

---

# **National Building Code of Canada 2015**

**Volume 1**

**Issued by the  
Canadian Commission on Building and Fire Codes  
National Research Council of Canada**

First Edition 1941  
Second Edition 1953  
Third Edition 1960  
Fourth Edition 1965  
Fifth Edition 1970  
Sixth Edition 1975  
Seventh Edition 1977  
Eighth Edition 1980  
Ninth Edition 1985  
Tenth Edition 1990  
Eleventh Edition 1995  
Twelfth Edition 2005  
Thirteenth Edition 2010  
Fourteenth Edition 2015

ISBN 0-660-03633-5

NR24-28/2015E

NRCC 56190

© National Research Council of Canada 2015  
Ottawa  
World Rights Reserved

Printed in Canada

First Printing

2 4 6 8 10 9 7 5 3 1

Aussi disponible en français :  
Code national du bâtiment – Canada 2015  
CNRC 56190F  
ISBN 0-660-03635-9

---

# Table of Contents

## Volume 1

Preface

Relationship of the NBC to Standards Development and Conformity Assessment

Canadian Commission on Building and Fire Codes and Standing Committees

### **Division A Compliance, Objectives and Functional Statements**

- Part 1 Compliance
- Part 2 Objectives
- Part 3 Functional Statements

### **Division B Acceptable Solutions**

- Part 1 General
- Part 2 Reserved
- Part 3 Fire Protection, Occupant Safety and Accessibility
- Part 4 Structural Design
- Part 5 Environmental Separation
- Part 6 Heating, Ventilating and Air-conditioning
- Part 7 Plumbing Services
- Part 8 Safety Measures at Construction and Demolition Sites
- Appendix C Climatic and Seismic Information
- Appendix D Fire-Performance Ratings

### **Division C Administrative Provisions**

- Part 1 General
- Part 2 Administrative Provisions

**Index**

## Volume 2

### **Division B Acceptable Solutions**

- Part 9 Housing and Small Buildings

**Index**



---

# Preface

The National Building Code of Canada 2015, together with the National Plumbing Code of Canada 2015, the National Fire Code of Canada 2015 and the National Energy Code of Canada for Buildings 2015, is an objective-based National Model Code that can be adopted by provincial and territorial governments. Codes Canada<sup>(1)</sup> are developed by the Canadian Commission on Building and Fire Codes (CCBFC).

In Canada, provincial and territorial governments have the authority to enact legislation that regulates building design and construction within their jurisdictions. This legislation may include the adoption of the National Building Code (NBC) without change or with modifications to suit local needs, and the enactment of other laws and regulations regarding building design and construction, including the requirements for professional involvement.

The NBC is a model code in the sense that it helps promote consistency among provincial and territorial building codes. Persons involved in the design or construction of a building should consult the provincial or territorial government concerned to find out which building code is applicable.

This edition of the NBC succeeds the 2010 edition.

## Code Development

### Development of Codes Canada

The Canadian Commission on Building and Fire Codes (CCBFC) is responsible for the content of the National Model Codes. The CCBFC is an independent body made up of volunteers from across the country and from all facets of the code-user community. Members of the CCBFC and its standing committees include builders, engineers, skilled trade workers, architects, building owners, building operators, fire and building officials, manufacturers and representatives of general interests.

The CCBFC is advised on scope, policy and technical issues pertaining to the Codes by the Provincial/Territorial Policy Advisory Committee on Codes (PTPACC), which is a committee of senior representatives from provincial/territorial ministries responsible for the regulation of buildings, fire safety and plumbing in their jurisdictions. The PTPACC was created by the provinces and territories, with provision of guidance to the CCBFC as one of its main functions. Through the PTPACC and its subcommittees on building, fire and plumbing regulation, the provinces and territories are engaged in every phase of the model Code development process.

Codes Canada (formerly named the Canadian Codes Centre) of the National Research Council (NRC) provides technical and administrative support to the CCBFC and its standing committees. NRC publishes Codes Canada and periodic revisions to the Codes to address pressing issues.

The broader code-user community also makes a significant contribution to the model Code development process by submitting requests for changes or additions to the Codes

---

(1) The National Model Codes are now collectively referred to as “Codes Canada.”

---

and by commenting on the proposed changes during the public reviews that precede each new edition.

The CCBFC takes into consideration the advice received from the provinces and territories as well as code users' comments at each stage of Code development. The scope and content of Codes Canada are determined on a consensus basis, which involves the review of technical, policy and practical concerns and debate on the implications of these concerns.

More information on the Code development process is available on NRC's Web site. Printed copies of this information may also be requested from the Secretary of the CCBFC, whose address is provided at the end of this Preface.

## **National Building Code of Canada 2015**

The National Building Code (NBC) sets out technical provisions for the design and construction of new buildings. It also applies to the alteration, change of use and demolition of existing buildings.

The NBC establishes requirements to address the following five objectives, which are fully described in Division A of the Code:

- safety
- health
- accessibility for persons with disabilities
- fire and structural protection of buildings
- environment

Code provisions do not necessarily address all the characteristics of buildings that might be considered to have a bearing on the Code's objectives. Through the extensive consensus process used to develop and maintain Codes Canada (see the section entitled Development of Codes Canada), the code-user community has decided which characteristics should be regulated through the NBC.

Because the NBC is a model code, its requirements can be considered as the minimum acceptable measures required to adequately achieve the above-listed objectives, as recommended by the Canadian Commission on Building and Fire Codes. They become minimum acceptable requirements once they are adopted and passed into law or regulation by an authority having jurisdiction: i.e. the requirements represent the minimum level of performance required to achieve the objectives that is acceptable to the adopting authority.

Code users are also involved in the development of the NBC and they help determine the content. The Code development process is described in the section entitled Development of Codes Canada.

The NBC is a model code which, when adopted or adapted by a province or territory, becomes a regulation. It is not a textbook on building design or construction. The design of a technically sound building depends upon many factors beyond simple compliance with building regulations. Such factors include the availability of knowledgeable practitioners who have received appropriate education, training and experience and who have some degree of familiarity with the principles of good building practice and experience using textbooks, reference manuals and technical guides.

The NBC does not list acceptable proprietary building products. It establishes the criteria that building materials, products and assemblies must meet. Some of these criteria are explicitly stated in the NBC while others are incorporated by reference to material or product standards published by standards development organizations. Only those portions of the standards related to the objectives of this Code are mandatory parts of the NBC.

## Relationship between the National Building Code and the National Fire Code

The National Building Code (NBC) and National Fire Code (NFC) each contain provisions that deal with the safety of persons in buildings in the event of a fire and the protection of buildings from the effects of fire.<sup>(2)</sup> These two National Model Codes are developed as complementary and coordinated documents to minimize the possibility of their containing conflicting provisions. It is expected that buildings comply with both the NBC and the NFC. The NBC generally applies at the time of construction and reconstruction while the NFC applies to the operation and maintenance of the fire-related features of buildings in use.

The scope of each of these Codes with respect to fire safety and fire protection can be summarized as follows:

The National Building Code covers the fire safety and fire protection features that are required to be incorporated in a building at the time of its original construction.

Building codes typically no longer apply once a building is occupied, unless the building is undergoing alteration or change of use, or being demolished.

The National Fire Code includes provisions for:

- the ongoing maintenance and use of the fire safety and fire protection features incorporated in buildings
- the conduct of activities that might cause fire hazards in and around buildings
- limitations on hazardous contents in and around buildings
- the establishment of fire safety plans
- fire safety at construction and demolition sites

In addition, the NFC contains provisions regarding fire safety and fire protection features that must be added to existing buildings when certain hazardous activities or processes are introduced in these buildings.

Some of the NFC's provisions are not duplicated directly in the NBC but are in fact adopted through cross-references to the NFC. Thus, some NFC provisions may apply to original construction, alterations, or changes in use.

### Code Requirements

Every NBC requirement must address at least one of the Code's five stated objectives, namely:

- safety
- health
- accessibility for persons with disabilities
- fire and structural protection of buildings
- environment

In dealing with proposed changes or additions to any Codes Canada, the CCBFC considers many issues such as the following:

- Does the proposed requirement provide the minimum level of performance—and no more than the minimum—needed to achieve the Code's objectives?
- Will persons responsible for Code compliance be able to act on or implement the requirement using commonly accepted practices?
- Will enforcement agencies be able to enforce the requirement?
- Are the costs of implementing the requirement justifiable?
- Have the potential policy implications of the requirement been identified and addressed?
- Is there broad consensus on this requirement among Code users representing all facets of the design and construction industries as well as among provincial and territorial governments?

---

(2) The NFC also applies to other types of facilities besides buildings (e.g. tank farms and storage yards). Those applications are not discussed here.

---

Guidelines for requesting changes to the NBC are available on NRC's Web site. Printed copies of the guidelines may also be requested from the Secretary of the CCBFC, whose address is provided at the end of this Preface.

## Objective-Based Code Format

The National Building Code (NBC) was published in an objective-based code format for the first time in 2005. This was the result of ten years of work on an initiative that arose out of the strategic plan adopted by the Canadian Commission on Building and Fire Codes (CCBFC) in 1995.

The NBC comprises three Divisions:

- Division A, which defines the scope of the Code and contains the objectives, the functional statements and the conditions necessary to achieve compliance;
- Division B, which contains acceptable solutions (commonly referred to as "technical requirements") deemed to satisfy the objectives and functional statements listed in Division A; and
- Division C, which contains administrative provisions.

A more complete description of this division-based structure is included in the section entitled Structure of Objective-Based Codes.

Each requirement in Division B is linked to three types of information:

- objectives (such as safety or health), which individual requirements help to address,
- functional statements (statements on the functions of the building that a particular requirement helps to achieve), and
- intent statements (detailed statements on the specific intent of the provision).

## Objectives

The NBC's objectives are fully defined in Section 2.2. of Division A. Most of the top-level objectives have two levels of sub-objectives.

The objectives describe, in very broad terms, the overall goals that the NBC's requirements are intended to achieve. They serve to define the boundaries of the subject areas the Code addresses. However, the Code does not deal with all the issues that might be considered to fall within those boundaries.

The objectives describe undesirable situations and their consequences, which the Code aims to avoid occurring in buildings. The wording of most of the definitions of the objectives includes two key phrases: "limit the probability" and "unacceptable risk." The phrase "limit the probability" is used to acknowledge that the NBC cannot entirely prevent those undesirable situations from happening. The phrase "unacceptable risk" acknowledges that the NBC cannot eliminate all risk: the "acceptable risk" is the risk remaining once compliance with the Code has been achieved.

The objectives are entirely qualitative and are not intended to be used on their own in the design and approval processes.

The objectives attributed to the requirements or portions of requirements in Division B are listed in a table following the provisions in each Part.

## Functional Statements

The NBC's functional statements are listed in Section 3.2. of Division A.

The functional statements are more detailed than the objectives: they describe conditions in the building that help satisfy the objectives. The functional statements and the objectives are interconnected: there may be several functional statements related to any one objective and a given functional statement may describe a function of the building that serves to achieve more than one objective.



---

Like objectives, functional statements are entirely qualitative and are not intended to be used on their own in the design and approval processes.

The functional statements attributed to the requirements or portions of requirements in Division B are listed in a table following the provisions in each Part.

## Intent Statements

Intent statements explain, in plain language, the basic thinking behind each Code provision contained in Division B. Intent statements, each of which is unique to the provision with which it is associated, explain how requirements help to achieve their attributed objectives and functional statements. Like the objectives, the intent statements are expressed in terms of risk avoidance and expected performance. They offer insight into the views of the responsible standing committees on what the Code provisions are intended to achieve.

The intent statements serve explanatory purposes only and do not form an integral part of the Code provisions: as such, they are similar in function to the explanatory notes at the end of each Part. Due to the sheer volume of intent statements—thousands for the NBC alone—they are only available as part of an online Code subscription and as a separate electronic document entitled “Supplement to the NBC 2015: Intent Statements,” which is posted on NRC’s Web site.

All this additional information—objectives, functional statements and intent statements—is intended to facilitate the implementation of the Code in two ways:

- **Clarity of intent:** The objectives, functional statements and intent statements linked to a Code requirement clarify the reasoning behind that requirement and facilitate understanding of what must be done to satisfy that requirement. This added information may also help avoid disputes between practitioners and officials over these types of issues.
- **Flexibility:** The additional information allows for flexibility in Code compliance. A person seeking to propose a new method or material not described or covered in the Code will be able to use the added information to understand the expected level of performance that their alternative solution must achieve to satisfy the Code.

## Structure of Objective-Based Codes

The National Building Code (NBC) is organized into three Divisions, which are distributed across two volumes.

### Division A: Compliance, Objectives and Functional Statements

Division A defines the scope of the NBC and presents the objectives that the Code addresses and the functions the building must perform to help to satisfy those objectives.

Division A cannot be used on its own as a basis for designing and constructing a building, or for evaluating a building’s compliance with the Code.

### Division B: Acceptable Solutions

The term “acceptable solutions” refers to the technical provisions contained in the Code. It reflects the principle that building codes establish an acceptable level of risk or performance and underlines the fact that a code cannot describe all possible valid design and construction options. The term provokes the question “To whom are these solutions considered acceptable?” Acceptable solutions represent the minimum level of performance that will satisfy the NBC’s objectives and that is acceptable to an authority that adopts the NBC into law or regulation.

The requirements in Division B—the acceptable solutions—are linked to at least one objective and functional statement found in Division A. These linkages play an important role in allowing objective-based codes to accommodate innovation.

It is expected that the majority of Code users will primarily follow the acceptable solutions presented in Division B and that they will consult Division A only when seeking clarification on the application of Division B's requirements to a particular situation, when considering an alternative solution, or to read the definition of selected terms in the context of the NBC.

## Division C: Administrative Provisions

Division C contains administrative provisions relating to the application of the Code. Many provinces and territories establish their own administrative provisions upon adopting or adapting the NBC; having all the administrative provisions in one Division facilitates their customization to suit jurisdictional needs.

## Relationship between Division A and Division B

Sentence 1.2.1.1.(1) of Division A is a very important sentence: it is a precise statement of the relationship between Divisions A and B and is central to the concept of objective-based codes.

- 1)** Compliance with this Code shall be achieved by
  - a) complying with the applicable acceptable solutions in Division B (see Note A-1.2.1.1.(1)(a)), or
  - b) using alternative solutions that will achieve at least the minimum level of performance required by Division B in the areas defined by the objectives and functional statements attributed to the applicable acceptable solutions (see Note A-1.2.1.1.(1)(b)).

Clause (a) makes it clear that the acceptable solutions in Division B are automatically deemed to satisfy the linked objectives and functional statements of Division A.

Clause (b) makes it clear that alternative solutions can be used in lieu of compliance with the acceptable solutions. However, to do something different from the acceptable solutions described in Division B, a builder, designer or building owner must show that their proposed alternative solution will perform at least as well as the acceptable solution(s) it is replacing. The objectives and functional statements attributed to the acceptable solution(s) identify the areas of performance where this equivalence must be demonstrated.

## What's New in the 2015 Edition

### New Structure

This edition of the NBC has been restructured to improve ease of access to interdependent provisions. The explanatory Notes for Division B provisions—which were formerly grouped in Appendices A and B—are now included at the end of the Part to which they apply (e.g., the Notes for Part 3 provisions are at the end of Part 3, etc.). The Attribution Tables are now included with each Part instead of being grouped in Volume 1. Appendices C and D are now at the end of Volume 1. Part 9 along with its Attribution Table and explanatory Notes is now self-contained in Volume 2.

### Reorganization of Section 3.8.

To improve clarity and ease of use, the application and design provisions in Section 3.8. of Division B have been separated and regrouped according to subject matter into three Subsections: Scope, Application and Design.

## Reorganization of Part 6

The provisions in Part 6 of Division B have been reorganized into a more logical sequence and divided according to major mechanical elements. General provisions are now grouped at the front end followed by system-specific provisions, which allows for easier, more intuitive access to information.

## Relocation of Fire and Sound Resistance Tables

The fire and sound resistance tables—which were previously located in Appendix Note A-9.10.3.1. of Division B—have been moved to the end of the Part 9 provisions as Tables 9.10.3.1.-A and 9.10.3.1.-B. They have been relocated because they contain specifications for assembly construction that represent acceptable solutions to requirements for minimum sound transmission ratings in Parts 5 and 9 and to requirements for minimum fire-resistance ratings in Part 9.

## Additional Information

### Numbering System

A consistent numbering system has been used throughout the Codes Canada. The first number indicates the Part of the Code; the second, the Section in the Part; the third, the Subsection; and the fourth, the Article in the Subsection. The detailed provisions are found at the Sentence level (indicated by numbers in brackets), and Sentences may be broken down into Clauses and Subclauses. This structure is illustrated as follows:

3	Part
3.5.	Section
3.5.2.	Subsection
3.5.2.1.	Article
3.5.2.1.(2)	Sentence
3.5.2.1.(2)(a)	Clause
3.5.2.1.(2)(a)(i)	Subclause

### Change Indication

Where a technical change or addition has been made relative to the 2010 edition, a vertical line has been added in the margin next to the affected provision to indicate the approximate location of new or modified content. No change indication is provided for renumbered or deleted content.

### Meaning of the words “and” and “or” between the Clauses and Subclauses of a Sentence

Multiple Clauses and Subclauses are connected by the word “and” or “or” at the end of the second last Clause or Subclause in the series. Although this connecting word appears only once, it is meant to apply to all the preceding Clauses or Subclauses within that series.

For example, in a series of five Clauses—a) to e)—in a Code Sentence, the appearance of the word “and” at the end of Clause d) means that all Clauses in the Sentence are connected to each other with the word “and.” Similarly, in a series of five Clauses—a) to e)—in a Code Sentence, the appearance of the word “or” at the end of Clause d) means that all Clauses in the Sentence are connected to each other with the word “or.”

In all cases, it is important to note that a Clause (and its Subclauses, if any) must always be read in conjunction with its introductory text appearing at the beginning of the Sentence.

---

## Administration

A separate CCBFC document entitled Administrative Requirements for Use with the National Building Code of Canada 1985 is also published by the National Research Council. It is automatically adopted as per Article 2.2.1.1. of Division C if the adopting authority does not provide other administrative requirements.

## Metric Conversion

All values in the NBC are given in metric units. A conversion table of imperial equivalents for the most common units used in building design and construction is located at the end of the Code.

## Parts in Division B and Professional Disciplines

Division B is organized into Parts that are largely related to disciplines. However, this does not mean that persons of a certain discipline who are executing the design or construction of a particular building component can necessarily deal with only one Part of the Code in isolation since provisions related to that building component may be found in more than one Part.

For example:

- provisions that deal with fire safety issues related to heating, ventilating and air-conditioning systems are located in Part 3 of Division B, Fire Protection, Occupant Safety and Accessibility, and not in Part 6, Heating, Ventilating and Air-conditioning;
- structural requirements related to loads on handrails and grab bars are located in Part 3 of Division B, Fire Protection, Occupant Safety and Accessibility, while structural requirements related to loads on guards and handrails are located in Part 4, Structural Design.

For this reason, the part-based structure of Division B is not well suited for use as the basis for allocating responsibilities to different professions or as the basis for contractual arrangements.

## Complementary Publications

The following Codes Canada publications are referenced in the NBC 2015 or facilitate the application of its requirements:

- National Fire Code of Canada 2015
- National Plumbing Code of Canada 2015
- Illustrated User's Guide – NBC 2010, Part 9 Housing and Small Buildings
- User's Guide – NBC 2015, Structural Commentaries (Part 4 of Division B)
- Supplement to the NBC 2015: Intent Statements

## Commercial Rights to Reproduce the National Building Code

Copyright for the National Building Code is owned by the National Research Council of Canada (NRC). All rights are reserved. Reproduction by any means of NRC's copyright material is prohibited without the written consent of NRC. Request for permission to reproduce the National Building Code must be sent to:

Production and Marketing Manager  
Codes Canada  
National Research Council of Canada  
Ottawa, Ontario K1A 0R6  
E-mail: Codes@nrc-cnrc.gc.ca

---

## Contact Information

The CCBFC welcomes comments and suggestions for improvements to the National Building Code. Persons interested in requesting a change to an NBC provision should refer to the guidelines available on NRC's Web site.

To submit comments or suggestions or to request printed copies of Internet material referred to in this Preface, contact:

The Secretary  
Canadian Commission on Building and Fire Codes  
Codes Canada  
National Research Council of Canada  
Ottawa, Ontario K1A 0R6  
Telephone: 613-993-9960  
Fax: 613-952-4040  
E-mail: [Codes@nrc-cnrc.gc.ca](mailto:Codes@nrc-cnrc.gc.ca)



---

# Relationship of the NBC to Standards Development and Conformity Assessment

The development of many provisions in the National Building Code (NBC) and the assessment of conformity to those provisions are supported by several of the member organizations of Canada's National Standards System (NSS).

The NSS is a federation of accredited organizations concerned with standards development, certification, testing, inspection, personnel and management systems registration that is established under the auspices of the Standards Council of Canada Act. Activities of the NSS are coordinated by the Standards Council of Canada (SCC), which has accredited 8 standards development organizations, 36 certification organizations, 21 registration organizations, and 344 calibration and testing laboratories.

The SCC is a federal non-profit Crown corporation responsible for the coordination of voluntary standardization in Canada. It also has responsibilities for Canada's activities in voluntary international standardization.

## Canadian Standards

The NBC contains many references to standards published by accredited standards development organizations in Canada. As part of the accreditation requirements, these organizations adhere to the principles of consensus. This generally means substantial majority agreement of a committee comprising a balance of producer, user and general interest members, and the consideration of all negative comments. The organizations also have formal procedures for the second-level review of the technical preparation and balloting of standards prepared under their auspices. (The Canadian Commission on Building and Fire Codes (CCBFC) follows these same principles of consensus in the operation of its Code development process.)

The following organizations are accredited as standards development organizations in Canada:

- American Society for Testing and Materials International (ASTM)
- Bureau de normalisation du Québec (BNQ)
- Canadian General Standards Board (CGSB)
- Canadian Standards Association (CSA)
- Underwriters' Laboratories (UL)
- ULC Standards (ULC)

Tables 1.3.1.2. and D-1.1.2. of Division B list the standards referenced in the NBC. Standards proposed to be referenced in the NBC are reviewed to ensure their content is compatible with the Code. Thereafter, referenced standards are reviewed as needed during each Code cycle. Standards development organizations are asked to provide information on any changes in the status of their standards referenced in the NBC—withdrawals, amendments, new editions, etc. This information is passed on to the CCBFC, its standing committees, the provinces and territories, and interested stakeholders on particular issues, all of whom are given the opportunity to identify any problems associated with the changes. These bodies do not necessarily review in detail the revised standards; rather, the approach relies on the consensus process involved in the maintenance of the standards and on the extensive knowledge and backgrounds of committee members, provincial or territorial staff, NRC staff, and consulted stakeholders to identify changes in the standards that might create problems in the Code.

---

## Non-Canadian Standards

A number of subject areas for which the Canadian standards development organizations have not developed standards are covered in the NBC. In these cases, the Code often references standards developed by organizations in other countries, such as the American Society of Heating, Refrigerating and Air-Conditioning Engineers (ASHRAE) and the National Fire Protection Association (NFPA). These standards are developed using processes that may differ from those used by the Canadian standards development organizations; nevertheless, these standards have been reviewed by the relevant standing committees and found to be acceptable.

## Conformity Assessment

The NBC establishes minimum measures, either within its own text or that of referenced standards. However, the NBC does not deal with the question of who is responsible for assessing conformity to the measures or how those with this responsibility might carry it out. This responsibility is usually established by the governing legislation of the adopting provinces or territories. Provincial or territorial authorities should be consulted to determine who is responsible for conformity assessment within their jurisdiction.

Those persons responsible for ensuring that a material, appliance, system or equipment meets the requirements of this Code have several means available to assist them. These means vary from on-site inspection to the use of certification services provided by accredited third-party organizations. Test reports or mill certificates provided by manufacturers or suppliers can also assist in the acceptance of products. Engineering reports may be required for more complex products.

### Testing

The accreditation programs of the SCC include many organizations accredited for testing and calibration that are capable of reliably testing building products to specified standards. The test results produced by these organizations can be used in the evaluation, qualification and certification of building products to Code provisions. The SCC's Web site ([www.scc.ca](http://www.scc.ca)) lists accredited certification bodies and allows users to search the scope of accreditation for each of these organizations.

### Certification

Certification is the confirmation by an independent organization that a product or service meets a requirement. Certification of a product, process, or system entails physical examination, testing as specified in the appropriate standards, plant examination, and follow-up unannounced plant inspections. This procedure leads to the issuing of a formal assurance or declaration, by means of a certification mark or certificate, that the product, process or system is in full conformity with specified provisions.

In some cases, a product for which no standard exists can be certified using procedures and criteria developed by the accredited certifying organization and specifically designed to measure the performance of that product. Certification bodies publish lists of certified products and companies.

### Registration

Quality Registration Organizations assess a company's conformance to quality assurance standards like the International Organization for Standardization ISO 9000.

### Evaluation

An evaluation is a written opinion by an independent professional organization that a product will perform its intended function in a building. An evaluation is very often done to determine the ability of an innovative product, for which no standards exist, to satisfy



---

the intent of a Code requirement. Follow-up plant inspections are not normally part of the evaluation process. Several organizations, including the Canadian Construction Materials Centre (CCMC), offer such evaluation services.

### **Qualification**

The qualification of building products also evaluates the ability of a product to perform its intended function by verifying that it meets the requirements of a standard. Qualification normally includes some follow-up plant inspection. Some organizations publish lists of qualified products that meet the specified requirements. Some organizations qualify manufacturing and/or testing facilities for building products for compliance with the Code and relevant standards.



# Canadian Commission on Building and Fire Codes and Standing Committees

## Canadian Commission on Building and Fire Codes

C. Fillingham ( <i>Chair</i> )	K. Gloge	J. Orr	C. Tye
D. Crawford ( <i>Vice Chair</i> )	H. Griffin	R. Owens	R. Vincent
R. Bartlett	J. Hackett	R. Riffel	D. Watts
A. Beaumont	L. Holmen	T. Ross	B. Wyness
A. Borooh	J. Huzar	R. Rymell	
T. Cochren	D. Ieroncig	J. Sherstobitoff	
A. Crimi	P. Jago	B. Sim	
R. DeVall	M. Kuzyk	G. Stasyneć	Codes Canada staff who provided assistance to the Commission
B. Dion	L. Leduc	B. Stebbing	
E. Domingo	B. Lorne	D. Stewart	
S. Dufresne	D. MacKinnon	G. Tessier	D. Bergeron
R. Dulmage	M. McSweeney	P. Thorkelsson	G. Gosselin
G. Fawcett	D. Miller	D. Thorsteinson	A. Gribbon
L. Francescutti	K.W. Newbert	M. Tovey	P. Rizcallah ( <i>Deputy Chair</i> )

## Standing Committee on Building and Plumbing Services

G.D. Stasyneć ( <i>Chair</i> )	R. Moulton
R.K. Armstrong	C.O. Muller
G.D. Burrill	K.W. Newbert
P.T. Chang	D.A. Pope
J. Clark	S.A. Remedios
C. Côté	R. Roberts
A.R. Dallaway	C.R. Roy
B.G. Diggins	A.J. Spurrell
Y. Duchesne	E.M. Sterling
L. Gill	T.D. Underwood
R. Gill	T.T. White
N. Grusnick	
D.C. Hickerty	Codes Canada staff who provided assistance to the Committee
D.K.S. Hui	
G. Jensen	
A.A. Knapp	D. Green

## Standing Committee on Earthquake Design

J. Sherstobitoff ( <i>Chair</i> )	D. Mitchell
J.E. Adams	C.J. Montgomery
D.L. Anderson	T. Onur
G.M. Atkinson	M. Popovski
M. Bruneau	G.C. Rogers
D. Carson	M. Saatcioglu
R.H. DeVall	R. Tremblay
H. Dutrisac	R. Vincent
K. Elwood	A. Wightman
W.D.L. Finn	
R. Grimshaw	
J.L. Humar	Codes Canada staff who provided assistance to the Committee
G. Krsmanovic	
S. Kuan	C.R. Taraschuk
T. Kokai	J. Singh
A. Metten	

## Standing Committee on Energy Efficiency in Buildings

K.W. Newbert ( <i>Chair</i> ) <sup>(2)</sup>	Rd. Marshall
A. Pride ( <i>Chair</i> ) <sup>(1)</sup>	Rt. Marshall
D.W. Bailey	A. Pape-Saimon
D. Bartel	J. Pockar
M. Bayat	M. Roy
S. Bioletti	T. Ryce
N. Brisson	P. Sectakof
A. Cameron	M. Slivar
R. Cardinal	A. Syed
J. Comtois	R. Veerasammy
L. Dalglish	T. White
B. Darrell	W. Wang
D. Dessario	
J. Donovan	Codes Canada staff who provided assistance to the Committee
F. Genest	
H. Hayne	
C. Kahramanoglu	E. Girgis
M. Kelly	H. Knudsen
M.M. Lamanque	M. Mihailovic
K.W. Lau	C. Taraschuk
D. Mather	P. Tardif
	M. Zeghal

## Standing Committee on Environmental Separation

D.L. Watts ( <i>Chair</i> )	R. Ogle
R. Baker	R. Rocheleau
S. Bioletti	L. Semko
R. Cardinal	A. Spino
J. Donovan	D. Stones
D. Inculet	G.R. Sturgeon
D. Ionescu	J. Wade
R. Jutras	
C. Kahramanoglu	
D. Kayll	Codes Canada staff who provided assistance to the Committee
T. Lee	
D.W. Lovell	
R. Marshall	M. Zeghal

## Standing Committee on Fire Protection

A. Crimi ( <i>Chair</i> ) <sup>(2)</sup>	H.J. Pothier
R.G. Brown ( <i>Chair</i> ) <sup>(1)</sup>	B.G. Schultz
K. Bailey	J.A. Scott
P.D. Blackwood	E.A. Sopeju
C.F. Campbell	R. Swart
R. Cerminara	A. Tabet
R. Cheung	J. Zorko
G.S. Frater	
K. Knox	Codes Canada staff who provided assistance to the Committee
M. Kohli	
N. Lessard	
H.A. Locke	M. Fortin
R.J. McGrath	S. Hyde-Clarke
R.A. McPhee	A. Laroche
R. Mercer	G. Morinville
E. Piecuch	P. Rizcallah

## Standing Committee on Hazardous Materials and Activities

G. Fawcett ( <i>Chair</i> ) <sup>(2)</sup>	W.P. Rodger
A. MacLellan-Bonnell ( <i>Chair</i> ) <sup>(1)</sup>	J.F. Selann
K. McEown ( <i>Chair</i> ) <sup>(1)(2)</sup>	R.I. Stephenson
M. Brockmann	A. Thériault
P. Chamberland	P.H. Thorkelsson
D. Edgecombe	B. Trussler
T. Espejo	B. Wright
E.G. Fernandes	
R.P.R. Gaade	Codes Canada staff who provided assistance to the Committee
M. Gagné	
H. Genest	
E. La Rocque	M. Fortin
M. Ng	S. Hyde-Clarke
P. Richards	A. Laroche
G. Robichaud	G. Morinville

## Standing Committee on Housing and Small Buildings

T. Cochren ( <i>Chair</i> )	M. Lasalle
P. Aitchison	P. Lepper
A. Amir	R. Lind
C. Bélanger	M. Lio
A.L. Bortolussi	R. Maling
H.W. Bromberg	B. Maltby
M. Brown	Z. May
Y.H. Chui	C. McLellan
B. Craig	R. Monsour
S.L. Crowell	B. Nantel
C. Dagenais	N. Perozzo
L. Dalglish	T. Pringle
B. Deeks	F. Scrafield
R. Di Gaetano	L. Semko
S. Dueck	G. Sharp
R. Dupuis	M. Stiller
L. Gareau	L. Strobl
R. Gratton	R.S. Wilson
S. Grbac	
L. Hasan	
J. Hockman	Codes Canada staff who provided assistance to the Committee
K. Hykawy	
D. Johnston	
R. Jonkman	N. Belrechid
R. Kadulski	F. Lohmann
K. Koo	M. Mihailovic
A. Lanteigne	J. Urquhart

## Standing Committee on Structural Design

R.B. Vincent ( <i>Chair</i> )	G.A. Nanji
M. Allen	G.R. Newfield
J.M. Bartel	M.F. Picher
D. Beaulieu	M. Rosseker
M.S. Buckley	R. Schuster
P.K.S. Chan	P.K.W. Shek
R.G. Drysdale	J. Sherstobitoff
K. Drysdale	I. Smith
G.A. Fenton	A.J. Steen
M.I. Gilmor	S.F. Stiemer
K.G. Griffiths	G.C. Williams
T.R. Grimshaw	A.F. Wong
H. Hong	
P.A. Irwin	Codes Canada staff who provided assistance to the Committee
R.J. McGrath	
R.C. Merchant	
H. Mi	A. Attar
D. Mitchell	C.R. Taraschuk

## Standing Committee on Use and Egress

E.A. Domingo ( <i>Chair</i> )	C. Salvian
J.W. Archer	G. Sereda
E.M. Beck	R.R. Thompson
S. Bourdeau	B. Topping
K. Calder	D.E. Weber
P. Caron	A. Weinstein
A.N. Cavers	
B.R. Everton	Codes Canada staff who provided assistance to the Committee
R. Fraser	
J. Goad	M. Fortin
L.G. Hamre	S. Hyde-Clarke
I.C. MacDonald	A. Laroche
D.B. Nauss	G. Morinville
J.D. Redmond	P. Rizcallah
J. Rubes	

## CCBFC Technical Translation Verification Committee

G. Harvey ( <i>Chair</i> )	Codes Canada staff who provided assistance to the Committee
F. Genest	
A. Gobeil	
B. Lagueux	I. Bastien
M.C. Ratté	I. Lanteigne
I. Wagner	G. Mougeot-Lemay

- (1) Chair term commenced during the preparation of the 2015 Code.
- (2) Chair term ended during the preparation of the 2015 Code.





## **Division A**

# **Compliance, Objectives and Functional Statements**





# Part 1

## Compliance

<b>1.1.</b>	<b>General</b>	
1.1.1.	Application of this Code .....	1-1
<b>1.2.</b>	<b>Compliance</b>	
1.2.1.	Compliance with this Code .....	1-1
1.2.2.	Materials, Appliances, Systems and Equipment .....	1-1
<b>1.3.</b>	<b>Divisions A, B and C of this Code</b>	
1.3.1.	General .....	1-2
1.3.2.	Application of Division A .....	1-2
1.3.3.	Application of Division B .....	1-2
1.3.4.	Application of Division C .....	1-3
<b>1.4.</b>	<b>Terms and Abbreviations</b>	
1.4.1.	Definitions of Words and Phrases ..	1-3
1.4.2.	Symbols and Other Abbreviations .....	1-13
<b>1.5.</b>	<b>Referenced Documents and Organizations</b>	
1.5.1.	Referenced Documents .....	1-14
1.5.2.	Organizations .....	1-14
	<b>Notes to Part 1 .....</b>	<b>1-15</b>



# Part 1 Compliance

## Section 1.1. General

### 1.1.1. Application of this Code

#### 1.1.1.1. Application of this Code

**1)** This Code applies to the design, construction and *occupancy* of all new *buildings*, and the *alteration*, reconstruction, demolition, removal, relocation and *occupancy* of all existing *buildings*. (See Note A-1.1.1.1.(1).)

**2)** This Code applies to both site-built and factory-constructed *buildings*. (See Note A-1.1.1.1.(2).)

**3)** *Farm buildings* shall conform to the requirements in the National Farm Building Code of Canada 1995.

## Section 1.2. Compliance

### 1.2.1. Compliance with this Code

#### 1.2.1.1. Compliance with this Code

- 1)** Compliance with this Code shall be achieved by
- complying with the applicable acceptable solutions in Division B (see Note A-1.2.1.1.(1)(a)), or
  - using alternative solutions that will achieve at least the minimum level of performance required by Division B in the areas defined by the objectives and functional statements attributed to the applicable acceptable solutions (see Note A-1.2.1.1.(1)(b)).

**2)** For the purposes of compliance with this Code as required in Clause 1.2.1.1.(1)(b), the objectives and functional statements attributed to the acceptable solutions in Division B shall be the objectives and functional statements referred to in Subsection 1.1.2. of Division B.

### 1.2.2. Materials, Appliances, Systems and Equipment

#### 1.2.2.1. Characteristics of Materials, Appliances, Systems and Equipment

**1)** All materials, *appliances*, systems and equipment installed to meet the requirements of this Code shall possess the necessary characteristics to perform their intended functions when installed in a *building*.

#### 1.2.2.2. Storage on the Building Site

**1)** All *building* materials, *appliances* and equipment on the *building* site shall be stored in such a way as to prevent the deterioration or impairment of their essential properties.

**1.2.2.3. Used Materials, Appliances and Equipment**

1) Unless otherwise specified, used materials, *appliances* and equipment are permitted to be reused when they meet the requirements of this Code for new materials and are satisfactory for the intended use.

**Section 1.3. Divisions A, B and C of this Code****1.3.1. General****1.3.1.1. Scope of Division A**

1) Division A contains the compliance and application provisions, objectives and functional statements of this Code.

**1.3.1.2. Scope of Division B**

1) Division B contains the acceptable solutions of this Code.

**1.3.1.3. Scope of Division C**

1) Division C contains the administrative provisions of this Code.

**1.3.1.4. Internal Cross-references**

1) Where the Division of a referenced provision is not specified in this Code, it shall mean that the referenced provision is in the same Division as the referencing provision.

**1.3.2. Application of Division A****1.3.2.1. Application of Parts 1, 2 and 3**

1) Parts 1, 2 and 3 of Division A apply to all *buildings* covered in this Code. (See Article 1.1.1.1.)

**1.3.3. Application of Division B****1.3.3.1. Application of Parts 1, 7 and 8**

1) Parts 1, 7 and 8 of Division B apply to all *buildings* covered in this Code. (See Article 1.1.1.1.)

**1.3.3.2. Application of Parts 3, 4, 5 and 6**

1) Parts 3, 4, 5, and 6 of Division B apply to all *buildings* described in Article 1.1.1.1. and

- a) classified as *post-disaster buildings*,
- b) used for *major occupancies* classified as
  - i) Group A, *assembly occupancies*,
  - ii) Group B, *care, treatment or detention occupancies*, or
  - iii) Group F, Division 1, *high-hazard industrial occupancies*, or
- c) exceeding 600 m<sup>2</sup> in *building area* or exceeding 3 *storeys* in *building height* used for *major occupancies* classified as
  - i) Group C, *residential occupancies*,
  - ii) Group D, *business and personal services occupancies*,
  - iii) Group E, *mercantile occupancies*, or
  - iv) Group F, Divisions 2 and 3, *medium- and low-hazard industrial occupancies*.

**1.3.3.3. Application of Part 9**

**1)** Part 9 of Division B applies to all *buildings* described in Article 1.1.1.1. of 3 *storeys* or less in *building height*, having a *building area* not exceeding 600 m<sup>2</sup>, and used for *major occupancies* classified as

- a) Group C, *residential occupancies* (see Note A-9.1.1.1.(1) of Division B),
- b) Group D, *business and personal services occupancies*,
- c) Group E, *mercantile occupancies*, or
- d) Group F, Divisions 2 and 3, *medium- and low-hazard industrial occupancies*.

**1.3.3.4. Building Size Determination**

**1)** Where a *firewall* divides a *building*, each portion of the *building* so divided shall be considered as a separate *building*, except when this requirement is specifically modified in other parts of this Code. (See Note A-1.3.3.4.(1).)

**2)** Except as permitted in Sentence (3), where portions of a *building* are completely separated by a vertical *fire separation* that has a *fire-resistance rating* of not less than 1 h and extends through all *storeys* and *service spaces* of the separated portions, each separated portion is permitted to be considered as a separate *building* for the purpose of determining *building height*, provided

- a) each separated portion is not more than 4 *storeys* in *building height* and is used only for *assembly, residential, and business and personal services occupancies*, and
- b) the unobstructed path of travel for a firefighter from the nearest *street* to one entrance of each separated portion is not more than 45 m.

(See Note A-1.3.3.4.(2).)

**3)** The vertical *fire separation* referred to in Sentence (2) may terminate at the floor assembly immediately above a *basement* provided the *basement* conforms to Article 3.2.1.2. of Division B.

**1.3.4. Application of Division C****1.3.4.1. Application of Parts 1 and 2**

**1)** Parts 1 and 2 of Division C apply to all *buildings* covered in this Code. (See Article 1.1.1.1.)

**Section 1.4. Terms and Abbreviations****1.4.1. Definitions of Words and Phrases****1.4.1.1. Non-defined Terms**

**1)** Words and phrases used in this Code that are not included in the list of definitions in Article 1.4.1.2. shall have the meanings that are commonly assigned to them in the context in which they are used, taking into account the specialized use of terms by the various trades and professions to which the terminology applies.

**2)** Where objectives and functional statements are referred to in this Code, they shall be the objectives and functional statements described in Parts 2 and 3.

**3)** Where acceptable solutions are referred to in this Code, they shall be the provisions stated in Parts 3 to 9 of Division B.

**4)** Where alternative solutions are referred to in this Code, they shall be the alternative solutions mentioned in Clause 1.2.1.1.(1)(b).

**1.4.1.2. Defined Terms**

**1)** The words and terms in italics in this Code shall have the following meanings:  
*Access to exit* means that part of a *means of egress* within a *floor area* that provides access to an *exit* serving the *floor area*.

*Adfreezing* means the adhesion of *soil* to a *foundation unit* resulting from the freezing of *soil water*. (Also referred to as “frost grip.”)

*Air barrier system* means the assembly installed to provide a continuous barrier to the movement of air.

*Air-supported structure* means a structure consisting of a pliable membrane which achieves and maintains its shape and support by internal air pressure.

*Alarm signal* means an audible signal transmitted throughout a zone or zones or throughout a *building* to advise occupants that a fire emergency exists.

*Alert signal* means an audible signal to advise designated persons of a fire emergency.

*Alteration* means a change or extension to any matter or thing or to any *occupancy* regulated by this Code.

*Apparent sound transmission class (ASTC)* means a single number rating of the airborne sound attenuation of *building* assemblies separating two adjoining spaces, taking into account both the direct and flanking sound transmission paths. (See Note A-1.4.1.2.(1).) (See also Note A-9.11. of Division B.)

*Appliance* means a device to convert fuel into energy and includes all components, controls, wiring and piping required to be part of the device by the applicable standard referred to in this Code.

*Artesian groundwater* means a confined body of water under pressure in the ground.

*Assembly occupancy* means the *occupancy* or the use of a *building*, or part thereof, by a gathering of persons for civic, political, travel, religious, social, educational, recreational or like purposes, or for the consumption of food or drink.

*Attic or roof space* means the space between the roof and the ceiling of the top *storey* or between a dwarf wall and a sloping roof.

*Authority having jurisdiction* means the governmental body responsible for the enforcement of any part of this Code or the official or agency designated by that body to exercise such a function.

*Barrier-free* means that a *building* and its facilities can be approached, entered, and used by persons with physical or sensory disabilities.

*Basement* means a *storey* or *storeys* of a *building* located below the *first storey*.

*Bearing surface* means the contact surface between a *foundation unit* and the *soil* or *rock* upon which it bears.

*Boiler* means an *appliance* intended to supply hot water or steam for space heating, processing or power purposes.

*Braced wall band* means an imaginary continuous straight band extending vertically and horizontally through the *building* or part of the *building*, within which *braced wall panels* are constructed.

*Braced wall panel* means a portion of a wood-frame wall where bracing, sheathing, cladding or interior finish is designed and installed to provide the required resistance to lateral loads due to wind or earthquake.

*Breeching* means a *flue pipe* or chamber for receiving *flue* gases from one or more *flue* connections and for discharging these gases through a single *flue* connection.

*Building* means any structure used or intended for supporting or sheltering any use or *occupancy*.

*Building area* means the greatest horizontal area of a *building* above *grade* within the outside surface of exterior walls or within the outside surface of exterior walls and the centre line of *firewalls*.

*Building height* (in *storeys*) means the number of *storeys* contained between the roof and the floor of the *first storey*.

*Business and personal services occupancy* means the *occupancy* or use of a *building* or part thereof for the transaction of business or the rendering or receiving of professional or personal services.

*Caisson* (see *Pile*).

*Care* means the provision of services other than *treatment* by or through care facility management to residents who require these services because of cognitive, physical or behavioural limitations.

*Care occupancy* means the *occupancy* or use of a *building* or part thereof where *care* is provided to residents. (See Note A-1.4.1.2.(1).)

*Cavity wall* means a construction of masonry units laid with a cavity between the wythes. The wythes are tied together with metal ties or bonding units, and are relied on to act together in resisting lateral loads.

*Chimney* means a primarily vertical shaft enclosing at least one *flue* for conducting *flue* gases to the outdoors.

*Chimney liner* means a conduit containing a *chimney flue* used as a lining of a *masonry or concrete chimney*.

*Closure* means a device or assembly for closing an opening through a *fire separation* or an exterior wall, such as a door, a shutter, a damper, wired glass or glass block, and includes all components such as hardware, closing devices, frames and anchors.

*Combustible* means that a material fails to meet the acceptance criteria of CAN/ULC-S114, "Test for Determination of Non-Combustibility in Building Materials."

*Combustible construction* means that type of construction that does not meet the requirements for *noncombustible construction*.

*Combustible dusts* means dusts and particles that are ignitable and liable to produce an explosion.

*Combustible fibres* means finely divided, combustible vegetable or animal fibres and thin sheets or flakes of such materials which, in a loose, unbaled condition, present a flash fire hazard, including cotton, wool, hemp, sisal, jute, kapok, paper and cloth.

*Combustible liquid* means a liquid having a *flash point* at or above 37.8°C and below 93.3°C.

*Conditioned space* means any space within a *building* the temperature of which is controlled to limit variation in response to the exterior ambient temperature by the provision, either directly or indirectly, of heating or cooling over substantial portions of the year.

*Constructor* means a person who contracts with an *owner* or their authorized agent to undertake a project, and includes an *owner* who contracts with more than one person for the work on a project or undertakes the work on a project or any part thereof.

*Contained use area* means a supervised area containing one or more rooms in which occupant movement is restricted to a single room by security measures not under the control of the occupant.

*Cooktop* means a cooking surface having one or more burners or heating elements.

*Dangerous goods* means products, materials or substances that are

- (a) regulated by TC SOR/2008-34, "Transportation of Dangerous Goods Regulations (TDGR)" (see Table 3.2.7.1. of Division B of the NFC), or
- (b) classified as controlled products under HC SOR/2015-17, "Hazardous Products Regulations" (see Note A-Table 3.2.7.1. of Division B of the NFC).

(See Note A-1.4.1.2.(1).)

*Dead load* means the weight of all permanent structural and non-structural components of a *building*.

*Deep foundation* means a *foundation unit* that provides support for a *building* by transferring loads either by end-bearing to *soil* or *rock* at considerable depth below the *building*, or by adhesion or friction, or both, in the *soil* or *rock* in which it is placed. *Piles* are the most common type of *deep foundation*.

*Designer* means the person responsible for the design.

*Detention occupancy* means the *occupancy* by persons who are restrained from or are incapable of evacuating to a safe location without the assistance of another person because of security measures not under their control.

*Distillery* means a *process plant* where *distilled beverage alcohols* are produced, concentrated or otherwise processed, and includes facilities on the same site where the concentrated products may be blended, mixed, stored or packaged.

*Distilled beverage alcohol* means a beverage that is produced by fermentation and contains more than 20% by volume of water-miscible alcohol.

*Direct-vented* (as applying to a fuel-fired space- or water-heating *appliance*) means an *appliance* and its venting system in which all the combustion air is supplied directly from the outdoors and the products of combustion are vented directly to the outdoors via independent, totally enclosed passageways connected directly to the *appliance*.

*Dwelling unit* means a *suite* operated as a housekeeping unit, used or intended to be used by one or more persons and usually containing cooking, eating, living, sleeping and sanitary facilities.

*Excavation* means the space created by the removal of *soil, rock or fill* for the purposes of construction.

*Exhaust duct* means a duct through which air is conveyed from a room or space to the outdoors.

*Exit* means that part of a *means of egress*, including doorways, that leads from the *floor area* it serves to a separate *building*, an open public thoroughfare, or an exterior open space protected from fire exposure from the *building* and having access to an open public thoroughfare. (See Note A-1.4.1.2.(1).)

*Exit level* means the level of an *exit* stairway at which an exterior *exit* door or *exit* passageway leads to the exterior.

*Exit storey* (as applying to Subsection 3.2.6. of Division B) means a *storey* having an exterior *exit* door.

*Exposing building face* means that part of the exterior wall of a *building* that faces one direction and is located between ground level and the ceiling of its top *storey* or, where a *building* is divided into *fire compartments*, the exterior wall of a *fire compartment* that faces one direction.

*Factory-built chimney* means a *chimney* consisting entirely of factory-made parts, each designed to be assembled with the other without requiring fabrication on site.

*Farm building* means a *building* or part thereof that does not contain a *residential occupancy* and that is associated with and located on land devoted to the practice of farming, and used essentially for the housing of equipment or livestock, or the production, storage or processing of agricultural and horticultural produce or feeds. (See Note A-1.4.1.2.(1).)

*Fill* means *soil, rock, rubble, industrial waste* such as slag, organic material or a combination of these that is transported and placed on the natural surface of *soil* or *rock* or organic terrain. It may or may not be compacted.

*Fire block* means a material, component or system that restricts the spread of fire within a concealed space or from a concealed space to an adjacent space.

*Fire compartment* means an enclosed space in a *building* that is separated from all other parts of the *building* by enclosing construction providing a *fire separation* having a required *fire-resistance rating*.

*Fire damper* means a *closure* consisting of a damper that is installed in an air distribution system or a wall or floor assembly and that is normally held open but designed to close automatically in the event of a fire in order to maintain the integrity of the *fire separation*.

*Fire detector* means a device that detects a fire condition and automatically initiates an electrical signal to actuate an *alert signal* or *alarm signal* and includes *heat detectors* and *smoke detectors*.

*Fire load* (as applying to an *occupancy*) means the *combustible* contents of a room or *floor area* expressed in terms of the average weight of *combustible* materials per unit area, from which the potential heat liberation may be calculated based on the calorific



value of the materials, and includes the furnishings, finished floor, wall and ceiling finishes, trim and temporary and movable *partitions*.

*Fire-protection rating* means the time in minutes or hours that a *closure* will withstand the passage of flame when exposed to fire under specified conditions of test and performance criteria, or as otherwise prescribed in this Code.

*Fire-resistance rating* means the time in minutes or hours that a material or assembly of materials will withstand the passage of flame and the transmission of heat when exposed to fire under specified conditions of test and performance criteria, or as determined by extension or interpretation of information derived therefrom as prescribed in this Code. (See D-1.2.1.(2) in Appendix D of Division B.)

*Fire-retardant-treated wood* means wood or a wood product that has had its surface-burning characteristics, such as flame spread, rate of fuel contribution and density of smoke developed, reduced by impregnation with fire-retardant chemicals.

*Fire separation* means a construction assembly that acts as a barrier against the spread of fire. (See Note A-1.4.1.2.(1).)

*Fire stop* means a system consisting of a material, component and means of support used to fill gaps between *fire separations* or between *fire separations* and other assemblies, or used around items that wholly or partially penetrate a *fire separation*.

*Fire stop flap* means a device intended for use in horizontal assemblies required to have a *fire-resistance rating* and incorporating protective ceiling membranes, which operates to close off a duct opening through the membrane in the event of a fire.

*Firewall* means a type of *fire separation* of *noncombustible construction* that subdivides a *building* or separates adjoining *buildings* to resist the spread of fire and that has a *fire-resistance rating* as prescribed in this Code and has structural stability to remain intact under fire conditions for the required fire-rated time.

*First storey* means the uppermost *storey* having its floor level not more than 2 m above *grade*.

*Flame-spread rating* means an index or classification indicating the extent of spread-of-flame on the surface of a material or an assembly of materials as determined in a standard fire test as prescribed in this Code.

*Flammable liquid* means a liquid having a *flash point* below 37.8°C and having a vapour pressure not more than 275.8 kPa (absolute) at 37.8°C as determined by ASTM D 323, "Vapor Pressure of Petroleum Products (Reid Method)."

*Flash point* means the minimum temperature at which a liquid within a container gives off vapour in sufficient concentration to form an ignitable mixture with air near the surface of the liquid.

*Flight* means a series of steps between landings. (See Note A-1.4.1.2.(1).)

*Floor area* means the space on any *storey* of a *building* between exterior walls and required *firewalls*, including the space occupied by interior walls and *partitions*, but not including *exits*, *vertical service spaces*, and their enclosing assemblies.

*Flue* means an enclosed passageway for conveying *flue* gases.

*Flue collar* means the portion of a fuel-fired *appliance* designed for the attachment of the *flue pipe* or *breeching*.

*Flue pipe* means the pipe connecting the *flue collar* of an *appliance* to a *chimney*.

*Forced-air furnace* means a *furnace* equipped with a fan that provides the primary means for the circulation of air.

*Foundation* means a system or arrangement of *foundation units* through which the loads from a *building* are transferred to supporting *soil* or *rock*.

*Foundation unit* means one of the structural members of the *foundation* of a *building* such as a footing, raft or *pile*.

*Frost action* means the phenomenon that occurs when water in *soil* is subjected to freezing which, because of the water/ice phase change or ice lens growth, results in a total volume increase or the build-up of expansive forces under confined

conditions or both, and the subsequent thawing that leads to loss of *soil* strength and increased compressibility.

*Furnace* means a *space-heating appliance* using warm air as the heating medium and usually having provision for the attachment of ducts.

*Gas vent* means that portion of a venting system designed to convey vent gases to the outdoors from the *vent connector* of a gas-fired *appliance* or directly from the *appliance* when a *vent connector* is not used.

*Grade* means the lowest of the average levels of finished ground adjoining each exterior wall of a *building*, except that localized depressions need not be considered in the determination of average levels of finished ground. (See *First storey* and Note A-1.4.1.2.(1).)

*Groundwater* means a free standing body of water in the ground.

*Groundwater level* (groundwater table) means the top surface of a free standing body of water in the ground.

*Guard* means a protective barrier around openings in floors or at the open sides of stairs, landings, balconies, *mezzanines*, galleries, raised *walkways* or other locations to prevent accidental falls from one level to another. Such a barrier may or may not have openings through it.

*Heat detector* means a *fire detector* designed to operate at a predetermined temperature or rate of temperature rise.

*Heavy timber construction* means that type of *combustible construction* in which a degree of fire safety is attained by placing limitations on the sizes of wood structural members and on the thickness and composition of wood floors and roofs and by the avoidance of concealed spaces under floors and roofs.

*High-hazard industrial occupancy* (Group F, Division 1) means an *industrial occupancy* containing sufficient quantities of highly *combustible* and flammable or explosive materials which, because of their inherent characteristics, constitute a special fire hazard.

*Horizontal exit* means an *exit* from one *building* to another by means of a doorway, vestibule, *walkway*, bridge or balcony.

*Horizontal service space* means a space such as an attic, duct, ceiling, roof or crawl space oriented essentially in a horizontal plane, concealed and generally inaccessible, through which *building* service facilities such as pipes, ducts and wiring may pass.

*Impeded egress zone* means a supervised area in which occupants have free movement but require the release, by security personnel, of security doors at the boundary before they are able to leave the area, but does not include a *contained use area*.

*Indirect service water heater* means a *service water heater* that derives its heat from a heating medium such as warm air, steam or hot water.

*Industrial occupancy* means the *occupancy* or use of a *building* or part thereof for the assembling, fabricating, manufacturing, processing, repairing or storing of goods and materials.

*Interconnected floor space* means superimposed *floor areas* or parts of *floor areas* in which floor assemblies that are required to be *fire separations* are penetrated by openings that are not provided with *closures*.

*Limiting distance* means the distance from an *exposing building face* to a property line, the centre line of a *street*, lane or public thoroughfare, or to an imaginary line between 2 *buildings* or *fire compartments* on the same property, measured at right angles to the *exposing building face*.

*Live load* means a variable load due to the intended use and *occupancy* that is to be assumed in the design of the structural members of a *building*. It includes loads due to cranes and the pressure of liquids in containers.

*Loadbearing* (as applying to a *building* element) means subjected to or designed to carry loads in addition to its own *dead load*, excepting a wall element subjected only to wind or earthquake loads in addition to its own *dead load*.

*Low-hazard industrial occupancy* (Group F, Division 3) means an *industrial occupancy* in which the *combustible* content is not more than 50 kg/m<sup>2</sup> or 1 200 MJ/m<sup>2</sup> of *floor area*.

*Major occupancy* means the principal *occupancy* for which a *building* or part thereof is used or intended to be used, and shall be deemed to include the subsidiary *occupancies* that are an integral part of the principal *occupancy*. The *major occupancy* classifications used in this Code are as follows:

- A1 – *Assembly occupancies* intended for the production and viewing of the performing arts
- A2 – *Assembly occupancies* not elsewhere classified in Group A
- A3 – *Assembly occupancies* of the arena type
- A4 – *Assembly occupancies* in which the occupants are gathered in the open air
- B1 – *Detention occupancies* in which persons are under restraint or are incapable of self-preservation because of security measures not under their control
- B2 – *Treatment occupancies*
- B3 – *Care occupancies*
- C – *Residential occupancies*
- D – *Business and personal services occupancies*
- E – *Mercantile occupancies*
- F1 – *High-hazard industrial occupancies*
- F2 – *Medium-hazard industrial occupancies*
- F3 – *Low-hazard industrial occupancies*

*Masonry or concrete chimney* means a *chimney* of brick, stone, concrete or masonry units constructed on site.

*Means of egress* means a continuous path of travel provided for the escape of persons from any point in a *building* or contained open space to a separate *building*, an open public thoroughfare, or an exterior open space protected from fire exposure from the *building* and having access to an open public thoroughfare. *Means of egress* includes *exits* and *access to exits*.

*Mechanically vented* (as applying to a fuel-fired space- or water-heating *appliance*) means an *appliance* and its combustion venting system in which the products of combustion are entirely exhausted to the outdoors by a mechanical device, such as a fan, blower or aspirator, upstream or downstream from the combustion zone of the *appliance*, and the portion of the combustion venting system that is downstream of the fan, blower or aspirator is sealed and does not include draft hoods or draft control devices. (See Note A-1.4.1.2.(1).)

*Medium-hazard industrial occupancy* (Group F, Division 2) means an *industrial occupancy* in which the *combustible* content is more than 50 kg/m<sup>2</sup> or 1 200 MJ/m<sup>2</sup> of *floor area* and not classified as a *high-hazard industrial occupancy*.

*Mercantile occupancy* means the *occupancy* or use of a *building* or part thereof for the displaying or selling of retail goods, wares or merchandise.

*Mezzanine* means an intermediate floor assembly between the floor and ceiling of any room or *storey* and includes an interior balcony.

*Noncombustible* means that a material meets the acceptance criteria of CAN/ULC-S114, "Test for Determination of Non-Combustibility in Building Materials."

*Noncombustible construction* means that type of construction in which a degree of fire safety is attained by the use of *noncombustible* materials for structural members and other *building* assemblies.

*Occupancy* means the use or intended use of a *building* or part thereof for the shelter or support of persons, animals or property.

*Occupant load* means the number of persons for which a *building* or part thereof is designed.

*Open-air storey* means a *storey* in which at least 25% of the total area of its perimeter walls is open to the outdoors in a manner that will provide cross-ventilation to the entire *storey*.

*Owner* means any person, firm or corporation controlling the property under consideration.

*Partition* means an interior wall 1 *storey* or part-*storey* in height that is not *loadbearing*.

*Party wall* means a wall jointly owned and jointly used by 2 parties under easement agreement or by right in law, and erected at or upon a line separating 2 parcels of land each of which is, or is capable of being, a separate real-estate entity.

*Perched groundwater* means a free standing body of water in the ground extending to a limited depth.

*Pile* means a slender *deep foundation unit* made of materials such as wood, steel or concrete or a combination thereof, that is either premanufactured and placed by driving, jacking, jetting or screwing, or cast-in-place in a hole formed by driving, excavating or boring. (Cast-in-place bored *piles* are often referred to as *caissons* in Canada.)

*Plenum* means a chamber forming part of an air duct system.

*Plumbing system* means a drainage system, a venting system and a water system or parts thereof.

*Post-disaster building* means a *building* that is essential to the provision of services in the event of a disaster, and includes

- hospitals, emergency treatment facilities and blood banks,
- telephone exchanges,
- power generating stations and electrical substations,
- control centres for air, land and marine transportation,
- public water treatment and storage facilities, and pumping stations,
- sewage treatment facilities and *buildings* having critical national defence functions, and
- *buildings* of the following types, unless exempted from this designation by the authority having jurisdiction:
  - emergency response facilities,
  - fire, rescue and police stations and housing for vehicles, aircraft or boats used for such purposes, and
  - communications facilities, including radio and television stations.

(See Note A-1.4.1.2.(1).)

*Private sewage disposal system* means a privately owned plant for the treatment and disposal of sewage (such as a septic tank with an absorption field).

*Process plant* means an *industrial occupancy* where materials, including *flammable liquids*, *combustible liquids*, or gases, are produced or used in a process. (See Table 3.2.7.1. of Division B of the NFC.)

*Protected floor space* means that part of a *floor area* protected from the effects of fire and used as part of a *means of egress* from an *interconnected floor space*.

*Public corridor* means a corridor that provides *access to exit* from more than one *suite*. (See Note A-1.4.1.2.(1).)

*Public way* means a sidewalk, *street*, highway, square or other open space to which the public has access, as of right or by invitation, expressed or implied.

*Repair garage* means a *building* or part thereof where facilities are provided for the repair or servicing of motor vehicles.

*Residential occupancy* means the *occupancy* or use of a *building* or part thereof by persons for whom sleeping accommodation is provided but who are not harboured for the purpose of receiving *care* or *treatment* and are not involuntarily detained.

*Return duct* means a duct for conveying air from a space being heated, ventilated or air-conditioned back to the heating, ventilating or air-conditioning *appliance*.

*Rim joist* means the outermost member in floor framing, other than blocking, be it parallel, perpendicular or on an angle to the floor joists. (See Note A-1.4.1.2.(1).)

*Rock* means that portion of the earth's crust that is consolidated, coherent and relatively hard and is a naturally formed, solidly bonded, mass of mineral matter that cannot readily be broken by hand.

*Run* means the horizontal distance between two adjacent tread nosings on a stair. (See Figure A-9.8.4.-B in Note A-9.8.4. of Division B.)

*Sanitary drainage system* means a drainage system that conducts sewage.

*Secondary suite* means a self-contained *dwelling unit* with a prescribed *floor area* located in a *building* or portion of a *building* of only *residential occupancy* that contains only one other *dwelling unit* and common spaces, and where both *dwelling units* constitute a single real estate entity. (See Note A-1.4.1.2.(1) and Article 9.1.2.1. of Division B.)

*Service room* means a room provided in a *building* to contain equipment associated with *building services*. (See Note A-1.4.1.2.(1).)

*Service space* means space provided in a *building* to facilitate or conceal the installation of *building service facilities* such as chutes, ducts, pipes, shafts or wires.

*Service water heater* means a device for heating water for plumbing services.

*Shallow foundation* means a *foundation unit* that derives its support from *soil* or *rock* located close to the lowest part of the *building* that it supports.

*Smoke alarm* means a combined *smoke detector* and audible alarm device designed to sound an alarm within the room or *suite* in which it is located upon the detection of smoke within that room or *suite*.

*Smoke detector* means a *fire detector* designed to operate when the concentration of airborne combustion products exceeds a predetermined level.

*Soil* means that portion of the earth's crust that is fragmentary, or such that some individual particles of a dried sample may be readily separated by agitation in water; it includes boulders, cobbles, gravel, sand, silt, clay and organic matter.

*Solid masonry* means a single wythe or multi-wythe construction made of *solid masonry units* or semi-solid, cored, or hollow masonry units, the cells of which may or may not be filled with mortar or grout. In multi-wythe masonry construction, the space between the wythes consists of a mortar-filled collar joint or grout-filled space and the wythes may or may not be constructed of the same masonry materials.

*Solid masonry unit* means a concrete block or brick unit, a clay brick unit, or calcium silicate brick unit whose net solid area is at least 75% of its gross area. (See Note A-1.4.1.2.(1).)

*Sound transmission class (STC)* means a single number rating of the airborne sound attenuation of a *building assembly* separating two adjoining spaces, taking into account the direct sound transmission path. (See Note A-1.4.1.2.(1).) (See also Note A-9.11. of Division B.)

*Space heater* means a *space-heating appliance* for heating the room or space within which it is located, without the use of ducts.

*Space-heating appliance* means an *appliance* intended for the supplying of heat to a room or space directly, such as a *space heater*, fireplace or *unit heater*, or to rooms or spaces of a *building* through a heating system such as a central *furnace* or *boiler*.

*Sprinklered* (as applying to a *building* or part thereof) means that the *building* or part thereof is equipped with a system of automatic sprinklers.

*Stage* means a space that is designed primarily for theatrical performances with provision for quick change scenery and overhead lighting, including environmental control for a wide range of lighting and sound effects and that is traditionally, but not necessarily, separated from the audience by a proscenium wall and curtain opening.

*Storage garage* means a *building* or part thereof intended for the storage or parking of motor vehicles and containing no provision for the repair or servicing of such vehicles. (See Note A-1.4.1.2.(1).)

*Storage-type service water heater* means a *service water heater* with an integral hot water storage tank.

*Storey* means that portion of a *building* that is situated between the top of any floor and the top of the floor next above it, and if there is no floor above it, that portion between the top of such floor and the ceiling above it.

*Stove* means an *appliance* intended for cooking and space heating.

*Street* means any highway, road, boulevard, square or other improved thoroughfare 9 m or more in width, that has been dedicated or deeded for public use and is accessible to fire department vehicles and equipment.

*Subsurface investigation* means the appraisal of the general subsurface conditions at a *building* site by analysis of information gained by such methods as geological surveys, in situ testing, sampling, visual inspection, laboratory testing of samples of the subsurface materials and *groundwater* observations and measurements.

*Suite* means a single room or series of rooms of complementary use, operated under a single tenancy, and includes *dwelling units*, individual guest rooms in motels, hotels, boarding houses, rooming houses and dormitories as well as individual stores and individual or complementary rooms for *business and personal services occupancies*. (See Note A-1.4.1.2.(1).)

*Supply duct* means a duct for conveying air from a heating, ventilating or air-conditioning *appliance* to a space to be heated, ventilated or air-conditioned.

*Tapered tread* means a tread with non-parallel edges that increases or decreases its *run* uniformly over its width.

*Theatre* means a place of public assembly intended for the production and viewing of the performing arts or the screening and viewing of motion pictures, and consisting of an auditorium with permanently fixed seats intended solely for a viewing audience.

*Treatment* means the provision of medical or other health-related intervention to persons, where the administration or lack of administration of these interventions may render them incapable of evacuating to a safe location without the assistance of another person. (See Note A-1.4.1.2.(1).)

*Treatment occupancy* means the *occupancy* or use of a *building* or part thereof for the provision of *treatment*, and where overnight accommodation is available to facilitate the *treatment*. (See Note A-1.4.1.2.(1).)

*Unit heater* means a suspended *space heater* with an integral air-circulating fan.

*Unprotected opening* (as applying to *exposing building face*) means a doorway, window or opening other than one equipped with a *closure* having the required *fire-protection rating*, or any part of a wall forming part of the *exposing building face* that has a *fire-resistance rating* less than that required for the *exposing building face*.

*Unsafe condition* means any condition that could cause undue hazard to the life, limb or health of any person authorized or expected to be on or about the premises.

*Unstable liquid* means a liquid, including *flammable liquids* and *combustible liquids*, that is chemically reactive to the extent that it will vigorously react or decompose at or near normal temperature and pressure conditions or that is chemically unstable when subjected to impact.

*Vapour barrier* means the elements installed to control the diffusion of water vapour.

*Vent connector* (as applying to heating or cooling systems) means the part of a venting system that conducts the *flue* gases or vent gases from the *flue collar* of a *gas appliance* to the *chimney* or *gas vent*, and may include a draft control device.

*Vertical service space* means a shaft oriented essentially vertically that is provided in a *building* to facilitate the installation of *building* services including mechanical, electrical and plumbing installations and facilities such as elevators, refuse chutes and linen chutes.

*Walkway* means a covered or roofed pedestrian thoroughfare used to connect 2 or more *buildings*.

**1.4.2. Symbols and Other Abbreviations**

**1.4.2.1. Symbols and Other Abbreviations**

**1)** The symbols and other abbreviations in this Code shall have the meanings assigned to them in this Article and Article 1.3.2.1. of Division B.

1 in 2 .....	slope of 1 vertical to 2 horizontal
cm .....	centimetre(s)
° .....	degree(s)
°C .....	degree(s) Celsius
dBA .....	A-weighted sound level
diam .....	diameter
g .....	gram(s)
h .....	hour(s)
HDD .....	heating degree-day(s)
HVAC .....	heating, ventilating and air-conditioning
Hz .....	hertz
J .....	joule(s)
K .....	degree(s) Kelvin
kg .....	kilogram(s)
kN .....	kilonewton(s)
kPa .....	kilopascal(s)
kW .....	kilowatt(s)
L .....	litre(s)
lx .....	lux
m .....	metre(s)
M .....	metric nomenclature for reinforcing bars
max. ....	maximum
mg .....	milligram(s)
min. ....	minimum
min .....	minute(s)
MJ .....	megajoule(s)
mm .....	millimetre(s)
MPa .....	megapascal(s)
N .....	newton
n/a .....	not applicable
ng .....	nanogram(s)
No. ....	number(s)
o.c. ....	on centre
OSB .....	oriented strandboard
PM .....	particulate matter
ppb .....	part(s) per billion
ppm .....	part(s) per million
R .....	thermal resistance value (imperial unit)
RSI .....	thermal resistance value (metric unit)
s .....	second(s)
W .....	watt(s)

% .....	percent
µg .....	microgram(s)
µm .....	micrometre(s)
U-value .....	overall thermal transmittance

## Section 1.5. Referenced Documents and Organizations

### 1.5.1. Referenced Documents

#### 1.5.1.1. Application of Referenced Documents

**1)** Except as provided in Sentence (2), the provisions of documents referenced in this Code, and of any documents referenced within those documents, apply only to the extent that they relate to

- a) *buildings*, and
- b) the objectives and functional statements attributed to the applicable acceptable solutions in Division B where the documents are referenced.

(See Note A-1.5.1.1.(1).)

**2)** Where a provision of this Code references another National Model Code, the applicable objectives and functional statements shall include those found in that referenced National Model Code. (See Note A-2.1.1.2.(6).)

#### 1.5.1.2. Conflicting Requirements

**1)** In case of conflict between the provisions of this Code and those of a referenced document, the provisions of this Code shall govern.

#### 1.5.1.3. Applicable Editions

**1)** Where documents are referenced in this Code, they shall be the editions designated in Subsection 1.3.1. of Division B.

### 1.5.2. Organizations

#### 1.5.2.1. Abbreviations of Proper Names

**1)** The abbreviations of proper names in this Code shall have the meanings assigned to them in Article 1.3.2.1. of Division B.



# Notes to Part 1 Compliance

**A-1.1.1.1.(1) Application to Existing Buildings.** This Code is most often applied to existing or relocated buildings when an owner wishes to rehabilitate a building, change its use, or build an addition, or when an enforcement authority decrees that a building or class of buildings be altered for reasons of public safety. It is not intended that the NBC be used to enforce the retrospective application of new requirements to existing buildings or existing portions of relocated buildings, unless specifically required by local regulations or bylaws. For example, although the NFC could be interpreted to require the installation of fire alarm, standpipe and hose, and automatic sprinkler systems in an existing building for which there were no requirements at the time of construction, it is the intent of the CCBFC that the NFC not be applied in this manner to these buildings unless the authority having jurisdiction has determined that there is an inherent threat to occupant safety and has issued an order to eliminate the unsafe condition, or where substantial changes or additions are being made to an existing building or the occupancy has been changed. (See also Note A-1.1.1.1.(1) of Division A of the NFC.)

Relocated buildings that have been in use in another location for a number of years can be considered as existing buildings, in part, and the same analytical process can be applied as for existing buildings. It should be noted, however, that a change in occupancy may affect some requirements (e.g. loads and fire separations) and relocation to an area with different wind, snow or earthquake loads will require the application of current code requirements. Depending on the construction of the building and the changes in load, structural modifications may be required. Similarly, parts of a relocated or existing building that are reconstructed, such as foundations and basements, or parts being modified are required to be built to current codes.

Whatever the reason, Code application to existing or relocated buildings requires careful consideration of the level of safety needed for that building. This consideration involves an analytical process similar to that required to assess alternative design proposals for new construction. See Clause 1.2.1.1.(1)(b) for information on achieving compliance with the Code using alternative solutions.

In developing Code requirements for new buildings, consideration has been given to the cost they impose on a design in relation to the perceived benefits in terms of safety. The former is definable; the latter difficult to establish on a quantitative basis. In applying the Code requirements to an existing building, the benefits derived are the same as in new buildings. On the other hand, the increased cost of implementing in an existing building a design solution that would normally be intended for a new building may be prohibitive.

The successful application of Code requirements to existing construction becomes a matter of balancing the cost of implementing a requirement with the relative importance of that requirement to the overall Code objectives. The degree to which any particular requirement can be relaxed without affecting the intended level of safety of the Code requires considerable judgment on the part of both the designer and the authority having jurisdiction.

Further information on the application of Code requirements to existing or relocated buildings can be found in the following publications:

- "User's Guide – NBC 1995, Fire Protection, Occupant Safety and Accessibility (Part 3)"
- "Guidelines for Application of Part 3 of the National Building Code of Canada to Existing Buildings"
- Commentary entitled "Application of NBC Part 4 of Division B for the Structural Evaluation and Upgrading of Existing Buildings" of the "User's Guide – NBC 2015, Structural Commentaries (Part 4 of Division B)"
- "User's Guide – NBC 1995, Application of Part 9 to Existing Buildings"
- CBD 230, "Applying Building Codes to Existing Buildings"

These publications can be ordered through NRC's Web site.

---

These Notes are included for explanatory purposes only and do not form part of the requirements. The number that introduces each Note corresponds to the applicable requirement in this Part.

**A-1.1.1.1.(2) Factory-Constructed Buildings.** The NBC applies the same requirements to site-built and factory-constructed buildings. However, it can often be difficult to determine whether a factory-constructed building complies with the Code once it has been delivered to the construction site because many of the wall, roof and floor assemblies are closed in and so their components cannot be inspected. CSA A277, “Procedure for Factory Certification of Buildings,” was developed to address this problem with regard to residential, commercial and industrial buildings. This standard describes a procedure whereby an independent certification agency can review the quality control procedures of a factory and make periodic unannounced inspections of its products. The standard is not a building code, only a procedure for certifying compliance of factory-constructed components with a building code or other standard. If a factory-constructed building bears the label of an accredited certification agency indicating that compliance with the National Building Code has been certified using the CSA A277 procedure, the accepting authority will have some assurance that the concealed components do not require re-inspection on site.

On the other hand, standards in the CSA Z240 MH Series, “Manufactured Homes,” do resemble a building code. Most of the individual standards in the series contain requirements regarding many issues also covered in the NBC. Some of these Z240 MH provisions are performance requirements with no quantitative criteria, some simply reference the applicable NBC requirements, while others contain requirements that differ from those in the NBC. Because it would be illogical to have two different sets of requirements for buildings—one set that applies to site-built buildings and one set that applies to factory-constructed buildings—the NBC does not reference these Z240 MH standards. One of the individual standards in the Z240 MH series deals with special requirements for manufactured homes related to the fact that these houses must be moved over roads, which is an issue the NBC does not address. Therefore, labeling that indicates that a factory-constructed house complies with the Z240 MH standards can NOT be taken as an indication that the house necessarily complies with the building code in effect for the location where the house will be sited.

The NBC does reference CSA Z240.10.1, “Site Preparation, Foundation, and Anchorage of Manufactured Homes,” which is not actually part of the CSA Z240 MH Series. This standard contains requirements for surface foundations where buildings—not just houses—comply with the deformation resistance test provided in CSA Z240.2.1, “Structural Requirements for Manufactured Homes.”

**A-1.2.1.1.(1)(a) Code Compliance via Acceptable Solutions.** If a building design (e.g. material, component, assembly or system) can be shown to meet all provisions of the applicable acceptable solutions in Division B (e.g. it complies with the applicable provisions of a referenced standard), it is deemed to have satisfied the objectives and functional statements linked to those provisions and thus to have complied with that part of the Code. In fact, if it can be determined that a design meets all the applicable acceptable solutions in Division B, there is no need to consult the objectives and functional statements in Division A to determine its compliance.

**A-1.2.1.1.(1)(b) Code Compliance via Alternative Solutions.** Where a design differs from the acceptable solutions in Division B, then it should be treated as an “alternative solution.” A proponent of an alternative solution must demonstrate that the alternative solution addresses the same issues as the applicable acceptable solutions in Division B and their attributed objectives and functional statements. However, because the objectives and functional statements are entirely qualitative, demonstrating compliance with them in isolation is not possible. Therefore, Clause 1.2.1.1.(1)(b) identifies the principle that Division B establishes the quantitative performance targets that alternative solutions must meet. In many cases, these targets are not defined very precisely by the acceptable solutions—certainly far less precisely than would be the case with a true performance code, which would have quantitative performance targets and prescribed methods of performance measurement for all aspects of building performance. Nevertheless, Clause 1.2.1.1.(1)(b) makes it clear that an effort must be made to demonstrate that an alternative solution will perform as well as a design that would satisfy the applicable acceptable solutions in Division B—not “well enough” but “as well as.”

In this sense, it is Division B that defines the boundaries between acceptable risks and the “unacceptable” risks referred to in the statements of the Code’s objectives, i.e. the risk remaining once the applicable acceptable solutions in Division B have been implemented represents the residual level of risk deemed to be acceptable by the broad base of Canadians who have taken part in the consensus process used to develop the Code.

### **Level of Performance**

Where Division B offers a choice between several possible designs, it is likely that these designs may not all provide exactly the same level of performance. Among a number of possible designs satisfying acceptable solutions in Division B, the design providing the lowest level of performance should generally be considered to establish the minimum acceptable level of performance to be used in evaluating alternative solutions for compliance with the Code.

Sometimes a single design will be used as an alternative solution to several sets of acceptable solutions in Division B. In this case, the level of performance required of the alternative solution should be at least equivalent to the overall level of performance established by all the applicable sets of acceptable solutions taken as a whole.

Each provision in Division B has been analyzed to determine what it is intended to achieve. The resultant intent statements clarify what undesirable results each provision seeks to preclude. These statements are not a legal component of the Code, but are advisory in nature, and can help Code users establish performance targets for alternative solutions. They are published as part of the online Code subscriptions and as a separate electronic document entitled "Supplement to the NBC 2015: Intent Statements," which is available on NRC's Web site.

### **Areas of Performance**

A subset of the acceptable solutions in Division B may establish criteria for particular types of designs (e.g. certain types of materials, components, assemblies, or systems). Often such subsets of acceptable solutions are all attributed to the same objective: Fire Safety for example. In some cases, the designs that are normally used to satisfy this subset of acceptable solutions might also provide some benefits that could be related to some other objective: Fire Protection of the Building for example. However, if none of the applicable acceptable solutions are linked to Objective OP1, Fire Protection of the Building, it is not necessary that alternative solutions proposed to replace these acceptable solutions provide a similar benefit related to Fire Protection of the Building. In other words, the acceptable solutions in Division B establish acceptable levels of performance for compliance with the Code only in those areas defined by the objectives and functional statements attributed to the acceptable solutions.

### **Applicable Acceptable Solutions**

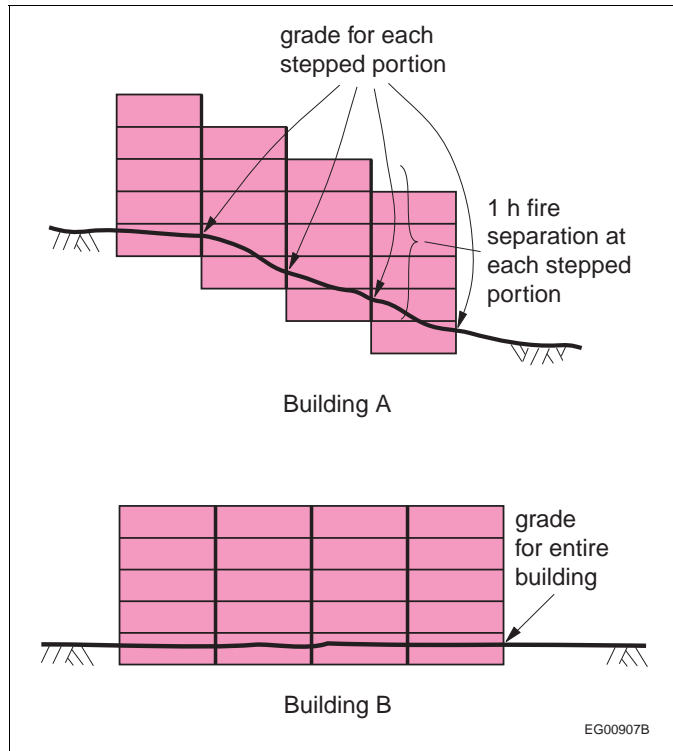
In demonstrating that an alternative solution will perform as well as a design that would satisfy the applicable acceptable solutions in Division B, its evaluation should not be limited to comparison with the acceptable solutions to which an alternative is proposed. It is possible that acceptable solutions elsewhere in the Code also apply. The proposed alternative solution may be shown to perform as well as the most apparent acceptable solution which it is replacing but may not perform as well as other relevant acceptable solutions. For example, an innovative sheathing material may perform adequately as sheathing in a wall system that is braced by other means but may not perform adequately as sheathing in a wall system where the sheathing must provide the structural bracing. All applicable acceptable solutions should be taken into consideration in demonstrating the compliance of an alternative solution.

**A-1.3.3.4.(1) Buildings Divided by Firewalls.** This concept relates to the provisions directly regulated by this Code and does not apply to electrical service entrance requirements, which are regulated by other documents.

**A-1.3.3.4.(2) Buildings on Sloping Sites.** Application of the definition of grade to stepped buildings on sloping sites often results in such buildings being designated as being greater than 4 storeys in building height even though there may be only 2, 3 or 4 storeys at any one location. Figure A-1.3.3.4.(2) illustrates this application compared to a similar building on a flat site.

Under Sentence 1.3.3.4.(2), Building A can be considered as being 4 storeys in building height instead of 7 storeys in building height. Both Building A and B are comparable with regard to fire safety and egress.

This relaxation applies to the determination of building height only. All other requirements continue to apply as appropriate.



**Figure A-1.3.3.4.(2)**  
Application of the definition of grade

**A-1.4.1.2.(1) Defined Terms.**

**ASTC and STC**

The higher the ASTC or STC rating, the more the assembly or the system of assemblies protects occupants from noise in adjacent spaces.

These ratings, which are determined in accordance with ASTM E 413, "Classification for Rating Sound Insulation," roughly describe the noise reduction in decibels (dB) provided by the separating floor or wall, or in the case of the ASTC rating, by the system of separating and adjoining walls and floors. For example, where an 80 dB sound on one side of a wall/floor/ceiling is reduced to 30 dB on the other side, that partition is said to have an STC of 50.

The dB scale is a logarithmic one and the human ear perceives a 10 dB reduction in sound as roughly halving the volume: for example, a 40 dB noise, subjectively, seems half as loud as a 50 dB one.

**Care Occupancy**

Support services rendered by or through care facility management refer to services provided by the organization that is responsible for the care for a period exceeding 24 consecutive hours. They do not refer to services provided by residents of dwelling units or suites, or to services arranged directly by residents of dwelling units or suites with outside agencies.

In the context of care occupancies, these services may include a daily assessment of the resident's functioning, awareness of their whereabouts, the making of appointments for residents and reminding them of those appointments, the ability and readiness to intervene if a crisis arises for a resident, supervision in areas of nutrition or medication, and provision of transient medical services. Services may also include activities of daily living such as bathing, dressing, feeding, and assistance in the use of washroom facilities, etc. No actual treatment is provided by or through care facility management.

**Dangerous Goods**

In previous editions of the NBC, the terminology used to identify dangerous goods came from TC SOR/2008-34, "Transportation of Dangerous Goods Regulations (TDGR)." The TDGR apply solely to

the adequate identification of hazards related to dangerous goods in the contexts of transportation and emergency response.

Dangerous goods in the workplace are identified in accordance with the “Workplace Hazardous Materials Information System (WHMIS),” established in accordance with the “Hazardous Products Act.” The WHMIS identification system is specifically designed with the users of the product in mind.

This edition of the NBC identifies dangerous goods as products regulated by the TDGR or classified under the WHMIS. In order to harmonize these two nomenclatures for dangerous goods, class descriptors were developed taking into consideration both the TDGR and WHMIS classification systems. The proposed nomenclature introduces a descriptive approach to classifying dangerous goods, which is similar to the one proposed by the Globally Harmonized System of Classification and Labelling of Chemicals (GHS) developed by the United Nations (UN). Canada has actively participated in the development of the GHS and has committed to its implementation through the TDGR and WHMIS regulations.

The NBC 2015 nomenclature takes a common sense approach that corresponds more closely to how people refer to dangerous goods on a daily basis, blending TDGR and WHMIS terminology without using nondescript numbers and letters as previously found in the NBC, TDGR and WHMIS.

**Table A-1.4.1.2.(1)**  
**UN, TDGR, WHMIS and NBC Class Descriptors for Dangerous Goods**

UN	TDGR	WHMIS	NBC 2015
1	Explosives	Explosives	Explosives
2	Gases	Gases under pressure	Compressed gases
2.1	Flammable gases	Flammable gases; Flammable aerosols	Flammable gases; Flammable aerosols
2.2	Non-flammable, non-toxic gases	Gases under pressure	Non-flammable, non-toxic gases
2.2 (5.1)	—	Oxidizing gases	Oxidizing gases
2.3	Toxic gases	—	Toxic gases
3	Flammable liquids	Flammable liquids	Flammable liquids
4.1	Flammable solids	Flammable solids	Flammable solids
4.2	Substances liable to spontaneous combustion	Pyrophoric liquids; pyrophoric solids	Pyrophoric materials
4.3	Water-reactive substances	Substances and mixtures which, in contact with water, emit flammable gases	Water-reactive substances
5.1	Oxidizing substances	Oxidizing liquids; oxidizing solids	Oxidizers
5.2	Organic peroxides	Organic peroxides	Organic peroxides
6.1	Toxic substances	(1)	Toxic substances
6.2	Infectious substances	(1)	Infectious materials
7	Radioactive materials	Not covered by GHS	Radioactive materials
8	Corrosives	(2)	Corrosives
9	Miscellaneous products, substances, or organisms	(2)	Miscellaneous dangerous goods
—	—	Previously Class F	Dangerously reactive materials

**Notes to Table A-1.4.1.2.(1):**

- (1) The WHMIS has various descriptors for this Class of products based on their toxicity.
- (2) The WHMIS has various descriptors for this Class of products based on the nature of the danger presented by the product.

**Exit**

Exits include doors or doorways leading directly into an exit stair or directly to the outside. In the case of an exit leading to a separate building, exits also include vestibules, walkways, bridges or balconies.

**Farm Building**

Farm buildings as defined in Article 1.4.1.2. include, but are not limited to, produce storage and packing facilities, livestock and poultry housing, milking centres, manure storage facilities, grain bins, silos, feed preparation centres, farm workshops, greenhouses, farm retail centres, and horse riding, exercise and training facilities. Farm buildings may be classed as low or high human occupancy, depending on the occupant load.

Examples of farm buildings likely to be classed as low human occupancy as defined in Article 1.2.1.2. of the National Farm Building Code of Canada are livestock and poultry housing, manure and machinery storage facilities and horse exercise and training facilities where no bleachers or viewing area are provided.

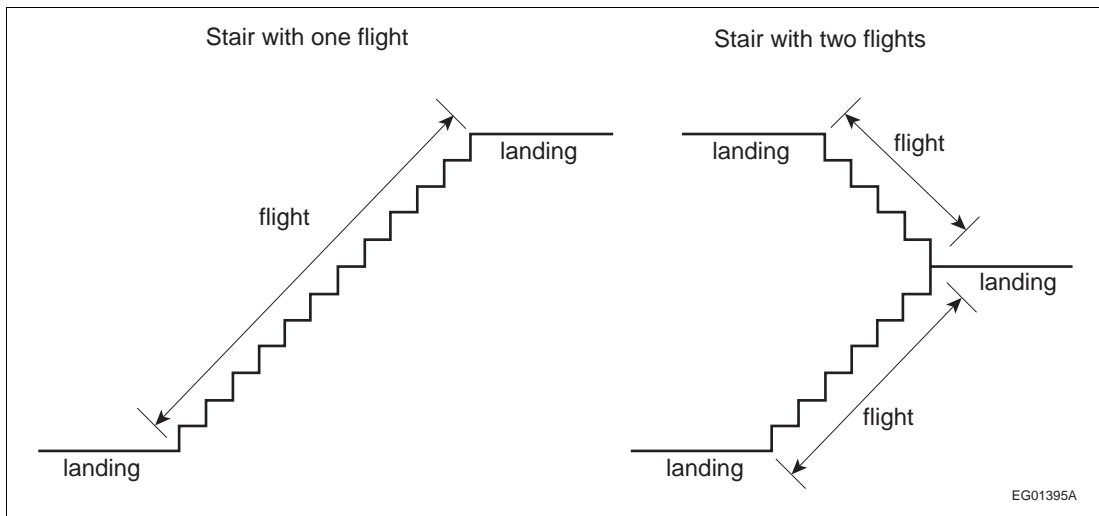
Examples of farm buildings that would be classed as other than low human occupancy include farm retail centres for feeds, horticultural and livestock produce, auction barns and show areas where bleachers or other public facilities are provided. Farm work centres where the number of workers frequently exceeds the limit for low human occupancy will also be in this category.

It is possible to have areas of both high and low human occupancy in the same building provided that the structural safety and fire separation requirements for high human occupancy are met in the part thus designated.

**Fire Separation**

It is generally understood that the term “fire” refers to all products of combustion, including heat and smoke. Although a fire separation is not always required to have a fire-resistance rating, it should act as a barrier to the spread of smoke and fire until some type of response is initiated. If the fire-resistance rating of a fire separation is permitted to be waived on the basis of the presence of an automatic sprinkler system, it is nonetheless the intent of the Code that the fire separation be constructed so that it will remain in place and act as a barrier against the spread of smoke until the sprinklers have actuated.

**Flight**



**Figure A-1.4.1.2.(1)-A**  
**Flight**

**Grade**

Localized depressions that need not be considered in the determination of the elevation of grade include such features as vehicle and pedestrian entrances and other minor depressions that do not affect accessibility for firefighting or evacuation.

**Mechanically Vented**

The definition of this term is intended to include all types of appliances and venting systems that rely entirely on fans to evacuate the products of combustion. Systems variously referred to as “forced draft,”

“power vented” and “induced draft” in standards and industry terminology may be covered by this definition. The key characteristic of such systems is that they are more resistant to depressurization-induced spillage of combustion products into the building in which they are housed because the combustion venting system downstream of the fan is “sealed,” i.e. includes no draft hood or draft control device.

**Post-disaster Building**

There may be circumstances where the authority having jurisdiction would choose to exempt certain types of buildings or parts thereof from being designated as post-disaster buildings in order to permit them to be governed by Part 9 rather than by the rest of the Code. Such is the case in the following examples: an ambulance that is stored at a volunteer’s residence or a police station that is housed in a small shopping mall. The circumstances where such exemptions are permitted are intentionally limited by the definition of post-disaster building.

**Public Corridor**

A covered mall is considered to be a public corridor and, as such, is subject to the same requirements as a public corridor.

**Rim Joist**

In the field, rim joists may also be referred to as rim boards, headers or header joists.

**Secondary Suite**

A secondary suite is a self-contained dwelling unit of a prescribed maximum total floor area that is part of a building containing not more than two dwelling units (including the secondary suite) and any common spaces such as common storage, common service rooms, common laundry facilities or common areas used for egress. Secondary suites are typically created within an existing single dwelling unit—commonly called a “house”—either constructed as an addition to an existing house or incorporated during the construction of a new house. A secondary suite may have more than one storey and may be on the same level as the principal dwelling unit of the house or be above or below it.

Examples of buildings where secondary suites are permitted include individual detached houses, or where the secondary suite is located in a portion of a building, semi-detached houses (half of a double) and freehold row houses.

Where a building has multiple occupancies, the secondary suite can only be created in a portion of the building that is of residential occupancy. Apartment buildings have more than two dwelling units and are therefore not permitted to have secondary suites.

Neither dwelling unit in a house can be strata-titled or otherwise subdivided from the remainder of the house under provincial or territorial legislation. This means that both dwelling units are registered under the same title.

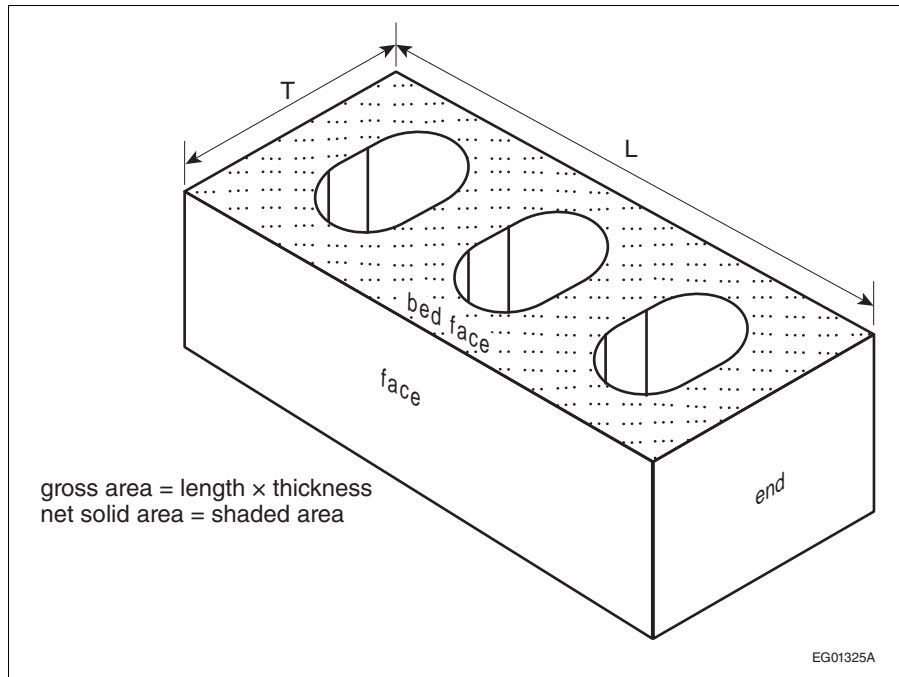
Secondary suites are also referred to as “accessory suites” or “secondary units” by various jurisdictions.

**Service Room**

Typical examples of service rooms include boiler rooms, furnace rooms, incinerator rooms, garbage handling rooms and rooms to accommodate air-conditioning or heating appliances, pumps, compressors and electrical equipment. Rooms such as elevator machine rooms and common laundry rooms are not considered to be service rooms.

**Solid Masonry Units**

The net solid area of a masonry unit is calculated by determining the gross area of the bed face of the unit ( $L \times T$ ) and subtracting the cumulative areas of the hollow portions. As long as the total area of the hollow portions is 25% or less of the gross area, the unit is considered to be a solid masonry unit.



**Figure A-1.4.1.2.(1)-B**  
**Net solid area of masonry unit**

### Storage Garage

Entrances at which vehicles stop for a short time beneath an unenclosed canopy to pick up and drop off passengers are not considered as storage garages.

### Suite

Tenancy in the context of the term “suite” applies to both rental and ownership tenure. In a condominium arrangement, for example, dwelling units are considered separate suites even though they are individually owned. In order to be of complementary use, a series of rooms that constitute a suite must be in reasonably close proximity to each other and have access to each other either directly by means of a common doorway or indirectly by a corridor, vestibule or other similar arrangement.

The term “suite” does not apply to rooms such as service rooms, common laundry rooms and common recreational rooms that are not leased or under a separate tenure in the context of the Code. Similarly, the term “suite” is not normally applied in the context of buildings such as schools and hospitals, since the entire building is under a single tenure. However, a room that is individually rented is considered a suite. A warehousing unit in a mini-warehouse is a suite. A rented room in a nursing home could be considered as a suite if the room was under a separate tenure. A hospital bedroom on the other hand is not considered to be under a separate tenure, since the patient has little control of that space, even though he pays the hospital a per diem rate for the privilege of using the hospital facilities, which include the sleeping areas.

For certain requirements in the Code, the expression “room or suite” is used (e.g., travel distance). This means that the requirement applies within the rooms of suites as well as to the suite itself and to rooms that may be located outside the suite. In other places the expression “suite, and rooms not located within a suite” is used (e.g., for the installation of smoke and heat detectors). This means that the requirement applies to individual suites as defined, but not to each room within the suite. The rooms “not within a suite” would include common laundry rooms, common recreational rooms and service rooms, which are not considered as tenant-occupied space.

### Treatment

The ability to evacuate unassisted implies that a person is capable of recognizing and responding to an emergency given their physical, cognitive and behavioural abilities, and able to move to a safe location without the assistance of another person. For example, such persons must be able to arise and walk, or transfer from a bed or chair to a means of mobility, and leave the building or move to a safe location on their own.



**Treatment Occupancy**

“Treatments” may include such things as surgery, intensive care, and emergency medical intervention. Treatment services differ from the services provided by care occupancies like personal care assistance or the administration of medication, and from those provided by business and personal services occupancies like dentistry or day procedures.

**A-1.5.1.1.(1) Application of Referenced Documents.** Documents referenced in the NBC may contain provisions covering a wide range of issues, including issues that are unrelated to the objectives and functional statements stated in Parts 2 and 3 of Division A respectively; e.g. aesthetic issues such as colour-fastness or uniformity. Sentence 1.5.1.1.(1) is intended to make it clear that, whereas referencing a document in the NBC generally has the effect of making the provisions of that document part of the Code, provisions that are unrelated to buildings or to the objectives and functional statements attributed to the provisions in Division B where the document is referenced are excluded.

Furthermore, many documents referenced in the NBC contain references to other documents, which may also, in turn, refer to other documents. These secondary and tertiary referenced documents may contain provisions that are unrelated to buildings or to the objectives and functional statements of the NBC: such provisions—no matter how far down the chain of references they occur—are not included in the intent of Sentence 1.5.1.1.(1).



# **Part 2**

## **Objectives**

<b>2.1.</b>	<b>Application</b>	
2.1.1.	Application .....	2-1
<b>2.2.</b>	<b>Objectives</b>	
2.2.1.	Objectives .....	2-2
	<b>Notes to Part 2</b> .....	<b>2-7</b>



# Part 2

## Objectives

### Section 2.1. Application

#### 2.1.1. Application

##### 2.1.1.1. Application

- 1) This Part applies to all *buildings* covered in this Code. (See Article 1.1.1.1.)

##### 2.1.1.2. Application of Objectives

(See Note A-2.2.1.1.(1).)

1) Except as provided in Sentences (2) to (6), the objectives described in this Part apply

- a) to all *buildings* covered in this Code (see Article 1.1.1.1.), and
- b) only to the extent that they relate to compliance with this Code as required in Article 1.2.1.1.

2) Objective OS4, Resistance to Unwanted Entry, applies only to *dwelling units* in *buildings* covered in Part 9 of Division B. (See Article 1.3.3.3.)

3) Objective OH3, Noise Protection, applies only to *dwelling units*.

4) Objective OH5, Hazardous Substances Containment, applies only to the extent defined in

- a) the National Plumbing Code of Canada 2015, and
- b) the National Fire Code of Canada 2015.

5) Objective OA, Accessibility (including Objectives OA1, Barrier-Free Path of Travel, and OA2, Barrier-Free Facilities), does not apply to

- a) detached houses, semi-detached houses, houses with a *secondary suite*, duplexes, triplexes, townhouses, row houses and boarding houses (see Note A-1.4.1.2.(1), Secondary Suite),
- b) *buildings* of Group F, Division 1 *major occupancy*, and
- c) *buildings* that are not intended to be occupied on a daily or full-time basis, including automatic telephone exchanges, pumphouses and substations.

6) Objective OE, Environment (including Objectives OE1, Resources, and OE1.1, Excessive Use of Energy), applies only to

- a) *buildings* of *residential occupancy* to which Part 9 of Division B applies,
- b) *buildings* containing *business and personal services, mercantile or low-hazard industrial occupancies* to which Part 9 of Division B applies whose combined total floor area does not exceed 300 m<sup>2</sup>, and
- c) *buildings* containing a mix of the *residential* and *non-residential occupancies* described in Clauses (a) and (b).

(See Note A-2.1.1.2.(6).) (See also Article 1.3.3.3.)

## Section 2.2. Objectives

### 2.2.1. Objectives

#### 2.2.1.1. Objectives

- 1) The objectives of this Code are as follows (see Note A-2.2.1.1.(1)):

#### OS Safety

An objective of this Code is to limit the probability that, as a result of the design, construction or demolition of the *building*, a person in or adjacent to the *building* will be exposed to an unacceptable risk of injury.

#### OS1 Fire Safety

An objective of this Code is to limit the probability that, as a result of the design or construction of the *building*, a person in or adjacent to the *building* will be exposed to an unacceptable risk of injury due to fire. The risks of injury due to fire addressed in this Code are those caused by—

- OS1.1 – fire or explosion occurring
- OS1.2 – fire or explosion impacting areas beyond its point of origin
- OS1.3 – collapse of physical elements due to a fire or explosion
- OS1.4 – fire safety systems failing to function as expected
- OS1.5 – persons being delayed in or impeded from moving to a safe place during a fire emergency

#### OS2 Structural Safety

An objective of this Code is to limit the probability that, as a result of the design or construction of the *building*, a person in or adjacent to the *building* will be exposed to an unacceptable risk of injury due to structural failure. The risks of injury due to structural failure addressed in this Code are those caused by—

- OS2.1 – loads bearing on the *building* elements that exceed their *loadbearing* capacity
- OS2.2 – loads bearing on the *building* that exceed the *loadbearing* properties of the supporting medium
- OS2.3 – damage to or deterioration of *building* elements
- OS2.4 – vibration or deflection of *building* elements
- OS2.5 – instability of the *building* or part thereof
- OS2.6 – collapse of the *excavation*

#### OS3 Safety in Use

An objective of this Code is to limit the probability that, as a result of the design or construction of the *building*, a person in or adjacent to the *building* will be exposed to an unacceptable risk of injury due to hazards. The risks of injury due to hazards addressed in this Code are those caused by—

- OS3.1 – tripping, slipping, falling, contact, drowning or collision
- OS3.2 – contact with hot surfaces or substances
- OS3.3 – contact with energized equipment
- OS3.4 – exposure to hazardous substances
- OS3.5 – exposure to high levels of sound from fire alarm systems
- OS3.6 – persons becoming trapped in confined spaces
- OS3.7 – persons being delayed in or impeded from moving to a safe place during an emergency (see Note A-2.2.1.1.(1))

**OS4 Resistance to Unwanted Entry**

An objective of this Code is to limit the probability that, as a result of the design or construction of the *building*, a person in the *building* will be exposed to an unacceptable risk of injury due to the *building's* low level of resistance to unwanted entry (see Sentence 2.1.1.2.(2) for application limitation). The risks of injury due to unwanted entry addressed in this Code are those caused by—

- OS4.1 – intruders being able to force their way through locked doors or windows
- OS4.2 – occupants being unable to identify potential intruders as such

**OS5 Safety at Construction and Demolition Sites**

An objective of this Code is to limit the probability that, as a result of the construction or demolition of the *building*, the public adjacent to a construction or demolition site will be exposed to an unacceptable risk of injury due to hazards. The risks of injury due to construction and demolition hazards addressed in this Code are those caused by—

- OS5.1 – objects projected onto *public ways*
- OS5.2 – vehicular accidents on *public ways*
- OS5.3 – damage to or obstruction of *public ways*
- OS5.4 – water accumulated in *excavations*
- OS5.5 – entry into the site
- OS5.6 – exposure to hazardous substances and activities
- OS5.7 – loads bearing on a covered way that exceed its *loadbearing* capacity
- OS5.8 – collapse of the *excavation*
- OS5.9 – persons being delayed in or impeded from moving to a safe place during an emergency (see Note A-2.2.1.1.(1))

**OH Health**

An objective of this Code is to limit the probability that, as a result of the design or construction of the *building*, a person will be exposed to an unacceptable risk of illness.

**OH1 Indoor Conditions**

An objective of this Code is to limit the probability that, as a result of the design or construction of the *building*, a person in the *building* will be exposed to an unacceptable risk of illness due to indoor conditions. The risks of illness due to indoor conditions addressed in this Code are those caused by—

- OH1.1 – inadequate indoor air quality
- OH1.2 – inadequate thermal comfort
- OH1.3 – contact with moisture

**OH2 Sanitation**

An objective of this Code is to limit the probability that, as a result of the design or construction of the *building*, a person in the *building* will be exposed to an unacceptable risk of illness due to unsanitary conditions. The risks of illness due to unsanitary conditions addressed in this Code are those caused by—

- OH2.1 – exposure to human or domestic waste
- OH2.2 – consumption of contaminated water
- OH2.3 – inadequate facilities for personal hygiene
- OH2.4 – contact with contaminated surfaces
- OH2.5 – contact with vermin and insects

**OH3 Noise Protection**

An objective of this Code is to limit the probability that, as a result of the design or construction of the *building*, a person in the *building* will be exposed to an unacceptable risk of illness due to high levels of sound originating in adjacent spaces in the *building* (see Sentence 2.1.1.2.(3) for application limitation). The risks of illness due to high levels of sound addressed in this Code are those caused by—

- OH3.1 – exposure to airborne sound transmitted through assemblies separating *dwelling units* from adjacent spaces in the *building*

**OH4 Vibration and Deflection Limitation**

An objective of this Code is to limit the probability that, as a result of the design or construction of the *building*, a person in the *building* will be exposed to an unacceptable risk of illness due to high levels of vibration or deflection of *building* elements.

**OH5 Hazardous Substances Containment**

An objective of this Code is to limit the probability that, as a result of the design or construction of the *building*, the public will be exposed to an unacceptable risk of illness due to the release of hazardous substances from the *building* (see Sentence 2.1.1.2.(4) for application limitation).

**OA Accessibility**

An objective of this Code is to limit the probability that, as a result of the design or construction of the *building*, a person with a physical or sensory limitation will be unacceptably impeded from accessing or using the *building* or its facilities (see Sentence 2.1.1.2.(5) for application limitations).

**OA1 Barrier-Free Path of Travel**

An objective of this Code is to limit the probability that, as a result of the design or construction of the *building*, a person with a physical or sensory limitation will be unacceptably impeded from accessing the *building* or circulating within it (see Sentence 2.1.1.2.(5) for application limitations).

**OA2 Barrier-Free Facilities**

An objective of this Code is to limit the probability that, as a result of the design or construction of the *building*, a person with a physical or sensory limitation will be unacceptably impeded from using the *building's* facilities (see Sentence 2.1.1.2.(5) for application limitations).

**OP Fire and Structural Protection of Buildings**

An objective of this Code is to limit the probability that, as a result of the design, construction or demolition of the *building*, the *building* or adjacent *buildings* will be exposed to an unacceptable risk of damage due to fire or structural insufficiency, or the *building* or part thereof will be exposed to an unacceptable risk of loss of use also due to structural insufficiency.



**OP1 Fire Protection of the Building**

An objective of this Code is to limit the probability that, as a result of its design or construction, the *building* will be exposed to an unacceptable risk of damage due to fire. The risks of damage due to fire addressed in this Code are those caused by—

- OP1.1 – fire or explosion occurring
- OP1.2 – fire or explosion impacting areas beyond its point of origin
- OP1.3 – collapse of physical elements due to a fire or explosion
- OP1.4 – fire safety systems failing to function as expected

**OP2 Structural Sufficiency of the Building**

An objective of this Code is to limit the probability that, as a result of its design or construction, the *building* or part thereof will be exposed to an unacceptable risk of damage or loss of use due to structural failure or lack of structural serviceability. The risks of damage and of loss of use due to structural failure or lack of structural serviceability addressed in this Code are those caused by—

- OP2.1 – loads bearing on the *building* elements that exceed their *loadbearing* capacity
- OP2.2 – loads bearing on the *building* that exceed the *loadbearing* properties of the supporting medium
- OP2.3 – damage to or deterioration of *building* elements
- OP2.4 – vibration or deflection of *building* elements
- OP2.5 – instability of the *building* or part thereof
- OP2.6 – instability or movement of the supporting medium

**OP3 Protection of Adjacent Buildings from Fire**

An objective of this Code is to limit the probability that, as a result of the design or construction of the *building*, adjacent *buildings* will be exposed to an unacceptable risk of damage due to fire. The risks of damage to adjacent *buildings* due to fire addressed in this Code are those caused by—

- OP3.1 – fire or explosion impacting areas beyond the *building* of origin

**OP4 Protection of Adjacent Buildings from Structural Damage**

An objective of this Code is to limit the probability that, as a result of the design, construction or demolition of the *building*, adjacent *buildings* will be exposed to an unacceptable risk of structural damage. The risks of structural damage to adjacent *buildings* addressed in this Code are those caused by—

- OP4.1 – settlement of the medium supporting adjacent *buildings*
- OP4.2 – collapse of the *building* or portion thereof onto adjacent *buildings*
- OP4.3 – impact of the *building* on adjacent *buildings*
- OP4.4 – collapse of the *excavation*

**OE Environment**

An objective of this Code is to limit the probability that, as a result of the design or construction of the *building*, the environment will be affected in an unacceptable manner.

**OE1 Resources**

An objective of this Code is to limit the probability that, as a result of the design or construction of the *building*, resources will be used in a manner that will have an unacceptable effect on the environment. The risks of unacceptable effect on the environment due to use of resources addressed in this Code are those caused by –

OE1.1 – excessive use of energy

# Notes to Part 2

## Objectives

**A-2.1.1.2.(6) Application of Environment Objective.** Objective OE, Environment (including its sub-objectives), is attributed to the requirements in Section 9.36. of Division B, which address energy efficiency for small residential buildings and certain small non-residential and mixed-use buildings (see Article 9.36.1.3. of Division B). The objectives, functional statements and energy efficiency requirements for larger Part 9 residential buildings as well as for non-residential buildings whose combined total floor area exceeds 300 m<sup>2</sup> and some mixed-use buildings are addressed in the National Energy Code for Buildings.

### **A-2.2.1.1.(1) Objectives.**

#### **Listing of objectives**

Any gaps in the numbering sequence of the objectives are due to the fact that there is a master list of objectives covering the four principal National Code Documents—the National Building Code, the National Fire Code, the National Plumbing Code and the National Energy Code for Buildings—but not all objectives are pertinent to all Codes.

#### **The building**

Where the term “the building” is used in the wording of the objectives, it refers to the building for which compliance with the National Building Code is being assessed.

#### **Emergency**

The term “emergency”—in the context of safety in buildings—is often equated to the term “fire emergency;” however, the wording of objectives OS3.7 and OS5.9 makes it clear that the Code addresses any type of emergency that would require the rapid evacuation of the building, such as a bomb threat or the presence of intruders.

---

These Notes are included for explanatory purposes only and do not form part of the requirements. The number that introduces each Note corresponds to the applicable requirement in this Part.



# **Part 3**

## **Functional Statements**

<b>3.1.</b>	<b>Application</b>	
3.1.1.	Application .....	3-1
<b>3.2.</b>	<b>Functional Statements</b>	
3.2.1.	Functional Statements .....	3-1
	<b>Notes to Part 3</b> .....	<b>3-5</b>



# Part 3

## Functional Statements

### Section 3.1. Application

#### 3.1.1. Application

##### 3.1.1.1. Application

- 1) This Part applies to all *buildings* covered in this Code. (See Article 1.1.1.1.)

##### 3.1.1.2. Application of Functional Statements

1) Except as provided in Sentences (2) to (4), the functional statements described in this Part apply

- a) to all *buildings* covered in this Code (see Article 1.1.1.1.), and
- b) only to the extent that they relate to compliance with this Code as required in Article 1.2.1.1.

2) Functional Statement F56 applies only to *dwelling units*.

3) Functional Statements F73 and F74 do not apply to

- a) detached houses, semi-detached houses, houses with a *secondary suite*, duplexes, triplexes, townhouses, row houses and boarding houses (see Note A-1.4.1.2.(1), Secondary Suite),
- b) *buildings* of Group F, Division 1 *major occupancy*, and
- c) *buildings* that are not intended to be occupied on a daily or full-time basis, including automatic telephone exchanges, pumphouses and substations.

4) Functional Statements F90 to F93, F95, F96 and F98 to F100 apply only to

- a) *buildings* of *residential occupancy* to which Part 9 of Division B applies,
- b) *buildings* containing *business and personal services, mercantile or low-hazard industrial occupancies* to which Part 9 of Division B applies whose combined total *floor area* does not exceed 300 m<sup>2</sup>, and
- c) *buildings* containing a mix of the *residential* and *non-residential occupancies* described in Clauses (a) and (b).

(See also Article 1.3.3.3.)

### Section 3.2. Functional Statements

#### 3.2.1. Functional Statements

##### 3.2.1.1. Functional Statements

1) The objectives of this Code are achieved by measures, such as those described in the acceptable solutions in Division B, that are intended to allow the *building* or its elements to perform the following functions (see Note A-3.2.1.1.(1)):

- F01** To minimize the risk of accidental ignition.
- F02** To limit the severity and effects of fire or explosions.
- F03** To retard the effects of fire on areas beyond its point of origin.
- F04** To retard failure or collapse due to the effects of fire.
- F05** To retard the effects of fire on emergency egress facilities.

- F06 To retard the effects of fire on facilities for notification, suppression and emergency response.
- F10 To facilitate the timely movement of persons to a safe place in an emergency.
- F11 To notify persons, in a timely manner, of the need to take action in an emergency.
- F12 To facilitate emergency response.
- F13 To notify emergency responders, in a timely manner, of the need to take action in an emergency.
  
- F20 To support and withstand expected loads and forces.
- F21 To limit or accommodate dimensional change.
- F22 To limit movement under expected loads and forces.
- F23 To maintain equipment in place during structural movement.
  
- F30 To minimize the risk of injury to persons as a result of tripping, slipping, falling, contact, drowning or collision.
- F31 To minimize the risk of injury to persons as a result of contact with hot surfaces or substances.
- F32 To minimize the risk of injury to persons as a result of contact with energized equipment.
- F33 To limit the level of sound of a fire alarm system.
- F34 To resist or discourage unwanted access or entry.
- F35 To facilitate the identification of potential intruders.
- F36 To minimize the risk that persons will be trapped in confined spaces.
  
- F40 To limit the level of contaminants.
- F41 To minimize the risk of generation of contaminants.
- F42 To resist the entry of vermin and insects.
- F43 To minimize the risk of release of hazardous substances.
- F44 To limit the spread of hazardous substances beyond their point of release.
- F46 To minimize the risk of contamination of potable water.
  
- F50 To provide air suitable for breathing.
- F51 To maintain appropriate air and surface temperatures.
- F52 To maintain appropriate relative humidity.
- F53 To maintain appropriate indoor/outdoor air pressure differences.
- F54 To limit drafts.
- F55 To resist the transfer of air through environmental separators.
- F56 To limit the transmission of airborne sound into a *dwelling unit* from spaces elsewhere in the *building* (see Sentence 3.1.1.2.(2) for application limitation).
  
- F60 To control the accumulation and pressure of water on and in the ground.
- F61 To resist the ingress of precipitation, water or moisture from the exterior or from the ground.
- F62 To facilitate the dissipation of water and moisture from the *building*.
- F63 To limit moisture condensation.



- F70** To provide potable water.
- F71** To provide facilities for personal hygiene.
- F72** To provide facilities for the sanitary disposal of human and domestic wastes.
- F73** To facilitate access to and circulation in the *building* and its facilities by persons with physical or sensory limitations (see Sentence 3.1.1.2.(3) for application limitation).
- F74** To facilitate the use of the *building's* facilities by persons with physical or sensory limitations (see Sentence 3.1.1.2.(3) for application limitation).
  
- F80** To resist deterioration resulting from expected service conditions.
- F81** To minimize the risk of malfunction, interference, damage, tampering, lack of use or misuse.
- F82** To minimize the risk of inadequate performance due to improper maintenance or lack of maintenance.
  
- F90** To limit the amount of uncontrolled air leakage through the *building* envelope.
- F91** To limit the amount of uncontrolled air leakage through system components.
- F92** To limit the amount of uncontrolled thermal transfer through the *building* envelope.
- F93** To limit the amount of uncontrolled thermal transfer through system components.
- F95** To limit the unnecessary demand and/or consumption of energy for heating and cooling.
- F96** To limit the unnecessary demand and/or consumption of energy for service water heating.
- F98** To limit the inefficiency of equipment.
- F99** To limit the inefficiency of systems.
  
- F100** To limit the unnecessary rejection of reusable waste energy.



# Notes to Part 3

## Functional Statements

**A-3.2.1.1.(1) Listing of Functional Statements.** The numbered functional statements are grouped according to functions that deal with closely related subjects. For example, the first group deals with fire risks, the second group deals with emergency egress and response, etc. There may be gaps in the numbering sequence for the following reasons:

- Each group has unused numbers which allows for the possible future creation of additional functional statements within any one group.
- There is a master list of functional statements covering the four principal National Code Documents—the National Building Code, the National Fire Code, the National Plumbing Code and the National Energy Code for Buildings—but not all functional statements are pertinent to all Codes.

---

These Notes are included for explanatory purposes only and do not form part of the requirements. The number that introduces each Note corresponds to the applicable requirement in this Part.





# **Division B**

## **Acceptable Solutions**



# Part 1

## General

<b>1.1.</b>	<b>General</b>	
1.1.1.	Application .....	1-1
1.1.2.	Objectives and Functional Statements .....	1-1
1.1.3.	Climatic and Seismic Data .....	1-1
1.1.4.	Fire Safety Plan .....	1-1
<b>1.2.</b>	<b>Terms and Abbreviations</b>	
1.2.1.	Definitions of Words and Phrases ..	1-1
1.2.2.	Symbols and Other Abbreviations ..	1-2
<b>1.3.</b>	<b>Referenced Documents and Organizations</b>	
1.3.1.	Referenced Documents .....	1-2
1.3.2.	Organizations .....	1-27
	<b>Notes to Part 1 .....</b>	<b>1-31</b>





# Part 1 General

## Section 1.1. General

### 1.1.1. Application

#### 1.1.1.1. Application

1) This Part applies to all *buildings* covered in this Code. (See Article 1.1.1.1. of Division A.)

### 1.1.2. Objectives and Functional Statements

#### 1.1.2.1. Attributions to Acceptable Solutions

1) For the purpose of compliance with this Code as required in Clause 1.2.1.1.(1)(b) of Division A, the objectives and functional statements attributed to the acceptable solutions in Division B shall be the objectives and functional statements identified in Sections 3.10., 4.5., 5.10., 6.4., 7.2., 8.3. and 9.37. (See Note A-1.1.2.1.(1).)

### 1.1.3. Climatic and Seismic Data

#### 1.1.3.1. Climatic and Seismic Values

1) The climatic and seismic values required for the design of *buildings* under this Code shall be in conformance with the values established by the *authority having jurisdiction* or, in the absence of such data, with Sentence (2) and the climatic and seismic values in Appendix C. (See Note A-1.1.3.1.(1).)

2) The outside winter design temperatures determined from Appendix C shall be those listed for the January 2.5% values. (See Note A-1.1.3.1.(2).)

#### 1.1.3.2. Depth of Frost Penetration

1) Depth of frost penetration shall be established on the basis of local experience.

### 1.1.4. Fire Safety Plan

#### 1.1.4.1. Fire Safety Plan

1) Where a fire safety plan is required, it shall conform to Section 2.8. of Division B of the NFC.

## Section 1.2. Terms and Abbreviations

### 1.2.1. Definitions of Words and Phrases

#### 1.2.1.1. Non-defined Terms

1) Words and phrases used in Division B that are not included in the list of definitions in Article 1.4.1.2. of Division A shall have the meanings that are commonly assigned to them in the context in which they are used, taking into account the

specialized use of terms by the various trades and professions to which the terminology applies.

**2)** Where objectives and functional statements are referred to in Division B, they shall be the objectives and functional statements described in Parts 2 and 3 of Division A.

**3)** Where acceptable solutions are referred to in Division B, they shall be the provisions stated in Parts 3 to 9.

### 1.2.1.2. Defined Terms

**1)** The words and terms in italics in Division B shall have the meanings assigned to them in Article 1.4.1.2. of Division A.

## 1.2.2. Symbols and Other Abbreviations

### 1.2.2.1. Symbols and Other Abbreviations

**1)** The symbols and other abbreviations in Division B shall have the meanings assigned to them in Article 1.4.2.1. of Division A and Article 1.3.2.1.

## Section 1.3. Referenced Documents and Organizations

### 1.3.1. Referenced Documents

#### 1.3.1.1. Effective Date

**1)** Unless otherwise specified herein, the documents referenced in this Code shall include all amendments, revisions, reaffirmations, reapprovals, addenda and supplements effective to 30 June 2014.

#### 1.3.1.2. Applicable Editions

**1)** Where documents are referenced in this Code, they shall be the editions designated in Table 1.3.1.2.

**Table 1.3.1.2.**  
**Documents Referenced in the National Building Code of Canada 2015<sup>(1)</sup>**  
Forming Part of Sentence 1.3.1.2.(1)

Issuing Agency	Document Number <sup>(2)</sup>	Title of Document <sup>(3)</sup>	Code Reference
AAMA	501-05	Test for Exterior Walls	A-5.9.3.
AAMA	501.1-05	Water Penetration of Windows, Curtain Walls and Doors Using Dynamic Pressure	A-5.9.3.
AAMA	501.2-09	Quality Assurance and Diagnostic Water Leakage Field Check of Installed Storefronts, Curtain Walls, and Sloped Glazing Systems	A-5.9.3.
AAMA	501.4-09	Recommended Static Test Method for Evaluating Curtain Wall and Storefront Systems Subjected to Seismic and Wind Induced Interstory Drifts	A-5.9.3.
AAMA	501.5-07	Thermal Cycling of Exterior Walls	A-5.9.3. A-5.9.3.3.(1)
AAMA	501.6-09	Recommended Dynamic Test Method For Determining The Seismic Drift Causing Glass Fallout From A Wall System	A-4.1.8.18.(15) and (16)(c) A-5.9.3.
ACGIH	28th Edition	Industrial Ventilation: A Manual of Recommended Practice for Design	6.3.2.14.(2) A-6.3.1.6.
AHAM	ANSI/AHAM RAC-1-1982	Room Air Conditioners	Table 9.36.3.10.

**Table 1.3.1.2. (Continued)**

Issuing Agency	Document Number <sup>(2)</sup>	Title of Document <sup>(3)</sup>	Code Reference
AHRI	ANSI/AHRI 210/240-2008	Performance Rating of Unitary Air-Conditioning and Air-Source Heat Pump Equipment	Table 9.36.3.10.
AHRI	1060 (I-P)-2013	Performance Rating of Air-to-Air Exchangers for Energy Recovery Ventilation Equipment	9.36.3.8.(4)
AHRI	BTS-2000	Efficiency of Commercial Space Heating Boilers	Table 9.36.3.10.
AISI	S201-12	North American Standard for Cold-Formed Steel Framing - Product Data	9.24.1.2.(1)
ANSI	A208.1-2009	Particleboard	9.23.15.2.(3) 9.29.9.1.(1) 9.30.2.2.(1)
ANSI/CSA	ANSI Z21.10.3-2013/CSA 4.3-2013	Gas-Fired Water Heaters, Volume III, Storage Water Heaters With Input Ratings Above 75,000 Btu Per Hour, Circulating and Instantaneous	Table 9.36.4.2.
ANSI/CSA	ANSI Z21.56-2013/CSA 4.7-2013	Gas-Fired Pool Heaters	Table 9.36.4.2.
ANSI/CSA	ANSI Z83.8-2013/CSA 2.6-2013	Gas Unit Heaters, Gas Packaged Heaters, Gas Utility Heaters and Gas-Fired Duct Furnaces	Table 9.36.3.10.
ASCE	ASCE/SEI 7-10	Minimum Design Loads for Buildings and Other Structures	A-4.1.8.18.(15) and (16)(c)
ASCE	ASCE/SEI 8-02	Design of Cold-Formed Stainless Steel Structural Members	A-4.3.4.2.(1)
ASCE	ASCE/SEI 49-12	Wind Tunnel Testing for Buildings and Other Structures	4.1.7.12.(1)
ASHRAE	1997	ASHRAE Handbook – Fundamentals	A-9.32.3.11.
ASHRAE	2013	ASHRAE Handbook – Fundamentals	A-9.36.2.4.(1) Table A-9.36.2.4.(1)-D
ASHRAE	Guideline 12-2000	Minimizing the Risk of Legionellosis Associated with Building Water Systems	6.3.2.15.(4) 6.3.2.16.(3)
ASHRAE	ANSI/ASHRAE 62-2001	Ventilation for Acceptable Indoor Air Quality (except Addendum n)	6.3.1.1.(2) A-9.25.5.2.
ASHRAE	ANSI/ASHRAE 62.1-2007	Ventilation for Acceptable Indoor Air Quality	6.3.2.2.(1)
ASHRAE	ANSI/ASHRAE 103-2007	Annual Fuel Utilization Efficiency of Residential Central Furnaces and Boilers	Table 9.36.3.10.
ASHRAE	ANSI/ASHRAE 140-2011	Evaluation of Building Energy Analysis Computer Programs	9.36.5.4.(8)
ASME/CSA	ASME A17.1-2010/CSA B44-10	Safety Code for Elevators and Escalators	3.2.6.7.(2) 3.5.2.1.(1) 3.5.2.1.(2) 3.5.2.1.(3) 3.5.4.2.(1) A-3.5.2.1.(1) Table 4.1.5.11. Table 4.1.8.18.
ASME	B18.6.1-1981	Wood Screws (Inch Series)	Table 5.9.1.1. 9.23.3.1.(3) A-9.23.3.1.(3)
ASTM	A 123/A 123M-13	Zinc (Hot-Dip Galvanized) Coatings on Iron and Steel Products	Table 5.9.1.1. Table 9.20.16.1.
ASTM	A 153/A 153M-09	Zinc Coating (Hot-Dip) on Iron and Steel Hardware	Table 5.9.1.1. Table 9.20.16.1.
ASTM	A 252-10	Welded and Seamless Steel Pipe Piles	4.2.3.8.(1)
ASTM	A 283/A 283M-13	Low and Intermediate Tensile Strength Carbon Steel Plates	4.2.3.8.(1)
ASTM	A 390-06	Zinc-Coated (Galvanized) Steel Poultry Fence Fabric (Hexagonal and Straight Line)	Table 9.10.3.1.-B
ASTM	A 653/A 653M-13	Steel Sheet, Zinc-Coated (Galvanized) or Zinc-Iron Alloy-Coated (Galvannealed) by the Hot-Dip Process	Table 5.9.1.1. 9.3.3.2.(1)

Table 1.3.1.2. (Continued)

Issuing Agency	Document Number <sup>(2)</sup>	Title of Document <sup>(3)</sup>	Code Reference
ASTM	A 792/A 792M-10	Steel Sheet, 55% Aluminum-Zinc Alloy-Coated by the Hot-Dip Process	9.3.3.2.(1)
ASTM	A 1008/A 1008M-13	Steel, Sheet, Cold-Rolled, Carbon, Structural, High-Strength Low-Alloy, High-Strength Low-Alloy with Improved Formability, Solution Hardened, and Bake Hardenable	4.2.3.8.(1)
ASTM	A 1011/A 1011M-14	Steel, Sheet and Strip, Hot-Rolled, Carbon, Structural, High-Strength Low-Alloy, High-Strength Low-Alloy with Improved Formability, and Ultra-High Strength	4.2.3.8.(1)
ASTM	C 4-04	Clay Drain Tile and Perforated Clay Drain Tile	Table 5.9.1.1. 9.14.3.1.(1)
ASTM	C 27-98	Fireclay and High-Alumina Refractory Brick	9.21.3.4.(1)
ASTM	C 73-10	Calcium Silicate Brick (Sand-Lime Brick)	Table 5.9.1.1. 9.20.2.1.(1)
ASTM	C 126-13	Ceramic Glazed Structural Clay Facing Tile, Facing Brick, and Solid Masonry Units	Table 5.9.1.1. 9.20.2.1.(1)
ASTM	C 177-13	Steady-State Heat Flux Measurements and Thermal Transmission Properties by Means of the Guarded-Hot-Plate Apparatus	9.36.2.2.(1)
ASTM	C 212-14	Structural Clay Facing Tile	Table 5.9.1.1. 9.20.2.1.(1)
ASTM	C 260/C 260M-10a	Air-Entraining Admixtures for Concrete	9.3.1.8.(1)
ASTM	C 411-11	Hot-Surface Performance of High-Temperature Thermal Insulation	3.6.5.4.(4) 3.6.5.5.(1) 9.33.6.4.(4) 9.33.8.2.(2)
ASTM	C 412M-11	Concrete Drain Tile (Metric)	Table 5.9.1.1. 9.14.3.1.(1)
ASTM	C 444M-03	Perforated Concrete Pipe (Metric)	Table 5.9.1.1. 9.14.3.1.(1)
ASTM	C 494/C 494M-13	Chemical Admixtures for Concrete	9.3.1.8.(1)
ASTM	C 516-08	Vermiculite Loose Fill Thermal Insulation	A-9.25.2.4.(5)
ASTM	C 518-10	Steady-State Thermal Transmission Properties by Means of the Heat Flow Meter Apparatus	9.36.2.2.(1)
ASTM	C 553-13	Mineral Fiber Blanket Thermal Insulation for Commercial and Industrial Applications	Table 5.9.1.1.
ASTM	C 612-14	Mineral Fiber Block and Board Thermal Insulation	Table 5.9.1.1.
ASTM	C 700-13	Vitrified Clay Pipe, Extra Strength, Standard Strength, and Perforated	Table 5.9.1.1. 9.14.3.1.(1)
ASTM	C 726-12	Mineral Wool Roof Insulation Board	Table 5.9.1.1. 9.25.2.2.(1)
ASTM	C 754-11	Installation of Steel Framing Members to Receive Screw-Attached Gypsum Panel Products	Table A-9.11.1.4.-A Table A-9.11.1.4.-B Table A-9.11.1.4.-C Table A-9.11.1.4.-D
ASTM	C 834-10	Latex Sealants	Table 5.9.1.1. 9.27.4.2.(2)
ASTM	C 840-13	Application and Finishing of Gypsum Board	Table 5.9.1.1.
ASTM	C 920-14	Elastomeric Joint Sealants	Table 5.9.1.1. 9.27.4.2.(2)
ASTM	C 954-11	Steel Drill Screws for the Application of Gypsum Panel Products or Metal Plaster Bases to Steel Studs from 0.033 in. (0.84 mm) to 0.112 in. (2.84 mm) in Thickness	9.24.1.4.(1)
ASTM	C 991-08e1	Flexible Fibrous Glass Insulation for Metal Buildings	Table 5.9.1.1.

**Table 1.3.1.2. (Continued)**

Issuing Agency	Document Number <sup>(2)</sup>	Title of Document <sup>(3)</sup>	Code Reference
ASTM	C 1002-07	Steel Self-Piercing Tapping Screws for the Application of Gypsum Panel Products or Metal Plaster Bases to Wood Studs or Steel Studs	Table 5.9.1.1. 9.24.1.4.(1) 9.29.5.7.(1)
ASTM	C 1177/C 1177M-13	Glass Mat Gypsum Substrate for Use as Sheathing	3.1.5.14.(6) 3.1.5.15.(4) Table 5.9.1.1. Table 9.23.17.2.-A A-9.27.13.2.(2)(a)
ASTM	C 1178/C 1178M-13	Coated Glass Mat Water-Resistant Gypsum Backing Panel	3.1.5.14.(6) 3.1.5.15.(4) Table 5.9.1.1. 9.29.5.2.(1)
ASTM	C 1184-13	Structural Silicone Sealants	Table 5.9.1.1. 9.27.4.2.(2)
ASTM	C 1193-13	Use of Joint Sealants	A-Table 5.9.1.1. A-9.27.4.2.(1)
ASTM	C 1299-03	Selection of Liquid-Applied Sealants	A-Table 5.9.1.1. A-9.27.4.2.(1)
ASTM	C 1311-10	Solvent Release Sealants	Table 5.9.1.1. 9.27.4.2.(2)
ASTM	C 1330-02	Cylindrical Sealant Backing for Use with Cold Liquid-Applied Sealants	Table 5.9.1.1. 9.27.4.2.(3)
ASTM	C 1363-11	Thermal Performance of Building Materials and Envelope Assemblies by Means of a Hot Box Apparatus	A-5.9.4.1.(1) 9.36.2.2.(4)
ASTM	C 1396/C 1396M-14	Gypsum Board	3.1.5.14.(6) 3.1.5.15.(4) Table 5.9.1.1. Table 9.23.17.2.-A 9.29.5.2.(1) Table 9.29.5.3.
ASTM	C 1472-10	Calculating Movement and Other Effects When Establishing Sealant Joint Width	A-Table 5.9.1.1. A-9.27.4.2.(1)
ASTM	C 1658/C 1658M-13	Glass Mat Gypsum Panels	3.1.5.14.(6) Table 5.9.1.1.
ASTM	D 323-08	Vapor Pressure of Petroleum Products (Reid Method)	1.4.1.2.(1) <sup>(4)</sup>
ASTM	D 1037-12	Evaluating Properties of Wood-Base Fiber and Particle Panel Materials	A-9.23.15.2.(4)
ASTM	D 1143/D 1143M-07	Deep Foundations Under Static Axial Compressive Load	A-4.2.7.2.(2)
ASTM	D 1227-95	Emulsified Asphalt Used as a Protective Coating for Roofing	Table 5.9.1.1. 9.13.2.2.(2) 9.13.3.2.(2)
ASTM	D 2178/D 2178M-13a	Asphalt Glass Felt Used in Roofing and Waterproofing	Table 5.9.1.1.
ASTM	D 2898-10	Accelerated Weathering of Fire-Retardant-Treated Wood for Fire Testing	3.1.4.8.(2) 3.1.5.5.(3) 3.1.5.24.(1) 3.2.3.7.(4) 9.10.14.5.(3) 9.10.15.5.(3)
ASTM	D 3019-08	Lap Cement Used with Asphalt Roll Roofing, Non-Fibered, Asbestos-Fibered, and Non-Asbestos-Fibered	Table 5.9.1.1. 9.13.3.2.(2) Table 9.26.2.1.-B

Copyright © NRC 1941 - 2021 World Rights Reserved © CNRC 1941-2021 Droits réservés pour tous pays

Table 1.3.1.2. (Continued)

Issuing Agency	Document Number <sup>(2)</sup>	Title of Document <sup>(3)</sup>	Code Reference
ASTM	D 4479/D 4479M-07	Asphalt Roof Coatings – Asbestos-Free	Table 5.9.1.1. 9.13.2.2.(2) 9.13.3.2.(2) Table 9.26.2.1.-B
ASTM	D 4637/D 4637M-12	EPDM Sheet Used In Single-Ply Roof Membrane	Table 5.9.1.1. 9.13.3.2.(2) Table 9.26.2.1.-B
ASTM	D 4811/D 4811M-06	Nonvulcanized (Uncured) Rubber Sheet Used as Roof Flashing	Table 5.9.1.1. 9.13.3.2.(2) Table 9.26.2.1.-B
ASTM	D 5456-10a	Evaluation of Structural Composite Lumber Products	3.1.11.7.(4)
ASTM	D 6878/D 6878M-11a	Thermoplastic Polyolefin Based Sheet Roofing	Table 5.9.1.1. 9.13.3.2.(2) Table 9.26.2.1.-B
ASTM	E 90-09	Laboratory Measurement of Airborne Sound Transmission Loss of Building Partitions and Elements	5.8.1.2.(1) 5.8.1.4.(1) 9.11.1.2.(1)
ASTM	E 96/E 96M-13	Water Vapor Transmission of Materials	5.5.1.2.(3) 9.13.2.2.(2) 9.25.4.2.(1) 9.25.5.1.(1) 9.30.1.2.(1)
ASTM	E 283-04	Determining Rate of Air Leakage Through Exterior Windows, Curtain Walls, and Doors Under Specified Pressure Differences Across the Specimen	5.9.3.4.(2) A-5.9.3.4.(2)
ASTM	E 330/E 330M-02	Structural Performance of Exterior Windows, Doors, Skylights and Curtain Walls by Uniform Static Air Pressure Difference	A-5.9.3.2.(1)
ASTM	E 331-00	Water Penetration of Exterior Windows, Skylights, Doors, and Curtain Walls by Uniform Static Air Pressure Difference	5.9.3.5.(2) A-5.9.3.5.(2)
ASTM	E 336-11	Measurement of Airborne Sound Attenuation between Rooms in Buildings	5.8.1.2.(2) 5.8.1.4.(7) 9.11.1.2.(2) A-9.11.
ASTM	E 413-10	Classification for Rating Sound Insulation	A-1.4.1.2.(1) <sup>(4)</sup> 5.8.1.2.(1) 5.8.1.2.(2) 5.8.1.4.(7) 5.8.1.5.(3) 9.11.1.2.(1) 9.11.1.2.(2)
ASTM	E 492-09	Laboratory Measurement of Impact Sound Transmission Through Floor-Ceiling Assemblies Using the Tapping Machine	A-9.11.
ASTM	E 547-00	Water Penetration of Exterior Windows, Skylights, Doors, and Curtain Walls by Cyclic Static Air Pressure Difference	5.9.3.5.(2) A-5.9.3.5.(2)
ASTM	E 597-95	Determining a Single Number Rating of Airborne Sound Insulation for Use in Multi-Unit Building Specifications	A-9.11.
ASTM	E 736-00	Cohesion/Adhesion of Sprayed Fire-Resistive Materials Applied to Structural Members	Table 9.10.3.1.-B
ASTM	E 783-02	Field Measurement of Air Leakage Through Installed Exterior Windows and Doors	A-5.9.2.3.(1) A-5.9.3.4.(2)
ASTM	E 1007-13b	Field Measurement of Tapping Machine Impact Sound Transmission Through Floor-Ceiling Assemblies and Associated Support Structures	A-9.11.

**Table 1.3.1.2. (Continued)**

Issuing Agency	Document Number <sup>(2)</sup>	Title of Document <sup>(3)</sup>	Code Reference
ASTM	E 1105-00	Field Determination of Water Penetration of Installed Exterior Windows, Skylights, Doors, and Curtain Walls, by Uniform or Cyclic Static Air Pressure Difference	A-5.9.2.3.(1) A-5.9.3.5.(2)
ASTM	E 1300-12ae1	Determining Load Resistance of Glass in Buildings	4.3.6.1.(1) 9.6.1.3.(1)
ASTM	E 2178-13	Air Permeance of Building Materials	5.4.1.2.(1)
ASTM	E 2190-10	Insulating Glass Unit Performance and Evaluation	Table 5.9.1.1. 9.6.1.2.(1)
ASTM	E 2357-11	Determining Air Leakage of Air Barrier Assemblies	9.36.2.9.(1) A-9.36.2.9.(1)
ASTM	F 476-14	Security of Swinging Door Assemblies	9.7.5.2.(2) A-9.7.5.2.(2)
ASTM	F 1667-13	Driven Fasteners: Nails, Spikes, and Staples	9.23.3.1.(1) 9.26.2.3.(1) 9.29.5.6.(1)
AWPA	M4-11	Care of Preservative-Treated Wood Products	4.2.3.2.(2)
BNQ	BNQ 3624-115/2007	Polyethylene (PE) Pipe and Fittings – Flexible Pipes for Drainage – Characteristics and Test Methods	Table 5.9.1.1. 9.14.3.1.(1)
CCBFC	NRCC 35951	Guidelines for Application of Part 3 of the National Building Code of Canada to Existing Buildings	A-1.1.1.1.(1) <sup>(4)</sup>
CCBFC	NRCC 38730	Model National Energy Code of Canada for Houses 1997	A-9.36.3.10.(1) A-9.36.4.2.(1)
CCBFC	NRCC 38732	National Farm Building Code of Canada 1995	1.1.1.1.(3) <sup>(4)</sup> A-1.4.1.2.(1) <sup>(4)</sup> A-Table 4.1.2.1. A-5.1.2.1.(1)
CCBFC	NRCC 40383	User's Guide – NBC 1995, Fire Protection, Occupant Safety and Accessibility (Part 3)	A-1.1.1.1.(1) <sup>(4)</sup>
CCBFC	NRCC 43963	User's Guide – NBC 1995, Application of Part 9 to Existing Buildings	A-1.1.1.1.(1) <sup>(4)</sup>
CCBFC	NRCC 56191	National Energy Code of Canada for Buildings 2015	A-2.1.1.2.(6) <sup>(4)</sup> A-2.2.1.1.(1) <sup>(4)</sup> A-3.2.1.1.(1) <sup>(4)</sup> 9.36.1.3.(1) 9.36.1.3.(4) 9.36.3.1.(2) 9.36.4.1.(2) A-9.36.1.3. A-9.36.2.4.(1) A-9.36.3.10.(1) A-9.36.4.2.(1) A-9.36.5.2. A-2.2.8.1.(1) <sup>(5)</sup>

Table 1.3.1.2. (Continued)

Issuing Agency	Document Number <sup>(2)</sup>	Title of Document <sup>(3)</sup>	Code Reference
CCBFC	NRCC 56192	National Fire Code of Canada 2015	1.4.1.2.(1) <sup>(4)</sup> A-1.1.1.1.(1) <sup>(4)</sup> 2.1.1.2.(4) <sup>(4)</sup> A-2.2.1.1.(1) <sup>(4)</sup> A-3.2.1.1.(1) <sup>(4)</sup> 1.1.4.1.(1) 3.1.13.1.(1) 3.2.3.21.(1) 3.2.5.16.(1) 3.3.1.2.(1) 3.3.1.10.(1) 3.3.2.3.(1) 3.3.2.16.(1) 3.3.4.3.(4) 3.3.5.2.(1) 3.3.6.1.(1) 3.3.6.3.(1) 3.3.6.3.(2) 3.3.6.4.(1) 3.3.6.4.(2) 3.3.6.6.(1) 3.7.3.1.(1) A-3.1.2.3.(1) A-3.2.4.6.(2) A-3.2.6. A-3.2.7.8.(3) A-3.3. A-3.3.1.7.(1) A-3.3.3.1.(1) A-3.3.6.1.(1) A-3.9.3.1.(1) 6.3.4.2.(3) 6.3.4.3.(1) 6.3.4.4.(1) 6.9.1.2.(1) 8.1.1.1.(3) 8.1.1.3.(1) 9.10.20.4.(1) 9.10.21.8.(1)
CCBFC	NRCC 56193	National Plumbing Code of Canada 2015	2.1.1.2.(4) <sup>(4)</sup> A-2.2.1.1.(1) <sup>(4)</sup> A-3.2.1.1.(1) <sup>(4)</sup> A-4.1.6.4.(3) 5.6.2.2.(2) 6.3.2.15.(3) 6.3.2.15.(5) 7.1.2.1.(1) 9.31.6.2.(1) 9.36.3.11.(2) 9.36.4.3.(2) A-9.36.5.8.(5) Appendix C

Copyright © NRC 1941 - 2021 World Rights Reserved © CNRC 1941-2021 Droits réservés pour tous pays



**Table 1.3.1.2. (Continued)**

Issuing Agency	Document Number <sup>(2)</sup>	Title of Document <sup>(3)</sup>	Code Reference
CCBFC	NRCC 56194	User's Guide – NBC 2015, Structural Commentaries (Part 4 of Division B)	A-1.1.1.1.(1) <sup>(4)</sup> A-4.1.1.3.(1) A-4.1.1.3.(2) A-4.1.2.1. A-4.1.2.1.(1) A-4.1.3. A-4.1.3.2.(2) A-4.1.3.2.(4) A-4.1.3.2.(5) A-4.1.3.3.(2) A-4.1.3.4.(1) A-4.1.3.5.(1) A-4.1.3.5.(3) A-4.1.3.6.(1) A-4.1.3.6.(2) A-4.1.3.6.(3) A-4.1.5.8. A-4.1.5.17. A-4.1.6.2. A-4.1.6.3.(2) A-4.1.6.4.(1) A-4.1.7.2.(1) and (2) A-4.1.7.3.(5)(c) A-4.1.7.3.(10) A-4.1.7.9.(1) A-4.1.8.2.(1) A-4.1.8.3.(4) A-4.1.8.3.(6) A-4.1.8.3.(7)(b) and (c) A-4.1.8.3.(8) A-4.1.8.4.(3) and Table 4.1.8.4.-A A-Table 4.1.8.5. A-Table 4.1.8.6. A-4.1.8.7.(1) A-4.1.8.9.(4) A-4.1.8.9.(5) A-4.1.8.10.(4) A-4.1.8.10.(5) A-4.1.8.10.(7) A-4.1.8.11.(3) A-4.1.8.12.(1)(a) A-4.1.8.12.(1)(b) A-4.1.8.12.(3) A-4.1.8.12.(4)(a) A-4.1.8.13.(4) A-4.1.8.15.(1) A-4.1.8.15.(3) A-4.1.8.15.(4) A-4.1.8.15.(5) A-4.1.8.15.(6) A-4.1.8.15.(7) A-4.1.8.15.(8) A-4.1.8.16.(1)

Copyright © NRC 1941 - 2021 World Rights Reserved © CNRC 1941-2021 Droits réservés pour tous pays

Table 1.3.1.2. (Continued)

Issuing Agency	Document Number <sup>(2)</sup>	Title of Document <sup>(3)</sup>	Code Reference
CCBFC	NRCC 56194	User's Guide – NBC 2015, Structural Commentaries (Part 4 of Division B) (continued)	A-4.1.8.16.(4) A-4.1.8.16.(6)(a) A-4.1.8.16.(7) A-4.1.8.16.(8)(a) A-4.1.8.16.(10) A-4.1.8.17.(1) A-4.1.8.18. A-4.1.8.18.(14) A-4.1.8.18.(15) and (16)(c) A-4.1.8.19.(3)(a) A-4.1.8.19.(4) A-4.1.8.21.(4)(a) A-4.1.8.21.(5) A-4.2.4.1.(3) A-4.2.4.1.(5) A-4.2.5.1.(1) A-4.2.6.1.(1) A-4.2.7.2.(1) A-4.3.6.1.(1) A-4.4.2.1.(1) A-5.1.4.2. A-5.2.2.2.(4) Appendix C
CGSB	CAN/CGSB-1.501-M89	Method for Permeance of Coated Wallboard	5.5.1.2.(2) 9.25.4.2.(5)
CGSB	CAN/CGSB-7.2-94	Adjustable Steel Columns	9.17.3.4.(1) A-9.17.3.4.
CGSB	CAN/CGSB-10.3-92	Air Setting Refractory Mortar	9.21.3.4.(2) 9.21.3.9.(1) 9.22.2.2.(2)
CGSB	CAN/CGSB-11.3-M87	Hardboard	Table 5.9.1.1. 9.27.9.1.(2) 9.29.7.1.(1) 9.30.2.2.(1)
CGSB	CAN/CGSB-11.5-M87	Hardboard, Precoated, Factory Finished, for Exterior Cladding	Table 5.9.1.1. 9.27.9.1.(1)
CGSB	CAN/CGSB-12.1-M90	Tempered or Laminated Safety Glass	3.3.1.19.(3) 3.4.6.15.(1) 3.4.6.15.(3) Table 5.9.1.1. 9.6.1.2.(1) 9.6.1.4.(1) 9.8.8.7.(1)
CGSB	CAN/CGSB-12.2-M91	Flat, Clear Sheet Glass	Table 5.9.1.1. 9.6.1.2.(1)
CGSB	CAN/CGSB-12.3-M91	Flat, Clear Float Glass	Table 5.9.1.1. 9.6.1.2.(1)
CGSB	CAN/CGSB-12.4-M91	Heat Absorbing Glass	Table 5.9.1.1. 9.6.1.2.(1)
CGSB	CAN/CGSB-12.8-97	Insulating Glass Units	Table 5.9.1.1. 9.6.1.2.(1)
CGSB	CAN/CGSB-12.10-M76	Glass, Light and Heat Reflecting	Table 5.9.1.1. 9.6.1.2.(1)

**Table 1.3.1.2. (Continued)**

Issuing Agency	Document Number <sup>(2)</sup>	Title of Document <sup>(3)</sup>	Code Reference
CGSB	CAN/CGSB-12.11-M90	Wired Safety Glass	3.3.1.19.(3) 3.4.6.15.(1) 3.4.6.15.(3) Table 5.9.1.1. 9.6.1.2.(1) 9.6.1.4.(1) 9.8.8.7.(1)
CGSB	CAN/CGSB-12.20-M89	Structural Design of Glass for Buildings	4.3.6.1.(1) 9.6.1.3.(1) A-9.6.1.3.(2)
CGSB	CAN/CGSB-19.22-M89	Mildew-Resistant Sealing Compound for Tubs and Tiles	9.29.10.5.(1)
CGSB	37-GP-9Ma-1983	Primer, Asphalt, Unfilled, for Asphalt Roofing, Dampproofing and Waterproofing	Table 5.9.1.1. 9.13.3.2.(2) Table 9.26.2.1.-A
CGSB	CAN/CGSB-37.50-M89	Hot-Applied, Rubberized Asphalt for Roofing and Waterproofing	Table 5.9.1.1. 9.13.3.2.(2) Table 9.26.2.1.-B
CGSB	CAN/CGSB-37.51-M90	Application for Hot-Applied Rubberized Asphalt for Roofing and Waterproofing	9.26.15.1.(1)
CGSB	CAN/CGSB-37.54-95	Polyvinyl Chloride Roofing and Waterproofing Membrane	Table 5.9.1.1. 9.13.3.2.(2) Table 9.26.2.1.-B
CGSB	37-GP-55M-1979	Application of Sheet Applied Flexible Polyvinyl Chloride Roofing Membrane	9.26.16.1.(1)
CGSB	37-GP-56M-1985	Membrane, Modified, Bituminous, Prefabricated, and Reinforced for Roofing	Table 5.9.1.1. 9.13.3.2.(2) Table 9.26.2.1.-B
CGSB	CAN/CGSB-37.58-M86	Membrane, Elastomeric, Cold-Applied Liquid, for Non-Exposed Use in Roofing and Waterproofing	Table 5.9.1.1. 9.13.3.2.(2) Table 9.26.2.1.-B
CGSB	CAN/CGSB-41.24-95	Rigid Vinyl Siding, Soffits and Fascia	Table 5.9.1.1. 9.27.12.1.(1)
CGSB	CAN/CGSB-51.25-M87	Thermal Insulation, Phenolic, Faced	Table 9.23.17.2.-A 9.25.2.2.(1)
CGSB	51-GP-27M-1979	Thermal Insulation, Polystyrene, Loose Fill	9.25.2.2.(1)
CGSB	CAN/CGSB-51.32-M77	Sheathing, Membrane, Breather Type	Table 5.9.1.1. 9.20.13.9.(1) Table 9.26.2.1.-A 9.27.3.2.(1)
CGSB	CAN/CGSB-51.33-M89	Vapour Barrier Sheet, Excluding Polyethylene, for Use in Building Construction	Table 5.9.1.1. 9.25.4.2.(4)
CGSB	CAN/CGSB-51.34-M86	Vapour Barrier, Polyethylene Sheet for Use in Building Construction	Table 5.9.1.1. 9.13.2.2.(2) 9.18.6.2.(1) 9.25.3.2.(2) 9.25.3.6.(1) 9.25.4.2.(3)
CGSB	CAN/CGSB-51.71-2005	Depressurization Test	9.32.3.8.(7)
CGSB	CAN/CGSB-71.26-M88	Adhesive for Field-Gluing Plywood to Lumber Framing for Floor Systems	A-9.23.4.2.(2) Table A-9.23.4.2.(2)-C
CGSB	CAN/CGSB-82.6-M86	Doors, Mirrored Glass, Sliding or Folding, Wardrobe	9.6.1.2.(2) A-9.6.1.2.(2)

Copyright © NRC 1941 - 2021 World Rights Reserved © CNRC 1941-2021 Droits réservés pour tous pays

Table 1.3.1.2. (Continued)

Issuing Agency	Document Number <sup>(2)</sup>	Title of Document <sup>(3)</sup>	Code Reference
CGSB	CAN/CGSB-93.1-M85	Sheet, Aluminum Alloy, Prefinished, Residential	Table 5.9.1.1. 9.27.11.1.(4) A-9.27.11.1.(3) and (4)
CGSB	CAN/CGSB-93.2-M91	Prefinished Aluminum Siding, Soffits, and Fascia, for Residential Use	3.2.3.6.(5) Table 5.9.1.1. 9.10.14.5.(8) 9.10.14.5.(12) 9.10.15.5.(7) 9.10.15.5.(11) 9.27.11.1.(3) A-9.27.11.1.(3) and (4)
CGSB	CAN/CGSB-93.3-M91	Prefinished Galvanized and Aluminum-Zinc Alloy Steel Sheet for Residential Use	Table 5.9.1.1. 9.27.11.1.(2)
CGSB	CAN/CGSB-93.4-92	Galvanized Steel and Aluminum-Zinc Alloy Coated Steel Siding, Soffits and Fascia, Prefinished, Residential	Table 5.9.1.1. 9.27.11.1.(1)
CGSB	CAN/CGSB-149.10-M86	Determination of the Airtightness of Building Envelopes by the Fan Depressurization Method	9.36.5.10.(11) A-9.36.5.10.(11)
CISC/ICCA	2013	Crane-Supporting Steel Structures: Design Guide	A-4.1.3.2.(2)
CMHC	1993	Testing of Fresh Air Mixing Devices	A-9.32.3.4.
CMHC	1988	Air Permeance of Building Materials	Table A-9.25.5.1.(1)
CSA	CAN/CSA-6.19-01	Residential Carbon Monoxide Alarming Devices	6.9.3.1.(2) 9.32.3.9.(2) 9.32.3.9.(3)
CSA	A23.1-14	Concrete Materials and Methods of Concrete Construction	4.2.3.6.(1) 4.2.3.9.(1) Table 5.9.1.1. 9.3.1.1.(1) 9.3.1.1.(4) 9.3.1.3.(1) 9.3.1.4.(1)
CSA	A23.3-14	Design of Concrete Structures	Table 4.1.8.9. 4.3.3.1.(1) A-4.1.3.2.(4) A-4.1.8.16.(1) A-4.1.8.16.(4) A-4.3.3.1.(1)
CSA	A23.4-09	Precast Concrete – Materials and Construction	A-4.3.3.1.(1)
CSA	CAN/CSA-A82-14	Fired Masonry Brick Made from Clay or Shale	Table 5.9.1.1. 9.20.2.1.(1)
CSA	CAN/CSA-A82.27-M91	Gypsum Board	3.1.5.14.(6) 3.1.5.15.(4)
CSA	A82.30-M1980	Interior Furring, Lathing and Gypsum Plastering	9.29.4.1.(1)
CSA	A82.31-M1980	Gypsum Board Application	3.2.3.6.(5) 9.10.9.2.(4) 9.10.12.4.(3) 9.10.14.5.(8) 9.10.14.5.(12) 9.10.15.5.(7) 9.10.15.5.(11) 9.29.5.1.(2) Table 9.10.3.1.-A Table 9.10.3.1.-B
CSA	CAN3-A93-M82	Natural Airflow Ventilators for Buildings	Table 5.9.1.1. 9.19.1.2.(5)

**Table 1.3.1.2. (Continued)**

Issuing Agency	Document Number <sup>(2)</sup>	Title of Document <sup>(3)</sup>	Code Reference
CSA	A123.1-05/A123.5-05	Asphalt Shingles Made From Organic Felt and Surfaced with Mineral Granules/Asphalt Shingles Made From Glass Felt and Surfaced with Mineral Granules	Table 5.9.1.1. Table 9.26.2.1.-B
CSA	CAN/CSA-A123.2-03	Asphalt-Coated Roofing Sheets	Table 5.9.1.1. 9.13.3.2.(2) Table 9.26.2.1.-B
CSA	A123.3-05	Asphalt Saturated Organic Roofing Felt	Table 5.9.1.1. Table 9.26.2.1.-B
CSA	CAN/CSA-A123.4-04	Asphalt for Constructing Built-Up Roof Coverings and Waterproofing Systems	Table 5.9.1.1. 9.13.2.2.(2) 9.13.3.2.(2) Table 9.26.2.1.-B
CSA	A123.17-05	Asphalt Glass Felt Used in Roofing and Waterproofing	Table 5.9.1.1. 9.13.3.2.(2) Table 9.26.2.1.-B
CSA	CAN/CSA-A123.21-10	Dynamic Wind Uplift Resistance of Membrane-Roofing Systems	5.2.2.2.(4) A-5.2.2.2.(4)
CSA	A123.22-08	Self-Adhering Polymer Modified Bituminous Sheet Materials Used as Steep Roofing Underlayment for Ice Dam Protection	Table 9.26.2.1.-B
CSA	CAN3-A123.51-M85	Asphalt Shingle Application on Roof Slopes 1:3 and Steeper	Table 5.9.1.1. 9.26.1.3.(1)
CSA	CAN3-A123.52-M85	Asphalt Shingle Application on Roof Slopes 1:6 to Less Than 1:3	Table 5.9.1.1. 9.26.1.3.(1)
CSA	A165.1-14	Concrete Block Masonry Units	Table 5.9.1.1. 9.15.2.2.(1) 9.17.5.1.(1) 9.20.2.1.(1) 9.20.2.6.(1) Table A-9.11.1.4.-A Table A-9.11.1.4.-C
CSA	A165.2-14	Concrete Brick Masonry Units	Table 5.9.1.1. 9.20.2.1.(1)
CSA	A165.3-14	Prefaced Concrete Masonry Units	Table 5.9.1.1. 9.20.2.1.(1)
CSA	A179-14	Mortar and Grout for Unit Masonry	Table 5.9.1.1. 9.15.2.2.(3) 9.20.3.1.(1)
CSA	CAN/CSA-A220 Series-06	Concrete Roof Tiles	Table 5.9.1.1. Table 9.26.2.1.-B 9.26.17.1.(1)
CSA	A277-08	Procedure for Factory Certification of Buildings	A-1.1.1.1.(2) <sup>(4)</sup>
CSA	CAN/CSA-A324-M88	Clay Flue Liners	9.21.3.3.(1)
CSA	A370-14	Connectors for Masonry	A-9.21.4.5.(2)
CSA	A371-14	Masonry Construction for Buildings	Table 5.9.1.1. 9.15.2.2.(3) 9.20.3.2.(7) 9.20.15.2.(1)
CSA	CAN/CSA-A405-M87	Design and Construction of Masonry Chimneys and Fireplaces	9.21.3.5.(1) 9.22.1.4.(1) 9.22.5.2.(2)

Copyright © NRC 1941 - 2021 World Rights Reserved © CNRC 1941-2021 Droits réservés pour tous pays

Table 1.3.1.2. (Continued)

Issuing Agency	Document Number <sup>(2)</sup>	Title of Document <sup>(3)</sup>	Code Reference
CSA	AAMA/WDMA/CSA 101/I.S.2/A440-11	NAFS – North American Fenestration Standard/Specification for Windows, Doors, and Skylights	5.9.2.2.(1) A-5.3.1.2. A-5.9.2.3.(1) A-5.9.3.1.(1) Table 9.7.3.3. 9.7.4.1.(1) 9.7.4.2.(1) 9.7.5.1.(1) 9.7.5.3.(1) 9.36.2.9.(3) A-9.7.4.2.(1)
CSA	A440S1-09	Canadian Supplement to AAMA/WDMA/CSA 101/I.S.2/A440, NAFS – North American Fenestration Standard/Specification for Windows, Doors, and Skylights	5.9.2.2.(1) 5.9.3.5.(3) A-5.9.2.2. A-5.9.3.5.(3) 9.7.4.2.(1) 9.36.2.9.(3) A-9.7.4.2.(1)
CSA	A440.2-14/A440.3-14	Fenestration Energy Performance/User Guide to CSA A440.2-14, Fenestration Energy Performance	Table 9.7.3.3. 9.36.2.2.(3) A-Table 9.36.2.7.-A
CSA	A440.2-14	Fenestration Energy Performance	A-5.3.1.2. A-5.9.3.3.(1) A-9.7.4.2.(1)
CSA	A440.3-14	User Guide to CSA A440.2-14, Fenestration Energy Performance	A-5.3.1.2.
CSA	CAN/CSA-A440.4-07	Window, Door, and Skylight Installation	A-5.9.2.3.(1) 9.7.6.1.(1) A-9.7.4.2.(1)
CSA	A660-10	Certification of Manufacturers of Steel Building Systems	4.3.4.3.(1)
CSA	A3001-13	Cementitious Materials for Use in Concrete	Table 5.9.1.1. 9.3.1.2.(1) 9.28.2.1.(1)
CSA	B51-14	Boiler, Pressure Vessel, and Pressure Piping Code	6.2.1.5.(1) 9.31.6.2.(2) 9.33.5.2.(1)
CSA	B52-13	Mechanical Refrigeration Code	6.2.1.5.(1) 9.33.5.2.(1)
CSA	CAN/CSA-B72-M87	Installation Code for Lightning Protection Systems	3.6.1.3.(1)
CSA	B111-1974	Wire Nails, Spikes and Staples	9.23.3.1.(1) 9.26.2.3.(1) 9.29.5.6.(1) A-Table 9.23.3.5.-B
CSA	B139-09	Installation Code for Oil-Burning Equipment	6.2.1.5.(1) 9.31.6.2.(2) 9.33.5.2.(1)
CSA	B140.12-03	Oil-Burning Equipment: Service Water Heaters for Domestic Hot Water, Space Heating, and Swimming Pools	Table 9.36.4.2.
CSA	B149.1-10	Natural Gas and Propane Installation Code	6.2.1.5.(1) 9.10.22.1.(1) 9.31.6.2.(2) 9.33.5.2.(1) A-9.10.22.
CSA	CAN/CSA-B182.1-11	Plastic Drain and Sewer Pipe and Pipe Fittings	Table 5.9.1.1. 9.14.3.1.(1)
CSA	CAN/CSA-B211-00	Energy Efficiency of Oil-Fired Storage Tank Water Heaters	Table 9.36.4.2.

**Table 1.3.1.2. (Continued)**

Issuing Agency	Document Number <sup>(2)</sup>	Title of Document <sup>(3)</sup>	Code Reference
CSA	B212-00	Energy Utilization Efficiencies of Oil-Fired Furnaces and Boilers	Table 9.36.3.10.
CSA	B214-12	Installation Code for Hydronic Heating Systems	6.2.1.1.(1) 9.33.4.2.(1) A-9.36.3.4.(1)
CSA	B355-09	Lifts for Persons with Physical Disabilities	3.8.3.7.(1)
CSA	B365-10	Installation Code for Solid-Fuel-Burning Appliances and Equipment	6.2.1.5.(1) 9.22.10.2.(1) 9.31.6.2.(2) 9.33.5.3.(1) A-9.33.1.1.(2) A-9.33.5.3.
CSA	B415.1-10	Solid-Fuel-Burning Heating Appliances	Table 9.36.3.10.
CSA	B651-12	Accessible Design for the Built Environment	3.8.3.1.(1) Table 3.8.3.1. A-3.8.3.1.(1)
CSA	C22.1-12	Canadian Electrical Code, Part I	3.3.6.2.(4) 3.6.1.2.(1) 3.6.2.1.(6) 3.6.2.7.(1) A-3.1.4.3.(1)(b)(i) A-3.2.4.20.(7)(a) A-3.3.6.2.(4) 6.2.1.5.(1) 9.31.6.2.(2) 9.33.5.2.(1) 9.34.1.1.(1) A-9.10.22. A-9.34.2. A-9.35.2.2.(1)
CSA	C22.2 No. 0.3-09	Test Methods for Electrical Wires and Cables	3.1.4.3.(1) 3.1.4.3.(3) 3.1.5.21.(1) 3.1.5.21.(3) 9.34.1.5.(1)
CSA	C22.2 No. 113-10	Fans and Ventilators	9.32.3.10.(7)
CSA	C22.2 No. 141-10	Emergency Lighting Equipment	3.2.7.4.(2) 3.4.5.1.(3) 9.9.11.3.(3) 9.9.12.3.(7)
CSA	CAN/CSA-C22.2 No. 150-M89	Microwave Ovens	A-9.10.22.
CSA	C22.2 No. 211.0-03	General Requirements and Methods of Testing for Nonmetallic Conduit	3.1.5.23.(1)
CSA	CAN/CSA-C22.2 No. 262-04	Optical Fiber Cable and Communication Cable Raceway Systems	3.1.5.23.(1)
CSA	CAN/CSA-C191-04	Performance of Electric Storage Tank Water Heaters for Domestic Hot Water Service	Table 9.36.4.2.
CSA	CAN/CSA-C260-M90	Rating the Performance of Residential Mechanical Ventilating Equipment	9.32.3.10.(1) 9.32.3.10.(2) Table 9.32.3.10.-B
CSA	C282-09	Emergency Electrical Power Supply for Buildings	3.2.7.5.(1)
CSA	C368.1-14	Energy Performance of Room Air Conditioners	Table 9.36.3.10.
CSA	CAN/CSA-C439-09	Rating the Performance of Heat/Energy-Recovery Ventilators	9.32.3.10.(4) 9.32.3.10.(5) 9.36.3.8.(4) 9.36.3.9.(3) A-9.36.3.9.(3)

Copyright © NRC 1941 - 2021 World Rights Reserved © CNRC 1941-2021 Droits réservés pour tous pays

Table 1.3.1.2. (Continued)

Issuing Agency	Document Number <sup>(2)</sup>	Title of Document <sup>(3)</sup>	Code Reference
CSA	C448 Series-13	Design and Installation of Earth Energy Systems	9.33.5.2.(1)
CSA	C656-14	Split-System and Single-Package Air Conditioners and Heat Pumps	Table 9.36.3.10.
CSA	CAN/CSA-C745-03	Energy Efficiency of Electric Storage Tank Water Heaters and Heat Pump Water Heaters	Table 9.36.4.2.
CSA	CAN/CSA-C746-06	Rating Large and Single Packaged Vertical Air Conditioners and Heat Pumps	Table 9.36.3.10.
CSA	C748-13	Direct-Expansion (DX) Ground-Source Heat Pumps	Table 9.36.3.10.
CSA	CAN/CSA-C749-07	Performance of Dehumidifiers	Table 9.36.3.10.
CSA	C828-13	Thermostats Used with Individual Room Electric Space Heating Devices	9.36.3.6.(3)
CSA	CAN/CSA-C13256-1-01	Water-Source Heat Pumps - Testing and Rating for Performance - Part 1: Water-to-Air and Brine-to-Air Heat Pumps (Adopted ISO 13256-1:1998, with Canadian Deviations)	Table 9.36.3.10.
CSA	CAN/CSA-C13256-2-01	Water-Source Heat Pumps - Testing and Rating for Performance - Part 2: Water-to-Water and Brine-to-Water Heat Pumps (Adopted ISO 13256-2:1998, with Canadian Deviations)	Table 9.36.3.10.
CSA	F280-12	Determining the Required Capacity of Residential Space Heating and Cooling Appliances	9.33.5.1.(1) A-9.36.3.2.(1) A-9.36.5.15.(5)
CSA	CAN/CSA-F326-M91	Residential Mechanical Ventilation Systems	9.32.3.1.(1) A-9.32.3.1.(1) A-9.32.3.5. A-9.32.3.7. A-9.32.3.8. A-9.33.6.13.
CSA	G30.18-09	Carbon Steel Bars for Concrete Reinforcement	9.3.1.1.(4)
CSA	G40.21-13	Structural Quality Steel	4.2.3.8.(1) Table 5.9.1.1. 9.23.4.3.(2)
CSA	G401-14	Corrugated Steel Pipe Products	Table 5.9.1.1. 9.14.3.1.(1)
CSA	CAN/CSA-O80 Series-08	Wood Preservation	3.1.4.5.(1) 4.2.3.2.(1) 4.2.3.2.(2) Table 5.9.1.1.
CSA	CAN/CSA-O80.1-08	Specification of Treated Wood	9.3.2.9.(5)
CSA	CAN/CSA-O80.2-08	Processing and Treatment	4.2.3.2.(1)
CSA	CAN/CSA-O80.3-08	Preservative Formulations	4.2.3.2.(1)
CSA	O80.15-97	Preservative Treatment of Wood for Building Foundation Systems, Basements, and Crawl Spaces by Pressure Processes	4.2.3.2.(1)
CSA	O86-14	Engineering Design in Wood	Table 4.1.8.9. 4.3.1.1.(1) A-5.1.4.1.(6)(b) and (c) A-9.15.2.4.(1) A-9.23.4.2.
CSA	O112.9-10	Evaluation of Adhesives for Structural Wood Products (Exterior Exposure)	Table 9.10.3.1.-B
CSA	O112.10-08	Evaluation of Adhesives for Structural Wood Products (Limited Moisture Exposure)	Table 9.10.3.1.-B
CSA	O118.1-08	Western Red Cedar Shakes and Shingles	Table 5.9.1.1. Table 9.26.2.1.-B 9.27.7.1.(1)



**Table 1.3.1.2. (Continued)**

Issuing Agency	Document Number <sup>(2)</sup>	Title of Document <sup>(3)</sup>	Code Reference
CSA	O118.2-08	Eastern White Cedar Shingles	Table 5.9.1.1. Table 9.26.2.1.-B 9.27.7.1.(1)
CSA	O121-08	Douglas Fir Plywood	Table 5.9.1.1. 9.23.15.2.(1) 9.23.16.2.(1) Table 9.23.17.2.-A 9.27.8.1.(1) 9.30.2.2.(1) Span Table 9.23.12.3.-A Span Table 9.23.12.3.-C
CSA	CAN/CSA-O122-06	Structural Glued-Laminated Timber	Span Table 9.23.4.2.-K Span Table 9.23.12.3.-D
CSA	CAN/CSA-O132.2 Series-90	Wood Flush Doors	9.7.4.3.(4)
CSA	O141-05	Softwood Lumber	Table 5.9.1.1. 9.3.2.6.(1) A-9.3.2.1.(1)
CSA	O151-09	Canadian Softwood Plywood	Table 5.9.1.1. 9.23.15.2.(1) 9.23.16.2.(1) Table 9.23.17.2.-A 9.27.8.1.(1) 9.30.2.2.(1) Span Table 9.23.12.3.-A Span Table 9.23.12.3.-C
CSA	O153-13	Poplar Plywood	Table 5.9.1.1. 9.23.15.2.(1) 9.23.16.2.(1) Table 9.23.17.2.-A 9.27.8.1.(1) 9.30.2.2.(1)
CSA	O177-06	Qualification Code for Manufacturers of Structural Glued-Laminated Timber	4.3.1.2.(1) Span Table 9.23.4.2.-K Span Table 9.23.12.3.-D
CSA	O325-07	Construction Sheathing	Table 5.9.1.1. Table 9.23.13.6. 9.23.15.2.(1) 9.23.15.4.(2) 9.23.16.2.(1) 9.23.16.3.(2) 9.29.9.1.(2) 9.29.9.2.(5) Span Table 9.23.12.3.-A Span Table 9.23.12.3.-C
CSA	O437.0-93	OSB and Waferboard	Table 5.9.1.1. 9.23.15.2.(1) 9.23.15.4.(2) 9.23.16.2.(1) 9.23.16.3.(2) Table 9.23.17.2.-A 9.27.10.1.(1) 9.29.9.1.(2) 9.30.2.2.(1) A-9.23.15.4.(2) Span Table 9.23.12.3.-A Span Table 9.23.12.3.-C

Copyright © NRC 1941 - 2021 World Rights Reserved © CNRC 1941-2021 Droits réservés pour tous pays

Table 1.3.1.2. (Continued)

Issuing Agency	Document Number <sup>(2)</sup>	Title of Document <sup>(3)</sup>	Code Reference
CSA	P2-13	Measuring the Annual Fuel Utilization Efficiency of Residential Gas-Fired or Oil-Fired Furnaces and Boilers	Table 9.36.3.10.
CSA	CAN/CSA-P3-04	Measuring Energy Consumption and Determining Efficiencies of Gas-Fired Storage Water Heaters	Table 9.36.4.2.
CSA	P6-09	Measuring Thermal Efficiency of Gas-Fired Pool Heaters	Table 9.36.4.2.
CSA	CAN/CSA-P7-10	Measuring Energy Loss of Gas-Fired Instantaneous Water Heaters	Table 9.36.4.2.
CSA	CAN/CSA-P8-09	Thermal Efficiencies of Industrial and Commercial Gas-Fired Package Furnaces	Table 9.36.3.10.
CSA	CAN/CSA-P9-11	Performance of Combined Space and Water Heating Systems (Combos)	9.36.3.10.(3) Table 9.36.3.10. Table 9.36.4.2. Table 9.36.5.15.-C
CSA	P.10-07	Performance of Integrated Mechanical Systems for Residential Heating and Ventilation	9.36.3.9.(2) Table 9.36.3.10. Table 9.36.4.2. Table 9.36.5.15.-C
CSA	CAN/CSA-P11-07	Measuring Efficiency and Energy Consumption of Gas-Fired Unit Heaters	Table 9.36.3.10.
CSA	S6-14	Canadian Highway Bridge Design Code	A-Table 4.1.5.3. A-Table 4.1.5.9.
CSA	S16-14	Design of Steel Structures	Table 4.1.8.9. 4.3.4.1.(1) A-4.1.5.11. A-Table 4.1.8.9. A-4.3.4.1.(1)
CSA	S37-13	Antennas, Towers, and Antenna-Supporting Structures	4.1.6.15.(1) 4.1.7.11.(1)
CSA	S136-12	North American Specification for the Design of Cold-Formed Steel Structural Members (using the Appendix B provisions applicable to Canada)	4.1.8.1.(5) Table 4.1.8.9. 4.3.4.2.(1)
CSA	CAN/CSA-S157-05/S157.1-05	Strength Design in Aluminum/Commentary on CSA S157-05, Strength Design in Aluminum	4.3.5.1.(1)
CSA	S269.1-1975	Falsework for Construction Purposes	4.1.1.3.(4)
CSA	CAN/CSA-S269.2-M87	Access Scaffolding for Construction Purposes	4.1.1.3.(4)
CSA	CAN/CSA-S269.3-M92	Concrete Formwork	4.1.1.3.(4)
CSA	S304-14 <sup>(6)</sup>	Design of Masonry Structures	Table 4.1.8.9. 4.3.2.1.(1) A-5.1.4.1.(6)(b) and (c)
CSA	S307-M1980	Load Test Procedure for Wood Roof Trusses for Houses and Small Buildings	9.23.14.11.(5)
CSA	S367-12	Air-, Cable-, and Frame-Supported Membrane Structures	4.4.1.1.(1)
CSA	S406-14	Permanent Wood Foundations for Housing and Small Buildings	9.15.2.4.(1) 9.16.5.1.(1) A-9.15.2.4.(1)
CSA	S413-14	Parking Structures	4.4.2.1.(1)
CSA	S478-95	Guideline on Durability in Buildings	A-5.1.4.2.
CSA	CAN/CSA-S832-06	Seismic Risk Reduction of Operational and Functional Components (OFCs) of Buildings	A-Table 4.1.8.18.
CSA	Z32-09	Electrical Safety and Essential Electrical Systems in Health Care Facilities	3.2.7.3.(4) 3.2.7.6.(1) A-3.2.7.6.(1)
CSA	Z240 MH Series-09	Manufactured Homes	A-1.1.1.1.(2) <sup>(4)</sup>

**Table 1.3.1.2. (Continued)**

Issuing Agency	Document Number <sup>(2)</sup>	Title of Document <sup>(3)</sup>	Code Reference
CSA	Z240.2.1-09	Structural Requirements for Manufactured Homes	A-1.1.1.1.(2) <sup>(4)</sup> 9.12.2.2.(6) 9.15.1.3.(1)
CSA	Z240.10.1-08	Site Preparation, Foundation, and Anchorage of Manufactured Homes	A-1.1.1.1.(2) <sup>(4)</sup> 9.15.1.3.(1) 9.23.6.3.(1)
CSA	CAN/CSA-Z317.2-10	Special Requirements for Heating, Ventilation, and Air-Conditioning (HVAC) Systems in Health Care Facilities	6.2.1.1.(1) 6.3.2.15.(1)
CSA	Z662-11 Package	Oil and Gas Pipeline Systems/CSA Z662-11, Commentary on Oil and Gas Pipeline Systems	3.2.3.22.(1)
CSA	Z7396.1-12	Medical Gas Pipeline Systems – Part 1: Pipelines for Medical Gases, Medical Vacuum, Medical Support Gases, and Anaesthetic Gas Scavenging Systems	3.7.3.1.(1)
CTI	STD-201RS-04	Certification of Water-Cooling Tower Thermal Performance	Table 9.36.3.10.
CWC	BPS No. 1-2000	Moisture and Wood-Frame Buildings	A-5.6.2.1.
CWC	1997	Introduction to Wood Building Technology	A-9.27.3.8.(4)
CWC	2000	Wood Reference Handbook	A-9.27.3.8.(4)
CWC	2009	The Span Book	A-9.23.4.2.
CWC	2014	Engineering Guide for Wood Frame Construction	9.4.1.1.(1) 9.23.13.1.(2) 9.23.13.2.(2) 9.23.13.3.(2) A-9.4.1.1. A-9.23.13.1.
DOE	10 CFR, Part 430-2011	Energy, Energy Conservation Program for Consumer Products	Table 9.36.4.2.
DOE	10 CFR, Part 431-2011	Energy, Energy Efficiency Program for Certain Commercial and Industrial Equipment	Table 9.36.4.2.
ECC	2013	EIFS Practice Manual	A-5.9.4.1.(1) A-9.27.13.1.(1)
EPA	40 CFR, Part 60-2008	Protection of Environment, Standards of Performance for New Stationary Sources	Table 9.36.3.10.
EPA	625/R-92/016 (1994)	Radon Prevention in the Design and Construction of Schools and Other Large Buildings	A-5.4.1.1. 6.2.1.1.(1)
FEMA	450-1-2003	NEHRP Recommended Provisions for Seismic Regulations for New Buildings and Other Structures	A-4.1.8.18.(15) and (16)(c)
FEMA	P-750-2009	NEHRP Recommended Seismic Provisions for New Buildings and Other Structures	A-4.1.8.18.(15) and (16)(c)
FLL	2008	Guidelines for the Planning, Construction and Maintenance of Green Roofing	A-5.6.1.2.(2)
FPI	Project 43-10C-024 (1988)	Deflection Serviceability Criteria for Residential Floors	A-9.23.4.2.(2)
FPI/RDH	SP-53-2013	Guide for Designing Energy-Efficient Building Enclosures for Wood-Frame Multi-Unit Residential Buildings in Marine to Cold Climate Zones in North America	A-5.6.2.1.
HC	H46-2/90-156E	Exposure Guidelines for Residential Indoor Air Quality	A-6.3.1.6. A-9.25.5.2.
HC	2007	Radon: A Guide for Canadian Homeowners	A-5.4.1.1. A-6.2.1.1. A-9.13.4.3.
HC	R.S.C., 1985, c. H-3	Hazardous Products Act	A-1.4.1.2.(1) <sup>(4)</sup> A-9.25.2.2.(2)

Table 1.3.1.2. (Continued)

Issuing Agency	Document Number <sup>(2)</sup>	Title of Document <sup>(3)</sup>	Code Reference
HC	Hazardous Products Act, Part II	Workplace Hazardous Materials Information System (WHMIS)	A-1.4.1.2.(1) <sup>(4)</sup> A-3.3.1.2.(1)
HC	SOR/2015-17	Hazardous Products Regulations	1.4.1.2.(1) <sup>(4)</sup> A-3.3.1.2.(1)
HC	2004	Fungal Contamination in Public Buildings: Health Effects and Investigation Methods	A-5.5.1.1.
HC	2008	Guide for Radon Measurements in Public Buildings (Schools, Hospitals, Care Facilities, Detention Centres)	A-5.4.1.1. A-6.2.1.1.
HC	2008	Guide for Radon Measurements in Residential Dwellings (Homes)	A-9.13.4.3.
HPVA	ANSI/HPVA HP-1-2009	Hardwood and Decorative Plywood	Table 5.9.1.1. 9.27.8.1.(1) 9.30.2.2.(1)
HRAI	SAR-G1	HRAI Digest 2005	6.2.1.1.(1) 9.32.2.3.(4) 9.32.3.2.(1) 9.33.4.1.(1) A-9.36.3.2.(1) A-9.36.3.2.(2) A-9.36.3.4.(1)
HVI	HVI Publication 911	Certified Home Ventilating Products Directory	A-9.36.3.9.(3)
HVI	HVI Publication 915-2013	Loudness Testing and Rating Procedure	9.32.3.10.(2) Table 9.32.3.10.-B
HVI	HVI Publication 916-2013	Airflow Test Procedure	9.32.3.10.(1)
ICC	400-2012	Design and Construction of Log Structures	9.36.2.2.(5) A-9.36.2.2.(5)
IEC	60268-16:2011	Sound System Equipment – Part 16: Objective Rating of Speech Intelligibility by Speech Transmission Index	A-3.2.4.22.(1)(b)
ISO	3864-1:2011	Graphical symbols – Safety colours and safety signs – Part 1: Design principles for safety signs and safety markings	3.4.5.1.(2) 9.9.11.3.(2)
ISO	7010:2011	Graphical symbols – Safety colours and safety signs – Registered safety signs	3.4.5.1.(2) A-3.4.5.1.(2)(c) 9.9.11.3.(2)
ISO	7240-19:2007	Fire Detection and Alarm Systems – Part 19: Design, Installation, Commissioning and Service of Sound Systems for Emergency Purposes	A-3.2.4.22.(1)(b)
ISO	7731:2003(E)	Ergonomics – Danger signals for public and work areas – Auditory danger signals	A-3.2.4.22.(1)(b)
ISO	8201:1987(E)	Acoustics – Audible emergency evacuation signal	3.2.4.18.(2) A-3.2.4.18.(2)
ISO	10848:2006	Acoustics - Laboratory Measurement of the Flanking Transmission of Airborne and Impact Sound Between Adjoining Rooms	5.8.1.4.(2) 5.8.1.4.(3) 5.8.1.5.(2) 5.8.1.5.(3)
ISO	15712-1:2005	Building Acoustics - Estimation of Acoustic Performance of Buildings From the Performance of Elements - Part 1: Airborne Sound Insulation Between Rooms	5.8.1.4.(1) 5.8.1.4.(2) 5.8.1.4.(4) 5.8.1.4.(5) 5.8.1.4.(6) 5.8.1.5.(1) 5.8.1.5.(2) 5.8.1.5.(5) 5.8.1.5.(6)
NEMA	SB 50-2008	Emergency Communications Audio Intelligibility Applications Guide	A-3.2.4.22.(1)(b)
NFPA	2010 Edition	Fire Protection Guide to Hazardous Materials	A-6.9.1.2.(1)

**Table 1.3.1.2. (Continued)**

Issuing Agency	Document Number <sup>(2)</sup>	Title of Document <sup>(3)</sup>	Code Reference
NFPA	2008	Fire Protection Handbook, Twentieth Edition	A-3.2.2.2.(1) A-3.6.2.7.(5)
NFPA	13-2013	Installation of Sprinkler Systems	3.1.9.1.(4) 3.2.4.8.(2) 3.2.4.15.(1) 3.2.5.12.(1) 3.3.2.14.(3) A-3.1.11.5.(3) A-3.2.4.9.(3)(f) A-3.2.5.12.(1) A-3.2.5.12.(6) A-3.2.5.13.(1) A-3.2.8.2.(3) 9.10.9.6.(11)
NFPA	13D-2013	Installation of Sprinkler Systems in One- and Two-Family Dwellings and Manufactured Homes	3.2.4.1.(2) 3.2.5.12.(3) A-3.2.5.12.(2) A-3.2.5.12.(6) A-3.2.5.13.(1) 9.10.18.2.(3)
NFPA	13R-2013	Installation of Sprinkler Systems in Low-Rise Residential Occupancies	3.2.5.12.(2) A-3.2.5.12.(2) A-3.2.5.12.(6) A-3.2.5.13.(1)
NFPA	14-2013	Installation of Standpipe and Hose Systems	3.2.5.9.(1) 3.2.5.10.(1)
NFPA	20-2013	Installation of Stationary Pumps for Fire Protection	3.2.4.9.(4) 3.2.5.18.(1) A-3.2.4.9.(3)(f)
NFPA	30-2012	Flammable and Combustible Liquids Code	A-6.9.1.2.(1)
NFPA	30A-2012	Motor Fuel Dispensing Facilities and Repair Garages	A-6.9.1.2.(1)
NFPA	32-2011	Drycleaning Plants	A-6.9.1.2.(1)
NFPA	33-2011	Spray Application Using Flammable or Combustible Materials	A-6.9.1.2.(1)
NFPA	34-2011	Dipping, Coating, and Printing Processes Using Flammable or Combustible Liquids	A-6.9.1.2.(1)
NFPA	35-2011	Manufacture of Organic Coatings	A-6.9.1.2.(1)
NFPA	36-2013	Solvent Extraction Plants	A-6.9.1.2.(1)
NFPA	40-2011	Storage and Handling of Cellulose Nitrate Film	A-6.9.1.2.(1)
NFPA	51-2013	Design and Installation of Oxygen-Fuel Gas Systems for Welding, Cutting, and Allied Processes	A-6.9.1.2.(1)
NFPA	51A-2012	Acetylene Cylinder Charging Plants	A-6.9.1.2.(1)
NFPA	55-2013	Compressed Gases and Cryogenic Fluids Code	A-6.9.1.2.(1)
NFPA	61-2013	Prevention of Fires and Dust Explosions in Agricultural and Food Processing Facilities	A-6.9.1.2.(1)
NFPA	68-2013	Explosion Protection by Deflagration Venting	3.3.6.4.(2) A-3.6.2.7.(5) A-6.9.1.2.(1)
NFPA	69-2014	Explosion Prevention Systems	A-3.6.2.7.(5) A-6.9.1.2.(1)
NFPA	72-2013	National Fire Alarm and Signaling Code	A-3.2.4.22.(1)(b)

Copyright © NRC 1941 - 2021 World Rights Reserved © CNRC 1941-2021 Droits réservés pour tous pays

Table 1.3.1.2. (Continued)

Issuing Agency	Document Number <sup>(2)</sup>	Title of Document <sup>(3)</sup>	Code Reference
NFPA	80-2013	Fire Doors and Other Opening Protectives	3.1.8.5.(2) 3.1.8.12.(2) 3.1.8.16.(1) 3.1.9.1.(5) A-3.1.8.1.(2) A-3.2.8.2.(3) 9.10.9.6.(13) 9.10.13.1.(1)
NFPA	80A-2012	Protection of Buildings from Exterior Fire Exposures	A-3
NFPA	82-2014	Incinerators and Waste and Linen Handling Systems and Equipment	6.2.2.1.(1) 9.10.10.5.(2)
NFPA	85-2011	Boiler and Combustion Systems Hazards Code	A-6.9.1.2.(1)
NFPA	86-2011	Ovens and Furnaces	A-6.9.1.2.(1)
NFPA	88A-2011	Parking Structures	A-6.9.1.2.(1)
NFPA	91-2010	Exhaust Systems for Air Conveying of Vapors, Gases, Mists, and Noncombustible Particulate Solids	6.3.4.3.(1) A-6.9.1.2.(1)
NFPA	96-2014	Ventilation Control and Fire Protection of Commercial Cooking Operations	3.2.4.8.(2) 3.6.3.5.(1) A-3.3.1.2.(2) A-3.6.3.5. 6.3.1.7.(1) A-6.9.1.2.(1) A-9.10.1.4.(1)
NFPA	101-2012	Life Safety Code	3.3.2.1.(2) 3.3.2.1.(3) A-3.3.2.1.(2)
NFPA	105-2013	Smoke Door Assemblies and Other Opening Protectives	3.1.8.5.(3) 3.1.8.5.(7)
NFPA	204-2012	Smoke and Heat Venting	A-6.9.1.2.(1)
NFPA	211-2013	Chimneys, Fireplaces, Vents, and Solid Fuel-Burning Appliances	6.3.3.2.(2) 6.3.3.3.(1)
NFPA	303-2011	Marinas and Boatyards	A-6.9.1.2.(1)
NFPA	307-2011	Construction and Fire Protection of Marine Terminals, Piers, and Wharves	A-6.9.1.2.(1)
NFPA	409-2011	Aircraft Hangars	A-6.9.1.2.(1)
NFPA	415-2013	Airport Terminal Buildings, Fueling Ramp Drainage, and Loading Walkways	A-6.9.1.2.(1)
NFPA	484-2012	Combustible Metals	A-6.9.1.2.(1)
NFPA	654-2013	Prevention of Fire and Dust Explosions from the Manufacturing, Processing, and Handling of Combustible Particulate Solids	A-6.9.1.2.(1)
NFPA	655-2012	Prevention of Sulfur Fires and Explosions	A-6.9.1.2.(1)
NFPA	664-2012	Prevention of Fires and Explosions in Wood Processing and Woodworking Facilities	A-6.9.1.2.(1)
NFPA	1710-2010	Organization and Deployment of Fire Suppression Operations, Emergency Medical Operations, and Special Operations to the Public by Career Fire Departments	A-3.2.3.1.(8)
NFRC	100-2010	Determining Fenestration Product U-factors	9.36.2.2.(3)
NFRC	200-2010	Determining Fenestration Product Solar Heat Gain Coefficient and Visible Transmittance at Normal Incidence	9.36.2.2.(3)

**Table 1.3.1.2. (Continued)**

Issuing Agency	Document Number <sup>(2)</sup>	Title of Document <sup>(3)</sup>	Code Reference
NLGA	2014	Standard Grading Rules for Canadian Lumber	9.3.2.1.(1) A-9.3.2.1.(1) Table A-9.3.2.1.(1)-A A-Table 9.3.2.1. A-9.3.2.8.(1) A-9.23.10.4.(1)
NLGA	SPS-1-2013	Fingerjoined Structural Lumber	Table 9.10.3.1.-A A-9.23.10.4.(1)
NLGA	SPS-3-2013	Fingerjoined "Vertical Stud Use Only" Lumber	Table 9.10.3.1.-A A-9.23.10.4.(1)
NRC-IRC	CBD 222	Airtight Houses and Carbon Monoxide Poisoning	A-9.33.1.1.(2)
NRC-IRC	CBD 230	Applying Building Codes to Existing Buildings	A-1.1.1.1.(1) <sup>(4)</sup>
NRC-IRC	CBD 231	Moisture Problems in Houses	A-9.25.3.1.(1)
NRC-IRC	1988	Performance and Acceptability of Wood Floors – Forintek Studies	A-9.23.4.2.(2)
NRCA	2005	The NRCA Waterproofing Manual	A-5.6.2.1.
NRCA	2011	The NRCA Roofing Manual: Membrane Roof Systems	A-5.6.2.1.
NRCA	2nd Edition, 2009	Vegetative Roof Systems Manual	A-5.6.1.2.(2)
NRCan	R.S.C., 1985, c. E-17	Explosives Act	3.3.6.2.(3)
NRC Const.	2005	A Guide for the Wind Design of Mechanically Attached Flexible Membrane Roofs	A-5.2.2.2.(4)
NRC Const.	RR-331-2013	Guide to Calculating Airborne Sound Transmission in Buildings	A-5.8.1.4.
NYCDH	2008	Guidelines on Assessment and Remediation of Fungi in Indoor Environments	A-5.5.1.1.
OMMAH	2012	2012 Building Code Compendium, Volume 2, Supplementary Standard SB-7, Guards for Housing and Small Buildings	A-9.8.8.2.
SMACNA	ANSI/SMACNA 006-2006	HVAC Duct Construction Standards – Metal and Flexible	9.33.6.5.(2) A-9.36.3.2.(2)
SMACNA	2012	Architectural Sheet Metal Manual, Seventh Edition	A-5.6.2.1.
SPRI	ANSI/GRHC/SPRI VR-1-2011	Investigating Resistance to Root Penetration on Vegetative Roofs	5.6.1.2.(2)
SPRI	ANSI/SPRI WD-1-2008	Wind Design Standard Practice for Roofing Assemblies	A-5.2.2.2.(4)
TC	SOR/96-433	Canadian Aviation Regulations – Part III	4.1.5.13.(1)
TC	SOR/2008-34	Transportation of Dangerous Goods Regulations (TDGR)	1.4.1.2.(1) <sup>(4)</sup> A-1.4.1.2.(1) <sup>(4)</sup> A-3.3.1.2.(1)
TIAC	2013	Mechanical Insulation Best Practices Guide	A-6.3.2.5.
TPIC	2014	Truss Design Procedures and Specifications for Light Metal Plate Connected Wood Trusses (Limit States Design)	9.23.14.11.(6)
TWC	1993	Details of Air Barrier Systems for Houses	Table A-9.25.5.1.(1)
TWC	1995	High-Rise Residential Construction Guide	A-5.6.2.1.
UL	ANSI/UL 300-2005	Fire Testing of Fire Extinguishing Systems for Protection of Commercial Cooking Equipment	6.9.1.3.(1)
UL	731-1995	Oil-Fired Unit Heaters	Table 9.36.3.10.
UL	ANSI/UL-1784-04	Air Leakage Tests of Door Assemblies and Other Opening Protectives	3.1.8.4.(4)

Table 1.3.1.2. (Continued)

Issuing Agency	Document Number <sup>(2)</sup>	Title of Document <sup>(3)</sup>	Code Reference
ULC	CAN/ULC-S101-14	Fire Endurance Tests of Building Construction and Materials	3.1.5.7.(2) 3.1.5.14.(5) 3.1.5.14.(6) 3.1.5.15.(3) 3.1.5.15.(4) 3.1.7.1.(1) 3.1.11.7.(1) 3.2.3.8.(1) 3.2.6.5.(6) A-3.1.5.14.(5)(d) A-3.2.6.5.(6)(b) 9.10.16.3.(1) Table 9.10.3.1.-B
ULC	CAN/ULC-S102-10	Test for Surface Burning Characteristics of Building Materials and Assemblies	3.1.5.24.(1) 3.1.12.1.(1) Table 9.23.17.2.-A 9.29.5.2.(1)
ULC	CAN/ULC-S102.2-10	Test for Surface Burning Characteristics of Flooring, Floor Coverings, and Miscellaneous Materials and Assemblies	3.1.12.1.(2) 3.1.13.4.(1)
ULC	CAN/ULC-S102.3-07	Fire Test of Light Diffusers and Lenses	3.1.13.4.(1)
ULC	CAN/ULC-S102.4-10	Test for Fire and Smoke Characteristics of Electrical Wiring, Cables and Non-Metallic Raceways	3.1.4.3.(2) 3.1.5.21.(2) 3.1.5.23.(2)
ULC	CAN/ULC-S104-10	Fire Tests of Door Assemblies	3.1.8.4.(1) 3.2.6.5.(3)
ULC	CAN/ULC-S105-09	Fire Door Frames Meeting the Performance Required by CAN/ULC-S104	9.10.13.6.(1)
ULC	CAN4-S106-M80	Fire Tests of Window and Glass Block Assemblies	3.1.8.4.(1)
ULC	CAN/ULC-S107-10	Fire Tests of Roof Coverings	3.1.15.1.(1)
ULC	CAN/ULC-S109-03	Flame Tests of Flame-Resistant Fabrics and Films	3.1.6.5.(1) 3.1.16.1.(1) 3.6.5.2.(2) 3.6.5.3.(1) 9.33.6.3.(1)
ULC	CAN/ULC-S110-13	Test for Air Ducts	3.6.5.1.(2) 3.6.5.1.(5) 9.33.6.2.(2) 9.33.6.2.(4)
ULC	CAN/ULC-S111-13	Fire Tests for Air Filter Units	6.3.2.13.(1) 9.33.6.14.(1)
ULC	CAN/ULC-S112-10	Fire Test of Fire Damper Assemblies	3.1.8.4.(1) A-3.2.6.6.(1)
ULC	CAN/ULC-S112.1-10	Leakage Rated Dampers for Use in Smoke Control Systems	3.1.8.4.(3) 6.3.2.7.(3)
ULC	CAN/ULC-S112.2-07	Fire Test of Ceiling Firestop Flap Assemblies	3.6.4.3.(2) 9.10.13.14.(1)
ULC	CAN/ULC-S113-07	Wood Core Doors Meeting the Performance Required by CAN/ULC-S104 for Twenty Minute Fire Rated Closure Assemblies	9.10.13.2.(1) A-9.10.9.3.(2) A-9.10.13.2.(1)
ULC	CAN/ULC-S114-05	Test for Determination of Non-Combustibility in Building Materials	1.4.1.2.(1) <sup>(4)</sup>



**Table 1.3.1.2. (Continued)**

Issuing Agency	Document Number <sup>(2)</sup>	Title of Document <sup>(3)</sup>	Code Reference
ULC	CAN/ULC-S115-11	Fire Tests of Firestop Systems	3.1.5.19.(3) 3.1.9.1.(1) 3.1.9.1.(2) 3.1.9.1.(3) 3.1.9.4.(1) 3.1.9.5.(4) 9.10.9.6.(2) 9.10.9.7.(3)
ULC	CAN/ULC-S124-06	Test for the Evaluation of Protective Coverings for Foamed Plastic	3.1.5.15.(2) A-3.1.5.14.(5)(d)
ULC	CAN/ULC-S126-06	Test for Fire Spread Under Roof-Deck Assemblies	3.1.14.1.(1) 3.1.14.2.(1)
ULC	CAN/ULC-S134-13	Fire Test of Exterior Wall Assemblies	3.1.5.5.(1) 9.10.14.5.(2) 9.10.15.5.(2) 9.10.15.5.(3)
ULC	ULC-S135-04	Test Method for the Determination of Combustibility Parameters of Building Materials Using an Oxygen Consumption Calorimeter (Cone Calorimeter)	3.1.5.1.(2)
ULC	CAN/ULC-S138-06	Test for Fire Growth of Insulated Building Panels in a Full-Scale Room Configuration	3.1.5.7.(1) 3.1.5.7.(3)
ULC	CAN/ULC-S139-12	Fire Test for Evaluation of Integrity of Electrical Power, Data and Optical Fibre Cables	3.2.7.10.(2) 3.2.7.10.(3)
ULC	CAN/ULC-S143-09	Fire Tests for Non-Metallic Electrical and Optical Fibre Cable Raceway Systems	3.1.5.23.(1)
ULC	CAN/ULC-S144-12	Fire Resistance Test – Grease Duct Assemblies	3.6.3.5.(2) A-3.6.3.5.
ULC	ULC-S332-93	Burglary Resisting Glazing Material	A-9.7.5.2.(1)
ULC	ULC-S505-1974	Fusible Links for Fire Protection Service	3.1.8.10.(2)
ULC	CAN/ULC-S524-14	Installation of Fire Alarm Systems	3.1.8.11.(3) 3.1.8.14.(3) 3.2.4.5.(1) 3.2.4.20.(8) 3.2.4.20.(13) 9.10.19.4.(3) 9.10.19.6.(2) A-3.2.4.7.(4) A-3.2.4.18.(8) and (9) A-3.2.4.20.(8)
ULC	CAN/ULC-S526-07	Visible Signal Devices for Fire Alarm Systems, Including Accessories	A-3.2.4.19.(2)
ULC	CAN/ULC-S531-14	Smoke Alarms	3.2.4.20.(2) 9.10.19.1.(1)
ULC	CAN/ULC-S537-13	Verification of Fire Alarm Systems	3.2.4.5.(2)
ULC	CAN/ULC-S540-13	Residential Fire and Life Safety Warning Systems: Installation, Inspection, Testing and Maintenance	3.2.4.21.(1) 9.10.19.8.(1)
ULC	CAN/ULC-S553-14	Installation of Smoke Alarms	3.2.4.20.(11) 9.10.19.3.(2)
ULC	CAN/ULC-S561-13	Installation and Services for Fire Signal Receiving Centres and Systems	3.2.4.7.(4) A-3.2.4.7.(4)

Table 1.3.1.2. (Continued)

Issuing Agency	Document Number <sup>(2)</sup>	Title of Document <sup>(3)</sup>	Code Reference
ULC	CAN/ULC-S572-10	Photoluminescent and Self-Luminous Exit Signs and Path Marking Systems	3.4.5.1.(3) 3.4.5.1.(4) 9.9.11.3.(3) 9.9.11.3.(4) A-3.4.5.1.(4)
ULC	CAN/ULC-S610-M87	Factory-Built Fireplaces	9.22.8.1.(1)
ULC	ULC-S628-93	Fireplace Inserts	9.22.10.1.(1)
ULC	CAN/ULC-S629-M87	650°C Factory-Built Chimneys	9.33.10.2.(1)
ULC	CAN/ULC-S639-M87	Steel Liner Assemblies for Solid-Fuel Burning Masonry Fireplaces	9.22.2.3.(1)
ULC	CAN/ULC-S701-11	Thermal Insulation, Polystyrene, Boards and Pipe Covering	Table 5.9.1.1. 9.15.4.1.(1) Table 9.23.17.2.-A 9.25.2.2.(1) Table A-9.36.2.4.(1)-D
ULC	CAN/ULC-S702-09	Mineral Fibre Thermal Insulation for Buildings	Table 5.9.1.1. A-5.9.1.1.(1) Table 9.23.17.2.-A 9.25.2.2.(1) Table A-9.36.2.4.(1)-D
ULC	CAN/ULC-S703-09	Cellulose Fibre Insulation for Buildings	Table 5.9.1.1. 9.25.2.2.(1) Table A-9.36.2.4.(1)-D
ULC	CAN/ULC-S704-11	Thermal Insulation, Polyurethane and Polyisocyanurate, Boards, Faced	Table 5.9.1.1. Table 9.23.17.2.-A 9.25.2.2.(1) Table A-9.36.2.4.(1)-D
ULC	CAN/ULC-S705.1-01	Thermal Insulation – Spray Applied Rigid Polyurethane Foam, Medium Density – Material – Specification	Table 5.9.1.1. 9.25.2.2.(1) Table A-9.36.2.4.(1)-D
ULC	CAN/ULC-S705.2-05	Thermal Insulation – Spray Applied Rigid Polyurethane Foam, Medium Density – Application	Table 5.9.1.1. 9.25.2.5.(1)
ULC	CAN/ULC-S706-09	Wood Fibre Insulating Boards for Buildings	Table 5.9.1.1. 9.23.16.7.(3) Table 9.23.17.2.-A 9.25.2.2.(1) 9.29.8.1.(1)
ULC	CAN/ULC-S710.1-11	Thermal Insulation – Bead-Applied One Component Polyurethane Air Sealant Foam, Part 1: Material Specification	Table 5.9.1.1. 9.36.2.10.(6)
ULC	CAN/ULC-S711.1-11	Thermal Insulation – Bead-Applied Two Component Polyurethane Air Sealant Foam, Part 1: Material Specification	Table 5.9.1.1. 9.36.2.10.(6)
ULC	CAN/ULC-S712.1-10	Thermal Insulation - Light Density, Open Cell Spray Applied Semi-Rigid Polyurethane Foam - Material Specification	Table A-9.36.2.4.(1)-D
ULC	CAN/ULC-S716.1-12	Exterior Insulation and Finish Systems (EIFS) - Materials and Systems	5.9.4.1.(1) A-5.9.4.1.(1) 9.27.13.1.(1) 9.27.13.2.(1) A-9.27.13.2.(2)(a)
ULC	CAN/ULC-S716.2-12	Exterior Insulation and Finish Systems (EIFS) - Installation of EIFS Components and Water Resistive Barrier	A-5.9.4.1.(1) 9.27.13.3.(1)
ULC	CAN/ULC-S716.3-12	Exterior Insulation and Finish System (EIFS) - Design Application	A-5.9.4.1.(1) 9.27.13.3.(1)
ULC	CAN/ULC-S741-08	Air Barrier Materials – Specification	5.4.1.2.(1) 9.36.2.10.(1)

**Table 1.3.1.2. (Continued)**

Issuing Agency	Document Number <sup>(2)</sup>	Title of Document <sup>(3)</sup>	Code Reference
ULC	CAN/ULC-S742-11	Air Barrier Assemblies – Specification	9.36.2.9.(1) A-9.36.2.9.(1) A-9.36.2.10.(5)(b)
ULC	CAN/ULC-S770-09	Determination of Long-Term Thermal Resistance of Closed-Cell Thermal Insulating Foams	Table A-9.36.2.4.(1)-D
ULC	CAN/ULC-S1001-11	Integrated Systems Testing of Fire Protection and Life Safety Systems	3.2.9.1.(1) A-3.2.9.1.(1) 9.10.1.2.(1)
ULC	ULC/ORD-C199P-2002	Combustible Piping for Sprinkler Systems	3.2.5.13.(2) 3.2.5.13.(5)
ULC	ULC/ORD-C1254.6-1995	Fire Testing of Restaurant Cooking Area Fire Extinguishing System Units	6.9.1.3.(1)
U.S. Congress		National Appliance Energy Conservation Act of 1987	Table 9.36.4.2. Table 9.36.5.16.
WCLIB	No. 17 (2004)	Standard Grading Rules	A-Table 9.3.2.1.
WWPA	2011	Western Lumber Grading Rules	A-Table 9.3.2.1.

**Notes to Table 1.3.1.2.:**

- (1) See Table D-1.1.2. in Appendix D for the list of standards referenced therein.
- (2) Some documents may have been reaffirmed or reapproved. Check with the applicable issuing agency for up-to-date information.
- (3) Some titles have been abridged to omit superfluous wording.
- (4) Code reference is in Division A.
- (5) Code reference is in Division C.
- (6) Notwithstanding the effective date stated in Sentence 1.3.1.1.(1), the August 2014 edition of CSA S304 is referenced as it better meets the intent of the Code.

**1.3.2. Organizations**

**1.3.2.1. Abbreviations of Proper Names**

**1)** The abbreviations of proper names in this Code shall have the meanings assigned to them in this Article.

- AAMA ..... American Architectural Manufacturers Association  
(www.aamanet.org)
- ACGIH ..... American Conference of Governmental Industrial Hygienists  
(www.acgih.org)
- AHAM ..... Association of Home Appliance Manufacturers (www.aham.org)
- AHRI ..... Air-Conditioning, Heating and Refrigeration Institute  
(www.ahrinet.org)
- AISI ..... American Iron and Steel Institute (www.steel.org)
- ANSI ..... American National Standards Institute (www.ansi.org)
- ASCE ..... American Society of Civil Engineers (www.asce.org)
- ASHRAE ..... American Society of Heating, Refrigerating and Air-Conditioning Engineers (www.ashrae.org)
- ASME ..... American Society of Mechanical Engineers (www.asme.org)
- ASTM ..... American Society for Testing and Materials International  
(www.astm.org)
- AWPA ..... American Wood Protection Association (www.awpa.com)
- BIA ..... Brick Industry Association (www.bia.org)
- BNQ ..... Bureau de normalisation du Québec (www.bnq.qc.ca)

CAN .....	National Standard of Canada designation (The number or name following the CAN designation represents the agency under whose auspices the standard is issued.) CAN3 designates CSA CAN4 designates ULC
CCBFC .....	Canadian Commission on Building and Fire Codes (see NRC)
CCME .....	Canadian Council of Ministers of the Environment ( <a href="http://www.ccme.ca">www.ccme.ca</a> )
CGSB .....	Canadian General Standards Board ( <a href="http://www.tpsgc-pwgsc.gc.ca/ongc-cgsb/index-eng.html">www.tpsgc-pwgsc.gc.ca/ongc-cgsb/index-eng.html</a> )
CHC .....	Canadian Hydronics Council ( <a href="http://www.ciph.com">www.ciph.com</a> )
CISC .....	Canadian Institute of Steel Construction ( <a href="http://www.cisc.ca">www.cisc.ca</a> )
CMHC .....	Canada Mortgage and Housing Corporation ( <a href="http://www.cmhc.ca">www.cmhc.ca</a> )
CRCA .....	Canadian Roofing Contractors' Association ( <a href="http://www.roofingcanada.com">www.roofingcanada.com</a> )
CSA .....	CSA Group ( <a href="http://www.csagroup.org">www.csagroup.org</a> )
CTI .....	Cooling Technology Institute ( <a href="http://www.cti.org">www.cti.org</a> )
CWC .....	Canadian Wood Council ( <a href="http://www.cwc.ca">www.cwc.ca</a> )
DOE .....	Department of Energy ( <a href="http://www.energy.gov">www.energy.gov</a> )
EC .....	Environment Canada ( <a href="http://www.ec.gc.ca">www.ec.gc.ca</a> )
ECC .....	EIFS Council of Canada ( <a href="http://www.eifscouncil.org">www.eifscouncil.org</a> )
EPA .....	Environmental Protection Agency (U.S.) ( <a href="http://www.epa.gov">www.epa.gov</a> )
FEMA .....	Federal Emergency Management Agency ( <a href="http://www.fema.gov">www.fema.gov</a> )
FLL .....	German Landscape Research, Development and Construction Society ( <a href="http://www.fll.de/shop/english-publications.html">www.fll.de/shop/english-publications.html</a> )
FPI .....	FPInnovations – Wood Products (formerly FCC – Forintek Canada Corporation) ( <a href="http://www.fpinnovations.ca">www.fpinnovations.ca</a> )
GRHC .....	Green Roofs for Healthy Cities ( <a href="http://www.greenroofs.org">www.greenroofs.org</a> )
HC .....	Health Canada ( <a href="http://www.hc-sc.gc.ca">www.hc-sc.gc.ca</a> )
HPVA .....	Hardwood Plywood & Veneer Association ( <a href="http://www.hpva.org">www.hpva.org</a> )
HRAI .....	Heating, Refrigeration and Air Conditioning Institute of Canada ( <a href="http://www.hrai.ca">www.hrai.ca</a> )
HVI .....	Home Ventilating Institute ( <a href="http://www.hvi.org">www.hvi.org</a> )
ICC .....	International Code Council ( <a href="http://www.iccsafe.org">www.iccsafe.org</a> )
IEC .....	International Electrotechnical Commission ( <a href="http://www.iec.ch">www.iec.ch</a> )
ISO .....	International Organization for Standardization ( <a href="http://www.iso.org">www.iso.org</a> )
NBC .....	National Building Code of Canada 2015
NCMA .....	National Concrete Masonry Association ( <a href="http://www.ncma.org">www.ncma.org</a> )
NECB .....	National Energy Code of Canada for Buildings 2015
NEMA .....	National Electrical Manufacturers Association ( <a href="http://www.nema.org">www.nema.org</a> )
NFC .....	National Fire Code of Canada 2015
NFPA .....	National Fire Protection Association ( <a href="http://www.nfpa.org">www.nfpa.org</a> )
NFRC .....	National Fenestration Rating Council ( <a href="http://www.nfrc.org">www.nfrc.org</a> )
NLGA .....	National Lumber Grades Authority ( <a href="http://www.nlga.org">www.nlga.org</a> )
NPC .....	National Plumbing Code of Canada 2015
NRC .....	National Research Council of Canada (Ottawa, Ontario K1A 0R6; <a href="http://www.nrc-cnrc.gc.ca">www.nrc-cnrc.gc.ca</a> )
NRCA .....	National Roofing Contractors Association ( <a href="http://www.nrca.net">www.nrca.net</a> )
NRCan .....	Natural Resources Canada ( <a href="http://www.nrcan.gc.ca">www.nrcan.gc.ca</a> )
NRC Const. ..	NRC Construction (see NRC) ( <a href="http://www.nrc.gc.ca/construction">www.nrc.gc.ca/construction</a> )

NRC-IRC .....	National Research Council, Institute for Research in Construction (former name of NRC Construction)
NYCDH .....	New York City Department of Health and Mental Hygiene ( <a href="http://www.nyc.gov/health">www.nyc.gov/health</a> )
OMMAH .....	Ontario Ministry of Municipal Affairs and Housing ( <a href="http://www.mah.gov.on.ca">www.mah.gov.on.ca</a> )
SMACNA ....	Sheet Metal and Air Conditioning Contractors' National Association ( <a href="http://www.smacna.org">www.smacna.org</a> )
SPRI .....	Single Ply Roofing Industry ( <a href="http://www.spri.org">www.spri.org</a> )
TC .....	Transport Canada ( <a href="http://www.tc.gc.ca">www.tc.gc.ca</a> )
TIAC .....	Thermal Insulation Association of Canada ( <a href="http://www.tiac.ca">www.tiac.ca</a> )
TPIC .....	Truss Plate Institute of Canada ( <a href="http://www.tpic.ca">www.tpic.ca</a> )
TWC .....	Tarion Warranty Corporation (formerly Ontario New Home Warranty Program) ( <a href="http://www.tarion.com">www.tarion.com</a> )
UL .....	Underwriters Laboratories Inc. ( <a href="http://www.ul.com">www.ul.com</a> )
ULC .....	ULC Standards ( <a href="http://canada.ul.com/ulcstandards">canada.ul.com/ulcstandards</a> )
WCLIB .....	West Coast Lumber Inspection Bureau ( <a href="http://www.wclib.org">www.wclib.org</a> )
WWPA .....	Western Wood Products Association ( <a href="http://www.wwpa.org">www.wwpa.org</a> )



# Notes to Part 1

## General

### **A-1.1.2.1.(1) Objectives and Functional Statements Attributed to Acceptable**

**Solutions.** The objectives and functional statements attributed to each Code provision are listed in a table following the provisions in each Part.

Many provisions in Division B serve as modifiers of or pointers to other provisions, or serve other clarification or explanatory purposes. In most cases, no objectives and functional statements have been attributed to such provisions, which therefore do not appear in the above-mentioned tables.

For provisions that serve as modifiers of or pointers to other referenced provisions and that do not have any objectives and functional statements attributed to them, the objectives and functional statements that should be used are those attributed to the provisions they reference.

**A-1.1.3.1.(1) Climatic and Seismic Values.** Climatic values for municipalities not listed in Appendix C may be obtained by contacting the Meteorological Service of Canada, Environment Canada, 4905 Dufferin Street, Toronto, Ontario M3H 5T4; [www.climate.weather.gc.ca](http://www.climate.weather.gc.ca).

Seismic values for municipalities not listed in Appendix C can be obtained at [www.earthquakescanada.nrcan.gc.ca](http://www.earthquakescanada.nrcan.gc.ca) or by writing to the Geological Survey of Canada at 7 Observatory Crescent, Ottawa, Ontario K1A 0Y3, or at P.O. Box 6000, Sidney, B.C. V8L 4B2.

**A-1.1.3.1.(2) Winter Design Temperatures.** The 2.5% values referred to in Sentence 1.1.3.1.(2) are the least restrictive temperatures that can be used. A designer may choose to use the 1% values given in Appendix C, which are in excess of the Code minimums but are considered acceptable.

---

These Notes are included for explanatory purposes only and do not form part of the requirements. The number that introduces each Note corresponds to the applicable requirement in this Part.





---

**Division B**

**Part 2**  
**Reserved**



# **Part 3**

## **Fire Protection, Occupant Safety and Accessibility**

<b>3.1.</b>	<b>General</b>	
3.1.1.	Scope and Definitions .....	3-1
3.1.2.	Classification of Buildings or Parts of Buildings by Major Occupancy .....	3-1
3.1.3.	Multiple Occupancy Requirements .....	3-2
3.1.4.	Combustible Construction .....	3-4
3.1.5.	Noncombustible Construction .....	3-7
3.1.6.	Tents and Air-Supported Structures .....	3-16
3.1.7.	Fire-Resistance Ratings .....	3-17
3.1.8.	Fire Separations and Closures .....	3-18
3.1.9.	Penetrations in Fire Separations and Fire-Rated Assemblies .....	3-25
3.1.10.	Firewalls .....	3-27
3.1.11.	Fire Blocks in Concealed Spaces .....	3-29
3.1.12.	Flame-Spread Rating and Smoke Developed Classification ..	3-31
3.1.13.	Interior Finish .....	3-31
3.1.14.	Roof Assemblies .....	3-34
3.1.15.	Roof Covering .....	3-35
3.1.16.	Fabrics .....	3-35
3.1.17.	Occupant Load .....	3-36
<b>3.2.</b>	<b>Building Fire Safety</b>	
3.2.1.	General .....	3-37
3.2.2.	Building Size and Construction Relative to Occupancy .....	3-39
3.2.3.	Spatial Separation and Exposure Protection .....	3-69
3.2.4.	Fire Alarm and Detection Systems .....	3-82
3.2.5.	Provisions for Firefighting .....	3-91
3.2.6.	Additional Requirements for High Buildings .....	3-96
3.2.7.	Lighting and Emergency Power Systems .....	3-99
3.2.8.	Mezzanines and Openings through Floor Assemblies .....	3-103
3.2.9.	Integrated Fire Protection and Life Safety Systems .....	3-105
<b>3.3.</b>	<b>Safety within Floor Areas</b>	
3.3.1.	All Floor Areas .....	3-105
3.3.2.	Assembly Occupancy .....	3-114
3.3.3.	Care, Treatment or Detention Occupancies .....	3-119
3.3.4.	Residential Occupancy .....	3-121
3.3.5.	Industrial Occupancy .....	3-124

3.3.6.	Design of Hazardous Areas .....	3-126
<b>3.4.</b>	<b>Exits</b>	
3.4.1.	General .....	3-128
3.4.2.	Number and Location of Exits from Floor Areas .....	3-129
3.4.3.	Width and Height of Exits .....	3-132
3.4.4.	Fire Separation of Exits .....	3-134
3.4.5.	Exit Signs .....	3-135
3.4.6.	Types of Exit Facilities .....	3-136
3.4.7.	Fire Escapes .....	3-145
<b>3.5.</b>	<b>Vertical Transportation</b>	
3.5.1.	General .....	3-146
3.5.2.	Standards .....	3-146
3.5.3.	Fire Separations .....	3-147
3.5.4.	Dimensions and Signs .....	3-147
<b>3.6.</b>	<b>Service Facilities</b>	
3.6.1.	General .....	3-148
3.6.2.	Service Rooms .....	3-148
3.6.3.	Vertical Service Spaces and Service Facilities .....	3-151
3.6.4.	Horizontal Service Spaces and Service Facilities .....	3-152
3.6.5.	Air Duct and Plenum Systems ....	3-154
<b>3.7.</b>	<b>Health Requirements</b>	
3.7.1.	Height of Rooms .....	3-157
3.7.2.	Plumbing Facilities .....	3-157
3.7.3.	Medical Gas Piping Systems .....	3-160
<b>3.8.</b>	<b>Accessibility</b>	
3.8.1.	Scope .....	3-161
3.8.2.	Application .....	3-161
3.8.3.	Design .....	3-164
<b>3.9.</b>	<b>Self-service Storage Buildings</b>	
3.9.1.	General .....	3-173
3.9.2.	Building Fire Safety .....	3-173
3.9.3.	Floor Areas .....	3-174
<b>3.10.</b>	<b>Objectives and Functional Statements</b>	
3.10.1.	Objectives and Functional Statements .....	3-174
	<b>Notes to Part 3 .....</b>	<b>3-207</b>

# **Part 3**

## **Fire Protection, Occupant Safety and Accessibility**

(See Note A-3.)

### **Section 3.1. General**

#### **3.1.1. Scope and Definitions**

##### **3.1.1.1. Scope**

- 1)** The scope of this Part shall be as described in Subsection 1.3.3. of Division A.

##### **3.1.1.2. Defined Words**

- 1)** Words that appear in italics are defined in Article 1.4.1.2. of Division A.

##### **3.1.1.3. Use of Term Storage Tank**

- 1)** For the purposes of this Part, the term “storage tank” shall mean a vessel for *flammable liquids* or *combustible liquids* having a capacity of more than 230 L and designed to be installed in a fixed location.

##### **3.1.1.4. Fire Protection Information**

- 1)** Information to be submitted regarding major components of fire protection shall conform to the requirements of Subsection 2.2.3. of Division C.

#### **3.1.2. Classification of Buildings or Parts of Buildings by Major Occupancy**

(See Note A-3.1.2.)

##### **3.1.2.1. Classification of Buildings**

- 1)** Except as permitted by Articles 3.1.2.3. to 3.1.2.5., every *building* or part thereof shall be classified according to its *major occupancy* as belonging to one of the Groups or Divisions described in Table 3.1.2.1. (See Note A-3.1.2.1.(1).)

- 2)** A *building* intended for use by more than one *major occupancy* shall be classified according to all *major occupancies* for which it is used or intended to be used.

**Table 3.1.2.1.**  
**Major Occupancy Classification**  
 Forming Part of Sentences 3.1.2.1.(1) and 3.1.2.2.(1)

Group	Division	Description of <i>Major Occupancies</i>
A	1	<i>Assembly occupancies</i> intended for the production and viewing of the performing arts
A	2	<i>Assembly occupancies</i> not elsewhere classified in Group A
A	3	<i>Assembly occupancies</i> of the arena type
A	4	<i>Assembly occupancies</i> in which occupants are gathered in the open air
B	1	<i>Detention occupancies</i>
B	2	<i>Treatment occupancies</i>
B	3	<i>Care occupancies</i>
C	—	<i>Residential occupancies</i>
D	—	<i>Business and personal services occupancies</i>
E	—	<i>Mercantile occupancies</i>
F	1	<i>High-hazard industrial occupancies</i>
F	2	<i>Medium-hazard industrial occupancies</i>
F	3	<i>Low-hazard industrial occupancies</i>

### 3.1.2.2. Occupancies of Same Classification

1) Any *building* is deemed to be occupied by a single *major occupancy*, notwithstanding its use for more than one *major occupancy*, provided that all *occupancies* are classified as belonging to the same Group classification or, where the Group is divided into Divisions, as belonging to the same Division classification described in Table 3.1.2.1.

### 3.1.2.3. Arena-Type Buildings

1) An arena-type *building* intended for occasional use for trade shows and similar exhibition purposes shall be classified as a Group A, Division 3 *occupancy*. (See Note A-3.1.2.3.(1).)

### 3.1.2.4. Police Stations

1) A police station with detention quarters is permitted to be classified as a Group B, Division 2 *major occupancy* provided the station is not more than 1 *storey* in *building height* and 600 m<sup>2</sup> in *building area*.

### 3.1.2.5. Convalescent and Children's Custodial Homes

1) Convalescent homes and children's custodial homes are permitted to be classified as *residential occupancies* within the application of Part 3, provided that occupants are ambulatory and live as a single housekeeping unit in a *suite* with sleeping accommodation for not more than 10 persons.

### 3.1.2.6. Storage of Combustible Fibres

1) *Buildings* or parts thereof used for the storage of baled *combustible fibres* shall be classified as *medium-hazard industrial occupancies*.

## 3.1.3. Multiple Occupancy Requirements

### 3.1.3.1. Separation of Major Occupancies

1) Except as permitted by Sentences (2) and (3), *major occupancies* shall be separated from adjoining *major occupancies* by *fire separations* having *fire-resistance ratings* conforming to Table 3.1.3.1.

**2)** In a *building* not more than 3 storeys in *building height*, if not more than 2 *dwelling units* are contained together with a Group E *major occupancy*, the *fire-resistance rating* of the *fire separation* between the 2 *major occupancies* need not be more than 1 h.

**3)** In a *building* conforming to the requirements of Articles 3.2.8.2. to 3.2.8.8., the requirements of Sentence (1) for *fire separations* between *major occupancies* do not apply at the vertical plane around the perimeter of an opening through the horizontal *fire separation*.

**Table 3.1.3.1.**  
**Major Occupancy Fire Separations<sup>(1)</sup>**  
Forming Part of Sentence 3.1.3.1.(1)

Major Occupancy	Minimum Fire-Resistance Rating of Fire Separation, h												
	Adjoining Major Occupancy												
	A-1	A-2	A-3	A-4	B-1	B-2	B-3	C	D	E	F-1	F-2	F-3
A-1	—	1	1	1	2	2	2	1	1	2	(2)	2	1
A-2	1	—	1	1	2	2	2	1 <sup>(3)</sup>	1 <sup>(4)</sup>	2	(2)	2	1
A-3	1	1	—	1	2	2	2	1	1	2	(2)	2	1
A-4	1	1	1	—	2	2	2	1	1	2	(2)	2	1
B-1	2	2	2	2	—	2	2	2	2	2	(2)	2	2
B-2	2	2	2	2	2	—	1	2	2	2	(2)	2	2
B-3	2	2	2	2	2	1	—	1	2	2	(2)	2	2
C	1	1 <sup>(3)</sup>	1	1	2	2	1	—	1	2 <sup>(5)</sup>	(2)	2 <sup>(6)</sup>	1
D	1	1 <sup>(4)</sup>	1	1	2	2	2	1	—	—	3	—	—
E	2	2	2	2	2	2	2	2 <sup>(5)</sup>	—	—	3	—	—
F-1	(2)	(2)	(2)	(2)	(2)	(2)	(2)	(2)	3	3	—	2	2
F-2	2	2	2	2	2	2	2	2 <sup>(6)</sup>	—	—	2	—	—
F-3	1	1	1	1	2	2	2	1	—	—	2	—	—

**Notes to Table 3.1.3.1.:**

- (1) Section 3.3. contains requirements for the separation of *occupancies* and tenancies that are in addition to the requirements for the separation of *major occupancies*.
- (2) See Sentence 3.1.3.2.(1).
- (3) Where the *building* is constructed in accordance with Article 3.2.2.50., a *fire separation* with a 2 h *fire-resistance rating* is required between the Group C and Group A, Division 2 *major occupancies*.
- (4) Where the *building* is constructed in accordance with Article 3.2.2.58., a *fire separation* with a 2 h *fire-resistance rating* is required between the Group D and Group A, Division 2 *major occupancies*.
- (5) See Sentence 3.1.3.1.(2).
- (6) See Sentence 3.1.3.2.(2).

**3.1.3.2. Prohibition of Occupancy Combinations**

**1)** No *major occupancy* of Group F, Division 1 shall be contained within a *building* with any *occupancy* classified as Group A, B or C.

**2)** Not more than one *suite of residential occupancy* shall be contained within a *building* classified as a Group F, Division 2 *major occupancy*.

**3)** A *building* conforming to Article 3.2.2.50. shall not contain

- a) except as provided in Sentence (5), a Group A, Division 1 or 3, Group B, or Group F, Division 2 or 3 *major occupancy*, or
- b) a Group A, Division 2 or Group E *major occupancy* above the second *storey*.

(See Note A-3.1.3.2.(3) to (5).)

- 4)** A *building* conforming to Article 3.2.2.58. shall not contain
- a) a Group A, Division 1 or 3, Group B, or Group F, Division 1 *major occupancy*, or
  - b) except as provided in Sentence (5), a Group A, Division 2, Group E, or Group F, Division 2 or 3 *major occupancy* above the second *storey*.
- (See Note A-3.1.3.2.(3) to (5).)

**5)** A *building* conforming to Article 3.2.2.50. or 3.2.2.58. is permitted to contain a *storage garage* below the fourth *storey*. (See Note A-3.1.3.2.(3) to (5).) (See also Sentence 4.4.2.1.(1).)

### 3.1.4. Combustible Construction

#### 3.1.4.1. Combustible Materials Permitted

**1)** A *building* permitted to be of *combustible construction* is permitted to be constructed of *combustible* materials, with or without *noncombustible* components. (See Note A-3.1.4.1.(1).)

**2)** The *flame-spread rating* on any exposed surface of foamed plastic insulation, and on any surface that would be exposed by cutting through the insulation in any direction, shall be not more than 500.

#### 3.1.4.2. Protection of Foamed Plastics

(See Note A-3.1.4.2.)

**1)** Except as permitted in Sentence (2), foamed plastics that form part of a wall or ceiling assembly in *combustible construction* shall be protected from adjacent spaces in the *building*, other than adjacent concealed spaces within *attic or roof spaces*, crawl spaces, and wall and ceiling assemblies,

- a) by one of the interior finishes described in Subsections 9.29.4. to 9.29.9.,
  - b) provided the *building* does not contain a Group A, Group B or Group C *major occupancy*, by sheet metal
    - i) mechanically fastened to the supporting assembly independent of the insulation,
    - ii) not less than 0.38 mm thick, and
    - iii) with a melting point not below 650°C, or
  - c) by any thermal barrier that meets the requirements of Sentence 3.1.5.15.(2) (see Note A-3.1.4.2.(1)(c)).
- (See Note A-3.1.4.2.(1).)

**2)** A walk-in cooler or freezer consisting of factory-assembled wall, floor or ceiling panels containing foamed plastics is permitted in a *building* required to be of *combustible construction*, provided the panels

- a) are protected on both sides by sheet metal not less than 0.38 mm thick having a melting point not less than 650°C,
  - b) do not contain an air space, and
  - c) when a sample panel with an assembled joint typical of field installation is subjected to the applicable test described in Subsection 3.1.12., have a *flame-spread rating* not more than that permitted for the space in which they are located or the space that they bound, as applicable.
- (See Note A-3.1.4.2.(2) and 3.1.5.7.(3).)

**3)** The *flame-spread rating* of doors containing foamed plastics shall comply with Sentences 3.1.13.2.(1) to (3).



**3.1.4.3. Wires and Cables**

**1)** Except as required by Sentence (2), optical fibre cables and electrical wires and cables with *combustible* insulation, jackets or sheathes that are installed in a *building* permitted to be of *combustible construction* shall

- a) not convey flame or continue to burn for more than 1 min when tested in conformance with the Vertical Flame Test (FT1 rating) in CSA C22.2 No. 0.3, "Test Methods for Electrical Wires and Cables," or
- b) be located in
  - i) totally enclosed *noncombustible* raceways (see Note A-3.1.4.3.(1)(b)(i)),
  - ii) masonry walls,
  - iii) concrete slabs, or
  - iv) totally enclosed non-metallic raceways conforming to Clause 3.1.5.23.(1)(b).

(See Note A-3.1.4.3.(1).)

(See also Sentence 3.6.4.3.(1).)

**2)** Except as permitted in Sentences (3) and (4), optical fibre cables and electrical wires and cables with *combustible* insulation, jackets or sheathes that are used for the transmission of voice, sound or data and are installed in a *plenum* in a *building* permitted to be of *combustible construction* shall exhibit the following characteristics when tested in conformance with CAN/ULC-S102.4, "Test for Fire and Smoke Characteristics of Electrical Wiring, Cables and Non-Metallic Raceways," (FT6 rating):

- a) a horizontal flame distance of not more than 1.5 m,
- b) an average optical smoke density of not more than 0.15, and
- c) a peak optical smoke density of not more than 0.5.

**3)** Except as permitted in Sentence (4), where totally enclosed *noncombustible* raceways are used in a *plenum*, exposed components of wiring systems with *combustible* insulation, jackets or sheathes, including optical fibre cables and electrical wires and cables that are used for the transmission of voice, sound or data, that are installed in the *plenum* or that extend not more than 9 m from the *plenum*, including drop down to the floor level, are permitted, provided they exhibit a vertical char of not more than 1.5 m when tested in conformance with the Vertical Flame Test – Cables in Cable Trays (FT4 rating) in CSA C22.2 No. 0.3, "Test Methods for Electrical Wires and Cables."

**4)** Cables or wires within *plenums* that are used for the transmission of signals in fire alarm systems need not comply with the requirements of Sentence (2).

**3.1.4.4. Non-metallic Raceways**

**1)** Totally enclosed non-metallic raceways used in a *plenum* in a *building* permitted to be of *combustible construction* shall meet the requirements of Clause 3.1.5.23.(1)(a).

**3.1.4.5. Fire-Retardant-Treated Wood**

- 1)** If *fire-retardant-treated wood* is specified in this Part, the wood shall
- a) be pressure impregnated with fire-retardant chemicals in conformance with CAN/CSA-O80 Series, "Wood Preservation," and
  - b) have a *flame-spread rating* not more than 25.

**3.1.4.6. Heavy Timber Construction Alternative**

**1)** If *combustible construction* is permitted and is not required to have a *fire-resistance rating* more than 45 min, *heavy timber construction* is permitted to be used.

**2)** If *heavy timber construction* is permitted, it shall conform to Article 3.1.4.7.

**3.1.4.7. Heavy Timber Construction**

**1)** Wood elements in *heavy timber construction* shall be arranged in heavy solid masses and with essentially smooth flat surfaces to avoid thin sections and sharp projections.

**2)** Except as permitted by Sentences (3) to (6) and (12), the minimum dimensions of wood elements in *heavy timber construction* shall conform to Table 3.1.4.7.

**Table 3.1.4.7.**  
**Heavy Timber Dimensions**  
Forming Part of Sentence 3.1.4.7.(2)

Supported Assembly	Structural Element	Solid Sawn (width x depth), mm x mm	Glued-Laminated (width x depth), mm x mm	Round (diam), mm
Roofs only	Columns	140 x 191	130 x 190	180
	Arches supported on the tops of walls or abutments	89 x 140	80 x 152	—
	Beams, girders and trusses	89 x 140	80 x 152	—
	Arches supported at or near the floor line	140 x 140	130 x 152	—
Floors, floors plus roofs	Columns	191 x 191	175 x 190	200
	Beams, girders, trusses and arches	140 x 241 or 191 x 191	130 x 228 or 175 x 190	—

**3)** Where splice plates are used at splices of roof arches supported on the tops of walls or abutments, roof trusses, roof beams and roof girders in *heavy timber construction*, they shall be not less than 64 mm thick.

**4)** Floors in *heavy timber construction* shall be of glued-laminated or solid sawn plank not less than

- a) 64 mm thick, splined or tongued and grooved, or
- b) 38 mm wide and 89 mm deep set on edge and well spiked together.

**5)** Floors in *heavy timber construction* shall be laid

- a) so that no continuous line of end joints will occur except at points of support, and covered with
  - i) tongued and grooved flooring not less than 19 mm thick laid crosswise or diagonally, or
  - ii) tongued and grooved phenolic-bonded plywood, strandboard or waferboard not less than 12.5 mm thick, and
- b) not closer than 15 mm to the walls to provide for expansion, with the gap covered at the top or bottom.

**6)** Roofs in *heavy timber construction* shall be of tongued and grooved phenolic-bonded plywood, strandboard or waferboard not less than 28 mm thick, or glued-laminated or solid sawn plank that is

- a) not less than 38 mm thick, splined or tongued and grooved, or
- b) not less than 38 mm wide and 64 mm deep set on edge and laid so that no continuous line of end joints will occur except at the points of support.

**7)** Wood columns in *heavy timber construction* shall be continuous or superimposed throughout all *storeys*.

**8)** Superimposed wood columns in *heavy timber construction* shall be connected by

- a) reinforced concrete or metal caps with brackets,
- b) steel or iron caps with pintles and base plates, or
- c) timber splice plates fastened to the columns by metal connectors housed within the contact faces.

**9)** Where beams and girders in *heavy timber construction* enter masonry, wall plates, boxes of the self-releasing type or hangers shall be used.

**10)** Wood girders and beams in *heavy timber construction* shall be closely fitted to columns, and adjoining ends shall be connected by ties or caps to transfer horizontal loads across the joints.

**11)** In *heavy timber construction*, intermediate wood beams used to support a floor shall be supported on top of the girders or on metal hangers into which the ends of the beams are closely fitted.

**12)** Roof arches supported on the top of walls or abutments, roof trusses, roof beams and roof girders in *heavy timber construction* are permitted to be not less than 64 mm wide provided

- a) where two or more spaced members are used, the intervening spaces are
  - i) blocked solidly throughout, or
  - ii) tightly closed by a continuous wood cover plate not less than 38 mm thick secured to the underside of the members,
 or
- b) the underneath of the roof deck or sheathing is *sprinklered*.

#### 3.1.4.8. Exterior Cladding

**1)** Not less than 90% of the exterior cladding on each exterior wall of *buildings* conforming to Article 3.2.2.50. or 3.2.2.58. shall consist of

- a) *noncombustible* cladding, or
  - b) a wall assembly that satisfies the criteria of Clause 3.1.5.5.(1)(b).
- (See Note A-3.1.4.8.(1).) (See also Notes A-3.1.5.5.(1)(b)(i) and A-3.1.5.5.(1)(b)(ii).)

**2)** A wall assembly conforming to Clause (1)(b) that includes *combustible* cladding made of *fire-retardant-treated wood* shall be tested for fire exposure after the cladding has been subjected to the accelerated weathering test specified in ASTM D 2898, "Accelerated Weathering of Fire-Retardant-Treated Wood for Fire Testing."

### 3.1.5. Noncombustible Construction

#### 3.1.5.1. Noncombustible Materials

(See Note A-3.1.4.1.(1).)

**1)** Except as permitted by Sentences (2) to (4) and Articles 3.1.5.2. to 3.1.5.24., 3.1.13.4. and 3.2.2.16., a *building* or part of a *building* required to be of *noncombustible construction* shall be constructed with *noncombustible* materials. (See also Subsection 3.1.13. for the requirements regarding the *flame-spread rating* of interior finishes.)

**2)** Notwithstanding the definition of *noncombustible* materials stated in Article 1.4.1.2. of Division A, a material is permitted to be used in *noncombustible construction* provided that, when tested in accordance with ULC-S135, "Test Method for the Determination of Combustibility Parameters of Building Materials Using an Oxygen Consumption Calorimeter (Cone Calorimeter)," at a heat flux of 50 kW/m<sup>2</sup>,

- a) its average total heat release is not more than 3 MJ/m<sup>2</sup>,
- b) its average total smoke extinction area is not more than 1.0 m<sup>2</sup>, and
- c) the test duration is extended beyond the time stipulated in the referenced standard until it is clear that there is no further release of heat or smoke.

**3)** If a material referred to in Sentence (2) consists of a number of discrete layers and testing reveals that the surface layer or layers protect the underlying layers such that complete combustion of the underlying layers does not occur, the test shall be repeated by removing the outer layers sequentially until all layers have been exposed during testing, or until complete combustion has occurred.

**4)** The acceptance criteria for a material tested in accordance with Sentence (3) shall be based on the cumulative emissions from all layers, which must not exceed the criteria stated in Clauses (2)(a) and (b).

#### 3.1.5.2. Minor Combustible Components

**1)** The following minor *combustible* components are permitted in a *building* required to be of *noncombustible construction*:

- a) paint (see also Clause 3.1.13.1.(2)(b)),
- b) self-adhesive tapes, mastics and caulking materials, including foamed plastic air sealants, applied to provide a seal between the major components

- of exterior wall construction, (see also Article 3.6.4.3. for limits on the use of *combustible* materials in *plenum* spaces),
- c) *fire stops* and *fire blocks* conforming to Sentence 3.1.9.1.(1) and Article 3.1.11.7.,
  - d) tubing for pneumatic controls provided it has an outside diameter of not more than 10 mm,
  - e) adhesives, *vapour barriers* and sheathing papers,
  - f) electrical outlet and junction boxes,
  - g) wood blocking within wall assemblies intended for the attachment of handrails, fixtures, and similar items mounted on the surface of the wall, and
  - h) similar minor components.

### 3.1.5.3. Combustible Roofing Materials

- 1) *Combustible* roof covering that has an A, B, or C classification determined in conformance with Subsection 3.1.15. is permitted on a *building* required to be of *noncombustible construction*.
- 2) *Combustible* roof sheathing and roof sheathing supports installed above a concrete deck are permitted on a *building* required to be of *noncombustible construction* provided
  - a) the concrete deck is not less than 50 mm thick,
  - b) the height of the roof space above the deck is not more than 1 m,
  - c) the roof space is divided into compartments by *fire blocks* in conformance with Article 3.1.11.5.,
  - d) openings through the concrete deck other than for *noncombustible* roof drains and plumbing piping are protected by masonry or concrete shafts
    - i) constructed as *fire separations* having a *fire-resistance rating* not less than 1 h, and
    - ii) extending from the concrete deck to not less than 150 mm above the adjacent roof sheathing,
  - e) the perimeter of the roof is protected by a *noncombustible* parapet extending from the concrete deck to not less than 150 mm above the adjacent sheathing, and
  - f) except as permitted by Clause (d), the roof space does not contain any *building* services.
- 3) *Combustible* cant strips, roof curbs, nailing strips and similar components used in the installation of roofing are permitted on a *building* required to be of *noncombustible construction*.
- 4) Wood nailer facings to parapets, not more than 600 mm high, are permitted on a *building* required to be of *noncombustible construction*, if the facings and any roof membranes covering the facings are protected by sheet metal.

### 3.1.5.4. Combustible Glazing and Skylights

- 1) *Combustible* skylight assemblies are permitted in a *building* required to be of *noncombustible construction* if the assemblies have a *flame-spread rating* not more than
  - a) 150 provided the assemblies
    - i) have an individual area not more than 9 m<sup>2</sup>,
    - ii) have an aggregate horizontal projected area of the openings through the ceiling not more than 25% of the area of the ceiling of the room or space in which they are located, and
    - iii) are spaced not less than 2.5 m from adjacent assemblies and from required *fire separations*, or
  - b) 75 provided the assemblies
    - i) have an individual area not more than 27 m<sup>2</sup>,
    - ii) have an aggregate horizontal projected area of the openings through the ceiling not more than 33% of the area of the ceiling of the room or space in which they are located, and
    - iii) are spaced not less than 1.2 m from adjacent assemblies and from required *fire separations*.

(See Note A-3.1.5.4.(1).)

- 2)** *Combustible* vertical glazing installed no higher than the second storey is permitted in a *building* required to be of *noncombustible construction*.
- 3)** Except as permitted by Sentence (4), the *combustible* vertical glazing permitted by Sentence (2) shall have a *flame-spread rating* not more than 75.
- 4)** The *flame-spread rating* of *combustible* glazing is permitted to be not more than 150 if the aggregate area of glazing is not more than 25% of the wall area of the storey in which it is located, and
- the glazing is installed in a *building* not more than 1 storey in *building height*,
  - the glazing in the *first storey* is separated from the glazing in the second storey in accordance with the requirements of Article 3.2.3.17. for opening protection, or
  - the *building* is *sprinklered* throughout.
- 5)** *Combustible* window sashes and frames are permitted in a *building* required to be of *noncombustible construction* provided
- each window in an exterior wall face is an individual unit separated by *noncombustible* wall construction from every other opening in the wall,
  - windows in exterior walls in contiguous storeys are separated by not less than 1 m of *noncombustible construction*, and
  - the aggregate area of openings in an exterior wall face of a *fire compartment* is not more than 40% of the area of the wall face.

### 3.1.5.5. Combustible Cladding on Exterior Walls

- 1)** Except as provided in Sentences (2) and (3), *combustible* cladding is permitted to be used on an exterior wall assembly in a *building* required to be of *noncombustible construction*, provided
- the *building* is
    - not more than 3 storeys in *building height*, or
    - sprinklered* throughout, and
  - when tested in accordance with CAN/ULC-S134, "Fire Test of Exterior Wall Assemblies," the wall assembly satisfies the following criteria for testing and conditions of acceptance (see Note A-3.1.5.5.(1)(b)):
    - flaming on or in the wall assembly does not spread more than 5 m above the opening (see Note A-3.1.5.5.(1)(b)(i)), and
    - the heat flux during the flame exposure on the wall assembly is not more than 35 kW/m<sup>2</sup> measured at 3.5 m above the opening (see Note A-3.1.5.5.(1)(b)(ii)).
- 2)** Except as permitted by Articles 3.2.3.10. and 3.2.3.11., where the *limiting distance* in Tables 3.2.3.1.-B to 3.2.3.1.-E permits an area of *unprotected openings* of not more than 10% of the *exposing building face*, the construction requirements of Table 3.2.3.7. shall be met.
- 3)** A wall assembly permitted by Sentence (1) that includes *combustible* cladding of *fire-retardant-treated wood* shall be tested for fire exposure after the cladding has been subjected to an accelerated weathering test as specified in ASTM D 2898, "Accelerated Weathering of Fire-Retardant-Treated Wood for Fire Testing."

### 3.1.5.6. Combustible Components in Exterior Walls

- 1)** *Combustible* components, other than those permitted by Article 3.1.5.5., are permitted to be used in an exterior wall assembly of a *building* required to be of *noncombustible construction*, provided
- the *building* is
    - not more than 3 storeys in *building height*, or
    - sprinklered* throughout, and
  - the wall assembly
    - meets the requirements of Clause 3.1.5.5.(1)(b), or
    - is protected by masonry or concrete cladding not less than 25 mm thick (see Note A-3.1.5.5.(1)(b)).

**3.1.5.7. Factory-Assembled Panels**

**1)** Except as provided in Sentence (2), factory-assembled wall and ceiling panels containing foamed plastic insulation with a *flame-spread rating* not more than 500 are permitted to be used in a *building* required to be of *noncombustible construction*, provided

- a) the *building*
  - i) is *sprinklered*,
  - ii) is not more than 18 m high, measured from *grade* to the underside of the roof, and
  - iii) does not contain a Group A, Group B, or Group C *major occupancy*, and
- b) the panels
  - i) do not contain an air space,
  - ii) when tested in accordance with CAN/ULC-S138, "Test for Fire Growth of Insulated Building Panels in a Full-Scale Room Configuration," meet the criteria defined therein, and
  - iii) when a sample panel with an assembled joint typical of field installation is subjected to the applicable test described in Subsection 3.1.12., have a *flame-spread rating* not more than that permitted for the room or space that they bound.

**2)** Factory-assembled exterior wall panels containing thermosetting foamed plastic insulation are permitted to be used in a *building* required to be of *noncombustible construction*, provided

- a) the *building*
  - i) is not more than 18 m high, measured from *grade* to the underside of the roof, and
  - ii) does not contain a Group B or Group C *major occupancy*, and
- b) the wall panels
  - i) do not contain an air space,
  - ii) are protected on both sides by sheet steel not less than 0.38 mm thick,
  - iii) remain in place for not less than 10 min when tested in conformance with CAN/ULC-S101, "Fire Endurance Tests of Building Construction and Materials," where the exposed surface includes typical vertical and horizontal joints, and
  - iv) when a sample panel with an assembled joint typical of field installation is subjected to the applicable test described in Subsection 3.1.12., have a *flame-spread rating* not more than that permitted for the room or space that they bound.

**3)** A walk-in cooler or freezer consisting of factory-assembled wall, floor or ceiling panels containing foamed plastic insulation with a *flame-spread rating* not more than 500 is permitted to be used in a *building* required to be of *noncombustible construction*, provided

- a) the *building* is *sprinklered*, and
- b) the panels
  - i) are protected on both sides by sheet metal not less than 0.38 mm thick with a melting point not less than 650°C,
  - ii) do not contain an air space,
  - iii) when tested in accordance with CAN/ULC-S138, "Test for Fire Growth of Insulated Building Panels in a Full-Scale Room Configuration," meet the criteria defined therein, and
  - iv) when a sample panel with an assembled joint typical of field installation is subjected to the applicable test described in Subsection 3.1.12., have a *flame-spread rating* not more than that permitted for the space in which they are located or the space that they bound, as applicable.

(See Note A-3.1.4.2.(2) and 3.1.5.7.(3).)

**3.1.5.8. Nailing Elements**

1) Wood nailing elements attached directly to or set into a continuous *noncombustible* backing for the attachment of interior finishes are permitted in a *building* required to be of *noncombustible construction* provided the concealed space created by the wood elements is not more than 50 mm thick.

**3.1.5.9. Combustible Millwork**

1) *Combustible* millwork, including interior trim, doors and door frames, show windows together with their frames, aprons and backing, handrails, shelves, cabinets and counters, is permitted in a *building* required to be of *noncombustible construction*.

**3.1.5.10. Combustible Flooring Elements**

1) *Combustible stage* flooring supported on *noncombustible* structural members is permitted in a *building* required to be of *noncombustible construction*.

2) Wood members more than 50 mm but not more than 300 mm high applied directly to or set into a *noncombustible* floor slab are permitted for the construction of a raised platform in a *building* required to be of *noncombustible construction* provided the concealed spaces created are divided into compartments by *fire blocks* in conformance with Sentence 3.1.11.3.(2).

3) The floor system for the raised platform referred to in Sentence (2) is permitted to include a *combustible* subfloor and *combustible* finished flooring.

4) *Combustible* finished flooring is permitted in a *building* required to be of *noncombustible construction*.

**3.1.5.11. Combustible Stairs in Dwelling Units**

1) *Combustible* stairs are permitted in a *dwelling unit* in a *building* required to be of *noncombustible construction*.

**3.1.5.12. Combustible Interior Finishes**

1) Except as permitted in Sentences (2) and (3), *combustible* interior wall and ceiling finishes referred to in Clause 3.1.13.1.(2)(b) that are not more than 1 mm thick are permitted in a *building* required to be of *noncombustible construction*.

2) *Combustible* interior wall finishes, other than foamed plastics, that are not more than 25 mm thick are permitted in a *building* required to be of *noncombustible construction*, provided they have a *flame-spread rating* not more than 150 on any exposed surface, or any surface that would be exposed by cutting through the material in any direction.

3) Except as provided in Sentence (4), *combustible* interior ceiling finishes, other than foamed plastics, that are not more than 25 mm thick are permitted in a *building* required to be of *noncombustible construction*, provided they have a *flame-spread rating* not more than 25 on any exposed surface or on any surface that would be exposed by cutting through the material in any direction, except that not more than 10% of the ceiling area within each *fire compartment* is permitted to have a *flame-spread rating* not more than 150.

4) *Combustible* interior ceiling finishes made of *fire-retardant-treated wood* are permitted in a *building* required to be of *noncombustible construction*, provided they are not more than 25 mm thick or are exposed *fire-retardant-treated wood* battens.

**3.1.5.13. Gypsum Board**

1) Gypsum board with a tightly adhering paper covering not more than 1 mm thick is permitted in a *building* required to be of *noncombustible construction* provided the *flame-spread rating* on the surface is not more than 25.

**3.1.5.14. Combustible Insulation**

(See Notes A-3.1.4.2. and A-3.1.4.2.(1).)

- 1) Foamed plastic insulation shall conform to Article 3.1.5.15.
- 2) *Combustible* insulation with a *flame-spread rating* not more than 25 on any exposed surface, or any surface that would be exposed by cutting through the material in any direction, is permitted in a *building* required to be of *noncombustible construction*.
- 3) *Combustible* insulation is permitted to be installed above roof decks, outside of *foundation* walls below ground level, and beneath concrete slabs-on-ground of *buildings* required to be of *noncombustible construction*.
- 4) Except as provided in Sentences (5) and (6), *combustible* insulation with a *flame-spread rating* more than 25 but not more than 500 on any exposed surface, or any surface that would be exposed by cutting through the material in any direction, is permitted in a *building* required to be of *noncombustible construction*, provided the insulation is protected from adjacent space in the *building*, other than adjacent concealed spaces within wall assemblies, by a thermal barrier consisting of
  - a) not less than 12.7 mm thick gypsum board mechanically fastened to a supporting assembly independent of the insulation,
  - b) lath and plaster, mechanically fastened to a supporting assembly independent of the insulation,
  - c) masonry, or
  - d) concrete.
- 5) *Combustible* insulation with a *flame-spread rating* more than 25 but not more than 500 on any exposed surface, or any surface that would be exposed by cutting through the material in any direction, is permitted in the exterior walls of a *building* required to be of *noncombustible construction* that is not *sprinklered* and is more than 18 m high, measured from *grade* to the underside of the roof, provided the insulation is protected from adjacent space in the *building*, other than adjacent concealed spaces within wall assemblies, by a thermal barrier consisting of
  - a) gypsum board not less than 12.7 mm thick, mechanically fastened to a supporting assembly independent of the insulation and with all joints either backed or taped and filled,
  - b) lath and plaster, mechanically fastened to a supporting assembly independent of the insulation,
  - c) masonry or concrete not less than 25 mm thick, or
  - d) any thermal barrier that, when tested in conformance with CAN/ULC-S101, "Fire Endurance Tests of Building Construction and Materials," will not develop an average temperature rise more than 140°C or a maximum temperature rise more than 180°C at any point on its unexposed face within 10 min (see Note A-3.1.5.14.(5)(d)) (see also Article 3.2.3.7.).
- 6) *Combustible* insulation with a *flame-spread rating* more than 25 but not more than 500 on any exposed surface, or any surface that would be exposed by cutting through the material in any direction, is permitted in the interior walls, within ceilings and within roof assemblies of a *building* required to be of *noncombustible construction* that is not *sprinklered* and is more than 18 m high, measured from *grade* to the underside of the roof, provided the insulation is protected from adjacent space in the *building*, other than adjacent concealed spaces within wall assemblies, by a thermal barrier consisting of
  - a) Type X gypsum board not less than 15.9 mm thick, mechanically fastened to a supporting assembly independent of the insulation and with all joints either backed or taped and filled, conforming to
    - i) ASTM C 1177/C 1177M, "Glass Mat Gypsum Substrate for Use as Sheathing,"
    - ii) ASTM C 1178/C 1178M, "Coated Glass Mat Water-Resistant Gypsum Backing Panel,"
    - iii) ASTM C 1396/C 1396M, "Gypsum Board,"
    - iv) ASTM C 1658/C 1658M, "Glass Mat Gypsum Panels," or
    - v) CAN/CSA-A82.27-M, "Gypsum Board,"
  - b) non-loadbearing masonry or concrete not less than 50 mm thick,



- c) *loadbearing* masonry or concrete not less than 75 mm thick, or
- d) any thermal barrier that, when tested in conformance with CAN/ULC-S101, "Fire Endurance Tests of Building Construction and Materials,"
  - i) does not develop an average temperature rise more than 140°C or a maximum temperature rise more than 180°C at any point on its unexposed face within 20 min, and
  - ii) remains in place for not less than 40 min.

### 3.1.5.15. Foamed Plastic Insulation

(See Notes A-3.1.4.2. and A-3.1.4.2.(1).)

**1)** Foamed plastic insulation is permitted to be installed above roof decks, outside of *foundation* walls below ground level, and beneath concrete slabs-on-ground of a *building* required to be of *noncombustible construction*.

**2)** Except as provided in Sentences (3) and (4), foamed plastic insulation with a *flame-spread rating* not more than 500 on any exposed surface, or any surface that would be exposed by cutting through the material in any direction, is permitted in a *building* required to be of *noncombustible construction*, provided the insulation is protected from adjacent space in the *building*, other than adjacent concealed spaces within wall assemblies, by a thermal barrier consisting of

- a) not less than 12.7 mm thick gypsum board mechanically fastened to a supporting assembly independent of the insulation,
- b) lath and plaster, mechanically fastened to a supporting assembly independent of the insulation,
- c) masonry,
- d) concrete, or
- e) any thermal barrier that meets the requirements of classification B when tested in conformance with CAN/ULC-S124, "Test for the Evaluation of Protective Coverings for Foamed Plastic."

**3)** Foamed plastic insulation with a *flame-spread rating* more than 25 but not more than 500 on any exposed surface, or any surface that would be exposed by cutting through the material in any direction, is permitted in the exterior walls of a *building* required to be of *noncombustible construction* that is not *sprinklered* and is more than 18 m high, measured from *grade* to the underside of the roof, provided the insulation is protected from adjacent space in the *building*, other than adjacent concealed spaces within wall assemblies, by a thermal barrier consisting of

- a) gypsum board not less than 12.7 mm thick, mechanically fastened to a supporting assembly independent of the insulation and with all joints either backed or taped and filled,
- b) lath and plaster, mechanically fastened to a supporting assembly independent of the insulation,
- c) masonry or concrete not less than 25 mm thick, or
- d) any thermal barrier that, when tested in conformance with CAN/ULC-S101, "Fire Endurance Tests of Building Construction and Materials," does not develop an average temperature rise more than 140°C or a maximum temperature rise more than 180°C at any point on its unexposed face within 10 min (see Note A-3.1.5.14.(5)(d)) (see also Article 3.2.3.7.).

**4)** Foamed plastic insulation with a *flame-spread rating* more than 25 but not more than 500 on any exposed surface, or any surface that would be exposed by cutting through the material in any direction, is permitted in the interior walls, within ceilings and within roof assemblies of a *building* required to be of *noncombustible construction* that is not *sprinklered* and is more than 18 m high, measured from *grade* to the underside of the roof, provided the insulation is protected from adjacent space in the *building*, other than adjacent concealed spaces within wall assemblies, by a thermal barrier consisting of

- a) Type X gypsum board not less than 15.9 mm thick, mechanically fastened to a supporting assembly independent of the insulation and with all joints either backed or taped and filled, conforming to
  - i) ASTM C 1177/C 1177M, "Glass Mat Gypsum Substrate for Use as Sheathing,"

- ii) ASTM C 1178/C 1178M, "Coated Glass Mat Water-Resistant Gypsum Backing Panel,"
- iii) ASTM C 1396/C 1396M, "Gypsum Board," or
- iv) CAN/CSA-A82.27-M, "Gypsum Board,"
- b) non-loadbearing masonry or concrete not less than 50 mm thick,
- c) loadbearing masonry or concrete not less than 75 mm thick, or
- d) any thermal barrier that, when tested in conformance with CAN/ULC-S101, "Fire Endurance Tests of Building Construction and Materials,"
  - i) does not develop an average temperature rise more than 140°C or a maximum temperature rise more than 180°C at any point on its unexposed face within 20 min, and
  - ii) remains in place for not less than 40 min.

### 3.1.5.16. Combustible Elements in Partitions

- 1) Except as permitted by Sentence (2), solid lumber *partitions* not less than 38 mm thick and wood framing in *partitions* located in a *fire compartment* not more than 600 m<sup>2</sup> in area are permitted to be used in a *building* required to be of *noncombustible construction* in a *floor area* that is not *sprinklered* throughout provided the *partitions*
  - a) are not required *fire separations*, and
  - b) are not located in a *care, treatment* or *detention occupancy*.
- 2) *Partitions* installed in a *building* of *noncombustible construction* are permitted to contain wood framing provided
  - a) the *building* is not more than 3 *storeys* in *building height*,
  - b) the *partitions* are not located in a *care, treatment* or *detention occupancy*, and
  - c) the *partitions* are not installed as enclosures for *exits* or *vertical service spaces*.
- 3) Solid lumber *partitions* not less than 38 mm thick and *partitions* that contain wood framing are permitted to be used in a *building* required to be of *noncombustible construction* provided
  - a) the *building* is *sprinklered* throughout, and
  - b) the *partitions* are not
    - i) located in a *care, treatment* or *detention occupancy*,
    - ii) installed as enclosures for *exits* or *vertical service spaces*, or
    - iii) used to satisfy the requirements of Clause 3.2.8.1.(1)(a).

### 3.1.5.17. Storage Lockers in Residential Buildings

- 1) Storage lockers in storage rooms are permitted to be constructed of wood in a *building* of *residential occupancy* required to be of *noncombustible construction*.

### 3.1.5.18. Combustible Ducts

- 1) Except as required by Sentence 3.6.4.3.(1), *combustible ducts*, including *plenums* and duct connectors, are permitted to be used in a *building* required to be of *noncombustible construction* provided these ducts and duct connectors are used only in horizontal runs.
- 2) *Combustible duct linings*, duct coverings, duct insulation, vibration isolation connectors, duct tape, pipe insulation and pipe coverings are permitted to be used in a *building* required to be of *noncombustible construction* provided they conform to the appropriate requirements of Subsection 3.6.5.
- 3) In a *building* required to be of *noncombustible construction*, *combustible ducts* need not comply with the requirements of Sentences 3.6.5.1.(1) and (2) provided the ducts are
  - a) part of a duct system conveying only ventilation air, and
  - b) contained entirely within a *dwelling unit*.

### 3.1.5.19. Combustible Piping Materials

- 1) Except as permitted by Clause 3.1.5.2.(1)(d) and Sentences (2) and (3), *combustible piping* and tubing and associated adhesives are permitted to be used in

a *building* required to be of *noncombustible construction* provided that, except when concealed in a wall or concrete floor slab, they

- a) have a *flame-spread rating* not more than 25, and
- b) if used in a *building* described in Subsection 3.2.6., have a smoke developed classification not more than 50.

**2)** *Combustible* sprinkler piping is permitted to be used within a *sprinklered floor area* in a *building* required to be of *noncombustible construction*. (See also Article 3.2.5.13.)

**3)** Polypropylene pipes and fittings are permitted to be used for drain, waste and vent piping for the conveyance of highly corrosive materials and for piping used to distribute distilled or dialyzed water in laboratory and hospital facilities in a *building* required to be of *noncombustible construction*, provided

- a) the *building* is *sprinklered* throughout,
- b) the piping is not located in a vertical shaft, and
- c) piping that penetrates a *fire separation* is sealed at the penetration by a *fire stop* that has an FT rating not less than the *fire-resistance rating* of the *fire separation* when subjected to the fire test method in CAN/ULC-S115, "Fire Tests of Firestop Systems," with a pressure differential of 50 Pa between the exposed and unexposed sides, with the higher pressure on the exposed side.

### 3.1.5.20. Combustible Plumbing Fixtures

**1)** *Combustible* plumbing fixtures, including wall and ceiling enclosures that form part of the plumbing fixture, are permitted in a *building* required to be of *noncombustible construction* provided they are constructed of material having a *flame-spread rating* and smoke developed classification not more than that permitted for the wall surface of the room or space in which they are installed.

### 3.1.5.21. Wires and Cables

**1)** Except as required by Sentence (2) and Article 3.1.5.22., optical fibre cables and electrical wires and cables with *combustible* insulation, jackets or sheathes are permitted in a *building* required to be of *noncombustible construction*, provided

- a) the wires and cables exhibit a vertical char of not more than 1.5 m when tested in conformance with the Vertical Flame Test – Cables in Cable Trays (FT4 rating) in CSA C22.2 No. 0.3, "Test Methods for Electrical Wires and Cables,"
- b) the wires and cables are located in
  - i) totally enclosed *noncombustible* raceways (see Note A-3.1.4.3.(1)(b)(i)),
  - ii) masonry walls,
  - iii) concrete slabs,
  - iv) a *service room* separated from the remainder of the *building* by a *fire separation* having a *fire-resistance rating* not less than 1 h, or
  - v) totally enclosed non-metallic raceways conforming to Clause 3.1.5.23.(1)(b), or
- c) the wires and cables are communication cables used at the service entry to a *building* and are not more than 3 m long.

(See Note A-3.1.5.21.(1).)

**2)** Except as permitted in Sentences (3) and (4), optical fibre cables and electrical wires and cables with *combustible* insulation, jackets or sheathes that are used for the transmission of voice, sound or data and are not located in totally enclosed *noncombustible* raceways are permitted to be installed in a *plenum* in a *building* required to be of *noncombustible construction*, provided the wires and cables exhibit a horizontal flame distance of not more than 1.5 m, an average optical smoke density of not more than 0.15, and a peak optical smoke density of not more than 0.5 when tested in conformance with CAN/ULC-S102.4, "Test for Fire and Smoke Characteristics of Electrical Wiring, Cables and Non-Metallic Raceways," (FT6 rating).

**3)** Except as permitted in Sentence (4), where totally enclosed *noncombustible* raceways are used in a *plenum*, exposed components of wiring systems with *combustible*

insulation, jackets or sheathes, including optical fibre cables and electrical wires and cables that are used for the transmission of voice, sound or data, that are installed in the *plenum* or that extend not more than 9 m from the *plenum* including drop down to the floor level, are permitted provided they exhibit a vertical char of not more than 1.5 m when tested in conformance with the Vertical Flame Test – Cables in Cable Trays (FT4 rating) in CSA C22.2 No. 0.3, “Test Methods for Electrical Wires and Cables.”

4) Cables or wires within *plenums* that are used for the transmission of signals in fire alarm systems need not comply with the requirements of Sentences (2) and (3).

### 3.1.5.22. Combustible Travelling Cables for Elevators

1) *Combustible* travelling cables are permitted on elevating devices in a *building* required to be of *noncombustible construction*.

### 3.1.5.23. Non-metallic Raceways

1) Except as required in Sentence (2), subject to the limits on the size of elements that penetrate *fire separations* as stated in Sentence 3.1.9.3.(2), within a *fire compartment* of a *building* required to be of *noncombustible construction*, totally enclosed non-metallic raceways not more than 175 mm in outside diameter, or of an equivalent rectangular area, are permitted to be used to enclose optical fibre cables and electrical wires and cables, provided

- a) where the wires and cables in the raceways meet or exceed the requirements of Clause 3.1.5.21.(1)(a), the non-metallic raceways meet the requirements for at least an FT4 rating in
  - i) CAN/CSA-C22.2 No. 262, “Optical Fiber Cable and Communication Cable Raceway Systems,” or
  - ii) CAN/ULC-S143, “Fire Tests for Non-Metallic Electrical and Optical Fibre Cable Raceway Systems,” and
- b) where the wires and cables in the raceways do not meet or exceed the requirements of Clause 3.1.5.21.(1)(a), the non-metallic raceways exhibit a vertical char of not more than 1.5 m when tested in conformance with the Vertical Flame Test (FT4) – Conduit or Tubing on Cable Tray in Clause 6.16 of CSA C22.2 No. 211.0, “General Requirements and Methods of Testing for Nonmetallic Conduit.”

2) Totally enclosed non-metallic raceways used in a *plenum* in a *building* required to be of *noncombustible construction* shall exhibit a horizontal flame distance of not more than 1.5 m, an average optical smoke density of not more than 0.15, and a peak optical smoke density of not more than 0.5 when tested in conformance with CAN/ULC-S102.4, “Test for Fire and Smoke Characteristics of Electrical Wiring, Cables and Non-Metallic Raceways,” (FT6 rating).

### 3.1.5.24. Decorative Wood Cladding

1) On *buildings* required to be of *noncombustible construction*, decorative wood cladding is permitted to be used on the exterior fascias and soffits of marquees or canopies on the *building* face of a *storey* having direct access to a *street* or access route, provided the wood cladding is *fire-retardant-treated wood* that has been conditioned in conformance with ASTM D 2898, “Accelerated Weathering of Fire-Retardant-Treated Wood for Fire Testing,” before being tested in accordance with CAN/ULC-S102, “Test for Surface Burning Characteristics of Building Materials and Assemblies.”

## 3.1.6. Tents and Air-Supported Structures

(See Note A-3.1.6.)

### 3.1.6.1. Means of Egress

1) Tents and *air-supported structures* shall conform to Sections 3.3. and 3.4.

**3.1.6.2. Restrictions**

- 1) An *air-supported structure* shall not be located above the *first storey* on any *building*.
- 2) An *air-supported structure* shall not be used for Groups B, C, or Group F, Division 1 *major occupancies* or for classrooms.
- 3) An *air-supported structure* shall be designed as open floor space without interior walls, *mezzanines*, intermediate floors or similar construction.

**3.1.6.3. Clearance to Other Structures**

- 1) Except as permitted by Sentences (2), (3) and (4), every tent and *air-supported structure* shall conform to Subsection 3.2.3.
- 2) Tents and *air-supported structures*
  - a) shall not be erected closer than 3 m to other structures on the same property except as permitted by Sentences (3) and (4), and
  - b) shall be sufficiently distant from one another to provide an area to be used as a means of emergency egress.
- 3) Tents and *air-supported structures* not occupied by the public
  - a) need not be separated from one another, and
  - b) are permitted to be erected less than 3 m from other structures on the same property provided this spacing does not create a hazard to the public.
- 4) Tents not more than 120 m<sup>2</sup> in ground area, located on fair grounds or similar open spaces, need not be separated from one another provided this does not create a hazard to the public.

**3.1.6.4. Clearance to Flammable Material**

- 1) The ground enclosed by a tent or *air-supported structure* and not less than 3 m of ground outside the structure shall be cleared of all flammable material or vegetation that will spread fire.

**3.1.6.5. Flame Resistance**

- 1) Every tent and *air-supported structure* and all tarpaulins and decorative materials used in connection with these structures shall conform to CAN/ULC-S109, "Flame Tests of Flame-Resistant Fabrics and Films."

**3.1.6.6. Emergency Air Supply**

- 1) An *air-supported structure* used as a place of assembly for more than 200 persons shall have either
  - a) an automatic emergency engine-generator set capable of powering one blower continuously for 4 h, or
  - b) a supplementary blower powered by an automatic internal combustion engine.

**3.1.6.7. Electrical Systems**

- 1) The electrical system and equipment in a tent or *air-supported structure*, including electrical fuses and switches, shall be inaccessible to the public.
- 2) Cables on the ground in areas used by the public in a tent or *air-supported structure* shall be placed in trenches or protected by covers to prevent damage from traffic.

**3.1.7. Fire-Resistance Ratings****3.1.7.1. Determination of Ratings**

- 1) Except as permitted by Sentence (2) and Articles 3.1.7.2. and 3.6.3.5., the rating of a material, assembly of materials or a structural member that is required to have a *fire-resistance rating*, shall be determined on the basis of the results of tests conducted in

conformance with CAN/ULC-S101, "Fire Endurance Tests of Building Construction and Materials."

**2)** A material, assembly of materials or a structural member is permitted to be assigned a *fire-resistance rating* on the basis of Appendix D.

### 3.1.7.2. Exception for Exterior Walls

**1)** The limit on the rise of temperature on the unexposed surface of an assembly as required by the tests referred to in Sentence 3.1.7.1.(1) shall not apply to an exterior wall that has a *limiting distance* of 1.2 m or more, provided correction is made for radiation from the unexposed surface in accordance with Sentence 3.2.3.1.(9).

### 3.1.7.3. Exposure Conditions for Rating

**1)** Floor, roof and ceiling assemblies shall be rated for exposure to fire on the underside.

**2)** *Firewalls* and interior vertical *fire separations* shall be rated for exposure to fire on each side.

**3)** Exterior walls shall be rated for exposure to fire from inside the *building*.

### 3.1.7.4. Minimum Fire-Resistance Rating

**1)** The use of materials or assemblies having a greater *fire-resistance rating* than required shall impose no obligation to exceed in whole or in part the minimum *fire-resistance ratings* required by this Part.

### 3.1.7.5. Rating of Supporting Construction

**1)** Except as permitted by Sentence (2) and by Articles 3.2.2.20. to 3.2.2.90. for mixed types of construction, all *loadbearing* walls, columns and arches in the *storey* immediately below a floor or roof assembly required to have a *fire-resistance rating* shall have a *fire-resistance rating* not less than that required for the supported floor or roof assembly.

**2)** *Loadbearing* walls, columns and arches supporting a *service room* or *service space* need not conform to Sentence (1).

**3)** Except for *noncombustible* roof assemblies required by Clauses 3.2.2.50.(2)(c) and 3.2.2.58.(2)(c), if an assembly is required to be of *noncombustible construction* and have a *fire-resistance rating*, it shall be supported by *noncombustible construction*.

## 3.1.8. Fire Separations and Closures

### 3.1.8.1. General Requirements

- 1)** Any wall, *partition* or floor assembly required to be a *fire separation* shall
- a) except as permitted by Sentence (2), be constructed as a continuous element, and
  - b) as required in this Part, have a *fire-resistance rating* as specified (see Note A-3.1.8.1.(1)(b)).

**2)** Openings in a *fire separation* shall be protected with *closures*, shafts or other means in conformance with Articles 3.1.8.4. to 3.1.8.19. and Subsections 3.1.9. and 3.2.8. (See Note A-3.1.8.1.(2).)

### 3.1.8.2. Combustible Construction Support

**1)** *Combustible construction* that abuts on or is supported by a *noncombustible fire separation* shall be constructed so that its collapse under fire conditions will not cause the collapse of the *fire separation*.

### 3.1.8.3. Continuity of Fire Separations

**1)** Except as permitted by Sentence 3.6.4.2.(2), a *horizontal service space* or other concealed space located above a required vertical *fire separation*, including the walls

of a vertical shaft, shall be divided at the *fire separation* by an equivalent *fire separation* within the *service space*.

**2)** The *fire separation* required by Sentence (1) shall terminate so that smoke-tight joints are provided where it abuts on or intersects

- a) a floor,
- b) a roof slab, or
- c) a roof deck.

**3)** Except as required by Subsection 3.6.3. for a shaft penetrating a roof assembly, a shaft, including an *exit enclosure*, that penetrates a *fire separation*, shall

- a) extend through any *horizontal service space* or any other concealed space, and
- b) terminate so that smoke-tight joints are provided where the shaft abuts on or intersects
  - i) a floor,
  - ii) a roof slab, or
  - iii) a roof deck.

**4)** The continuity of a *fire separation* shall be maintained where it abuts another *fire separation*, a floor, a ceiling, a roof, or an exterior wall assembly. (See Note A-3.1.8.3.(4).)

**3.1.8.4. Determination of Ratings and Classifications**

**1)** Except as permitted by Sentences (2) and 3.1.8.16.(1), the *fire-protection rating* of a *closure* shall be determined in accordance with

- a) CAN/ULC-S104, "Fire Tests of Door Assemblies,"
- b) CAN4-S106-M, "Fire Tests of Window and Glass Block Assemblies," or
- c) CAN/ULC-S112, "Fire Test of Fire Damper Assemblies."

(See Articles 3.1.8.17. to 3.1.8.19. for additional requirements for *closures*.)

**2)** Except as permitted by Sentence 3.1.8.12.(1), the *fire-protection rating* of a *closure* shall conform to Table 3.1.8.4. for the required *fire-resistance rating* of the *fire separation*.

**3)** The leakage rate of smoke dampers and combination smoke/*fire dampers* shall

- a) be determined in accordance with the applicable provisions in CAN/ULC-S112.1, "Leakage Rated Dampers for Use in Smoke Control Systems," and
- b) conform to Class I, II or III of that standard.

**4)** The leakage rate of a door assembly shall be determined in accordance with ANSI/UL-1784, "Air Leakage Tests of Door Assemblies and Other Opening Protectives."

**Table 3.1.8.4.**  
**Fire-Protection Rating of Closures**  
Forming Part of Sentences 3.1.8.4.(2) and 3.1.9.1.(1)

<i>Fire-Resistance Rating of Fire Separation</i>	<i>Minimum Fire-Protection Rating of Closure</i>
45 min	45 min
1 h	45 min
1.5 h	1 h
2 h	1.5 h
3 h	2 h
4 h	3 h

**3.1.8.5. Installation of Closures**

**1)** Except where *fire dampers*, window assemblies and glass block are used as *closures*, *closures* of the same *fire-protection rating* installed on opposite sides of the same opening are deemed to have a *fire-protection rating* equal to the sum of the *fire-protection ratings* of the *closures*. (See Note A-3.1.8.1.(2).)

- 2)** Except as otherwise specified in this Part, every door, *fire damper*, window assembly or glass block used as a *closure* in a required *fire separation* shall be installed in conformance with NFPA 80, "Fire Doors and Other Opening Protectives." (See Note A-3.1.8.1.(2).)
- 3)** Except as otherwise specified in this Part, every smoke damper or combination smoke/*fire damper* used as a *closure* in a required *fire separation* shall be installed in conformance with NFPA 105, "Smoke Door Assemblies and Other Opening Protectives."
- 4)** If a door is installed such that it could damage the integrity of a *fire separation* if its swing is unrestricted, door stops shall be installed to prevent the damage.
- 5)** Protective guarding devices shall be
- provided where necessary to prevent damage to the mechanical components of doors in *fire separations*, and
  - installed so as not to interfere with the proper operation of the doors.
- 6)** A leakage-rated door assembly complying with Sentence 3.1.8.4.(4) shall be installed in
- fire separations* in protected *floor areas* referred to in Clause 3.3.1.7.(1)(b),
  - fire separations* in *care* or *treatment occupancies* referred to in Sentence 3.3.3.5.(4),
  - except as provided in Sentence (8), *fire separations* of *public corridors* serving *dwelling units* in *storeys* that are not *sprinklered*, and
  - firewalls* that are a *horizontal exit* referred to in Sentence 3.3.3.5.(3).
- 7)** Leakage-rated door assemblies required by Sentence (6) shall be installed in accordance with NFPA 105, "Smoke Door Assemblies and Other Opening Protectives."
- 8)** A leakage-rated door assembly need not be installed where a *dwelling unit* served by a *public corridor* has
- a second and separate *means of egress*, or
  - an open-air balcony that is sized to accommodate the number of occupants for which the *dwelling unit* is intended.

### 3.1.8.6. Maximum Openings

- 1)** The size of an opening in an interior *fire separation* required to be protected with a *closure* shall be not more than 11 m<sup>2</sup>, with no dimension more than 3.7 m, if a *fire compartment* on either side of the *fire separation* is not *sprinklered*.
- 2)** The size of an opening in an interior *fire separation* required to be protected with a *closure* shall be not more than 22 m<sup>2</sup>, with no dimension more than 6 m, provided the *fire compartments* on both sides of the *fire separation* are *sprinklered*.

### 3.1.8.7. Location of Fire Dampers and Smoke Dampers

- 1)** Except as provided in Article 3.1.8.8., a *fire damper* having a *fire-protection rating* conforming to Sentence 3.1.8.4.(2) shall be installed in conformance with Article 3.1.8.10. in ducts or air-transfer openings that penetrate an assembly required to be a *fire separation*.
- 2)** Except as provided in Article 3.1.8.9., a smoke damper or a combination smoke/*fire damper* shall be installed in conformance with Article 3.1.8.11. in ducts or air-transfer openings that penetrate an assembly required to be a *fire separation*, where the *fire separation*
- separates a *public corridor*,
  - contains an egress door referred to in Sentence 3.4.2.4.(2),
  - serves an *assembly*, *care*, *treatment*, *detention* or *residential occupancy*, or
  - is installed to meet the requirements of Clause 3.3.1.7.(1)(b) or Sentence 3.3.3.5.(4).



**3.1.8.8. Fire Dampers Waived**

- 1)** Except as provided in Sentence (2), the requirement for *fire dampers* stated in Sentence 3.1.8.7.(1) is permitted to be waived for
- a) ducts that serve commercial cooking equipment (see also Article 6.3.1.7.),
  - b) continuous *noncombustible* ducts having a melting point above 760°C that penetrate a vertical *fire separation* required by Sentence 3.3.1.1.(1) between *suites of assembly, mercantile, low-hazard industrial, medium-hazard industrial or high-hazard industrial occupancy*,
  - c) ducts or air-transfer openings that penetrate a vertical *fire separation* not required to have a *fire-resistance rating*, or
  - d) *noncombustible* ducts or air-transfer openings that penetrate a horizontal *fire separation* not required to have a *fire-resistance rating*.
- 2)** The requirement for *fire dampers* stated in Sentence 3.1.8.7.(1) is permitted to be waived for *noncombustible* branch ducts having a melting point above 760°C that penetrate a *fire separation*,
- a) provided the ducts
    - i) have a cross-sectional area not more than 0.013 m<sup>2</sup> and serve only air-conditioning units or combined air-conditioning and heating units discharging air not more than 1.2 m above the floor, or
    - ii) extend not less than 500 mm inside *exhaust duct* risers that are under negative pressure and in which the airflow is upward as required by Article 3.6.3.4., or
  - b) where the *fire separation* separates a *vertical service space* from the remainder of the *building*, provided each individual duct exhausts directly to the outdoors at the top of the *vertical service space*.

**3.1.8.9. Smoke Dampers Waived**

- 1)** Except as provided in Sentence (2), the requirement for smoke dampers or combination smoke/*fire dampers* stated in Sentence 3.1.8.7.(2) is permitted to be waived for ducts
- a) that serve commercial cooking equipment (see also Article 6.3.1.7.),
  - b) in which all inlet and outlet openings serve not more than one *fire compartment*, or
  - c) that penetrate a vertical *fire separation* referred to in Clause 3.3.1.7.(1)(b) or in Sentence 3.3.3.5.(4), provided
    - i) the movement of air is continuous, and
    - ii) the configuration of the air-handling system prevents the recirculation of exhaust or return air under fire emergency conditions.
- 2)** The requirement for smoke dampers or combination smoke/*fire dampers* stated in Sentence 3.1.8.7.(2) is permitted to be waived for *noncombustible* branch ducts having a melting point above 760°C that penetrate a *fire separation*,
- a) provided the ducts
    - i) have a cross-sectional area not more than 0.013 m<sup>2</sup> and serve only air-conditioning units or combined air-conditioning and heating units discharging air not more than 1.2 m above the floor,
    - ii) extend not less than 500 mm inside *exhaust duct* risers that are under negative pressure and in which the airflow is upward as required by Article 3.6.3.4., or
    - iii) are required to function as part of a smoke control system, or
  - b) where the *fire separation* separates a *vertical service space* from the remainder of the *building*, provided each individual duct exhausts directly to the outdoors at the top of the *vertical service space*.

**3.1.8.10. Installation of Fire Dampers**

- 1) A *fire damper* shall be installed in the plane of the *fire separation* so as to stay in place should the duct become dislodged during a fire. (See Note A-3.1.8.10.(1).)
- 2) A *fire damper* shall be arranged so as to close automatically upon the operation of a fusible link conforming to ULC-S505, "Fusible Links for Fire Protection Service," or other heat-actuated or smoke-actuated device.
  - 3) A heat-actuated device referred to in Sentence (2) shall
    - a) be located where it is readily affected by an abnormal rise in temperature in the duct, and
    - b) have a temperature rating approximately 30°C above the maximum temperature that would exist in the system, whether it is in operation or shut down.
- 4) A *fire damper* tested in the vertical or horizontal position shall be installed in the position in which it was tested.
- 5) A tightly fitted access door shall be installed for each *fire damper* to provide access for the inspection of the damper and the resetting of the release device. (See Note A-3.1.8.10.(5).)

**3.1.8.11. Installation of Smoke Dampers**

- 1) Where smoke dampers are used as a *closure* in an air-transfer opening, they shall be installed in the plane of the *fire separation*.
- 2) Where combination smoke/*fire dampers* are used as a *closure* in a duct, they shall be installed within 610 mm of the plane of the *fire separation*, provided there is no inlet or outlet opening between the *fire separation* and the damper.
- 3) Except as required by a smoke control system, smoke dampers and combination smoke/*fire dampers* shall be configured so as to close automatically upon a signal from an adjacent *smoke detector* located as described in CAN/ULC-S524, "Installation of Fire Alarm Systems," within 1.5 m horizontally of the duct or air-transfer opening in the *fire separation*
  - a) on both sides of the air-transfer opening, or
  - b) in the duct downstream of the smoke damper or combination smoke/*fire damper*.
- 4) Smoke dampers or combination smoke/*fire dampers* shall be installed in the vertical or horizontal position in which they were tested.
- 5) A tightly fitted access door shall be installed for each smoke damper and combination smoke/*fire damper* to provide access for their inspection and the resetting of the release device. (See Note A-3.1.8.10.(5).)

**3.1.8.12. Twenty-Minute Closures**

- 1) A door assembly having a *fire-protection rating* not less than 20 min is permitted to be used as a *closure* in
  - a) a *fire separation* not required to have a *fire-resistance rating* more than 1 h, located between
    - i) a *public corridor* and a *suite*,
    - ii) a corridor and adjacent sleeping rooms, or
    - iii) a corridor and adjacent classrooms, offices and libraries in Group A, Division 2 *major occupancies*, or
  - b) a *fire separation* not required to have a *fire-resistance rating* more than 45 min, located in a *building* not more than 3 *storeys* in *building height*.
- 2) The requirements for *noncombustible* sills and *combustible* floor coverings in NFPA 80, "Fire Doors and Other Opening Protectives," do not apply to a door described in Sentence (1).
- 3) A door described in Sentence (1) shall have clearances of not more than 6 mm at the bottom and not more than 3 mm at the sides and top.

**3.1.8.13. Self-closing Devices**

- 1)** Except as permitted by Sentence (2), every door in a *fire separation*, other than doors to freight elevators and dumbwaiters, shall be equipped with a self-closing device designed to return the door to the closed position after each use.
- 2)** A self-closing device need not be provided on a door that is located between
- a) a classroom and a corridor providing *access to exit* from the classroom in a *building* that is not more than 3 storeys in *building height*,
  - b) a *public corridor* and an adjacent room of *business and personal services occupancy* in a *building* that is not more than 3 storeys in *building height* provided the door is not located in a dead-end portion of the corridor,
  - c) a patients' sleeping room and a corridor serving the patients' sleeping room, provided the room and corridor are within a *fire compartment* in a hospital or nursing home with *treatment* that complies with the requirements of Article 3.3.3.5., or
  - d) a patients' sleeping room and an adjacent room that serves the patients' sleeping room, provided these rooms are within a *fire compartment* in a hospital or nursing home with *treatment* that complies with the requirements of Article 3.3.3.5.

**3.1.8.14. Hold-Open Devices**

**1)** Except as provided in Sentences 3.1.8.10.(2) and 3.1.8.11.(3), a hold-open device is permitted to be used on a *closure* in a required *fire separation*, other than on an *exit* stair door in a *building* more than 3 storeys in *building height* and on a door for a vestibule required by Article 3.3.5.7., provided the device is designed to release the *closure* in conformance with this Article.

**2)** Except as provided in Sentences (5) and (6), where the *building* is provided with a fire alarm system, a hold-open device permitted by Sentence (1) shall release

- a) in a single-stage system, upon any signal from the fire alarm system, and
- b) in a 2-stage system,
  - i) upon any *alert signal* from the fire alarm system, or
  - ii) upon actuation of any adjacent *smoke detectors*.

**3)** Where the *building* is provided with a fire alarm system, a hold-open device permitted by Sentence (1) shall release upon a signal from a *smoke detector* connected to the fire alarm system and located as described in CAN/ULC-S524, "Installation of Fire Alarm Systems," where the hold-open device is used on

- a) an *exit* door,
- b) a door opening into a *public corridor*,
- c) an egress door referred to in Sentence 3.4.2.4.(2),
- d) a *closure* serving an *assembly, care, treatment, detention, or residential occupancy*,
- e) a door in a *fire separation* referred to in Clause 3.3.1.7.(1)(b) or Sentence 3.3.3.5.(4), or
- f) a door required to function as part of a smoke control system.

**4)** Where the *building* is not provided with a fire alarm system, a hold-open device permitted by Sentence (1) shall release upon a signal from a *smoke alarm* located on each side of the *fire separation* at ceiling level within 1.5 m horizontally of the *closure* opening in the *fire separation*, where the hold-open device is used on *closures* described in Clauses (3)(a) to (e).

**5)** Where a hold-open device is used on *closures* other than those described in Sentences (3) and (4), it is permitted to be released upon actuation of a heat-actuated device.

**6)** A hold-open device used on a door located between a corridor used by the public and an adjacent sleeping room in a *treatment occupancy* need not release automatically as stated in Sentence (2).

**3.1.8.15. Door Latches**

1) Except as permitted by Article 3.3.3.5., a swing-type door in a *fire separation* shall be equipped with a positive latching mechanism designed to hold the door in the closed position after each use.

**3.1.8.16. Wired Glass and Glass Block**

1) Except as permitted by Articles 3.1.8.18. and 3.1.8.19. for the separation of *exits*, an opening in a *fire separation* having a *fire-resistance rating* not more than 1 h is permitted to be protected with fixed wired glass assemblies or glass blocks installed in conformance with NFPA 80, “Fire Doors and Other Opening Protectives.”

2) Wired glass assemblies permitted by Sentence (1) and described in Appendix D are permitted to be used as *closures* in vertical *fire separations* without being tested in accordance with Sentence 3.1.8.4.(1).

3) Glass blocks permitted by Sentence (1) shall be installed in accordance with Subsection 4.3.2. and reinforced with steel reinforcement in each horizontal joint.

**3.1.8.17. Temperature Rise Limit for Doors**

1) Except as permitted by Article 3.1.8.19., the maximum temperature rise on the opaque portion of the unexposed side of a door used as a *closure* in a *fire separation* in a location shown in Table 3.1.8.17. shall conform to the Table when tested in conformance with Sentence 3.1.8.4.(1).

**Table 3.1.8.17.**  
**Restrictions on Temperature Rise and Glazing for Closures**  
 Forming Part of Articles 3.1.8.17. and 3.1.8.18.

Location	Minimum Required Fire-Protection Rating of Door	Maximum Temperature Rise on Opaque Portion of Unexposed Side of Door, °C	Maximum Area of Wired Glass in Door, m <sup>2</sup>	Maximum Aggregate Area of Glass Block and Wired Glass Panels not in a Door, m <sup>2</sup>
Between a dead-end corridor and an adjacent occupancy where the corridor provides the only access to exit and is required to have a fire-resistance rating	Less than 45 min	No limit	No limit	No limit
	45 min	250 after 30 min	0.0645	0.0645
Between an exit enclosure and the adjacent floor area in a building not more than 3 storeys in building height	All ratings	No limit	0.8	0.8
Between an exit enclosure and the adjacent floor area (except as permitted above)	45 min	250 after 30 min	0.0645	0.0645
	1.5 h	250 after 1 h	0.0645	0.0645
	2 h	250 after 1 h	0.0645	0.0645
In a firewall	1.5 h	250 after 30 min	0.0645	0
	3 h	250 after 1 h	0	0

**3.1.8.18. Area Limits for Wired Glass and Glass Block**

1) Except as permitted by Article 3.1.8.19., the maximum area of wired glass in a door used in the locations shown in Table 3.1.8.17. shall conform to the Table. (See Note A-3.1.8.18.(1).)

2) Except as permitted by Article 3.1.8.19., the maximum area of glass block and wired glass panels not in a door, used in the locations shown in Table 3.1.8.17., shall conform to the Table.

**3.1.8.19. Temperature Rise and Area Limits Waived**

**1)** The temperature rise limits and glass area limits required by Articles 3.1.8.17. and 3.1.8.18. are waived for a *closure* between an *exit* enclosure and an enclosed vestibule or corridor, provided

- a) the vestibule or corridor is separated from the remainder of the *floor area* by a *fire separation* having a *fire-resistance rating* not less than 45 min,
- b) the *fire separation* required by Clause (a) contains no wired glass or glass block within 3 m of the *closure* into the *exit* enclosure, and
- c) the vestibule or corridor contains no *occupancy*.

(See Note A-3.1.8.19.(1).)

**3.1.9. Penetrations in Fire Separations and Fire-Rated Assemblies**

(See Note A-3.1.9.)

**3.1.9.1. Fire Stops**

**1)** Except as provided in Sentences (2) to (5) and Article 3.1.9.4., penetrations of a *fire separation* or a membrane forming part of an assembly required to have a *fire-resistance rating* shall be

- a) sealed by a *fire stop* that, when subjected to the fire test method in CAN/ULC-S115, "Fire Tests of Firestop Systems," has an F rating not less than the *fire-protection rating* required for *closures* in the *fire separation* in conformance with Table 3.1.8.4., or
- b) cast in place (see Note A-3.1.9.1.(1)(b)).

(See also Article 3.1.9.5. for requirements regarding penetrations by *combustible* drain, waste and vent piping.)

**2)** Penetrations of a *firewall* or a horizontal *fire separation* that is required to have a *fire-resistance rating* in conformance with Article 3.2.1.2. shall be sealed at the penetration by a *fire stop* that, when subjected to the fire test method in CAN/ULC-S115, "Fire Tests of Firestop Systems," has an FT rating not less than the *fire-resistance rating* for the *fire separation*.

**3)** Penetrations of a *fire separation* in conformance with Sentence 3.6.4.2.(2) shall be sealed by a *fire stop* that, when subjected to the fire test method in CAN/ULC-S115, "Fire Tests of Firestop Systems," has an FT rating not less than the *fire-resistance rating* for the *fire separation* of the assembly.

**4)** Sprinklers are permitted to penetrate a *fire separation* or a membrane forming part of an assembly required to have a *fire-resistance rating* without having to meet the *fire stop* requirements of Sentences (1) to (3), provided the annular space created by the penetration of a fire sprinkler is covered by a metal escutcheon plate in accordance with NFPA 13, "Installation of Sprinkler Systems."

**5)** Unless specifically designed with a *fire stop*, *fire dampers* are permitted to penetrate a *fire separation* or a membrane forming part of an assembly required to have a *fire-resistance rating* without having to meet the *fire stop* requirements of Sentences (1) to (3), provided the *fire damper* is installed in conformance with NFPA 80, "Fire Doors and Other Opening Protectives."

**3.1.9.2. Combustibility of Service Penetrations**

**1)** Except as permitted by Articles 3.1.9.3. and 3.1.9.5., pipes, ducts, electrical outlet boxes, totally enclosed raceways or other similar service equipment that penetrate an assembly required to have a *fire-resistance rating* shall be *noncombustible*, unless the assembly was tested incorporating that service equipment. (See Note A-3.1.9.2.(1).)

**3.1.9.3. Penetration by Wires, Cables and Outlet Boxes**

**1)** Optical fibre cables and electrical wires and cables in totally enclosed *noncombustible* raceways are permitted to penetrate an assembly required to have a *fire-resistance rating* without being incorporated in the assembly at the time of testing as required by Article 3.1.9.2.

**2)** Except as permitted by Sentence (3), totally enclosed non-metallic raceways conforming to Article 3.1.5.23., optical fibre cables, and electrical wires and cables, single or grouped, with *combustible* insulation, jackets or sheathes that conform to the requirements of Clause 3.1.5.21.(1)(a) and that are not installed in totally enclosed *noncombustible* raceways are permitted to penetrate an assembly required to have a *fire-resistance rating* without being incorporated in the assembly at the time of testing as required by Article 3.1.9.2., provided the overall diameter of the single or grouped wires or cables, or the raceways is not more than 25 mm.

**3)** Single conductor metal sheathed cables with *combustible* jacketting that are more than 25 mm in overall diameter are permitted to penetrate a *fire separation* required to have a *fire-resistance rating* without being incorporated in the assembly at the time of testing as required by Article 3.1.9.2., provided the cables are not grouped and are spaced a minimum of 300 mm apart.

**4)** *Combustible* totally enclosed raceways that are embedded in a concrete floor slab are permitted in an assembly required to have a *fire-resistance rating* without being incorporated in the assembly at the time of testing as required by Article 3.1.9.2., provided the concrete cover between the raceway and the bottom of the slab is not less than 50 mm.

**5)** *Combustible* outlet boxes are permitted in an assembly required to have a *fire-resistance rating* without being incorporated in the assembly at the time of testing as required by Article 3.1.9.2., provided the opening through the membrane into the box is not more than 0.016 m<sup>2</sup>.

#### 3.1.9.4.

#### Penetration by Outlet Boxes

(See Note A-3.1.9.4.)

**1)** Except as provided in Sentence (2), outlet boxes are permitted to penetrate the membrane of an assembly required to have a *fire-resistance rating*, provided they are sealed at the penetration by a *fire stop* that has an FT rating not less than the *fire-resistance rating* of the *fire separation* when subjected to the fire test method in CAN/ULC-S115, "Fire Tests of Firestop Systems."

**2)** Except as provided in Sentences 3.1.9.1.(2) and (3), *noncombustible* outlet boxes that penetrate a vertical *fire separation* or a membrane forming part of an assembly required to have a *fire-resistance rating* are permitted to be waived, provided

- a) they do not exceed
  - i) 0.016 m<sup>2</sup> in area, and
  - ii) an aggregate area of 0.065 m<sup>2</sup> in any 9.3 m<sup>2</sup> of surface area, and
- b) the annular space between the membrane and the *noncombustible* electrical outlet boxes does not exceed 3 mm.

**3)** In addition to the requirements of Sentence (2), outlet boxes on opposite sides of a vertical *fire separation* having a *fire-resistance rating* shall be separated by

- a) a horizontal distance of not less than 600 mm, or
- b) a *fire block* conforming to Article 3.1.11.7.

#### 3.1.9.5.

#### Combustible Piping Penetrations

**1)** *Combustible* sprinkler piping is permitted to penetrate a *fire separation* provided the *fire compartments* on each side of the *fire separation* are sprinklered.

**2)** *Combustible* water distribution piping is permitted to penetrate a *fire separation* that is required to have a *fire-resistance rating* without being incorporated in the assembly at the time of testing as required by Article 3.1.9.2., provided the piping is protected at the penetration with a *fire stop* in conformance with Sentence (4).

**3)** Except as permitted by Sentences (4) to (5), *combustible* piping shall not be used in a drain, waste and vent piping system if any part of that system penetrates

- a) a *fire separation* required to have a *fire-resistance rating*, or
- b) a membrane that forms part of an assembly required to have a *fire-resistance rating*.

4) *Combustible* drain, waste and vent piping is permitted to penetrate a *fire separation* required to have a *fire-resistance rating* or a membrane that forms part of an assembly required to have a *fire-resistance rating*, provided

- a) the piping is sealed at the penetration by a *fire stop* that has an F rating not less than the *fire-resistance rating* required for the *fire separation* when subjected to the fire test method in CAN/ULC-S115, "Fire Tests of Firestop Systems," with a pressure differential of 50 Pa between the exposed and unexposed sides, with the higher pressure on the exposed side, and
- b) the piping is not located in a *vertical service space*.

5) *Combustible* drain, waste and vent piping is permitted on one side of a *vertical fire separation* provided it is not located in a *vertical service space*.

6) *Combustible* piping for central vacuum systems is permitted to penetrate a *fire separation* provided the installation conforms to the requirements that apply to *combustible* drain, waste and vent piping specified in Sentence (4).

### 3.1.9.6. Openings through a Membrane Ceiling

1) A membrane ceiling forming part of an assembly assigned a *fire-resistance rating* on the basis of Appendix D is permitted to be penetrated by openings leading into ducts within the ceiling space, provided

- a) the ducts are sheet steel, and
- b) the number of openings and their protection conform to the requirements of Appendix D.

### 3.1.9.7. Plenums

1) A ceiling assembly used as a *plenum* shall conform to Article 3.6.4.3.

## 3.1.10. Firewalls

### 3.1.10.1. Prevention of Firewall Collapse

1) Except as permitted by Sentence (2), the connections and supports for structural framing members that are connected to or supported on a *firewall* and have a *fire-resistance rating* less than that required for the *firewall*, shall be designed so that the failure of the framing systems during a fire will not affect the integrity of the *firewall* during the fire.

2) Sentence (1) does not apply to a *firewall* consisting of two separate wall assemblies each tied to its respective *building* frame but not to each other, provided each wall assembly is

- a) a *fire separation* having one half of the *fire-resistance rating* required for the *firewall* by Sentences 3.1.10.2.(1) and (2), and
- b) designed so that the collapse of one wall assembly will not cause collapse of the other.

3) A *firewall* is permitted to be supported on the structural frame of a *building* of *noncombustible construction* provided the supporting frame has a *fire-resistance rating* not less than that required for the *firewall*.

4) Piping, ducts and totally enclosed *noncombustible* raceways shall be installed so that their collapse will not cause collapse of the *firewall*.

### 3.1.10.2. Rating of Firewalls

1) A *firewall* that separates a *building* or *buildings* with *floor areas* containing a Group E or a Group F, Division 1 or 2 *major occupancy* shall be constructed as a *fire separation* of *noncombustible construction* having a *fire-resistance rating* not less than 4 h, except that where the upper portion of a *firewall* separates *floor areas* containing other than Group E or Group F, Division 1 or 2 *major occupancies*, the *fire-resistance rating* of the upper portion of the *firewall* is permitted to be not less than 2 h.

**2)** A *firewall* that separates a *building* or *buildings* with *floor areas* containing *major occupancies* other than Group E or Group F, Division 1 or 2 shall be constructed as a *fire separation of noncombustible construction* having a *fire-resistance rating* not less than 2 h.

**3)** Except as permitted by Sentence (4), the required *fire-resistance rating* of a *firewall*, except for *closures*, shall be provided by masonry or concrete.

**4)** A *firewall* permitted to have a *fire-resistance rating* not more than 2 h need not be constructed of masonry or concrete, provided

- a) the assembly providing the *fire-resistance rating* is protected against damage that would compromise the integrity of the assembly, and
- b) the design conforms to Article 4.1.5.17.

(See Note A-3.1.10.2.(4).)

### 3.1.10.3. Continuity of Firewalls

**1)** A *firewall* shall extend from the ground continuously through, or adjacent to, all *storeys* of a *building* or *buildings* so separated, except that a *firewall* located above a *basement storage garage* conforming to Article 3.2.1.2. is permitted to commence at the floor assembly immediately above the *storage garage*. (See also Sentence 3.1.10.1.(3).)

**2)** A *firewall* is permitted to terminate on the underside of a reinforced concrete roof slab, provided

- a) the roof slab on both sides of the *firewall* has a *fire-resistance rating* not less than
  - i) 1 h if the *firewall* is required to have a *fire-resistance rating* not less than 2 h, or
  - ii) 2 h if the *firewall* is required to have a *fire-resistance rating* not less than 4 h, and
- b) there are no concealed spaces within the roof slab in that portion immediately above the *firewall*.

### 3.1.10.4. Parapets

**1)** Except as permitted by Sentences (2) and 3.1.10.3.(2), a *firewall* shall extend above the roof surface to form a parapet not less than

- a) 150 mm high for a *firewall* required to have a *fire-resistance rating* not less than 2 h, and
- b) 900 mm high for a *firewall* required to have a *fire-resistance rating* not less than 4 h.

**2)** A *firewall* that separates 2 *buildings* with roofs at different elevations need not extend above the upper roof surface to form a parapet, provided the difference in elevation between the roofs is more than 3 m.

### 3.1.10.5. Maximum Openings

**1)** Openings in a *firewall* shall conform to the size limits described in Article 3.1.8.6. and the aggregate width of openings shall be not more than 25% of the entire length of the *firewall*.

### 3.1.10.6. Exposure Protection for Adjacent Walls

**1)** The requirements of Article 3.2.3.14. shall apply to the external walls of 2 *buildings* that meet at a *firewall* at an angle less than 135°.

### 3.1.10.7. Combustible Projections

**1)** *Combustible* material shall not extend across the end of a *firewall* but is permitted to extend across a roof above a *firewall* that is terminated in conformance with Sentence 3.1.10.3.(2).

**2)** If *buildings* are separated by a *firewall*, *combustible* projections on the exterior of one *building*, including balconies, platforms, canopies, eave projections and stairs, that extend outward beyond the end of the *firewall*, shall not be permitted within 2.4 m



of *combustible* projections and window or door openings of the adjacent *building*. (See also Article 3.2.3.6.)

### 3.1.11. Fire Blocks in Concealed Spaces

#### 3.1.11.1. Separation of Concealed Spaces

1) Concealed spaces in interior wall, ceiling and crawl spaces shall be separated from concealed spaces in exterior walls and *attic or roof spaces* by *fire blocks* conforming to Article 3.1.11.7.

#### 3.1.11.2. Fire Blocks in Wall Assemblies

1) Except as permitted by Sentence (2), *fire blocks* conforming to Article 3.1.11.7. shall be provided to block off concealed spaces within a wall assembly

- a) at every floor level,
- b) at every ceiling level where the ceiling forms part of an assembly required to have a *fire-resistance rating*, and
- c) so that the maximum horizontal dimension is not more than 20 m and the maximum vertical dimension is not more than 3 m.

2) *Fire blocks* conforming to Sentence (1) are not required, provided

- a) the wall space is filled with insulation,
- b) the exposed construction materials and any insulation within the wall space are *noncombustible*,
- c) the exposed materials within the space, including insulation but not including wiring, piping or similar services, have a *flame-spread rating* not more than 25 on any exposed surface, or on any surface that would be exposed by cutting through the material in any direction, and *fire blocks* are installed so that the vertical distance between them is not more than 10 m, or
- d) the insulated wall assembly contains not more than one concealed air space, and the horizontal thickness of that air space is not more than 25 mm.

#### 3.1.11.3. Fire Blocks between Nailing and Supporting Elements

1) In a *building* required to be of *noncombustible construction*, a concealed space in which there is an exposed ceiling finish with a *flame-spread rating* more than 25 shall be provided with *fire blocks* conforming to Article 3.1.11.7. between wood nailing elements so that the maximum area of the concealed space is not more than 2 m<sup>2</sup>.

2) In a *building* required to be of *noncombustible construction*, *fire blocks* conforming to Article 3.1.11.7. shall be provided in the concealed spaces created by the wood members permitted by Sentence 3.1.5.10.(2) so that the maximum area of a concealed space is not more than 10 m<sup>2</sup>.

#### 3.1.11.4. Fire Blocks between Vertical and Horizontal Spaces

1) *Fire blocks* conforming to Article 3.1.11.7. shall be provided

- a) at all interconnections between concealed vertical and horizontal spaces in interior coved ceilings, drop ceilings and soffits in which the exposed construction materials within the space have a *flame-spread rating* more than 25, and
- b) at the end of each run and at each floor level in concealed spaces between stair stringers in which the exposed construction materials within the space have a *flame-spread rating* more than 25.

#### 3.1.11.5. Fire Blocks in Horizontal Concealed Spaces

1) Except for crawl spaces conforming to Sentence 3.1.11.6.(1) and as required in Sentence (3), horizontal concealed spaces within a floor assembly or roof assembly of

*combustible construction*, in which sprinklers are not installed, shall be separated by construction conforming to Article 3.1.11.7. into compartments

- a) not more than 600 m<sup>2</sup> in area with no dimension more than 60 m if the exposed construction materials within the space have a *flame-spread rating* not more than 25, and
- b) not more than 300 m<sup>2</sup> in area with no dimension more than 20 m if the exposed construction materials within the space have a *flame-spread rating* more than 25.

(See Note A-3.1.11.5.(1).)

**2)** A concealed space in an exterior cornice, a mansard-style roof, a balcony or a canopy in which exposed construction materials within the space have a *flame-spread rating* more than 25, shall be separated by construction conforming to Article 3.1.11.7.

- a) at locations where the concealed space extends across the ends of required vertical *fire separations*, and
- b) so that the maximum dimension in the concealed space is not more than 20 m.

**3)** Except as provided in Sentence (4), in *buildings* conforming to Article 3.2.2.50. or 3.2.2.58., horizontal concealed spaces within a floor assembly or roof assembly of *combustible* construction shall be separated by construction conforming to Article 3.1.11.7. into compartments that are

- a) not more than 600 m<sup>2</sup> in area with no dimension more than 60 m, if the exposed construction materials within the space have a *flame-spread rating* not more than 25, and
- b) not more than 300 m<sup>2</sup> in area with no dimension more than 20 m, if the exposed construction materials within the space have a *flame-spread rating* more than 25.

(See Note A-3.1.11.5.(3).)

**4)** *Fire blocks* conforming to Sentence (3) are not required where the horizontal concealed space within the floor or roof assembly is entirely filled with *noncombustible* insulation such that any air gap between the top of the insulation and the floor or roof deck does not exceed 50 mm.

### 3.1.11.6. Fire Blocks in Crawl Spaces

**1)** A crawl space that is not considered as a *basement* by Article 3.2.2.9. and in which sprinklers are not installed, shall be separated by construction conforming to Article 3.1.11.7. into compartments not more than 600 m<sup>2</sup> in area with no dimension more than 30 m.

### 3.1.11.7. Fire Block Materials

**1)** Except as permitted by Sentences (2) to (4) and (7), *fire blocks* shall remain in place and prevent the passage of flames for not less than 15 min when subjected to the standard fire exposure in CAN/ULC-S101, "Fire Endurance Tests of Building Construction and Materials."

**2)** Gypsum board not less than 12.7 mm thick and sheet steel not less than 0.38 mm thick need not be tested in conformance with Sentence (1), provided all joints have continuous support.

**3)** In a *building* required to be of *noncombustible construction*, wood nailing elements described in Article 3.1.5.8. need not be tested in conformance with Sentence (1).

**4)** In a *building* permitted to be of *combustible construction*, in a *combustible* roof system permitted by Sentence 3.1.5.3.(2), and in a raised platform permitted by Sentence 3.1.5.10.(2), *fire blocks* are permitted to be

- a) solid lumber or a structural composite lumber product conforming to ASTM D 5456, "Evaluation of Structural Composite Lumber Products," not less than 38 mm thick,

- b) phenolic bonded plywood, waferboard, or oriented strandboard not less than 12.5 mm thick with joints supported, or
- c) two thicknesses of lumber or a structural composite lumber product conforming to ASTM D 5456, "Evaluation of Structural Composite Lumber Products," each not less than 19 mm thick with joints staggered, where the width or height of the concealed space requires more than one piece of lumber or structural composite lumber product not less than 38 mm thick to block off the space.

**5)** Openings through materials referred to in Sentences (1) to (4) shall be protected to maintain the integrity of the construction.

**6)** Where materials referred to in Sentences (1) to (4) are penetrated by construction elements or by service equipment, a *fire stop* shall be used to seal the penetration. (See Note A-3.1.11.7.(6).)

**7)** In *buildings* permitted to be of *combustible construction*, semi-rigid fibre insulation board produced from glass, rock or slag is permitted to be used to block the vertical space in a double stud wall assembly formed at the intersection of the floor assembly and the walls, provided the width of the vertical space does not exceed 25 mm and the insulation board

- a) has a density not less than 45 kg/m<sup>3</sup>,
- b) is securely fastened to one set of studs,
- c) extends from below the bottom of the top plates in the lower *storey* to above the top of the bottom plate in the upper *storey*, and
- d) completely fills the portion of the vertical space between the headers and between the wall plates.

(See Note A-3.1.11.7.(7).)

### 3.1.12. Flame-Spread Rating and Smoke Developed Classification

#### 3.1.12.1. Determination of Ratings

**1)** Except as required by Sentence (2) and as permitted by Sentence (3), the *flame-spread rating* and smoke developed classification of a material, assembly, or structural member shall be determined on the basis of not less than three tests conducted in conformance with CAN/ULC-S102, "Test for Surface Burning Characteristics of Building Materials and Assemblies."

**2)** The *flame-spread rating* and smoke developed classification of a material or assembly shall be determined on the basis of not less than three tests conducted in conformance with CAN/ULC-S102.2, "Test for Surface Burning Characteristics of Flooring, Floor Coverings, and Miscellaneous Materials and Assemblies," if the material or assembly

- a) is designed for use in a relatively horizontal position with only its top surface exposed to air,
- b) cannot be tested in conformance with Sentence (1) without the use of supporting material that is not representative of the intended installation, or
- c) is thermoplastic.

**3)** A material, assembly, or structural member is permitted to be assigned a *flame-spread rating* and smoke developed classification on the basis of Appendix D.

### 3.1.13. Interior Finish

#### 3.1.13.1. Interior Finishes, Furnishings and Decorative Materials

**1)** Except as otherwise provided by this Subsection, interior finishes, furnishings and decorative materials shall conform to Section 2.3. of Division B of the NFC.

**2)** Interior finish material shall include any material that forms part of the interior surface of a floor, wall, *partition* or ceiling, including

- a) interior cladding of plaster, wood or tile,
- b) surfacing of fabric, paint, plastic, veneer or wallpaper,
- c) doors, windows and trim,

- d) lighting elements such as light diffusers and lenses forming part of the finished surface of the ceiling, and
- e) carpet material that overlies a floor that is not intended as the finished floor.

### 3.1.13.2. Flame-Spread Rating

**1)** Except as otherwise required or permitted by this Subsection, the *flame-spread rating* of interior wall and ceiling finishes, including glazing and skylights, shall be not more than 150 and shall conform to Table 3.1.13.2.

**Table 3.1.13.2.**  
**Flame-Spread Ratings**  
Forming Part of Sentence 3.1.13.2.(1)

Occupancy, Location or Element	Maximum <i>Flame-Spread Rating</i> for Walls and Ceilings	
	<i>Sprinklered</i>	<i>Not Sprinklered</i>
Group A, Division 1 <i>occupancies</i> , including doors, skylights, glazing and light diffusers and lenses	150	75
Group B <i>occupancies</i>	150	75
<i>Exits</i> <sup>(1)</sup>	25	25
Lobbies described in Sentence 3.4.4.2.(2)	25	25
Covered vehicular passageways, except for roof assemblies of <i>heavy timber construction</i> in the passageways	25	25
<i>Vertical service spaces</i>	25	25

#### Notes to Table 3.1.13.2.:

<sup>(1)</sup> See Articles 3.1.13.8. and 3.1.13.10.

**2)** Except as permitted by Sentence (3), doors, other than those in Group A, Division 1 *occupancies*, need not conform to Sentence (1) provided they have a *flame-spread rating* not more than 200. (See Note A-3.1.13.2.(2).)

**3)** Doors within a *dwelling unit* need not conform to Sentences (1) and (2).

**4)** Up to 10% of the total wall area and 10% of the total ceiling area of a wall or ceiling finish that is required by Sentence (1) to have a *flame-spread rating* less than 150 is permitted to have a *flame-spread rating* not more than 150, except that up to 25% of the total wall area of lobbies described in Sentence 3.4.4.2.(2) is permitted to have a *flame-spread rating* not more than 150.

**5)** Except in the case of Group A, Division 1 *occupancies*, *combustible* doors, skylights, glazing and light diffusers and lenses shall not be considered in the calculation of wall and ceiling areas described in Sentence (4).

### 3.1.13.3. Bathrooms in Residential Suites

**1)** The *flame-spread rating* of interior wall and ceiling finishes for a bathroom within a *suite of residential occupancy* shall be not more than 200.

### 3.1.13.4. Light Diffusers and Lenses

**1)** The *flame-spread rating* of *combustible* light diffusers and lenses in all *occupancies* other than Group A, Division 1 is permitted to be more than the *flame-spread rating* limits required elsewhere in this Subsection, provided the light diffusers and lenses

- a) have a *flame-spread rating* not more than 250 and a smoke developed classification not more than 600 when tested in conformance with CAN/ULC-S102.2, "Test for Surface Burning Characteristics of Flooring, Floor Coverings, and Miscellaneous Materials and Assemblies,"
- b) fall to the bottom of the test apparatus before igniting when tested in conformance with CAN/ULC-S102.3, "Fire Test of Light Diffusers and Lenses,"

- c) are not prevented from falling from the ceiling by construction located beneath the elements, and
- d) are not used in a corridor that is required to be separated from the remainder of the *building* by a *fire separation* or in an *exit* shaft unless individual diffusers or lenses are not more than 1 m<sup>2</sup> in area and are not less than 1.2 m apart.

**3.1.13.5. Skylights**

**1)** Individual *combustible* skylights in a corridor that is required to be separated from the remainder of the *building* by a *fire separation* shall be not more than 1 m<sup>2</sup> in area and not less than 1.2 m apart.

**3.1.13.6. Corridors**

**1)** Except as permitted by Sentences (2) and (3), the *flame-spread rating* shall be not more than 75 for the interior wall finish of

- a) a *public corridor*,
- b) a corridor used by the public in an *assembly occupancy*, or
- c) a corridor serving classrooms.

**2)** The *flame-spread rating* for corridors specified in Sentence (1) is permitted to be waived, provided the *flame-spread rating* is not more than

- a) 25 on the upper half of the wall, and
- b) 150 on the lower half of the wall.

**3)** Where the *floor area* is *sprinklered* throughout, the *flame-spread ratings* for corridors specified in Sentences (1) and (2) shall be not more than 150.

**4)** The *flame-spread ratings* specified in Sentences (1), (2) and (3) apply to *occupancies* in the corridor as well as to the corridor itself.

**5)** Except as provided in Sentence (6), the interior ceiling finish of corridors and *occupancies* referred to in Sentences (1) and (4) shall have a *flame-spread rating* not more than 25.

**6)** Where the *floor area* is *sprinklered* throughout, the *flame-spread rating* of the interior ceiling finish of corridors and *occupancies* referred to in Sentences (1) and (4) shall be not more than 150.

**3.1.13.7. High Buildings**

**1)** Except as permitted by Sentences (2) to (4), the interior wall, ceiling and floor finishes in a *building* regulated by the provisions of Subsection 3.2.6. shall conform to the *flame-spread rating* requirements in Articles 3.1.13.2. and 3.1.13.11. and to the *flame-spread rating* and smoke developed classification values in Table 3.1.13.7.

**Table 3.1.13.7.**  
**Flame-Spread Rating and Smoke Developed Classification in High Buildings**  
Forming Part of Sentence 3.1.13.7.(1)

Location or Element	Maximum <i>Flame-Spread Rating</i>			Maximum Smoke Developed Classification		
	Wall Surface	Ceiling Surface <sup>(1)</sup>	Floor Surface	Wall Surface	Ceiling Surface <sup>(1)</sup>	Floor Surface
<i>Exit</i> stairways, vestibules to <i>exit</i> stairs and lobbies described in Sentence 3.4.4.2.(2)	25	25	25	50	50	50
Corridors not within <i>suites</i>	(2)	(2)	300	100	50	500
Elevator cars	75	75	300	450	450	450
Elevator vestibules	25	25	300	100	100	300
<i>Service spaces</i> and <i>service rooms</i>	25	25	25	50	50	50
Other locations and elements	(2)	(2)	No Limit	300	50	No Limit

**Notes to Table 3.1.13.7.:**

- (1) See Article 3.1.13.4. for lighting elements.
- (2) Other requirements of this Part apply.

**2)** Except for a *building* of Group B *major occupancy* and elevator cars, the *flame-spread rating* and smoke developed classification of interior wall, floor and ceiling finishes need not conform to the values in Table 3.1.13.7., provided the *building* is *sprinklered*.

**3)** Trim and millwork in an *exit* stairway, a vestibule to an *exit* stairway, a lobby described in Sentence 3.4.4.2.(2), or a corridor not within a *suite* need not conform to the *flame-spread rating* and smoke developed classification requirements of Sentence (1) provided they have

- a) a *flame-spread rating* not more than 150,
- b) a smoke developed classification not more than 300, and
- c) an aggregate area not more than 10% of the area of the wall or ceiling on which they occur.

**4)** A door serving an *exit* stairway, a vestibule to an *exit* stairway, a lobby described in Sentence 3.4.4.2.(2), or a corridor not within a *suite* need not conform to the *flame-spread rating* and smoke developed classification requirements of Sentence (1) provided

- a) it has a *flame-spread rating* not more than 200,
- b) it has a smoke developed classification not more than 300, and
- c) the aggregate area of all doors is not more than 10% of the area of the wall in which they are located.

### 3.1.13.8. Noncombustible Construction

- 1)** In a *building* required to be of *noncombustible construction*,
- a) the *flame-spread ratings* required by Subsection 3.1.5. shall apply in addition to the requirements in this Subsection, and
  - b) the *flame-spread ratings* for *exits* in this Subsection shall also apply to any surface in the *exit* that would be exposed by cutting through the material in any direction, except that this requirement does not apply to doors, *heavy timber construction* in a *sprinklered building* and *fire-retardant-treated wood*.

### 3.1.13.9. Underground Walkways

**1)** Except for paint, the interior wall and ceiling finishes of an underground *walkway* shall be of *noncombustible* materials.

### 3.1.13.10. Exterior Exit Passageway

**1)** The wall and ceiling finishes of an exterior *exit* passageway that provides the only *means of egress* from the rooms or *suites* it serves, including the soffit beneath and the *guard* on the passageway, shall have a *flame-spread rating* not more than 25, except that a *flame-spread rating* not more than 150 is permitted for up to 10% of the total wall area and for up to 10% of the total ceiling area.

### 3.1.13.11. Elevator Cars

**1)** The wall and ceiling surfaces of elevator cars shall have a *flame-spread rating* not more than 75.

**2)** The wall, ceiling and floor surfaces of elevator cars shall have a smoke developed classification not more than 450.

## 3.1.14. Roof Assemblies

### 3.1.14.1. Fire-Retardant-Treated Wood Roof Systems

**1)** If a *fire-retardant-treated wood* roof system is used to comply with the requirements of Subsection 3.2.2., the roof deck assembly shall meet the conditions of acceptance of CAN/ULC-S126, "Test for Fire Spread Under Roof-Deck Assemblies."

- 2)** Supports for the roof deck assembly referred to in Sentence (1) shall consist of
- a) *fire-retardant-treated wood*,
  - b) *heavy timber construction*,

- c) *noncombustible construction*, or
- d) a combination thereof.

### 3.1.14.2. Metal Roof Deck Assemblies

- 1) Except as permitted by Sentence (2), a metal roof deck assembly shall meet the conditions of acceptance of CAN/ULC-S126, "Test for Fire Spread Under Roof-Deck Assemblies," if
  - a) it supports a *combustible* material above the deck that could propagate a fire beneath the roof deck assembly, and
  - b) the deck is used to comply with the requirements of Sentences 3.2.2.25.(2), 3.2.2.32.(2), 3.2.2.60.(2), 3.2.2.66.(2), 3.2.2.76.(2) and 3.2.2.83.(2) for *noncombustible construction*.
- 2) The requirements of Sentence (1) are waived provided
  - a) the *combustible* material above the roof deck is protected by not less than 12.7 mm thick gypsum board, mechanically fastened to a supporting assembly if located beneath the roof deck, or by a thermal barrier conforming to one of Clauses 3.1.5.15.(2)(c) to (e) that is located
    - i) on the underside of the *combustible* material, or
    - ii) beneath the roof deck,
  - b) the *building* is *sprinklered* throughout, or
  - c) the roof assembly has a *fire-resistance rating* not less than 45 min.

### 3.1.15. Roof Covering

#### 3.1.15.1. Roof Covering Classification

- 1) A roof covering classification shall be determined in conformance with CAN/ULC-S107, "Fire Tests of Roof Coverings."

#### 3.1.15.2. Roof Coverings

- 1) Except as provided in Sentences (2) and (3), every roof covering shall have a Class A, B or C classification as determined in accordance with Article 3.1.15.1.
- 2) A roof covering is not required to have a Class A, B or C classification for
  - a) a tent,
  - b) an *air-supported structure*,
  - c) a *building* of Group A, Division 2 *occupancy* not more than 2 *storeys* in *building height* and not more than 1 000 m<sup>2</sup> in *building area* provided the roof covering is underlaid with *noncombustible* material, or
  - d) a steel *building* system referred to in Article 4.3.4.3., provided the roof covering consists of brick, masonry, concrete, metal sheets or metal shingles.
- 3) Except as provided in Sentence (4), roof coverings on *buildings* conforming to Article 3.2.2.50. or 3.2.2.58. shall have a Class A classification where the roof height is greater than 25 m measured from the floor of the *first storey* to the highest point of the roof.
- 4) Where *buildings* conforming to Article 3.2.2.50. or 3.2.2.58. include non-contiguous roof assemblies at different elevations, the roof coverings referred to in Sentence (3) are permitted to be evaluated separately to determine the roof covering classification required.

### 3.1.16. Fabrics

#### 3.1.16.1. Fabric Canopies and Marquees

- 1) Fabrics used as part of an awning, canopy or marquee that is located within or attached to a *building* of any type of construction shall conform to CAN/ULC-S109, "Flame Tests of Flame-Resistant Fabrics and Films."

**3.1.17. Occupant Load****3.1.17.1. Occupant Load Determination**

- 1)** The *occupant load* of a *floor area* or part of a *floor area* shall be based on
- the number of seats in an *assembly occupancy* having fixed seats,
  - 2 persons per sleeping room in a *dwelling unit*, or
  - the number of persons for which the area is designed, but not less than that determined from Table 3.1.17.1. for *occupancies* other than those described in Clauses (a) and (b), unless it can be shown that the area will be occupied by fewer persons.
- 2)** If a *floor area* or part thereof has been designed for an *occupant load* other than that determined from Table 3.1.17.1., a permanent sign indicating that *occupant load* shall be posted in a conspicuous location.

**Table 3.1.17.1.**  
**Occupant Load**  
Forming Part of Article 3.1.17.1.

Type of Use of <i>Floor Area</i> or Part Thereof	Area per person, m <sup>2</sup>
<b>Assembly uses</b>	
space with fixed seats	(1)
space with non-fixed seats	0.75
<i>stages</i> for theatrical performances	0.75
space with non-fixed seats and tables	0.95
standing space	0.40
stadia and grandstands	0.60
bowling alleys, pool and billiard rooms	9.30
classrooms	1.85
school shops and vocational rooms	9.30
reading or writing rooms or lounges	1.85
dining, beverage and cafeteria space	1.20
laboratories in schools	4.60
<b>Care, treatment or detention uses</b>	
<i>suites</i>	(2)
<i>care, treatment</i> and sleeping room areas	10.00
detention quarters	11.60
<b>Residential uses</b>	
<i>dwelling units</i>	(2)
dormitories	4.60
<b>Business and personal services uses</b>	
personal services shops	4.60
offices	9.30
<b>Mercantile uses</b>	
<i>basements</i> and <i>first storeys</i>	3.70
second <i>storeys</i> having a principal entrance from a pedestrian thoroughfare or a parking area	3.70
other <i>storeys</i>	5.60



**Table 3.1.17.1. (Continued)**

Type of Use of Floor Area or Part Thereof	Area per person, m <sup>2</sup>
<b>Industrial uses</b>	
manufacturing or process rooms	4.60
storage garages	46.00
storage spaces (warehouse)	28.00
aircraft hangars	46.00
<b>Other uses</b>	
cleaning and repair goods	4.60
kitchens	9.30
storage	46.00
public corridors intended for occupancies in addition to pedestrian travel	3.70 <sup>(3)</sup>

**Notes to Table 3.1.17.1.:**

- (1) See Clause 3.1.17.1.(1)(a).
- (2) See Clause 3.1.17.1.(1)(b) (apply values for dwelling units to suites of care occupancy).
- (3) See Note A-3.3.

**3)** For the purposes of this Article, *mezzanines*, tiers and balconies shall be regarded as part of the *floor area*.

**4)** If a room or group of rooms is intended for different *occupancies* at different times, the value to be used from Table 3.1.17.1. shall be the value which gives the greatest number of persons for the *occupancies* concerned.

## **Section 3.2. Building Fire Safety**

### **3.2.1. General**

#### **3.2.1.1. Exceptions in Determining Building Height**

**1)** A roof-top enclosure provided for elevator machinery, a stairway or a *service room* used for no purpose other than for service to the *building*, shall not be considered as a *storey* in calculating the *building height*.

**2)** Space under tiers of seats in a *building* of the arena type shall not be considered as adding to the *building height* provided the space is used only for dressing rooms, concession stands and similar purposes incidental to the *major occupancy* of the *building*.

**3)** Except as required by Sentence (5), the space above a *mezzanine* need not be considered as a *storey* in calculating the *building height*, provided

- a) the aggregate area of *mezzanines* that are not superimposed does not exceed 40% of the open area of the room in which they are located (see Note A-3.2.1.1.(3)(a)), and
- b) except as permitted in Sentences (7) and 3.3.2.13.(3), the space above the *mezzanine* is used as an open area without *partitions* or subdividing walls higher than 1 070 mm above the *mezzanine* floor.

**4)** Except as required by Sentence (5), the space above a *mezzanine* need not be considered as a *storey* in calculating the *building height*, provided

- a) the aggregate area of *mezzanines* that are not superimposed and do not meet the conditions of Sentence (3) does not exceed 10% of the *floor area* in which they are located, and
- b) the area of a *mezzanine* in a *suite* does not exceed 10% of the area of that *suite*.

**5)** Except as permitted by Sentence (6), each level of *mezzanine* that is partly or wholly superimposed above the first level of *mezzanine* shall be considered as a *storey* in calculating the *building height*.

**6)** Platforms intended solely for periodic inspection and elevated maintenance catwalks need not be considered as floor assemblies or *mezzanines* for the purpose of calculating *building height*, provided

- a) they are not used for storage, and
- b) they are constructed with *noncombustible* materials, unless the *building* is permitted to be of *combustible construction*.

**7)** The space above a *mezzanine* conforming to Sentence (3) is permitted to include an enclosed space whose area does not exceed 10% of the open area of the room in which the *mezzanine* is located provided the enclosed space does not obstruct visual communication between the open space above the *mezzanine* and the room in which it is located. (See Note A-3.2.1.1.(3)(a).)

**8)** A *service space* in which facilities are included to permit a person to enter and to undertake maintenance and other operations pertaining to *building* services from within the *service space* need not be considered a *storey* if it conforms to Articles 3.2.5.14. and 3.3.1.24., and Sentences 3.2.4.18.(10), 3.2.7.3.(2), 3.3.1.3.(7), 3.4.2.4.(3) and 3.4.4.4.(9). (See Note A-3.2.1.1.(8).)

### 3.2.1.2. Storage Garage Considered as a Separate Building

**1)** A *basement* used primarily as a *storage garage* is permitted to be considered as a separate *building* for the purposes of Subsection 3.2.2. and Sentences 3.2.5.12.(2) and (3), provided the floor and roof assemblies above the *basement* and the exterior walls of the *basement* above the adjoining ground level are constructed as *fire separations* of *noncombustible construction* having a *fire-resistance rating* not less than 2 h and protected in conformance with Clause 3.1.10.2.(4)(a), except as permitted by Sentence (2). (See Notes A-3.1.10.2.(4) and A-3.2.5.12.(2).)

**2)** The exterior wall of a *basement* that is required to be a *fire separation* with a *fire-resistance rating* in accordance with Sentence (1) is permitted to be penetrated by openings that are not protected by *closures* provided

- a) the *storage garage* is *sprinklered* throughout,
- b) every opening in the exterior wall is separated from *storeys* above the opening by a projection of the floor or roof assembly above the *basement*, extending not less than
  - i) 1 m beyond the exterior face of the *storage garage* if the upper *storeys* are required to be of *noncombustible construction*, or
  - ii) 2 m beyond the exterior face of the *storage garage* if the upper *storeys* are permitted to be of *combustible construction*, or
- c) the exterior walls of any *storeys* located above the floor or roof assembly referred to in Sentence (1) are recessed behind the outer edge of the assembly by not less than
  - i) 1 m if the upper *storeys* are required to be of *noncombustible construction*, or
  - ii) 2 m if the upper *storeys* are permitted to be of *combustible construction*.

**3)** The floor or roof assembly projection referred to in Clause (2)(b) shall have a *fire-resistance rating* not less than 2 h and shall have no openings within the projection.

### 3.2.1.3. Roof Considered as a Wall

**1)** For the purposes of this Section any part of a roof that is pitched at an angle of 60° or more to the horizontal and is adjacent to a space intended for *occupancy* within a *building* shall be considered as part of an exterior wall of the *building*.

### 3.2.1.4. Floor Assembly over Basement

**1)** Except as permitted by Sentence 3.2.2.47.(3), 3.2.2.48.(3), 3.2.2.49.(3), 3.2.2.51.(3), 3.2.2.52.(3), 3.2.2.53.(3) or 3.2.2.54.(3), a floor assembly immediately above a *basement* shall be constructed as a *fire separation* having a *fire-resistance rating* conforming to the requirements of Articles 3.2.2.20. to 3.2.2.90. for a floor assembly, but not less than 45 min.

2) All *loadbearing* walls, columns and arches supporting a floor assembly immediately above a *basement* shall have a *fire-resistance rating* not less than that required by Sentence (1) for the floor assembly.

#### 3.2.1.5. Fire Containment in Basements

1) Except as permitted by Sentences (2) and 3.2.2.15.(3), in a *building* in which an automatic sprinkler system is not required to be installed by Article 3.2.2.18., every *basement* shall

- a) be *sprinklered* throughout, or
- b) be subdivided into *fire compartments* not more than 600 m<sup>2</sup> in area by a *fire separation* having a *fire-resistance rating* not less than that required for the floor assembly immediately above the *basement*.

2) An *open-air storey* need not conform to Sentence (1).

#### 3.2.1.6. Mezzanines

1) The floor assembly of a *mezzanine* that is required to be considered as a *storey* in calculating the *building height* shall be constructed in conformance with the *fire separation* requirements for floor assemblies stated in Articles 3.2.2.20. to 3.2.2.90.

### 3.2.2. Building Size and Construction Relative to Occupancy

#### 3.2.2.1. Application

1) Except as permitted by Article 3.2.2.3., a *building* shall be constructed in conformance with this Subsection to prevent fire spread and collapse caused by the effects of fire. (See Subsection 3.1.3. for *fire separations* between *major occupancies*.)

#### 3.2.2.2. Special and Unusual Structures

1) A structure that cannot be identified with the characteristics of a *building* in Articles 3.2.2.20. to 3.2.2.90. shall be protected against fire spread and collapse in conformance with good fire protection engineering practice. (See Note A-3.2.2.2.(1).) (See also Notes A-3 and A-3.2.5.12.(1).)

#### 3.2.2.3. Exceptions to Structural Fire Protection

- 1) Fire protection is not required for
  - a) steel lintels above openings not more than 2 m wide in *loadbearing* walls and not more than 3 m wide in *non-loadbearing* walls,
  - b) steel lintels above openings more than 2 m wide in *loadbearing* walls and more than 3 m wide in *non-loadbearing* walls provided the lintels are supported at intervals of not more than 2 m by structural members with the required *fire-resistance rating*,
  - c) the bottom flanges of shelf angles and plates that are not a part of the structural frame,
  - d) steel members for framework around elevator hoistway doorways, steel for the support of elevator and dumbwaiter guides, counterweights and other similar equipment, that are entirely enclosed in a hoistway and are not a part of the structural frame of the *building*,
  - e) steel members of stairways and escalators that are not a part of the structural frame of a *building*,

- f) steel members of porches, exterior balconies, exterior stairways, fire escapes, cornices, marquees and other similar appurtenances, provided they are outside an exterior wall of a *building*, and
- g) *loadbearing* steel or concrete members wholly or partly outside a *building* face in a *building* not more than 4 *storeys* in *building height* and classified as Group A, B, C, D or F, Division 3 *major occupancy* provided the members are
  - i) not less than 1 m away from any *unprotected opening* in an exterior wall, or
  - ii) shielded from heat radiation in the event of a fire within the *building* by construction that will provide the same degree of protection that would be necessary if the member was located inside the *building*, with the protection extending on either side of the member a distance equal to the projection of the member from the face of the wall.

(See also Article 3.2.3.9.)

#### 3.2.2.4. Buildings with Multiple Major Occupancies

**1)** The requirements restricting fire spread and collapse for a *building* of a single *major occupancy* classification are provided in this Subsection according to its *building height* and *building area*.

**2)** If a *building* contains more than one *major occupancy*, classified in more than one Group or Division, the requirements of this Subsection concerning *building size* and construction relative to *major occupancy* shall apply according to Articles 3.2.2.5. to 3.2.2.8.

#### 3.2.2.5. Applicable Building Height and Area

**1)** In determining the fire safety requirements of a *building* in relation to each of the *major occupancies* contained therein, the *building height* and *building area* of the entire *building* shall be used.

#### 3.2.2.6. Multiple Major Occupancies

**1)** Except as permitted by Articles 3.2.2.7. and 3.2.2.8., in a *building* containing more than one *major occupancy*, the requirements of this Subsection for the most restricted *major occupancy* contained shall apply to the whole *building*.

#### 3.2.2.7. Superimposed Major Occupancies

**1)** Except as provided in Article 3.2.2.8. and Sentence 3.2.2.18.(2), in a *building* in which one *major occupancy* is located entirely above another *major occupancy*, the requirements in this Subsection for each portion of the *building* containing a *major occupancy* shall apply to that portion as if the entire *building* were of that *major occupancy*.

**2)** If one *major occupancy* is located above another *major occupancy*, the *fire-resistance rating* of the floor assembly between the *major occupancies* shall be determined on the basis of the requirements of this Subsection for the lower *major occupancy*. (See also Article 3.1.3.1.)

**3)** A *building* that is wholly constructed in accordance with the *building area* and construction requirements of Article 3.2.2.50. shall not contain

- a) Group A, Division 2 and Group E *major occupancies* above the second *storey*, or
- b) a *storage garage* above the third *storey* (see also Sentence 4.4.2.1.(1)).

**4)** A *building* that is wholly constructed in accordance with the *building area* and construction requirements of Article 3.2.2.58. shall not contain

- a) Group A, Division 2, Group E, and Group F, Division 2 or 3 *major occupancies* above the second *storey*, or
- b) a *storage garage* above the third *storey* (see also Sentence 4.4.2.1.(1)).

**3.2.2.8. Exceptions for Major Occupancies**

1) In a *building* in which the aggregate area of all *major occupancies* in a particular Group or Division is not more than 10% of the *floor area* of the *storey* in which they are located, these *major occupancies* need not be considered as *major occupancies* for the purposes of this Subsection, provided they are not classified as Group F, Division 1 or 2 *occupancies*.

**3.2.2.9. Crawl Spaces**

- 1) For the purposes of Articles 3.1.11.6., 3.2.1.4. and 3.2.1.5., a crawl space shall be considered as a *basement* if it is
- more than 1.8 m high between the lowest part of the floor assembly and the ground or other surface below,
  - used for any *occupancy*,
  - used for the passage of *flue pipes*, or
  - used as a *plenum* in *combustible construction*.
- 2) A floor assembly immediately above a crawl space is not required to be constructed as a *fire separation* and is not required to have a *fire-resistance rating* provided the crawl space is not required to be considered as a *basement* by Sentence (1).

**3.2.2.10. Streets**

- 1) Every *building* shall face a *street* located in conformance with the requirements of Articles 3.2.5.4. and 3.2.5.5. for access routes.
- 2) For the purposes of Subsections 3.2.2. and 3.2.5. an access route conforming to Subsection 3.2.5. is permitted to be considered as a *street*.
- 3) A *building* conforming to Article 3.2.2.50. or 3.2.2.58. is considered to face 1 *street* where not less than 25% of the *building* perimeter is located within 15 m of a *street* or *streets*.
- 4) A *building* is considered to face 2 *streets* provided not less than 50% of the *building* perimeter is located within 15 m of the *street* or *streets*.
- 5) A *building* is considered to face 3 *streets* provided not less than 75% of the *building* perimeter is located within 15 m of the *street* or *streets*.
- 6) Enclosed spaces, tunnels, bridges and similar structures, even though used for vehicular or pedestrian traffic, are not considered as *streets* for the purpose of this Part.

**3.2.2.11. Exterior Balconies**

1) An exterior balcony shall be constructed in accordance with the type of construction required by Articles 3.2.2.20. to 3.2.2.90., as applicable to the *occupancy* classification of the *building*.

**3.2.2.12. Exterior Passageways**

1) An elevated exterior passageway used as part of a *means of egress* shall conform to the requirements of Articles 3.2.2.20. to 3.2.2.90. for *mezzanines*.

**3.2.2.13. Occupancy on Roof**

1) A portion of a roof that supports an *occupancy* shall be constructed in conformance with the *fire separation* requirements of Articles 3.2.2.20. to 3.2.2.90. for floor assemblies, and not the *fire-resistance rating* for roof assemblies.

**3.2.2.14. Roof-Top Enclosures**

- 1) A roof-top enclosure for elevator machinery or for a *service room* shall be constructed in accordance with the type of construction required by Articles 3.2.2.20. to 3.2.2.90.
- 2) A roof-top enclosure for elevator machinery or for a *service room*, not more than one *storey* high, is not required to have a *fire-resistance rating*.

**3)** A roof-top enclosure for a stairway shall be constructed in accordance with the type of construction required by Articles 3.2.2.20. to 3.2.2.90.

**4)** A roof-top enclosure for a stairway need not have a *fire-resistance rating* nor be constructed as a *fire separation*.

### 3.2.2.15. Storeys below Ground

**1)** If a *building* is erected entirely below the adjoining finished ground level and does not extend more than one *storey* below that ground level, the minimum precautions against fire spread and collapse shall be the same as are required for *basements* under a *building* of 1 *storey* in *building height* having the same *occupancy* and *building area*.

**2)** If any portion of a *building* is erected entirely below the adjoining finished ground level and extends more than one *storey* below that ground level, the following minimum precautions against fire spread and collapse shall be taken:

- a) except as permitted by Sentence (3), the *basements* shall be *sprinklered* throughout,
- b) a floor assembly below the ground level shall be constructed as a *fire separation* with a *fire-resistance rating* not less than
  - i) 3 h if the *basements* are used as Group E or Group F, Division 1 or 2 *occupancies*, or
  - ii) 2 h if the *basements* are not used as Group E or Group F, Division 1 or 2 *occupancies*, and
- c) all *loadbearing* walls, columns and arches shall have a *fire-resistance rating* not less than that required for the construction that they support.

**3)** If the *first storey* of a *building* is not required to be *sprinklered*, sprinklers are not required in the *storey* immediately below the *first storey* provided the *storey* below

- a) contains only *residential occupancies*, and
- b) has at least one unobstructed access opening conforming to Sentence 3.2.5.1.(2) installed on that *storey* for each 15 m of wall length in at least one wall required by this Subsection to face a *street*.

### 3.2.2.16. Heavy Timber Roof Permitted

**1)** Unless otherwise permitted by Articles 3.2.2.20. to 3.2.2.90., a roof assembly in a *building* up to 2 *storeys* in *building height* is permitted to be of *heavy timber construction* regardless of *building area* or type of construction required, provided the *building* is *sprinklered* throughout.

**2)** If Sentence (1) permits a roof assembly to be of *heavy timber construction*, structural members in the *storey* immediately below the roof assembly are permitted to be of *heavy timber construction*.

### 3.2.2.17. Arena-Type Building Roof Assembly

**1)** The requirements for a roof assembly to have a *fire-resistance rating* are permitted to be waived for a gymnasium, a swimming pool, an arena, or a rink if no part of the roof assembly is less than 6 m above the main floor or balcony and the roof carries no loads other than normal roof loads, including permanent access walks, and ventilating, sound and lighting equipment, except that the restriction concerning minimum distance shall not apply to

- a) an inclined and stepped floor ascending from the main floor which is used for seating purposes only, or
- b) a balcony used for seating purposes only.

### 3.2.2.18. Automatic Sprinkler System Required

**1)** Except as permitted by Sentence (2), an automatic sprinkler system conforming to the requirements of Articles 3.2.4.7., 3.2.4.8., 3.2.4.9. and 3.2.5.12. shall be installed throughout a *building* regulated by one or more of Articles 3.2.2.20., 3.2.2.21., 3.2.2.22., 3.2.2.23., 3.2.2.24., 3.2.2.26., 3.2.2.27., 3.2.2.29., 3.2.2.31., 3.2.2.33., 3.2.2.36., 3.2.2.37., 3.2.2.38., 3.2.2.39., 3.2.2.40., 3.2.2.41., 3.2.2.42., 3.2.2.43., 3.2.2.44., 3.2.2.45., 3.2.2.46.,

3.2.2.47., 3.2.2.48., 3.2.2.51., 3.2.2.54., 3.2.2.55., 3.2.2.57., 3.2.2.59., 3.2.2.61., 3.2.2.63., 3.2.2.64., 3.2.2.65., 3.2.2.67., 3.2.2.69., 3.2.2.70., 3.2.2.71., 3.2.2.72., 3.2.2.74., 3.2.2.75., 3.2.2.77., 3.2.2.79., 3.2.2.80., 3.2.2.82., 3.2.2.84., 3.2.2.86. and 3.2.2.88.

**2)** If a *storey* in a *building* or a *floor area* is required to have an automatic sprinkler system installed throughout in accordance with one or more of Articles 3.2.2.20. to 3.2.2.90. or Section 3.3., the automatic sprinkler system shall also be installed throughout all lower *storeys* in the *building* notwithstanding permission in Articles 3.2.2.20. to 3.2.2.90. to construct one or more of those *storeys* without installing automatic sprinkler protection. (See Note A-3.2.2.18.(2).)

### 3.2.2.19. Buildings Containing Impeded Egress Zones

**1)** A *building* containing an *impeded egress zone* and conforming to the appropriate requirements of Articles 3.2.2.20. to 3.2.2.90. is not required to conform to the requirements of Articles 3.2.2.36. and 3.2.2.37. for a Group B, Division 1 *major occupancy* provided

- a) the *building* is *sprinklered* throughout,
- b) it is not more than 1 *storey* in *building height*,
- c) it does not include
  - i) a *contained use area*,
  - ii) sleeping accommodation,
  - iii) a *high-hazard industrial occupancy*, or
  - iv) a *mercantile occupancy*,
- d) the *building area* is not more than 6 400 m<sup>2</sup> if the *building* includes a *medium-hazard industrial occupancy*,
- e) the *impeded egress zone* does not extend beyond the boundaries of the *fire compartment* in which it is located, and
- f) the *occupant load* of the *impeded egress zone* is not more than 100.

### 3.2.2.20. Group A, Division 1, Any Height, Any Area, Sprinklered

**1)** Except as permitted by Articles 3.2.2.21. and 3.2.2.22., a *building* classified as Group A, Division 1 shall conform to Sentence (2).

**2)** Except as permitted by Article 3.2.2.16., the *building* referred to in Sentence (1) shall be of *noncombustible construction*, and

- a) except as permitted by Sentences 3.2.2.7.(1) and 3.2.2.18.(2), the *building* shall be *sprinklered* throughout,
- b) floor assemblies shall be *fire separations* with a *fire-resistance rating* not less than 2 h,
- c) *mezzanines* shall have a *fire-resistance rating* not less than 1 h, and
- d) *loadbearing walls*, columns and arches shall have a *fire-resistance rating* not less than that required for the supported assembly.

### 3.2.2.21. Group A, Division 1, One Storey, Limited Area, Sprinklered

**1)** A *building* classified as Group A, Division 1 is permitted to conform to Sentence (2) provided

- a) except as permitted by Sentences 3.2.2.7.(1) and 3.2.2.18.(2), the *building* is *sprinklered* throughout,
- b) it is not more than 1 *storey* in *building height*,
- c) it has less than 40% of the area of the *building* as 2 *storeys* for the purpose of
  - i) development of productions, including preparation of scenery and costumes and rehearsal of performers,
  - ii) organization of performers, scenery and sound equipment,
  - iii) preparation by performers for a performance,
  - iv) managerial functions, or
  - v) toilets, rest rooms and similar public facilities,
- d) it has no *occupancy* above or below the auditorium other than one which serves it or is dependent on it,
- e) it is not more than 600 m<sup>2</sup> in *building area*, and
- f) the *occupant load* is not more than 600.

- 2)** The *building* referred to in Sentence (1) is permitted to be of *heavy timber construction* or *noncombustible construction* used singly or in combination, and
- a) floor assemblies shall be *fire separations*
    - i) with a *fire-resistance rating* not less than 45 min, or
    - ii) of *heavy timber construction*, and
  - b) *loadbearing walls, columns and arches* shall
    - i) have a *fire-resistance rating* not less than that required for the supported assembly, or
    - ii) be of *heavy timber construction*.

### 3.2.2.22. Group A, Division 1, One Storey, Sprinklered

- 1)** A *building* classified as Group A, Division 1 is permitted to conform to Sentence (2) provided
- a) except as permitted by Sentences 3.2.2.7.(1) and 3.2.2.18.(2), the *building* is *sprinklered* throughout,
  - b) it is not more than 1 *storey* in *building height*,
  - c) no part of an auditorium floor is more than 5 m above or below *grade*,
  - d) no *occupancy* is above or below the auditorium other than one which serves it or is dependent on it, and
  - e) the *occupant load* of the auditorium floor is not more than 300.
- 2)** The *building* referred to in Sentence (1) is permitted to be of *combustible construction* or *noncombustible construction* used singly, or in combination, and
- a) floor assemblies shall be *fire separations* with a *fire-resistance rating* not less than 45 min,
  - b) *mezzanines* shall have, if of *combustible construction*, a *fire-resistance rating* not less than 45 min,
  - c) *loadbearing walls, columns and arches* supporting an assembly required to have a *fire-resistance rating* shall
    - i) have a *fire-resistance rating* not less than 45 min, or
    - ii) be of *noncombustible construction*, and
  - d) *loadbearing walls, columns and arches* supporting a *fire separation* shall have a *fire-resistance rating* not less than that required for the *fire separation*.

### 3.2.2.23. Group A, Division 2, Any Height, Any Area, Sprinklered

- 1)** Except as permitted by Sentences 3.2.2.7.(3) and (4) and Articles 3.2.2.24. to 3.2.2.28., a *building* classified as Group A, Division 2 shall conform to Sentence (2).
- 2)** Except as permitted by Article 3.2.2.16., the *building* referred to in Sentence (1) shall be of *noncombustible construction*, and
- a) except as permitted by Sentences 3.2.2.7.(1) and 3.2.2.18.(2), the *building* shall be *sprinklered* throughout,
  - b) floor assemblies shall be *fire separations* with a *fire-resistance rating* not less than 2 h,
  - c) *mezzanines* shall have a *fire-resistance rating* not less than 1 h, and
  - d) *loadbearing walls, columns and arches* shall have a *fire-resistance rating* not less than that required for the supported assembly.

### 3.2.2.24. Group A, Division 2, up to 6 Storeys, Any Area, Sprinklered

- 1)** Except as permitted by Sentences 3.2.2.7.(3) and (4), a *building* classified as Group A, Division 2, that is not limited by *building area*, is permitted to conform to Sentence (2), provided
- a) except as permitted by Sentences 3.2.2.7.(1) and 3.2.2.18.(2), the *building* is *sprinklered* throughout, and
  - b) it is not more than 6 *storeys* in *building height*.
- 2)** Except as permitted by Article 3.2.2.16., the *building* referred to in Sentence (1) shall be of *noncombustible construction*, and
- a) floor assemblies shall be *fire separations* with a *fire-resistance rating* not less than 1 h,



- b) *mezzanines* shall have a *fire-resistance rating* not less than 1 h, and
- c) *loadbearing walls, columns and arches* shall have a *fire-resistance rating* not less than that required for the supported assembly.

**3.2.2.25. Group A, Division 2, up to 2 Storeys**

- 1) A *building* classified as Group A, Division 2 is permitted to conform to Sentence (2) provided
  - a) it is not more than 2 *storeys* in *building height*, and
  - b) it has a *building area* not more than the value in Table 3.2.2.25.

**Table 3.2.2.25.**  
**Maximum Building Area, Group A, Division 2, up to 2 Storeys**  
 Forming Part of Sentence 3.2.2.25.(1)

No. of Storeys	Maximum Area, m <sup>2</sup>		
	Facing 1 Street	Facing 2 Streets	Facing 3 Streets
1	1 600	2 000	2 400
2	800	1 000	1 200

- 2) The *building* referred to in Sentence (1) is permitted to be of *combustible construction* or *noncombustible construction* used singly or in combination, and
  - a) floor assemblies shall be *fire separations* and, if of *combustible construction*, shall have a *fire-resistance rating* not less than 45 min,
  - b) *mezzanines* shall have, if of *combustible construction*, a *fire-resistance rating* not less than 45 min,
  - c) roof assemblies shall have, if of *combustible construction*, a *fire-resistance rating* not less than 45 min, except that in a *building* not more than 1 *storey* in *building height*, the *fire-resistance rating* is permitted to be waived provided the roof assembly is constructed as a *fire-retardant-treated wood* roof system conforming to Article 3.1.14.1., and the *building area* is not more than
    - i) 800 m<sup>2</sup> if facing one *street*,
    - ii) 1 000 m<sup>2</sup> if facing 2 *streets*, or
    - iii) 1 200 m<sup>2</sup> if facing 3 *streets*, and
  - d) *loadbearing walls, columns and arches* supporting an assembly required to have a *fire-resistance rating* shall
    - i) have a *fire-resistance rating* not less than 45 min, or
    - ii) be of *noncombustible construction*.

**3.2.2.26. Group A, Division 2, up to 2 Storeys, Increased Area, Sprinklered**

- 1) A *building* classified as Group A, Division 2 is permitted to conform to Sentence (2) provided
  - a) except as permitted by Sentences 3.2.2.7.(1) and 3.2.2.18.(2), the *building* is *sprinklered* throughout,
  - b) it is not more than 2 *storeys* in *building height*, and
  - c) it has a *building area* not more than
    - i) 4 800 m<sup>2</sup> if 1 *storey* in *building height*, or
    - ii) 2 400 m<sup>2</sup> if 2 *storeys* in *building height*.

- 2) The *building* referred to in Sentence (1) is permitted to be of *combustible construction* or *noncombustible construction* used singly or in combination, and
  - a) floor assemblies shall be *fire separations* and, if of *combustible construction*, shall have a *fire-resistance rating* not less than 45 min,
  - b) *mezzanines* shall have, if of *combustible construction*, a *fire-resistance rating* not less than 45 min, and
  - c) *loadbearing walls, columns and arches* supporting an assembly required to have a *fire-resistance rating* shall
    - i) have a *fire-resistance rating* not less than 45 min, or
    - ii) be of *noncombustible construction*.

**3.2.2.27. Group A, Division 2, up to 2 Storeys, Sprinklered**

- 1)** A building classified as Group A, Division 2 is permitted to be of *combustible construction* or *noncombustible construction*, used singly or in combination, provided
- except as permitted by Sentences 3.2.2.7.(1) and 3.2.2.18.(2), the building is *sprinklered* throughout,
  - it is not more than 2 storeys in building height, and
  - it has a building area not more than
    - 2 400 m<sup>2</sup> if 1 storey in building height with no basement,
    - 1 200 m<sup>2</sup> if 1 storey in building height, or
    - 600 m<sup>2</sup> if 2 storeys in building height.

**3.2.2.28. Group A, Division 2, One Storey**

- 1)** A building classified as Group A, Division 2 is permitted to be of *combustible construction* or *noncombustible construction*, used singly or in combination, provided
- it is not more than 1 storey in building height, and
  - except as permitted by Sentence (2), it has a building area not more than
    - 400 m<sup>2</sup> if facing one street,
    - 500 m<sup>2</sup> if facing 2 streets, or
    - 600 m<sup>2</sup> if facing 3 streets.
- 2)** In a building referred to in Sentence (1) without a basement, the building area limits of Sentence (1) are permitted to be doubled provided a fire separation with a fire-resistance rating not less than 1 h is used to separate the building into fire compartments, each one of which does not exceed the limits of Clause (1)(b).

**3.2.2.29. Group A, Division 3, Any Height, Any Area, Sprinklered**

- 1)** Except as permitted by Articles 3.2.2.30. to 3.2.2.34., a building classified as Group A, Division 3 shall conform to Sentence (2).
- 2)** Except as permitted by Article 3.2.2.16., the building referred to in Sentence (1) shall be of *noncombustible construction*, and
- except as permitted by Sentences 3.2.2.7.(1) and 3.2.2.18.(2), the building shall be *sprinklered* throughout,
  - floor assemblies shall be fire separations with a fire-resistance rating not less than 2 h,
  - mezzanines shall have a fire-resistance rating not less than 1 h, and
  - loadbearing walls, columns and arches shall have a fire-resistance rating not less than that required for the supported assembly.

**3.2.2.30. Group A, Division 3, up to 2 Storeys**

- 1)** A building classified as Group A, Division 3 is permitted to conform to Sentence (2) provided
- it is not more than 2 storeys in building height, and
  - it has a building area not more than the value in Table 3.2.2.30.

**Table 3.2.2.30.**  
**Maximum Building Area, Group A, Division 3, up to 2 Storeys**  
 Forming Part of Sentence 3.2.2.30.(1)

No. of Storeys	Maximum Area, m <sup>2</sup>		
	Facing 1 Street	Facing 2 Streets	Facing 3 Streets
1	4 000	5 000	6 000
2	2 000	2 500	3 000

- 2)** Except as permitted by Clauses (c) and (d), the building referred to in Sentence (1) shall be of *noncombustible construction*, and
- floor assemblies shall be fire separations with a fire-resistance rating not less than 1 h,

- b) *mezzanines* shall have a *fire-resistance rating* not less than 1 h,
- c) roof assemblies shall
  - i) have a *fire-resistance rating* not less than 45 min, or
  - ii) be of *heavy timber construction*, and
- d) *loadbearing walls, columns and arches* shall have a *fire-resistance rating* not less than that required for the supported assembly, except that arches and structural members within the *storey* immediately below a roof assembly are permitted to be of *heavy timber construction*.

**3)** If intended for occasional use for trade shows and similar exhibition purposes, a *building* referred to in Sentence (1) that is more than 1 500 m<sup>2</sup> in *building area* shall be *sprinklered* throughout.

### 3.2.2.31. Group A, Division 3, up to 2 Storeys, Sprinklered

**1)** A *building* classified as Group A, Division 3 is permitted to conform to Sentence (2) provided

- a) except as permitted by Sentences 3.2.2.7.(1) and 3.2.2.18.(2), the *building* is *sprinklered* throughout,
- b) it is not more than 2 *storeys* in *building height*, and
- c) it has a *building area* not more than
  - i) 12 000 m<sup>2</sup> if 1 *storey* in *building height*, or
  - ii) 6 000 m<sup>2</sup> if 2 *storeys* in *building height*.

**2)** Except as permitted by Clause (c) and Article 3.2.2.16., the *building* referred to in Sentence (1) shall be of *noncombustible construction*, and

- a) floor assemblies shall be *fire separations* with a *fire-resistance rating* not less than 1 h,
- b) *mezzanines* shall have a *fire-resistance rating* not less than 1 h, and
- c) *loadbearing walls, columns and arches* shall have a *fire-resistance rating* not less than that required for the supported assembly, except that arches are permitted to be of *heavy timber construction*.

### 3.2.2.32. Group A, Division 3, One Storey, Increased Area

**1)** A *building* classified as Group A, Division 3 is permitted to conform to Sentence (2) provided

- a) it is not more than 1 *storey* in *building height*, and
- b) it has a *building area* not more than
  - i) 2 400 m<sup>2</sup> if facing one *street*,
  - ii) 3 000 m<sup>2</sup> if facing 2 *streets*, or
  - iii) 3 600 m<sup>2</sup> if facing 3 *streets*.

**2)** The *building* referred to in Sentence (1) is permitted to be of *combustible construction* or *noncombustible construction* used singly or in combination, and

- a) *mezzanines* shall have, if of *combustible construction*, a *fire-resistance rating* not less than 45 min,
- b) roof assemblies shall have, if of *combustible construction*, a *fire-resistance rating* not less than 45 min, except that the *fire-resistance rating* is permitted to be waived provided the roof assembly is constructed as a *fire-retardant-treated wood* roof system conforming to Article 3.1.14.1., and the *building area* is not more than
  - i) 1 200 m<sup>2</sup> if facing one *street*,
  - ii) 1 500 m<sup>2</sup> if facing 2 *streets*, or
  - iii) 1 800 m<sup>2</sup> if facing 3 *streets*, and
- c) *loadbearing walls, columns and arches* supporting an assembly required to have a *fire-resistance rating* shall
  - i) have a *fire-resistance rating* not less than 45 min, or
  - ii) be of *noncombustible construction*.

**3)** If intended for occasional use for trade shows and similar exhibition purposes, a *building* referred to in Sentence (1) that is more than 1 500 m<sup>2</sup> in *building area* shall be *sprinklered* throughout.

**3.2.2.33. Group A, Division 3, One Storey, Sprinklered**

- 1) A *building* classified as Group A, Division 3 is permitted to be of *combustible construction* or *noncombustible construction* used singly or in combination provided
- except as permitted by Sentences 3.2.2.7.(1) and 3.2.2.18.(2), the *building* is *sprinklered* throughout,
  - it is not more than 1 *storey* in *building height*, and
  - it has a *building area* not more than 7 200 m<sup>2</sup>.

**3.2.2.34. Group A, Division 3, One Storey**

- 1) A *building* classified as Group A, Division 3 is permitted to be of *combustible construction* or *noncombustible construction* used singly or in combination provided
- it is not more than 1 *storey* in *building height*, and
  - it has a *building area* not more than
    - 1 000 m<sup>2</sup> if facing one *street*,
    - 1 250 m<sup>2</sup> if facing 2 *streets*, or
    - 1 500 m<sup>2</sup> if facing 3 *streets*.

**3.2.2.35. Group A, Division 4**

- 1) Except as permitted by Sentences (2) and (3), a *building* classified as Group A, Division 4 shall be of *noncombustible construction*.
- 2) Roof assemblies and supporting arches and columns are permitted to be of *heavy timber construction*.
- 3) A *building* classified as Group A, Division 4 is permitted to be of *combustible construction* provided
- the *occupant load* is less than 1 500, and
  - the *building* has a *limiting distance* not less than 6 m.
- 4) Sprinklers shall be installed in all spaces below tiers of seats in a *building* classified as Group A, Division 4 if those spaces are used for *occupancy*. (See Note A-3.2.2.35.(4).)

**3.2.2.36. Group B, Division 1, Any Height, Any Area, Sprinklered**

- 1) Except as permitted by Article 3.2.2.37., a *building* classified as Group B, Division 1 shall conform to Sentence (2).
- 2) Except as permitted by Article 3.2.2.16., the *building* referred to in Sentence (1) shall be of *noncombustible construction*, and
- except as permitted by Sentences 3.2.2.7.(1) and 3.2.2.18.(2), the *building* shall be *sprinklered* throughout,
  - floor assemblies shall be *fire separations* with a *fire-resistance rating* not less than 2 h,
  - mezzanines* shall have a *fire-resistance rating* not less than 1 h, and
  - loadbearing* walls, columns and arches shall have a *fire-resistance rating* not less than that required for the supported assembly.

**3.2.2.37. Group B, Division 1, up to 3 Storeys, Sprinklered**

- 1) A *building* classified as Group B, Division 1 is permitted to conform to Sentence (2) provided
- except as permitted by Sentences 3.2.2.7.(1) and 3.2.2.18.(2), the *building* is *sprinklered* throughout,
  - it is not more than 3 *storeys* in *building height*, and
  - it has a *building area*
    - that is not limited if the *building* is not more than 1 *storey* in *building height*,
    - not more than 12 000 m<sup>2</sup> if 2 *storeys* in *building height*, or
    - not more than 8 000 m<sup>2</sup> if 3 *storeys* in *building height*.

- 2)** Except as permitted by Article 3.2.2.16., the *building* referred to in Sentence (1) shall be of *noncombustible construction*, and
  - a) floor assemblies shall be *fire separations* with a *fire-resistance rating* not less than 1 h,
  - b) *mezzanines* shall have a *fire-resistance rating* not less than 1 h, and
  - c) *loadbearing walls, columns and arches* shall have a *fire-resistance rating* not less than that required for the supported assembly.

**3.2.2.38. Group B, Division 2, Any Height, Any Area, Sprinklered**

- 1)** Except as permitted by Articles 3.2.2.39. to 3.2.2.41., a *building* classified as Group B, Division 2 shall conform to Sentence (2).
- 2)** Except as permitted by Article 3.2.2.16., the *building* referred to in Sentence (1) shall be of *noncombustible construction*, and
  - a) except as permitted by Sentences 3.2.2.7.(1) and 3.2.2.18.(2), the *building* shall be *sprinklered* throughout,
  - b) floor assemblies shall be *fire separations* with a *fire-resistance rating* not less than 2 h,
  - c) *mezzanines* shall have a *fire-resistance rating* not less than 1 h, and
  - d) *loadbearing walls, columns and arches* shall have a *fire-resistance rating* not less than that required for the supported assembly.

**3.2.2.39. Group B, Division 2, up to 3 Storeys, Sprinklered**

- 1)** A *building* classified as Group B, Division 2 is permitted to conform to Sentence (2) provided
  - a) except as permitted by Sentences 3.2.2.7.(1) and 3.2.2.18.(2), the *building* is *sprinklered* throughout,
  - b) it is not more than 3 *storeys* in *building height*, and
  - c) it has a *building area*
    - i) that is not limited if the *building* is not more than 1 *storey* in *building height*,
    - ii) not more than 12 000 m<sup>2</sup> if 2 *storeys* in *building height*, or
    - iii) not more than 8 000 m<sup>2</sup> if 3 *storeys* in *building height*.
- 2)** Except as permitted by Article 3.2.2.16., the *building* referred to in Sentence (1) shall be of *noncombustible construction*, and
  - a) floor assemblies shall be *fire separations* with a *fire-resistance rating* not less than 1 h,
  - b) *mezzanines* shall have a *fire-resistance rating* not less than 1 h, and
  - c) *loadbearing walls, columns and arches* shall have a *fire-resistance rating* not less than that required for the supported assembly.

**3.2.2.40. Group B, Division 2, up to 2 Storeys, Sprinklered**

- 1)** A *building* classified as Group B, Division 2 is permitted to conform to Sentence (2) provided
  - a) except as permitted by Sentences 3.2.2.7.(1) and 3.2.2.18.(2), the *building* is *sprinklered* throughout,
  - b) it is not more than 2 *storeys* in *building height*, and
  - c) it has a *building area* not more than
    - i) 2 400 m<sup>2</sup> if 1 *storey* in *building height*, or
    - ii) 1 600 m<sup>2</sup> if 2 *storeys* in *building height*.
- 2)** The *building* referred to in Sentence (1) is permitted to be of *combustible construction* or *noncombustible construction* used singly or in combination, and
  - a) floor assemblies shall be *fire separations* with a *fire-resistance rating* not less than 45 min,
  - b) *mezzanines* shall have, if of *combustible construction*, a *fire-resistance rating* not less than 45 min, and
  - c) *loadbearing walls, columns and arches* shall have a *fire-resistance rating* not less than that required for the supported assembly.

**3.2.2.41. Group B, Division 2, One Storey, Sprinklered**

**1)** A *building* classified as Group B, Division 2 is permitted to be of *combustible construction* or *noncombustible construction*, used singly or in combination, provided

- a) except as permitted by Sentences 3.2.2.7.(1) and 3.2.2.18.(2), the *building* is *sprinklered* throughout,
- b) it is not more than 1 *storey* in *building height*, and
- c) it has a *building area* not more than 500 m<sup>2</sup>.

**3.2.2.42. Group B, Division 3, Any Height, Any Area, Sprinklered**

**1)** Except as permitted by Articles 3.2.2.43. to 3.2.2.46., a *building* classified as Group B, Division 3 shall conform to Sentence (2).

**2)** Except as permitted by Article 3.2.2.16., the *building* referred to in Sentence (1) shall be of *noncombustible construction*, and

- a) except as permitted by Sentences 3.2.2.7.(1) and 3.2.2.18.(2), the *building* shall be *sprinklered* throughout,
- b) floor assemblies shall be *fire separations* with a *fire-resistance rating* not less than 2 h,
- c) *mezzanines* shall have a *fire-resistance rating* not less than 1 h, and
- d) *loadbearing walls*, columns and arches shall have a *fire-resistance rating* not less than that required for the supported assembly.

**3.2.2.43. Group B, Division 3, up to 3 Storeys (Noncombustible), Sprinklered**

**1)** A *building* classified as Group B, Division 3 is permitted to conform to Sentence (2) provided

- a) except as permitted by Sentences 3.2.2.7.(1) and 3.2.2.18.(2), the *building* is *sprinklered* throughout,
- b) it is not more than 3 *storeys* in *building height*, and
- c) it has a *building area*
  - i) that is not limited if the *building* is not more than 1 *storey* in *building height*,
  - ii) not more than 12 000 m<sup>2</sup> if 2 *storeys* in *building height*, or
  - iii) not more than 8 000 m<sup>2</sup> if 3 *storeys* in *building height*.

**2)** Except as permitted by Article 3.2.2.16., the *building* referred to in Sentence (1) shall be of *noncombustible construction*, and

- a) floor assemblies shall be *fire separations* with a *fire-resistance rating* not less than 1 h,
- b) *mezzanines* shall have a *fire-resistance rating* not less than 1 h, and
- c) *loadbearing walls*, columns and arches shall have a *fire-resistance rating* not less than that required for the supported assembly.

**3.2.2.44. Group B, Division 3, up to 3 Storeys, Sprinklered**

**1)** A *building* classified as Group B, Division 3 is permitted to conform to Sentence (2) provided

- a) except as permitted by Sentences 3.2.2.7.(1) and 3.2.2.18.(2), the *building* is *sprinklered* throughout,
- b) it is not more than 3 *storeys* in *building height*, and
- c) it has a *building area* not more than
  - i) 5 400 m<sup>2</sup> if 1 *storey* in *building height*,
  - ii) 2 700 m<sup>2</sup> if 2 *storeys* in *building height*, or
  - iii) 1 800 m<sup>2</sup> if 3 *storeys* in *building height*.

**2)** The *building* referred to in Sentence (1) is permitted to be of *combustible construction* or *noncombustible construction*, used singly or in combination, and

- a) floor assemblies shall be *fire separations* with a *fire-resistance rating* not less than 1 h,
- b) *mezzanines* shall have a *fire-resistance rating* not less than 1 h, and
- c) *loadbearing walls*, columns and arches shall have a *fire-resistance rating* not less than that required for the supported assembly.

**3.2.2.45. Group B, Division 3, up to 2 Storeys, Sprinklered**

- 1)** A *building* classified as Group B, Division 3 is permitted to conform to Sentence (2) provided
- a) except as permitted by Sentences 3.2.2.7.(1) and 3.2.2.18.(2), the *building* is *sprinklered* throughout,
  - b) it is not more than 2 *storeys* in *building height*, and
  - c) it has a *building area* not more than
    - i) 2 400 m<sup>2</sup> if 1 *storey* in *building height*, or
    - ii) 1 600 m<sup>2</sup> if 2 *storeys* in *building height*.
- 2)** The *building* referred to in Sentence (1) is permitted to be of *combustible construction* or *noncombustible construction*, used singly or in combination, and
- a) floor assemblies shall be *fire separations* with a *fire-resistance rating* not less than 45 min,
  - b) *mezzanines* shall have, if of *combustible construction*, a *fire-resistance rating* not less than 45 min, and
  - c) *loadbearing walls*, columns and arches shall have a *fire-resistance rating* not less than that required for the supported assembly.

**3.2.2.46. Group B, Division 3, One Storey, Sprinklered**

- 1)** A *building* classified as Group B, Division 3 is permitted to be of *combustible construction* or *noncombustible construction*, used singly or in combination, provided
- a) except as permitted by Sentences 3.2.2.7.(1) and 3.2.2.18.(2), the *building* is *sprinklered* throughout,
  - b) it is not more than 1 *storey* in *building height*, and
  - c) it has a *building area* not more than 600 m<sup>2</sup>.

**3.2.2.47. Group C, Any Height, Any Area, Sprinklered**

- 1)** Except as permitted by Articles 3.2.2.48. to 3.2.2.54., a *building* classified as Group C shall conform to Sentence (2).
- 2)** Except as permitted by Article 3.2.2.16., the *building* referred to in Sentence (1) shall be of *noncombustible construction*, and
- a) except as permitted by Sentences 3.2.2.7.(1) and 3.2.2.18.(2), the *building* shall be *sprinklered* throughout,
  - b) except as permitted by Sentence (3), floor assemblies shall be *fire separations* with a *fire-resistance rating* not less than 2 h,
  - c) *mezzanines* shall have a *fire-resistance rating* not less than 1 h, and
  - d) *loadbearing walls*, columns and arches shall have a *fire-resistance rating* not less than that required for the supported assembly.
- 3)** In a *building* that contains *dwelling units* that have more than one *storey*, subject to the requirements of Sentence 3.3.4.2.(3), the floor assemblies, including floors over *basements*, which are entirely contained within these *dwelling units*, shall have a *fire-resistance rating* not less than 1 h but need not be constructed as *fire separations*.

**3.2.2.48. Group C, up to 6 Storeys, Sprinklered, Noncombustible Construction**

- 1)** A *building* classified as Group C is permitted to conform to Sentence (2) provided
- a) except as permitted by Sentences 3.2.2.7.(1) and 3.2.2.18.(2), the *building* is *sprinklered* throughout,
  - b) it is not more than 6 *storeys* in *building height*, and
  - c) it has a *building area*
    - i) that is not limited if the *building* is not more than 2 *storeys* in *building height*,
    - ii) not more than 12 000 m<sup>2</sup> if 3 *storeys* in *building height*,
    - iii) not more than 9 000 m<sup>2</sup> if 4 *storeys* in *building height*,
    - iv) not more than 7 200 m<sup>2</sup> if 5 *storeys* in *building height*, or
    - v) not more than 6 000 m<sup>2</sup> if 6 *storeys* in *building height*.

**2)** Except as permitted by Article 3.2.2.16., the *building* referred to in Sentence (1) shall be of *noncombustible construction*, and

- a) except as permitted by Sentence (3), floor assemblies shall be *fire separations* with a *fire-resistance rating* not less than 1 h,
- b) *mezzanines* shall have a *fire-resistance rating* not less than 1 h, and
- c) *loadbearing walls*, columns and arches shall have a *fire-resistance rating* not less than that required for the supported assembly.

**3)** In a *building* that contains *dwelling units* that have more than one *storey*, subject to the requirements of Sentence 3.3.4.2.(3), the floor assemblies, including floors over *basements*, which are entirely contained within these *dwelling units*, shall have a *fire-resistance rating* not less than 1 h but need not be constructed as *fire separations*.

### 3.2.2.49. Group C, up to 3 Storeys, Noncombustible Construction

**1)** A *building* classified as Group C is permitted to conform to Sentence (2) provided

- a) it is not more than 3 *storeys* in *building height*, and
- b) it has a *building area* not more than the value in Table 3.2.2.49.

**Table 3.2.2.49.**  
**Maximum Building Area, Group C, up to 3 Storeys**  
 Forming Part of Sentence 3.2.2.49.(1)

No. of Storeys	Maximum Area, m <sup>2</sup>		
	Facing 1 Street	Facing 2 Streets	Facing 3 Streets
1	not limited	not limited	not limited
2	6 000	not limited	not limited
3	4 000	5 000	6 000

**2)** The *building* referred to in Sentence (1) shall be of *noncombustible construction*, and

- a) except as permitted by Sentence (3), floor assemblies shall be *fire separations* with a *fire-resistance rating* not less than 1 h,
- b) *mezzanines* shall have a *fire-resistance rating* not less than 1 h,
- c) roof assemblies shall have a *fire-resistance rating* not less than 1 h, and
- d) *loadbearing walls*, columns and arches shall have a *fire-resistance rating* not less than that required for the supported assembly.

**3)** In a *building* that contains *dwelling units* that have more than one *storey*, subject to the requirements of Sentence 3.3.4.2.(3), the floor assemblies, including floors over *basements*, which are entirely contained within these *dwelling units*, shall have a *fire-resistance rating* not less than 1 h but need not be constructed as *fire separations*.

### 3.2.2.50. Group C, up to 6 Storeys, Sprinklered

**1)** A *building* classified as Group C is permitted to conform to Sentence (2), provided

- a) it is *sprinklered* throughout,
- b) it is not more than 6 *storeys* in *building height*,
- c) it has a height not more than 18 m measured between the floor of the *first storey* and the uppermost floor level that does not serve a rooftop enclosure for elevator machinery, a stairway or a *service room* used only for service to the *building*, and
- d) it has a *building area* not more than
  - i) 9 000 m<sup>2</sup> if 1 *storey* in *building height*,
  - ii) 4 500 m<sup>2</sup> if 2 *storeys* in *building height*,
  - iii) 3 000 m<sup>2</sup> if 3 *storeys* in *building height*,
  - iv) 2 250 m<sup>2</sup> if 4 *storeys* in *building height*,
  - v) 1 800 m<sup>2</sup> if 5 *storeys* in *building height*, or
  - vi) 1 500 m<sup>2</sup> if 6 *storeys* in *building height*.



- 2)** Buildings referred to in Sentence (1) are permitted to be of *combustible construction* or *noncombustible construction*, used singly or in combination, and
- except as provided in Sentence (3), floor assemblies shall be *fire separations* with a *fire-resistance rating* not less than 1 h,
  - roof assemblies shall have a *fire-resistance rating* not less than 1 h,
  - except as provided in Sentence (4), where the roof assembly has a height greater than 25 m measured from the floor of the *first storey* to the highest point of the roof assembly, the roof assembly shall be constructed of *noncombustible construction* or *fire-retardant-treated wood* conforming to Article 3.1.4.5.,
  - mezzanines* shall have a *fire-resistance rating* not less than 1 h, and
  - loadbearing walls, columns and arches* shall have a *fire-resistance rating* not less than that required for the supported assembly.
- 3)** In a *building* that contains *dwelling units* that have more than one *storey*, subject to the requirements of Sentence 3.3.4.2.(3), the floor assemblies, including those over *basements*, that are entirely contained within these *dwelling units* shall have a *fire-resistance rating* not less than 1 h but need not be constructed as *fire separations*.
- 4)** Where *buildings* conforming to Sentence (2) include non-contiguous roof assemblies at different elevations, the roof assemblies are permitted to be evaluated separately to determine which ones are required to be constructed in accordance with Clause (2)(c).

### 3.2.2.51. Group C, up to 4 Storeys, Sprinklered

- 1)** A *building* classified as Group C is permitted to conform to Sentence (2) provided
- except as permitted by Sentences 3.2.2.7.(1) and 3.2.2.18.(2), the *building* is *sprinklered* throughout,
  - it is not more than 4 *storeys* in *building height*, and
  - it has a *building area* not more than
    - 7 200 m<sup>2</sup> if 1 *storey* in *building height*,
    - 3 600 m<sup>2</sup> if 2 *storeys* in *building height*,
    - 2 400 m<sup>2</sup> if 3 *storeys* in *building height*, or
    - 1 800 m<sup>2</sup> if 4 *storeys* in *building height*.
- 2)** The *building* referred to in Sentence (1) is permitted to be of *combustible construction* or *noncombustible construction* used singly or in combination, and
- except as permitted by Sentences (3) and (4), floor assemblies shall be *fire separations* with a *fire-resistance rating* not less than 1 h,
  - mezzanines* shall have a *fire-resistance rating* not less than 1 h, and
  - loadbearing walls, columns and arches* shall have a *fire-resistance rating* not less than that required for the supported assembly.
- 3)** In a *building* that contains *dwelling units* that have more than one *storey*, subject to the requirements of Sentence 3.3.4.2.(3), the floor assemblies, including floors over *basements*, which are entirely contained within these *dwelling units*, shall have a *fire-resistance rating* not less than 1 h but need not be constructed as *fire separations*.
- 4)** In a *building* in which there is no *dwelling unit* above another *dwelling unit*, the *fire-resistance rating* for floor assemblies entirely within the *dwelling unit* is waived.

### 3.2.2.52. Group C, up to 3 Storeys, Increased Area

- 1)** A *building* classified as Group C is permitted to conform to Sentence (2) provided
- it is not more than 3 *storeys* in *building height*, and
  - it has a *building area* not more than the value in Table 3.2.2.52.

**Table 3.2.2.52.**  
**Maximum Building Area, Group C, up to 3 Storeys, Increased Area**  
 Forming Part of Sentence 3.2.2.52.(1)

No. of Storeys	Maximum Area, m <sup>2</sup>		
	Facing 1 Street	Facing 2 Streets	Facing 3 Streets
1	2 400	3 000	3 600
2	1 200	1 500	1 800
3	800	1 000	1 200

- 2)** The *building* referred to in Sentence (1) is permitted to be of *combustible construction* or *noncombustible construction* used singly or in combination, and
- except as permitted by Sentences (3) and (4), floor assemblies shall be *fire separations* with a *fire-resistance rating* not less than 1 h,
  - mezzanines* shall have a *fire-resistance rating* not less than 1 h,
  - roof assemblies shall have a *fire-resistance rating* not less than 1 h, and
  - loadbearing walls, columns, and arches* shall have a *fire-resistance rating* not less than that required for the supported assembly.

**3)** In a *building* that contains *dwelling units* that have more than one *storey*, subject to the requirements of Sentence 3.3.4.2.(3), the floor assemblies, including floors over *basements*, which are entirely contained within these *dwelling units*, shall have a *fire-resistance rating* not less than 1 h but need not be constructed as *fire separations*.

**4)** In a *building* in which there is no *dwelling unit* above another *dwelling unit*, the *fire-resistance rating* for floor assemblies entirely within the *dwelling unit* is waived.

### 3.2.2.53. Group C, up to 3 Storeys

- 1)** A *building* classified as Group C is permitted to conform to Sentence (2) provided
- it is not more than 3 *storeys* in *building height*, and
  - it has a *building area* not more than the value in Table 3.2.2.53.

**Table 3.2.2.53.**  
**Maximum Building Area, Group C, up to 3 Storeys**  
 Forming Part of Sentence 3.2.2.53.(1)

No. of Storeys	Maximum Area, m <sup>2</sup>		
	Facing 1 Street	Facing 2 Streets	Facing 3 Streets
1	1 800	2 250	2 700
2	900	1 125	1 350
3	600	750	900

- 2)** The *building* referred to in Sentence (1) is permitted to be of *combustible construction* or *noncombustible construction* used singly or in combination, and
- except as permitted by Sentences (3) and (4), floor assemblies shall be *fire separations* with a *fire-resistance rating* not less than 45 min,
  - mezzanines* shall have, if of *combustible construction*, a *fire-resistance rating* not less than 45 min, and
  - loadbearing walls, columns and arches* shall have a *fire-resistance rating* not less than that required for the supported assembly.

**3)** In a *building* that contains *dwelling units* that have more than one *storey*, subject to the requirements of Sentence 3.3.4.2.(3), the floor assemblies, including floors over *basements*, which are entirely contained within these *dwelling units*, shall have a *fire-resistance rating* not less than 45 min but need not be constructed as *fire separations*.

4) In a *building* in which there is no *dwelling unit* above another *dwelling unit*, the *fire-resistance rating* for floor assemblies entirely within the *dwelling unit* is waived.

#### 3.2.2.54. Group C, up to 3 Storeys, Sprinklered

- 1) A *building* classified as Group C is permitted to conform to Sentence (2) provided
- except as permitted by Sentences 3.2.2.7.(1) and 3.2.2.18.(2), the *building* is *sprinklered* throughout,
  - it is not more than 3 *storeys* in *building height*, and
  - it has a *building area* not more than
    - 5 400 m<sup>2</sup> if 1 *storey* in *building height*,
    - 2 700 m<sup>2</sup> if 2 *storeys* in *building height*, or
    - 1 800 m<sup>2</sup> if 3 *storeys* in *building height*.
- 2) The *building* referred to in Sentence (1) is permitted to be of *combustible construction* or *noncombustible construction* used singly or in combination, and
- except as permitted by Sentences (3) and (4), floor assemblies shall be *fire separations* with a *fire-resistance rating* not less than 45 min,
  - mezzanines* shall have, if of *combustible construction*, a *fire-resistance rating* not less than 45 min, and
  - loadbearing walls*, columns and arches shall have a *fire-resistance rating* not less than that required for the supported assembly.
- 3) In a *building* that contains *dwelling units* that have more than one *storey*, subject to the requirements of Sentence 3.3.4.2.(3), the floor assemblies, including floors over *basements*, which are entirely contained within these *dwelling units*, shall have a *fire-resistance rating* not less than 45 min but need not be constructed as *fire separations*.
- 4) In a *building* in which there is no *dwelling unit* above another *dwelling unit*, the *fire-resistance rating* for floor assemblies entirely within the *dwelling unit* is waived.

#### 3.2.2.55. Group D, Any Height, Any Area, Sprinklered

- 1) Except as permitted by Articles 3.2.2.56. to 3.2.2.63., a *building* classified as Group D shall conform to Sentence (2).
- 2) Except as permitted by Article 3.2.2.16., the *building* referred to in Sentence (1) shall be of *noncombustible construction*, and
- except as permitted by Sentences 3.2.2.7.(1) and 3.2.2.18.(2), the *building* shall be *sprinklered* throughout,
  - floor assemblies shall be *fire separations* with a *fire-resistance rating* not less than 2 h,
  - mezzanines* shall have a *fire-resistance rating* not less than 1 h, and
  - loadbearing walls*, columns and arches shall have a *fire-resistance rating* not less than that required for the supported assembly.

#### 3.2.2.56. Group D, up to 6 Storeys

- 1) A *building* classified as Group D is permitted to conform to Sentence (2) provided
- it is not more than 6 *storeys* in *building height*, and
  - it has a *building area* not more than the value in Table 3.2.2.56.

**Table 3.2.2.56.**  
**Maximum Building Area, Group D, up to 6 Storeys**  
 Forming Part of Sentence 3.2.2.56.(1)

No. of Storeys	Maximum Area, m <sup>2</sup>		
	Facing 1 Street	Facing 2 Streets	Facing 3 Streets
1	not limited	not limited	not limited
2	7 200	not limited	not limited
3	4 800	6 000	7 200
4	3 600	4 500	5 400
5	2 880	3 600	4 320
6	2 400	3 000	3 600

- 2)** The *building* referred to in Sentence (1) shall be of *noncombustible construction*, and
- floor assemblies shall be *fire separations* with a *fire-resistance rating* not less than 1 h,
  - mezzanines* shall have a *fire-resistance rating* not less than 1 h,
  - roof assemblies shall have a *fire-resistance rating* not less than 1 h, except that in a *building* not more than 1 *storey* in *building height* this requirement is waived, and
  - loadbearing* walls, columns and arches shall have a *fire-resistance rating* not less than that required for the supported assembly.

### 3.2.2.57. Group D, up to 6 Storeys, Sprinklered, Noncombustible Construction

- 1)** A *building* classified as Group D is permitted to conform to Sentence (2) provided
- except as permitted by Sentences 3.2.2.7.(1) and 3.2.2.18.(2), the *building* is *sprinklered* throughout,
  - it is not more than 6 *storeys* in *building height*, and
  - it has a *building area*
    - that is not limited if the *building* is not more than 2 *storeys* in *building height*,
    - not more than 14 400 m<sup>2</sup> if 3 *storeys* in *building height*,
    - not more than 10 800 m<sup>2</sup> if 4 *storeys* in *building height*,
    - not more than 8 640 m<sup>2</sup> if 5 *storeys* in *building height*, or
    - not more than 7 200 m<sup>2</sup> if 6 *storeys* in *building height*.
- 2)** Except as permitted by Article 3.2.2.16., the *building* referred to in Sentence (1) shall be of *noncombustible construction*, and
- floor assemblies shall be *fire separations* with a *fire-resistance rating* not less than 1 h,
  - mezzanines* shall have a *fire-resistance rating* not less than 1 h, and
  - loadbearing* walls, columns and arches shall have a *fire-resistance rating* not less than that required for the supported assembly.

### 3.2.2.58. Group D, up to 6 Storeys, Sprinklered

- 1)** A *building* classified as Group D is permitted to conform to Sentence (2), provided
- it is *sprinklered* throughout,
  - it is not more than 6 *storeys* in *building height*,
  - it has a height not more than 18 m measured between the floor of the *first storey* and the uppermost floor level that does not serve a rooftop enclosure for elevator machinery, a stairway or a *service room* used only for service to the *building*, and
  - it has a *building area* not more than
    - 18 000 m<sup>2</sup> if 1 *storey* in *building height*,
    - 9 000 m<sup>2</sup> if 2 *storeys* in *building height*,

- iii) 6 000 m<sup>2</sup> if 3 storeys in building height,
- iv) 4 500 m<sup>2</sup> if 4 storeys in building height,
- v) 3 600 m<sup>2</sup> if 5 storeys in building height, or
- vi) 3 000 m<sup>2</sup> if 6 storeys in building height.

- 2)** The building referred to in Sentence (1) is permitted to be of *combustible construction* or *noncombustible construction*, used singly or in combination, and
- a) floor assemblies shall be *fire separations* with a *fire-resistance rating* not less than 1 h,
  - b) roof assemblies shall have a *fire-resistance rating* not less than 1 h,
  - c) except as provided in Sentence (3), where the roof assembly has a height greater than 25 m measured from the floor of the *first storey* to the highest point of the roof assembly, the roof assembly shall be constructed of *noncombustible construction* or *fire-retardant-treated wood* conforming to Article 3.1.4.5.,
  - d) *mezzanines* shall have a *fire-resistance rating* not less than 1 h, and
  - e) *loadbearing walls*, columns and arches shall have a *fire-resistance rating* not less than that required for the supported assembly.

**3)** Where buildings conforming to Sentence (2) include non-contiguous roof assemblies at different elevations, the roof assemblies are permitted to be evaluated separately to determine which ones are required to be constructed in accordance with Clause (2)(c).

**3.2.2.59. Group D, up to 4 Storeys, Sprinklered**

- 1)** A building classified as Group D is permitted to conform to Sentence (2) provided
- a) except as permitted by Sentences 3.2.2.7.(1) and 3.2.2.18.(2), the building is *sprinklered* throughout,
  - b) it is not more than 4 storeys in building height, and
  - c) it has a *building area* not more than 3 600 m<sup>2</sup>.
- 2)** The building referred to in Sentence (1) is permitted to be of *combustible construction* or *noncombustible construction* used singly or in combination, and
- a) floor assemblies shall be *fire separations* with a *fire-resistance rating* not less than 1 h,
  - b) *mezzanines* shall have a *fire-resistance rating* not less than 1 h, and
  - c) *loadbearing walls*, columns and arches shall have a *fire-resistance rating* not less than that required for the supported assembly.

**3.2.2.60. Group D, up to 3 Storeys**

- 1)** A building classified as Group D is permitted to conform to Sentence (2) provided
- a) it is not more than 3 storeys in building height, and
  - b) it has a *building area* not more than the value in Table 3.2.2.60.

**Table 3.2.2.60.**  
**Maximum Building Area, Group D, up to 3 Storeys**  
 Forming Part of Sentence 3.2.2.60.(1)

No. of Storeys	Maximum Area, m <sup>2</sup>		
	Facing 1 Street	Facing 2 Streets	Facing 3 Streets
1	4 800	6 000	7 200
2	2 400	3 000	3 600
3	1 600	2 000	2 400

- 2)** The *building* referred to in Sentence (1) is permitted to be of *combustible construction* or *noncombustible construction* used singly or in combination, and
- floor assemblies shall be *fire separations* and, if of *combustible construction*, shall have a *fire-resistance rating* not less than 45 min,
  - mezzanines* shall have, if of *combustible construction*, a *fire-resistance rating* not less than 45 min,
  - roof assemblies shall have, if of *combustible construction*, a *fire-resistance rating* not less than 45 min, except that in a *building* not more than 1 *storey* in *building height*, the *fire-resistance rating* is permitted to be waived provided the roof assembly is constructed as a *fire-retardant-treated wood* roof system conforming to Article 3.1.14.1. and the *building area* is not more than
    - 2 400 m<sup>2</sup> if facing one *street*,
    - 3 000 m<sup>2</sup> if facing 2 *streets*, or
    - 3 600 m<sup>2</sup> if facing 3 *streets*, and
  - loadbearing walls*, columns and arches supporting an assembly required to have a *fire-resistance rating* shall
    - have a *fire-resistance rating* not less than 45 min, or
    - be of *noncombustible construction*.

### 3.2.2.61. Group D, up to 3 Storeys, Sprinklered

- 1)** A *building* classified as Group D is permitted to conform to Sentence (2) provided
- except as permitted by Sentences 3.2.2.7.(1) and 3.2.2.18.(2), the *building* is *sprinklered* throughout,
  - it is not more than 3 *storeys* in *building height*, and
  - it has a *building area* not more than
    - 14 400 m<sup>2</sup> if 1 *storey* in *building height*,
    - 7 200 m<sup>2</sup> if 2 *storeys* in *building height*, or
    - 4 800 m<sup>2</sup> if 3 *storeys* in *building height*.
- 2)** The *building* referred to in Sentence (1) is permitted to be of *combustible construction* or *noncombustible construction* used singly or in combination, and
- floor assemblies shall be *fire separations* and, if of *combustible construction*, shall have a *fire-resistance rating* not less than 45 min,
  - mezzanines* shall have, if of *combustible construction*, a *fire-resistance rating* not less than 45 min, and
  - loadbearing walls*, columns and arches supporting an assembly required to have a *fire-resistance rating* shall
    - have a *fire-resistance rating* not less than 45 min, or
    - be of *noncombustible construction*.

### 3.2.2.62. Group D, up to 2 Storeys

- 1)** A *building* classified as Group D is permitted to conform to Sentence (2) provided
- it is not more than 2 *storeys* in *building height*, and
  - it has a *building area* not more than the value in Table 3.2.2.62.

**Table 3.2.2.62.**  
**Maximum Building Area, Group D, up to 2 Storeys**  
 Forming Part of Sentence 3.2.2.62.(1)

No. of Storeys	Maximum Area, m <sup>2</sup>		
	Facing 1 Street	Facing 2 Streets	Facing 3 Streets
1	1 000	1 250	1 500
2	800	1 000	1 200

- 2)** The *building* referred to in Sentence (1) is permitted to be of *combustible construction* or *noncombustible construction* used singly or in combination, and
- a) floor assemblies shall be *fire separations* and, if of *combustible construction*, shall have a *fire-resistance rating* not less than 45 min, and
  - b) *loadbearing walls*, columns and arches supporting an assembly required to have a *fire-resistance rating* shall
    - i) have a *fire-resistance rating* not less than 45 min, or
    - ii) be of *noncombustible construction*.

### 3.2.2.63. Group D, up to 2 Storeys, Sprinklered

- 1)** A *building* classified as Group D is permitted to conform to Sentence (2) provided
- a) except as permitted by Sentences 3.2.2.7.(1) and 3.2.2.18.(2), the *building* is *sprinklered* throughout,
  - b) it is not more than 2 *storeys* in *building height*, and
  - c) it has a *building area* not more than
    - i) 3 000 m<sup>2</sup> if 1 *storey* in *building height*, or
    - ii) 2 400 m<sup>2</sup> if 2 *storeys* in *building height*.
- 2)** The *building* referred to in Sentence (1) is permitted to be of *combustible construction* or *noncombustible construction* used singly or in combination, and
- a) floor assemblies shall be *fire separations* and, if of *combustible construction*, shall have a *fire-resistance rating* not less than 45 min, and
  - b) *loadbearing walls*, columns and arches supporting an assembly required to have a *fire-resistance rating* shall
    - i) have a *fire-resistance rating* not less than 45 min, or
    - ii) be of *noncombustible construction*.

### 3.2.2.64. Group E, Any Height, Any Area, Sprinklered

- 1)** Except as permitted by Sentences 3.2.2.7.(3) and (4) and Articles 3.2.2.65. to 3.2.2.69., a *building* classified as Group E shall conform to Sentence (2).
- 2)** Except as permitted by Article 3.2.2.16., the *building* referred to in Sentence (1) shall be of *noncombustible construction*, and
- a) except as permitted by Sentences 3.2.2.7.(1) and 3.2.2.18.(2), the *building* shall be *sprinklered* throughout,
  - b) floor assemblies shall be *fire separations* with a *fire-resistance rating* not less than 2 h,
  - c) *mezzanines* shall have a *fire-resistance rating* not less than 1 h, and
  - d) *loadbearing walls*, columns and arches shall have a *fire-resistance rating* not less than that required for the supported assembly.

### 3.2.2.65. Group E, up to 4 Storeys, Sprinklered

- 1)** A *building* classified as Group E is permitted to conform to Sentence (2) provided
- a) except as permitted by Sentences 3.2.2.7.(1) and 3.2.2.18.(2), the *building* is *sprinklered* throughout,
  - b) it is not more than 4 *storeys* in *building height*, and
  - c) it has a *building area* not more than 1 800 m<sup>2</sup>.
- 2)** The *building* referred to in Sentence (1) is permitted to be of *combustible construction* or *noncombustible construction* used singly or in combination, and
- a) floor assemblies shall be *fire separations* with a *fire-resistance rating* not less than 1 h,
  - b) *mezzanines* shall have a *fire-resistance rating* not less than 1 h, and
  - c) *loadbearing walls*, columns and arches shall have a *fire-resistance rating* not less than that required for the supported assembly.

**3.2.2.66. Group E, up to 3 Storeys**

- 1)** A *building* classified as Group E is permitted to conform to Sentence (2) provided
- it is not more than 3 *storeys* in *building height*, and
  - it has a *building area* not more than the value in Table 3.2.2.66.

**Table 3.2.2.66.**  
**Maximum Building Area, Group E, up to 3 Storeys**  
 Forming Part of Sentence 3.2.2.66.(1)

No. of Storeys	Maximum Area, m <sup>2</sup>		
	Facing 1 Street	Facing 2 Streets	Facing 3 Streets
1	1 500	1 500	1 500
2	1 200	1 500	1 500
3	800	1 000	1 500

- 2)** The *building* referred to in Sentence (1) is permitted to be of *combustible construction* or *noncombustible construction* used singly or in combination, and
- floor assemblies shall be *fire separations* with a *fire-resistance rating* not less than 45 min,
  - mezzanines* shall have, if of *combustible construction*, a *fire-resistance rating* not less than 45 min,
  - roof assemblies shall have a *fire-resistance rating* not less than 45 min, except that in a *building* not more than 1 *storey* in *building height*, the *fire-resistance rating* is permitted to be waived provided the roof assembly is of *noncombustible construction* or is constructed as a *fire-retardant-treated wood* roof system conforming to Article 3.1.14.1.,
  - loadbearing walls*, columns and arches supporting an assembly required to have a *fire-resistance rating* shall
    - have a *fire-resistance rating* not less than 45 min, or
    - be of *noncombustible construction*, and
  - loadbearing walls*, columns and arches supporting a *fire separation* shall have a *fire-resistance rating* not less than that required for the *fire separation*.

**3.2.2.67. Group E, up to 3 Storeys, Sprinklered**

- 1)** A *building* classified as Group E is permitted to conform to Sentence (2) provided
- except as permitted by Sentences 3.2.2.7.(1) and 3.2.2.18.(2), the *building* is *sprinklered* throughout,
  - it is not more than 3 *storeys* in *building height*, and
  - it has a *building area* not more than
    - 7 200 m<sup>2</sup> if 1 *storey* in *building height*,
    - 3 600 m<sup>2</sup> if 2 *storeys* in *building height*, or
    - 2 400 m<sup>2</sup> if 3 *storeys* in *building height*.

- 2)** The *building* referred to in Sentence (1) is permitted to be of *combustible construction* or *noncombustible construction* used singly or in combination, and
- floor assemblies shall be *fire separations* with a *fire-resistance rating* not less than 45 min,
  - mezzanines* shall have, if of *combustible construction*, a *fire-resistance rating* not less than 45 min,
  - loadbearing walls*, columns and arches supporting an assembly required to have a *fire-resistance rating* shall
    - have a *fire-resistance rating* not less than 45 min, or
    - be of *noncombustible construction*, and
  - loadbearing walls*, columns and arches supporting a *fire separation* shall have a *fire-resistance rating* not less than that required for the *fire separation*.



**3.2.2.68. Group E, up to 2 Storeys**

- 1)** A *building* classified as Group E is permitted to conform to Sentence (2) provided
- a) it is not more than 2 *storeys* in *building height*, and
  - b) it has a *building area* not more than the value in Table 3.2.2.68.

**Table 3.2.2.68.**  
**Maximum Building Area, Group E, up to 2 Storeys**  
 Forming Part of Sentence 3.2.2.68.(1)

No. of Storeys	Maximum Area, m <sup>2</sup>		
	Facing 1 <i>Street</i>	Facing 2 <i>Streets</i>	Facing 3 <i>Streets</i>
1	1 000	1 250	1 500
2	600	750	900

- 2)** The *building* referred to in Sentence (1) is permitted to be of *combustible construction* or *noncombustible construction* used singly or in combination, and
- a) floor assemblies shall be *fire separations* with a *fire-resistance rating* not less than 45 min, and
  - b) *loadbearing walls*, columns and arches shall have a *fire-resistance rating* not less than that required for the supported assembly.

**3.2.2.69. Group E, up to 2 Storeys, Sprinklered**

- 1)** A *building* classified as Group E is permitted to conform to Sentence (2) provided
- a) except as permitted by Sentences 3.2.2.7.(1) and 3.2.2.18.(2), the *building* is *sprinklered* throughout,
  - b) it is not more than 2 *storeys* in *building height*, and
  - c) it has a *building area* not more than
    - i) 3 000 m<sup>2</sup> if 1 *storey* in *building height*, or
    - ii) 1 800 m<sup>2</sup> if 2 *storeys* in *building height*.
- 2)** The *building* referred to in Sentence (1) is permitted to be of *combustible construction* or *noncombustible construction* used singly or in combination, and
- a) floor assemblies shall be *fire separations* with a *fire-resistance rating* not less than 45 min, and
  - b) *loadbearing walls*, columns and arches shall have a *fire-resistance rating* not less than that required for the supported assembly.

**3.2.2.70. Group F, Division 1, up to 4 Storeys, Sprinklered**

- 1)** Except as permitted by Articles 3.2.2.71. to 3.2.2.73., a *building* classified as Group F, Division 1 shall conform to Sentence (2) provided
- a) it is not more than 4 *storeys* in *building height*, and
  - b) it has a *building area* not more than
    - i) 9 000 m<sup>2</sup> if 1 *storey* in *building height*,
    - ii) 4 500 m<sup>2</sup> if 2 *storeys* in *building height*,
    - iii) 3 000 m<sup>2</sup> if 3 *storeys* in *building height*, or
    - iv) 2 250 m<sup>2</sup> if 4 *storeys* in *building height*.
- 2)** Except as permitted by Article 3.2.2.16., the *building* referred to in Sentence (1) shall be of *noncombustible construction*, and
- a) except as permitted by Sentences 3.2.2.7.(1) and 3.2.2.18.(2), the *building* shall be *sprinklered* throughout,
  - b) floor assemblies shall be *fire separations* with a *fire-resistance rating* not less than 2 h,
  - c) *mezzanines* shall have a *fire-resistance rating* not less than 1 h, and
  - d) *loadbearing walls*, columns and arches shall have a *fire-resistance rating* not less than that required for the supported assembly.

**3.2.2.71. Group F, Division 1, up to 3 Storeys, Sprinklered**

- 1)** A *building* classified as Group F, Division 1 is permitted to conform to Sentence (2) provided
- a) except as permitted by Sentences 3.2.2.7.(1) and 3.2.2.18.(2), the *building* is *sprinklered* throughout,
  - b) it is not more than 3 *storeys* in *building height*, and
  - c) it has a *building area* not more than
    - i) 3 600 m<sup>2</sup> if 1 *storey* in *building height*,
    - ii) 1 800 m<sup>2</sup> if 2 *storeys* in *building height*, or
    - iii) 1 200 m<sup>2</sup> if 3 *storeys* in *building height*.
- 2)** The *building* referred to in Sentence (1) is permitted to be of *heavy timber construction* or *noncombustible construction* used singly or in combination, and
- a) floor assemblies shall be *fire separations* with a *fire-resistance rating* not less than 45 min, and
  - b) *loadbearing walls*, columns and arches shall have a *fire-resistance rating* not less than that required for the supported assembly.

**3.2.2.72. Group F, Division 1, up to 2 Storeys, Sprinklered**

- 1)** A *building* classified as Group F, Division 1 is permitted to conform to Sentence (2) provided
- a) except as permitted by Sentences 3.2.2.7.(1) and 3.2.2.18.(2), the *building* is *sprinklered* throughout,
  - b) it is not more than 2 *storeys* in *building height*, and
  - c) it has a *building area* not more than
    - i) 2 400 m<sup>2</sup> if 1 *storey* in *building height*, or
    - ii) 1 200 m<sup>2</sup> if 2 *storeys* in *building height*.
- 2)** The *building* referred to in Sentence (1) is permitted to be of *combustible construction* or *noncombustible construction* used singly or in combination, and
- a) floor assemblies shall be *fire separations* and, if of *combustible construction*, shall have a *fire-resistance rating* not less than 45 min, and
  - b) *loadbearing walls*, columns and arches supporting an assembly required to have a *fire-resistance rating* shall
    - i) have a *fire-resistance rating* not less than 45 min, or
    - ii) be of *noncombustible construction*.

**3.2.2.73. Group F, Division 1, One Storey**

- 1)** A *building* classified as Group F, Division 1 is permitted to be of *combustible construction* or *noncombustible construction* used singly or in combination provided
- a) it is not more than 1 *storey* in *building height*, and
  - b) it has a *building area* not more than 800 m<sup>2</sup>.

**3.2.2.74. Group F, Division 2, Any Height, Any Area, Sprinklered**

- 1)** Except as permitted by Sentence 3.2.2.7.(4) and Articles 3.2.2.75. to 3.2.2.79., a *building* classified as Group F, Division 2 shall conform to Sentence (2).
- 2)** Except as permitted by Article 3.2.2.16., the *building* referred to in Sentence (1) shall be of *noncombustible construction*, and
- a) except as permitted by Sentences 3.2.2.7.(1) and 3.2.2.18.(2), the *building* shall be *sprinklered* throughout,
  - b) floor assemblies shall be *fire separations* with a *fire-resistance rating* not less than 2 h,
  - c) *mezzanines* shall have a *fire-resistance rating* not less than 1 h, and
  - d) *loadbearing walls*, columns and arches shall have a *fire-resistance rating* not less than that required for the supported assembly.

**3.2.2.75. Group F, Division 2, up to 4 Storeys, Increased Area, Sprinklered**

- 1)** A *building* classified as Group F, Division 2 is permitted to conform to Sentence (2) provided
  - a) except as permitted by Sentences 3.2.2.7.(1) and 3.2.2.18.(2), the *building* is *sprinklered* throughout,
  - b) it is not more than 4 *storeys* in *building height*, and
  - c) it has a *building area* not more than
    - i) 18 000 m<sup>2</sup> if 1 *storey* in *building height*,
    - ii) 9 000 m<sup>2</sup> if 2 *storeys* in *building height*,
    - iii) 6 000 m<sup>2</sup> if 3 *storeys* in *building height*, or
    - iv) 4 500 m<sup>2</sup> if 4 *storeys* in *building height*.
- 2)** Except as permitted by Article 3.2.2.16., the *building* referred to in Sentence (1) shall be of *noncombustible construction*, and
  - a) floor assemblies shall be *fire separations* with a *fire-resistance rating* not less than 1 h,
  - b) *mezzanines* shall have a *fire-resistance rating* not less than 1 h, and
  - c) *loadbearing* walls, columns and arches shall have a *fire-resistance rating* not less than that required for the supported assembly.

**3.2.2.76. Group F, Division 2, up to 3 Storeys**

- 1)** A *building* classified as Group F, Division 2 is permitted to conform to Sentence (2) provided
  - a) it is not more than 3 *storeys* in *building height*, and
  - b) it has a *building area* not more than the value in Table 3.2.2.76.

**Table 3.2.2.76.**  
**Maximum Building Area, Group F, Division 2, up to 3 Storeys**  
 Forming Part of Sentence 3.2.2.76.(1)

No. of Storeys	Maximum Area, m <sup>2</sup>		
	Facing 1 Street	Facing 2 Streets	Facing 3 Streets
1	1 500	1 500	1 500
2	1 500	1 500	1 500
3	1 070	1 340	1 500

- 2)** The *building* referred to in Sentence (1) is permitted to be of *combustible construction* or *noncombustible construction* used singly or in combination, and
  - a) floor assemblies shall be *fire separations* with a *fire-resistance rating* not less than 45 min,
  - b) *mezzanines* shall have, if of *combustible construction*, a *fire-resistance rating* not less than 45 min,
  - c) roof assemblies shall have, if of *combustible construction*, a *fire-resistance rating* not less than 45 min, except that in a *building* not more than 1 *storey* in *building height*, the *fire-resistance rating* is permitted to be waived provided that the roof assembly is constructed as a *fire-retardant-treated wood* roof system conforming to Article 3.1.14.1.,
  - d) *loadbearing* walls, columns and arches supporting an assembly required to have a *fire-resistance rating* shall
    - i) have a *fire-resistance rating* not less than 45 min, or
    - ii) be of *noncombustible construction*, and
  - e) *loadbearing* walls, columns and arches supporting a *fire separation* shall have a *fire-resistance rating* not less than that required for the *fire separation*.

**3.2.2.77. Group F, Division 2, up to 4 Storeys, Sprinklered**

- 1)** A *building* classified as Group F, Division 2 is permitted to conform to Sentence (2) provided
- a) except as permitted by Sentences 3.2.2.7.(1) and 3.2.2.18.(2), the *building* is *sprinklered* throughout,
  - b) it is not more than 4 *storeys* in *building height*, and
  - c) it has a *building area* not more than
    - i) 9 600 m<sup>2</sup> if 1 *storey* in *building height*,
    - ii) 4 800 m<sup>2</sup> if 2 *storeys* in *building height*,
    - iii) 3 200 m<sup>2</sup> if 3 *storeys* in *building height*, or
    - iv) 2 400 m<sup>2</sup> if 4 *storeys* in *building height*.
- 2)** The *building* referred to in Sentence (1) is permitted to be of *combustible construction* or *noncombustible construction* used singly or in combination, and
- a) floor assemblies shall be *fire separations* with a *fire-resistance rating* not less than 45 min,
  - b) *mezzanines* shall have, if of *combustible construction*, a *fire-resistance rating* not less than 45 min,
  - c) *loadbearing walls*, columns and arches supporting an assembly required to have a *fire-resistance rating* shall
    - i) have a *fire-resistance rating* not less than 45 min, or
    - ii) be of *noncombustible construction*, and
  - d) *loadbearing walls*, columns and arches supporting a *fire separation* shall have a *fire-resistance rating* not less than that required for the *fire separation*.

**3.2.2.78. Group F, Division 2, up to 2 Storeys**

- 1)** A *building* classified as Group F, Division 2 is permitted to conform to Sentence (2) provided
- a) it is not more than 2 *storeys* in *building height*, and
  - b) it has a *building area* not more than the value in Table 3.2.2.78.

**Table 3.2.2.78.**  
**Maximum Building Area, Group F, Division 2, up to 2 Storeys**  
 Forming Part of Sentence 3.2.2.78.(1)

No. of Storeys	Maximum Area, m <sup>2</sup>		
	Facing 1 Street	Facing 2 Streets	Facing 3 Streets
1	1 000	1 250	1 500
2	600	750	900

- 2)** The *building* referred to in Sentence (1) is permitted to be of *combustible construction* or *noncombustible construction* used singly or in combination, and
- a) floor assemblies shall be *fire separations* and, if of *combustible construction*, shall have a *fire-resistance rating* not less than 45 min, and
  - b) *loadbearing walls*, columns and arches supporting an assembly required to have a *fire-resistance rating* shall
    - i) have a *fire-resistance rating* not less than 45 min, or
    - ii) be of *noncombustible construction*.

**3.2.2.79. Group F, Division 2, up to 2 Storeys, Sprinklered**

- 1)** A *building* classified as Group F, Division 2 is permitted to conform to Sentence (2) provided
- a) except as permitted by Sentences 3.2.2.7.(1) and 3.2.2.18.(2), the *building* is *sprinklered* throughout,
  - b) it is not more than 2 *storeys* in *building height*, and
  - c) it has a *building area* not more than
    - i) 4 500 m<sup>2</sup> if 1 *storey* in *building height*, or
    - ii) 1 800 m<sup>2</sup> if 2 *storeys* in *building height*.

- 2)** The *building* referred to in Sentence (1) is permitted to be of *combustible construction* or *noncombustible construction* used singly or in combination, and
  - a) floor assemblies shall be *fire separations* and, if of *combustible construction*, shall have a *fire-resistance rating* not less than 45 min, and
  - b) *loadbearing* walls, columns and arches supporting an assembly required to have a *fire-resistance rating* shall
    - i) have a *fire-resistance rating* not less than 45 min, or
    - ii) be of *noncombustible construction*.

**3.2.2.80. Group F, Division 3, Any Height, Any Area, Sprinklered**

- 1)** Except as permitted by Sentences 3.2.2.7.(3) and (4) and Articles 3.2.2.81. to 3.2.2.90., a *building* classified as Group F, Division 3 shall conform to Sentence (2).
- 2)** Except as permitted by Article 3.2.2.16., the *building* referred to in Sentence (1) shall be of *noncombustible construction*, and
  - a) except as permitted by Sentences 3.2.2.7.(1) and 3.2.2.18.(2), the *building* shall be *sprinklered* throughout,
  - b) floor assemblies shall be *fire separations* with a *fire-resistance rating* not less than 2 h, except that floor assemblies are permitted to be *fire separations* with a *fire-resistance rating* not less than 1 h in a *storage garage* with all *storeys* constructed as *open-air storeys*,
  - c) *mezzanines* shall have a *fire-resistance rating* not less than 1 h, and
  - d) *loadbearing* walls, columns and arches shall have a *fire-resistance rating* not less than that required for the supported assembly.

**3.2.2.81. Group F, Division 3, up to 6 Storeys**

- 1)** Except as permitted by Sentences 3.2.2.7.(3) and (4), a *building* classified as Group F, Division 3 is permitted to conform to Sentence (2) provided
  - a) it is not more than 6 *storeys* in *building height*, and
  - b) it has a *building area* not more than the value in Table 3.2.2.81.

**Table 3.2.2.81.**  
**Maximum Building Area, Group F, Division 3, up to 6 Storeys**  
 Forming Part of Sentence 3.2.2.81.(1)

No. of Storeys	Maximum Area, m <sup>2</sup>		
	Facing 1 Street	Facing 2 Streets	Facing 3 Streets
1	not limited	not limited	not limited
2	7 200	9 000	10 800
3	4 800	6 000	7 200
4	3 600	4 500	5 400
5	2 880	3 600	4 320
6	2 400	3 000	3 600

- 2)** The *building* referred to in Sentence (1) shall be of *noncombustible construction*, and
  - a) floor assemblies shall be *fire separations* with a *fire-resistance rating* not less than 1 h,
  - b) *mezzanines* shall have a *fire-resistance rating* not less than 1 h,
  - c) roof assemblies shall have a *fire-resistance rating* not less than 1 h, and
  - d) *loadbearing* walls, columns and arches shall have a *fire-resistance rating* not less than that required for the supported assembly.

**3.2.2.82. Group F, Division 3, up to 6 Storeys, Sprinklered**

- 1) Except as permitted by Sentences 3.2.2.7.(3) and (4), a *building* classified as Group F, Division 3 is permitted to conform to Sentence (2) provided
  - a) except as permitted by Sentences 3.2.2.7.(1) and 3.2.2.18.(2), the *building* is *sprinklered* throughout,
  - b) it is not more than 6 *storeys* in *building height*, and
  - c) it has a *building area*
    - i) that is not limited if the *building* is not more than 1 *storey* in *building height*,
    - ii) not more than 21 600 m<sup>2</sup> if 2 *storeys* in *building height*,
    - iii) not more than 14 400 m<sup>2</sup> if 3 *storeys* in *building height*,
    - iv) not more than 10 800 m<sup>2</sup> if 4 *storeys* in *building height*,
    - v) not more than 8 640 m<sup>2</sup> if 5 *storeys* in *building height*, or
    - vi) not more than 7 200 m<sup>2</sup> if 6 *storeys* in *building height*.
- 2) Except as permitted by Article 3.2.2.16., the *building* referred to in Sentence (1) shall be of *noncombustible construction*, and
  - a) floor assemblies shall be *fire separations* with a *fire-resistance rating* not less than 1 h,
  - b) *mezzanines* shall have a *fire-resistance rating* not less than 1 h, and
  - c) *loadbearing walls*, columns and arches shall have a *fire-resistance rating* not less than that required for the supported assembly.

**3.2.2.83. Group F, Division 3, up to 4 Storeys**

- 1) A *building* classified as Group F, Division 3 is permitted to conform to Sentence (2) provided
  - a) it is not more than 4 *storeys* in *building height*, and
  - b) it has a *building area* not more than the value in Table 3.2.2.83.

**Table 3.2.2.83.**  
**Maximum Building Area, Group F, Division 3, up to 4 Storeys**  
 Forming Part of Sentence 3.2.2.83.(1)

No. of Storeys	Maximum Area, m <sup>2</sup>		
	Facing 1 Street	Facing 2 Streets	Facing 3 Streets
1	4 800	6 000	7 200
2	2 400	3 000	3 600
3	1 600	2 000	2 400
4	1 200	1 500	1 800

- 2) The *building* referred to in Sentence (1) is permitted to be of *combustible construction* or *noncombustible construction* used singly or in combination, and
  - a) floor assemblies shall be *fire separations* and, if of *combustible construction*, shall have a *fire-resistance rating* not less than 45 min,
  - b) *mezzanines* shall have, if of *combustible construction*, a *fire-resistance rating* not less than 45 min,
  - c) roof assemblies shall have, if of *combustible construction*, a *fire-resistance rating* not less than 45 min, except that in a *building* not more than 1 *storey* in *building height*, the *fire-resistance rating* is permitted to be waived provided the roof assembly is constructed as a *fire-retardant-treated wood* roof system conforming to Article 3.1.14.1., and the *building area* is not more than
    - i) 2 400 m<sup>2</sup> if facing one *street*,
    - ii) 3 000 m<sup>2</sup> if facing 2 *streets*, or
    - iii) 3 600 m<sup>2</sup> if facing 3 *streets*, and
  - d) *loadbearing walls*, columns and arches supporting an assembly required to have a *fire-resistance rating* shall
    - i) have a *fire-resistance rating* not less than 45 min, or
    - ii) be of *noncombustible construction*.

**3.2.2.84. Group F, Division 3, up to 4 Storeys, Sprinklered**

- 1)** A *building* classified as Group F, Division 3 is permitted to conform to Sentence (2) provided
  - a) except as permitted by Sentences 3.2.2.7.(1) and 3.2.2.18.(2), the *building* is *sprinklered* throughout,
  - b) it is not more than 4 *storeys* in *building height*, and
  - c) it has a *building area* not more than
    - i) 14 400 m<sup>2</sup> if 1 *storey* in *building height*,
    - ii) 7 200 m<sup>2</sup> if 2 *storeys* in *building height*,
    - iii) 4 800 m<sup>2</sup> if 3 *storeys* in *building height*, or
    - iv) 3 600 m<sup>2</sup> if 4 *storeys* in *building height*.
- 2)** The *building* referred to in Sentence (1) is permitted to be of *combustible construction* or *noncombustible construction* used singly or in combination, and
  - a) floor assemblies shall be *fire separations* and, if of *combustible construction*, shall have a *fire-resistance rating* not less than 45 min,
  - b) *mezzanines* shall have, if of *combustible construction*, a *fire-resistance rating* not less than 45 min, and
  - c) *loadbearing walls*, columns and arches supporting an assembly required to have a *fire-resistance rating* shall
    - i) have a *fire-resistance rating* not less than 45 min, or
    - ii) be of *noncombustible construction*.

**3.2.2.85. Group F, Division 3, up to 2 Storeys**

- 1)** A *building* classified as Group F, Division 3 is permitted to conform to Sentence (2) provided
  - a) it is not more than 2 *storeys* in *building height*, and
  - b) it has a *building area* not more than the value in Table 3.2.2.85.

**Table 3.2.2.85.**  
**Maximum Building Area, Group F, Division 3, up to 2 Storeys**  
 Forming Part of Sentence 3.2.2.85.(1)

No. of Storeys	Maximum Area, m <sup>2</sup>		
	Facing 1 Street	Facing 2 Streets	Facing 3 Streets
1	1 600	2 000	2 400
2	800	1 000	1 200

- 2)** The *building* referred to in Sentence (1) is permitted to be of *combustible construction* or *noncombustible construction* used singly or in combination, and
  - a) floor assemblies shall be *fire separations* and, if of *combustible construction*, shall have a *fire-resistance rating* not less than 45 min, and
  - b) *loadbearing walls*, columns and arches supporting an assembly required to have a *fire-resistance rating* shall
    - i) have a *fire-resistance rating* not less than 45 min, or
    - ii) be of *noncombustible construction*.

**3.2.2.86. Group F, Division 3, up to 2 Storeys, Sprinklered**

- 1)** A *building* classified as Group F, Division 3 is permitted to conform to Sentence (2) provided
  - a) except as permitted by Sentences 3.2.2.7.(1) and 3.2.2.18.(2), the *building* is *sprinklered* throughout,
  - b) it is not more than 2 *storeys* in *building height*, and
  - c) it has a *building area* not more than
    - i) 7 200 m<sup>2</sup> if 1 *storey* in *building height*, or
    - ii) 2 400 m<sup>2</sup> if 2 *storeys* in *building height*.

- 2)** The *building* referred to in Sentence (1) is permitted to be of *combustible construction* or *noncombustible construction* used singly or in combination, and
- a) floor assemblies shall be *fire separations* and, if of *combustible construction*, shall have a *fire-resistance rating* not less than 45 min, and
  - b) *loadbearing walls*, columns and arches supporting an assembly required to have a *fire-resistance rating* shall
    - i) have a *fire-resistance rating* not less than 45 min, or
    - ii) be of *noncombustible construction*.

**3.2.2.87. Group F, Division 3, One Storey**

- 1)** A *building* classified as Group F, Division 3 is permitted to be of *heavy timber construction* or *noncombustible construction* used singly or in combination provided
- a) it is not more than 1 *storey* in *building height*, and
  - b) it has a *building area* not more than
    - i) 5 600 m<sup>2</sup> if facing one *street*,
    - ii) 7 000 m<sup>2</sup> if facing 2 *streets*, or
    - iii) 8 400 m<sup>2</sup> if facing 3 *streets*.

**3.2.2.88. Group F, Division 3, One Storey, Sprinklered**

- 1)** A *building* classified as Group F, Division 3 is permitted to be of *heavy timber construction* or *noncombustible construction* used singly or in combination provided
- a) except as permitted by Sentences 3.2.2.7.(1) and 3.2.2.18.(2), the *building* is *sprinklered* throughout,
  - b) it is not more than 1 *storey* in *building height*, and
  - c) it has a *building area* not more than 16 800 m<sup>2</sup>.

**3.2.2.89. Group F, Division 3, One Storey, Any Area, Low Fire Load Occupancy**

- 1)** A *building* classified as Group F, Division 3 is permitted to conform to Sentence (2) provided it is
- a) not more than 1 *storey* in *building height*,
  - b) used solely for low *fire load occupancies* such as
    - i) power generating plants, or
    - ii) plants for the manufacture or storage of *noncombustible materials*, and
  - c) not limited in *building area*.
- 2)** The *building* referred to in Sentence (1) shall be of *noncombustible construction*.

**3.2.2.90. Group F, Division 3, Storage Garages up to 22 m High**

- 1)** A *building* used as a *storage garage* with all *storeys* constructed as *open-air storeys* and having no other *occupancy* above it is permitted to have its floor, wall, ceiling and roof assemblies constructed without a *fire-resistance rating* provided it is
- a) of *noncombustible construction*,
  - b) not more than 22 m high, measured between *grade* and the ceiling level of the top *storey*,
  - c) not more than 10 000 m<sup>2</sup> in *building area*, and
  - d) designed so that every portion of each *floor area* is within 60 m of an exterior wall opening.



**3.2.3. Spatial Separation and Exposure Protection**

(See Note A-3.2.3.)

**3.2.3.1. Limiting Distance and Area of Unprotected Openings**

**1)** Except as permitted by Articles 3.2.3.10. to 3.2.3.12., the area of *unprotected openings* in an *exposing building face* for the applicable *limiting distance* shall be not more than the value determined in accordance with

- a) Table 3.2.3.1.-B or 3.2.3.1.-C for an *exposing building face* conforming to Article 3.2.3.2. of a *building* or *fire compartment* which is not *sprinklered*, or
- b) Table 3.2.3.1.-D or 3.2.3.1.-E for an *exposing building face* conforming to Article 3.2.3.2. of a *sprinklered fire compartment* that is part of a *building* which is *sprinklered* in conformance with Section 3.2.

(See Note A-3.)

(See also Article 3.1.6.3.)

**2)** The area of the *unprotected openings* in an *exposing building face* shall be the aggregate area of *unprotected openings* expressed as a percentage of the area of the *exposing building face* in Table 3.2.3.1.-B, 3.2.3.1.-C, 3.2.3.1.-D or 3.2.3.1.-E. (See Sentence 3.2.3.2.(1).)

**3)** For the purpose of determining the type of construction and cladding and the *fire-resistance rating* of an exterior wall,

- a) the *exposing building face* shall be taken as the projection of the exterior wall onto a vertical plane located so that no portion of the exterior wall of the *building* or of a *fire compartment*, if the *fire compartment* complies with the requirements of Article 3.2.3.2., is between the vertical plane and the line to which the *limiting distance* is measured, and
- b) the area of *unprotected openings* shall be determined from Table 3.2.3.1.-B, 3.2.3.1.-C, 3.2.3.1.-D or 3.2.3.1.-E.

**4)** For the purpose of determining the actual percentage of *unprotected openings* permitted in an exterior wall, the location of the *exposing building face* is permitted to be taken at a vertical plane located so that there are no *unprotected openings* between the vertical plane and the line to which the *limiting distance* is measured. (See Note A-3.2.3.1.(4).)

**5)** Except for *buildings* that are *sprinklered*, where the *limiting distance* is 2 m or less, individual *unprotected openings* in an *exposing building face* shall be no greater than

- a) the area stated in Table 3.2.3.1.-A, or
- b) where the *limiting distance* is equal to or greater than 1.2 m, the area calculated by

$$\text{Area} = 0.24 (2 \times \text{LD} - 1.2)^2$$

where

Area = area of the *unprotected opening*, and  
 LD = *limiting distance*.

**Table 3.2.3.1.-A**  
**Maximum Concentrated Area of Unprotected Openings**  
 Forming Part of Sentence 3.2.3.1.(5)

<i>Limiting Distance, m</i>	Maximum Area of Individual <i>Unprotected Openings, m<sup>2</sup></i>
1.2	0.35
1.5	0.78
2.0	1.88

- 6)** The spacing between individual *unprotected openings* described in Sentence (5) that serve a single room or space described in Sentence (7) shall not be less than
- 2 m horizontally of another *unprotected opening* that is on the same *exposing building face* and serves the single room or space, or
  - 2 m vertically of another *unprotected opening* that serves the single room or space, or another room or space on the same *storey*.
- 7)** For the purpose of Sentence (6), “single room or space” shall mean
- two or more adjacent spaces having a full-height separating wall extending less than 1.5 m from the interior face of the exterior wall, or
  - two or more stacked spaces that are on the same *storey*.
- 8)** A *limiting distance* equal to half the actual *limiting distance* shall be used as input to Tables 3.2.3.1.-B and 3.2.3.1.-C, where
- the time from receipt of notification of a fire by the fire department until the arrival of the first fire department vehicle at the *building* exceeds 10 min in 10% or more of all fire department calls to the *building*, and
  - any *storey* in the *building* is not *sprinklered*.
- (See Notes A-3.2.3.1.(8) and A-3.2.3.)
- 9)** If the surface temperature on the unexposed surface of a wall assembly exceeds the temperature limit of a standard fire test as permitted by Article 3.1.7.2., an allowance shall be made for the radiation from the hot unexposed wall surface by adding an equivalent area of *unprotected opening* to the area of actual openings as follows:

$$A_C = A + (A_F \times F_{EO})$$

where

- $A_C$  = corrected area of *unprotected openings* including actual and equivalent openings,  
 $A$  = actual area of *unprotected openings*,  
 $A_F$  = area of exterior surface of the *exposing building face*, exclusive of openings, on which the temperature limit of the standard test is exceeded, and  
 $F_{EO}$  = an equivalent opening factor derived from the following expression:

$$F_{EO} = \frac{(T_u + 273)^4}{(T_e + 273)^4}$$

- $T_u$  = average temperature in degrees Celsius of the unexposed wall surface at the time the required *fire-resistance rating* is reached under test conditions,  
 $T_e$  = 892°C for a *fire-resistance rating* not less than 45 min, 927°C for a *fire-resistance rating* not less than 1 h, and 1 010°C for a *fire-resistance rating* not less than 2 h.

- 10)** Unless a *closure* used to protect an opening in an *exposing building face* has a protective performance equivalent to that required for the wall assembly in which it is located, an equivalent area of *unprotected opening*, determined in accordance with the procedures of Sentence (9) shall be added to the greater of
- the actual area of *unprotected openings*, or
  - the corrected area of *unprotected openings*.

**Table 3.2.3.1.-B**  
**Unprotected Opening Limits for a Building or Fire Compartment that is not Sprinklered Throughout**  
 Forming Part of Article 3.2.3.1.

Exposing Building Face		Area of Unprotected Opening for Groups A, C, D, and F; Division 3 Occupancies, %																																
		Limiting Distance, m																																
Max. Area, m <sup>2</sup>	Ratio (L/H or H/L) <sup>(1)</sup>	0	1.2	1.5	2.0	2.5	3	4	5	6	7	8	9	10	11	12	13	14	16	18	20	25	30	35	40	45	50							
10	Less than 3 : 1	0	8	10	18	29	46	91	100																									
	3 : 1 to 10 : 1	0	8	12	21	33	50	96	100																									
	over 10 : 1	0	11	18	32	48	68	100																										
15	Less than 3 : 1	0	7	9	14	22	33	63	100																									
	3 : 1 to 10 : 1	0	8	10	17	25	37	67	100																									
	over 10 : 1	0	10	15	26	39	53	87	100																									
20	Less than 3 : 1	0	7	9	12	18	26	49	81	100																								
	3 : 1 to 10 : 1	0	8	10	15	21	30	53	85	100																								
	over 10 : 1	0	9	14	23	33	45	72	100																									
25	Less than 3 : 1	0	7	8	11	16	23	41	66	98	100																							
	3 : 1 to 10 : 1	0	8	9	13	19	26	45	70	100																								
	over 10 : 1	0	9	13	21	30	39	62	90	100																								
30	Less than 3 : 1	0	7	8	11	15	20	35	56	83	100																							
	3 : 1 to 10 : 1	0	7	9	12	17	23	39	61	88	100																							
	over 10 : 1	0	8	12	19	27	36	56	79	100																								
40	Less than 3 : 1	0	7	8	10	13	17	28	44	64	89	100																						
	3 : 1 to 10 : 1	0	7	8	11	15	20	32	48	69	93	100																						
	over 10 : 1	0	8	11	17	24	31	47	66	88	100																							
50	Less than 3 : 1	0	7	8	9	12	15	24	37	53	72	96	100																					
	3 : 1 to 10 : 1	0	7	8	10	14	18	28	41	57	77	100																						
	over 10 : 1	0	8	10	15	21	28	41	57	76	97	100																						
60	Less than 3 : 1	0	7	8	9	11	14	21	32	45	62	81	100																					
	3 : 1 to 10 : 1	0	7	8	10	13	16	25	36	49	66	85	100																					
	over 10 : 1	0	8	10	14	20	25	38	51	67	85	100																						
80	Less than 3 : 1	0	7	7	8	10	12	18	26	36	48	62	79	98	100																			
	3 : 1 to 10 : 1	0	7	8	9	11	14	21	29	40	52	67	84	100																				
	over 10 : 1	0	8	9	13	17	22	32	44	56	70	86	100																					
100	Less than 3 : 1	0	7	7	8	9	11	16	22	30	40	51	65	80	97	100																		
	3 : 1 to 10 : 1	0	7	8	9	11	13	18	25	34	44	56	69	84	100																			
	over 10 : 1	0	7	9	12	16	20	29	39	49	61	74	89	100																				

Table 3.2.3.1.-B (Continued)

Exposing Building Face	Area of Unprotected Opening for Groups A, C, D, and F; Division 3 Occupancies, %																											
	Limiting Distance, m																											
Max. Area, m <sup>2</sup>	Ratio (L/H or H/L) <sup>(1)</sup>	0	1.2	1.5	2.0	2.5	3	4	5	6	7	8	9	10	11	12	13	14	16	18	20	25	30	35	40	45	50	
150	Less than 3 : 1	0	7	7	8	9	10	13	17	22	29	37	46	56	67	79	93	100										
	3 : 1 to 10 : 1	0	7	7	8	10	11	15	20	26	33	41	50	60	71	84	97	100										
	over 10 : 1	0	7	8	11	13	17	24	31	39	48	57	68	79	91	100												
250	Less than 3 : 1	0	7	7	7	8	9	10	13	16	20	25	30	36	43	51	59	68	87	100								
	3 : 1 to 10 : 1	0	7	7	8	9	10	12	15	19	24	28	34	40	47	55	63	72	92	100								
	over 10 : 1	0	7	8	9	11	14	19	24	30	36	43	50	57	65	73	82	92	100									
350	Less than 3 : 1	0	7	7	7	8	8	9	11	14	16	20	24	28	33	38	44	50	64	81	99	100						
	3 : 1 to 10 : 1	0	7	7	8	8	9	11	13	16	19	23	27	32	37	42	48	55	69	85	100							
	over 10 : 1	0	7	8	9	10	12	16	21	25	30	36	41	47	53	59	66	73	88	100								
500	Less than 3 : 1	0	7	7	7	7	7	8	9	10	12	14	16	19	22	25	29	33	37	47	59	71	100					
	3 : 1 to 10 : 1	0	7	7	7	8	8	10	12	14	16	19	22	25	29	33	37	41	52	63	76	100						
	over 10 : 1	0	7	7	8	9	11	14	18	22	25	30	34	38	43	48	53	58	70	82	96	100						
1 000	Less than 3 : 1	0	7	7	7	7	7	7	8	9	9	10	12	13	14	16	18	20	22	27	33	39	58	82	100			
	3 : 1 to 10 : 1	0	7	7	7	7	8	9	10	11	12	14	15	17	19	21	23	26	31	37	43	63	86	100				
	over 10 : 1	0	7	7	8	8	9	11	13	16	19	21	24	27	30	33	36	39	46	53	60	82	100					
2 000	Less than 3 : 1	0	7	7	7	7	7	7	8	8	9	9	10	11	12	13	14	15	17	20	23	33	44	58	74	93	100	
	3 : 1 to 10 : 1	0	7	7	7	7	7	7	8	8	9	10	11	12	13	14	15	16	17	20	23	37	49	63	79	97	100	
	over 10 : 1	0	7	7	7	8	8	9	11	12	14	16	18	19	21	23	25	27	32	36	40	53	66	82	99	100		

Notes to Table 3.2.3.1.-B:

(1) Apply whichever ratio is greater.

L = Length of exposing building face

H = Height of exposing building face



Table 3.2.3.1.-C (Continued)

Exposing Building Face	Area of Unprotected Openings for Groups E and F, Division 1 and 2 Occupancies, %																																				
	Max. Area, m <sup>2</sup>	Ratio (L/H or H/L) <sup>(1)</sup>	Limiting Distance, m																																		
			0	1.2	1.5	2.0	2.5	3	4	4	5	6	7	8	9	10	11	12	13	14	16	18	20	25	30	35	40	45	50	55	60	65	70				
150	Less than 3 : 1 3 : 1 to 10 : 1 over 10 : 1	0	4	4	4	4	4	5	6	8	11	14	18	23	28	33	40	46	54	70	89	100															
		0	4	4	4	5	6	8	10	13	16	20	24	29	34	39	46	52	59	67	84	100															
		0	4	4	4	5	7	8	12	16	20	24	29	34	39	46	52	59	67	84	100																
250	Less than 3 : 1 3 : 1 to 10 : 1 over 10 : 1	0	4	4	4	4	4	4	5	7	8	10	12	15	18	22	25	29	34	44	55	68	100														
		0	4	4	4	4	4	5	6	8	10	12	14	17	20	24	27	32	36	46	57	70	100														
		0	4	4	4	5	6	7	9	12	15	18	21	25	28	32	37	41	46	56	68	81	100														
350	Less than 3 : 1 3 : 1 to 10 : 1 over 10 : 1	0	4	4	4	4	4	4	5	6	7	8	10	12	14	16	18	21	24	27	34	43	52	79	100												
		0	4	4	4	4	4	4	5	6	8	10	13	15	18	21	23	26	30	36	44	53	62	90	100												
		0	4	4	4	4	4	5	6	8	10	13	15	18	21	23	26	30	33	36	44	53	62	90	100												
500	Less than 3 : 1 3 : 1 to 10 : 1 over 10 : 1	0	4	4	4	4	4	4	4	5	6	7	8	10	12	14	16	18	21	24	26	29	35	41	48	68	92	100									
		0	4	4	4	4	4	4	4	5	6	7	8	10	12	14	16	18	21	24	26	29	35	41	48	68	92	100									
		0	4	4	4	4	4	4	4	5	6	7	8	10	12	14	16	18	21	24	26	29	35	41	48	68	92	100									
1 000	Less than 3 : 1 3 : 1 to 10 : 1 over 10 : 1	0	4	4	4	4	4	4	4	4	4	5	6	7	8	9	11	13	14	16	19	24	29	36	55	78	100										
		0	4	4	4	4	4	4	4	4	5	6	7	8	9	11	13	14	16	18	21	26	31	38	57	80	100										
		0	4	4	4	4	4	4	5	5	7	9	11	13	15	17	19	21	24	26	29	35	41	48	68	92	100										
2 000	Less than 3 : 1 3 : 1 to 10 : 1 over 10 : 1	0	4	4	4	4	4	4	4	4	4	4	5	5	6	7	8	9	10	11	12	13	14	16	20	29	41	55	71	89	100						
		0	4	4	4	4	4	4	4	4	4	4	4	5	5	6	7	8	9	10	11	12	13	15	18	22	31	43	57	73	91	100					
		0	4	4	4	4	4	4	4	4	4	4	4	4	4	4	5	5	6	7	8	9	10	11	12	13	15	16	18	20	23	26	30	34	41	53	68
2 000	Less than 3 : 1 3 : 1 to 10 : 1 over 10 : 1	0	4	4	4	4	4	4	4	4	4	4	4	4	4	5	5	6	7	8	9	10	11	12	13	16	22	29	37	46	56	68	80	94	100		
		0	4	4	4	4	4	4	4	4	4	4	4	4	4	4	4	4	4	4	4	4	4	4	4	4	4	4	4	4	4	4	4	4	4	4	4
		0	4	4	4	4	4	4	4	4	4	4	4	4	4	4	4	4	4	4	4	4	4	4	4	4	4	4	4	4	4	4	4	4	4	4	4

Notes to Table 3.2.3.1.-C:

- (1) Apply whichever ratio is greater.
- L = Length of exposing building face
- H = Height of exposing building face

**Table 3.2.3.1.-D**  
**Unprotected Opening Limits for a Building or Fire Compartment that is Sprinklered Throughout**  
 Forming Part of Article 3.2.3.1.

Exposing Building Face	Area of Unprotected Opening for Groups A, B, C, D and F, Division 3 Occupancies, %											
	Limiting Distance, m											
Max. Area, m <sup>2</sup>	0	1.2	1.5	2.0	2.5	3	4	5	6	7	8	9
10	0	16	24	42	66	100						
15	0	16	20	34	50	74	100					
20	0	16	20	30	42	60	100					
25	0	16	18	26	38	52	90	100				
30	0	14	18	24	34	46	78	100				
40	0	14	16	22	30	40	64	96	100			
50	0	14	16	20	28	36	56	82	100			
60	0	14	16	20	26	32	50	72	98	100		
80	0	14	16	18	22	28	42	58	80	100		
100	0	14	16	18	22	26	36	50	68	88	100	
150 or more	0	14	14	16	20	22	30	40	52	66	82	100

**Table 3.2.3.1.-E**  
**Unprotected Opening Limits for a Building or Fire Compartment that is Sprinklered Throughout**  
 Forming Part of Article 3.2.3.1.

Exposing Building Face	Area of Unprotected Opening for Groups E and F, Division 1 and 2 Occupancies, %																	
	Limiting Distance, m																	
Max. Area, m <sup>2</sup>	0	1.2	1.5	2.0	2.5	3	4	5	6	7	8	9	10	11	12	13	14	15
10	0	8	12	20	34	50	96	100										
15	0	8	10	16	26	36	68	100										
20	0	8	10	14	22	30	54	86	100									
25	0	8	10	14	18	26	44	70	100									
30	0	8	8	12	18	24	40	60	88	100								
40	0	8	8	12	16	20	32	48	68	94	100							
50	0	8	8	10	14	18	28	40	58	76	100							
60	0	8	8	10	12	16	24	36	50	66	86	100						
80	0	8	8	10	12	14	20	30	40	52	66	84	100					
100	0	8	8	8	10	12	18	26	34	44	56	70	84	100				
150	0	8	8	8	10	12	16	20	26	32	40	50	60	72	84	98	100	
200 or more	0	8	8	8	8	10	14	18	22	28	34	42	50	60	68	80	92	100

**3.2.3.2. Area of Exposing Building Face**

**1)** Except as permitted by Sentences (2) and (3), the area of an *exposing building face* shall be calculated as the total area of an exterior wall facing in one direction on any side of a *building* measured from the finished ground level to the uppermost ceiling.

**2)** If a *building* is divided by *fire separations* into *fire compartments*, the area of *exposing building face* is permitted to be calculated for each *fire compartment* provided the *fire separations* have a *fire-resistance rating* not less than 45 min.

**3)** In a *building* that is *sprinklered* throughout and contains an *interconnected floor space*, the area of the *exposing building face* for the *interconnected floor space* is permitted to be determined by considering each *storey* as a separate *fire compartment* notwithstanding openings through the floor assemblies.

**3.2.3.3. Wall Enclosing Attic or Roof Space**

**1)** An exterior wall enclosing an *attic or roof space* and located above an *exposing building face*, shall be constructed in conformance with the requirements for the *exposing building face*.

**3.2.3.4. Party Wall**

**1)** A *party wall* shall be constructed as a *firewall*. (See Note A-3.2.3.4.(1).)

**3.2.3.5. Wall with Limiting Distance Less Than 1.2 m**

**1)** Openings in a wall that has a *limiting distance* less than 1.2 m shall be protected by *closures* whose *fire-protection rating* is in conformance with the *fire-resistance rating* required for the wall.

**2)** Wired glass or glass block shall not be used for a *closure* referred to in Sentence (1).

**3.2.3.6. Combustible Projections**

**1)** Except for a *building* containing one or 2 *dwelling units* only, *combustible* projections on the exterior of a wall that could expose an adjacent *building* to fire spread and are more than 1 m above ground level, including balconies, platforms, canopies and stairs, shall not be permitted within

- a) 1.2 m of a property line or the centre line of a *public way*, or
- b) 2.4 m of a *combustible* projection on another *building* on the same property.

**2)** Except as provided in Sentence (4), where the *exposing building face* has a *limiting distance* of not more than 0.45 m, projecting roof soffits shall not be constructed above the *exposing building face*. (See Note A-3.2.3.6.(2).)

**3)** Except as provided in Sentence (4), where the *exposing building face* has a *limiting distance* of more than 0.45 m, the face of roof soffits shall not project to less than 0.45 m from the property line. (See Note A-3.2.3.6.(2).)

**4)** The face of a roof soffit is permitted to project to the property line, where it faces a *street*, lane or public thoroughfare. (See Note A-9.10.14.5.(11) and 9.10.15.5.(10).)

**5)** Where roof soffits project to less than 1.2 m from the centre line of a lane or public thoroughfare, or from an imaginary line between two *buildings* or *fire compartments* on the same property, they shall

- a) have no openings, and
- b) be protected by
  - i) not less than 0.38 mm thick sheet steel,
  - ii) unvented aluminum conforming to CAN/CGSB-93.2-M, "Prefinished Aluminum Siding, Soffits, and Fascia, for Residential Use,"
  - iii) not less than 12.7 mm thick gypsum soffit board or gypsum ceiling board installed according to CSA A82.31-M, "Gypsum Board Application,"
  - iv) not less than 11 mm thick plywood,
  - v) not less than 12.5 mm thick OSB or waferboard, or
  - vi) not less than 11 mm thick lumber.

**6)** For *buildings* of *combustible construction*, materials installed to provide the required protection of soffits may be covered with a *combustible* or *noncombustible* finish material.

**3.2.3.7. Construction of Exposing Building Face**

**1)** Except as provided in Sentences (3) and (4), and Articles 3.2.3.10. and 3.2.3.11., the *fire-resistance rating*, construction and cladding for *exposing building faces* of *buildings* or *fire compartments* of Group A, B, C, D or Group F, Division 3 *occupancy* classification shall comply with Table 3.2.3.7.



**2)** Except as provided in Sentences (3) and (4) and Article 3.2.3.10., the *fire-resistance rating*, construction and cladding for *exposing building faces* of buildings or *fire compartments* of Group E or Group F, Division 1 or 2 *occupancy* classification shall comply with Table 3.2.3.7.

**Table 3.2.3.7.**  
**Minimum Construction Requirements for Exposing Building Faces**  
Forming Part of Sentences 3.2.3.7.(1) and (2)

<i>Occupancy Classification of Building or Fire Compartment</i>	<i>Maximum Area of Unprotected Openings Permitted, % of Exposing Building Face Area</i>	<i>Minimum Required Fire-Resistance Rating</i>	<i>Type of Construction Required</i>	<i>Type of Cladding Required</i>
Group A, B, C, D, or Group F, Division 3	0 to 10	1 h	<i>Noncombustible</i>	<i>Noncombustible</i>
	> 10 to 25	1 h	<i>Combustible or Noncombustible</i>	<i>Noncombustible</i>
	> 25 to 50	45 min	<i>Combustible or Noncombustible</i>	<i>Noncombustible</i>
	> 50 to < 100	45 min	<i>Combustible or Noncombustible</i>	<i>Combustible or Noncombustible</i> <sup>(1)</sup>
Group E, or Group F, Division 1 or 2	0 to 10	2 h	<i>Noncombustible</i>	<i>Noncombustible</i>
	> 10 to 25	2 h	<i>Combustible or Noncombustible</i>	<i>Noncombustible</i>
	> 25 to 50	1 h	<i>Combustible or Noncombustible</i>	<i>Noncombustible</i>
	> 50 to < 100	1 h	<i>Combustible or Noncombustible</i>	<i>Combustible or Noncombustible</i>

**Notes to Table 3.2.3.7.:**

<sup>(1)</sup> The cladding on Group C buildings conforming to Article 3.2.2.50. and on Group D buildings conforming to Article 3.2.2.58. shall be *noncombustible*.

**3)** Except as provided in Article 3.1.4.8., the requirement in Table 3.2.3.7. for *noncombustible* cladding for buildings or fire compartments where the maximum permitted area of *unprotected openings* is more than 10% of the *exposing building face* is permitted to be waived for exterior wall assemblies that comply with Article 3.1.5.5.

**4)** Except as provided in Article 3.1.4.8., the requirement in Table 3.2.3.7. for *noncombustible* cladding for buildings or fire compartments where the maximum permitted area of *unprotected openings* is more than 25% but not more than 50% of the *exposing building face* is permitted to be waived where

- a) the *limiting distance* is greater than 5 m,
- b) the *building* or *fire compartment* and all *combustible* attic and roof spaces are *sprinklered* throughout,
- c) the cladding
  - i) conforms to Subsections 9.27.6. , 9.27.7. , 9.27.8. , 9.27.9. or 9.27.10.,
  - ii) is installed without furring members, or on furring not more than 25 mm thick, over gypsum sheathing at least 12.7 mm thick or over masonry, and
  - iii) after conditioning in conformance with ASTM D 2898, "Accelerated Weathering of Fire-Retardant-Treated Wood for Fire Testing," has a *flame-spread rating* not greater than 25 on the exterior face when tested in accordance with Sentence 3.1.12.1.(1),
- d) the cladding
  - i) conforms to Subsection 9.27.12.,
  - ii) is installed with or without furring members over gypsum sheathing at least 12.7 mm thick or over masonry,

- iii) has a *flame-spread rating* not greater than 25 when tested in accordance with Sentence 3.1.12.1.(2), and
- iv) does not exceed 2 mm in thickness exclusive of fasteners, joints and local reinforcements, or
- e) the exterior wall assembly complies with Article 3.1.5.5.

**5)** The construction requirements for the *exposing building face* stated in Sentences (1) and (2) shall be satisfied before increasing the *unprotected opening* area as permitted by Sentence 3.2.3.12.(1).

### 3.2.3.8. Protection of Exterior Building Face

**1)** Except as permitted by Sentence (3) and in addition to the requirements of Sentences 3.2.3.7.(1) and (2) and where the maximum permitted area of *unprotected openings* is greater than 10% of the *exposing building face*, foamed plastic insulation used in an exterior wall of a *building* more than 3 *storeys* in *building height* shall be protected on its exterior surface by

- a) concrete or masonry not less than 25 mm thick, or
- b) *noncombustible* material that complies with the criteria for testing and the conditions of acceptance stated in Sentence (2) when tested in conformance with CAN/ULC-S101, "Fire Endurance Tests of Building Construction and Materials."

**2)** The criteria for testing and the conditions of acceptance for a wall assembly to satisfy the requirements of Clause (1)(b) are that

- a) the fire exposed area of the wall assembly shall be not less than 9.3 m<sup>2</sup> and have no dimension less than 2.75 m,
- b) the exposed surface shall include typical vertical and horizontal joints,
- c) the test shall be continued for not less than 15 min and the standard time/temperature curve of the referenced standard shall be followed,
- d) the *noncombustible* protective material must remain in place and no through openings should develop that are visible when viewed normal to the face of the material, and
- e) the *noncombustible* protective material should not disintegrate in a manner that would permit fire to propagate along the surface of the test assembly.

**3)** The requirements of Sentence (1) are waived for wall assemblies that comply with the requirements of Article 3.1.5.5. (See Note A-3.1.4.1.(1).)

### 3.2.3.9. Protection of Structural Members

**1)** Structural members, including beams, columns and arches, that are placed wholly or partly outside the exterior face of a *building* and are less than 3 m from the property line or the centre line of a public thoroughfare shall be protected from exterior fire exposure by fire protection having a *fire-resistance rating* not less than that required for their protection from interior fire exposure, as stated in Articles 3.2.2.20. to 3.2.2.90., but not less than 1 h.

**2)** Structural members of *heavy timber construction*, including beams, columns and arches, that are placed wholly or partly outside the exterior face of a *building* and are 3 m or more from the property line or the centre line of a public thoroughfare need not be covered with *noncombustible* cladding.

### 3.2.3.10. Unlimited Unprotected Openings

**1)** An *exposing building face* in a *storage garage* with all *storeys* constructed as *open-air storeys* is permitted to have unlimited *unprotected openings* provided it has a *limiting distance* not less than 3 m.

**2)** The *exposing building face* of a *storey* that faces a *street* and is at the same level as the *street* is permitted to have unlimited *unprotected openings* if the *limiting distance* is not less than 9 m.

**3.2.3.11. Low Fire Load, One Storey Building**

- 1)** An *exposing building face* of a building of low-hazard industrial occupancy conforming to Article 3.2.2.89. is permitted to be of *noncombustible construction* without a *fire-resistance rating* provided
- a) it is not a *loadbearing wall*, and
  - b) the *limiting distance* is not less than 3 m.

**3.2.3.12. Area Increase for Unprotected Openings**

- 1)** Except as required by Sentence 3.2.3.7.(5), the maximum area of *unprotected openings* in any *exposing building face* of an un-sprinklered *building* is permitted to be doubled if the openings are glazed with
- a) glass block conforming to the requirements of Article 3.1.8.16., or
  - b) wired glass assemblies conforming to D-2.3.15. in Appendix D.

**3.2.3.13. Protection of Exit Facilities**

- 1)** Except as required by Sentence (3) and as permitted by Sentence 3.4.4.3.(1), if the plane of an exterior wall of an *exit* enclosure forms an angle less than 135° with the plane of an exterior wall of the *building* it serves, and an opening in the exterior wall of the *exit* enclosure could be exposed to fire from an opening in the exterior wall of the *building*, the opening in either the exterior wall of the *exit* or the exterior wall of the *building* shall be protected in conformance with the requirements of Sentence (4) where the opening in the exterior wall of the *building* is within 3 m horizontally and
- a) less than 10 m below an opening in the exterior wall of the *exit*, or
  - b) less than 2 m above an opening in the exterior wall of the *exit*.
- (See Note A-3.2.3.14.(1).)

- 2)** If an unenclosed exterior *exit* stair or ramp could be exposed to fire from an opening in the exterior wall of the *building* it serves, the opening in the exterior wall of the *building* shall be protected in conformance with the requirements of Sentence (4) where the opening in the exterior wall of the *building* is within 3 m horizontally and
- a) less than 10 m below the *exit* stair or ramp, or
  - b) less than 5 m above the *exit* stair or ramp.

- 3)** Except as permitted by Sentence 3.4.4.3.(1), if an exterior *exit* door in one *fire compartment* is within 3 m horizontally of an opening in another *fire compartment* and the exterior walls of these *fire compartments* intersect at an exterior angle of less than 135°, the opening shall be protected in conformance with the requirements of Sentence (4).

- 4)** The opening protection referred to in Sentences (1), (2) and (3) shall consist of
- a) glass block conforming to the requirements of Article 3.1.8.16.,
  - b) a wired glass assembly conforming to D-2.3.15. in Appendix D, or
  - c) a *closure* conforming to the requirements of Subsection 3.1.8. and Articles 3.2.3.1. and 3.2.3.14.

**3.2.3.14. Wall Exposed to Another Wall**

- 1)** Except as required by Sentences (3) and 3.2.3.13.(1) or as permitted by Sentence 3.2.3.19.(4), if an *unprotected opening* in an exterior wall of a *fire compartment* is exposed to an *unprotected opening* in the exterior wall of another *fire compartment*, and the planes of the 2 walls are parallel or at an angle less than 135°, measured from the exterior of the *building*, the *unprotected openings* in the 2 *fire compartments* shall be separated by a distance not less than  $D_o$  where

$$D_o = 2D - \left( \frac{\theta}{90} \times D \right)$$

but in no case less than 1 m, and

D = the greater required *limiting distance* for the *exposing building faces* of the 2 *fire compartments*, and

$\theta$  = the angle made by the intersecting planes of the *exposing building faces* of the 2 *fire compartments* (in the case where the exterior walls are parallel and face each other,  $\theta = 0^\circ$ ).

(See Note A-3.2.3.14.(1).)

**2)** The exterior wall of each *fire compartment* referred to in Sentence (1) within the distance,  $D_{or}$ , shall have a *fire-resistance rating* not less than that required for the interior vertical *fire separation* between the *fire compartment* and the remainder of the *building*.

**3)** Sentence (1) does not apply to *unprotected openings* of *fire compartments* within a *building* that is *sprinklered* throughout, but shall apply to

- a) *unprotected openings* of *fire compartments* on opposite sides of a *firewall*, and
- b) exposure from *unprotected openings* of a *fire compartment* that is not protected by an automatic sprinkler system.

### 3.2.3.15. Wall Exposed to Adjoining Roof

**1)** Except as permitted by Sentence 3.2.3.19.(4), if a wall in a *building* is exposed to a fire hazard from an adjoining roof of a separate *fire compartment* that is not *sprinklered* in the same *building*, and the exposed wall contains windows within 3 *storeys* vertically and 5 m horizontally of the roof, the roof shall contain no skylights within 5 m of the exposed wall.

### 3.2.3.16. Protection of Soffits

**1)** Except as permitted by Sentences (3) and (4), where there is a common *attic or roof space* above more than 2 *suites of residential occupancy* or above more than 2 *patients' sleeping rooms*, and the common *attic or roof space* projects beyond the exterior wall of the *building*, the soffit, and any opening in the soffit or other surface of the projection located within 2 500 mm of a window or door opening, shall be protected by

- a) *noncombustible* material
  - i) not less than 0.38 m thick, and
  - ii) having a melting point not below 650°C,
- b) plywood not less than 11 mm thick,
- c) strandboard or waferboard not less than 12.5 mm thick, or
- d) lumber not less than 11 mm thick.

**2)** The soffit protection required by Sentence (1) shall extend the full width of the opening and to not less than 1 200 mm on either side of it, and shall apply to all openings through the soffit within this limit.

**3)** If an eave overhang is completely separated from the remainder of the *attic or roof space* by the use of *fire blocks*, the requirements of Sentence (1) do not apply.

**4)** The protection required by Sentence (1) for projections is permitted to be omitted if

- a) the *fire compartments* behind the window and door openings are *sprinklered* in accordance with Article 3.2.5.12., and
- b) all rooms, including closets and bathrooms, having openings in the wall beneath the soffit are *sprinklered*, notwithstanding exceptions permitted in the standards referenced in Article 3.2.5.12. for the installation of automatic sprinkler systems.

### 3.2.3.17. Canopy Protection for Vertically Separated Openings

**1)** Except as permitted by Sentences (2) and (3), if a *storey* classified as a Group E or Group F, Division 1 or 2 *major occupancy* is required to be separated from the *storey* above by a *fire separation*,

- a) every opening in the exterior wall of the lower *storey* that is located vertically below an opening in the *storey* above shall be separated from the *storey*

- above by a canopy projecting not less than 1 m from the face of the *building* at the intervening floor level, and
- b) the canopy required by Clause (a) shall have a *fire-resistance rating* not less than that required for the floor assembly but need not be more than 1 h, except as required elsewhere in this Subsection.

**2)** Except as permitted by Sentence (3), the canopy required by Sentence (1) is permitted to be omitted if the exterior wall of the upper *storey* is recessed not less than 1 m behind the exterior wall containing the opening in the lower *storey*.

**3)** The requirements of Sentences (1) and (2) are permitted to be waived if the *building* is *sprinklered* throughout.

### 3.2.3.18. Covered Vehicular Passageway

**1)** A covered vehicular passageway designed as a receiving or shipping area shall be separated from every *building* or part of a *building* adjoining it by a *fire separation* having a *fire-resistance rating* not less than 1.5 h.

**2)** A covered vehicular passageway constructed below *grade* shall be of *noncombustible construction*.

### 3.2.3.19. Walkway between Buildings

**1)** Except as required by Sentence 3.2.3.20.(2), if *buildings* are connected by a *walkway*, each *building* shall be separated from the *walkway* by a *fire separation* with a *fire-resistance rating* not less than 45 min .

**2)** Except as permitted by Sentence (3), a *walkway* connected to a *building* required to be of *noncombustible construction* shall also be of *noncombustible construction*.

**3)** A *walkway* connected to a *building* required to be of *noncombustible construction* is permitted to be of *heavy timber construction* provided

- a) not less than 50% of the area of any enclosing perimeter walls is open to the outdoors, and
- b) the *walkway* is at ground level.

**4)** A *walkway* of *noncombustible construction* used only as a pedestrian thoroughfare need not conform to the requirements of Articles 3.2.3.14. and 3.2.3.15.

**5)** A *walkway* between *buildings* shall be not more than 9 m wide.

### 3.2.3.20. Underground Walkway

**1)** An underground *walkway* shall not be designed or used for any purpose other than pedestrian travel unless

- a) the purpose is acceptable to the *authority having jurisdiction*, and
- b) sprinklers are installed in any space in the *walkway* containing an *occupancy*.

**2)** *Buildings* connected by an underground *walkway* shall be separated from the *walkway* by a *fire separation* with a *fire-resistance rating* not less than 1 h.

**3)** An underground *walkway* shall be of *noncombustible construction* suitable for an underground location.

**4)** In an underground *walkway*

- a) smoke barrier doors shall be installed at intervals of not more than 100 m, or
- b) the travel distance from the door of an adjacent room or space to the nearest *exit* shall be not more than one and a half times the least allowable travel distance to an *exit* for any of the adjacent *occupancies* as permitted by Sentence 3.4.2.5.(1).

**5)** An underground *walkway* between *buildings* shall be not more than 9 m wide.

### 3.2.3.21. Storage and Process Equipment Located Outdoors

**1)** Location of outdoor storage and outdoor process equipment in relation to *buildings* shall conform to Parts 3 and 4 of Division B of the NFC.

**3.2.3.22. Installation of Service Lines Under Buildings**

**1)** When a *building* is erected over existing buried flammable gas mains, such service lines shall be encased in gas-tight conduits in conformance with CSA Z662 Package, "Oil and Gas Pipeline Systems/CSA Z662-11, Commentary on Oil and Gas Pipeline Systems."

**3.2.4. Fire Alarm and Detection Systems**

(See Note A-3.2.4.)

**3.2.4.1. Determination of Requirement for a Fire Alarm System**

**1)** Except as permitted in Sentences (2) and (3), a fire alarm system shall be installed in *buildings* in which an automatic sprinkler system is installed.

**2)** *Buildings* in which a sprinkler system is installed in accordance with NFPA 13D, "Installation of Sprinkler Systems in One- and Two-Family Dwellings and Manufactured Homes," need not comply with Sentence (1).

**3)** *Buildings* that contain fewer than 9 sprinklers conforming to Sentence 3.2.5.12.(4) need not comply with Sentence (1).

**4)** Except as permitted by Sentences (5) to (7) and Sentence 3.2.4.2.(4), a fire alarm system shall be installed in a *building* that is not *sprinklered* throughout and that contains

- a) a *contained use area*,
- b) an *impeded egress zone*,
- c) more than 3 *storeys*, including the *storeys* below the *first storey*,
- d) a total *occupant load* more than 300, other than in open air seating areas,
- e) an *occupant load* more than 150 above or below the *first storey*, other than in open air seating areas,
- f) a school, college, or child *care* facility, including a daycare facility, with an *occupant load* more than 40,
- g) a licensed beverage establishment or a licensed restaurant, with an *occupant load* more than 150,
- h) a *low-hazard industrial occupancy* with an *occupant load* more than 75 above or below the *first storey*,
- i) a *medium-hazard industrial occupancy* with an *occupant load* more than 75 above or below the *first storey*,
- j) a *residential occupancy* with sleeping accommodation for more than 10 persons,
- k) a *high-hazard industrial occupancy* with an *occupant load* more than 25, or
- l) an *occupant load* more than 300 below an open air seating area.

**5)** Where each *dwelling unit* in an apartment *building* that is not *sprinklered* has direct access to an exterior *exit* facility leading to ground level, a fire alarm system is not required if

- a) not more than 4 *dwelling units* share a common *means of egress*, or
- b) the *building* is not more than 3 *storeys* in *building height*.

**6)** A fire alarm system is not required in a hotel or motel 3 *storeys* or less in *building height* that is contained in a *building* that is not *sprinklered* provided each *suite* has direct access to an exterior *exit* facility leading to ground level.

**7)** A fire alarm system is not required in a *storage garage* conforming to Article 3.2.2.90. that is contained in a *building* that is not *sprinklered* provided there are no other *occupancies* in the *building*.

**3.2.4.2. Continuity of Fire Alarm System**

**1)** Except as permitted by Sentence (6), if there are openings through a *firewall*, other than those for piping, tubing, wiring and totally enclosed *noncombustible* raceways, the requirements in this Subsection shall apply to the *floor areas* on both sides of the *firewall* as if they were in the same *building*.

**2)** Except as permitted by Sentence (4), if a *building* contains more than one *major occupancy* and a fire alarm system is required, a single system shall serve all *occupancies*.

**3)** Except as permitted by Sentence (4), if a fire alarm system is required in any portion of a *building*, it shall be installed throughout the *building*.

**4)** Except as required by Sentence (5), the requirements in this Subsection are permitted to be applied to each portion of a *building* not more than 3 *storeys* in *building height*, in which a vertical *fire separation* having a *fire-resistance rating* not less than 1 h separates the portion from the remainder of the *building* as if it were a separate *building*, provided there are no openings through the *fire separation*, other than those for piping, tubing, wiring and totally enclosed *noncombustible* raceways.

**5)** The permission in Sentence (4) to consider separated portions of a *building* as separate *buildings* does not apply to *service rooms* and storage rooms.

**6)** *Buildings* interconnected by *walkways* permitted in Articles 3.2.3.19. and 3.2.3.20. or by vestibules provided in conformance with Article 3.2.6.3. shall be treated as separate *buildings* for the purpose of fire alarm installation required by this Subsection.

### 3.2.4.3. Types of Fire Alarm Systems

- 1)** A fire alarm system shall be
  - a) a single-stage system in a Group F, Division 1 *occupancy*,
  - b) except as permitted in Clause (c), a 2-stage system in a Group B *occupancy*,
  - c) a single- or 2-stage system in a Group B, Division 3 *occupancy* where the *building* is 3 *storeys* or less in *building height*, and
  - d) a single- or 2-stage system in all other cases.

### 3.2.4.4. Description of Fire Alarm Systems

**1)** A single stage fire alarm system shall, upon the operation of any manual station, waterflow detecting device, or *fire detector*, cause an *alarm signal* to sound on all audible signal devices in the system. (See Note A-3.2.4.4.(1).)

- 2)** A 2-stage fire alarm system shall
  - a) cause an *alert signal* to sound upon the operation of any manual station, waterflow detecting device, or *fire detector*,
  - b) automatically cause an *alarm signal* to sound if the *alert signal* is not acknowledged within 5 min of its initiation, and
  - c) have manual stations, each of which is equipped so that the use of a key or other similar device causes an *alarm signal* to sound that continues to sound upon removal of the key or similar device from the manual station (see Note A-3.2.4.4.(2)(c)).

(See Note A-3.2.4.4.(2).)

- 3)** A 2-stage fire alarm system is permitted to be zone coded so that, upon the operation of any manual station, waterflow detecting device, or *fire detector*,
  - a) a coded *alert signal* is sounded indicating the zone of alarm initiation,
  - b) the coded *alert signal* is repeated in its entirety not less than 4 times, and
  - c) a continuous *alert signal* is sounded upon completion of the coded signals referred to in Clause (b) and Sentence (4).

**4)** If a second manual station, waterflow detecting device, or *fire detector* is operated in a fire alarm system with zone coding as permitted by Sentence (3), in a zone other than that for which the first *alert signal* was sounded, the coded *alert signal* for the first zone shall be completed before the coded *alert signal* for the second zone is repeated not less than 4 times.

### 3.2.4.5. Installation and Verification of Fire Alarm Systems

**1)** Fire alarm systems, including the voice communication capability where provided, shall be installed in conformance with CAN/ULC-S524, "Installation of Fire Alarm Systems."

**2)** Fire alarm systems shall be verified in conformance with CAN/ULC-S537, "Verification of Fire Alarm Systems," to ensure they are operating satisfactorily.

**3.2.4.6. Silencing of Alarm Signals**

- 1)** A fire alarm system shall be designed so that when an *alarm signal* is actuated, it cannot be silenced automatically before a period of time has elapsed that is not less than
  - a) 5 min for a *building* not required to be equipped with an annunciator, and
  - b) 20 min for any other *building*.
- 2)** Except as permitted by Sentence 3.2.4.18.(7) and Sentences 3.2.4.22.(2) and (3), a fire alarm system shall not incorporate manual silencing switches other than those installed inside the fire alarm control unit. (See Note A-3.2.4.6.(2).)

**3.2.4.7. Signals to Fire Department**

- 1)** A single stage fire alarm system installed in a *building of assembly occupancy* that has an *occupant load* more than 300 shall be designed to notify the fire department, in conformance with Sentence (4), that an *alarm signal* has been initiated.
- 2)** A fire alarm system that includes waterflow-indicating devices shall be designed to notify the fire department in conformance with Sentence (4) when an alarm is initiated.
- 3)** A 2-stage fire alarm system shall be designed to notify the fire department, in conformance with Sentence (4), that an *alert signal* has been initiated.
- 4)** Notification of the fire department, as required by Sentences (1), (2) and (3), shall be provided in conformance with CAN/ULC-S561, "Installation and Services for Fire Signal Receiving Centres and Systems." (See Note A-3.2.4.7.(4).)
- 5)** Where a single stage fire alarm system is installed in a *building* that is not *sprinklered* throughout and Sentence (1) does not apply, a legible notice that is not easily removed shall be affixed to the wall near each manual station stating
  - a) that the fire department is to be notified in the event of a fire emergency, and
  - b) the emergency telephone number for the municipality or for the fire department (see Note A-3.2.4.7.(5)(b)).
- 6)** Helicopter landing areas on roofs shall be provided with telephone extensions or means to notify the fire department.

**3.2.4.8. Annunciator and Zone Indication**

- 1)** Except as permitted by Sentences (3) to (5), an annunciator shall be installed in close proximity to a *building* entrance that faces a *street* or an access route for fire department vehicles that complies with Sentence 3.2.5.5.(1).
- 2)** Except as permitted by Sentence (6), the annunciator required by Sentence (1) shall have separate zone indication of the actuation of the alarm initiating devices in each
  - a) *floor area* so that the area of coverage for each zone in a *building* that is not *sprinklered* is not more than 2 000 m<sup>2</sup>,
  - b) *floor area* so that the area of coverage for each zone is neither
    - i) more than one *storey*, nor
    - ii) more than the system area limits specified in NFPA 13, "Installation of Sprinkler Systems,"
  - c) shaft required to be equipped with *smoke detectors*,
  - d) air-handling system required to be equipped with *smoke detectors*,
  - e) fire extinguishing system required by NFPA 96, "Ventilation Control and Fire Protection of Commercial Cooking Operations,"
  - f) *contained use area*,
  - g) *impeded egress zone*, and
  - h) *fire compartment* required by Sentence 3.3.3.5.(2).
 (See Note A-3.2.4.8.(2).)
- 3)** An annunciator need not be provided for a fire alarm system if not more than one zone indicator is required by Sentence (2).



**4)** If an annunciator is not installed as part of a fire alarm system in conformance with Sentence (1), a visual and audible trouble signal device shall be provided inside the main entrance of the *building*.

- 5)** The requirements of Sentence (1) are waived in a *building*
- a) in which an automatic sprinkler system is not installed,
  - b) that has an aggregate area for all *storeys* of not more than 2 000 m<sup>2</sup>, and
  - c) that is not more than 3 *storeys* in *building height*.

**6)** The area limits of Clause (2)(a) are waived for an interior undivided open space used as an arena, a rink, or a swimming pool provided that other spaces in the *building* that are separated from the open space are individually zoned in accordance with the requirements of Sentence (2).

**7)** A fire alarm control unit installed in close proximity to a *building* entrance that faces a *street* or an access route for fire department vehicles that complies with Sentence 3.2.5.5.(1) is deemed to satisfy the requirement for an annunciator, provided all indicators required for an annunciator or trouble signal device are included on the control unit.

### 3.2.4.9. Electrical Supervision

**1)** Electrical supervision shall be provided for a fire alarm system.

**2)** If a fire alarm system in a *building* is required to have an annunciator by Sentence 3.2.4.8.(1), except for hose valves, all valves controlling water supplies in a standpipe system shall be equipped with an electrically supervised switch for transmitting a trouble signal to the annunciator in the event of movement of the valve handle.

**3)** An automatic sprinkler system shall be electrically supervised to indicate a supervisory signal on the *building* fire alarm system annunciator for each of the following:

- a) movement of a valve handle that controls the supply of water to sprinklers,
- b) loss of excess water pressure required to prevent false alarms in a wet pipe system,
- c) loss of air pressure in a dry pipe system,
- d) loss of air pressure in a pressure tank,
- e) a significant change in water level in any water storage container used for firefighting purposes,
- f) loss of power to any automatically starting fire pump (see Note A-3.2.4.9.(3)(f)), and
- g) a temperature approaching the freezing point in any dry pipe valve enclosure or water storage container used for firefighting purposes.

**4)** A fire pump shall be electrically supervised as stipulated in NFPA 20, "Installation of Stationary Pumps for Fire Protection."

**5)** Indication of a supervisory signal in accordance with Sentence (3) shall be transmitted to the fire department in conformance with Sentence 3.2.4.7.(4).

### 3.2.4.10. Fire Detectors

**1)** *Fire detectors* required by this Code shall be connected to the fire alarm system.

**2)** Except as permitted by Sentence (3), if a fire alarm system is required in a *building* that is not *sprinklered*, *fire detectors* shall be installed in the following spaces:

- a) storage rooms not within *dwelling units*,
- b) *service rooms* not within *dwelling units*,
- c) janitors' rooms,
- d) rooms in which hazardous substances are to be used or stored (see Note A-3.3.1.2.(1)),
- e) elevator hoistways and dumbwaiter shafts, and
- f) laundry rooms in *buildings of residential occupancy*, but not those within *dwelling units*.

**3)** *Fire detectors* required by Sentence (2) need not be provided within *floor areas* that are *sprinklered*.

**4)** *Fire detectors* required by Sentence (2) shall be installed in elevator hoistways and dumbwaiter shafts where a sprinkler system is not installed within the hoistway or shaft.

### 3.2.4.11. Smoke Detectors

- 1)** If a fire alarm system is installed, *smoke detectors* shall be installed in
  - a) except as permitted in Sentence (2), each sleeping room and each corridor serving as part of a *means of egress* from sleeping rooms in portions of a *building* classified as a Group B *major occupancy*,
  - b) each room in a *contained use area* and corridors serving those rooms,
  - c) each corridor in portions of a *building* classified as a Group A, Division 1 *major occupancy*,
  - d) each *public corridor* in portions of a *building* classified as a Group C *major occupancy*,
  - e) each *exit* stair shaft other than those serving only a Group A, Division 4 *major occupancy* or an open *storage garage*,
  - f) the vicinity of draft stops required by Article 3.2.8.6., and
  - g) elevator machine rooms.

(See Note A-3.2.4.11.(1).)

**2)** *Smoke detectors* need not be installed in sleeping rooms and in corridors serving the sleeping rooms within a *suite of care occupancy* where *smoke alarms* are installed in accordance with Article 3.2.4.20.

**3)** *Smoke detectors* required in the sleeping rooms of a *care, treatment* or *detention occupancy* shall, upon actuation, provide an audible and visible signal to staff serving those rooms so that the room or location containing the actuated *smoke detector* can be easily identified. (See Note A-3.2.4.11.(3).)

**4)** *Smoke detectors* required in Clause (1)(g) shall, upon actuation, recall the elevators served by the elevator machine room in which the *smoke detector* is installed.

**5)** Except as permitted in Sentences (6) and (7), *smoke detectors* installed in *buildings* required to be equipped with a fire alarm system shall be located near the entrance to *walkways* described in Articles 3.2.3.19. and 3.2.3.20. or vestibules provided in conformance with Article 3.2.6.3.

**6)** *Smoke detectors* installed at the entrance to the *walkways* in conformance with Article 3.1.8.14. shall be deemed to meet the requirements of Sentence (5).

**7)** *Smoke detectors* required by Sentence (5) may be replaced with *fire detectors* in Group F *occupancies* where the *smoke detectors* may be subjected to false alarms due to the activities within the *building*.

### 3.2.4.12. Prevention of Smoke Circulation

**1)** If a fire alarm system is installed, an air-handling system shall be designed to prevent the circulation of smoke upon a signal from a duct-type *smoke detector* if the air-handling system

- a) serves more than one *storey*,
- b) serves more than one *suite* in a *storey*, or
- c) serves more than one *fire compartment* required by Sentence 3.3.3.5.(2).

### 3.2.4.13. Vacuum Cleaning System Shutdown

**1)** A central vacuum cleaning system in a *building* equipped with a fire alarm system shall be designed to shut down upon actuation of the fire alarm system.

### 3.2.4.14. Elevator Emergency Return

**1)** Except as permitted by Sentence (3), in a *building* having elevators that serve *storeys* above the *first storey* and that are equipped with an automatic emergency recall feature, *smoke detectors* shall be installed in the elevator lobbies on the recall level so

that when these *smoke detectors* are actuated, the elevators will automatically return directly to an alternate floor level.

**2)** *Smoke detectors* required by Sentence (1) shall be designed as part of the *building* fire alarm system.

**3)** The alternate floor recall feature required by Sentence (1) is not required if the *floor area* containing the recall level is *sprinklered* throughout.

### 3.2.4.15. System Monitoring

**1)** An automatic sprinkler system shall be equipped with waterflow detecting devices and, if an annunciator is required by Article 3.2.4.8., shall be installed so that each device serves

- a) not more than one *storey*, and
- b) an area on each *storey* that is not more than the system area limits as specified in NFPA 13, "Installation of Sprinkler Systems."

**2)** Waterflow-detecting devices required by Sentence (1) shall be connected to the fire alarm system so that, upon its actuation, an *alert signal* or an *alarm signal* is initiated.

**3)** The actuation of each waterflow detecting device required by Sentence (1) shall be indicated separately on the fire alarm system annunciator.

### 3.2.4.16. Manual Stations

**1)** Except as permitted by Sentences (2) and (3), where a fire alarm system is installed, a manual station shall be installed in every *floor area* near

- a) every principal entrance to the *building*, and
- b) every *exit*.

(See Note A-3.2.4.16.(1).)

**2)** In a *building* that is *sprinklered* throughout, a manual station is not required at an exterior egress doorway from a *suite* that does not lead to an interior shared *means of egress* in a hotel or motel not more than 3 *storeys* in *building height*, provided each *suite* is served by an exterior *exit* facility leading directly to ground level.

**3)** In a *building* that is *sprinklered* throughout, a manual station is not required at an exterior egress doorway from a *dwelling unit* that does not lead to an interior shared *means of egress* in a *building* not more than 3 *storeys* in *building height* containing only *dwelling units*, provided each *dwelling unit* is served by an exterior *exit* facility leading directly to ground level.

**4)** In a *building* referred to in Sentences (2) or (3), manual stations shall be installed near doorways leading from shared interior corridors to the exterior.

**5)** Where a fire alarm system is installed, a manually operated fire alarm station shall be installed on the roof at each *exit* from a helicopter landing area.

### 3.2.4.17. Alert and Alarm Signals

**1)** In a 2-stage fire alarm system described in Sentence 3.2.4.4.(2), the same audible signal devices are permitted to be used to sound the *alert signals* and the *alarm signals*.

**2)** If audible signal devices with voice reproduction capabilities are intended for paging and similar voice message use, other than during a fire emergency, they shall be installed so that *alert signals* and *alarm signals* take priority over all other signals.

**3)** Audible signal devices forming part of a fire alarm or voice communication system shall not be used for playing music or background noise.

**3.2.4.18. Audibility of Alarm Systems**

(See Note A-3.2.4.18.)

- 1)** Audible signal devices forming part of a fire alarm system shall be installed in a *building* so that
- alarm signals* are clearly audible throughout the *floor area*, and
  - alert signals* are clearly audible in continuously staffed locations, and where there are no continuously staffed locations, throughout the *floor area*.
- (See Note A-3.2.4.18.(1).)
- 2)** The sound pattern of an *alarm signal* shall conform to the temporal pattern defined in Clause 4.2 of ISO 8201, "Acoustics – Audible emergency evacuation signal." (See Note A-3.2.4.18.(2).)
- 3)** The sound patterns of *alert signals* shall be significantly different from the temporal patterns of *alarm signals*. (See Note A-3.2.4.18.(3).)
- 4)** The fire *alarm signal* sound pressure level shall be not more than 110 dBA in any normally occupied area. (See Note A-3.2.4.18.(4).)
- 5)** The sound pressure level in a sleeping room from a fire alarm audible signal device shall be not less than 75 dBA in a *building* of *residential* or *care occupancy* when any intervening doors between the device and the sleeping room are closed. (See Note A-3.2.4.18.(5).)
- 6)** Except as required by Sentence (5), the sound pressure level from a fire alarm system's audible signal device within a *floor area* shall be not less than 10 dBA above the ambient noise level without being less than 65 dBA.
- 7)** Except as permitted by Sentence (11), audible signal devices located within a *dwelling unit* shall include a means for them to be manually silenced for a period of not more than 10 min, after which time the devices shall restore themselves to normal operation. (See Note A-3.2.4.18.(7).)
- 8)** Audible signal devices within a *dwelling unit* or a *suite* of *residential* or *care occupancy* shall be connected to the fire alarm system
- in a manner such that a single open circuit at one device will not impair the operation of other audible signal devices on that same circuit that serve the other *dwelling units* or *suites* of *residential* or *care occupancy*, or
  - on separate signal circuits that are not connected to the devices in any other *dwelling unit*, *public corridor* or *suite* of *residential* or *care occupancy*.
- (See Note A-3.2.4.18.(8) and (9).)
- 9)** In a *building* or part thereof classified as a *residential* or *care occupancy*,
- separate circuits shall be provided for audible signal devices on each *floor area*, and
  - audible signal devices within *dwelling units* or *suites* of *residential* or *care occupancy* shall be wired on separate signal circuits from those not within *dwelling units* or *suites* of *residential* or *care occupancy*.
- (See Note A-3.2.4.18.(8) and (9).)
- 10)** Audible signal devices shall be installed in a *service space* referred to in Sentence 3.2.1.1.(8) and shall be connected to the fire alarm system.
- 11)** Audible signal devices within *dwelling units* that are wired on separate signal circuits need not include a means for silencing as required by Sentence (7) provided the fire alarm system includes a provision for an automatic signal silence within *dwelling units*, where
- the automatic signal silence cannot occur within the first 60 s of operation or within the zone of initiation,
  - a subsequent alarm elsewhere in the *building* will reactuate the silenced audible signal devices within *dwelling units*,
  - after a period of not more than 10 min, the silenced audible signal devices will be restored to continuous audible signal if the alarm is not acknowledged, and
  - the voice communication system referred to in Article 3.2.4.22. has a provision to override the automatic signal silence to allow the transmission

of voice messages through silenced audible signal device circuits that serve the *dwelling units*.  
(See Note A-3.2.4.18.(7).)

**12)** If a 2-stage fire alarm system has been installed with an automatic signal silence as described in Sentence (11), the system shall be designed so that any silenced audible signal devices serving *dwelling units* are reactivated whenever an *alarm signal* is required to be transmitted as part of the second stage. (See Note A-3.2.4.18.(7).)

**3.2.4.19. Visual Signals**

- 1)** Visual signal devices shall be installed in addition to *alarm signals*
  - a) in *buildings* or portions thereof intended for use primarily by persons with a hearing impairment,
  - b) in *assembly occupancies* in which music and other sounds associated with performances could exceed 100 dBA,
  - c) in any *floor area* in which the ambient noise level is more than 87 dBA, and
  - d) in any *floor area* in which the occupants
    - i) use ear protection devices,
    - ii) are located in an audiometric booth, or
    - iii) are located in sound-insulating enclosures.

**2)** Visual signal devices required by Sentence (1) shall be installed so that the signal from at least one device is visible throughout the *floor area* or portion thereof in which they are installed. (See Note A-3.2.4.19.(2).)

**3.2.4.20. Smoke Alarms**

**1)** Except as provided in Article 3.2.4.21., *smoke alarms* shall be installed in accordance with this Article.

**2)** Except as required by Sentence (5) and permitted by Sentence (8), *smoke alarms* conforming to CAN/ULC-S531, "Smoke Alarms," shall be installed in each *dwelling unit* and, except for *care, treatment* or *detention occupancies* required to have a fire alarm system, in each sleeping room not within a *dwelling unit* or *suite* of *care occupancy*.

**3)** At least one *smoke alarm* shall be installed on each *storey* of a *dwelling unit* or *suite* of *care occupancy*.

**4)** On any *storey* of a *dwelling unit* containing sleeping rooms, a *smoke alarm* shall be installed

- a) in each sleeping room, and
- b) in a location between the sleeping rooms and the remainder of the *storey*, and if the sleeping rooms are served by a hallway, the *smoke alarm* shall be located in the hallway.

**5)** Where a *care occupancy* has individual *suites* for residents, a *smoke alarm* shall be installed

- a) in each sleeping room, and
- b) in a location between the sleeping rooms and the remainder of the *suite*, and if the sleeping rooms are served by a corridor within the *suite*, the *smoke alarm* shall be located in the corridor.

**6)** A *smoke alarm* shall be installed on or near the ceiling.

**7)** Except as permitted in Sentence (8), *smoke alarms* referred in Sentence (2) shall

- a) be installed with permanent connections to an electrical circuit (see Note A-3.2.4.20.(7)(a)),
- b) have no disconnect switch between the overcurrent device and the *smoke alarm*, and
- c) in case the regular power supply to the *smoke alarm* is interrupted, be provided with a battery as an alternative power source that can continue to provide power to the *smoke alarm* for a period of no less than 7 days in the normal condition, followed by 4 minutes of alarm.

**8)** Suites of residential occupancy are permitted to be equipped with *smoke detectors* in lieu of *smoke alarms*, provided the *smoke detectors*

- a) are capable of independently sounding audible signals within the individual suites,
- b) except as permitted in Sentence (9), are installed in conformance with CAN/ULC-S524, "Installation of Fire Alarm Systems," and
- c) form part of the fire alarm system.

(See Note A-3.2.4.20.(8).)

**9)** *Smoke detectors* permitted to be installed in lieu of *smoke alarms* as stated in Sentence (8) are permitted to sound localized alarms within individual suites, and need not sound an alarm throughout the rest of the *building*.

**10)** If more than one *smoke alarm* is required in a *dwelling unit*, the *smoke alarms* shall be wired so that the actuation of one *smoke alarm* will cause all *smoke alarms* within the *dwelling unit* to sound.

**11)** A *smoke alarm* required by Sentence (2) shall be installed in conformance with CAN/ULC-S553, "Installation of Smoke Alarms."

**12)** Except as permitted in Sentence (13), a manually operated silencing device shall be incorporated within the circuitry of a *smoke alarm* installed in a *dwelling unit* so that it will silence the signal emitted by the *smoke alarm* for a period of not more than 10 min, after which the *smoke alarm* will reset and again sound the alarm if the level of smoke in the vicinity is sufficient to reactuate the *smoke alarm*.

**13)** Suites of residential occupancy equipped with *smoke detectors* installed to CAN/ULC-S524, "Installation of Fire Alarm Systems," as part of the fire alarm system in lieu of *smoke alarms* as permitted by Sentence (8), need not incorporate the manually operated device required in Sentence (12). (See Note A-3.2.4.20.(8).)

**14)** The sound patterns of *smoke alarms* shall

- a) meet the temporal patterns of *alarm signals* (see Note A-3.2.4.18.(2)), or
- b) be a combination temporal pattern and voice relay.

### 3.2.4.21.

#### Residential Fire Warning Systems

**1)** Except where a fire alarm system is installed or required in a *building*, *smoke detectors* forming part of a residential fire warning system installed in conformance with CAN/ULC-S540, "Residential Fire and Life Safety Warning Systems: Installation, Inspection, Testing and Maintenance," are permitted to be installed in lieu of all *smoke alarms* required by Article 3.2.4.20., provided the system

- a) is capable of sounding audible signals in accordance with Articles 9.10.19.2. and 9.10.19.5.,
- b) is powered in accordance with Article 9.10.19.4., and
- c) is provided with a silencing device in accordance with Article 9.10.19.6.

### 3.2.4.22.

#### Voice Communication Systems

**1)** A voice communication system required by Subsection 3.2.6. and Sentences (7) to (10) shall

- a) consist of a two-way means of communication with the central alarm and control facility and to the mechanical control centre from each *floor area*, and
- b) be capable of broadcasting prerecorded, synthesized, or live messages from the central alarm and control facility that are audible and intelligible in all parts of the *building*, except that this requirement does not apply to elevator cars (see Note A-3.2.4.22.(1)(b)).

**2)** The voice communication system referred to in Sentence (1) shall include a means to silence the *alarm signal* in a single stage fire alarm system while voice instructions are being transmitted, but only after the *alarm signal* has initially sounded for not less than 30 s.

**3)** The voice communication system referred to in Sentence (1) shall include a means to silence the *alert signal* and the *alarm signal* in a 2-stage fire alarm system while

voice instructions are being transmitted, but only after the *alert signal* has initially sounded for not less than

- a) 10 s in hospitals that have supervisory personnel on duty for twenty-four hours each day, or
- b) 30 s for all other *occupancies*.

**4)** The voice communication system referred to in Clause (1)(b) shall be designed so that the *alarm signal* in a 2-stage fire alarm system can be selectively transmitted to any zone or zones while maintaining an *alert signal* or selectively transmitting voice instructions to any other zone or zones in the *building*.

**5)** The 2-way communication system referred to in Clause (1)(a) shall be installed so that emergency telephones are located in each *floor area* near *exit* stair shafts.

**6)** Visual signal devices required by Sentence 3.2.4.19.(1) shall continue to emit a visible signal while voice instructions are being transmitted.

**7)** Except for Group B, Division 1 and Group F, Division 1 *major occupancies*, where a fire alarm system is required under Subsection 3.2.4., a voice communication system shall be installed in *buildings* where a 2-stage fire alarm system is installed and whose *occupant load* exceeds 1 000.

**8)** A voice communication system required by Sentence (7) shall consist of loudspeakers that are

- a) operated from the central alarm and control facility or, in the absence of such a facility, from a designated area, and
- b) except in elevator cars, designed and located so that transmitted messages are audible and intelligible in all parts of the *building*.

(See Note A-3.2.4.22.(1)(b).)

**9)** Where the facility is not equipped with staff trained to provide instructions over the loudspeakers, a pre-recorded message shall be provided.

**10)** The voice communication system required by Sentence (7) shall meet the silencing and transmission requirements of Sentences (2) to (4).

### 3.2.5. Provisions for Firefighting

(See Note A-3.)

#### 3.2.5.1. Access to Above-Grade Storeys

**1)** Except for *storeys* below the *first storey*, direct access for firefighting shall be provided from the outdoors to every *storey* that is not *sprinklered* throughout and whose floor level is less than 25 m above *grade*, by at least one unobstructed window or access panel for each 15 m of wall in each wall required to face a *street* by Subsection 3.2.2.

**2)** An opening for access required by Sentence (1) shall

- a) have a sill no higher than 900 mm above the inside floor, and
- b) be not less than 1 100 mm high by not less than
  - i) 550 mm wide for a *building* not designed for the storage or use of *dangerous goods*, or
  - ii) 750 mm wide for a *building* designed for the storage or use of *dangerous goods*.

**3)** Access panels above the *first storey* shall be readily openable from both inside and outside, or the opening shall be glazed with plain glass.

#### 3.2.5.2. Access to Basements

**1)** Direct access from at least one *street* shall be provided from the outdoors in a *building* that is not *sprinklered* to each *basement* having a horizontal dimension more than 25 m.

- 2) The access required by Sentence (1) is permitted to be provided by
  - a) doors, windows or other means that provide an opening not less than 1 100 mm high and 550 mm wide, with a sill no higher than 900 mm above the inside floor, or
  - b) an interior stairway immediately accessible from the outdoors.

### 3.2.5.3. Roof Access

- 1) On a *building* more than 3 storeys in *building height* where the slope of the roof is less than 1 in 4, all main roof areas shall be provided with direct access from the *floor areas* immediately below, either by
  - a) a stairway, or
  - b) a hatch not less than 550 mm by 900 mm with a fixed ladder.

### 3.2.5.4. Access Routes

- 1) A *building* which is more than 3 storeys in *building height* or more than 600 m<sup>2</sup> in *building area* shall be provided with access routes for fire department vehicles
  - a) to the *building* face having a principal entrance, and
  - b) to each *building* face having access openings for firefighting as required by Articles 3.2.5.1. and 3.2.5.2.
 (See Note A-3.2.5.4.(1).)

### 3.2.5.5. Location of Access Routes

- 1) Access routes required by Article 3.2.5.4. shall be located so that the principal entrance and every access opening required by Articles 3.2.5.1. and 3.2.5.2. are located not less than 3 m and not more than 15 m from the closest portion of the access route required for fire department use, measured horizontally from the face of the *building*.
- 2) Access routes shall be provided to a *building* so that
  - a) for a *building* provided with a fire department connection, a fire department pumper vehicle can be located adjacent to the hydrants referred to in Article 3.2.5.15.,
  - b) for a *building* not provided with a fire department connection, a fire department pumper vehicle can be located so that the length of the access route from a hydrant to the vehicle plus the unobstructed path of travel for the firefighter from the vehicle to the *building* is not more than 90 m, and
  - c) the unobstructed path of travel for the firefighter from the vehicle to the *building* is not more than 45 m.
- 3) The unobstructed path of travel for the firefighter required by Sentence (2) from the vehicle to the *building* shall be measured from the vehicle to the fire department connection provided for the *building*, except that if no fire department connection is provided, the path of travel shall be measured to the principal entrance of the *building*.
- 4) If a portion of a *building* is completely cut off from the remainder of the *building* so that there is no access to the remainder of the *building*, the access routes required by Sentence (2) shall be located so that the unobstructed path of travel from the vehicle to one entrance of each portion of the *building* is not more than 45 m.

### 3.2.5.6. Access Route Design

- 1) A portion of a roadway or yard provided as a required access route for fire department use shall
  - a) have a clear width not less than 6 m, unless it can be shown that lesser widths are satisfactory,
  - b) have a centre-line radius not less than 12 m,
  - c) have an overhead clearance not less than 5 m,
  - d) have a change of gradient not more than 1 in 12.5 over a minimum distance of 15 m,
  - e) be designed to support the expected loads imposed by firefighting equipment and be surfaced with concrete, asphalt or other material designed to permit accessibility under all climatic conditions,



- f) have turnaround facilities for any dead-end portion of the access route more than 90 m long, and
  - g) be connected with a public thoroughfare.
- (See Note A-3.2.5.6.(1).)

**2)** For *buildings* conforming to Article 3.2.2.50. or 3.2.2.58., no portion of the access route described in Sentence 3.2.2.10.(3) shall be more than 20 m below the uppermost floor level.

**3.2.5.7. Water Supply**

**1)** Every *building* shall be provided with an adequate water supply for firefighting. (See Note A-3.2.5.7.(1).)

**3.2.5.8. Standpipe Systems**

- 1)** Except as permitted by Sentence 3.2.5.9.(4), a standpipe system shall be installed in a *building* that is
- a) more than 3 *storeys* in *building height*,
  - b) more than 14 m high measured between *grade* and the ceiling of the top *storey*, or
  - c) not more than 14 m high measured between *grade* and the ceiling of the top *storey* but has a *building area* exceeding the area shown in Table 3.2.5.8. for the applicable *building height* unless the *building* is *sprinklered* throughout.

**Table 3.2.5.8.**  
**Building Limits without Standpipe Systems**  
 Forming Part of Sentence 3.2.5.8.(1)

Occupancy Classification	Building Area, m <sup>2</sup>		
	1 storey	2 storeys	3 storeys
Group A	2 500	2 000	1 500
Group C	2 000	1 500	1 000
Group D	4 000	3 000	2 000
Group F, Division 2	1 500	1 500	1 000
Group F, Division 3	3 000	2 000	1 000

**3.2.5.9. Standpipe System Design**

**1)** Except as provided in Sentences (2) to (6), Articles 3.2.5.10. and 3.2.5.11., and Sentence 3.2.4.9.(2), the design, construction, installation and testing of a standpipe system shall conform to NFPA 14, "Installation of Standpipe and Hose Systems."

**2)** A dry standpipe that is not connected to a water supply shall not be considered as fulfilling the requirements of this Article.

**3)** If more than one standpipe is provided, the total water supply need not be more than 30 L/s.

**4)** A standpipe need not be installed in a *storage garage* conforming to Article 3.2.2.90., provided the *building* is not more than 15 m high.

**5)** The residual water pressure at the design flow rate at the topmost hose connection of a standpipe system that is required to be installed in a *building* is permitted to be less than 690 kPa provided

- a) the *building* is *sprinklered* throughout,
- b) the water supply at the base of the sprinkler riser is capable of meeting, without a fire pump, the design flow rate and pressure demand of the sprinkler system, including the inside and outside hose allowance, and
- c) fire protection equipment is available to deliver, by means of the fire department connection, the full demand flow rate at a residual water

pressure of 690 kPa at the topmost hose connection of the standpipe system (see Note A-3.2.5.9.(5)(c)).

- 6) A fire department connection shall be provided for every standpipe system.

### 3.2.5.10. Hose Connections

- 1) Hose connections shall be located in *exits*, in accordance with NFPA 14, "Installation of Standpipe and Hose Systems."
- 2) Hose connections are not required within a *floor area*.
- 3) Hose connections shall be provided with sufficient clearance to permit the use of a standard fire department hose key.
- 4) Except as permitted by Sentence (5), 64 mm diam hose connections shall be installed in a standpipe system.
- 5) Hose connections for 64 mm diam hose are not required in a *building* that is not more than 25 m high, measured between *grade* and the ceiling level of the top *storey* and in which an automatic sprinkler system is not installed.

### 3.2.5.11. Hose Stations

- 1) Hose stations for 38 mm diam hose shall be installed for a standpipe system in a *building* that is not *sprinklered* throughout.
- 2) Hose stations for a 38 mm diam hose shall be installed for a standpipe system within every *floor area* that is not *sprinklered* throughout. (See Note A-3.2.5.11.(2).)
- 3) Hose stations shall be located in the *floor area* within 5 m of *exits* and at other locations to provide coverage of the entire *floor area*.
- 4) A hose station located on one side of a *horizontal exit* shall be considered to serve only the *floor area* on that side of the *horizontal exit*.
- 5) A hose cabinet shall be located so that its door, when fully opened, will not obstruct the required width of a *means of egress*.
- 6) Where a *building* or part thereof is used as a *distillery* and the *building* is *sprinklered* in conformance with Article 3.2.5.12., small hose (38 mm) stations are permitted to be supplied from interior sprinkler piping.
- 7) Where a hose station is provided in grain handling and storage facilities in which *combustible dusts* are produced in quantities or concentrations that create an explosion or fire hazard, fog and fine spray nozzles shall be used instead of nozzles that discharge a solid stream of water to prevent *combustible dusts* from being raised into suspension.

### 3.2.5.12. Automatic Sprinkler Systems

- 1) Except as permitted by Sentences (2), (3) and (4), an automatic sprinkler system shall be designed, constructed, installed and tested in conformance with NFPA 13, "Installation of Sprinkler Systems." (See Note A-3.2.5.12.(1).)
- 2) Instead of the requirements of Sentence (1), NFPA 13R, "Installation of Sprinkler Systems in Low-Rise Residential Occupancies," is permitted to be used for the design, construction and installation of an automatic sprinkler system installed
- a) in a *building of residential occupancy* throughout that
    - i) is not more than 4 *storeys* in *building height* and conforms to Articles 3.2.2.47., 3.2.2.48., 3.2.2.50., 3.2.2.51. or 3.2.2.54., or
    - ii) is not more than 3 *storeys* in *building height* and conforms to Article 9.10.1.3., or
  - b) in a *building of care occupancy* with not more than 10 occupants that is not more than 3 *storeys* in *building height* and conforms to one of Articles 3.2.2.42. to 3.2.2.46.
- (See Note A-3.2.5.12.(2).)

- 3) Instead of the requirements of Sentence (1), NFPA 13D, "Installation of Sprinkler Systems in One- and Two-Family Dwellings and Manufactured Homes," is

permitted to be used for the design, construction and installation of an automatic sprinkler system installed

- a) in a *building of residential occupancy* throughout that contains not more than 2 *dwelling units*, or
- b) in a *building of care occupancy*, provided
  - i) it contains not more than 2 *suites of care occupancy*,
  - ii) it has not more than 5 residents throughout, and
  - iii) a 30-minute water supply demand can be met.

(See Note A-3.2.5.12.(2).)

**4)** If a *building* contains fewer than 9 sprinklers, the water supply for these sprinklers is permitted to be supplied from the domestic water system for the *building* provided the required flow for the sprinklers can be met by the domestic system.

**5)** If a water supply serves both an automatic sprinkler system and a system serving other equipment, control valves shall be provided so that either system can be shut off independently.

**6)** Notwithstanding the requirements of the standards referenced in Sentences (1) and (2) regarding the installation of automatic sprinkler systems, sprinklers shall not be omitted in any room or closet in the *storey* immediately below a roof assembly. (See Note A-3.2.5.12.(6).)

**7)** Notwithstanding the requirements of the standards referenced in Sentences (1) and (2) regarding the installation of automatic sprinkler systems, in *buildings* conforming to Article 3.2.2.50. or 3.2.2.58., sprinklers shall be provided for balconies and decks exceeding 610 mm in depth measured perpendicular to the exterior wall. (See Note A-3.2.5.12.(7).)

**8)** Sprinklers in elevator machine rooms shall have a temperature rating not less than that required for an intermediate temperature classification and shall be protected against physical damage. (See Note A-3.2.5.12.(8).)

### 3.2.5.13. Combustible Sprinkler Piping

**1)** *Combustible* sprinkler piping shall be used only for sprinkler systems in *residential occupancies* and other light-hazard *occupancies*. (See Note A-3.2.5.13.(1).)

**2)** *Combustible* sprinkler piping shall meet the requirements of ULC/ORD-C199P, "Combustible Piping for Sprinkler Systems."

**3)** Except as permitted by Sentence (5), *combustible* sprinkler piping shall be separated from the area served by the sprinkler system, and from any other *fire compartment*, by ceilings, walls, or soffits consisting of, as a minimum,

- a) lath and plaster,
- b) gypsum board not less than 9.5 mm thick,
- c) plywood not less than 13 mm thick, or
- d) a suspended membrane ceiling with
  - i) steel suspension grids, and
  - ii) lay-in panels or tiles having a mass not less than 1.7 kg/m<sup>2</sup>.

**4)** Except as permitted by Sentence (5), *combustible* sprinkler piping may be located above a ceiling provided that the distance between the edge of any ceiling opening that is not protected in conformance with Sentence (3) and the nearest sprinkler is not more than 300 mm.

**5)** Where *combustible* sprinkler piping has been tested in conformance with ULC/ORD-C199P, "Combustible Piping for Sprinkler Systems," and has been shown to meet the requirements therein without additional protection, conformance to Sentences (3) and (4) is not required.

### 3.2.5.14. Sprinklered Service Space

**1)** An automatic sprinkler system shall be installed in a *service space* referred to in Sentence 3.2.1.1.(8) if flooring for access within the *service space* is other than catwalks.

**2)** The sprinkler system required by Sentence (1) shall be equipped with waterflow detecting devices, with each device serving not more than one *storey*.

**3)** The waterflow detecting devices required by Sentence (2) shall be connected to the fire alarm system, to

- a) initiate an *alert signal* in a 2-stage system or an *alarm signal* in a single stage system, and
- b) indicate separately on the fire alarm system annunciator the actuation of each device.

### 3.2.5.15. Fire Department Connections

**1)** The fire department connection for a standpipe system shall be located so that the distance from the fire department connection to a hydrant is not more than 45 m and is unobstructed.

**2)** The fire department connection for an automatic sprinkler system shall be located so that the distance from the fire department connection to a hydrant is not more than 45 m and is unobstructed.

### 3.2.5.16. Portable Fire Extinguishers

- 1)** Portable extinguishers shall be provided and installed in accordance with
- a) provincial or territorial regulations or municipal bylaws, or
  - b) the NFC, in the absence of the regulations or bylaws referred to in Clause (a).

**2)** In a Group B, Division 1 *major occupancy*, portable fire extinguishers are permitted to be located in secure areas, or in lockable cabinets provided

- a) identical keys for all cabinets are located at all supervisory or security stations, or
- b) electrical remote release devices are provided and are connected to an emergency power supply.

### 3.2.5.17. Protection from Freezing

**1)** Equipment forming part of a fire protection system shall be protected from freezing if

- a) it could be adversely affected by freezing temperatures, and
- b) it is located in an unheated area.

### 3.2.5.18. Fire Pumps

**1)** If a fire pump is installed, it shall be installed in accordance with the requirements of NFPA 20, "Installation of Stationary Pumps for Fire Protection." (See Note A-3.2.5.18.(1).)

## 3.2.6. Additional Requirements for High Buildings

(See Note A-3.2.6.)

### 3.2.6.1. Application

- 1)** This Subsection applies to a *building*
- a) of Group A, D, E or F *major occupancy* classification that is more than
    - i) 36 m high, measured between *grade* and the floor level of the top *storey*, or
    - ii) 18 m high, measured between *grade* and the floor level of the top *storey*, and in which the cumulative or total *occupant load* on or above any *storey* above *grade*, other than the *first storey*, divided by 1.8 times the width in metres of all *exit stairs* at that *storey*, exceeds 300,
  - b) containing a Group B *major occupancy* in which the floor level of the highest *storey* of that *major occupancy* is more than 18 m above *grade*,

- c) containing a *floor area* or part of a *floor area* located above the third *storey* designed or intended as a Group B, Division 2 or 3 *occupancy*, or
- d) containing a Group C *major occupancy* whose floor level is more than 18 m above *grade*.

**3.2.6.2. Limits to Smoke Movement**

**1)** A *building* to which this Subsection applies shall be designed in accordance with Sentences (2) to (6) and Article 3.2.6.3. to limit the danger to occupants and firefighters from exposure to smoke in a *building* fire.

**2)** A *building* referred to in Sentence (1) shall be designed so that, during a period of 2 h after the start of a fire, each *exit* stair serving *storeys* below the lowest *exit level* will not contain more than 1% by volume of contaminated air from the fire floor, assuming an outdoor temperature equal to the January design temperature on a 2.5% basis determined in accordance with Subsection 1.1.3. (See Note A-3.2.6.2.(2).)

**3)** Each stairway that serves *storeys* above the lowest *exit level* shall have a vent to the outdoors, at or near the bottom of the stair shaft, that

- a) has an openable area of 0.05 m<sup>2</sup> for every door between the stair shaft and a *floor area*, but not less than 1.8 m<sup>2</sup>,
- b) opens directly to the outdoors or into a vestibule that has a similar opening to the outdoors, and
- c) has a door or *closure* that
  - i) is openable manually, and
  - ii) can remain in the open position during a fire emergency.

(See Note A-3.2.6.2.(3).)

**4)** Measures shall be taken to limit movement of smoke from a fire in a *floor area* below the lowest *exit storey* into upper *storeys*. (See Note A-3.2.6.2.(4).)

**5)** Except for exhaust fans in kitchens, washrooms and bathrooms in *dwelling units*, and except for fans used for smoke venting as required by Article 3.2.6.6., air moving fans in a system that serves more than 2 *storeys* shall be designed and installed so that in the event of a fire these fans can be stopped by means of a manually operated switch at the central alarm and control facility.

**6)** Except as provided in Article 3.2.4.12. or where there is a conflict with other smoke control measures in the *building*, air-handling systems used to provide make-up air to *public corridors* serving *suites* in a Group C *major occupancy* shall not shut down automatically upon activation of the fire alarm so as to maintain corridor pressurization.

**3.2.6.3. Connected Buildings**

**1)** If a *building* described in Article 3.2.6.1. is connected to any other *building*, measures shall be taken to limit movement of contaminated air from one *building* into another during a fire. (See Note A-3.2.6.3.(1).)

**3.2.6.4. Emergency Operation of Elevators**

**1)** Manual emergency recall shall be provided for all elevators serving *storeys* above the *first storey*.

**2)** Key-operated switches for emergency recall required by Sentence (1) shall be provided in a conspicuous location at

- a) each elevator lobby on the recall level, and
- b) the central alarm and control facility required by Article 3.2.6.7.

**3)** In-car emergency service switches shall be provided in all elevator cars.

**4)** Keys to operate the switches required by Sentences (2) and (3) shall be

- a) provided in a suitably identified box conspicuously located on the outside of an elevator hoistway near the central alarm and control facility required by Article 3.2.6.7., and

- b) kept at the central alarm and control facility.

**3.2.6.5. Elevator for Use by Firefighters**

**1)** At least one elevator shall be provided for use by firefighters in conformance with Sentences (2) to (6).

**2)** The elevator referred to in Sentence (1) shall have a useable platform area not less than 2.2 m<sup>2</sup> and shall be capable of carrying a load of 900 kg to the top floor that it serves from a landing on the *storey* containing the entrance for firefighter access referred to in Articles 3.2.5.4. and 3.2.5.5. within 1 min.

**3)** Each elevator for use by firefighters shall

- a) be provided with a *closure* at each shaft opening so that the interlock mechanism remains mechanically engaged and electrical continuity is maintained in the interlock circuits and associated wiring for a period of not less than 1 h when the assembly is subjected to the standard fire exposure described in CAN/ULC-S104, "Fire Tests of Door Assemblies,"
- b) be protected with a vestibule containing no *occupancy* and separated from the remainder of the *floor area* by a *fire separation* having a *fire-resistance rating* not less than 45 min, or
- c) be protected with a corridor containing no *occupancy* and separated from the remainder of the *building* by a *fire separation* having a *fire-resistance rating* not less than 1 h.

**4)** Except as permitted by Sentence (5), an elevator referred to in Sentence (1) shall be capable of providing transportation from the *storey* containing the entrance for firefighter access referred to in Articles 3.2.5.4. and 3.2.5.5. to every floor that is above *grade* in the *building* and that is normally served by the elevator system.

**5)** If it is necessary to change elevators to reach any floor referred to in Sentence (4), the system shall be designed so that not more than one change of elevator is required when travelling to any floor in the *building* from the *storey* containing the entrance for firefighter access referred to in Articles 3.2.5.4. and 3.2.5.5.

**6)** Electrical conductors for the operation of the elevator referred to in Sentence (1) shall be

- a) installed in *service spaces* conforming to Section 3.6. that do not contain other *combustible* material, or
- b) protected against exposure to fire from the service entrance of the emergency power supply, or the normal service entrance of the normal power supply, to the equipment served, to ensure operation for a period of 1 h when subjected to the standard fire exposure described in CAN/ULC-S101, "Fire Endurance Tests of Building Construction and Materials," (see Note A-3.2.6.5.(6)(b)).

**3.2.6.6. Venting to Aid Firefighting**

**1)** Means of venting each *floor area* to the outdoors shall be provided by windows, wall panels, smoke shafts, or the *building* exhaust system. (See Note A-3.2.6.6.(1).)

**2)** Fixed glass windows shall not be used for the venting required by Sentence (1) if the breaking of the windows could endanger pedestrians below.

**3)** Openable windows used for the venting required by Sentence (1) shall be permanently marked so that they are easily identifiable.

**4)** Elevator hoistways shall not be designed for the venting required by Sentence (1).

**3.2.6.7. Central Alarm and Control Facility**

**1)** A central alarm and control facility shall be provided on the *storey* containing the entrance for firefighter access referred to in Articles 3.2.5.4. and 3.2.5.5. in a location that

- a) is readily accessible to firefighters entering the *building*, and
- b) takes into account the effect of background noise likely to occur under fire emergency conditions, so that the facility can properly perform its required function under these conditions.

(See Note A-3.2.6.7.(1).)

- 2)** The central alarm and control facility required by Sentence (1) shall include
  - a) means to control the voice communication system required by Article 3.2.6.8., so that messages can be sent to
    - i) all loudspeakers simultaneously,
    - ii) individual *floor areas*, and
    - iii) *exit* stairwells,
  - b) means to indicate audibly and visually *alert signals* and *alarm signals* and a switch to
    - i) silence the audible portion of these signals, and
    - ii) indicate visually that the audible portion has been silenced,
  - c) means to indicate visually that elevators are on emergency recall,
  - d) an annunciator conforming to Article 3.2.4.8.,
  - e) means to transmit *alert signals* and *alarm signals* to the fire department in conformance with Article 3.2.4.7.,
  - f) means to release hold-open devices on doors to vestibules,
  - g) means to manually actuate *alarm signals* in the *building* selectively to any zone or zones,
  - h) means to silence the *alarm signals* referred to in Clause (g) in conformance with Sentences 3.2.4.22.(2) and 3.2.4.22.(3),
  - i) means, as appropriate to the measure for fire safety provided in the *building*, to
    - i) actuate auxiliary equipment identified in Articles 3.2.6.2., 3.2.6.3. and 3.2.6.6., or
    - ii) communicate with a continually staffed auxiliary equipment control centre,
  - j) means to communicate with telephones in elevator cars, separate from connections to firefighters' telephones, if elevator cars are required by ASME A17.1/CSA B44, "Safety Code for Elevators and Escalators," to be equipped with a telephone,
  - k) means to indicate visually, individual sprinkler system waterflow signals,
  - l) means to indicate audibly and visually, sprinkler and standpipe system supervisory signals and trouble signals,
  - m) a switch to silence the audible portion of a supervisory signal or a trouble signal, and
  - n) visual indication that the audible portion of a supervisory signal or a trouble signal has been silenced.

(See Note A-3.2.6.7.(2).)

**3.2.6.8. Voice Communication System**

- 1)** A voice communication system conforming to Article 3.2.4.22. shall be provided in a *building* if
  - a) the floor of the top *storey* is more than 36 m above *grade*, or
  - b) a *floor area* or part of a *floor area* located above the third *storey* is designed or intended for use as a Group B, Division 2 or 3 *occupancy*.

**3.2.6.9. Testing**

- 1)** The systems for control of smoke movement and mechanical venting required by Articles 3.2.6.2. and 3.2.6.6. shall be tested to ensure satisfactory operation. (See Note A-3.2.6.9.(1).)

**3.2.7. Lighting and Emergency Power Systems**

**3.2.7.1. Minimum Lighting Requirements**

- 1)** An *exit*, a *public corridor*, or a corridor providing *access to exit* for the public or serving patients' sleeping rooms or classrooms shall be equipped to provide illumination to an average level not less than 50 lx at floor or tread level and at angles and intersections at changes of level where there are stairs or ramps.
- 2)** The minimum value of the illumination required by Sentence (1) shall be not less than 10 lx.

**3)** Rooms and spaces used by the public shall be illuminated as described in Article 9.34.2.7.

**4)** Lighting outlets in a *building of residential occupancy* shall be provided in conformance with Subsection 9.34.2.

### 3.2.7.2. Recessed Lighting Fixtures

**1)** A recessed lighting fixture shall not be located in an insulated ceiling unless the fixture is designed for this type of installation.

### 3.2.7.3. Emergency Lighting

**1)** Emergency lighting shall be provided to an average level of illumination not less than 10 lx at floor or tread level in

- a) *exits*,
- b) principal routes providing *access to exit* in open *floor areas* and in *service rooms*,
- c) corridors used by the public,
- d) corridors serving sleeping rooms in a *treatment occupancy*,
- e) corridors serving sleeping rooms in a *care occupancy*, except corridors serving sleeping rooms within individual *suites of care occupancy*,
- f) corridors serving classrooms,
- g) underground *walkways*,
- h) *public corridors*,
- i) *floor areas* or parts thereof where the public may congregate
  - i) in Group A, Division 1 *occupancies*, or
  - ii) in Group A, Division 2 and 3 *occupancies* having an *occupant load* of 60 or more,
- j) *floor areas* or parts thereof of daycare centres where persons are cared for,
- k) food preparation areas in commercial kitchens, and
- l) public washrooms that are equipped to serve more than one person at a time.

**2)** Emergency lighting to provide an average level of illumination of not less than 10 lx at floor or catwalk level shall be included in a *service space* referred to in Sentence 3.2.1.1.(8).

**3)** The minimum value of the illumination required by Sentences (1) and (2) shall be not less than 1 lx.

**4)** In addition to the requirements of Sentences (1) to (3), the installation of battery-operated emergency lighting in buildings or part thereof where *treatment* is provided shall conform to the appropriate requirements of CSA Z32, "Electrical Safety and Essential Electrical Systems in Health Care Facilities."

### 3.2.7.4. Emergency Power for Lighting

- 1)** An emergency power supply shall be
  - a) provided to maintain the emergency lighting required by this Subsection from a power source such as batteries or generators that will continue to supply power in the event that the regular power supply to the *building* is interrupted, and
  - b) so designed and installed that upon failure of the regular power it will assume the electrical load automatically for a period of
    - i) 2 h for a *building* within the scope of Subsection 3.2.6.,
    - ii) 1 h for a *building* of Group B *major occupancy* classification that is not within the scope of Subsection 3.2.6.,
    - iii) 1 h for a *building* constructed in accordance with Article 3.2.2.50. or 3.2.2.58., and
    - iv) 30 min for a *building* of any other *occupancy*.

(See Note A-3.2.7.4.(1).)

**2)** If self-contained emergency lighting units are used, they shall conform to CSA C22.2 No. 141, "Emergency Lighting Equipment."



**3.2.7.5. Emergency Power Supply Installation**

**1)** Except as required by Articles 3.2.7.6. and 3.2.7.7., an emergency electrical power supply system shall be installed in conformance with CSA C282, “Emergency Electrical Power Supply for Buildings.” (See Sentence 3.2.7.8.(1) for emergency electrical power supply for voice communication systems.)

**3.2.7.6. Emergency Power for Treatment Occupancies**

**1)** Except as required by Article 3.2.7.7., an emergency electrical power supply system for emergency equipment required by this Part for *treatment occupancies* shall be installed in conformance with CSA Z32, “Electrical Safety and Essential Electrical Systems in Health Care Facilities.” (See Note A-3.2.7.6.(1).)

**3.2.7.7. Fuel Supply Shut-off Valves**

**1)** If a liquid or gas fuel-fired engine or turbine for an emergency electric power supply is dependent on a fuel supply from outside the *building*, the fuel supply shall be provided with a suitably-identified separate shut-off valve outside the *building*.

**3.2.7.8. Emergency Power for Fire Alarm Systems**

**1)** Fire alarm systems, including those incorporating a voice communication system, shall be provided with an emergency power supply conforming to Sentences (2), (3) and (4).

- 2)** The emergency power supply required by Sentence (1) shall be supplied from
- a) a generator,
  - b) batteries, or
  - c) a combination thereof.

**3)** The emergency power supply required by Sentence (1) shall be capable of providing

- a) supervisory power for not less than 24 h, and
- b) immediately following that period, emergency power under full load for not less than
  - i) 2 h for a *building* within the scope of Subsection 3.2.6.,
  - ii) 1 h for a *building* classified as a Group B *major occupancy* that is not within the scope of Subsection 3.2.6.,
  - iii) 1 h for a *building* constructed in accordance with Article 3.2.2.50. or 3.2.2.58.,
  - iv) 5 min for a *building* not required to be equipped with an annunciator, and
  - v) 30 min for any other *building*.

(See Note A-3.2.7.8.(3).)

**4)** The emergency power supply required by Sentence (1) shall be designed so that, in the event of a failure of the normal power source, there is an immediate automatic transfer to emergency power with no loss of information.

**3.2.7.9. Emergency Power for Building Services**

**1)** An emergency power supply capable of operating under a full load for not less than 2 h shall be provided by an emergency generator for

- a) every elevator serving *storeys* above the *first storey* in a *building* that is more than 36 m high measured between *grade* and the floor level of the top *storey* and every elevator for firefighters in conformance with Sentence (2),
- b) water supply for firefighting in conformance with Article 3.2.5.7., if the supply is dependent on electrical power supplied to the *building*,
- c) fans and other electrical equipment that are installed to maintain the air quality specified in Articles 3.2.6.2. and 3.3.3.6.,
- d) fans required for venting by Article 3.2.6.6., and
- e) fans required by Clause 3.2.8.4.(1)(c) and Article 3.2.8.7. in *buildings* within the scope of Subsection 3.2.6.

(See Note A-3.2.7.9.(1).)

**2)** Except as permitted by Sentence (3), the emergency power supply for elevators required by Clause (1)(a) shall be capable of operating all elevators for firefighters plus one additional elevator simultaneously.

**3)** Sentence (2) does not apply if the time to recall all elevators under emergency power supply is not more than 5 min, each from its most remote *storey* to

- a) the *storey* containing the entrance for firefighter access referred to in Articles 3.2.5.4. and 3.2.5.5., or
- b) to a transfer lobby.

### 3.2.7.10. Protection of Electrical Conductors

**1)** The protection of electrical and emergency conductors referred to in Clauses (a) to (c) shall conform to the requirements stated in Sentences (2) to (11):

- a) electrical conductors located within *buildings* identified in Article 3.2.6.1. serving
  - i) fire alarms,
  - ii) emergency lighting, or
  - iii) emergency equipment within the scope of Articles 3.2.6.2. to 3.2.6.8.,
- b) emergency conductors serving fire pumps required to be installed under Article 3.2.5.18., and
- c) electrical conductors serving mechanical systems serving
  - i) areas of refuge identified in Clause 3.3.3.6.(1)(b), or
  - ii) *contained use areas* identified in Clauses 3.3.3.7.(4)(a) and (b).

**2)** Except as otherwise required by Sentence (3) and permitted by this Article, electrical conductors that are used in conjunction with systems identified in Sentence (1) shall

- a) conform to CAN/ULC-S139, "Fire Test for Evaluation of Integrity of Electrical Power, Data and Optical Fibre Cables," including the hose stream application, to provide a circuit integrity rating of not less than 1 h (see Note A-3.2.7.10.(2)(a) and (3)(a)), or
- b) be located in a *service space* that is separated from the remainder of the *building* by a *fire separation* that has a *fire-resistance rating* not less than 1 h.

**3)** Electrical conductors identified in Clause (1)(c) shall

- a) conform to CAN/ULC-S139, "Fire Test for Evaluation of Integrity of Electrical Power, Data and Optical Fibre Cables," including the hose stream application, to provide a circuit integrity rating of not less than 2 h (see Note A-3.2.7.10.(2)(a) and (3)(a)), or
- b) be located in a *service space* that is separated from the remainder of the *building* by a *fire separation* that has a *fire-resistance rating* not less than 2 h.

**4)** The *service spaces* referred to in Clauses (2)(b) and (3)(b) shall not contain any *combustible* materials other than the conductors being protected.

**5)** Except as stated in Sentences (7) and (9), the electrical conductors referred to in Sentence (1) are those that extend from the source of emergency power to

- a) the equipment served, or
- b) the distribution equipment supplying power to the equipment served, if both are in the same room (see Note A-3.2.7.10.(5)(b)).

**6)** If a fire alarm transponder or annunciator in one *fire compartment* is connected to a central processing unit or another transponder or annunciator located in a different *fire compartment*, the electrical conductors connecting them shall be protected in accordance with Sentence (2).

**7)** Fire alarm system branch circuits within a *storey* that connect transponders and individual devices need not conform to Sentence (2). (See Note A-3.2.7.10.(7).)

**8)** Except as permitted in Sentence (9), if a distribution panel supplies power to emergency lighting, the power supply conductors leading up to the distribution panel shall be protected in accordance with Sentence (2).

**9)** Conductors leading from a distribution panel referred to in Sentence (8) to emergency lighting units in the same *storey* need not conform to Sentence (2).

**10)** Distribution panels serving emergency lighting units located on other *storeys* shall be installed in a *service room* separated from the *floor area* by a *fire separation* having a *fire-resistance rating* of at least 1 h.

**11)** Conductors leading from a distribution panel to emergency lighting units located on other *storeys* shall be protected in accordance with Sentence (2) between the distribution panel and the *floor area* where the emergency lighting units are located.

### 3.2.8. Mezzanines and Openings through Floor Assemblies

#### 3.2.8.1. Application

**1)** Except as permitted by Article 3.2.8.2. and Sentence 3.3.4.2.(3), the portions of a *floor area* or a *mezzanine* that do not terminate at an exterior wall, a *firewall* or a vertical shaft shall

- a) terminate at a vertical *fire separation* having a *fire-resistance rating* not less than that required for the floor assembly and extending from the floor assembly to the underside of the floor or roof assembly above, or
- b) be protected in conformance with the requirements of Articles 3.2.8.3. to 3.2.8.8.

**2)** The penetration of a floor assembly by an *exit* or a *vertical service space* shall conform to the requirements of Sections 3.4., 3.5. and 3.6.

**3)** A *floor area* containing sleeping rooms in a *building* of Group B, Division 2 *major occupancy* shall not be constructed as part of an *interconnected floor space*.

#### 3.2.8.2. Exceptions to Special Protection

**1)** A *mezzanine* need not terminate at a vertical *fire separation* nor be protected in conformance with the requirements of Articles 3.2.8.3. to 3.2.8.8. provided the *mezzanine*

- a) serves a Group A, Division 1 *major occupancy*,
- b) serves a Group A, Division 3 *major occupancy* in a *building* not more than 2 *storeys* in *building* height, or
- c) serves a Group A, C, D, E or F *major occupancy* and
  - i) is 500 m<sup>2</sup> or less in area, and
  - ii) conforms to Sentence 3.2.1.1.(3) or (4).

**2)** Except for floors referred to in Sentence 3.1.10.3.(1) and Article 3.2.1.2., openings through a horizontal *fire separation* for vehicular ramps in a *storage garage* are not required to be protected with *closures* and need not conform to this Subsection.

**3)** If a *closure* in an opening in a *fire separation* would disrupt the nature of a manufacturing process, such as a continuous flow of material from *storey* to *storey*, the *closure* for the opening is permitted to be omitted provided precautions are taken to offset the resulting hazard. (See Note A-3.2.8.2.(3).)

**4)** An *interconnected floor space* in a Group B, Division 1 *occupancy* need not conform to the requirements of Articles 3.2.8.3. to 3.2.8.8. provided the *interconnected floor space* does not interconnect more than 2 adjacent *storeys*.

**5)** Except as permitted by Sentence (6), openings for escalators and inclined moving walks need not conform to the requirements in Articles 3.2.8.3. to 3.2.8.8. provided

- a) the opening for each escalator or walk does not exceed 10 m<sup>2</sup>,
- b) the *building* is *sprinklered* throughout, and
- c) the *interconnected floor space* contains only Group A, Division 1, 2 or 3, Group D or Group E *major occupancies* (see Note A-3.2.8.2.(6)(c)).

**6)** An *interconnected floor space* need not conform to the requirements of Articles 3.2.8.3. to 3.2.8.8., provided

- a) it consists of the *first storey* and the *storey* next above or below it, but not both,

- b) it is *sprinklered* throughout or, where the *building area* is not more than one half of the area permitted by Subsection 3.2.2., the openings through the floor are used only for stairways, escalators or moving walks (see Note A-3.2.8.2.(6)(b)), and
- c) it contains only Group A, Division 1, 2 or 3, Group D, Group E, or Group F, Division 2 or 3 *major occupancies* (see Note A-3.2.8.2.(6)(c)).

### 3.2.8.3. Sprinklers

- 1) A *building* containing an *interconnected floor space* shall be *sprinklered* throughout.

### 3.2.8.4. Vestibules

- 1) An *exit* opening into an *interconnected floor space* shall be protected at each opening into the *interconnected floor space* by a vestibule
  - a) with doorways that are not less than 1.8 m apart,
  - b) that is separated from the remainder of the *floor area* by a *fire separation* that is not required to have a *fire-resistance rating* (see Note A-3.1.8.1.(1)(b)), and
  - c) that is designed to limit the passage of smoke so that the *exit* stair shaft does not contain more than 1% by volume of contaminated air from the fire floor, assuming an outdoor temperature equal to the January design temperature on a 2.5% basis determined in accordance with Subsection 1.1.3. (see Note A-3.2.8.4.(1)(c)).
- 2) An *exit* opening into an *interconnected floor space* shall conform to Sentence 3.4.3.2.(6).
- 3) If an elevator hoistway opens into an *interconnected floor space* and into *storeys* above the *interconnected floor space*, either the elevator doors opening into the *interconnected floor space* or the elevator doors opening into the *storeys* above the *interconnected floor space* shall be protected by vestibules conforming to Sentence (1).

### 3.2.8.5. Protected Floor Space

- 1) A *protected floor space* used to satisfy the requirements of Clause 3.4.3.2.(6)(b) shall
  - a) be separated from the *interconnected floor space* by a *fire separation* having a *fire-resistance rating* not less than that required for the floor assembly of the *storey* in which it is located,
  - b) have all openings in the vertical *fire separation* between a *protected floor space* and the adjacent *interconnected floor space* protected by vestibules conforming to Sentence 3.2.8.4.(1), and
  - c) be designed so that it is not necessary to enter the *interconnected floor space* to reach an *exit*.

### 3.2.8.6. Draft Stops

- 1) A draft stop shall be provided at each floor level within an *interconnected floor space*, immediately adjacent to and surrounding the opening, and shall be not less than 500 mm deep measured from ceiling level down to the underside of the draft stop.

### 3.2.8.7. Mechanical Exhaust System

- 1) A mechanical exhaust system shall be provided to remove air from an *interconnected floor space* at a rate of 4 air changes per hour. (See Note A-3.2.8.7.(1).)
- 2) The mechanical exhaust system required by Sentence (1) shall be actuated by a switch located on the *storey* containing the entrance for firefighter access referred to in Articles 3.2.5.4. and 3.2.5.5. near the annunciator for the fire alarm system.

### 3.2.8.8. Combustible Content Limits

- 1) An *interconnected floor space* shall be designed so that the *combustible* contents, excluding interior finishes, in those parts of a *floor area* in which the ceiling is more than 8 m above the floor, are limited to not more than 16 g of *combustible* material for each cubic metre of volume of the *interconnected floor space*.

### 3.2.9. Integrated Fire Protection and Life Safety Systems

#### 3.2.9.1. Testing

1) Where fire protection and life safety systems and systems with fire protection and life safety functions are integrated with each other, they shall be tested as a whole in accordance with CAN/ULC-S1001, "Integrated Systems Testing of Fire Protection and Life Safety Systems," to verify that they have been properly integrated. (See Note A-3.2.9.1.(1).)

## Section 3.3. Safety within Floor Areas

(See Note A-3.3.)

### 3.3.1. All Floor Areas

#### 3.3.1.1. Separation of Suites

1) Except as permitted by Sentences (2) and (3), each *suite* in other than *business and personal services occupancies* shall be separated from adjoining *suites* by a *fire separation* having a *fire-resistance rating* not less than 1 h. (See also Subsection 3.3.3. for *care, treatment or detention occupancies*, Article 3.3.4.2. for *residential occupancies*, and Article 3.1.8.7. for *fire dampers*.)

2) The *fire-resistance rating* of the *fire separation* required by Sentence (1) is permitted to be less than 1 h but not less than 45 min provided the *fire-resistance rating* required by Subsection 3.2.2. is permitted to be less than 1 h for

- a) the floor assembly above the *floor area*, or
- b) the floor assembly below the *floor area*, if there is no floor assembly above.

3) *Occupancies* that are served by *public corridors* conforming to Clause 3.3.1.4.(4)(b) in a *building* that is *sprinklered* throughout, are not required to be separated from one another by *fire separations* provided the *occupancies* are

- a) *suites of business and personal services occupancy*,
- b) fast food vending operations that do not provide seating for customers,
- c) *suites of mercantile occupancy*, or
- d) any combination of these occupancies.

#### 3.3.1.2. Hazardous Substances, Equipment and Processes

1) Except as provided in Subsections 3.3.5. and 3.3.6., the storage, handling and use of hazardous substances shall be in conformance with

- a) provincial or territorial regulations or municipal bylaws, or
- b) in the absence of the regulations or bylaws referred to in Clause (a), the NFC.

(See Note A-3.3.1.2.(1).)

2) Systems for the ventilation of cooking equipment that is not within a *dwelling unit* and is used in processes producing grease-laden vapours shall be designed and installed in conformance with Articles 3.6.3.5., 6.3.1.7. and 6.9.1.3. (See Note A-3.3.1.2.(2).)

3) A fuel-fired *appliance* shall not be installed in a corridor serving as an *access to exit*.

#### 3.3.1.3. Means of Egress

1) *Access to exit* within *floor areas* shall conform to Subsections 3.3.2. to 3.3.5., in addition to the requirements of this Subsection.

2) If a podium, terrace, platform or contained open space is provided, egress requirements shall conform to the appropriate requirements of Sentence 3.3.1.5.(1) for rooms and *suites*.

3) *Means of egress* shall be provided from every roof which is intended for *occupancy*, and from every podium, terrace, platform or contained open space.

- 4)** At least two separate *means of egress* shall be provided from a roof, used or intended for an *occupant load* more than 60, to stairs designed in conformance with the requirements regarding *exit* stairs stated in Section 3.4.
- 5)** A rooftop enclosure shall be provided with an *access to exit* that leads to an *exit*
- a) at the roof level, or
  - b) on the *storey* immediately below the roof.
- 6)** A rooftop enclosure which is more than 200 m<sup>2</sup> in area shall be provided with at least 2 *means of egress*.
- 7)** Two points of egress shall be provided for a *service space* referred to in Sentence 3.2.1.1.(8) if
- a) the area is more than 200 m<sup>2</sup>, or
  - b) the travel distance measured from any point in the *service space* to a point of egress is more than 25 m.
- 8)** Except as permitted by Sentences 3.3.4.4.(5) and (6), each *suite* in a *floor area* that contains more than one *suite* shall have
- a) an exterior *exit* doorway, or
  - b) a doorway
    - i) into a *public corridor*, or
    - ii) to an exterior passageway.
- 9)** Except as permitted by this Section and by Sentence 3.4.2.1.(2), at the point where a doorway referred to in Sentence (8) opens onto a *public corridor* or exterior passageway, it shall be possible to go in opposite directions to each of 2 separate *exits*.

#### 3.3.1.4. Public Corridor Separations

- 1)** Except as otherwise required by this Part or as permitted by Sentence (4), a *public corridor* shall be separated from the remainder of the *storey* by a *fire separation*.
- 2)** Except as permitted by Sentence (3) and Clauses (4)(a) and (b), the *fire separation* between a *public corridor* and the remainder of the *storey* shall have a *fire-resistance rating* not less than 45 min.
- 3)** If a *storey* is *sprinklered* throughout, no *fire-resistance rating* is required for a *fire separation* between a *public corridor* and the remainder of the *storey*, provided the corridor does not serve a *care, treatment* or *detention occupancy* or a *residential occupancy*. (See Note A-3.1.8.1.(1)(b).)
- 4)** No *fire separation* is required in a *sprinklered floor area* between a *public corridor* and
- a) except as required by Sentences 3.3.3.5.(8) and 3.3.4.2.(1), and notwithstanding Sentence 3.4.2.4.(2), the remainder of a *storey*, provided the travel distance from any part of the *floor area* to an *exit* is not more than 45 m,
  - b) a room or a *suite*, provided the *public corridor* complies with Sentence 3.3.1.9.(6) and Clause 3.4.2.5.(1)(d), or
  - c) a space containing plumbing fixtures required by Subsection 3.7.2., provided the space and the *public corridor* are separated from the remainder of the *storey* by a *fire separation* having a *fire-resistance rating* not less than that required between the *public corridor* and the remainder of the *storey*.

#### 3.3.1.5. Egress Doorways

- 1)** Except for *dwelling units*, a minimum of 2 egress doorways located so that one doorway could provide egress from the room or *suite* as required by Article 3.3.1.3. if the other doorway becomes inaccessible to the occupants due to a fire which originates in the room or *suite*, shall be provided for every room and every *suite*
- a) that is used for a *high-hazard industrial occupancy* and whose area is more than 15 m<sup>2</sup>,
  - b) intended for an *occupant load* more than 60,

- c) in a *floor area* that is not *sprinklered* throughout, and
  - i) the area of a room or *suite* is more than the value in Table 3.3.1.5.-A, or
  - ii) the travel distance within the room or *suite* to the nearest egress doorway is more than the value in Table 3.3.1.5.-A, or
- d) in a *floor area* that is *sprinklered* throughout and does not contain a *high-hazard industrial occupancy* and
  - i) the travel distance to an egress doorway is more than 25 m, or
  - ii) the area of the room or *suite* is more than the value in Table 3.3.1.5.-B.

**2)** Where 2 egress doorways are required by Sentence (1), they shall be placed at a distance from one another equal to or greater than one third of the maximum overall diagonal dimension of the area to be served, measured as the shortest distance that smoke would have to travel between the nearest required egress doors.

**Table 3.3.1.5.-A**  
**Egress in Floor Area not Sprinklered Throughout**  
 Forming Part of Sentence 3.3.1.5.(1)

<i>Occupancy of Room or Suite</i>	Maximum Area of Room or <i>Suite</i> , m <sup>2</sup>	Maximum Distance to Egress Doorway, m
Group A	150	15
Group C	100 <sup>(1)</sup>	15 <sup>(1)</sup>
Group D	200	25
Group E	150	15
Group F, Division 2	150	10
Group F, Division 3	200	15

**Notes to Table 3.3.1.5.-A:**

<sup>(1)</sup> See Article 3.3.4.4. for *dwelling units*.

**Table 3.3.1.5.-B**  
**Egress in Floor Area Sprinklered Throughout**  
 Forming Part of Sentence 3.3.1.5.(1)

<i>Occupancy of Room or Suite</i>	Maximum Area of Room or <i>Suite</i> , m <sup>2</sup>
Group A	200
Group B, Division 1	100
Group B, Division 2	
sleeping rooms	100
other than sleeping rooms	200
Group B, Division 3	
sleeping rooms not in <i>suites</i>	100
individual <i>suites</i>	150
other than sleeping rooms	200
Group C	150 <sup>(1)</sup>
Group D	300
Group E	200
Group F, Division 2	200
Group F, Division 3	300

**Notes to Table 3.3.1.5.-B:**

<sup>(1)</sup> See Article 3.3.4.4. for *dwelling units*.

**3.3.1.6. Travel Distance**

**1)** If more than one egress doorway is required from a room or *suite* referred to in Article 3.3.1.5., the travel distance within the room or *suite* to the nearest egress doorway shall not exceed the maximum travel distances specified in Clauses 3.4.2.5.(1)(a), (b), (c) and (f) for *exits*.

**3.3.1.7. Protection on Floor Areas with a Barrier-Free Path of Travel**

**1)** Every *floor area* above or below the *first storey* that is not *sprinklered* throughout and that has a *barrier-free* path of travel shall

- a) be served by an elevator
    - i) conforming to Sentences 3.2.6.5.(4) to (6),
    - ii) protected against fire in conformance with Clauses 3.2.6.5.(3)(b) or (c), and
    - iii) in a *building* over 3 *storeys* in *building height*, protected against smoke movement so that the hoistway will not contain more than 1% by volume of contaminated air from a fire floor during a period of 2 h after the start of a fire, assuming an outdoor temperature equal to the January design temperature on a 2.5% basis determined in conformance with Subsection 1.1.3.,
  - b) be divided into at least 2 zones by *fire separations* conforming to Sentences (2), (3) and 3.1.8.5.(6) so that (see Note A-3.3.1.7.(1)(b))
    - i) persons with physical disabilities can be accommodated in each zone, and
    - ii) the travel distance from any point in one zone to a doorway leading to another zone shall be not more than the value for travel distance permitted by Sentence 3.4.2.5.(1) for the *occupancy* classification of the zone,
  - c) in the case of *residential occupancies*, be provided with balconies conforming to Sentence (4), except on the *storey* containing the *barrier-free* entrance required by Article 3.8.2.2.,
  - d) have an exterior *exit* at ground level, or
  - e) have a ramp leading to ground level.
- (See Note A-3.3.1.7.(1).)

**2)** Except as permitted by Sentence (3), the *fire separations* referred to in Clause (1)(b) shall have a *fire-resistance rating* not less than 1 h.

**3)** The *fire-resistance rating* of the *fire separations* referred to in Clause (1)(b) is permitted to be less than 1 h but not less than 45 min provided the *fire-resistance rating* required by Subsection 3.2.2. is permitted to be less than 1 h for

- a) the floor assembly above the *floor area*, or
- b) the floor assembly below the *floor area*, if there is no floor assembly above.

**4)** A balcony required by Clause (1)(c) shall

- a) have direct *barrier-free* access from the *suite* or *floor area*
- b) be not less than 1.5 m deep from the outside face of the exterior wall to the inside edge of the balcony, and
- c) provide not less than 1.5 m<sup>2</sup> of balcony space for each non-ambulatory occupant and 0.5 m<sup>2</sup> for each ambulatory occupant.

**3.3.1.8. Headroom Clearance**

**1)** Except within the *floor area* of a *storage garage*, the minimum headroom clearance in every *access to exit* shall conform to the requirements of Article 3.4.3.4. for *exits*. (See also Sentence 3.3.5.4.(5).)

**3.3.1.9. Corridors**

**1)** The minimum width of a *public corridor* shall be 1 100 mm.



**2)** Except as required by Sentence 3.3.3.3.(3), the minimum unobstructed width of a corridor used by the public or a corridor serving classrooms or patients' sleeping rooms shall be 1 100 mm.

**3)** Except as permitted by Sentence (4), obstructions located within 1 980 mm of the floor shall not project more than 100 mm horizontally into an *exit* passageway, a *public corridor*, a corridor used by the public or a corridor serving classrooms or patients' sleeping rooms in a manner that would create a hazard for a person with a visual disability traveling adjacent to the walls.

**4)** The horizontal projection of an obstruction referred to in Sentence (3) is permitted to be more than 100 mm provided the clearance between the obstruction and the floor is less than 680 mm. (See Note A-3.3.1.9.(4).)

**5)** If a corridor contains an *occupancy*, the *occupancy* shall not reduce the unobstructed width of the corridor to less than its required width.

- 6)** If a *public corridor* conforming to Clause 3.4.2.5.(1)(d) contains an *occupancy*,
- a) the *occupancy* shall be located so that for pedestrian travel there is an unobstructed width not less than 3 m at all times adjacent and parallel to all rooms and *suites* that front onto the *public corridor*, and
  - b) the combined area of all *occupancies* in the *public corridor* shall be not more than 15% of the area of the *public corridor*.

**7)** Except for a dead-end corridor that is entirely within a *suite* or as permitted by Sentences 3.3.3.3.(1) and 3.3.4.4.(6), a dead-end corridor is permitted provided it is not more than 6 m long.

**3.3.1.10. Aisles**

**1)** Except as otherwise stated in this Section, aisles shall be provided in conformance with the NFC.

**3.3.1.11. Door Swing**

**1)** Except as permitted by Sentence (5) and Article 3.3.1.12., a door that opens into a corridor or other facility providing *access to exit* from a *suite* or room not located within a *suite* shall swing on a vertical axis.

**2)** Except as permitted by Article 3.3.1.12., a door that opens into a corridor or other facility providing *access to exit* from a room or *suite* that is used or intended for an *occupant load* more than 60 or for a *high-hazard industrial occupancy* shall swing in the direction of travel to the *exit*.

**3)** Every door that divides a corridor that is not wholly contained within a *suite* shall swing on a vertical axis in the direction of travel to the *exit*.

**4)** If a pair of doors is installed in a corridor that provides *access to exit* in both directions, the doors shall swing in opposite directions, with the door on the right hand side swinging in the direction of travel to the *exit*.

**5)** Doors that serve storage *suites* not more than 28 m<sup>2</sup> in area in warehousing *buildings* need not conform to Sentence (1).

**3.3.1.12. Sliding Doors**

**1)** Except as permitted by Sentences (2) and 3.3.1.11.(5), a sliding door provided in the locations described in Article 3.3.1.11. shall

- a) be designed and installed to swing on the vertical axis in the direction of travel to the *exit* when pressure is applied, and
- b) be identified as a swinging door by means of a label or decal affixed to it.

**2)** In a Group B, Division 1 *occupancy*, or in an *impeded egress zone* in other *occupancies*, sliding doors used in an *access to exit* need not conform to Sentence (1) and Article 3.3.1.11.

**3)** Movable *partitions* used to separate a *public corridor* from an adjacent *business and personal services occupancy* or a *mercantile occupancy* need not conform to Sentence (1)

and Sentences 3.3.1.11.(1) and (2), provided the *partitions* are not located in the only *means of egress*. (See Note A-3.3.1.12.(3).)

### 3.3.1.13. Doors and Door Hardware

- 1) Except as required by Article 3.3.3.4., a door that opens into or is located within a *public corridor* or other facility that provides *access to exit* from a *suite* shall
  - a) provide a clear opening of not less than 800 mm if there is only one door leaf,
  - b) in a doorway with multiple leaves, have the active leaf providing a clear opening of not less than 800 mm,
  - c) not open onto a step, and
  - d) have a threshold not more than 13 mm higher than the surrounding finished floor surface, except where it
    - i) is used to confine the spillage of *flammable liquids* within a *service room* or within a room in an *industrial occupancy*, or
    - ii) provides access to an exterior balcony, unless the balcony is required by Clause 3.3.1.7.(1)(c).
- 2) Except as provided in Sentences (6) and (7), a door in an *access to exit* shall be readily operable in travelling to an *exit* without requiring keys, special devices or specialized knowledge of the door-opening mechanism.
- 3) Except as permitted by Sentence (4), door release hardware shall comply with Clause 3.8.3.8.(1)(b) and the door shall be operable with not more than one releasing operation. (See also Sentence 3.8.3.6.(4).)
- 4) An egress door from an individual *dwelling unit* or from a *suite of residential occupancy* is permitted to be provided with additional devices that require a releasing operation additional to the main door release hardware, provided the devices are readily operable from the inside without the use of keys, special devices or specialized knowledge. (See Note A-3.3.1.13.(4).)
- 5) Door release hardware shall be installed not more than 1 200 mm above the finished floor.
- 6) An egress door in an *access to exit* serving a *contained use area* or an *impeded egress zone* is permitted to be equipped with locking devices, provided they can be released either locally or remotely in conformance with Sentence (8) or (9). (See Note A-3.3.1.13.(6).)
- 7) A door in an *access to exit* is permitted to be equipped with an electromagnetic lock conforming to Sentence 3.4.6.16.(4) or (5).
- 8) Local locking devices permitted by Sentence (6) shall be operable by a key from both sides of the door.
- 9) Controls for the remote release of door locking devices permitted by Sentence (6) shall be located in an area readily available to security personnel.
- 10) Locking devices permitted by Sentence (6) that are electrically operated shall be
  - a) designed to operate on emergency power, and
  - b) capable of manual release by security personnel.

### 3.3.1.14. Ramps and Stairways

- 1) Except as permitted by Sentence (2), Article 3.3.4.7. and Subsection 3.3.2., ramps and stairways that do not serve as *exits* shall conform to the requirements for *exit* ramps and stairways stated in Sentence 3.4.3.2.(8) and Articles 3.4.3.4., and 3.4.6.1. to 3.4.6.9.
- 2) Ramps and stairways that serve *service rooms*, *service spaces* or *industrial occupancies* need not comply with Sentence (1), provided
  - a) they are intended only for occasional use for servicing equipment and machinery, and
  - b) they do not serve as *exits*.

**3.3.1.15. Exterior Passageways**

**1)** An exterior passageway leading to a required *exit* shall conform to the requirements of Section 3.4. for exterior *exit* passageways.

**3.3.1.16. Tapered Treads in a Curved Flight**

**1)** *Flights* of stairs shall consist solely of

- a) straight *flights*, or
- b) curved *flights* complying with Sentence (2).

**2)** *Tapered treads* in a curved *flight* that is not required as an *exit* shall have

- a) a minimum *run* of 150 mm,
- b) a *run* not less than 280 mm when measured at a point 300 mm from the centre line of the handrail at the narrow end of the tread, and
- c) a riser conforming to Sentence 3.4.6.8.(2).

**3)** *Tapered treads* shall have a consistent angle and uniform *run* and rise dimensions in accordance with the construction tolerances stipulated in Article 3.4.6.8. when measured at a point 300 mm from the centre line of the handrail at the narrow end of the tread.

**4)** All *tapered treads* within a *flight* shall turn in the same direction.

**3.3.1.17. Capacity of Access to Exits**

(See Article 3.3.1.9. for minimum widths of corridors.)

**1)** The capacity of an *access to exit* shall be based on the *occupant load* of the portion of the *floor area* served.

**2)** In an *access to exit* the required width of ramps with a slope not more than 1 in 8, doorways, and corridors shall be based on not less than 6.1 mm per person.

**3)** In an *access to exit* the required width of a ramp with a slope more than 1 in 8 shall be based on not less than 9.2 mm per person.

**4)** In an *access to exit* from a *floor area* used or intended to be used for patients in a Group B, Division 2 *occupancy* or residents in a Group B, Division 3 *occupancy*, the required width of corridors, doorways, and ramps shall be based on not less than 18.4 mm per person.

**5)** The capacity of stairs in an *access to exit* shall conform to the requirements for stairs in Sentences 3.4.3.2.(1) to (3).

**6)** In a *building* that is not *sprinklered* throughout in accordance with Sentence 3.2.5.12.(1), an *access to exit* that is part of the principal entrance serving a dance hall or a licensed beverage establishment with an *occupant load* more than 250 shall provide at least one half of the required *exit* width.

**3.3.1.18. Guards**

**1)** Except as provided in Sentence (5) and Article 3.3.2.9., a *guard* not less than 1 070 mm high shall be provided

- a) around any roof to which access is provided for purposes other than maintenance,
- b) at openings into smoke shafts referred to in Subsection 3.2.6. that are less than 1 070 mm above the floor, and
- c) at each raised floor, *mezzanine*, balcony, gallery, interior or exterior vehicular ramp, and at other locations where (see Note A-9.8.8.1.)
  - i) the difference in elevation is more than 600 mm between the walking surface and the adjacent surface, or
  - ii) the adjacent surface within 1.2 m of the walking surface has a slope of more than 1 in 2.

**2)** Except as provided in Sentences (3) and 3.3.2.9.(4) and Articles 3.3.4.7. and 3.3.5.10., openings through *guards* shall be of a size that prevents the passage of a spherical object whose diameter is more than 100 mm.

**3)** Openings through *guards* other than those required by Sentence (1) that serve *occupancies* other than *industrial occupancies* shall be of a size that

- prevents the passage of a spherical object whose diameter is 100 mm, or
- permits the passage of a spherical object whose diameter is 200 mm.

(See Note A-9.8.8.5.(3).)

**4)** Except for *guards* conforming to Article 3.3.5.10., *guards* that protect a level located more than one *storey* or 4.2 m above the adjacent level shall be designed so that no member, attachment or opening located between 140 mm and 900 mm above the level protected by the *guard* facilitates climbing. (See Note A-9.8.8.6.(1).)

**5)** Sentence (1) does not apply

- to the front edges of *stages*,
- to loading docks, or
- where access is provided for maintenance purposes only.

### 3.3.1.19. Transparent Doors and Panels

**1)** Except as permitted by Sentence (5), a glass or transparent door shall be designed and constructed so that the existence and position of the door is readily apparent, by attaching visually contrasting hardware, bars or other permanent fixtures to it.

**2)** The visibility of fully glazed transparent doors, sidelights and panels shall be enhanced through the inclusion of mullions, markings or other elements that

- are visually contrasting,
- are at least 50 mm high,
- extend the full width of the door, sidelight or panel, and
- are located between 1 350 mm and 1 500 mm above the floor.

**3)** A glass door shall be constructed of

- laminated or tempered safety glass conforming to CAN/CGSB-12.1-M, "Tempered or Laminated Safety Glass," or
- wired glass conforming to CAN/CGSB-12.11-M, "Wired Safety Glass."

**4)** Except as permitted by Sentence (5), transparent panels used in an *access to exit* that, because of their physical configuration or design, could be mistaken as a *means of egress* shall be made inaccessible by barriers or railings.

**5)** Sliding glass *partitions* that separate a *public corridor* from an adjacent *occupancy* and that are open during normal working hours need not conform to Sentences (1) and (4), provided the *partitions* are suitably marked in conformance with Sentence (2) to indicate their existence and position.

**6)** Where vision glass is provided in doors or transparent sidelights, the lowest edge of the glass shall be no higher than 900 mm above floor level.

**7)** Glass in doors and in sidelights that could be mistaken for doors, within or at the entrances to *dwelling units* and in public areas, shall conform to the requirements of Article 9.6.1.4.

**8)** A window in a public area that extends to less than 1 000 mm above the floor and is located above the second *storey* in a *building of residential occupancy*, shall be protected by a barrier or railing to not less than 1 070 mm above the floor, or the window shall be non-openable and designed to withstand the lateral design loads for balcony *guards* required by Article 4.1.5.14.

### 3.3.1.20. Exhaust Ventilation and Explosion Venting

**1)** Except as provided in Sentence (2), an exhaust ventilation system designed in conformance with the appropriate requirements of Part 6 shall be provided in a *building* or part of a *building* in which dust, fumes, gases, vapour or other impurities or contaminants have the potential to create a fire or explosion hazard. (See also Article 4.2.4.13.)

2) Where a *fire separation* required to have a *fire-resistance rating* is penetrated by a ventilation system required by Sentence (1) for power-ventilated enclosures in laboratories, the ducts shall be

- a) continuously enclosed from the first penetrated *fire separation* to any subsequent *fire separations* or concealed spaces and all the way through to the outdoors so that the highest *fire-resistance rating* of all the penetrated *fire separations* is maintained, and
- b) exempted from the requirement to be equipped with a *fire damper*, smoke damper and fire/smoke damper as stated in Article 3.1.8.7.

3) Explosion relief devices, vents or other protective measures conforming to Subsection 6.3.1. and Article 6.9.1.2. shall be provided for a space in which substances or conditions that have the potential to create an explosion hazard are present as a result of the principal use of a *building*.

#### 3.3.1.21. Janitors' Rooms

1) Except as permitted by Sentences (2) and (3), a room or space within a *floor area* for the storage of janitorial supplies shall be separated from the remainder of the *building* by a *fire separation* having a *fire-resistance rating* not less than 1 h.

2) The *fire-resistance rating* of the *fire separation* required by Sentence (1) is permitted to be less than 1 h but not less than 45 min provided the *fire-resistance rating* required by Subsection 3.2.2. is permitted to be less than 1 h for

- a) the floor assembly above the *floor area*, or
- b) the floor assembly below the *floor area*, if there is no floor assembly above.

3) The *fire separation* required by Sentence (1) is not required to have a *fire-resistance rating* if the *floor area* in which the room or space is located is *sprinklered* throughout.

#### 3.3.1.22. Common Laundry Rooms

1) Except as permitted by Sentences (2) and (3), in a *building* of *residential occupancy*, a laundry room in a *floor area* that is not within a *dwelling unit* shall be separated from the remainder of the *building* by a *fire separation* having a *fire-resistance rating* not less than 1 h.

2) The *fire-resistance rating* of the *fire separation* required by Sentence (1) is permitted to be less than 1 h but not less than 45 min provided the *fire-resistance rating* required by Subsection 3.2.2. is permitted to be less than 1 h for

- a) the floor assembly above the *floor area*, or
- b) the floor assembly below the *floor area*, if there is no floor assembly above.

3) The *fire separation* required by Sentence (1) is not required to have a *fire-resistance rating* if the *floor area* in which the laundry room is located is *sprinklered* throughout.

#### 3.3.1.23. Obstructions

1) No obstruction shall be permitted in any *occupancy* that would restrict the width of a normal *means of egress* from any part of a *floor area* to less than 750 mm unless an alternative *means of egress* is provided adjacent to, accessible from, and plainly visible from the obstructed *means of egress*. (See Note A-3.3.1.23.(1).)

#### 3.3.1.24. Signs in Service Spaces

1) Illuminated signs conforming to Sentences 3.4.5.1.(2) and (6) shall be provided to indicate the direction to egress points in a *service space* referred to in Sentence 3.2.1.1.(8).

#### 3.3.1.25. Welding and Cutting

1) Except as provided in Sentence (2), welding and cutting operations shall be carried out in a room

- a) separated from the remainder of the *building* by a *fire separation* having a *fire-resistance rating* not less than 1 h, or
- b) protected by an automatic fire extinguishing system.

**2)** Sentence (1) shall not apply to *industrial occupancies* where the welding and cutting operations do not present a fire or explosion hazard to adjacent areas.

### 3.3.2. Assembly Occupancy

#### 3.3.2.1. Scope

**1)** This Subsection applies to *assembly occupancies* and to outdoor places of assembly.

**2)** Except as required in Sentence (3), provisions 12.2.3.2, 12.2.3.3, 12.2.5.4, 12.2.5.5, 12.2.5.6, 12.2.11.1, 12.4.1 and 12.4.2 of Chapter 12 of NFPA 101, "Life Safety Code," are permitted to be used in lieu of Articles 3.3.2.4., 3.3.2.5., 3.3.2.9., 3.3.2.11. and 3.3.2.12. (See Note A-3.3.2.1.(2).)

**3)** The minimum clear width of aisle accessways between rows of seats shall be calculated according to provisions 12.2.5.5.2, 12.2.5.5.4.1 and 12.2.5.5.5.1 of Chapter 12 of NFPA 101, "Life Safety Code," except that in no case shall the width be less than 400 mm.

#### 3.3.2.2. Fire Separations

**1)** Except as permitted by Sentence (2), the seating area of a Group A, Division 1 *occupancy* shall be separated from adjacent *occupancies* in the *floor area* by a *fire separation* having a *fire-resistance rating* not less than 1 h if the *occupant load* in the seating area exceeds 200.

**2)** The *fire-resistance rating* of the *fire separation* required by Sentence (1) is permitted to be less than 1 h but not less than 45 min provided the *fire-resistance rating* required by Subsection 3.2.2. is permitted to be less than 1 h for

- a) the floor assembly above the *floor area*, or
- b) the floor assembly below the *floor area*, if there is no floor assembly above.

**3)** If usable space exists under tiers of seats in *arena-type buildings*, a *fire separation* with a *fire-resistance rating* not less than 45 min shall be provided between the space and the seats or the space shall be *sprinklered*.

#### 3.3.2.3. Non-fixed Seating

**1)** Non-fixed seating shall conform to the NFC.

#### 3.3.2.4. Fixed Seats

**1)** Except for the requirements of Article 3.3.2.8. for bench-type seats and except as required or permitted by Sentence (2) and Articles 3.3.2.11. and 3.3.2.12., fixed seats in places of assembly shall be

- a) attached or secured to the floor, platform or platform riser,
- b) provided with arms and back, and
- c) arranged in rows having an unobstructed passage not less than 400 mm wide measured horizontally between plumb lines from the backs of the seats in one row and the edges of the furthest forward projection of the seats in the next row in the unoccupied position.

**2)** For fixed seats with backs and with folding tablet arms, the value of 400 mm required by Clause (1)(c) shall be measured when the tablet arms are in the use position, but is permitted to be measured in the stored position provided

- a) there are not more than 7 seats between any seat and the nearest aisle,
- b) the seats are located in a lecture hall or an auditorium used for instructional purposes, and
- c) the tablet arm, when raised manually to a vertical position, falls by the force of gravity to the stored position.

(See Note A-3.3.2.4.(2).)

**3)** Except as permitted by Sentence (4), aisles shall be located so that there are not more than 7 seats with backs or 20 seats without backs between any seat and the nearest aisle.

- 4)** The requirements of Sentence (3) do not apply if
  - a) egress doorways are provided to serve both ends of rows of seats,
  - b) each doorway referred to in Clause (a) serves not more than 3 rows of seats, and
  - c) each row contains not more than 100 seats.

**3.3.2.5. Aisles**

**1)** Except as required by Articles 3.3.2.11. and 3.3.2.12., aisles leading to *exits* shall be provided in conformance with Sentences (2) to (17) in places of assembly which contain fixed seats.

**2)** The minimum clear width of aisles shall be not less than 1 100 mm, except that the width is permitted to be reduced to not less than
 

- a) 750 mm if serving not more than 60 seats, and
- b) 900 mm if serving seats on one side only.

**3)** Except in the case of bleacher seats, the minimum clear width of aisles referred to in Sentence (2) shall be measured at the point farthest from an *exit*, cross aisle or foyer and shall be increased by 25 mm for each metre of distance toward the *exit*, cross aisle or foyer.

**4)** Aisles shall terminate in a cross aisle, foyer or *exit*, and the width of the cross aisle, foyer or *exit* shall be not less than the required width of the widest aisle plus 50% of the total required width of the remaining aisles that it serves.

**5)** Dead-end aisles shall be not more than 6 m long.

**6)** The length of travel to an *exit* door by any aisle shall be not more than 45 m.

**7)** Side aisles shall be not less than 1 100 mm wide if seating is provided in conformance with Sentence 3.3.2.4.(4).

**8)** An aisle that has a slope not more than 1 in 8 shall not be stepped.

**9)** An aisle that slopes more than 1 in 8 shall be stepped.

**10)** The passageway between rows of seats served by a stepped aisle shall be level at right angles to the line of travel.

**11)** The riser of a step in an aisle shall be
 

- a) not less than 110 mm high, and
- b) not more than 200 mm high.

**12)** Variations are permitted in riser height provided
 

- a) the height of adjacent risers does not vary by more than 6 mm, and
- b) the width of a tread or a platform in the direction of travel is not less than 430 mm.

**13)** Steps in an aisle shall
 

- a) have a *run* not less than 230 mm exclusive of nosings,
- b) have a tread width not less than 250 mm,
- c) extend to the adjacent rows of seats in a manner that will not create a hazard from tripping, and
- d) have a finish on the treads conforming to Sentence 3.4.6.1.(1).

**14)** The location of every riser in an aisle shall be made apparent from both directions of travel by strategically placed lighting or contrasting marking stripes.

**15)** A platform in an aisle shall be level, except that a slope not more than 1 in 50 is permitted for a platform that is not less than 430 mm wide in the direction of *exit* travel.

**16)** If a step is used at the entry to a row of seats from a stepped aisle, an unobstructed platform not less than 800 mm square shall be provided adjacent to the aisle.

**17)** The finish of the surface of a platform in or adjacent to a stepped aisle shall conform to Sentence 3.4.6.1.(1).

**3.3.2.6. Corridors**

- 1)** Except as permitted by Sentences (2) to (4), a corridor used by the public in an *assembly occupancy* as an *access to exit* shall be separated from the remainder of the *floor area* by a *fire separation* having a *fire-resistance rating* not less than 1 h.
- 2)** The *fire-resistance rating* of the *fire separation* required by Sentence (1) is permitted to be less than 1 h but not less than 45 min provided the *fire-resistance rating* required by Subsection 3.2.2. is permitted to be less than 1 h for
  - a) the floor assembly above the *floor area*, or
  - b) the floor assembly below the *floor area*, if there is no floor assembly above.
- 3)** The *fire-resistance rating* required by Sentence (1) is permitted to be waived if the *floor area* in which the corridor is located is *sprinklered* throughout.
- 4)** The requirement for a *fire separation* stated in Sentence (1) is permitted to be waived if the distance from any point in the *floor area* to an *exit* measured along the path of travel to the *exit* does not exceed the travel distance permitted by Article 3.4.2.5.

**3.3.2.7. Doors**

- 1)** A door equipped with a latching mechanism in an *access to exit* from a room or *suite of assembly occupancy* containing an *occupant load* more than 100 shall be equipped with a device that will release the latch and allow the door to swing wide open when a force not more than that specified in Sentence 3.8.3.6.(8) is applied to the device in the direction of travel to the *exit*.

**3.3.2.8. Fixed Bench-Type Seats without Arms**

- 1)** If fixed bench-type seats without arms are provided, the seat width per person shall be assumed to be 450 mm.
- 2)** The centre-to-centre spacing between rows of bench-type seats shall be not less than 760 mm if back rests are provided, and not less than 550 mm if back rests are not provided.
- 3)** A clear space of not less than 300 mm shall be provided between the back of each seat and the front of the seat immediately behind it.

**3.3.2.9. Guards**

- 1)** Except as required by Sentences (2) to (4) for bleacher seats, *guards* shall be installed in outdoor and indoor places of assembly with fixed seats so that
  - a) at the fascia of every box, balcony or gallery where the seats extend to the edge, the height of *guards* is not less than
    - i) 760 mm in front of the seats, and
    - ii) 920 mm if located at the end of aisles or at the foot of steps,
  - b) the height of *guards* along every cross aisle other than those adjacent to the fascia of every box, balcony or gallery is not less than 660 mm, except that *guards* need not be provided if the backs of the seats along the front side of the aisle are not less than 600 mm above the floor of the aisle, and
  - c) where the seating is arranged in successive tiers and the height of rise between platforms is more than 450 mm, the height of *guards* is not less than 660 mm along the entire row of seats at the edge of the platform.
- 2)** The backs and ends of bleacher seats more than 1 200 mm above the ground or floor that are not adjacent to a wall shall be protected with a *guard*
  - a) not less than 1 070 mm high above an adjacent aisle surface or foot rest, and
  - b) not less than 920 mm high above the centre of an adjacent seat board.
- 3)** If the front of a bleacher is more than 600 mm above the ground or floor, it shall be protected with a *guard* not less than 840 mm high above the front foot rest.
- 4)** The size of any opening in a *guard* required by Sentences (2) and (3) shall not allow the passage of a sphere whose diameter is more than 300 mm.



**3.3.2.10. Handrails in Aisles with Steps**

(See Note A-3.3.2.10.)

- 1) Handrails shall be provided in aisles with steps in conformance with Table 3.3.2.10.

**Table 3.3.2.10.**  
**Types and Location of Handrails in Aisles with Steps**  
Forming Part of Sentence 3.3.2.10.(1)

Aisle Width	Aisle Serving Seating on One Side	Aisle Serving Seating on Both Sides
	Handrail Requirements	
Less than 1 100 mm	a continuous handrail located on the side of the aisle opposite the seats that conforms to Sentences 3.4.6.5.(5) to (8), (11), (13) and (14)	a handrail located on one side at the end of each row of seats that conforms to Sentences 3.4.6.5.(5) to (8), (11), (13) and (14)
1 100 mm or more	a centre-line handrail that conforms to Sentence (2) or a continuous handrail located on the side of the aisle opposite the seats that conforms to Sentences 3.4.6.5.(5) to (8), (11), (13) and (14), plus a handrail located at the end of each row of seats that conforms to Sentences 3.4.6.5.(5) to (8), (11), (13) and (14)	a centre line handrail that conforms to Sentence (2)

- 2) Handrails installed along aisle centre lines as required by Table 3.3.2.10. shall
  - a) comply with Sentences 3.4.6.5.(5) to (7) and (14),
  - b) have gaps not less than 560 mm and not more than 915 mm wide, measured horizontally, at intervals not exceeding five rows,
  - c) comply with Sentence 3.4.6.5.(11) at terminations and required gaps, and
  - d) have an intermediate rail located 305 mm below the principal handrail.

**3.3.2.11. Outdoor Places of Assembly**

- 1) A Group A, Division 4 *occupancy* and each tier or balcony that has a capacity of more than
  - a) 1 000 persons shall have not less than 3 separate *exits*, or
  - b) 4 000 persons shall have not less than 4 separate *exits*.
- 2) In a Group A, Division 4 *occupancy*, every seat shall be located so that the travel distance is not more than 45 m measured along the path of travel from the seat to
  - a) the ground,
  - b) an *exit*,
  - c) an opening to a passageway leading from the seating area, or
  - d) a portal, a vomitory or any other opening through the seating deck structure.
- 3) *Exits* from outdoor stadia or grandstands shall be located not more than 25 m apart.
- 4) The capacity of a *means of egress* for a Group A, Division 4 *occupancy* shall conform to the requirements of Sentence 3.4.3.2.(3).
- 5) Aisles in a Group A, Division 4 *occupancy* shall
  - a) be located so that there are not more than 20 seats between any seat and the nearest aisle, and
  - b) be not less than 1 200 mm wide, except that an aisle serving less than 60 persons is permitted to be 750 mm wide.

**3.3.2.12. Bleachers**

- 1) Steps provided in aisles of bleachers of the telescopic type shall
  - a) have risers not more than 250 mm high, and
  - b) have treads with a *run* not less than 280 mm.

- 2) If the vertical distance between seating platforms in bleachers is more than 280 mm, an intermediate step shall be provided the full width of the aisle and proportioned to provide 2 equal risers between platforms.
- 3) If the vertical distance between seating platforms in bleachers is more than 450 mm, 2 intermediate steps shall be provided the full width of the aisle so that there are 3 equal risers between platforms.
- 4) If the passageway between rows of seats is not a closed deck, footboards shall be provided so that
  - a) the total width of the footboards shall be not less than three quarters of the centre-to-centre spacing between rows of seats, and
  - b) the spacing between footboard members shall be not more than 25 mm.
- 5) Openings above footboards and below the seats in rows of bleacher seats shall be provided with intermediate construction so that there is no opening that would permit the passage of a sphere of more than 100 mm in diameter.

### 3.3.2.13. Libraries

- 1) Except as permitted by Sentence (2), a library book storage room that is not normally accessible to the public shall be separated from the remainder of the *building* by a *fire separation* with a *fire-resistance rating* not less than 2 h if it
  - a) is more than 250 m<sup>2</sup> in area, or
  - b) contains book stacks that
    - i) are more than 10 m high, or
    - ii) penetrate more than one floor assembly.
- 2) The *fire separation* required by Sentence (1) is not required if the book storage room is *sprinklered*.
- 3) Open book shelves are permitted above and below a *mezzanine* floor in a library *building* provided the height of the shelves is not more than 2.1 m but not more than 75% of the floor-to-ceiling height of the space above or below the *mezzanine* floor assembly.

### 3.3.2.14. Stages for Theatrical Performances

- 1) A *stage* for theatrical performances and ancillary spaces, including workshops, dressing rooms and storage areas, shall be *sprinklered*.
- 2) A *fire separation* with a *fire-resistance rating* not less than 1 h shall be provided between a *stage* for theatrical performances and ancillary spaces, including workshops, dressing rooms and storage areas.
- 3) Except as permitted by Sentence (6), a *stage* for theatrical performances and ancillary spaces, including workshops, dressing rooms and storage areas, shall be separated from the seating area by a *fire separation* having a *fire-resistance rating* not less than 1 h, except for a proscenium opening protected with
  - a) a sprinkler deluge system conforming to the requirements of NFPA 13, "Installation of Sprinkler Systems,"
  - b) an unframed fire curtain if the opening is not more than 20 m wide, or
  - c) a semi-rigid fire curtain if the opening is more than 20 m wide.
- 4) A fire curtain required by Sentence (3) shall be of a type acceptable to the *authority having jurisdiction* and designed to close
  - a) automatically upon the actuation of the sprinkler system,
  - b) automatically upon actuation of the fire alarm system, and
  - c) manually by remote control devices located at the curtain control panel and at each side of the *stage*.
- 5) At least 2 vents for the purpose of venting fire and smoke to the outside of a *building* shall be provided above a *stage* designed for theatrical performances and shall
  - a) have an aggregate area not less than one eighth of the area of the *stage* behind the proscenium opening, and
  - b) be arranged to open automatically upon actuation of the sprinkler system.

6) The *fire separation* referred to in Sentence (3) is not required between a *stage* and a seating area in a *building* that is *sprinklered* throughout, provided a sprinkler deluge system is installed at the boundary between the *stage* and the seating area.

### 3.3.2.15. Risers for Stairs

- 1) In a Group A, Division 2 *occupancy* used for the serving of food and beverages, an interior *flight* of stairs with fewer than 3 risers is permitted provided it
- is not less than 900 mm wide,
  - is illuminated at all times that occupants are on the premises, and
  - has a handrail on each side.

### 3.3.2.16. Storage Rooms

1) Where storage rooms are required by Part 4 of Division B of the NFC for the storage of *flammable liquids* or *combustible liquids* in *assembly occupancies*, such rooms shall not be located above or below the *first storey*.

## 3.3.3. Care, Treatment or Detention Occupancies

### 3.3.3.1. Application

1) This Subsection applies to *care, treatment* and *detention occupancies*. (See Note A-3.3.3.1.(1).)

### 3.3.3.2. Separations between Care, Treatment or Detention Occupancies and Repair Garages

1) The *fire separation* required by Sentence 3.3.5.5.(1) between a *care, treatment* or *detention occupancy* and a *repair garage* shall have no openings.

### 3.3.3.3. Corridors

- 1) Except as provided in Sentence (2), a corridor used by the public or serving patients' or residents' sleeping rooms shall have no dead-end portion.
- 2) Corridors are permitted to have dead-portions, where
- the area served by the dead-end portion has a second and separate *means of egress*, or
  - the corridor serves a *suite* of *care occupancy* and the dead-end portion does not exceed 6 m.
- 3) Corridors shall be not less than
- 2 400 mm wide in *buildings* of *treatment occupancy* where the corridors may be used to move patients or residents in beds,
  - 1 650 mm wide
    - in *buildings* of *care* or *treatment occupancy* where the corridors will not be used to move patients or residents in beds, and
    - in *buildings* of *care occupancy* with more than 10 residents and where the corridors serve the residents, or
  - 1 100 mm wide in *buildings* of *care occupancy* with not more than 10 residents.
- 4) Paired doors in a corridor referred to in Clause (3)(a) shall
- swing in opposite directions, the right-hand door swinging in the direction of travel, and
  - be not less than 1 100 mm wide.

### 3.3.3.4. Doorway Width

1) Except as provided in Sentence (2) and within individual *suites* of *care occupancy*, the minimum clear width of a doorway shall be 850 mm where it opens into or is located within a *public corridor* or other facility that provides *access to exit* for patients or residents in *floor areas* containing *care* or *treatment occupancies*.

2) The minimum clear width of doorways through which it is necessary to move patients in bed shall be 1 050 mm. (See Note A-3.3.3.4.(2).)

**3.3.3.5. Compartments and Fire Separations**

**1)** *Floor areas* containing patients' or residents' sleeping rooms in a *care* or *treatment occupancy* where overnight sleeping accommodation is provided for more than a total of 10 patients or residents shall conform to Sentences (2) to (13).

**2)** Except as permitted by Sentence (3), a *floor area* described in Sentence (1) shall be divided into not less than 2 *fire compartments*, each not more than 1 000 m<sup>2</sup> in area.

**3)** The *floor area* on either side of a *horizontal exit* conforming to Article 3.4.6.10. is permitted to be considered as a *fire compartment* in applying the requirements of this Article.

**4)** Except as permitted by Sentence (5), *fire separations* separating *fire compartments* required by Sentence (2) shall have a *fire-resistance rating* not less than 1 h.

**5)** The *fire-resistance rating* of a *fire separation* referred to in Sentence (4) is permitted to be less than 1 h but not less than 45 min provided the *fire-resistance rating* required by Subsection 3.2.2. is permitted to be less than 1 h for

- a) the floor assembly above the *floor area*, or
- b) the floor assembly below the *floor area*, if there is no floor assembly above.

**6)** The travel distance from any point within each *fire compartment* referred to in Sentence (2) to a door to an adjoining *fire compartment* shall be not more than 45 m.

**7)** Each *fire compartment* referred to in Sentence (2) shall be capable of accommodating, in addition to its own occupants, the occupants of the largest adjacent *fire compartment* based on a clear floor space of 2.5 m<sup>2</sup> per patient in the adjacent *fire compartment*.

**8)** Except as provided in Sentences (9) to (13), walls between patients' or residents' sleeping rooms and the remainder of the *floor area* shall be constructed as *fire separations* but are not required to have a *fire-resistance rating* unless one is required by other provisions in this Part. (See Note A-3.1.8.1.(1)(b).)

**9)** The *fire separation* requirements of Sentence (8) do not apply to walls within a group of intercommunicating patients' or residents' sleeping rooms, provided the group of rooms does not

- a) contain more than 5 patients or residents, or
- b) include storage, bathing or toilet facilities serving persons not occupying the group of rooms.

(See Note A-3.3.3.5.(9).)

**10)** The *fire separation* requirements of Sentence (8) do not apply to walls within individual *suites* of *care occupancy*.

**11)** A door in a *fire separation* required by Sentence (8) is permitted to be equipped with a roller latch.

**12)** Except as permitted by Sentence (13), a *fire separation* required by Sentence (8) shall not have any grilles, louvres or other openings.

**13)** A door or wall separating a patient's or resident's sleeping room from an ensuite toilet room, shower room or similar ancillary space is permitted to incorporate grilles and louvres, provided

- a) the adjacent rooms are not used to store flammable or *combustible* materials, and
- b) the openings are located so that smoke cannot pass through these rooms to other parts of the *building*.

(See Note A-3.3.3.5.(13).)

**14)** Walls between individual *suites* of *care occupancy* and the remainder of the *floor area* in *buildings* of *care occupancy* shall be constructed as *fire separations* with a *fire-resistance rating* not less than that specified for *residential occupancies* in Sentences 3.3.4.2.(1) and (2).

**15)** Floor assemblies within individual *suites* of *care occupancy* need not be constructed as *fire separations*, provided the *suites* meet the conditions described in Clauses 3.3.4.2.(3)(a) and (b).

**16)** The *fire-resistance rating* of the *fire separation* required by Sentence 3.3.5.6.(1) is permitted to be waived if the *fire separation* is located between individual *suites of care occupancy* and an attached *storage garage* containing not more than 5 vehicles, provided the conditions described in Sentence 3.3.4.2.(4) are met.

### 3.3.3.6. Areas of Refuge

**1)** Compartments containing rooms such as operating rooms, recovery rooms, delivery rooms and intensive care units, from which it is impracticable to move patients in an emergency, shall be

- a) separated from adjacent spaces by *fire separations* having a *fire-resistance rating* not less than 1 h, and
- b) provided with a mechanical air supply so that during a period of 2 h after the start of a fire in another space, the compartments will not contain more than 1% by volume of contaminated air from the fire area.

### 3.3.3.7. Contained Use Areas

**1)** A *contained use area* shall conform to Sentences (2) to (5).

**2)** A *contained use area* shall be separated from the remainder of the *building* by a *fire separation* having a *fire-resistance rating* not less than 1 h.

**3)** Except as permitted by Sentence (4), a *building* that includes a *contained use area* shall be *sprinklered* throughout.

**4)** A *contained use area*, in a *building* for which Articles 3.2.2.20. to 3.2.2.90. do not require the installation of an automatic sprinkler system, is not required to be *sprinklered* as required by Sentence (3) provided

- a) the *building* is designed so that during a period of 2 h after the start of a fire in the *contained use area* other *fire compartments* will not contain more than 1% by volume of contaminated air from the *contained use area*,
- b) the *building* is designed so that during a period of 2 h after the start of a fire in another part of the *building* the *contained use area* will not contain more than 1% by volume of contaminated air from the other part of the *building*,
- c) all doors are designed to be remotely released in conformance with Sentence 3.3.1.13.(6), and
- d) the *contained use area* does not contain any rooms lined with *combustible padding*.

**5)** A corridor serving a *contained use area* shall have no dead-end portion unless the area served by the dead-end portion has a second and separate *means of egress*.

## 3.3.4. Residential Occupancy

### 3.3.4.1. Scope

**1)** This Subsection applies to *residential occupancies*.

### 3.3.4.2. Fire Separations

**1)** Except as permitted by Sentences (2) and 3.2.2.9.(2), *suites of residential occupancy* shall be separated from each other and the remainder of the *building* by a *fire separation* having a *fire-resistance rating* not less than 1 h.

**2)** The *fire-resistance rating* of the *fire separation* required by Sentence (1) is permitted to be less than 1 h but not less than 45 min provided the *fire-resistance rating* required by Subsection 3.2.2. is permitted to be less than 1 h for

- a) the floor assembly above the *floor area*, or
- b) the floor assembly below the *floor area*, if there is no floor assembly above.

- 3)** Floor assemblies within a *dwelling unit* need not be constructed as *fire separations* provided
- a) the distance between the lowest floor level and the uppermost floor level within the *dwelling unit* is not more than 6 m, and
  - b) the *dwelling unit* is separated from the remainder of the *building* by a *fire separation* having a *fire-resistance rating* not less than
    - i) 1 h if the *building* is not *sprinklered* throughout,
    - ii) 45 min if the *building* is *sprinklered* throughout and it is not more than 3 *storeys* in *building height*, or
    - iii) 1 h if the *building* is *sprinklered* throughout and it is more than 3 *storeys* in *building height*.
- 4)** The *fire-resistance rating* of the *fire separation* required by Sentence 3.3.5.6.(1) is permitted to be waived if the *fire separation* is located between a *dwelling unit* and an attached *storage garage* containing not more than 5 vehicles, provided
- a) the *dwelling unit* and the attached *storage garage* are *sprinklered*,
  - b) the *dwelling unit* and the attached *storage garage* are separated from the remainder of the *building* in conformance with Sentences (1), (2) and (3),
  - c) there are no air duct systems connecting the *storage garage* and the *dwelling unit*,
  - d) the construction between the *storage garage* and the *dwelling unit* provides an effective barrier to gas and exhaust fumes, and
  - e) every door between the *storage garage* and the *dwelling unit* is
    - i) tight fitting and weather-stripped to provide an effective barrier against the passage of gas and exhaust fumes,
    - ii) fitted with a self-closing device, and
    - iii) not located in a room intended for sleeping.
- 5)** The *fire separation* required by Sentence 3.3.5.6.(1) is not required between a *dwelling unit* and an attached *storage garage*, serving that *dwelling unit* only, provided
- a) the *dwelling unit* and its attached *storage garage* are separated from the remainder of the *building* in conformance with Sentences (1), (2) and (3),
  - b) there are no air duct systems connecting the *storage garage* and the *dwelling unit*,
  - c) the construction between the *storage garage* and the *dwelling unit* provides an effective barrier to gas and exhaust fumes, and
  - d) every door between the *storage garage* and the *dwelling unit* is
    - i) tight fitting and weather-stripped to provide an effective barrier against the passage of gas and exhaust fumes,
    - ii) fitted with a self-closing device, and
    - iii) not located in a room intended for sleeping.

### 3.3.4.3. Storage Rooms

- 1)** Sprinklers shall be installed in a storage room provided for the use of tenants in a *residential occupancy* within a *floor area* but not contained within a *suite*.
- 2)** Except as permitted by Sentence (3), a storage room referred to in Sentence (1) shall be separated from the remainder of the *building* by a *fire separation* having a *fire-resistance rating* not less than 1 h.
- 3)** The *fire-resistance rating* of the *fire separation* required by Sentence (2) is permitted to be less than 1 h but not less than 45 min provided the *fire-resistance rating* required by Subsection 3.2.2. is permitted to be less than 1 h for
- a) the floor assembly above the *floor area*, or
  - b) the floor assembly below the *floor area*, if there is no floor assembly above.
- 4)** Except for the storage of *flammable liquids* and *combustible liquids* inside a single-family *dwelling unit* and garages or sheds attached to these *dwelling units*, where storage rooms are required by Part 4 of Division B of the NFC for the storage of *flammable liquids* or *combustible liquids* in *residential occupancies*, such rooms shall not be located above or below the *first storey*.

**3.3.4.4. Egress from Dwelling Units**

**1)** Single *storey dwelling units* in an apartment building need not lead to a *public corridor* or exterior passageway on the same *storey* provided the *dwelling units* are served by private stairways leading directly to a *public access to exit* on the *storey*

- a) immediately above, and
- b) immediately below.

(See Note A-3.3.4.4.(1).)

**2)** Except as permitted by Sentences (3) and (4), a *dwelling unit* containing more than one *storey* shall have an *exit* door or an egress door opening directly into a *public access to exit* from the uppermost *storey* and from the lowest *storey* of the *dwelling unit* so that each of these *storeys* is served by an *exit* or egress door located not more than 1.5 m above or below its floor level.

**3)** A single *exit* is permitted from a *dwelling unit* provided the *exit* is an exterior doorway not more than 1.5 m above adjacent ground level and

- a) it is not necessary to travel up or down more than one *storey* to reach the *exit* door, or
- b) the uppermost floor level opens to a balcony not more than 6 m above adjacent ground level.

**4)** An egress door from either the uppermost *storey* or the lowest *storey* of a *dwelling unit*, as required by Sentence (2), need not be provided if that *storey* is served by a stairway that

- a) leads to a *public access to exit*,
- b) has no direct access to any other *storey* in the *dwelling unit*, and
- c) is separated from the other *storeys* in the *dwelling unit* by a *fire separation* having a *fire-resistance rating* not less than 45 min.

**5)** In a *building of residential occupancy* not more than 3 *storeys* in *building height*, a doorway from a *dwelling unit* is permitted to open directly into an *exit* stairway provided the *dwelling unit* has a second and separate *means of egress*.

**6)** If a *dwelling unit* has a second and separate *means of egress*, one *means of egress* from a *dwelling unit* is permitted to pass through

- a) an interior corridor served by a single *exit*,
- b) an exterior balcony served by a single *exit* stairway, or
- c) an exterior passageway served by a single *exit* stairway.

**3.3.4.5. Automatic Locking Prohibition**

**1)** Except for hotels and motels, a door opening onto a *public corridor* which provides *access to exit* from a *suite* shall be designed not to lock automatically. (See Note A-3.3.4.5.(1).)

**3.3.4.6. Sound Transmission**

**1)** Occupants of *dwelling units* shall be protected from airborne noise in conformance with Section 5.8.

**3.3.4.7. Stairs, Ramps, Landings, Handrails and Guards for Dwelling Units**

**1)** Except as required in Article 3.3.4.8., stairs, ramps, landings, handrails and *guards* within a *dwelling unit* shall conform to the appropriate requirements in Section 9.8.

**2)** Exterior stairs, ramps, landings, handrails and *guards* serving a single *dwelling unit*, and loads on *guards* serving not more than two *dwelling units*, shall conform to the appropriate requirements in Section 9.8.

**3.3.4.8. Protection of Openable Windows**

- 1) Except as provided in Sentence (2), openable windows in *suites* of *residential occupancy* shall be protected by
  - a) a *guard* with a minimum height of 1 070 mm constructed in accordance with Article 3.3.1.18., or
  - b) a mechanism capable of controlling the free swinging or sliding of the openable part of the window so as to limit any clear unobstructed opening to not more than 100 mm measured either vertically or horizontally where the other dimension is greater than 380 mm.
- 2) Windows need not be protected in accordance with Sentence (1) where
  - a) the only opening having greater dimensions than those allowed by Clause (1)(b) is located higher than 1 070 mm above the finished floor, or
  - b) the bottom edge of the openable portion of the window is located less than 1 800 mm above the floor or ground on the other side of the window.

**3.3.5. Industrial Occupancy****3.3.5.1. Scope**

- 1) This Subsection applies to *industrial occupancies*.

**3.3.5.2. Fire Extinguishing Systems**

- 1) In addition to other requirements in this Code for the installation of automatic fire extinguishing systems, an appropriate fire extinguishing system shall be installed in every *industrial occupancy floor area* to provide protection if required by
  - a) provincial or territorial regulations or municipal bylaws, or
  - b) the NFC, in the absence of the regulations or bylaws referred to in Clause (a).

**3.3.5.3. Basements**

- 1) A *basement* shall not be used for the storage, manufacture or handling of volatile solids, liquids or gases that generate explosive air-vapour mixtures or for processes that involve explosive dusts.
- 2) Entrances and *exits* to a *basement* and to rooms containing *building services* shall be separate from the remainder of the *building* in a *building* in which
  - a) the storage, manufacture or handling of volatile materials can generate explosive air-vapour mixtures, or
  - b) processes occur that produce explosive dusts.
- 3) *Basements* and rooms referred to in Sentence (2) shall be separated from the remainder of the *building* with a vapour-tight separation.

**3.3.5.4. Repair and Storage Garages**

- 1) If access is provided from a *storage garage* to a stair tower or elevator serving *occupancies* above the level of the *storage garage*, the access shall be through a vestibule conforming to Sentence 3.3.5.7.(4).
- 2) Treads and landings in interior stairs that extend to the roof of a *storage garage* shall be designed to be free of accumulations of ice and snow.
- 3) A mechanical *storage garage* not more than 4 *storeys* in *building height*, in which no persons other than parking attendants are permitted above the *street floor level*, need not have a *fire separation* between the *exits* and the remainder of the *building*.
- 4) A garage shall be provided with natural or mechanical ventilation in conformance with the requirements of Subsection 6.3.1. and Article 6.9.1.2. to prevent excessive accumulation of carbon monoxide, exhaust fumes or flammable and toxic vapours.
- 5) The clear height in a *storage garage* shall be not less than 2 m.



**6)** Where garage floors or ramps are 600 mm or more above the adjacent ground or floor level, every opening through such floors and the perimeter of floors and ramps shall be provided with

- a) a continuous curb not less than 140 mm high, a *guard* not less than 1 070 mm high, and a vehicle guardrail not less than 500 mm high conforming to Sentence (7), or
- b) a full-height wall conforming to Sentence (7).

**7)** Vehicle guardrails and full-height walls required in Sentence (6) shall be designed and constructed to withstand the loading values stipulated in Sentence 4.1.5.15.(1).

**8)** Except for *open-air storeys*, every *storey* of a *storage garage* or *repair garage* located below *grade* shall be *sprinklered*.

### 3.3.5.5. Repair Garage Separation

**1)** A *repair garage* and any ancillary spaces serving it, including waiting rooms, reception rooms, tool and parts storage areas and supervisory office space, shall be separated from other *occupancies* by a *fire separation* having a *fire-resistance rating* not less than 2 h.

### 3.3.5.6. Storage Garage Separation

**1)** Except as permitted by Sentences 3.3.4.2.(4) and (5), a *storage garage* shall be separated from other *occupancies* by a *fire separation* with a *fire-resistance rating* not less than 1.5 h.

### 3.3.5.7. Vestibules

**1)** Except as provided in Sentence (2), if access is provided through a *fire separation* between a *storage garage* and a Group A, Division 1 or Group B *occupancy*, the access shall be through a vestibule conforming to Sentence (4).

**2)** If access is provided through a *fire separation* between a *storage garage* and a Group B, Division 3 *occupancy* with not more than 10 occupants, access need not be through a vestibule, provided the *fire separation* complies with Clauses 3.3.4.2.(5)(b) to (d).

**3)** In a *building* more than 3 *storeys* in *building height*, access through a *fire separation* between a *storage garage* and a Group A, Division 2, 3 or 4, or a Group C *occupancy*, shall be through a vestibule conforming to Sentence (4).

**4)** If access is provided through a vestibule, as required by Sentences (1), (3) and 3.3.5.4.(1), the vestibule shall

- a) be not less than 1.8 m long,
- b) be ventilated
  - i) naturally to outside air by a vent that has an unobstructed area of not less than 0.1 m<sup>2</sup> for each door that opens into the vestibule but not less than 0.4 m<sup>2</sup>, or
  - ii) mechanically at a rate of 14 m<sup>3</sup>/h for each square metre of vestibule floor surface area, and
- c) have openings between the vestibule and an adjoining *occupancy* provided with self-closing doors with no hold-open devices.

### 3.3.5.8. Dispensing of Fuel

**1)** Facilities for the dispensing of fuel having a *flash point* below 37.8°C shall not be installed above any space intended for *occupancy*.

**2)** Facilities for the dispensing of fuel having a *flash point* below 37.8°C shall not be installed in any *building*, except that this requirement does not apply to a canopy which is open on not less than 75% of its perimeter.

**3.3.5.9. Multiple-Tenant Self-Storage Warehouses**

**1)** Except as provided in Sentence 3.9.3.1.(5) or unless the *building* is *sprinklered* throughout, each individual tenancy in a multiple tenant self storage warehouse classified as an *industrial occupancy* shall be separated from the remainder of the *building* by a *fire separation* having a *fire-resistance rating* not less than 45 min.

**3.3.5.10. Guards**

**1)** Except where they serve *storage garages*, *guards* in *industrial occupancies* are permitted to consist of

- a) a top railing, and
- b) one or more intermediate rails spaced such that openings through the *guard* are of a size that prevents the passage of a spherical object whose diameter is 535 mm.

**3.3.6. Design of Hazardous Areas****3.3.6.1. Application**

**1)** This Subsection applies to design and fire protection requirements for *buildings* or parts thereof used for the storage, handling, use and processing of *dangerous goods*, including *flammable liquids* and *combustible liquids*, in quantities in excess of those identified in Table 3.2.7.1. of Division B of the NFC. (See Note A-3.3.6.1.(1).)

**3.3.6.2. Storage of Dangerous Goods**

**1)** Solid and liquid *dangerous goods* classified as oxidizers or organic peroxides shall be separated from the remainder of the *building* by a *fire separation* having a *fire-resistance rating* of not less than 2 h.

**2)** Reactive materials shall be separated from the remainder of the *building* by a *fire separation* having a *fire-resistance rating* of not less than 2 h. (See Note A-3.3.6.2.(2).)

**3)** The design of *buildings* or parts thereof used for the storage of *dangerous goods* classified as explosives shall conform to the "Explosives Act" and its Regulations, published by Natural Resources Canada.

**4)** Where wiring or electrical equipment is located in areas in which flammable gases or vapours, *combustible dusts* or *combustible fibres* are present in quantities sufficient to create a hazard, such wiring and electrical equipment shall conform to CSA C22.1, "Canadian Electrical Code, Part I," for hazardous locations. (See Note A-3.3.6.2.(4).)

**3.3.6.3. Indoor Storage of Anhydrous Ammonia and Flammable, Toxic and Oxidizing Gases**

**1)** Where required by the NFC, cylinders of *dangerous goods* classified as flammable gases stored indoors shall be located in a room

- a) that is separated from the remainder of the *building* by a *gas-tight fire separation* having a *fire-resistance rating* of at least 2 h,
- b) that is located on an exterior wall of the *building*,
- c) that can be entered from the exterior, and
- d) whose *closures* leading to the interior of the *building* are
  - i) equipped with self-closing devices that keep the *closures* closed when not in use, and
  - ii) constructed so as to prevent the migration of gases from the room into other parts of the *building*.

**2)** Where required by the NFC, cylinders of anhydrous ammonia or *dangerous goods* classified as toxic or oxidizing gases stored indoors shall be located in a room

- a) that is separated from the remainder of the *building* by a *gas-tight fire separation* having a *fire-resistance rating* of at least 1 h,
- b) that is located on an exterior wall of the *building*,

- c) that can be entered from the exterior, and
- d) whose *closures* leading to the interior of the *building* are
  - i) equipped with self-closing devices that keep the *closures* closed when not in use, and
  - ii) constructed so as to prevent the migration of gases from the room into other parts of the *building*.

#### 3.3.6.4. Storage and Dispensing Rooms for Flammable Liquids and Combustible Liquids

1) *Fire separations* for rooms where *flammable liquids* and *combustible liquids* are stored are required to be constructed with a *fire-resistance rating* in conformance with Subsection 4.2.9. of Division B of the NFC.

2) Where Class IA or IB liquids specified in Subsection 4.1.2. of Division B of the NFC are dispensed within a storage room, the room shall be designed to prevent critical structural and mechanical damage from an internal explosion in conformance with good engineering practice such as that described in NFPA 68, "Explosion Protection by Deflagration Venting." (See Note A-3.3.6.4.(2).)

#### 3.3.6.5. Tire Storage

1) A tire storage area designed to contain more than 375 m<sup>3</sup> of rubber tires shall be separated from the remainder of the *building* by a *fire separation* having a *fire-resistance rating* of not less than 2 h. (See Note A-3.3.6.5.(1).)

#### 3.3.6.6. Ammonium Nitrate Storage

1) Where Article 3.2.9.1. of Division B of the NFC applies due to the quantity and nature of the stored product, and as stipulated in Sentences (2) to (6), *buildings* used for the storage of ammonium nitrate shall be classified as *medium-hazard industrial occupancies* (Group F, Division 2).

2) *Buildings* intended for the storage of ammonium nitrate shall be not more than one *storey* in *building* height.

3) *Buildings* intended for the storage of ammonium nitrate shall not

- a) have *basements* or crawl spaces, or
- b) contain open floor drains, tunnels, elevator pits or other pockets that might trap molten ammonium nitrate.

4) *Buildings* intended for the storage of ammonium nitrate shall have not less than 0.007 m<sup>2</sup> of vent area for each square metre of storage area, unless mechanical ventilation is provided.

5) All flooring in storage areas described in Sentence (1) shall be constructed of *noncombustible* materials.

6) *Buildings* intended for the storage of ammonium nitrate shall be designed to prevent the ammonium nitrate from coming into contact with *building* materials that

- a) will cause the ammonium nitrate to become unstable,
- b) may corrode or deteriorate by reason of contact with the ammonium nitrate, or
- c) will become impregnated with the ammonium nitrate.

(See Note A-3.3.6.6.(6).)

#### 3.3.6.7. Flooring Materials

1) Floors in areas where *dangerous goods* are stored shall be constructed of impermeable materials to prevent the absorption of chemicals.

#### 3.3.6.8. Fire Separations in Process Plants

1) In *process plants*, areas where unstable liquids are handled or where small-scale unit chemical processes occur shall be separated from the remainder of the *building* by a *fire separation* having a *fire-resistance rating* of not less than 2 h.

**3.3.6.9. Basements and Pits**

1) *Process plants* where Class I and II *flammable liquids* and *combustible liquids* are handled shall not be constructed with *basements* or covered pits.

**Section 3.4. Exits****3.4.1. General****3.4.1.1. Scope**

1) *Exit* facilities complying with this Section shall be provided from every *floor area* that is intended for *occupancy*. (See Note A-3.4.1.1.(1).)

**3.4.1.2. Separation of Exits**

1) Except as permitted by Sentence (2), if more than one *exit* is required from a *floor area*, each *exit* shall be separate from every other *exit* leading from that *floor area*.

2) If more than 2 *exits* are provided from a *floor area*, *exits* are permitted to converge in conformance with Sentence 3.4.3.1.(2), provided the cumulative capacity of the converging *exits* does not contribute more than 50% of the total required *exit* width for the *floor area*.

**3.4.1.3. Access to Exits**

1) *Access to exits* shall conform to Section 3.3.

**3.4.1.4. Types of Exit**

1) Subject to the requirements of this Section, an *exit* from any *floor area* shall be one of the following, used singly or in combination:

- a) an exterior doorway,
- b) an exterior passageway,
- c) an exterior ramp,
- d) an exterior stairway,
- e) a fire escape (conforming to Subsection 3.4.7.),
- f) a *horizontal exit*,
- g) an interior passageway,
- h) an interior ramp, or
- i) an interior stairway.

**3.4.1.5. Exterior Exit Passageways**

1) Access to an exterior *exit* passageway from a *floor area* shall be through *exit* doors at the floor level.

**3.4.1.6. Restricted Use of Horizontal Exits**

1) Except as permitted by Sentence (2), *horizontal exits* shall not comprise more than one half of the required number of *exits* from any *floor area*.

2) In a hospital or nursing home with *treatment*, *horizontal exits* serving patients' sleeping rooms shall comprise not more than two thirds of the required number of *exits* from any *floor area*. (See Note A-3.4.1.6.(2).)

**3.4.1.7. Slide Escapes**

1) A slide escape shall not be erected on any *building* as a required *exit*, but is permitted to be provided as an additional egress facility if unusual hazards are foreseen.

**3.4.1.8. Transparent Doors and Panels**

1) Glass and transparent panels in an *exit* shall conform to the appropriate requirements of Article 3.3.1.19. for glass and transparent panels in an *access to exit*.

**3.4.1.9. Mirrors near Exits**

1) No mirror shall be placed in or adjacent to any *exit* in a manner that would confuse the direction of *exit*.

**3.4.1.10. Combustible Glazing in Exits**

1) *Combustible* glazing is not permitted in wall or ceiling assemblies or in *closures* used to construct an *exit* enclosure.

**3.4.2. Number and Location of Exits from Floor Areas**

**3.4.2.1. Minimum Number of Exits**

1) Except as permitted by Sentences (2) to (4), every *floor area* intended for *occupancy* shall be served by at least 2 *exits*.

2) A *floor area* in a *building* not more than 2 *storeys* in *building height*, is permitted to be served by one *exit* provided the total *occupant load* served by the *exit* is not more than 60, and

- a) in a *floor area* that is not *sprinklered* throughout, the *floor area* and the travel distance are not more than the values in Table 3.4.2.1.-A, or
- b) in a *floor area* that is *sprinklered* throughout
  - i) the travel distance is not more than 25 m, and
  - ii) the *floor area* is not more than the value in Table 3.4.2.1.-B.

**Table 3.4.2.1.-A**  
**Criteria for One Exit (Floor Area Not Sprinklered Throughout)**  
 Forming Part of Sentence 3.4.2.1.(2)

<i>Occupancy of Floor Area</i>	Maximum <i>Floor Area</i> , m <sup>2</sup>	Maximum Travel Distance, m
Group A	150	15
Group B	75	10
Group C	100	15
Group D	200	25
Group E	150	15
Group F, Division 2	150	10
Group F, Division 3	200	15

**Table 3.4.2.1.-B**  
**Criteria for One Exit (Floor Area Sprinklered Throughout)**  
 Forming Part of Sentence 3.4.2.1.(2)

<i>Occupancy of Floor Area</i>	Maximum <i>Floor Area</i> , m <sup>2</sup>
Group A	200
Group B	100
Group C	150
Group D	300
Group E	200
Group F, Division 2	200
Group F, Division 3	300

**3)** Except as permitted by Sentence (4), if Sentence (2) permits a single *exit* from a *floor area* classified as Group B or Group C *occupancy*, the *exit* shall be an exterior doorway not more than 1.5 m above adjacent ground level.

**4)** The requirements of Sentences (1) and (2) are permitted to be waived for *dwelling units* that have an *access to exit* conforming to Sentences 3.3.4.4.(1) to (4).

**5)** *Exits* are not required directly from rooftop enclosures that are provided with *access to exits* in conformance with Sentences 3.3.1.3.(5) and (6).

### 3.4.2.2. Means of Egress from Mezzanines

**1)** Except as permitted by Sentences (2) and (3), the space above a *mezzanine* shall be served by *means of egress* leading to *exits* accessible at the *mezzanine* level on the same basis as *floor areas*.

**2)** The *means of egress* from a *mezzanine* need not conform to Sentence (1), provided

- a) the *mezzanine* is not required to terminate at a vertical *fire separation*, as permitted in Sentence 3.2.8.2.(1),
- b) the *occupant load* of the *mezzanine* is not more than 60,
- c) the area of the *mezzanine* does not exceed the area limits stated in Table 3.4.2.2., and
- d) the distance limits stated in Table 3.4.2.2. measured along the path of travel are not exceeded from any point on the *mezzanine* to
  - i) an egress door serving the space that the *mezzanine* overlooks, if the space is served by a single egress door, or
  - ii) the egress stairway leading to an *access to exit* in the space below if that space is required to be served by 2 or more egress doorways in conformance with Sentence 3.3.1.5.(1).

**3)** At least half of the required *means of egress* from a *mezzanine* shall comply with Sentence (1) if the *mezzanine* is not required to terminate at a *fire separation* as permitted by Sentence 3.2.8.2.(1).

**Table 3.4.2.2.**  
**Criteria for Egress from Mezzanine Space**  
Forming Part of Sentence 3.4.2.2.(2)

Occupancy of Space	Maximum Area, m <sup>2</sup>	Distance Limits, m
<i>Assembly occupancy</i>	150	15
<i>Residential occupancy</i>	100	15
<i>Business and personal services occupancy</i>	200	25
<i>Mercantile occupancy</i>	150	15
<i>Medium-hazard industrial occupancy</i>	150	10
<i>Low-hazard industrial occupancy</i>	200	15

### 3.4.2.3. Distance between Exits

**1)** Except as provided in Sentence (2), the least distance between 2 *exits* from a *floor area* shall be

- a) one half the maximum diagonal dimension of the *floor area*, but need not be more than 9 m for a *floor area* having a *public corridor*, or
- b) one half the maximum diagonal dimension of the *floor area*, but not less than 9 m for all other *floor areas*.

(See Note A-3.4.2.3.(1).)

**2)** *Exits* need not comply with Sentence (1) where

- a) the *floor area* is divided so that not less than one third of the *floor area* is on each side of a *fire separation*, and
- b) it is necessary to pass through the *fire separation* to travel from one *exit* to another *exit*.

**3)** The minimum distance between *exits* referred to in Sentence (1) shall be the shortest distance that smoke would have to travel between the *exits*, assuming that the smoke will not penetrate an intervening *fire separation*.

**4)** The distance between 2 exterior discharges of *exit* stairs serving the same *floor area* shall be

- a) not less than 9 m, or
- b) not less than 6 m, where
  - i) the *building* is *sprinklered* throughout, and
  - ii) the 2 exterior discharges are located within 15 m of a *street*.

#### 3.4.2.4. Travel Distance

**1)** Except as permitted by Sentence (2), for the purposes of this Subsection, travel distance means the distance from any point in the *floor area* to an *exit* measured along the path of travel to the *exit*.

**2)** The travel distance from a *suite* or a room not within a *suite* is permitted to be measured from an egress door of the *suite* or room to the nearest *exit*, provided

- a) the *suite* or room is separated from the remainder of the *floor area* by a *fire separation*
  - i) having a *fire-resistance rating* not less than 45 min in a *floor area* that is not *sprinklered* throughout, or
  - ii) which is not required to have a *fire-resistance rating*, in a *floor area* that is *sprinklered* throughout, and
- b) the egress door opens onto
  - i) an exterior passageway,
  - ii) a corridor used by the public that is separated from the remainder of the *floor area* in conformance with the requirements in Article 3.3.1.4. for the separation of *public corridors*, or
  - iii) a *public corridor* that is separated from the remainder of the *floor area* in conformance with Article 3.3.1.4. (see Note A-3.1.8.1.(1)(b)).

**3)** Travel distance to an *exit* shall be not more than 50 m from any point in a *service space* referred to in Sentence 3.2.1.1.(8).

#### 3.4.2.5. Location of Exits

**1)** Except as permitted by Sentences (2) and 3.3.2.5.(6), if more than one *exit* is required from a *floor area*, the *exits* shall be located so that the travel distance to at least one *exit* shall be not more than

- a) 25 m in a *high-hazard industrial occupancy*,
- b) 40 m in a *business and personal services occupancy*,
- c) 45 m in a *floor area* that contains an *occupancy* other than a *high-hazard industrial occupancy*, provided it is *sprinklered* throughout,
- d) 105 m in any *floor area*, served by a *public corridor*, in which rooms and *suites* are not separated from the remainder of the *floor area* by a *fire separation*, provided
  - i) the *public corridor* is not less than 9 m wide,
  - ii) the ceiling height in the *public corridor* is not less than 4 m above all floor surfaces,
  - iii) the *building* is *sprinklered* throughout, and
  - iv) not more than one half of the required egress doorways from a room or *suite* open into the *public corridor* if the room or *suite* is required to have more than one egress doorway,
- e) 60 m in any *storage garage* that conforms to the requirements of Article 3.2.2.90., and
- f) 30 m in any *floor area* other than those referred to in Clauses (a) to (e).

**2)** Except for a *high-hazard industrial occupancy*, Sentence (1) need not apply if *exits* are placed along the perimeter of the *floor area* and are not more than 60 m apart,

measured along the perimeter, provided each main aisle in the *floor area* leads directly to an *exit*.

**3)** *Exits* shall be located and arranged so that they are clearly visible or their locations are clearly indicated and they are accessible at all times.

### 3.4.2.6. Principal Entrances

**1)** For the purposes of this Section, at least one door at every principal entrance to a *building* providing access from the exterior at ground level shall be designed in accordance with the requirements for *exits*.

**2)** In a *building* that is not *sprinklered* throughout in accordance with Sentence 3.2.5.12.(1), the principal entrance serving a dance hall or a licensed beverage establishment with an *occupant load* more than 250 shall provide at least one half of the required *exit* width.

## 3.4.3. Width and Height of Exits

### 3.4.3.1. Exit Width Based on Occupant Load

**1)** For the purpose of determining the aggregate width of *exits*, the *occupant load* of every room or *floor area* shall be determined in conformance with Subsection 3.1.17.

**2)** Except as permitted by Sentence 3.4.3.2.(4), the required *exit* width shall be cumulative if 2 or more *exits* converge.

### 3.4.3.2. Exit Width

**1)** Except as permitted by Sentence (3), the minimum aggregate required width of *exits* serving *floor areas* intended for *assembly occupancies, residential occupancies, business and personal services occupancies, mercantile occupancies, and industrial occupancies* shall be determined by multiplying the *occupant load* of the area served by

- a) 6.1 mm per person for ramps with a slope of not more than 1 in 8, doorways, corridors and passageways,
- b) 8 mm per person for a stair consisting of steps whose rise is not more than 180 mm and whose *run* is not less than 280 mm, or
- c) 9.2 mm per person for
  - i) ramps with a slope of more than 1 in 8, or
  - ii) stairs, other than stairs conforming to Clause (b).

**2)** The minimum aggregate width of *exits* serving *floor areas* intended for a *care, treatment or detention occupancy* shall be determined by multiplying the *occupant load* of the area served by 18.4 mm per person.

**3)** The minimum aggregate width of *means of egress* serving a Group A, Division 4 *occupancy* shall be determined by multiplying the *occupant load* of the area served by

- a) 1.8 mm per person for
  - i) aisles,
  - ii) stairs other than *exit* stairs, and
  - iii) ramps and passageways in vomitories and *exits*, and
- b) 2.4 mm per person for *exit* stairs.

**4)** Except as required by Sentences 3.4.3.2.(5) and (6), the required *exit* width need not be cumulative in an *exit* serving 2 or more *floor areas* located one above the other.

**5)** The required *exit* width for an *exit* stair in an assembly hall or *theatre* serving more than one balcony level shall conform to Sentence (6).



- 6)** The required *exit* width for *exit* stairs that serve *interconnected floor space* designed in accordance with Articles 3.2.8.3. to 3.2.8.8. shall be cumulative, unless
- a) the stairs provide not less than 0.3 m<sup>2</sup> of area of treads and landings for each occupant of the *interconnected floor space* (see Note A-3.4.3.2.(6)), or
  - b) *protected floor spaces* conforming to Article 3.2.8.5. are provided at each floor level and the *protected floor space* on a floor level has not less than 0.5 m<sup>2</sup> of space for each occupant of that floor level of the *interconnected floor space*.
- (See Note A-3.4.3.2.(6)(a).)

**7)** If more than one *exit* is required, every *exit* shall be considered as contributing not more than one half of the required *exit* width.

**8)** The minimum widths of *exits* shall conform to Tables 3.4.3.2.-A and 3.4.3.2.-B.

**Table 3.4.3.2.-A**  
**Minimum Widths of Exit Corridors, Passageways, Ramps, Stairs and Doorways**  
**in Group A, Group B, Division 1, and Groups C, D, E and F Occupancies**  
 Forming Part of Sentence 3.4.3.2.(8)

Occupancy Classification	Exit Corridors and Passageways, mm	Ramps, mm	Stairs, mm	Doorways, mm
Group A, Group B, Division 1, Group C, Group D, Group E, Group F	1 100	1 100	900 <sup>(1)</sup> 1 100 <sup>(2)</sup>	800

**Notes to Table 3.4.3.2.-A:**

- (1) Serving not more than 2 *storeys* above the lowest *exit level* or not more than 1 *storey* below the lowest *exit level*.
- (2) Serving more than 2 *storeys* above the lowest *exit level* or more than 1 *storey* below the lowest *exit level*.

**Table 3.4.3.2.-B**  
**Minimum Widths of Exit Corridors, Passageways, Ramps, Stairs and Doorways in Group B, Division 2 and Division 3 Occupancies**  
 Forming Part of Sentence 3.4.3.2.(8)

Occupancy Classification	Exit Corridors and Passageways, mm	Ramps, mm		Stairs, mm		Doorways, mm	
		Not serving patients' or residents' sleeping rooms <sup>(1)</sup>	Serving patients' or residents' sleeping rooms <sup>(1)</sup>	Not serving patients' or residents' sleeping rooms <sup>(1)</sup>	Serving patients' or residents' sleeping rooms <sup>(1)</sup>	Not serving patients' or residents' sleeping rooms <sup>(1)</sup>	Serving patients' or residents' sleeping rooms <sup>(1)</sup>
Group B, Division 2	1 100	1 100	1 650	900 <sup>(2)</sup> 1 100 <sup>(3)</sup>	1 650	850	1 050
Group B, Division 3							
with more than 10 residents	1 100	1 100	1 100	900 <sup>(2)</sup> 1 100 <sup>(3)</sup>	1 100 <sup>(2)</sup> 1 650 <sup>(3)</sup>	850	850
with not more than 10 residents	1 100	1 100	1 100	900 <sup>(2)</sup> 1 100 <sup>(3)</sup>	900 <sup>(2)</sup> 1 100 <sup>(3)</sup>	850	850

**Notes to Table 3.4.3.2.-B:**

- (1) Minimum widths of ramps, stairs and doorways do not apply within individual *suites of care occupancy*.
- (2) Serving not more than 2 *storeys* above the lowest *exit level* or not more than 1 *storey* below the lowest *exit level*.
- (3) Serving more than 2 *storeys* above the lowest *exit level* or more than 1 *storey* below the lowest *exit level*.

**3.4.3.3. Exit Width Reduction**

- 1)** Except as permitted by Sentences (2) and (4), no fixture, turnstile or construction shall project into or be fixed within the required width of an *exit*.
- 2)** Swinging doors in their swing shall not reduce the required width of *exit* stairs or landings to less than 750 mm or reduce the width of an *exit* passageway to less than the minimum required width.

**3)** Doors shall be installed so that, when open, they do not diminish nor obstruct the required width of the *exit*.

**4)** Handrails and construction below handrails, including handrail supports and stair stringers, shall not project more than 100 mm into the required width of a *means of egress*.

#### 3.4.3.4. Headroom Clearance

(See Note A-3.4.3.4.)

**1)** Except as permitted by Sentences (4) and (5), every *exit* shall have a clear height over the clear width of the *exit* of not less than 2 050 mm.

**2)** The clear height of stairways shall be measured vertically over the clear width of the stairway, from the straight line tangent to the tread and landing nosings to the lowest element above. (See Note A-9.8.7.4.)

**3)** The clear height of landings shall be measured within the clear width of the landing vertically to the lowest element above.

**4)** Except as permitted by Sentence (5), the headroom clearance for doorways shall be not less than 2 030 mm.

**5)** No door closer or other device shall be installed so as to reduce the headroom clearance of a doorway to less than 1 980 mm.

### 3.4.4. Fire Separation of Exits

#### 3.4.4.1. Fire-Resistance Rating of Exit Separations

**1)** Except as permitted by Sentences (2), 3.3.5.4.(3), 3.4.4.2.(2) and 3.4.4.3.(1), every *exit* shall be separated from the remainder of the *building* by a *fire separation* having a *fire-resistance rating* not less than that required by Subsection 3.2.2., but not less than 45 min, for

- a) the floor assembly above the *storey*, or
- b) the floor assembly below the *storey*, if there is no floor assembly above.

**2)** The *fire-resistance rating* of the *fire separation* referred to in Sentence (1) need not be more than 2 h.

**3)** If an *exit* stair in an assembly hall or *theatre* serves more than one balcony level, the *exit* stair shall be separated from the remainder of the *building* in conformance with Sentence (1).

#### 3.4.4.2. Exits through Lobbies

**1)** Except as permitted by Sentence (2), no *exit* from a *floor area* above or below the *first storey* shall lead through a lobby.

**2)** Not more than one *exit* from a *floor area* is permitted to lead through a lobby, provided

- a) the lobby floor is not more than 4.5 m above *grade*,
- b) the path of travel through the lobby to the outdoors is not more than 15 m,
- c) the adjacent rooms or premises having direct access to the lobby do not contain a *care, residential or industrial occupancy*,
- d) the lobby is not located within an *interconnected floor space* other than as described in Sentence 3.2.8.2.(6),
- e) the lobby conforms to the requirements for *exits*, except that
  - i) rooms other than *service rooms* and storage rooms are permitted to open onto the lobby,
  - ii) the *fire separation* between the lobby and a room used for the sole purpose of control and supervision of the *building* need not have a *fire-resistance rating*,

- iii) the *fire separation* between the lobby and adjacent *occupancies* that are permitted to open onto the lobby need not have a *fire-resistance rating* provided the lobby and adjacent *occupancies* are *sprinklered*, and
- iv) passenger elevators are permitted to open onto the lobby, provided the elevator doors are designed to remain closed except while loading and unloading passengers, and (see Note A-3.4.4.2.(2)(e))
- f) a *fire separation*, constructed in accordance with Sentence 3.4.4.1.(1), is maintained between the lobby and any *exit* permitted by this Sentence to lead through the lobby.

### 3.4.4.3. Exterior Passageway Exceptions

- 1) The requirements of Sentences 3.4.4.1.(1) and 3.2.3.13.(1) and (3) do not apply to an exterior *exit* passageway provided
  - a) not less than 50% of the exterior side is open to the outdoors, and
  - b) an *exit* stair is provided at each end of the passageway.

### 3.4.4.4. Integrity of Exits

- 1) A *fire separation* that separates an *exit* from the remainder of the *building* shall have no openings except for
  - a) standpipe and sprinkler piping,
  - b) electrical wires and cables, totally enclosed *noncombustible* raceways and *noncombustible* piping that serve only the *exit*,
  - c) openings required by the provisions of Subsection 3.2.6.,
  - d) *exit* doorways, and
  - e) wired glass and glass block permitted by Article 3.1.8.16.
- 2) *Exits* within scissors stairs and other contiguous *exit* stairways shall be separated from each other by a smoke-tight *fire separation* having a *fire-resistance rating* not less than that required for the floor assembly through which they pass.
- 3) *Fire separations* separating contiguous stairs described in Sentence (2) shall not be pierced by doorways, ductwork, piping or any other openings that affect the continuity of the separation.
- 4) A fuel-fired *appliance* shall not be installed in an *exit*.
- 5) An *exit* shall not be used as a *plenum* for a heating, ventilating or air-conditioning system.
- 6) An *exit* shall be designed for no purpose other than for exiting, except that an *exit* is permitted also to be designed to serve as an access to a *floor area*.
- 7) A *service room* shall not open directly into an *exit*.
- 8) Storage rooms, washrooms, toilet rooms, laundry rooms and similar ancillary rooms shall not open directly into an *exit*.
- 9) *Service spaces* referred to in Sentence 3.2.1.1.(8) shall not open directly into an *exit*.

## 3.4.5. Exit Signs

### 3.4.5.1. Exit Signs

- 1) Every *exit* door shall have an *exit* sign placed over or adjacent to it if the *exit* serves
  - a) a *building* more than 2 storeys in *building height*,
  - b) a *building* having an *occupant load* of more than 150, or
  - c) a room or *floor area* that has a fire escape as part of a required *means of egress*.
- 2) Every *exit* sign shall
  - a) be visible on approach to the *exit*,

- b) consist of a green and white or lightly tinted graphical symbol meeting the colour specifications referred to in ISO 3864-1, "Graphical symbols – Safety colours and safety signs – Part 1: Design principles for safety signs and safety markings," and
  - c) conform to ISO 7010, "Graphical symbols – Safety colours and safety signs – Registered safety signs," for the following symbols (see Note A-3.4.5.1.(2)(c)):
    - i) E001 emergency exit left,
    - ii) E002 emergency exit right,
    - iii) E005 90-degree directional arrow, and
    - iv) E006 45-degree directional arrow.
- 3)** Internally illuminated *exit* signs shall be continuously illuminated and
- a) where illumination of the sign is powered by an electrical circuit, be constructed in conformance with CSA C22.2 No. 141, "Emergency Lighting Equipment," or
  - b) where illumination of the sign is not powered by an electrical circuit, be constructed in conformance with CAN/ULC-S572, "Photoluminescent and Self-Luminous Exit Signs and Path Marking Systems."
- 4)** Externally illuminated *exit* signs shall be continuously illuminated and be constructed in conformance with CAN/ULC-S572, "Photoluminescent and Self-Luminous Exit Signs and Path Marking Systems." (See Note A-3.4.5.1.(4).)
- 5)** The circuitry serving lighting for externally and internally illuminated *exit* signs shall
- a) serve no equipment other than emergency equipment, and
  - b) be connected to an emergency power supply as described in Article 3.2.7.4.
- 6)** Where no *exit* is visible from a *public corridor*, from a corridor used by the public in a Group A or B *major occupancy*, or from principal routes serving an open *floor area* having an *occupant load* of more than 150, an *exit* sign conforming to Clauses (2)(b) and (c) with an arrow or pointer indicating the direction of egress shall be provided.
- 7)** Except for egress doorways described in Sentence 3.3.2.4.(4), an *exit* sign conforming to Sentences (2) to (5) shall be placed over or adjacent to every egress doorway from rooms with an *occupant load* of more than 60 in Group A, Division 1 *occupancies*, dance halls, licensed beverage establishments, and other similar *occupancies* that, when occupied, have lighting levels below that which would provide easy identification of the egress doorway.

### 3.4.5.2. Signs for Stairs and Ramps at Exit Level

- 1)** In a *building* more than 2 *storeys* in *building height*, any part of an *exit* ramp or stairway that continues up or down past the lowest *exit level* shall have a posted sign clearly indicating that it does not lead to an *exit*.

### 3.4.6. Types of Exit Facilities

(See Note A-3.4.6.)

#### 3.4.6.1. Slip Resistance of Ramps and Stairs

- 1)** The surfaces of ramps, and landings and treads
  - a) shall have a finish that is slip resistant, and
  - b) if accessible to the public, shall have either a colour contrast or a distinctive pattern to demarcate the leading edge of the tread and the leading edge of the landing, as well as the beginning and end of a ramp.
- 2)** Treads and landings of exterior *exit* stairs more than 10 m high shall be designed to be free of ice and snow accumulations.

#### 3.4.6.2. Minimum Number of Risers

- 1)** Except as permitted by Sentence 3.3.2.15.(1), every *flight* of interior stairs shall have not less than 3 risers.

**3.4.6.3. Maximum Vertical Rise of Stair Flights and Required Landings**

**1)** No *flight* of stairs shall have a vertical rise of more than 3.7 m between floors or landings, except that a *flight* of stairs serving as an *exit* in a Group B, Division 2 *occupancy* shall have a vertical rise not more than 2.4 m between floors or landings.

- 2)** Except as provided in Sentence (3), a landing shall be provided
- a) at the top and bottom of each *flight* of interior and exterior stairs,
  - b) at the top and bottom of every section of ramp,
  - c) where a doorway opens onto a stair or ramp,
  - d) where a ramp opens onto a stair, and
  - e) where a stair opens onto a ramp.

**3)** A landing may be omitted at the bottom of an exterior stair or ramp, provided there is no gate, door or fixed obstruction within the lesser of

- a) the width of the stair or ramp, or
- b) 1 100 mm.

**3.4.6.4. Dimensions of Landings**

(See Note A-3.4.6.4.)

**1)** Except as provided in Sentence (2), a landing shall be at least as wide and as long as the width of the stairway in which it occurs.

**2)** In a straight stairway and in a stairway that turns less than 90°, the length of the landing need not be more than the lesser of

- a) the required width of stair, or
- b) 1 100 mm.

**3)** The length of a landing shall be measured perpendicular to the nosing of adjacent steps, at a distance equal to half the length required in Sentence (2), from the narrow edge of the landing.

**4)** Where a doorway or stairway empties onto a ramp through a side wall, there shall be a level area extending across the full width of the ramp, and for a distance of 300 mm on either side of the wall opening, except one side if it abuts on an end wall.

**5)** Where a doorway or stairway empties onto a ramp through an end wall, there shall be a level area extending across the full width of the ramp and along its length for not less than 900 mm.

**3.4.6.5. Handrails**

**1)** One handrail shall be provided on stairs that are less than 1 100 mm in width.

- 2)** One handrail shall be provided on each side of
- a) stairs that are 1 100 mm or more in width,
  - b) curved *flights* of any width, and
  - c) ramps.

**3)** In addition to Sentence (2), intermediate handrails shall be provided so that

- a) a handrail is reachable within 750 mm of all portions of the required *exit* width,

- b) at least one portion of the stair or ramp between two handrails is the minimum width required for stairways or ramps (see Sentences 3.4.3.2.(8) and 3.4.3.3.(4)), and

- c) all other portions of the stair or ramp between two handrails have a clear width of 510 mm or more.

**4)** Where a stair or ramp is wider than its required *exit* width, handrails shall be located along the most direct path of travel. (See Note A-3.4.6.5.(4).)

- 5)** Handrails shall be continuously graspable along their entire length, be free of any sharp or abrasive elements, and have
- a circular cross-section with an outside diameter not less than 30 mm and not more than 43 mm, or
  - a non-circular cross-section with a perimeter not less than 100 mm and not more than 125 mm and whose largest cross-sectional dimension is not more than 45 mm.
- 6)** The height of handrails on stairs, on aisles with steps and on ramps shall be measured vertically from the top of the handrail to
- a straight line drawn tangent to the tread nosings of the stair or aisle step served by the handrail (see Note A-9.8.7.4.), or
  - the surface of the ramp, floor or landing served by the handrail.
- 7)** Except as provided in Sentence (8) and Clause 3.8.3.5.(1)(e), the height of handrails on stairs, on aisles with steps and on ramps shall be
- not less than 865 mm, and
  - not more than 1 070 mm.
- 8)** Handrails installed in addition to required handrails need not comply with Sentence (7).
- 9)** Required handrails shall be continuously graspable throughout the length of
- a ramp, and
  - a *flight* of stairs, from the bottom riser to the top riser.
- (See Note A-9.8.7.2.)
- 10)** Except where interrupted by doorways, at least one handrail shall be continuous throughout the length of a stairway or ramp, including at landings. (See Note A-3.4.6.5.(10).)
- 11)** Handrails shall be terminated in a manner that will not obstruct pedestrian travel or create a hazard. (See Note A-3.4.6.5.(10).)
- 12)** At least one handrail at the side of a stairway or ramp shall extend horizontally not less than 300 mm beyond the top and bottom of the stairway or ramp. (See Note A-3.4.6.5.(10).)
- 13)** The clearance between a handrail and any surface behind it shall be not less than
- 50 mm, or
  - 60 mm if the surface behind the handrail is rough or abrasive.
- 14)** Handrails and their supports shall be designed and constructed to withstand the loading values specified in Sentence 4.1.5.14.(7).
- 15)** A ramp shall have handrails on both sides.

**3.4.6.6.****Guards**

- 1)** Every *exit* shall have a wall or a well-secured *guard* on each side, where
- there is a difference in elevation of more than 600 mm between the walking surface and the adjacent surface, or
  - the adjacent surface within 1.2 m of the walking surface has a slope of more than 1 in 2.
- (See Note A-9.8.8.1.)
- 2)** Except as required by Sentence (4), the height of *guards* for *exit* stairs and *exit* ramps as well as their landings shall be not less than 1 070 mm .
- 3)** The height of *guards* shall be measured vertically to the top of the *guard* from
- a line drawn through the outside edges of the stair nosings, or
  - the surface of the ramp or landing.
- 4)** The height of *guards* for exterior stairs and landings more than 10 m above adjacent ground level shall be not less than 1 500 mm measured vertically to the top of the *guard* from the surface of the landing or from a line drawn through the outside edges of the stair nosings.

**5)** Except as provided in Sentence 3.3.1.18.(3) and Articles 3.3.4.7. and 3.3.5.10., *guards in exits* shall not have any openings that permit the passage of a spherical object whose diameter is more than 100 mm.

**6)** In a stairway, a window for which the distance measured vertically between the bottom of the window and a line drawn through the outside edges of the stair nosings is less than 900 mm, or a window that extends to less than 1 070 mm above the landing, shall

- a) be protected by a *guard* that is
  - i) located approximately 900 mm above a line drawn through the outside edges of the stair nosings, or
  - ii) not less than 1 070 mm high measured to the top of the *guard* from the surface of the landing, or
- b) be fixed in position and designed to resist the lateral design loads specified for *guards* and walls in Articles 4.1.5.14. and 4.1.5.16.

**7)** Except for *guards* conforming to Article 3.3.5.10., *guards* that protect a level located more than one *storey* or 4.2 m above the adjacent level shall be designed so that no member, attachment or opening located between 140 mm and 900 mm above the level being protected by the *guard* facilitates climbing. (See Note A-9.8.8.6.(1).)

### 3.4.6.7. Ramp Slope

(See also Article 3.8.3.5.)

**1)** Except as required for aisles by Article 3.3.2.5., the maximum slope of a ramp shall be

- a) 1 in 10 in any *assembly, care, treatment, detention* or *residential occupancy*,
- b) 1 in 6 in an *industrial occupancy*,
- c) 1 in 8 in all other *occupancies*, and
- d) 1 in 10 for an exterior ramp.

### 3.4.6.8. Treads and Risers

(See Note A-9.8.4.)

**1)** Except as permitted for *dwelling units* and by Sentence 3.4.7.5.(1) for fire escapes, steps for stairs shall have a *run* of not less than 280 mm between successive steps.

**2)** Steps for stairs referred to in Sentence (1) shall have a rise between successive treads not less than 125 mm and not more than 180 mm.

**3)** Except as provided in Article 3.3.4.7. and except for fire escape stairs, stairs that are principally used for maintenance and service, and stairs that serve *industrial occupancies* other than *storage garages*, steps for stairs shall have no open risers.

**4)** Except in fire escape stairs and where an exterior stair adjoins a *walkway* as permitted in Sentence 3.4.6.3.(3), risers, measured as the vertical nosing-to-nosing distance, shall be of uniform height in any one *flight*, with a maximum tolerance of

- a) 5 mm between adjacent treads or landings, and
- b) 10 mm between the tallest and shortest risers in a *flight*.

**5)** Except in fire escape stairs, treads shall have a uniform *run* with a maximum tolerance of

- a) 5 mm between adjacent treads, and
- b) 10 mm between the deepest and shallowest treads in a *flight*.

**6)** Treads and risers shall not differ significantly in *run* and rise in successive *flights* in any stair system.

**7)** The slope of treads or landings shall not exceed 1 in 50.

**8)** Except as permitted by Sentence (10), the top of the nosing of stair treads shall have a rounded or beveled edge extending not less than 6 mm and not more than 13 mm measured horizontally from the front of the nosing.

**9)** The front edge of stair treads in *exits* and public *access to exits* shall be at right angles to the direction of *exit* travel.

**10)** If resilient material is used to cover the nosing of a stair tread, the minimum rounded or beveled edge required by Sentence (8) is permitted to be reduced to 3 mm.

#### 3.4.6.9. Curved Flights in Exits

- 1)** *Exit stair flights* shall consist solely of
  - a) straight *flights*, or
  - b) curved *flights* complying with Sentence (2).
- 2)** A curved *flight* used as an *exit* shall have
  - a) a handrail on each side,
  - b) a minimum *run* of 240 mm,
  - c) a *run* that conforms to Article 3.4.6.8. when measured at a point 300 mm from the centre line of the handrail at the narrow end of the tread, and
  - d) an inside radius that is not less than twice the stair width.
- 3)** *Tapered treads* shall have a consistent angle and uniform *run* and rise dimensions in accordance with the construction tolerances stipulated in Article 3.4.6.8. when measured at a point 300 mm from the centre line of the handrail at the narrow end of the tread.
- 4)** All *tapered treads* within a *flight* shall turn in the same direction.

#### 3.4.6.10. Horizontal Exits

- 1)** The *floor area* on each side of a *horizontal exit* shall be sufficient to accommodate the occupants of both *floor areas*, allowing not less than 0.5 m<sup>2</sup> of clear floor space per person, except that 1.5 m<sup>2</sup> shall be provided for each person in a wheelchair and 2.5 m<sup>2</sup> for each bedridden patient.
- 2)** If vestibules, enclosed balconies or bridges are used as parts of a *horizontal exit*, their clear width shall be not less than that of the *exit* doorways opening into them, except that handrails are not permitted to project into this clear width more than 100 mm.
- 3)** In a *horizontal exit* where there is a difference in level between the connected *floor areas*, slopes not more than those specified for ramps in Article 3.4.6.7. are permitted to be used.
- 4)** No stairs or steps shall be used in a *horizontal exit*.
- 5)** If 2 doors are provided in a *horizontal exit* that comprises a part of the required number of *exits* from the *floor areas* on both sides of the *exit*
  - a) the doors shall be mounted adjacent to each other with the door on the right side in the direction of travel through the *horizontal exit* swinging in the direction of travel through the *horizontal exit*, and
  - b) signs shall be provided on each side of the *horizontal exit* to indicate the door that swings in the direction of travel from that side.
 (See Note A-3.4.6.10.(5).)
- 6)** If a *horizontal exit* utilizes bridges between *buildings* or outside balconies, the bridges or balconies shall conform to Article 3.2.3.19.

#### 3.4.6.11. Doors

- 1)** The distance between a stair riser and the leading edge of a door during its swing shall be not less than 300 mm.
- 2)** Except as provided in Sentence (3) and where doorways are used to confine the spillage of *flammable liquids* within a *service room* or within a room in an *industrial occupancy*, a threshold for a doorway in an *exit* shall be not more than 13 mm higher than the surrounding finished floor surface.
- 3)** Except for doors providing access to ground level as required by Clause 3.3.1.7.(1)(d) and (e), an *exit* door is permitted to open onto not more than one step which shall be not more than 150 mm high where there is a risk of blockage by ice or snow.
- 4)** *Exit* doors shall be clearly identifiable. (See Note A-3.4.6.11.(4).)



5) No door leaf in an *exit* doorway with more than one leaf shall be less than 610 mm wide.

6) Where an *exit* door leading directly to the outside is subject to being obstructed by parked vehicles or storage because of its location, a visible sign or a physical barrier prohibiting such obstructions shall be installed on the exterior side of the door.

#### 3.4.6.12. Direction of Door Swing

1) Except for doors serving a single *dwelling unit* and except as permitted by Sentence (2) and Article 3.4.6.14., every *exit* door shall

- a) open in the direction of *exit* travel, and
- b) swing on its vertical axis.

2) *Exit* doors need not conform to Sentence (1), where

- a) they serve *storage garages* serving not more than one *dwelling unit*,
- b) they serve accessory *buildings* serving not more than one *dwelling unit*,
- c) they
  - i) serve *storage suites* not more than 28 m<sup>2</sup> in area that are on the *first storey* in warehousing *buildings*, and
  - ii) open directly outdoors at ground level, or
- d) they serve individual self-service storage units referred to in Section 3.9.

#### 3.4.6.13. Self-closing Devices

1) An *exit* door that is normally required to be kept closed

- a) shall be provided with a self-closing mechanism, and
- b) shall never be secured in an open position except as permitted by Sentence 3.1.8.14.(1).

#### 3.4.6.14. Sliding Doors

1) Except as permitted by Sentences (2) and 3.4.6.12.(2), an *exit* door leading directly to outdoors at ground level is permitted to be a sliding door provided it conforms to Sentence 3.3.1.12.(1).

2) An *exit* door serving a Group B, Division 1 *occupancy*, or an *impeded egress zone* in other *occupancies*, is permitted to be a sliding door that does not conform to Sentence 3.3.1.12.(1) provided it is designed to be released in conformance with Article 3.3.1.13.

#### 3.4.6.15. Revolving Doors

1) Except as permitted by Sentence (3), a revolving door, if used, shall

- a) be collapsible,
- b) have hinged doors providing equivalent exiting capacity located adjacent to it,
- c) be used as an *exit* from the ground floor level only,
- d) not be used at the foot of any stairway, and
- e) have all glass in door leaves and enclosure panels conforming to
  - i) CAN/CGSB-12.1-M, "Tempered or Laminated Safety Glass," or
  - ii) CAN/CGSB-12.11-M, "Wired Safety Glass."

2) Except as permitted by Sentence (3), a revolving door shall not be considered to have an exiting capacity for more than 45 persons.

3) An electrically powered revolving door is not required to conform to Sentences (1) and (2) provided

- a) the door leaves will collapse and stop automatic rotation of the door system and not obstruct the doorway if a force not more than that specified in Sentence 3.4.6.16.(2) is applied at the centre of a door leaf,
- b) the door leaves are capable of being opened from inside the *building* without requiring keys, special devices, or specialized knowledge of the door opening mechanism,

- c) the allowable exiting capacity is based on the clear width of passage through the door enclosure when the doors are fully collapsed,
- d) a permanent sign, whose centre line is between 1 000 mm and 1 500 mm above the floor, is placed on each face of each door leaf indicating the method for collapsing the door leaf in an emergency, and
- e) glass used for door leaves and enclosure panels is safety glass conforming to
  - i) CAN/CGSB-12.1-M, "Tempered or Laminated Safety Glass," or
  - ii) CAN/CGSB-12.11-M, "Wired Safety Glass."

### 3.4.6.16. Door Release Hardware

**1)** Except for devices on doors serving a *contained use area* or an *impeded egress zone* designed to be remotely released in conformance with Article 3.3.1.13., and except as permitted by Sentences (4) and (5) and Article 3.4.6.17., locking, latching and other fastening devices on a principal entrance door to a *building* as well as those on every *exit* door shall include release hardware complying with Clause 3.8.3.8.(1)(b) to permit the door to be readily opened from the inside with not more than one releasing operation and without requiring keys, special devices or specialized knowledge of the door-opening mechanism. (See Note A-3.4.6.16.(1).)

**2)** If a door is equipped with a latching mechanism, a device that will release the latch and allow the door to swing wide open when a force of not more than 90 N is applied to the device in the direction of travel to the *exit* shall be installed on

- a) every *exit* door from a *floor area* containing an *assembly occupancy* having an *occupant load* more than 100,
- b) every door leading to an *exit* lobby from an *exit* stair shaft, and every exterior door leading from an *exit* stair shaft in a *building* having an *occupant load* more than 100, and
- c) every *exit* door from a *floor area* containing a *high-hazard industrial occupancy*.

**3)** Except as required by Sentence 3.8.3.6.(8), every *exit* door shall be designed and installed so that, when the latch is released, the door will open under a force of not more than 90 N, applied at the knob or other latch releasing device.

**4)** Electromagnetic locks that do not incorporate latches, pins or other similar devices to keep the door in the closed position are permitted to be installed on doors, other than those leading directly from a *high-hazard industrial occupancy*, provided

- a) the *building* is equipped with a fire alarm system,
- b) the locking device releases upon actuation of the *alarm signal* from the *building's* fire alarm system,
- c) the locking device releases immediately upon loss of power controlling the electromagnetic locking mechanism and its associated auxiliary controls,
- d) except for locking devices installed in conformance with Sentence (5), the locking device releases immediately upon actuation of a manually operated switch readily accessible only to authorized personnel,
- e) except as provided in Clause (k), a force of not more than 90 N applied to the door opening hardware initiates an irreversible process that will release the locking device within 15 s and not re-lock until the door has been opened,
- f) upon release, the locking device must be reset manually by the actuation of the switch referred to in Clause (d),
- g) a legible sign is permanently mounted on the door to indicate that the locking device will release within 15 s of applying pressure to the door-opening hardware,
- h) the total time delay for all electromagnetic locks in any path of egress to release is not more than 15 s,
- i) where a bypass switch is installed to allow testing of the fire alarm system, actuation of the switch
  - i) can prevent the release of the locking device by the fire alarm system, as stated in Clause (b), during the test, and
  - ii) causes an audible and visual signal to be indicated at the fire alarm annunciator panel required by Article 3.2.4.9. and at the monitoring station specified in Sentence 3.2.4.8.(4),

- j) emergency lighting is provided at each door, and
- k) where they are installed on doors providing emergency crossover access to *floor areas* from *exit* stairs in accordance with Article 3.4.6.18.,
  - i) the locking device releases immediately upon the operation of a manual station for the fire alarm system located on the wall on the *exit* stair side not more than 600 mm from the door, and
  - ii) a legible sign with the words “re-entry door unlocked by fire alarm” written in letters at least 25 mm high with a stroke of at least 5 mm is permanently mounted on the door on the *exit* stair side.

(See Note A-3.4.6.16.(4).)

**5)** Electromagnetic locks that do not incorporate latches, pins or other similar devices to keep the door in the closed position are permitted to be installed on doors in Group B, Division 2 and Division 3 *occupancies*, provided

- a) the *building* is
  - i) equipped with a fire alarm system, and
  - ii) *sprinklered*,
- b) the electromagnetic lock releases upon
  - i) actuation of the *alarm signal* from the *building’s* fire alarm system,
  - ii) loss of its power supply and of power to its auxiliary controls,
  - iii) actuation of a manually operated switch that is readily accessible at a constantly attended location within the locked space, and
  - iv) actuation of the manual station installed within 0.5 m of each door and equipped with an auxiliary contact, which directly releases the electromagnetic lock,
- c) upon release, the electromagnetic lock requires manual resetting by actuation of the switch referred to in Subclause (b)(iii),
- d) a legible sign with the words “EMERGENCY EXIT UNLOCKED BY FIRE ALARM” written in letters at least 25 mm high with a stroke at least 5 mm wide is permanently mounted on the door,
- e) the operation of any by-pass switch, where provided for testing of the fire alarm system, sets off an audible signal and a visual signal at the fire alarm annunciator panel and at the monitoring station referred to in Sentence 3.2.4.7.(4), and
- f) emergency lighting is provided at the doors.

(See Note A-3.4.6.16.(5).)

**6)** Door hardware for the operation of the doors referred to in this Section shall be installed at a height not more than 1 200 mm above the finished floor.

**3.4.6.17. Security for Banks and Mercantile Floor Areas**

**1)** If a *building* is *sprinklered* throughout, the requirements of Sentence 3.4.6.16.(1) are permitted to be waived for *exit* and egress doors complying with Sentences (2) to (9) that serve a *floor area* or part of a *floor area* used exclusively for

- a) a bank, or
- b) the sale of retail merchandise.

(See Note A-3.4.6.17.(1).)

**2)** *Exit* and egress doors referred to in Sentence (1) shall be designed to prevent locking at any time that the part of the *floor area* that they serve is open to the public.

**3)** A sign with the words “This door shall not be locked at any time that the public is present” in letters not less than 50 mm high shall be permanently affixed to both sides of doors referred to in Sentence (1).

**4)** *Exit* and egress facilities complying with Sentences (5) to (9) shall be incorporated for egress by persons other than the public from a *floor area* or a part of a

*floor area* referred to in Sentence (1) during times when the public is neither present nor being admitted to the area that they serve.

**5)** In *exit* and egress facilities referred to in Sentence (4), at least one door at each *exit* and egress location shall

- a) be operable in conformance with Sentence 3.4.6.16.(1), or
- b) be equipped with locks conforming to Sentence 3.4.6.16.(4) that release immediately
  - i) if an *alert signal* or *alarm signal* is initiated in the fire alarm system, or
  - ii) the sprinkler system is actuated.

**6)** A door referred to in Sentence (5) shall be permanently and distinctly marked to indicate that it is an emergency *exit*.

**7)** *Exit* and egress facilities required for evacuation of persons other than the public from a *floor area* or a part of a *floor area* referred to in Sentence (1) shall have an aggregate width based on the maximum number of persons other than the public and determined in accordance with Articles 3.4.3.1. to 3.4.3.3.

**8)** Travel distance to an *exit* referred to in Sentence (7) shall not exceed the travel distance determined in accordance with Subsection 3.4.2.

**9)** *Exit* and egress doors serving a *floor area* or part of a *floor area* referred to in Sentence (1) are permitted to be equipped with locks that require keys, special devices or specialized knowledge of the door opening mechanism provided

- a) the doors do not lead into *exit* stairs,
- b) the doors do not lead from *exit* stairs to the exterior of the *building*,
- c) the doors do not serve any other *occupancy*,
- d) the area served contains at least one telephone
  - i) that is accessible and in operation at all times,
  - ii) that is not coin or card operated, and
  - iii) marked to indicate that it is for emergency use,
- e) the area served is illuminated by normal power or by emergency power when the doors are locked,
- f) there are provisions that enable an announcement to be made throughout the area served before the locks are fastened, and
- g) the locks are designed for use during times that the *building* is not occupied.

### 3.4.6.18. Emergency Crossover Access to Floor Areas

**1)** Except as permitted in Sentence (2), doors providing access to *floor areas* from *exit* stairs shall not have locking devices to prevent entry into any *floor area* from which the travel distance up or down to an unlocked door is more than 2 *storeys*.

**2)** Doors referred to in Sentence (1) are permitted to be equipped with electromagnetic locks, provided they comply with Sentences 3.4.6.16.(4) and (5).

**3)** Doors referred to in Sentence (1) shall be identified by a sign on the stairway side to indicate that they are openable from that side.

- 4)** Locked doors intended to prevent entry into a *floor area* from an *exit* stair shall
- a) be identified by a sign on the stairway side to indicate the location of the nearest unlocked door in each direction of travel, and
  - b) be openable with a master key that fits all locking devices and is kept in a designated location accessible to firefighters or be provided with a wired glass panel not less than 0.0645 m<sup>2</sup> in area and located not more than 300 mm from the door opening hardware.

**5)** Where access to *floor areas* through unlocked doors is required by Sentence (1), it shall be possible for a person entering the *floor area* to have access through unlocked doors within the *floor area* to at least one other *exit*.

**3.4.6.19. Floor Numbering**

- 1) Arabic numerals indicating the assigned floor number shall
  - a) be mounted permanently on the stair side of the wall at the latch side of doors to *exit* stair shafts,
  - b) be not less than 60 mm high, raised approximately 0.7 mm above the surface,
  - c) be located 1 500 mm from the finished floor and not more than 300 mm from the door, and
  - d) be contrasting in colour with the surface to which they are applied (see Note A-3.4.6.19.(1)(d)).

**3.4.7. Fire Escapes****3.4.7.1. Scope**

- 1) Except as permitted by Sentence (2), fire escapes shall not be erected on a *building*.
- 2) If it is impracticable to provide one or more of the *exit* facilities listed in Article 3.4.1.4., fire escapes conforming to Articles 3.4.7.2. to 3.4.7.7. are permitted to serve *floor areas* in an existing *building* provided the *floor areas* served are not more than
  - a) 2 storeys above ground level in *care, treatment* or *detention occupancies*, and
  - b) 5 storeys above ground level in other *occupancies*.

**3.4.7.2. Fire Escape Construction**

- 1) Fire escapes shall be of metal or concrete, of the stair type extending to ground level, constructed throughout in a strong substantial manner and securely fixed to the *building*, except that wooden fire escapes are permitted to be used on *buildings* of *combustible construction* if all posts and brackets are not less than 89 mm in their least dimension and all other *woodwork* is not less than 38 mm in its least dimension.

**3.4.7.3. Access to Fire Escapes**

- 1) Access to fire escapes shall be from corridors through doors at floor level, except that access from a *dwelling unit* is permitted to be through a casement window having an unobstructed opening not less than 1 100 mm high by 550 mm wide with a sill height of not more than 900 mm above the inside floor.
- 2) The clear area of a fire escape balcony onto which a door opens, shall be not less than 1 m<sup>2</sup>.

**3.4.7.4. Protection of Fire Escapes**

- 1) If a fire escape serves any *storey* above the second, openings located in a zone described in Sentence (2), including access doorways in the exterior walls of the *building* to which the fire escape is attached, shall be protected by *closures* conforming to Subsection 3.1.8.
- 2) The zone referred to in Sentence (1) extends from any balcony, platform or stairway of a fire escape to a distance
  - a) 3 m horizontally,
  - b) 10 m below, or
  - c) 1.8 m above.

**3.4.7.5. Stairs**

- 1) Stairs shall be inclined at an angle of not more than 45° with the horizontal, and their steps shall have risers not more than 210 mm high and treads not less than 220 mm wide exclusive of nosing.
- 2) Stairway headroom shall be not less than 1 950 mm plus the height of one riser measured vertically above the nosing of any tread or platform.

**3)** The width of a fire escape shall conform to Articles 3.4.3.1. to 3.4.3.3., except that the width is permitted to be reduced to 550 mm provided the fire escape serves

- a) not more than 3 *storeys*, and
- b) not more than 15 persons.

**4)** If a *flight* of stairs leading to the ground at the foot of a fire escape is not fixed in position, it shall be held in the raised position without a latch or locking device, and shall be fitted with a counterbalancing device that will permit it to be easily and quickly brought into position for use.

#### 3.4.7.6. Guards and Railings

**1)** The open sides of every platform, balcony and stairway forming part of a fire escape shall be protected by *guards* not less than 920 mm high measured vertically above the nosing of any tread or platform.

**2)** The top rail of a *guard* is permitted to serve as a handrail if it is free from obstructions which could break a handhold.

**3)** A wall handrail shall be installed if the fire escape is more than 550 mm wide.

**4)** Unless it can be shown that the size of openings that exceed this limit does not present a hazard, there shall be no opening that permits the passage of a sphere whose diameter is more than 100 mm through a *guard* for a fire escape.

**5)** Unless it can be shown that the location and size of an opening do not present a hazard, a *guard* for a fire escape shall be designed so that no member, attachment or opening located between 140 mm and 900 mm above a platform or the nosing of any tread will facilitate climbing.

#### 3.4.7.7. Landings

**1)** Platforms for a fire escape shall be provided in conformance with the requirements for stair landings in Articles 3.4.6.3. and 3.4.6.4.

## Section 3.5. Vertical Transportation

### 3.5.1. General

#### 3.5.1.1. Scope

**1)** This Section applies to vertical transportation facilities installed in a *building*, including elevators, escalators and dumbwaiters.

**2)** Elevators in a *building* within the scope of Subsection 3.2.6. shall conform to Articles 3.2.6.4., 3.2.6.5. and 3.2.6.6.

### 3.5.2. Standards

#### 3.5.2.1. Elevators, Escalators and Dumbwaiters

**1)** The design, construction, installation and *alteration* of every elevator, escalator and dumbwaiter shall conform to

- a) provincial or territorial regulations or municipal bylaws, or
- b) ASME A17.1/CSA B44, "Safety Code for Elevators and Escalators," in the absence of the regulations or bylaws referred to in Clause (a).

(See Note A-3.5.2.1.(1).)

**2)** Before being placed in service, every elevator, escalator or dumbwaiter installation, including safety and control devices, shall be inspected and tested in accordance with

- a) provincial or territorial regulations or municipal bylaws, or
- b) ASME A17.1/CSA B44, "Safety Code for Elevators and Escalators," in the absence of the regulations or bylaws referred to in Clause (a). (See Note A-3.5.2.1.(1).)

3) Passenger elevators shall conform to Appendix E of ASME A17.1/CSA B44, "Safety Code for Elevators and Escalators."

**3.5.3. Fire Separations**

**3.5.3.1. Fire Separations for Elevator Hoistways**

1) Except as permitted by Sentence (2), a *vertical service space* used as an elevator hoistway shall be separated from all other portions of each adjacent *storey* by a *fire separation* having a *fire-resistance rating* conforming to Table 3.5.3.1. for the *fire-resistance rating* required by Subsection 3.2.2. for

- a) the floor assembly above the *storey*, or
- b) the floor assembly below the *storey*, if there is no floor assembly above.

**Table 3.5.3.1.**  
**Fire Separation for Vertical Transportation Space**  
 Forming Part of Articles 3.5.3.1. and 3.5.3.2.

<i>Fire-Resistance Rating of Fire Separation Required for Floor Assembly</i>	<i>Minimum Fire-Resistance Rating of Vertical Service Space for Elevator Hoistway</i>	<i>Minimum Fire-Resistance Rating of Vertical Service Space for Dumbwaiters</i>
less than 45 min	45 min	—
45 min	45 min	45 min
1 h	1 h	45 min
1.5 h	1.5 h	1 h
2 h or more	2 h	1 h

2) Passenger elevators, other than those provided for firefighters in accordance with Article 3.2.6.5., are permitted to be located within *interconnected floor space* without being enclosed in a hoistway separated from the remainder of the *building*, provided the elevator machinery is located in a room separated from the remainder of the *building* by a *fire separation* having a *fire-resistance rating* not less than that required for hoistways by Sentence (1).

**3.5.3.2. Vertical Service Spaces for Dumbwaiters**

1) A *vertical service space* containing a dumbwaiter shall be separated from all other portions of each adjacent *storey* by a *fire separation* having a *fire-resistance rating* conforming to Table 3.5.3.1. for the *fire-resistance rating* required by Subsection 3.2.2. for

- a) the floor assembly above the *storey* or
- b) the floor assembly below the *storey*, if there is no floor assembly above.

**3.5.3.3. Fire Separations for Elevator Machine Rooms**

1) Except as permitted by Sentence (2), a room containing elevator machinery shall be separated from all other parts of the *building* by a *fire separation* having a *fire-resistance rating* not less than that required for the *vertical service space* containing the elevator hoistway.

2) A room containing elevator machinery need not be separated from the elevator hoistway that it serves provided the room and the hoistway are separated from all other parts of the *building* by a *fire separation* having a *fire-resistance rating* not less than that required for the *vertical service space* containing the elevator hoistway.

**3.5.4. Dimensions and Signs**

**3.5.4.1. Elevator Car Dimensions**

1) If one or more elevators are provided in a *building*, all *storeys* shall be served by at least one elevator which has inside dimensions that will accommodate and provide

adequate access for a patient stretcher 2 010 mm long and 610 mm wide in the prone position. (See Note A-3.5.4.1.(1).)

2) An elevator satisfying the requirements of Sentence (1) shall be clearly identified on the main entrance level of the *building*.

### 3.5.4.2. Floor Numbering

1) Arabic numerals indicating the assigned floor number shall be mounted permanently on both jambs of passenger elevator hoistway entrances in conformance with Appendix E of ASME A17.1/CSA B44, "Safety Code for Elevators and Escalators."

## Section 3.6. Service Facilities

### 3.6.1. General

#### 3.6.1.1. Scope

1) The provisions of this Section apply to *horizontal service spaces, vertical service spaces, attic or roof spaces, ducts, crawl spaces, shaft spaces, service rooms, and mechanical penthouses, and facilities contained therein.*

#### 3.6.1.2. Electrical Wiring and Equipment

1) The installation of electrical wiring and electrical equipment shall conform to the requirements of

- a) provincial or territorial regulations or municipal bylaws, or
- b) CSA C22.1, "Canadian Electrical Code, Part I," in the absence of the regulations or bylaws referred to in Clause (a).

#### 3.6.1.3. Lightning Protection Systems

1) A lightning protection system, when provided, shall conform to the requirements of the appropriate provincial or territorial legislation or, in the absence of such legislation, to CAN/CSA-B72-M, "Installation Code for Lightning Protection Systems."

#### 3.6.1.4. Storage Use Prohibition

1) *Service spaces* shall not be designed to facilitate subsequent use as storage space.

#### 3.6.1.5. Appliances Installed outside a Building

1) A fuel-fired *appliance* installed on the roof of a *building* or in another location outside the *building* shall be installed not less than

- a) 1.2 m from a property line, measured horizontally, and
- b) 3 m from an adjacent wall of the same *building* if that wall contains any opening within 3 *storeys* above and 5 m horizontally from the *appliance*, unless every opening within these limits is protected by
  - i) a *closure* having a *fire-protection rating* not less than 45 min determined in accordance with Article 3.1.8.4., or
  - ii) a wired glass assembly permitted for use in a vertical *fire separation* and described in D-2.3.15. in Appendix D.

### 3.6.2. Service Rooms

#### 3.6.2.1. Fire Separations around Service Rooms

1) Except as permitted by Sentences (2), (8), (9) and (10), fuel-fired *appliances* shall be installed in *service rooms* separated from the remainder of the *building* by *fire separations* having a *fire-resistance rating* not less than 1 h.



**2)** Except as required by Sentence (3), a fuel-fired *appliance* that serves only one room or *suite* is not required to be installed in a *service room* separated from the remainder of the *building*.

**3)** A solid-fuel-burning *appliance* shall not be located in a *repair garage*, a *storage garage*, or any other location where it could be exposed to flammable vapours or gases, unless

- a) it is enclosed in a *service room* that is separated from the remainder of the *building* by a *fire separation* having a *fire-resistance rating* not less than 1 h,
- b) it is supplied with combustion air directly from outside the *building*, and
- c) the heat that it generates is supplied indirectly to the space served by means of ducts or piping.

**4)** A *service room* containing an incinerator shall be separated from the remainder of the *building* by a *fire separation* having a *fire-resistance rating* not less than 2 h.

**5)** Equipment that uses a liquid having a *flash point* below 93.3°C shall be installed in a *service room* separated from the remainder of the *building* by a *fire separation* having a *fire-resistance rating* not less than 1 h.

**6)** Electrical equipment that is required to be located in a *service room* according to CSA C22.1, "Canadian Electrical Code, Part I," shall be installed in a *service room* separated from the remainder of the *building* by a *fire separation* having a *fire-resistance rating* not less than 1 h.

**7)** Except as permitted by Sentence (8), in a *storey* that is not *sprinklered* throughout, a *service room* that contains service equipment other than that addressed by Sentences (1) to (6) shall be separated from the remainder of the *building* by a *fire separation* having a *fire-resistance rating* not less than 1 h.

**8)** Where a *service room* contains a limited quantity of service equipment, and the service equipment neither constitutes a fire hazard nor is essential to the operation of fire safety systems in the *building*, the requirements for a *fire separation* shall not apply.

**9)** A *fire separation* is not required between a fireplace and the space it serves.

**10)** A *fire separation* is not required between a roof-top *appliance* and the *building* it serves.

### 3.6.2.2. Service Rooms under Exits

**1)** A *service room* containing service equipment subject to possible explosion, such as *boilers* operating in excess of 100 kPa (gauge) and some types of refrigerating machinery and transformers, shall not be located directly under a required *exit*.

### 3.6.2.3. Service Equipment

**1)** A *service room* containing space heating, space cooling and service water heating *appliances* is permitted to contain other service equipment such as electrical service equipment.

### 3.6.2.4. Incinerator Rooms

**1)** A *service room* containing an incinerator shall not contain other fuel-fired *appliances*.

### 3.6.2.5. Combustible Refuse Storage

**1)** Except as required by Sentence 3.6.3.3.(9), a room for the storage of *combustible* refuse shall be

- a) separated from the remainder of the *building* by a *fire separation* with a *fire-resistance rating* not less than 1 h, and
- b) *sprinklered*.

(See Note A-3.6.2.5.(1).)

**3.6.2.6. Door Swing for Service Rooms**

**1)** A swing-type door from a *service room* containing a *boiler* or incinerator shall swing outward from the room, except that the door shall swing inward if the door opens onto a corridor or any room used for an *assembly occupancy*. (See also Sentence 3.4.4.4.(7).)

**3.6.2.7. Electrical Equipment Vaults**

**1)** An electrical equipment vault shall conform to Sentences (2) to (8) if it is required by

- a) provincial or territorial regulations or municipal bylaws, or
- b) CSA C22.1, "Canadian Electrical Code, Part I," in the absence of the regulations or bylaws referred to in Clause (a).

**2)** An electrical equipment vault referred to in Sentence (1) shall be separated from the remainder of the *building* by a *fire separation of solid masonry* or concrete construction having a *fire-resistance rating* not less than

- a) 3 h if the vault is not protected by an automatic fire extinguishing system, or
- b) 2 h if the vault is protected by an automatic fire extinguishing system.

**3)** If a *building* is *sprinklered* throughout, an electrical equipment vault referred to in Sentence (1) need not be *sprinklered* provided

- a) the vault is designed for no purpose other than to contain the electrical equipment, and
- b) the vault contains a *smoke detector* which will actuate the *building* fire alarm system in the event of a fire in the vault.

**4)** Only pipes or ducts necessary for fire protection or the proper operation of the electrical installation shall penetrate the *fire separation* referred to in Sentence (2).

**5)** Explosion-relief devices and vents or other protective measures conforming to Sentence 3.3.1.20.(3) shall be provided for an electrical equipment vault referred to in Sentence (1) that contains dielectric-liquid-filled electrical equipment. (See Note A-3.6.2.7.(5).)

**6)** An electrical equipment vault referred to in Sentence (1) shall be provided with a ventilation system designed in conformance with Part 6 to prevent the ambient temperature in the vault from exceeding 40°C.

**7)** The ventilation system required by Sentence (6) shall be separate from the system for the remainder of the *building* and shall be designed so that it is automatically shut off in the event of a fire in the vault.

**8)** The floor of an electrical equipment vault referred to in Sentence (1) shall be liquid tight and surrounded by liquid tight walls and sills of sufficient height to confine within the vault all of the liquid from the largest item of electrical equipment, but to a height of not less than 100 mm.

**9)** Electrical equipment vaults shall be secured against unauthorized entry.

**3.6.2.8. Emergency Power Installations**

**1)** Where a generator intended to supply emergency power for lighting, fire safety and life safety systems is located in a *building*, except where such *building* is used solely for the purpose of housing the generator and its ancillary equipment, it shall be located in a room that

- a) is separated from the remainder of the *building* by a *fire separation* having a *fire-resistance rating* not less than 2 h, and
- b) contains only the generating set and equipment related to the emergency power supply system.

**3.6.3. Vertical Service Spaces and Service Facilities**

**3.6.3.1. Fire Separations for Vertical Service Spaces**

- 1)** Except as provided in Articles 3.6.3.3. and 3.6.3.5. and Section 3.5., a *vertical service space* shall be separated from all other portions of each adjacent *storey* by a *fire separation* having a *fire-resistance rating* conforming to Table 3.6.3.1. for the *fire-resistance rating* required by Subsection 3.2.2. for
- a) the floor assembly above the *storey*, or
  - b) the floor assembly below the *storey*, if there is no floor assembly above.
- (See Note A-3.6.3.1.(1).)

**Table 3.6.3.1.**  
**Fire Separations for Vertical Service Spaces**  
 Forming Part of Sentence 3.6.3.1.(1)

<i>Fire-Resistance Rating of Fire Separation</i> Required for Floor Assembly	Minimum <i>Fire-Resistance Rating of Vertical Service Space</i>
less than 45 min	—
45 min	45 min
1 h	45 min
1.5 h	1 h
2 h or more	1 h

- 2)** A *vertical service space* that does not extend through the roof of a *building* shall be enclosed at the top with construction having a *fire-resistance rating* not less than that required for the *vertical service space* walls.
- 3)** A *vertical service space* that does not extend to the bottom of a *building* shall be enclosed at the lowest level with construction having a *fire-resistance rating* not less than that required for the *vertical service space* walls.
- 4)** A vent from a *vertical service space* not extending to the roof shall be enclosed within the *building* with construction having a *fire-resistance rating* not less than that required for the *vertical service space* walls.
- 5)** Only openings that are necessary for the use of the *vertical service space* shall be permitted through a *vertical service space* enclosure.

**3.6.3.2. Foamed Plastic Protection**

- 1)** Foamed plastic insulation in a *vertical service space* shall be protected in conformance with Article 3.1.5.14.

**3.6.3.3. Linen and Refuse Chutes**

- 1)** A linen chute or refuse chute shall
- a) be impervious to moisture,
  - b) have a smooth internal surface,
  - c) be corrosion-resistant,
  - d) be constructed of *noncombustible* material, and
  - e) be located in a shaft in which there are no services other than *noncombustible* drain, waste and vent piping or *noncombustible* water piping.
- 2)** A shaft containing a linen chute or refuse chute shall have a *fire-resistance rating* conforming to Sentence 3.6.3.1.(1), but not less than
- a) 1 h if the chute outlet for the discharge room is protected by an automatic, self-latching *closure* held open by a fusible link, or
  - b) 2 h if no *closure* is provided at the chute outlet into the discharge room.

- 3) An interior linen chute or refuse chute shall extend not less than 1 m above the roof and shall be vented above the roof with a vent which
  - a) has an unobstructed area not less than the cross-sectional area of the chute, and
  - b) is equipped with a cover that will open automatically, or that can be opened manually, in the event of a fire in the chute.
- 4) Intake openings for a linen chute or a refuse chute shall
  - a) have an area not more than 60% of the cross-sectional area of the chute, and
  - b) be fitted with *closures* designed to close automatically and latch after use.
- 5) Intake openings for a linen chute or a refuse chute shall be located in rooms or compartments that
  - a) have no dimension less than 750 mm,
  - b) are separated from the remainder of the *building* by a *fire separation* with a *fire-resistance rating* not less than 45 min,
  - c) are designed for no other purpose, and
  - d) do not open directly into an *exit*.
- 6) Sprinklers shall be installed at the top of each linen chute or refuse chute, at alternate floor levels and in the room or bin into which the chute discharges.
- 7) The room into which a linen chute discharges shall be separated from the remainder of the *building* by a *fire separation* with a *fire-resistance rating* not less than 1 h.
- 8) A refuse chute shall be equipped at the top with spray equipment for washing-down purposes.
- 9) A refuse chute shall discharge only into a room or bin separated from the remainder of the *building* by a *fire separation* with a *fire-resistance rating* not less than 2 h.
- 10) The room or bin into which a refuse chute discharges shall be of sufficient size to contain the refuse between normal intervals of emptying, be impervious to moisture and be equipped with a water connection and floor drain for washing-down purposes.
- 11) A room into which a refuse chute discharges shall contain no service equipment that is not related to refuse handling and disposal.

#### 3.6.3.4. Exhaust Duct Negative Pressure

- 1) If a *vertical service space* contains an *exhaust duct* that serves more than one *fire compartment*,
  - a) the duct shall have a fan located at or near the exhaust outlet to ensure that the duct is under negative pressure, and
  - b) the individual *fire compartments* shall not have individual fans that exhaust directly into the duct in the *vertical service space*.

#### 3.6.3.5. Grease Duct Enclosures

(See Note A-3.6.3.5.)

- 1) Except as provided in Sentence (2), *fire separations* enclosing grease ducts for commercial cooking operations shall conform to NFPA 96, "Ventilation Control and Fire Protection of Commercial Cooking Operations."
- 2) The *fire-resistance rating* of field-applied and factory-built grease duct enclosure assemblies shall be determined in conformance with CAN/ULC-S144, "Fire Resistance Test – Grease Duct Assemblies."

### 3.6.4. Horizontal Service Spaces and Service Facilities

#### 3.6.4.1. Scope

- 1) This Subsection applies to *horizontal service spaces* and service facilities, including ceiling spaces, duct spaces, crawl spaces and *attic or roof spaces*.

**3.6.4.2. Fire Separations for Horizontal Service Spaces**

**1)** Except as provided in Article 3.6.3.5., a *horizontal service space* that penetrates a required vertical *fire separation* shall be separated from the remainder of the *building* it serves in conformance with Sentence (2).

**2)** If a *horizontal service space* or other concealed space is located above a required vertical *fire separation* other than a vertical shaft, this space need not be divided at the *fire separation* as required by Article 3.1.8.3. provided the construction between this space and the space below is a *fire separation* with a *fire-resistance rating* equivalent to that required for the vertical *fire separation*, except that the *fire-resistance rating* is permitted to be not less than 30 min if the vertical *fire separation* is not required to have a *fire-resistance rating* more than 45 min. (See Note A-3.6.4.2.(2).)

**3.6.4.3. Plenum Requirements**

**1)** A concealed space used as a *plenum* within a floor assembly or within a roof assembly need not conform to Sentence 3.1.5.18.(1) and Article 3.6.5.1., provided

- a) all materials within the concealed space have a *flame-spread rating* not more than 25 and a smoke developed classification not more than 50, except for
  - i) tubing for pneumatic controls,
  - ii) optical fibre cables and electrical wires and cables with *combustible* insulation, jackets or sheathes that are used for the transmission of voice, sound or data and conform to Sentences 3.1.4.3.(2) and 3.1.5.21.(2),
  - iii) totally enclosed non-metallic raceways with an FT6 rating, when tested in accordance with Clause 3.1.5.23.(1)(a), in *buildings* required to be of *noncombustible construction*, and
  - iv) totally enclosed non-metallic raceways with an FT4 rating, when tested in accordance with Clause 3.1.5.23.(1)(a), in *buildings* permitted to be of *combustible construction*, and
- b) the supports for the ceiling membrane are of *noncombustible* material having a melting point not below 760°C.

**2)** If a concealed space referred to in Sentence (1) is used as a return-air *plenum* and incorporates a ceiling membrane that forms part of the required *fire-resistance rating* of the assembly, every opening through the membrane shall be protected by a *fire stop flap* that

- a) stops the flow of air into the concealed space in the event of a fire,
- b) is supported in a manner that will maintain the integrity of the ceiling membrane for the duration of time required to provide the required *fire-resistance rating*,
- c) conforms to CAN/ULC-S112.2, "Fire Test of Ceiling Firestop Flap Assemblies," and
- d) activates at a temperature approximately 30°C above the normal maximum temperature that occurs in the return-air *plenum*, whether the air duct system is operating or shut down.

**3.6.4.4. Attic or Roof Space Access**

**1)** An *attic or roof space* more than 600 mm high shall be provided with access from the floor immediately below by a hatchway not less than 550 mm by 900 mm or by a stairway.

**3.6.4.5. Horizontal Service Space Access**

**1)** A *horizontal service space*, consisting of ceiling and duct spaces, which is more than 1 200 mm high and 600 mm wide shall have inspection doors not less than 300 mm in both horizontal and vertical dimensions placed so that the entire interior of the duct or space can be viewed.

**3.6.4.6. Crawl Space Access**

**1)** A crawl space shall have at least one access opening not less than 550 mm by 900 mm.

**3.6.5. Air Duct and Plenum Systems****3.6.5.1. Duct Materials**

**1)** Except as permitted by Sentences (2) to (5) and Article 3.6.4.3., all ducts, duct connectors, associated fittings and *plenums* used in air duct systems shall be constructed of steel, aluminum alloy, copper, clay, asbestos-cement or other *noncombustible* material.

**2)** Except as permitted by Sentence (3), ducts, associated fittings and *plenums* are permitted to contain *combustible* material provided they

- a) conform to the appropriate requirements for Class 1 duct materials in CAN/ULC-S110, "Test for Air Ducts,"
- b) conform to Article 3.1.5.18. in a *building* required to be of *noncombustible construction*,
- c) conform to Subsection 3.1.9.,
- d) are used only in horizontal runs in a *building* required to be of *noncombustible construction*,
- e) are not used in vertical runs serving more than 2 *storeys* in a *building* permitted to be of *combustible construction*, and
- f) are not used in air duct systems in which the air temperature could be more than 120°C.

**3)** *Combustible* ducts which are part of a duct system conveying only ventilation air and are contained entirely within a *dwelling unit* need not comply with the requirements of Sentences (1) and (2).

**4)** Duct sealants shall have a *flame-spread rating* not more than 25 and a smoke developed classification not more than 50.

**5)** Duct connectors that contain *combustible* materials and that are used between ducts and air outlet units shall

- a) conform to the appropriate requirements for Class 1 air duct materials in CAN/ULC-S110, "Test for Air Ducts,"
- b) be not more than 4 m long,
- c) be used only in horizontal runs, and
- d) not penetrate a required *fire separation*.

**3.6.5.2. Vibration Isolation Connectors**

**1)** Except as permitted by Sentence (2), vibration isolation connectors in air duct systems shall be *noncombustible*.

- 2)** *Combustible* fabric vibration isolation connectors are permitted provided they
- a) are not more than 250 mm long,
  - b) comply with the flame-resistance requirements of CAN/ULC-S109, "Flame Tests of Flame-Resistant Fabrics and Films," and
  - c) are not used in a location where they are exposed to heated air or radiation from heat sources that could cause the exposed surface temperature to be more than 120°C.

**3.6.5.3. Tape**

**1)** Tape used to seal joints in air ducts, *plenums* and other parts of air duct systems shall meet the flame-resistance requirements for fabric in CAN/ULC-S109, "Flame Tests of Flame-Resistant Fabrics and Films."

**3.6.5.4. Coverings, Linings, Adhesives and Insulation**

**1)** Coverings, linings and associated adhesives and insulation for air ducts, *plenums* and other parts of air duct systems that would have an exposed surface temperature more than 120°C when exposed to heated air or radiation from heat sources shall be of *noncombustible* material.

- 2) Except as permitted by Sentence (3), *combustible* coverings and linings, including associated adhesives and insulation, shall have
  - a) a *flame-spread rating* not more than 25 on any exposed surface or any surface that would be exposed by cutting through the material in any direction, and
  - b) a smoke developed classification not more than 50.
- 3) The outer covering of ducts, *plenums* and other parts of air duct systems used within an assembly of *combustible construction* is permitted to have
  - a) an exposed surface *flame-spread rating* not more than 75, and
  - b) a smoke developed classification not more than 50.
- 4) *Combustible* coverings and linings referred to in Sentences (2) and (3) shall not flame, glow, smoulder or smoke when tested in accordance with the method of test in ASTM C 411, "Hot-Surface Performance of High-Temperature Thermal Insulation," at the maximum temperature to which the coverings and linings are to be exposed in service.
- 5) Except as permitted by Sentence (6), foamed plastic insulation shall not be used as part of an air duct system or for insulating an air duct.
- 6) Foamed plastic insulation is permitted to be installed in a ceiling space that is used as a return air *plenum* provided the foamed plastic insulation is protected from exposure to the *plenum* in accordance with Article 3.1.5.14.
- 7) *Combustible* coverings and linings of ducts, including associated adhesives and insulation, shall be interrupted where the duct penetrates a *fire separation* and at the immediate area of operation of heat sources in a duct system, including electric resistance heaters or fuel-burning heaters or *furnaces*.

### 3.6.5.5. Insulation and Coverings

- 1) Insulation and coverings on pipes in which the temperature of the fluid exceeds 120°C shall
  - a) be made of *noncombustible* material, or
  - b) not flame, glow, smoulder or smoke when tested in accordance with ASTM C 411, "Hot-Surface Performance of High-Temperature Thermal Insulation," at the maximum temperature to which the insulation or covering is to be exposed in service.
- 2) Except as permitted by Sentence (5), where *combustible* insulation is used on piping in a *horizontal service space* or a *vertical service space*, the insulation and coverings on that piping shall have a *flame-spread rating*, on any exposed surface and on any surface that would be exposed by cutting through the material in any direction,
  - a) not more than 25 in a *building* required to be of *noncombustible construction*, or
  - b) not more than 75 in a *building* permitted to be of *combustible construction*.
- 3) Except as permitted by Sentence (5), insulation and coverings on piping located in rooms and spaces other than the *service spaces* described in Sentence (2) shall have a *flame-spread rating* not more than that required for the interior finish of the ceiling of the room or space.
- 4) Except as permitted by Sentence (5), *combustible* insulation and covering used on piping in a *building* within the scope of Subsection 3.2.6. shall have a smoke developed classification not more than 100.
- 5) No *flame-spread rating* or smoke developed classification limits are required for *combustible* insulation and coverings used on piping located within a
  - a) concealed space in a wall,
  - b) floor slab, or
  - c) *noncombustible* enclosure.

### 3.6.5.6. Clearance of Ducts and Plenums

- 1) The clearance of *furnace plenums* from *combustible* material shall conform to the requirements of the appropriate standards referenced in Sentence 6.2.1.5.(1).

**2)** If the *plenum* clearance required in accordance with Sentence (1) is not more than 75 mm, the clearance between a *supply duct* and *combustible* material shall be not less than

- a) the required *plenum* clearance within a horizontal distance of 450 mm from the *plenum*, and
- b) 12 mm at a horizontal distance of 450 mm or more from the *plenum*, except that this clearance is permitted to be reduced to zero beyond a bend or offset in the duct sufficiently large to shield the remainder of the *supply duct* from direct radiation from the *furnace* heat exchanger.

(See Note A-3.6.5.6.(2).)

**3)** If the *plenum* clearance required in accordance with Sentence (1) is more than 75 mm but not more than 150 mm, the clearance between a *supply duct* and *combustible* material shall be not less than

- a) the required *plenum* clearance within a horizontal distance of 1 800 mm from the *plenum*, and
- b) 12 mm at a horizontal distance of 1 800 mm or more from the *plenum*, except that this distance is permitted to be reduced to zero beyond a bend or offset in the duct sufficiently large to shield the remainder of the *supply duct* from direct radiation from the *furnace* heat exchanger.

(See Note A-3.6.5.6.(3).)

**4)** If the *plenum* clearance required in accordance with Sentence (1) is more than 150 mm, the clearance between a *supply duct* and *combustible* material shall be not less than

- a) the required *plenum* clearance within a horizontal distance of 1 000 mm from the *plenum*,
- b) 150 mm within a horizontal distance between 1 000 mm and 1 800 mm from the *plenum*, and
- c) 25 mm at a horizontal distance of 1 800 mm or more from the *plenum*, except that this distance is permitted to be reduced to 8 mm beyond a bend or offset in the duct sufficiently large to shield the remainder of the *supply duct* from direct radiation from the *furnace* heat exchanger.

(See Note A-3.6.5.6.(4).)

**5)** If a register is installed in a floor directly over a pipeless *furnace*, a double-walled register box with not less than 100 mm between walls, or a register box with the warm-air passage completely surrounded by the cold-air passage, shall be permitted instead of the clearances listed in Sentences (2), (3) and (4).

### 3.6.5.7. Supply, Return, Intake and Exhaust-Air Openings

**1)** *Combustible* grilles, diffusers and other devices for supply, return, and exhaust-air openings in rooms shall conform to the *flame-spread rating* and smoke developed classification requirements for the interior finish of the surface on which they are installed.

### 3.6.5.8. Return-Air System

**1)** Except as required by Sentences (2) and (3), *return ducts* shall be constructed of material having a *flame-spread rating* not more than 150.

**2)** If any part of a *return duct* will be exposed to radiation from the *furnace* heat exchanger or other radiating part within the *furnace*, that part of a *return duct* directly above or within 600 mm of the outside *furnace* casing shall be *noncombustible*.

**3)** *Return ducts* serving solid-fuel-burning *furnaces* shall be constructed of *noncombustible* material.

- 4)** *Combustible return ducts* shall be lined with *noncombustible* material
- a) below floor registers,
  - b) at the bottom of vertical ducts, and
  - c) under *furnaces* having a bottom return.



## Section 3.7. Health Requirements

### 3.7.1. Height of Rooms

#### 3.7.1.1. Room and Space Height

- 1) The height of every room and space shall be sufficient so that the ceiling or ceiling fixtures do not obstruct movement or activities below.
- 2) The unobstructed height in *dwelling units* shall conform to Subsection 9.5.3.

### 3.7.2. Plumbing Facilities

#### 3.7.2.1. Plumbing and Drainage Systems

- 1) Except as permitted in Sentence (2), if the installation of a *sanitary drainage system* is not possible because of the absence of a water supply, sanitary privies, chemical closets or other means for the disposal of human waste shall be provided.
- 2) Waterless urinals are permitted to be used in *buildings* provided with a water supply.

#### 3.7.2.2. Water Closets

- 1) Except as permitted by Sentence (4), water closets shall be provided for each sex assuming that the *occupant load* is equally divided between males and females, unless the proportion of each sex expected in the *building* can be determined with reasonable accuracy. (See Note A-3.7.2.2.(1).)
- 2) If a single universal washroom is provided in accordance with the requirements of Section 3.8., the total number of persons in the *building* used to determine the number of water closets to be provided, is permitted to be reduced by 10 before applying Sentence (6), (7), (8), (12), (13) or (14).
- 3) Except as permitted by Sentence (2), if only one universal washroom is provided in accordance with Section 3.8., the water closet in this room shall not be taken into consideration in determining the number of water closets required by this Article, unless a single water closet is permitted in accordance with Sentence (4).
- 4) Both sexes are permitted to be served by a single water closet if the *occupant load* in an *occupancy* referred to in Sentence (6), (10), (12), (13), (14) or (16) is not more than 10.
- 5) Urinals are permitted to be substituted for two thirds of the number of water closets required by this Article for males, except that if only 2 water closets are required for males, one urinal is permitted to be substituted for one of the water closets.
- 6) Except as permitted by Sentences (4), (7) and (8), the number of water closets required for *assembly occupancies* shall conform to Table 3.7.2.2.-A.

**Table 3.7.2.2.-A**  
**Water Closets for an Assembly Occupancy**  
 Forming Part of Sentence 3.7.2.2.(6)

Number of Persons of Each Sex	Minimum Number of Water Closets	
	Male	Female
1 - 25	1	1
26 - 50	1	2
51 - 75	2	3
76 - 100	2	4
101 - 125	3	5
126 - 150	3	6
151 - 175	4	7
176 - 200	4	8
201 - 250	5	9
251 - 300	5	10
301 - 350	6	11
351 - 400	6	12
Over 400	7, plus 1 for each additional increment of 200 males in excess of 400	13, plus 1 for each additional increment of 100 females in excess of 400

**7)** The number of water closets required for primary schools and daycare centres shall be at least one for each 30 males and one for each 25 females.

**8)** The number of water closets required for places of worship and undertaking premises shall be at least one for each 150 persons of each sex.

**9)** The number of water closets required for a *treatment* or *detention occupancy* shall be determined on the basis of the special needs of the *occupancy*.

**10)** Except as permitted by Sentences (4) and (7), the number of water closets required for a *care* or *residential occupancy* shall be at least one for each 10 persons of each sex.

**11)** At least one water closet shall be provided for each *dwelling unit*.

**12)** Except as permitted by Sentence (4), the number of water closets required for a *business and personal services occupancy* shall conform to Table 3.7.2.2.-B.

**Table 3.7.2.2.-B**  
**Water Closets for a Business and Personal Services Occupancy**  
 Forming Part of Sentences 3.7.2.2.(12) and (16)

Number of Persons of Each Sex	Minimum Number of Water Closets for Each Sex
1 - 25	1
26 - 50	2
Over 50	3, plus 1 for each additional increment of 50 persons of each sex in excess of 50

**13)** Except as permitted by Sentences (4) and (16), the number of water closets required for a *mercantile occupancy* shall be at least one for each 300 males and one for each 150 females.

**14)** Except as permitted by Sentence (4), the number of water closets required for an *industrial occupancy* shall conform to Table 3.7.2.2.-C.

**Table 3.7.2.2.-C**  
**Water Closets for an Industrial Occupancy**  
 Forming Part of Sentence 3.7.2.2.(14)

Number of Persons of Each Sex	Minimum Number of Water Closets for Each Sex
1 - 10	1
11 - 25	2
26 - 50	3
51 - 75	4
76 - 100	5
Over 100	6, plus 1 for each additional increment of 30 persons of each sex in excess of 100

**15)** In a *building* whose *floor area* is more than 600 m<sup>2</sup> and that includes one or more individual tenant spaces for a *business and personal services occupancy* or *mercantile occupancy*, water closets shall be located so that they are accessible to the public when the *building* is occupied.

**16)** The number of water closets required in a *suite* of *mercantile occupancy* whose area is not more than 500 m<sup>2</sup> is permitted to be determined in accordance with Table 3.7.2.2.-B based solely on the total number of staff.

**3.7.2.3. Lavatories**

**1)** Except as permitted by Sentence (2), at least one lavatory shall be provided in a room containing one or 2 water closets or urinals, and at least one additional lavatory shall be provided for each additional 2 water closets or urinals.

**2)** Wash fountains in circular form are permitted to be provided in lieu of lavatories required by Sentence (1) provided each 500 mm of circumference is considered to be the equivalent of one lavatory.

**3)** Any shelf or projection above a lavatory shall be located so that it will not be a hazard.

- 4)** Lavatories required by Sentence (1) shall be equipped with faucets that
- a) operate automatically, or
  - b) have a manual control that
    - i) complies with Clause 3.8.3.8.(1)(b),
    - ii) does not require the application of continuous force to maintain water flow, and
    - iii) where metered, provides at least 10 s of water flow.

**3.7.2.4. Mobile Home Facilities**

**1)** If mobile homes do not have individual sanitary facilities connected to a central water supply and drainage system, a service *building* shall be provided for public use.

- 2)** The service *building* required by Sentence (1) shall contain
- a) at least one water closet for each sex if the service *building* facilities serve not more than 10 mobile homes, and
  - b) an additional water closet for each sex for each additional 10 mobile homes.

**3)** If a service *building* is required by Sentence (1), it shall contain lavatories as required by Sentence 3.7.2.3.(1) and at least

- a) one laundry tray or similar facility, and
- b) one bathtub or shower for each sex.

**3.7.2.5. Safety Glass**

**1)** Glass, other than safety glass, shall not be used for a shower or bathtub enclosure.

**3.7.2.6.****3.7.2.6. Surface Protection**

**1)** Wall and floor surfaces below the uppermost surfaces of a urinal shall be protected from deterioration by impervious and durable material for a distance from the urinal to a point not less than 900 mm from the projected outline of the urinal on to the wall or floor.

**2)** Floor surfaces around a water closet shall be protected from deterioration by an impervious and durable material for a distance not less than 900 mm from the projected outline of the water closet on the floor.

**3.7.2.7. Floor Drain**

**1)** A floor drain shall be installed in a washroom containing a urinal equipped with an automatic flushing device.

**3.7.2.8. Grab Bars**

- 1)** Grab bars shall
- a) be slip-resistant and free of any sharp or abrasive elements,
  - b) be mounted on surfaces that are free of any sharp or abrasive elements,
  - c) be able to resist a load of not less than 1.3 kN applied vertically or horizontally,
  - d) be 30 mm to 40 mm in diameter, and
  - e) where mounted on a wall, have a clearance of 35 mm to 45 mm from the wall.

**3.7.2.9. Bathtubs**

- 1)** Where a bathtub is installed in a hotel or a motel, it shall
- a) have a clear floor space at least 750 mm wide along its length, except that a water closet or a lavatory is permitted to encroach this space,
  - b) have faucets and other controls that conform to Clause 3.8.3.8.(1)(b),
  - c) have a slip-resistant bottom surface,
  - d) have grab bars that
    - i) conform to Sentence 3.7.2.8.(1),
    - ii) are not less than 1 200 mm long located vertically at the end of the bathtub that is adjacent to the clear floor space, with the lower end between 180 mm and 280 mm above the bathtub rim, and
    - iii) are not less than 1 200 mm long located horizontally along the length of the bathtub at 180 mm to 280 mm above the bathtub rim, and
  - e) be capable of being accessed along its full length with no tracks mounted on the bathtub rim.

**3.7.3. Medical Gas Piping Systems****3.7.3.1. Medical Gas Piping**

**1)** If a non-flammable medical gas piping system is installed, it shall be installed in conformance with

- a) CSA Z7396.1, "Medical Gas Pipeline Systems – Part 1: Pipelines for Medical Gases, Medical Vacuum, Medical Support Gases, and Anaesthetic Gas Scavenging Systems," and
- b) Part 3 of Division B of the NBC.

## Section 3.8. Accessibility

(See Note A-3.8.)

### 3.8.1. Scope

#### 3.8.1.1. Scope

- 1) This Section is concerned with the *barrier-free* design of *buildings*.
- 2) *Buildings* and facilities required to be *barrier-free* in accordance with Subsection 3.8.2. shall be designed in accordance with Subsection 3.8.3.

### 3.8.2. Application

#### 3.8.2.1. Exceptions

(See Note A-3.8.2.1.)

- 1) The requirements of this Section apply to all *buildings* except
  - a) detached houses, semi-detached houses, houses with a *secondary suite*, duplexes, triplexes, townhouses, row houses and boarding houses (see Note A-1.4.1.2.(1) of Division A, Secondary Suite),
  - b) *buildings* of Group F, Division 1 *major occupancy*, and
  - c) *buildings* that are not intended to be occupied on a daily or full-time basis, including automatic telephone exchanges, pumphouses and substations.

#### 3.8.2.2. Entrances

(See Note A-3.8.2.2.)

- 1) In addition to the *barrier-free* entrances required by Sentence (2), not less than 50% of the pedestrian entrances of a *building* referred to in Sentence 3.8.2.1.(1) shall be *barrier-free* and shall lead from
  - a) the outdoors at sidewalk level, or
  - b) a ramp that complies with Subsection 3.8.3. and leads from a sidewalk.
- 2) A *suite of assembly occupancy, business and personal services occupancy or mercantile occupancy* that is located in the *first storey* of a *building*, or in a *storey* to which a *barrier-free* path of travel is provided, and that is completely separated from the remainder of the *building* so that there is no access to the remainder of the *building*, shall have at least one *barrier-free* entrance.
- 3) A *barrier-free* entrance required by Sentence (1) or (2) shall be designed in accordance with Subsection 3.8.3.
- 4) At a *barrier-free* entrance that includes more than one doorway, only one of the doorways is required to be designed in accordance with Subsection 3.8.3.
- 5) If a *walkway* or pedestrian bridge connects two *barrier-free storeys* in different *buildings*, the path of travel from one *storey* to the other *storey* by means of the *walkway* or bridge shall be *barrier-free*.

#### 3.8.2.3. Areas Requiring a Barrier-Free Path of Travel

(See Note A-3.8.2.3.)

- 1) Except as permitted by Sentence (2), a *barrier-free* path of travel from the entrances required by Sentences 3.8.2.2.(1) and (2) to be *barrier-free* shall be provided throughout the entrance *storey* and within all other normally occupied *floor areas* served by a passenger elevator, escalator, inclined moving walk, or other platform-equipped passenger-elevating device. (See Article 3.3.1.7. for additional requirements regarding *floor areas* above or below the *first storey* to which a *barrier-free* path of travel is required.)
- 2) A *barrier-free* path of travel for persons in wheelchairs is not required
  - a) to *service rooms*,
  - b) to elevator machine rooms,
  - c) to janitor's rooms,

- d) to *service spaces*,
- e) to *crawl spaces*,
- f) to *attic or roof spaces*,
- g) to floor levels not served by a passenger elevator, a platform-equipped passenger-elevating device, an escalator, or an inclined moving walk,
- h) to *high-hazard industrial occupancies*,
- i) within portions of a *floor area* with fixed seats in an *assembly occupancy* where those portions are not part of the *barrier-free* path of travel to spaces designated for wheelchair use,
- j) within floor levels of a *suite of residential occupancy* that are not at the same level as the entry level to the *suite*,
- k) within a *suite of residential occupancy* that has not been designated by an *authority having jurisdiction* to be accessible for use by persons with physical disabilities, or
- l) within those parts of a *floor area* that are not at the same level as the entry level, provided amenities and uses provided on any raised or sunken level are accessible on the entry level by means of a *barrier-free* path of travel.

**3)** In an *assembly occupancy*, the number of spaces designated for wheelchair use within rooms or areas with fixed seats shall conform to Table 3.8.2.3. (See also Article 3.8.3.21. for additional requirements.)

**Table 3.8.2.3.**  
**Designated Wheelchair Spaces**  
 Forming Part of Sentence 3.8.2.3.(3)

Number of Fixed Seats in Seating Area	Number of Spaces Required for Wheelchairs
2 - 100	2
101 - 200	3
201 - 300	4
301 - 400	5
401 - 500	6
501 - 900	7
901 - 1 300	8
1 301 - 1 700	9
each increment of up to 400 seats in excess of 1 700	one additional space

**3.8.2.4. Access to Storeys Served by Escalators and Moving Walks**

**1)** In a *building* in which an escalator or inclined moving walk provides access to any floor level above or below the entrance floor level, an interior *barrier-free* path of travel shall also be provided to that floor level. (See Note A-3.8.2.4.(1).)

**2)** The route from the escalator or inclined moving walk to the *barrier-free* path of travel that leads from floor to floor as required by Sentence (1) shall be clearly indicated by appropriate signs.

**3.8.2.5. Access to Parking Areas and Exterior Passenger-Loading Zones**

(See Note A-3.8.2.5.)

**1)** A *barrier-free* path of travel shall be provided between an exterior parking area and a *barrier-free* entrance referred to in Article 3.8.2.2. (See Note A-3.8.2.5.(1).)

**2)** Where a passenger elevator serves one or more indoor parking levels, a *barrier-free* path of travel shall be provided between at least one parking level and all other parts of the *building* required to be provided with *barrier-free* access in accordance with Subsection 3.8.3.

**3)** Exterior passenger-loading zones shall comply with Subsection 3.8.3.

**3.8.2.6. Controls**

**1)** Except as provided in Sentence 3.5.2.1.(3), controls for the operation of *building* services or safety devices, including electrical switches, thermostats, faucets, door hardware and intercom switches, that are intended to be operated by the occupant and are located in or adjacent to a *barrier-free* path of travel shall comply with Subsection 3.8.3. (See Note A-3.8.2.6.(1).)

**3.8.2.7. Power Door Operators**

**1)** Except as provided in Sentences (2) and (3), every door that provides a *barrier-free* path of travel through an entrance referred to in Article 3.8.2.2., including the interior doors of a vestibule where provided, shall be equipped with a power door operator that complies with Subsection 3.8.3. and allows persons to activate the opening of the door in the intended direction of travel, where the entrance serves

- a) a hotel,
- b) a *building* of Group B, Division 2 *major occupancy*, or
- c) a *building* of Group A, Group B, Division 3, Group D or E *major occupancy* more than 500 m<sup>2</sup> in *building area*.

**2)** The requirements of Sentence (1) do not apply to an individual *suite* having an area less than 500 m<sup>2</sup> in a *building* having only *suites* of *assembly, care, business and personal services* or *mercantile occupancy* if the *suite* is completely separated from the remainder of the *building* so that there is no access to the remainder of the *building*.

**3)** Only the active leaf in a multiple leaf door in a *barrier-free* path of travel need conform to the requirements of this Article.

**3.8.2.8. Plumbing Facilities**

**1)** Except as permitted by Sentence (2), a washroom in a *storey* to which a *barrier-free* path of travel is required in accordance with Article 3.8.2.3., shall be *barrier-free* in accordance with Subsection 3.8.3. (See Note A-3.8.2.8.(1) to (4).)

- 2)** A washroom need not conform to the requirements of Sentence (1) provided
- a) it is located within a *suite* of *residential occupancy* or a *suite* of *care occupancy*,
  - b) other *barrier-free* washrooms are provided on the same *floor area* within 45 m, or
  - c) it is located in an individual *suite* that is
    - i) used for a *business and personal services occupancy*, a *mercantile occupancy* or an *industrial occupancy*,
    - ii) less than 500 m<sup>2</sup> in area, and
    - iii) completely separated from, and without access to, the remainder of the *building*.

(See Note A-3.8.2.8.(1) to (4).)

**3)** In a *building* in which water closets are required in accordance with Subsection 3.7.2., at least one *barrier-free* water closet shall be provided in the entrance *storey*, unless

- a) a *barrier-free* path of travel is provided to *barrier-free* water closets elsewhere in the *building*, or
- b) the water closets required by Subsection 3.7.2. are for *dwelling units* only.

(See Note A-3.8.2.8.(1) to (4).)

**4)** Where *alterations* are made to an existing *building*, universal washrooms complying with Subsection 3.8.3. are permitted to be provided in lieu of facilities for persons with physical disabilities in washrooms used by the general public. (See Note A-3.8.2.8.(1) to (4).)

**5)** At least one water-closet stall or enclosure in a washroom required to be *barrier-free* shall comply with Subsection 3.8.3.

**6)** Where urinals are provided in a *barrier-free* washroom, at least one urinal shall comply with Subsection 3.8.3.

**7)** A *barrier-free* washroom shall be provided with a lavatory that complies with Subsection 3.8.3.

**8)** Where mirrors are provided in a *barrier-free* washroom, at least one mirror shall comply with Subsection 3.8.3.

**9)** Where drinking fountains are provided, at least one shall comply with Subsection 3.8.3.

**10)** Except within a *suite of care occupancy* or a *suite of residential occupancy*, where showers are provided in a *building*, at least one shower stall in each group of showers shall comply with Subsection 3.8.3.

**11)** Where a bathtub is installed in a *suite of residential occupancy* required to be *barrier-free*, it shall comply with Subsection 3.8.3.

### 3.8.2.9. Assistive Listening Devices

**1)** In a *building of assembly occupancy*, all classrooms, auditoria, meeting rooms and *theatres* with an area of more than 100 m<sup>2</sup> shall be equipped with an assistive listening system complying with Subsection 3.8.3.

### 3.8.2.10. Signs and Indicators

**1)** Signs complying with Subsection 3.8.3. shall be installed to indicate the location of

- a) *barrier-free* entrances,
- b) *barrier-free* washrooms,
- c) *barrier-free* showers,
- d) *barrier-free* elevators,
- e) *barrier-free* parking spaces, and
- f) facilities for persons with hearing disabilities.

**2)** Where a washroom is not designed to accommodate persons with physical disabilities in a *storey* to which a *barrier-free* path of travel is required, signs shall be provided to indicate the location of *barrier-free* facilities.

### 3.8.2.11. Counters and Counters for Telephones

**1)** Every counter more than 2 m long at which the public is served shall comply with Subsection 3.8.3. (See Note A-3.8.2.11.(1).) (See also Note A-3.8.2.3.)

**2)** Built-in shelves and counters provided for public telephones shall comply with Subsection 3.8.3.

## 3.8.3. Design

### 3.8.3.1. Design Standards

**1)** *Buildings* or parts thereof and facilities that are required to be *barrier-free* shall be designed in accordance with

- a) this Subsection, or
- b) the provisions of CSA B651, "Accessible Design for the Built Environment," listed in Table 3.8.3.1., in their entirety.

(See Note A-3.8.3.1.(1).)

**Table 3.8.3.1.**  
**Barrier-free Design Provisions**  
Forming Part of Sentence 3.8.3.1.(1)

Barrier-free Application (Code References)	Applicable CSA B651 Provisions
Interior accessible routes (3.8.3.2.)	4.3 and 5.1
Exterior accessible routes (3.8.3.3.)	8.2.1 to 8.2.5 and 8.2.7
Passenger pickup areas (3.8.3.4.)	9.3
Ramps (3.8.3.5.)	5.3 and 5.5
Doors and doorways (3.8.3.6.)	5.2



**Table 3.8.3.1. (Continued)**

<i>Barrier-free</i> Application (Code References)	Applicable CSA B651 Provisions
Passenger-elevating devices (3.8.3.7.)	5.6.2
Operating controls (3.8.3.8.)	4.2
Signage (3.8.3.9.)	4.5 and 9.4
Drinking fountains (3.8.3.10.)	6.1
Washroom facilities (3.8.3.11. to 3.8.3.15.)	6.2 and 6.3
Bathing facilities (3.8.3.16. and 3.8.3.17.)	6.5
Communication (3.8.3.18. and 3.8.3.20.)	6.6
Counters (3.8.3.19. and 3.8.3.20.)	6.7.1
Spaces in seating areas (3.8.3.21.)	6.7.2

**3.8.3.2. Barrier-Free Path of Travel**

**1)** Except as required elsewhere in this Part or as permitted by Article 3.8.3.6. pertaining to doorways, the unobstructed width of a *barrier-free* path of travel shall be not less than 920 mm.

**2)** Interior and exterior walking surfaces that are within a *barrier-free* path of travel shall

- a) have no opening that will permit the passage of a sphere more than 13 mm in diameter,
- b) have any elongated openings oriented approximately perpendicular to the direction of travel,
- c) be stable, firm and slip-resistant,
- d) have a cross slope no steeper than 1 in 50,
- e) be beveled at a maximum slope of 1 in 2 at changes in level between 6 mm and 13 mm, and
- f) be provided with sloped floors or ramps at changes in level more than 13 mm.

(See Note A-3.8.3.2.(2).)

**3)** A *barrier-free* path of travel is permitted to include ramps, passenger elevators or other platform-equipped passenger-elevating devices to overcome a difference in level.

**4)** The width of a *barrier-free* path of travel that is more than 30 m long shall be increased to not less than 1 500 mm for a length of 1 500 mm at intervals not exceeding 30 m.

**3.8.3.3. Exterior Walks**

**1)** Exterior walks that form part of a *barrier-free* path of travel shall

- a) have a slip-resistant, continuous and even surface,
- b) be not less than 1 100 mm wide, and
- c) have a level area conforming to Clause 3.8.3.5.(1)(c) adjacent to an entrance doorway.

**3.8.3.4. Exterior Passenger-Loading Zones**

**1)** If an exterior passenger-loading zone is provided, it shall have

- a) an access aisle not less than 1 500 mm wide and 6 000 mm long adjacent and parallel to the vehicle pull-up space,
- b) a curb ramp, where there are curbs between the access aisle and the vehicle pull-up space, and
- c) a clear height of not less than 2 750 mm at the pull-up space and along the vehicle access and egress routes.

**3.8.3.5. Ramps**

- 1)** A ramp located in a *barrier-free* path of travel shall
  - a) have a clear width not less than 870 mm (see Note A-3.4.3.4.),
  - b) have a slope not more than 1 in 12 (see Note A-3.8.3.5.(1)(b)),
  - c) have a level area not less than 1 500 by 1 500 mm at the top and bottom and at intermediate levels of a ramp leading to a door, so that on the latch side the level area extends not less than
    - i) 600 mm beyond the edge of the door opening where the door opens towards the ramp, or
    - ii) 300 mm beyond the edge of the door opening where the door opens away from the ramp,
 (see Note A-3.8.3.5.(1)(c)),
  - d) have a level area not less than 1 200 mm long and at least the same width as the ramp
    - i) at intervals not more than 9 m along its length, and
    - ii) where there is an abrupt change in the direction of the ramp, and
  - e) except as provided in Sentences (2) and (3), be equipped with handrails conforming to Article 3.4.6.5., except that they shall be not less than 865 mm and not more than 965 mm high, and
  - f) be equipped with *guards* conforming to Article 3.4.6.6.
- 2)** Handrails installed in addition to required handrails need not comply with the height requirements stated in Clause (1)(e).
- 3)** The requirement for handrails in Clause (1)(e) need not apply to a ramp serving as an aisle for fixed seating.
- 4)** The surfaces of ramps and landings shall
  - a) be hard or resilient where the ramp is steeper than 1 in 15 (see Note A-3.8.3.5.(4)(a)),
  - b) have a cross slope no steeper than 1 in 50, and
  - c) where exposed to water, be designed to drain.
- 5)** Ramps and landings not at *grade* or adjacent to a wall shall have edge protection consisting of
  - a) a curb not less than 75 mm high, or
  - b) a raised barrier or rail located not more than 100 mm from the ramp or landing surface.
- 6)** Floors or walks in a *barrier-free* path of travel having a slope steeper than 1 in 20 shall be designed as ramps.

**3.8.3.6. Doorways and Doors**

- 1)** Except where stated otherwise, this Article applies to swinging and sliding doors.
- 2)** Every doorway that is located in a *barrier-free* path of travel shall have a clear width not less than 800 mm when the door is in the open position. (See Note A-3.8.3.6.(2).)
- 3)** Doorways in a path of travel to at least one bathroom within a *suite of residential occupancy* shall have a clear width not less than 800 mm when the doors are open. (See Note A-3.8.3.6.(3).)
- 4)** Door-operating devices shall
  - a) comply with Clause 3.8.3.8.(1)(b), and
  - b) be operable at a height between 900 mm and 1 100 mm above the floor.
 (See Note A-3.8.3.6.(4).)
- 5)** A threshold for a doorway referred to in Sentences (2) and (3) shall be not more than 13 mm higher than the finished floor surface and shall be beveled to facilitate the passage of wheelchairs.

- 6)** Power door operators required by Sentence 3.8.2.7.(1) shall
- a) activate automatically or through the use of controls that
    - i) are located in a *barrier-free* path of travel,
    - ii) are marked with the International Symbol of Access,
    - iii) are located clear of the door swing and no more than 1 500 mm from that door swing,
    - iv) comply with Subclause 3.8.3.8.(1)(a)(ii),
    - v) are operable from a height between 150 mm and 300 mm as well as between 900 mm and 1 100 mm above the floor, and
    - vi) are operable by touching or approaching any part of their surface with a fist, arm or foot, and
  - b) unless equipped with safety sensors,
    - i) fully open the door in not less than 3 s, and
    - ii) require a force not more than 65 N to stop movement of the door.

(See Note A-3.8.3.6.(6) and (7).)

**7)** A cane-detectable *guard* shall be installed on the hinged side of power-assisted doors that swing open into the path of travel. (See Note A-3.8.3.6.(6) and (7).)

**8)** Except as provided in Sentence (9) and except for a door with a power door operator complying with Sentence (6), when unlatched, a door in a *barrier-free* path of travel shall open when the force applied to the handle, push plate or latch-releasing device is not more than

- a) 38 N in the case of an exterior swinging door,
- b) 22 N in the case of an interior swinging door, or
- c) 22 N in the case of a sliding door.

**9)** Sentence (8) does not apply to a door at the entrance to a *dwelling unit*, or where greater forces are required in order to close and latch the door against the prevailing difference in air pressure on opposite sides of the door. (See Note A-3.8.3.6.(9).)

**10)** Except for a door at the entrance to a *dwelling unit*, a closer for an interior door in a *barrier-free* path of travel shall have a closing period of not less than 3 s measured from when the door is in an open position of 70° to the doorway, to when the door reaches a point 75 mm from the closed position, measured from the leading edge of the latch side of the door. (See Note A-3.8.3.6.(10).)

**11)** Unless equipped with a power door operator complying with Sentence (6), a swinging door in a *barrier-free* path of travel shall have a clear space on the latch side extending the height of the doorway and not less than

- a) 600 mm beyond the edge of the door opening if the door swings toward the approach side, and
- b) 300 mm beyond the edge of the door opening if the door swings away from the approach side.

(See Note A-3.8.3.6.(11).)

**12)** A vestibule located in a *barrier-free* path of travel shall be arranged to allow the movement of wheelchairs between doors and shall provide a distance between 2 doors in series of not less than 1 200 mm plus the width of any door that swings into the space in the path of travel from one door to another.

**13)** Only the active leaf in a multiple-leaf door in a *barrier-free* path of travel need conform to the requirements of this Article.

**14)** Except as provided in Clause 3.8.3.5.(1)(c), the floor surface on each side of a door in a *barrier-free* path of travel shall be level within a rectangular area

- a) as wide as the door plus the clearance required on the latch side by Sentence (11), and
- b) whose dimension perpendicular to the closed door is not less than the width of the *barrier-free* path of travel but need not exceed 1 500 mm.

### 3.8.3.7. Passenger-Elevating Devices

**1)** A passenger-elevating device referred to in Article 3.8.2.3. shall conform to CSA B355, "Lifts for Persons with Physical Disabilities."

**3.8.3.8. Controls**

- 1) Controls described in this Section shall
  - a) where located in or adjacent to a *barrier-free* path of travel, and unless otherwise stated,
    - i) be mounted 400 mm to 1 200 mm above the floor,
    - ii) be adjacent to and centered on either the length or the width of a clear floor space of 1 350 mm by 800 mm, and
  - b) be operable
    - i) with one hand in a closed fist position, without requiring tight grasping, pinching with fingers, or twisting of the wrist, and
    - ii) unless otherwise stated, with a force not more than 22 N.

**3.8.3.9. Accessibility Signs**

- 1) Signs required by Article 3.8.2.10. shall incorporate the International Symbol of Access or the International Symbol of Access for Hearing Loss and appropriate graphical or textual information that clearly indicates the type of facilities available. (See Note A-3.8.3.9.(1).)

**3.8.3.10. Drinking Fountains**

- 1) Drinking fountains required by Sentence 3.8.2.8.(9) shall
  - a) be located along a *barrier-free* path of travel,
  - b) have a minimum clear floor space of 800 mm by 1 350 mm in front of it,
  - c) where it has frontal access, provide a knee clearance in accordance with Clause 3.8.3.15.(1)(d),
  - d) have a spout that
    - i) is located near the front of the unit, at a height between 750 mm and 915 mm above the floor, and
    - ii) directs water flow in a trajectory that is nearly parallel to the front of the unit, at a height not less than 100 mm, and
  - e) be equipped with controls that
    - i) activate automatically, or
    - ii) are located either on the front or on both sides of it and comply with Clause 3.8.3.8.(1)(b).

**3.8.3.11. Water-Closet Stalls**

- 1) Water-closet stalls and enclosures required by Sentence 3.8.2.8.(5) shall
  - a) be not less than 1 500 mm wide by 1 500 mm deep,
  - b) have a clear floor space of 1 500 mm by 1 500 mm in front of the accessible stall,
  - c) be equipped with a door that
    - i) can be latched from the inside with a mechanism conforming to Clause 3.8.3.8.(1)(b),
    - ii) is aligned with either the transfer space adjacent to the water closet or with a clear floor space not less than 1 500 mm by 1 500 mm within the stall,
    - iii) provides a clear opening not less than 850 mm wide when it is open,
    - iv) is self-closing so that, when at rest, the door is ajar by not more than 50 mm beyond the jamb,
    - v) swings outward, unless there is sufficient floor space within the stall for the door to swing inward in addition to a clear floor space of at least 800 mm by 1 350 mm (see Note A-3.8.3.11.(1)(c)(v)),

- vi) where the door swings outward, is provided with a horizontal, D-shaped, visually contrasting door pull not less than 140 mm long located on the inside such that its midpoint is 200 mm to 300 mm from the hinged side of the door and 800 mm to 1 000 mm above the floor (see Note A-3.8.3.11.(1)(c)(vi)), and
- vii) is provided with a horizontal, D-shaped, visually contrasting door pull not less than 140 mm long located on the outside such that its midpoint is 120 mm to 220 mm from the latch side and 800 mm to 1 000 mm above the floor,
- d) have a water closet located so that the distance between the centre line of the fixture and the wall on one side is 460 mm to 480 mm,
- e) be equipped with an L-shaped grab bar that
  - i) is mounted on the side wall closest to the water closet,
  - ii) has horizontal and vertical components not less than 760 mm long mounted with the horizontal component 750 mm to 850 mm above the floor and the vertical component 150 mm in front of the water closet (see Note A-3.8.3.11.(1)(e)(ii)), and
  - iii) complies with Article 3.7.2.8.,
- f) be equipped with either one grab bar at least 600 mm long and centred over the water closet, or two grab bars at least 300 mm long and located either side of the flush valve, that
  - i) conform to Article 3.7.2.8.,
  - ii) are mounted on the rear wall, and
  - iii) are mounted at the same height as the grab bar on the side wall or 100 mm above the top of the attached water tank, if applicable,
- g) be equipped with a coat hook mounted not more than 1 200 mm above the floor on a side wall and projecting not more than 50 mm from the wall, and
- h) be equipped with a toilet paper dispenser mounted on the side wall closest to the water closet such that
  - i) the bottom of the dispenser is 600 mm to 800 mm above the floor, and
  - ii) the closest edge of the dispenser is 300 mm from the front of the water closet.

### 3.8.3.12. Universal Washrooms

(See Note A-3.8.3.12.)

- 1) A universal washroom shall
  - a) be served by a *barrier-free* path of travel,
  - b) have a door complying with Article 3.8.3.6. that
    - i) has a latch-operating mechanism located 900 mm to 1 000 mm above the floor that complies with Clause 3.8.3.8.(1)(b) and is capable of being locked from the inside, and released from the outside in case of emergency, and
    - ii) if it is an outward swinging door that is not self-closing, has a door pull not less than 140 mm long located on the inside so that its midpoint is not less than 200 mm and not more than 300 mm from the hinged side of the door and not less than 900 mm and not more than 1 000 mm above the floor (see Note A-3.8.3.11.(1)(c)(vi)),
  - c) have one lavatory conforming to Article 3.8.3.15.,
  - d) have one water closet conforming to Article 3.8.3.13. and Clause 3.8.3.11.(1)(d), with a clear floor space at least 900 mm wide that is parallel and adjacent to the open side of the water closet,
  - e) have grab bars conforming to Clauses 3.8.3.11.(1)(e) and (f),
  - f) have a coat hook conforming to Clause 3.8.3.11.(1)(g),
  - g) have a toilet paper dispenser conforming to Clause 3.8.3.11.(1)(h),

- h) unless a counter is provided, have a shelf located not more than 1 200 mm above the floor, and
- i) be designed to permit a wheelchair to turn in an open space not less than 1 500 mm in diameter.

### 3.8.3.13. Water Closets

- 1) A water closet for a person with physical disabilities shall
    - a) be equipped with a seat located 430 mm to 460 mm above the floor,
    - b) flush automatically or be equipped with a flushing control that
      - i) is located 500 mm to 900 mm above the floor,
      - ii) is located no more than 350 mm from the transfer side, and
      - iii) complies with Clause 3.8.3.8.(1)(b),
    - c) be equipped with a seat lid or other back support, and
    - d) where it has a tank, have a securely attached tank top.
- (See Note A-3.8.3.13.(1).)

### 3.8.3.14. Urinals

- 1) Urinals described in Sentence 3.8.2.8.(6) shall
  - a) be wall-mounted, with the opening of the basin located not more than 430 mm above the floor,
  - b) be adjacent to an accessible route,
  - c) have a clear width of approach of 800 mm centred on the urinal and unobstructed by privacy screens,
  - d) have no step in front of it,
  - e) have a flush control that
    - i) is automatic, or
    - ii) complies with Clause 3.8.3.8.(1)(b) and is located 900 mm to 1 100 mm above the floor, and
  - f) have a vertically mounted grab bar installed on each side that
    - i) complies with Article 3.7.2.8.,
    - ii) is not less than 600 mm long, with its centre line 1 000 mm above the floor, and
    - iii) is located not more than 380 mm from the centre line of the urinal.

### 3.8.3.15. Lavatories and Mirrors

- 1) Lavatories required by Sentence 3.8.2.8.(7) shall
    - a) be equipped with faucets complying with Sentence 3.7.2.3.(4),
    - b) be located so that the distance between the centre line of the lavatory and any side wall is not less than 460 mm,
    - c) have a rim height not more than 865 mm above the floor,
    - d) have a clearance beneath the lavatory not less than
      - i) 760 mm wide,
      - ii) 735 mm high at the front edge,
      - iii) 685 mm high at a point 200 mm back from the front edge, and
      - iv) 230 mm high over the distance from a point 280 mm to a point 430 mm back from the front edge,
- (see Note A-3.8.3.15.(1)(d))
- e) have insulated water supply and drain pipes where these pipes are exposed (see Note A-3.8.3.15.(1)(e)),
  - f) have a soap dispenser that
    - i) is automatic, or
    - ii) complies with Clause 3.8.3.8.(1)(b) and is located not more than 1 100 mm above the floor, within 500 mm from the front of the lavatory (see Note A-3.8.3.15.(1)(f)), and
  - g) have a towel dispenser or other hand-drying equipment located close to the lavatory, not more than 1 200 mm above the floor in an area that is accessible to persons in wheelchairs.

- 2)** Mirrors required by Sentence 3.8.2.8.(8) shall be
  - a) mounted with their bottom edge not more than 1 000 mm above the floor, or
  - b) fixed in an inclined position so as to be usable by a person in a wheelchair.

**3.8.3.16. Showers**

- 1)** Showers required by Sentence 3.8.2.8.(10) shall
  - a) be not less than 1 500 mm wide and 900 mm deep,
  - b) have a clear floor space at the entrance to the shower that is not less than 900 mm deep and the same width as the shower, except that fixtures are permitted to project into that space provided they do not restrict access to the shower (see Note A-3.8.3.16.(1)(b)),
  - c) have no doors or curtains that obstruct the controls or the clear floor space at the entrance to the shower,
  - d) have a slip-resistant floor surface,
  - e) have a threshold not more than 13 mm higher than the finished floor, and where it is higher than 6 mm, beveled to a slope no steeper than 1 in 2 (50%),
  - f) have 2 grab bars that
    - i) conform to Sentence 3.7.2.8.(1),
    - ii) one of which is not less than 1 000 mm long and located vertically on the side wall 50 mm to 80 mm from the adjacent clear floor space, with its lower end 600 mm to 650 mm above the floor, and,
    - iii) one of which is L-shaped and located on the wall opposite the entrance to the shower, with a horizontal member not less than 1 000 mm long mounted 750 mm to 870 mm above the floor and a vertical member not less than 750 mm long mounted 400 mm to 500 mm from the side wall on which the other vertical grab bar is mounted,
  - (see Note A-3.8.3.16.(1)(f)),
  - g) have a hinged seat that is not spring-loaded or a fixed seat with a smooth, slip-resistant surface and no rough edges, the seat being
    - i) not less than 450 mm wide and 400 mm deep,
    - ii) mounted on the same side wall as the vertical grab bar, at 460 mm to 480 mm above the floor, and
    - iii) designed to carry a minimum load of 1.3 kN,
  - h) have a pressure-equalizing or thermostatic-mixing valve and other controls that
    - i) comply with Clause 3.8.3.8.(1)(b),
    - ii) are mounted on the wall opposite the entrance to the shower at not more than 1 200 mm above the floor and within reach of the seat,
  - i) have a hand-held shower head with not less than 1 800 mm of flexible hose located so that it
    - i) can be reached from a seated position,
    - ii) can be used in a fixed position at a height of 1 200 mm and 2 030 mm, and
    - iii) does not obstruct the use of the grab bars, and
  - j) have recessed soap holders that can be reached from the seated position.

**3.8.3.17. Bathtubs**

- 1)** Bathtubs required by Sentence 3.8.2.8.(11) shall
  - a) be located in a room with a clear floor space not less than 1 500 mm in diameter,
  - b) be not less than 1 500 mm long,
  - c) have a clear floor space not less than 750 mm wide adjacent to its entire length,
  - d) be capable of being accessed along its full length with no tracks mounted on its rim,

- e) have faucets and other controls that
  - i) conform to Clause 3.8.3.8.(1)(b), and
  - ii) are located on the centre line or between the centre line of the bathtub and the exterior edge of the bathtub rim, at a maximum height of 450 mm above the rim,
- f) have three grab bars
  - i) that conform to Sentence 3.7.2.8.(1),
  - ii) that are not less than 1 200 mm long,
  - iii) two of which are located vertically at each end of the bathtub, set 80 mm to 120 mm in from the outside edge of the bathtub, with their lower end 180 mm to 280 mm above the bathtub rim, and
  - iv) one of which is located horizontally along the length of the bathtub at 180 mm to 280 mm above the bathtub rim,
- g) have a slip-resistant bottom surface, and
- h) be equipped with a hand-held shower head with not less than 1 800 mm of flexible hose that can be used in a fixed position at a height of 1 200 mm and 2 030 mm.

### 3.8.3.18. Assistive Listening Devices

(See Note A-3.8.3.18.)

- 1) Except as provided in Sentence (2), assistive listening systems required by Article 3.8.2.9. shall encompass the entire seating area.
- 2) If an assistive listening system referred to in Article 3.8.2.9. is an induction loop system, only half the seating area in the room need be encompassed.

### 3.8.3.19. Counters

- 1) Counters required by Sentence 3.8.2.11.(1) shall have
  - a) at least one *barrier-free* section not less than 760 mm long centred over a knee space conforming to Clause (c),
  - b) a surface not more than 865 mm above the floor, and
  - c) except as provided in Sentence (2) and where the counter is intended to be used as a work surface, a knee space underneath it that is
    - i) not less than 760 mm wide,
    - ii) not less than 685 mm high, and
    - iii) not less than 485 mm deep.
- 2) A counter that is used in a cafeteria, or one that performs a similar function whereat movement takes place parallel to the counter, need not provide a knee space underneath it.

### 3.8.3.20. Shelves or Counters for Telephones

(See Note A-3.8.3.20.)

- 1) Shelves or counters required by Sentence 3.8.2.11.(2) shall
  - a) be level,
  - b) be not less than 305 mm deep,
  - c) have, for each telephone provided, a clear space not less than 250 mm wide having no obstruction within 250 mm above the surface, and
  - d) have a section with a surface not more than 865 mm above the floor serving at least one telephone.
- 2) Where a wall-hung telephone is provided above the shelf or counter section described in Clause (1)(d), it shall be located so that the receiver and coin slot are not more than 1 200 mm above the floor.

### 3.8.3.21. Spaces in Seating Area

- 1) Spaces designated for wheelchair use referred to in Sentence 3.8.2.3.(3) shall be
  - a) clear and level, or level with removable seats,



- b) not less than 900 mm wide and 1 525 mm long to permit a wheelchair to enter from a side approach and 1 220 mm long where the wheelchair enters from the front or rear of the space,
- c) arranged so that at least 2 designated spaces are side by side,
- d) located adjoining a *barrier-free* path of travel without infringing on egress from any row of seating or any aisle requirements, and
- e) situated, as part of the designated seating plan, to provide a choice of viewing location and a clear view of the event taking place.

## Section 3.9. Self-service Storage Buildings

### 3.9.1. General

#### 3.9.1.1. Definition

1) For the purpose of this Section, the term “self-service storage *building*” shall mean a *building* that is open to the public for the sole purpose of providing individual self-service storage units.

#### 3.9.1.2. Application

- 1) This Section applies to self-service storage *buildings* that
  - a) are not more than one *storey* in *building height*,
  - b) do not contain a *basement* or *mezzanine*,
  - c) consist of individual self-service storage units with external access only,
  - d) are used for no purpose other than storage, and
  - e) except as provided in Sentences 3.9.3.1.(2) and (4), contain no other *major occupancy*.
- 2) Where there is a conflict between the requirements of this Section and other requirements in Part 3, this Section shall govern.
- 3) The requirements in Part 3 regarding *occupant load* shall not apply to self-service storage *buildings*.

#### 3.9.1.3. Occupancy Classification

1) Self-service storage *buildings* shall be classified as Group F, Division 2 *major occupancies*.

### 3.9.2. Building Fire Safety

#### 3.9.2.1. Building Area

1) For the purpose of applying the requirements of Subsections 3.2.1. and 3.2.2. to self-service storage *buildings*, *building area* shall mean

- a) the *building area* of each *building*, or
- b) the total of the *building areas* of all *buildings* as a group.

(See Note A-3.9.2.1.(1).)

#### 3.9.2.2. Spatial Separation

(See Note A-3.9.2.2.)

- 1) Except as provided in Sentence (3), the spatial separation requirements in Subsection 3.2.3. shall apply to self-service storage *buildings*.
- 2) The distance between each group of self-service storage *buildings* shall be not less than 9 m.
- 3) Subsection 3.2.3. need not apply between *buildings* within a group of self-service storage *buildings*, where the distance between these *buildings* is at least 6 m.

**3.9.2.3. Access Route**

1) Where Clause 3.9.2.1.(1)(b) is applied to a group of *buildings*, Article 3.2.5.4. and Sentence 3.2.5.5.(1) shall apply to that group of *buildings* as if they were a single *building*.

**3.9.3. Floor Areas**

**3.9.3.1. Safety Requirements Within Floor Areas**

1) Except as provided in Sentences (2) to (6), the requirements of Section 3.3. shall apply. (See Note A-3.9.3.1.(1).)

2) Not more than one *dwelling unit* is permitted to be contained within one of the self-service storage *buildings* on a property.

3) A *dwelling unit* referred to in Sentence (2) shall be separated from individual self-service storage units by a *fire separation* having a *fire-resistance rating* not less than 2 h.

4) Where an office not more than 50 m<sup>2</sup> in area is adjacent to a *dwelling unit* referred to in Sentence (2), it shall be considered as part of the *dwelling unit*.

5) *Fire separations* required by Sentences 3.3.1.1.(1) and 3.3.5.9.(1) need not be provided between individual self-service storage units.

- 6) The *floor area* of self-service storage *buildings* shall be
- a) subdivided into compartments not more than 500 m<sup>2</sup> in area by a *fire separation* having a *fire-resistance rating* not less than 1 h, or
  - b) *sprinklered*.

(See also Sentence 3.4.6.12.(2) for the exemption applying to *exit* doors of individual self-service storage units.)

**3.9.3.2. Sanitary Facilities**

1) Except as provided in Sentence 3.7.2.1.(1), two public washrooms, each containing a water closet and a lavatory, shall be provided within one of the self-service storage *buildings* on the property. (See Note A-3.9.3.2.(1).)

**Section 3.10. Objectives and Functional Statements**

**3.10.1. Objectives and Functional Statements**

**3.10.1.1. Attributions to Acceptable Solutions**

1) For the purpose of compliance with this Code as required in Clause 1.2.1.1.(1)(b) of Division A, the objectives and functional statements attributed to the acceptable solutions in this Part shall be the objectives and functional statements listed in Table 3.10.1.1. (See Note A-1.1.2.1.(1).)

Table 3.10.1.1.

Objectives and Functional Statements Attributed to the Acceptable Solutions in Part 3 Forming Part of Sentence 3.10.1.1.(1)

Functional Statements and Objectives <sup>(1)</sup>	
<b>3.1.3.1. Separation of Major Occupancies</b>	
(1)	[F03-OS1.2] [F03-OP1.2]
(2)	[F03-OS1.2]
(3)	[F02,F03,F06-OS1.2] [F10,F05-OS1.5] [F02,F03,F06-OP1.2]

Table 3.10.1.1. (Continued)

Functional Statements and Objectives <sup>(1)</sup>	
<b>3.1.3.2. Prohibition of Occupancy Combinations</b>	
(1)	[F02,F03-OS1.2] [F10-OS1.5]
(2)	[F02,F03-OS1.2]
(3)	[F02,F03-OS1.2]
(4)	[F02,F03-OS1.2]
<b>3.1.4.1. Combustible Materials Permitted</b>	
(2)	[F02-OS1.2] [F02-OP1.2]

**Table 3.10.1.1. (Continued)**

Functional Statements and Objectives <sup>(1)</sup>	
<b>3.1.4.2. Protection of Foamed Plastics</b>	
(1)	[F01-OS1.1] [F02-OS1.2]
	[F01-OP1.1] [F02-OP1.2]
(2)	[F01-OS1.1] [F02-OS1.2]
	[F01-OP1.1] [F02-OP1.2]
<b>3.1.4.3. Wires and Cables</b>	
(1)	[F02-OS1.2]
	[F02-OP1.2]
(2)	[F02-OS1.2]
	[F02-OP1.2]
(3)	[F02-OS1.2]
	[F02-OP1.2]
<b>3.1.4.5. Fire-Retardant-Treated Wood</b>	
(1)	[F02-OS1.2]
	[F02-OP1.2]
<b>3.1.4.8. Exterior Cladding</b>	
(1)	[F03,F02-OP3.1]
<b>3.1.5.1. Noncombustible Materials</b>	
(1)	[F02-OS1.2]
	[F02-OP1.2]
<b>3.1.5.5. Combustible Cladding on Exterior Walls</b>	
(2)	[F03,F02-OP3.1]
<b>3.1.5.21. Wires and Cables</b>	
(2)	[F02-OS1.2]
	[F02-OP1.2]
(3)	[F02-OS1.2]
	[F02-OP1.2]
<b>3.1.5.23. Non-metallic Raceways</b>	
(1)	[F02-OS1.2]
	[F02-OP1.2]
(2)	[F02-OS1.2]
	[F02-OP1.2]
<b>3.1.6.2. Restrictions</b>	
(1)	[F10,F12,F36-OS3.7]
	[F20-OS2.2]
(2)	[F10,F36-OS3.7] Applies to portion of Code text: "An <i>air-supported structure</i> shall not be used for Groups B, C, ... <i>major occupancies</i> or for classrooms."
	[F01,F02,F36-OS1.5] Applies to portion of Code text: "An <i>air-supported structure</i> shall not be used for ... Group F, Division 1 <i>major occupancies</i> ..."
(3)	[F10-OS3.7]

**Table 3.10.1.1. (Continued)**

Functional Statements and Objectives <sup>(1)</sup>	
<b>3.1.6.3. Clearance to Other Structures</b>	
(2)	(a) [F03-OS1.2]
	(b) [F10-OS3.7]
	(a) [F03-OP3.1]
<b>3.1.6.4. Clearance to Flammable Material</b>	
(1)	[F01-OS1.1] [F03-OS1.2]
	[F01-OP1.1] [F03-OP1.2]
<b>3.1.6.5. Flame Resistance</b>	
(1)	[F02-OS1.2]
<b>3.1.6.6. Emergency Air Supply</b>	
(1)	[F20-OS3.7]
<b>3.1.6.7. Electrical Systems</b>	
(1)	[F34-OP1.1]
	[F34-OS3.3]
	[F34-OS1.1]
(2)	[F81-OP1.1]
	[F81-OS1.1]
<b>3.1.7.1. Determination of Ratings</b>	
(1)	[F03-OS1.2] [F04-OS1.3]
	[F03-OP1.2] [F04-OP1.3]
<b>3.1.7.5. Rating of Supporting Construction</b>	
(1)	[F04-OS1.3]
	[F04-OP1.3]
(3)	[F04-OS1.3]
	[F04-OP1.3]
<b>3.1.8.1. General Requirements</b>	
(1)	(a) [F03-OS1.2]
	(a) [F03-OP1.2]
(2)	[F03-OS1.2] Applies to the requirement that openings in <i>fire separations</i> be protected with <i>closures</i> , shafts or other means.
	[F03-OP1.2] Applies to the requirement that openings in <i>fire separations</i> be protected with <i>closures</i> , shafts or other means.
<b>3.1.8.2. Combustible Construction Support</b>	
(1)	[F04-OS1.2]
	[F04-OP1.2]
<b>3.1.8.3. Continuity of Fire Separations</b>	
(1)	[F03-OS1.2]
	[F03-OP1.2]
(2)	[F03-OS1.2]
	[F03-OP1.2]
(3)	(a) [F03-OS1.2]
	(a) [F03-OP1.2]
	(b) [F03-OS1.2]
	(b) [F03-OP1.2]

Copyright © NRC 1941 - 2021 World Rights Reserved © CNRC 1941-2021 Droits réservés pour tous pays

Table 3.10.1.1. (Continued)

Functional Statements and Objectives <sup>(1)</sup>	
(4)	[F03-OS1.2]
	[F03-OP1.2]
<b>3.1.8.4. Determination of Ratings and Classifications</b>	
(1)	[F03-OS1.2]
	[F03-OP1.2]
(2)	[F03-OS1.2]
	[F03-OP1.2]
(3)	[F03-OS1.2]
	[F03-OP1.2]
(4)	[F03-OS1.2]
	[F03-OP1.2]
<b>3.1.8.5. Installation of Closures</b>	
(2)	[F03-OS1.2]
	[F03-OP1.2]
(3)	[F03-OS1.2]
	[F03-OP1.2]
(4)	[F81-OS1.2]
	[F81-OP1.2]
(5)	[F81-OP1.2]
	[F81-OS1.2]
(6)	[F03-OS1.2]
	[F03-OP1.2]
(7)	[F03-OS1.2]
	[F03-OP1.2]
<b>3.1.8.6. Maximum Openings</b>	
(1)	[F03-OS1.2]
	[F03-OP1.2]
(2)	[F03-OS1.2]
	[F03-OP1.2]
<b>3.1.8.7. Location of Fire Dampers and Smoke Dampers</b>	
(1)	[F03-OS1.2]
	[F03-OP1.2]
(2)	[F03-OS1.2]
	[F03-OP1.2]
<b>3.1.8.10. Installation of Fire Dampers</b>	
(1)	[F04-OS1.2]
	[F04-OP1.2]
(2)	[F03-OS1.2]
	[F03-OP1.2]
(3)	[F03-OS1.2]
	[F03-OP1.2]
(4)	[F03-OS1.2]
	[F03-OP1.2]

Table 3.10.1.1. (Continued)

Functional Statements and Objectives <sup>(1)</sup>	
(5)	[F82-OS1.2] Applies to portion of Code text: "A tightly fitted access door shall be installed for each <i>fire damper</i> to provide access for the inspection of the damper ..."
	[F82-OP1.2] Applies to portion of Code text: "A tightly fitted access door shall be installed for each <i>fire damper</i> to provide access for the inspection of the damper ..."
	[F82-OH1.2] Applies to portion of Code text: "A tightly fitted access door shall be installed for each <i>fire damper</i> to provide access for ... the resetting of the release device."
<b>3.1.8.11. Installation of Smoke Dampers</b>	
(1)	[F03-OS1.2]
	[F03-OP1.2]
(2)	[F03-OS1.2]
	[F03-OP1.2]
(3)	[F03-OS1.2]
	[F03-OP1.2]
(4)	[F03-OS1.2]
	[F03-OP1.2]
(5)	[F82-OS1.2] Applies to portion of Code text: "A tightly fitted access door shall be installed for each smoke damper to provide access for the inspection of the damper ..."
	[F82-OH1.2] Applies to portion of Code text: "A tightly fitted access door shall be installed for each smoke damper to provide access for the inspection of the damper ..."
	[F82-OP1.2] Applies to portion of Code text: "A tightly fitted access door shall be installed for each fire damper to provide access for the ... resetting of the release device."
<b>3.1.8.12. Twenty-Minute Closures</b>	
(3)	[F03-OS1.2]
	[F03-OP1.2]
<b>3.1.8.13. Self-closing Devices</b>	
(1)	[F03-OS1.2]
	[F03-OP1.2]
<b>3.1.8.14. Hold-Open Devices</b>	
(1)	[F03-OS1.2]
(2)	[F03-OS1.2]
	[F03-OP1.2]
(3)	[F03-OS1.2]
	[F03-OP1.2]
(4)	[F03-OS1.2]
	[F03-OP1.2]
(5)	[F03-OS1.2]
	[F03-OP1.2]
(6)	[F03-OS1.2]
	[F03-OP1.2]

**Table 3.10.1.1. (Continued)**

Functional Statements and Objectives <sup>(1)</sup>	
<b>3.1.8.15. Door Latches</b>	
(1)	[F03-OS1.2]
	[F03-OP1.2]
<b>3.1.8.16. Wired Glass and Glass Block</b>	
(3)	[F04-OS1.2] Applies to portion of Code text: "Glass blocks permitted by Sentence (1) shall be ... reinforced with steel reinforcement in each horizontal joint."
	[F04-OP1.2] Applies to portion of Code text: "Glass blocks permitted by Sentence (1) shall be ... reinforced with steel reinforcement in each horizontal joint."
<b>3.1.8.17. Temperature Rise Limit for Doors</b>	
(1)	[F03,F31-OS1.2] [F05-OS1.5]
	[F03-OP1.2]
<b>3.1.8.18. Area Limits for Wired Glass and Glass Block</b>	
(1)	[F05-OS1.5] [F31-OS1.2]
	[F30-OS3.1]
(2)	[F05-OS1.5] [F31-OS1.2]
<b>3.1.9.1. Fire Stops</b>	
(1)	[F03-OS1.2] [F04-OS1.3]
	[F03-OP1.2] [F04-OP1.3]
(2)	[F03-OS1.2]
	[F03-OP3.1]
	[F03-OP1.2]
(3)	[F03-OS1.2]
	[F03-OP1.2]
<b>3.1.9.2. Combustibility of Service Penetrations</b>	
(1)	[F03-OS1.2] [F02,F04-OS1.3] Applies to portion of Code text: "Except as permitted by Articles 3.1.9.3. and 3.1.9.5., pipes, ducts, electrical outlet boxes, totally enclosed raceways or other similar service equipment that penetrate an assembly required to have a <i>fire-resistance rating</i> shall be <i>noncombustible</i> ..."
	[F03-OP1.2] [F02,F04-OP1.3] Applies to portion of Code text: "Except as permitted by Articles 3.1.9.3. and 3.1.9.5., pipes, ducts, electrical outlet boxes, totally enclosed raceways or other similar service equipment that penetrate an assembly required to have a <i>fire-resistance rating</i> shall be <i>noncombustible</i> ..."
<b>3.1.9.4. Penetration by Outlet Boxes</b>	
(1)	[F03-OS1.2]
	[F03-OP1.2]
(3)	[F03-OS1.2]
	[F03-OP1.2]
<b>3.1.9.5. Combustible Piping Penetrations</b>	
(3)	[F03-OS1.2] [F02,F04-OS1.3]
	[F03-OP1.2] [F02,F04-OP1.3]

**Table 3.10.1.1. (Continued)**

Functional Statements and Objectives <sup>(1)</sup>	
<b>3.1.9.6. Openings through a Membrane Ceiling</b>	
(1)	[F04-OS1.3]
	[F04-OP1.3]
<b>3.1.10.1. Prevention of Firewall Collapse</b>	
(1)	[F04-OP1.2]
	[F04-OS1.2]
	[F04-OP3.1]
(2)	[F03,F04-OP1.2]
	[F03,F04-OS1.2]
	[F03,F04-OP3.1]
(4)	[F04-OS1.2]
	[F04-OP1.2]
	[F04-OP3.1]
<b>3.1.10.2. Rating of Firewalls</b>	
(1)	[F03-OS1.2] Applies to portion of Code text: "A <i>firewall</i> that separates a <i>building</i> or <i>buildings</i> with <i>floor areas</i> containing a Group E or a Group F, Division 1 or 2 <i>major occupancy</i> shall be constructed as a <i>fire separation of noncombustible construction</i> having a <i>fire-resistance rating</i> not less than 4 h ..."
	[F03-OP1.2] Applies to portion of Code text: "A <i>firewall</i> that separates a <i>building</i> or <i>buildings</i> with <i>floor areas</i> containing a Group E or a Group F, Division 1 or 2 <i>major occupancy</i> shall be constructed as a <i>fire separation of noncombustible construction</i> having a <i>fire-resistance rating</i> not less than 4 h ..."
	[F03-OP3.1] Applies to portion of Code text: "A <i>firewall</i> that separates a <i>building</i> or <i>buildings</i> with <i>floor areas</i> containing a Group E or a Group F, Division 1 or 2 <i>major occupancy</i> shall be constructed as a <i>fire separation of noncombustible construction</i> having a <i>fire-resistance rating</i> not less than 4 h ..."
(2)	[F03-OS1.2]
	[F03-OP1.2]
	[F03-OP3.1]
(3)	[F80,F04-OP1.2]
	[F80,F04-OS1.2]
	[F80,F04-OP1.3]
(4)	[F80,F04-OP1.2]
	[F80,F04-OS1.2]
	[F80,F04-OP3.1]
<b>3.1.10.3. Continuity of Firewalls</b>	
(1)	[F03-OS1.2] Applies to portion of Code text: "A <i>firewall</i> shall extend from the ground continuously through, or adjacent to, all <i>storeys</i> of a <i>building</i> or <i>buildings</i> so separated ..."
	[F03-OP1.2] Applies to portion of Code text: "A <i>firewall</i> shall extend from the ground continuously through, or adjacent to, all <i>storeys</i> of a <i>building</i> or <i>buildings</i> so separated ..."
	[F03-OP3.1] Applies to portion of Code text: "A <i>firewall</i> shall extend from the ground continuously through, or adjacent to, all <i>storeys</i> of a <i>building</i> or <i>buildings</i> so separated ..."

Table 3.10.1.1. (Continued)

Functional Statements and Objectives <sup>(1)</sup>	
<b>3.1.10.4. Parapets</b>	
(1)	[F03-OP1.2]
	[F03-OS1.2]
	[F03-OP3.1]
<b>3.1.10.5. Maximum Openings</b>	
(1)	[F03-OP1.2] Applies to portion of Code text: "... the aggregate width of openings shall be not more than 25% of the entire length of the <i>firewall</i> ."
	[F03-OS1.2] Applies to portion of Code text: "... the aggregate width of openings shall be not more than 25% of the entire length of the <i>firewall</i> ."
	[F03-OP3.1] Applies to portion of Code text: "... the aggregate width of openings shall be not more than 25% of the entire length of the <i>firewall</i> ."
<b>3.1.10.7. Combustible Projections</b>	
(1)	[F03-OP1.2] Applies to portion of Code text: " <i>Combustible</i> material shall not extend across the end of a <i>firewall</i> ..."
	[F03-OS1.2] Applies to portion of Code text: " <i>Combustible</i> material shall not extend across the end of a <i>firewall</i> ..."
	[F03-OP3.1] Applies to portion of Code text: " <i>Combustible</i> material shall not extend across the end of a <i>firewall</i> ..."
(2)	[F03-OS1.2]
	[F03-OP1.2]
	[F03-OP3.1]
<b>3.1.11.1. Separation of Concealed Spaces</b>	
(1)	[F03-OS1.2]
	[F03-OP1.2]
<b>3.1.11.2. Fire Blocks in Wall Assemblies</b>	
(1)	[F03-OS1.2]
	[F03-OP1.2]
<b>3.1.11.3. Fire Blocks between Nailing and Supporting Elements</b>	
(1)	[F03-OS1.2]
	[F03-OP1.2]
(2)	[F03-OS1.2]
	[F03-OP1.2]
<b>3.1.11.4. Fire Blocks between Vertical and Horizontal Spaces</b>	
(1)	[F03-OS1.2]
	[F03-OP1.2]
<b>3.1.11.5. Fire Blocks in Horizontal Concealed Spaces</b>	
(1)	[F03,F04-OS1.2]
	[F03,F04-OP1.2]
(2)	[F03,F04-OS1.2]
	[F03,F04-OP1.2]
(3)	[F02,F03-OP1.2] [F04-OP1.3]

Table 3.10.1.1. (Continued)

Functional Statements and Objectives <sup>(1)</sup>	
<b>3.1.11.6. Fire Blocks in Crawl Spaces</b>	
(1)	[F03,F04-OS1.2]
	[F03,F04-OP1.2]
<b>3.1.11.7. Fire Block Materials</b>	
(1)	[F04-OS1.2]
	[F04-OP1.2]
(5)	[F04-OP1.2]
	[F04-OS1.2]
(6)	[F03-OP1.2]
	[F03-OS1.2]
<b>3.1.12.1. Determination of Ratings</b>	
(1)	[F02-OS1.2]
	[F02-OP1.2]
(2)	[F02-OS1.2]
	[F02-OP1.2]
<b>3.1.13.2. Flame-Spread Rating</b>	
(1)	[F02-OS1.2]
	[F02-OP1.2]
<b>3.1.13.5. Skylights</b>	
(1)	[F02-OS1.5]
<b>3.1.13.6. Corridors</b>	
(1)	[F02-OS1.2,OS1.5]
	[F02-OP1.2]
(5)	[F02-OS1.2,OS1.5]
	[F02-OP1.2]
(6)	[F02-OS1.2]
	[F02-OP1.2]
<b>3.1.13.7. High Buildings</b>	
(1)	[F02-OS1.2]
	[F02-OP1.2]
<b>3.1.13.9. Underground Walkways</b>	
(1)	[F02-OS1.2]
	[F02-OP3.1]
<b>3.1.13.10. Exterior Exit Passageway</b>	
(1)	[F02-OS1.5]
<b>3.1.13.11. Elevator Cars</b>	
(1)	[F02-OS1.2]
	[F02-OP1.2]
(2)	[F02-OS1.2]
	[F02-OP1.2]
<b>3.1.14.1. Fire-Retardant-Treated Wood Roof Systems</b>	
(1)	[F02-OS1.2]
	[F02-OP1.2]

**Table 3.10.1.1. (Continued)**

Functional Statements and Objectives <sup>(1)</sup>	
(2)	[F02-OS1.3,OS1.2] [F02-OP1.3]
<b>3.1.14.2. Metal Roof Deck Assemblies</b>	
(1)	[F02-OS1.2] [F02-OP1.2]
<b>3.1.15.1. Roof Covering Classification</b>	
(1)	[F02-OS1.2] [F02-OP1.2] [F02-OP3.1]
<b>3.1.15.2. Roof Coverings</b>	
(1)	[F02-OS1.2] [F02-OP1.2] [F02-OP3.1]
(3)	[F02-OS1.2] [F02-OP1.2] [F02-OP3.1]
<b>3.1.16.1. Fabric Canopies and Marquees</b>	
(1)	[F02-OS1.2,OS1.5] [F02-OP1.2]
<b>3.1.17.1. Occupant Load Determination</b>	
(1)	[F10-OS3.7] [F72-OH2.1] [F71-OH2.3]
(2)	[F10-OS3.7] [F72-OH2.1] [F71-OH2.3]
(4)	[F10-OS3.7] [F72-OH2.1] [F71-OH2.3]
<b>3.2.1.2. Storage Garage Considered as a Separate Building</b>	
(1)	[F03-OS1.2] [F03-OP1.2]
(2)	[F03-OS1.2] [F03-OP1.2]
(3)	[F03-OS1.2] [F03-OP1.2]
<b>3.2.1.4. Floor Assembly over Basement</b>	
(1)	[F03-OS1.2] [F04-OS1.3] [F03-OP1.2] [F04-OP1.3]
(2)	[F04-OS1.2,OS1.3] [F04-OP1.2,OP1.3]
<b>3.2.1.5. Fire Containment in Basements</b>	
(1)	[F02-OS1.2,OS1.3] [F02-OP1.2,OP1.3]

**Table 3.10.1.1. (Continued)**

Functional Statements and Objectives <sup>(1)</sup>	
<b>3.2.2.2. Special and Unusual Structures</b>	
(1)	[F02,F03,F04-OS1.2,OS1.3] [F02,F03,F04-OP1.2,OP1.3]
<b>3.2.2.6. Multiple Major Occupancies</b>	
(1)	[F02,F03,F04-OS1.2,OS1.3] [F02,F03,F04-OP1.2,OP1.3]
<b>3.2.2.7. Superimposed Major Occupancies</b>	
(3)	[F04-OS1.3] [F04-OP1.3]
(4)	[F04-OS1.3] [F04-OP1.3]
<b>3.2.2.10. Streets</b>	
(1)	[F12-OS1.2,OS1.5] [F12-OP1.2]
<b>3.2.2.15. Storeys below Ground</b>	
(2)	(a) [F02,F04-OS1.2,OS1.3] (a) [F02,F04-OP1.2,OP1.3] (b),(c) [F03-OS1.2] [F04-OS1.2,OS1.3] (b),(c) [F03-OP1.2] [F04-OP1.2,OP1.3]
<b>3.2.2.18. Automatic Sprinkler System Required</b>	
(2)	[F02,F04-OS1.2,OS1.3] [F02,F04-OP1.2,OP1.3]
<b>3.2.2.20. Group A, Division 1, Any Height, Any Area, Sprinklered</b>	
(2)	[F02-OS1.2] Applies to portion of Code text: "... the <i>building</i> referred to in Sentence (1) shall be of <i>noncombustible construction</i> ..." [F02-OP1.2] Applies to portion of Code text: "... the <i>building</i> referred to in Sentence (1) shall be of <i>noncombustible construction</i> ..." [F02,F04-OS1.2,OS1.3] Applies to portion of Code text: "... a ... the <i>building</i> shall be <i>sprinklered</i> throughout ..." [F02,F04-OP1.2,OP1.3] Applies to portion of Code text: "... a ... the <i>building</i> shall be <i>sprinklered</i> throughout ..." (b),(d) [F03-OS1.2] [F04-OS1.2,OS1.3] (b),(d) [F03-OP1.2] [F04-OP1.2,OP1.3] (c),(d) [F04-OS1.3] (c),(d) [F04-OP1.3]
<b>3.2.2.21. Group A, Division 1, One Storey, Limited Area, Sprinklered</b>	
(1)	[F02,F04-OS1.2,OS1.3] Applies to portion of Code text: "... a ... the <i>building</i> is <i>sprinklered</i> throughout ..." [F02,F04-OP1.2,OP1.3] Applies to portion of Code text: "... a ... the <i>building</i> is <i>sprinklered</i> throughout ..."

Table 3.10.1.1. (Continued)

Functional Statements and Objectives <sup>(1)</sup>	
(2)	[F02-OS1.2] Applies to portion of Code text: “The <i>building</i> referred to in Sentence (1) is permitted to be of <i>heavy timber construction</i> or <i>noncombustible construction</i> used singly or in combination ...”
	[F02-OP1.2] Applies to portion of Code text: “The <i>building</i> referred to in Sentence (1) is permitted to be of <i>heavy timber construction</i> or <i>noncombustible construction</i> used singly or in combination ...”
	[F03-OS1.2] [F04-OS1.2,OS1.3] Applies to portion of Code text: “... (a) floor assemblies shall be <i>fire separations</i> ... (i) with a <i>fire-resistance rating</i> not less than 45 min ...” and to Clause (b).
	[F03-OP1.2] [F04-OP1.2,OP1.3] Applies to portion of Code text: “... (a) floor assemblies shall be <i>fire separations</i> ... (i) with a <i>fire-resistance rating</i> not less than 45 min ...” and to Clause (b).
<b>3.2.2.22. Group A, Division 1, One Storey, Sprinklered</b>	
(1)	[F02,F04-OS1.2,OS1.3] Applies to portion of Code text: “... a) ... the <i>building</i> is <i>sprinklered</i> throughout ...”
	[F02,F04-OP1.2,OP1.3] Applies to portion of Code text: “... a) ... the <i>building</i> is <i>sprinklered</i> throughout ...”
(2)	[F03-OS1.2] [F04-OS1.2,OS1.3] Applies to portion of Code text: “... a) floor assemblies shall be <i>fire separations</i> with a <i>fire-resistance rating</i> not less than 45 min, ...” and to Clause (d).
	[F03-OP1.2] [F04-OP1.2,OP1.3] Applies to portion of Code text: “... a) floor assemblies shall be <i>fire separations</i> with a <i>fire-resistance rating</i> not less than 45 min, ...” and to Clause (d).
	(b),(c) [F04-OS1.3]
	(b),(c) [F04-OP1.3]
<b>3.2.2.23. Group A, Division 2, Any Height, Any Area, Sprinklered</b>	
(2)	[F02-OS1.2] Applies to portion of Code text: “... the <i>building</i> referred to in Sentence (1) shall be of <i>noncombustible construction</i> ...”
	[F02-OP1.2] Applies to portion of Code text: “... the <i>building</i> referred to in Sentence (1) shall be of <i>noncombustible construction</i> ...”
	[F02,F04-OS1.2,OS1.3] Applies to portion of Code text: “... a) ... the <i>building</i> shall be <i>sprinklered</i> throughout ...”
	[F02,F04-OP1.2,OP1.3] Applies to portion of Code text: “... a) ... the <i>building</i> shall be <i>sprinklered</i> throughout ...”
	(b),(d) [F03-OS1.2] [F04-OS1.2,OS1.3]
	(b),(d) [F03-OP1.2] [F04-OP1.2,OP1.3]
	(c),(d) [F04-OS1.3]
	(c),(d) [F04-OP1.3]
<b>3.2.2.24. Group A, Division 2, up to 6 Storeys, Any Area, Sprinklered</b>	
(1)	[F02,F04-OS1.2,OS1.3] Applies to portion of Code text: “... a) ... the <i>building</i> is <i>sprinklered</i> throughout ...”
	[F02,F04-OP1.2,OP1.3] Applies to portion of Code text: “... a) ... the <i>building</i> is <i>sprinklered</i> throughout ...”

Table 3.10.1.1. (Continued)

Functional Statements and Objectives <sup>(1)</sup>	
(2)	[F02-OS1.2] Applies to portion of Code text: “... the <i>building</i> referred to in Sentence (1) shall be of <i>noncombustible construction</i> ...”
	[F02-OP1.2] Applies to portion of Code text: “... the <i>building</i> referred to in Sentence (1) shall be of <i>noncombustible construction</i> ...”
	(a),(c) [F03-OS1.2] [F04-OS1.2,OS1.3]
	(a),(c) [F03-OP1.2] [F04-OP1.2,OP1.3]
	(b),(c) [F04-OS1.3]
	(b),(c) [F04-OP1.3]
<b>3.2.2.25. Group A, Division 2, up to 2 Storeys</b>	
(2)	[F04-OS1.3] Applies to portion of Code text: “... c) roof assemblies shall have, if of <i>combustible construction</i> , a <i>fire-resistance rating</i> not less than 45 min, ...” and to Clause (d).
	[F04-OP1.3] Applies to portion of Code text: “... c) roof assemblies shall have, if of <i>combustible construction</i> , a <i>fire-resistance rating</i> not less than 45 min, ...” and to Clause (d).
	(a) [F03-OS1.2] Applies to the requirement that <i>noncombustible</i> floor assemblies be <i>fire separations</i> .
	(a) [F03-OP1.2] Applies to the requirement that <i>noncombustible</i> floor assemblies be <i>fire separations</i> .
	(a),(d) [F03-OS1.2] [F04-OS1.2,OS1.3]
	(a),(d) [F03-OP1.2] [F04-OP1.2,OP1.3]
	(b),(d) [F04-OS1.3]
	(b),(d) [F04-OP1.3]
<b>3.2.2.26. Group A, Division 2, up to 2 Storeys, Increased Area, Sprinklered</b>	
(1)	[F02,F04-OS1.2,OS1.3] Applies to portion of Code text: “... a) ... the <i>building</i> is <i>sprinklered</i> throughout ...”
	[F02,F04-OP1.2,OP1.3] Applies to portion of Code text: “... a) ... the <i>building</i> is <i>sprinklered</i> throughout ...”
(2)	(a) [F03-OS1.2] Applies to the requirement that <i>noncombustible</i> floor assemblies be <i>fire separations</i> .
	(a) [F03-OP1.2] Applies to the requirement that <i>noncombustible</i> floor assemblies be <i>fire separations</i> .
	(a),(c) [F03-OS1.2] [F04-OS1.2,OS1.3]
	(a),(c) [F03-OP1.2] [F04-OP1.2,OP1.3]
	(b),(c) [F04-OS1.3]
	(b),(c) [F04-OP1.3]
<b>3.2.2.27. Group A, Division 2, up to 2 Storeys, Sprinklered</b>	
(1)	[F02,F04-OS1.2,OS1.3] Applies to portion of Code text: “... a) ... the <i>building</i> is <i>sprinklered</i> throughout ...”
	[F02,F04-OP1.2,OP1.3] Applies to portion of Code text: “... a) ... the <i>building</i> is <i>sprinklered</i> throughout ...”
<b>3.2.2.28. Group A, Division 2, One Storey</b>	
(2)	[F03-OP1.2]
	[F03-OS1.2]



**Table 3.10.1.1. (Continued)**

Functional Statements and Objectives <sup>(1)</sup>	
<b>3.2.2.29. Group A, Division 3, Any Height, Any Area, Sprinklered</b>	
(2)	[F02-OS1.2] Applies to portion of Code text: "... the <i>building</i> referred to in Sentence (1) shall be of <i>noncombustible construction</i> ..."
	[F02-OP1.2] Applies to portion of Code text: "... the <i>building</i> referred to in Sentence (1) shall be of <i>noncombustible construction</i> ..."
	[F02,F04-OS1.2,OS1.3] Applies to portion of Code text: "... a) ... the <i>building</i> shall be <i>sprinklered</i> throughout ..."
	[F02,F04-OP1.2,OP1.3] Applies to portion of Code text: "... a) ... the <i>building</i> shall be <i>sprinklered</i> throughout ..."
	(b),(d) [F03-OS1.2] [F04-OS1.2,OS1.3]
	(b),(d) [F03-OP1.2] [F04-OP1.2,OP1.3]
	(c),(d) [F04-OS1.3]
(c),(d) [F04-OP1.3]	
<b>3.2.2.30. Group A, Division 3, up to 2 Storeys</b>	
(2)	[F02-OS1.2] Applies to portion of Code text: "Except as permitted by Clauses (c) and (d), the <i>building</i> referred to in Sentence (1) shall be of <i>noncombustible construction</i> ..."
	[F02-OP1.2] Applies to portion of Code text: "Except as permitted by Clauses (c) and (d), the <i>building</i> referred to in Sentence (1) shall be of <i>noncombustible construction</i> ..."
	(a),(d) [F03-OS1.2] [F04-OS1.2,OS1.3]
	(a),(d) [F03-OP1.2] [F04-OP1.2,OP1.3]
	(b),(d) [F04-OS1.3]
	(b),(d) [F04-OP1.3]
	[F04-OS1.3] Applies to portion of Code text: "... c) roof assemblies shall ... (i) have a <i>fire-resistance rating</i> not less than 45 min, ..." and to Clause (d).
[F04-OP1.3] Applies to portion of Code text: "... c) roof assemblies shall (i) ... have a <i>fire-resistance rating</i> not less than 45 min, ..." and to Clause (d).	
(3)	[F02-OS1.2] [F04-OS1.3]
	[F02-OP1.2] [F04-OP1.3]
<b>3.2.2.31. Group A, Division 3, up to 2 Storeys, Sprinklered</b>	
(1)	[F02,F04-OS1.2,OS1.3] Applies to portion of Code text: "... a) ... the <i>building</i> is <i>sprinklered</i> throughout ..."
	[F02,F04-OP1.2,OP1.3] Applies to portion of Code text: "... a) ... the <i>building</i> is <i>sprinklered</i> throughout ..."
(2)	[F02-OS1.2] Applies to portion of Code text: "Except as permitted by Clause (c) ... the <i>building</i> referred to in Sentence (1) shall be of <i>noncombustible construction</i> ..."
	[F02-OP1.2] Applies to portion of Code text: "Except as permitted by Clause (c) ... the <i>building</i> referred to in Sentence (1) shall be of <i>noncombustible construction</i> ..."
	(a),(c) [F03-OS1.2] [F04-OS1.2,OS1.3]
	(a),(c) [F03-OP1.2] [F04-OP1.2,OP1.3]
	(b),(c) [F04-OS1.3]
	(b),(c) [F04-OP1.3]

**Table 3.10.1.1. (Continued)**

Functional Statements and Objectives <sup>(1)</sup>	
<b>3.2.2.32. Group A, Division 3, One Storey, Increased Area</b>	
(2)	(a),(c) [F04-OS1.3]
	(a),(c) [F04-OP1.3]
	[F04-OS1.3] Applies to portion of Code text: "... b) roof assemblies shall have, if of <i>combustible construction</i> , a <i>fire-resistance rating</i> not less than 45 min, ..." and to Clause (c).
	[F04-OP1.3] Applies to portion of Code text: "... b) roof assemblies shall have, if of <i>combustible construction</i> , a <i>fire-resistance rating</i> not less than 45 min, ..." and to Clause (c).
(3)	[F02-OS1.2] [F04-OS1.3]
	[F02-OP1.2] [F04-OP1.3]
<b>3.2.2.33. Group A, Division 3, One Storey, Sprinklered</b>	
(1)	[F02,F04-OS1.2,OS1.3] Applies to portion of Code text: "... a) ... the <i>building</i> is <i>sprinklered</i> throughout ..."
	[F02,F04-OP1.2,OP1.3] Applies to portion of Code text: "... a) ... the <i>building</i> is <i>sprinklered</i> throughout ..."
<b>3.2.2.35. Group A, Division 4</b>	
(1)	[F02-OS1.2] Applies to portion of Code text: "... a <i>building</i> classified as Group A, Division 4 shall be of <i>noncombustible construction</i> ."
	[F02-OP1.2] Applies to portion of Code text: "... a <i>building</i> classified as Group A, Division 4 shall be of <i>noncombustible construction</i> ."
(4)	[F02,F04-OS1.2,OS1.3]
	[F02,F04-OP1.2,OP1.3]
<b>3.2.2.36. Group B, Division 1, Any Height, Any Area, Sprinklered</b>	
(2)	[F02-OS1.2] Applies to portion of Code text: "... the <i>building</i> referred to in Sentence (1) shall be of <i>noncombustible construction</i> ..."
	[F02-OP1.2] Applies to portion of Code text: "... the <i>building</i> referred to in Sentence (1) shall be of <i>noncombustible construction</i> ..."
	[F02,F04-OS1.2,OS1.3] Applies to portion of Code text: "... a) ... the <i>building</i> shall be <i>sprinklered</i> throughout ..."
	[F02,F04-OP1.2,OP1.3] Applies to portion of Code text: "... a) ... the <i>building</i> shall be <i>sprinklered</i> throughout ..."
	(b),(d) [F03-OS1.2] [F04-OS1.2,OS1.3]
	(b),(d) [F03-OP1.2] [F04-OP1.2,OP1.3]
	(c),(d) [F04-OS1.3]
(c),(d) [F04-OP1.3]	
<b>3.2.2.37. Group B, Division 1, up to 3 Storeys, Sprinklered</b>	
(1)	[F02,F04-OS1.2,OS1.3] Applies to portion of Code text: "... a) ... the <i>building</i> is <i>sprinklered</i> throughout ..."
	[F02,F04-OP1.2,OP1.3] Applies to portion of Code text: "... a) ... the <i>building</i> is <i>sprinklered</i> throughout ..."

Table 3.10.1.1. (Continued)

Functional Statements and Objectives <sup>(1)</sup>		
(2)	[F02-OS1.2] Applies to portion of Code text: "... the <i>building</i> referred to in Sentence (1) shall be of <i>noncombustible construction</i> ..."	
	[F02-OP1.2] Applies to portion of Code text: "... the <i>building</i> referred to in Sentence (1) shall be of <i>noncombustible construction</i> ..."	
	(a),(c) [F03-OS1.2] [F04-OS1.2,OS1.3]	
	(a),(c) [F03-OP1.2] [F04-OP1.2,OP1.3]	
	(b),(c) [F04-OS1.3]	
<b>3.2.2.38. Group B, Division 2, Any Height, Any Area, Sprinklered</b>		
(2)	[F02-OS1.2] Applies to portion of Code text: "... the <i>building</i> referred to in Sentence (1) shall be of <i>noncombustible construction</i> ..."	
	[F02-OP1.2] Applies to portion of Code text: "... the <i>building</i> referred to in Sentence (1) shall be of <i>noncombustible construction</i> ..."	
	[F02,F04-OS1.2,OS1.3] Applies to portion of Code text: "... a) ... the <i>building</i> shall be <i>sprinklered</i> throughout ..."	
	[F02,F04-OP1.2,OP1.3] Applies to portion of Code text: "... a) ... the <i>building</i> shall be <i>sprinklered</i> throughout ..."	
	(b),(d) [F03-OS1.2] [F04-OS1.2,OS1.3]	
	(b),(d) [F03-OP1.2] [F04-OP1.2,OP1.3]	
	(c),(d) [F04-OS1.3]	
	(c),(d) [F04-OP1.3]	
	<b>3.2.2.39. Group B, Division 2, up to 3 Storeys, Sprinklered</b>	
	(1)	[F02,F04-OS1.2,OS1.3] Applies to portion of Code text: "... a) ... the <i>building</i> is <i>sprinklered</i> throughout ..."
[F02,F04-OP1.2,OP1.3] Applies to portion of Code text: "... a) ... the <i>building</i> is <i>sprinklered</i> throughout ..."		
(2)	[F02-OS1.2] Applies to portion of Code text: "... the <i>building</i> referred to in Sentence (1) shall be of <i>noncombustible construction</i> ..."	
	[F02-OP1.2] Applies to portion of Code text: "... the <i>building</i> referred to in Sentence (1) shall be of <i>noncombustible construction</i> ..."	
	(a),(c) [F03-OS1.2] [F04-OS1.2,OS1.3]	
	(a),(c) [F03-OP1.2] [F04-OP1.2,OP1.3]	
	(b),(c) [F04-OS1.3]	
	(b),(c) [F04-OP1.3]	
	<b>3.2.2.40. Group B, Division 2, up to 2 Storeys, Sprinklered</b>	
(1)	[F02,F04-OS1.2,OS1.3] Applies to portion of Code text: "... a) ... the <i>building</i> is <i>sprinklered</i> throughout ..."	
	[F02,F04-OP1.2,OP1.3] Applies to portion of Code text: "... a) ... the <i>building</i> is <i>sprinklered</i> throughout ..."	
(2)	(a),(c) [F03-OS1.2] [F04-OS1.2,OS1.3]	
	(a),(c) [F03-OP1.2] [F04-OP1.2,OP1.3]	
	(b),(c) [F04-OS1.3]	
	(b),(c) [F04-OP1.3]	

Table 3.10.1.1. (Continued)

Functional Statements and Objectives <sup>(1)</sup>		
<b>3.2.2.41. Group B, Division 2, One Storey, Sprinklered</b>		
(1)	[F02,F04-OS1.2,OS1.3] Applies to portion of Code text: "... a) ... the <i>building</i> is <i>sprinklered</i> throughout ..."	
	[F02,F04-OP1.2,OP1.3] Applies to portion of Code text: "... a) ... the <i>building</i> is <i>sprinklered</i> throughout ..."	
<b>3.2.2.42. Group B, Division 3, Any Height, Any Area, Sprinklered</b>		
(2)	[F02-OS1.2] Applies to portion of Code text: "... the <i>building</i> referred to in Sentence (1) shall be of <i>noncombustible construction</i> ..."	
	[F02-OP1.2] Applies to portion of Code text: "... the <i>building</i> referred to in Sentence (1) shall be of <i>noncombustible construction</i> ..."	
	[F02,F04-OS1.2,OS1.3] Applies to portion of Code text: "... a) ... the <i>building</i> shall be <i>sprinklered</i> throughout ..."	
	[F02,F04-OP1.2,OP1.3] Applies to portion of Code text: "... a) ... the <i>building</i> shall be <i>sprinklered</i> throughout ..."	
	(b),(d) [F03-OS1.2] [F04-OS1.2,OS1.3]	
	(b),(d) [F03-OP1.2] [F04-OP1.2,OP1.3]	
	(c),(d) [F04-OS1.3]	
	(c),(d) [F04-OP1.3]	
	<b>3.2.2.43. Group B, Division 3, up to 3 Storeys (Noncombustible), Sprinklered</b>	
	(1)	[F02,F04-OS1.2,OS1.3] Applies to portion of Code text: "... a) ... the <i>building</i> is <i>sprinklered</i> throughout ..."
[F02,F04-OP1.2,OP1.3] Applies to portion of Code text: "... a) ... the <i>building</i> is <i>sprinklered</i> throughout ..."		
(2)	[F02-OS1.2] Applies to portion of Code text: "... the <i>building</i> referred to in Sentence (1) shall be of <i>noncombustible construction</i> ..."	
	[F02-OP1.2] Applies to portion of Code text: "... the <i>building</i> referred to in Sentence (1) shall be of <i>noncombustible construction</i> ..."	
	(a),(c) [F03-OS1.2] [F04-OS1.2,OS1.3]	
	(a),(c) [F03-OP1.2] [F04-OP1.2,OP1.3]	
	(b),(c) [F04-OS1.3]	
<b>3.2.2.44. Group B, Division 3, up to 3 Storeys, Sprinklered</b>		
(1)	[F02,F04-OS1.2,OS1.3] Applies to portion of Code text: "... a) ... the <i>building</i> is <i>sprinklered</i> throughout ..."	
	[F02,F04-OP1.2,OP1.3] Applies to portion of Code text: "... a) ... the <i>building</i> is <i>sprinklered</i> throughout ..."	
(2)	[F03-OS1.2] [F04-OS1.2,OS1.3] Applies to portion of Code text: "...a) ... floor assemblies shall be fire separations with a fire-resistance rating not less than 1 h, ..." and to Clause (c).	
	[F03-OP1.2] [F04-OP1.2,OP1.3] Applies to portion of Code text: "...a) ... floor assemblies shall be <i>fire separations</i> with a <i>fire-resistance rating</i> not less than 1 h, ..." and to Clause (c).	
	(b),(c) [F04-OS1.3]	
(b),(c) [F04-OP1.3]		

**Table 3.10.1.1. (Continued)**

Functional Statements and Objectives <sup>(1)</sup>	
<b>3.2.2.45. Group B, Division 3, up to 2 Storeys, Sprinklered</b>	
(1)	[F02,F04-OS1.2,OS1.3] Applies to portion of Code text: "... a ... the <i>building</i> is <i>sprinklered</i> throughout ..." [F02,F04-OP1.2,OP1.3] Applies to portion of Code text: "... a ... the <i>building</i> is <i>sprinklered</i> throughout ..."
(2)	(a),(c) [F03-OS1.2] [F04-OS1.2,OS1.3] (a),(c) [F03-OP1.2] [F04-OP1.2,OP1.3] (b),(c) [F04-OS1.3] (b),(c) [F04-OP1.3]
<b>3.2.2.46. Group B, Division 3, One Storey, Sprinklered</b>	
(1)	[F02,F04-OS1.2,OS1.3] Applies to portion of Code text: "... a ... the <i>building</i> is <i>sprinklered</i> throughout ..." [F02,F04-OP1.2,OP1.3] Applies to portion of Code text: "... a ... the <i>building</i> is <i>sprinklered</i> throughout ..."
<b>3.2.2.47. Group C, Any Height, Any Area, Sprinklered</b>	
(2)	[F02-OS1.2] Applies to portion of Code text: "... the <i>building</i> referred to in Sentence (1) shall be of <i>noncombustible construction</i> ..." [F02-OP1.2] Applies to portion of Code text: "... the <i>building</i> referred to in Sentence (1) shall be of <i>noncombustible construction</i> ..." [F02,F04-OS1.2,OS1.3] Applies to portion of Code text: "... a ... the <i>building</i> shall be <i>sprinklered</i> throughout ..." [F02,F04-OP1.2,OP1.3] Applies to portion of Code text: "... a ... the <i>building</i> shall be <i>sprinklered</i> throughout ..." (b),(d) [F03-OS1.2] [F04-OS1.2,OS1.3] (b),(d) [F03-OP1.2] [F04-OP1.2,OP1.3] (c),(d) [F04-OS1.3] (c),(d) [F04-OP1.3]
<b>3.2.2.48. Group C, up to 6 Storeys, Sprinklered, Noncombustible Construction</b>	
(1)	[F02,F04-OS1.2,OS1.3] Applies to portion of Code text: "... a ... the <i>building</i> is <i>sprinklered</i> throughout ..." [F02,F04-OP1.2,OP1.3] Applies to portion of Code text: "... a ... the <i>building</i> is <i>sprinklered</i> throughout ..."
(2)	[F02-OS1.2] Applies to portion of Code text: "... the <i>building</i> referred to in Sentence (1) shall be of <i>noncombustible construction</i> ..." [F02-OP1.2] Applies to portion of Code text: "... the <i>building</i> referred to in Sentence (1) shall be of <i>noncombustible construction</i> ..." (a),(c) [F03-OS1.2] [F04-OS1.2,OS1.3] (a),(c) [F03-OP1.2] [F04-OP1.2,OP1.3] (b),(c) [F04-OS1.3] (b),(c) [F04-OP1.3]

**Table 3.10.1.1. (Continued)**

Functional Statements and Objectives <sup>(1)</sup>	
<b>3.2.2.49. Group C, up to 3 Storeys, Noncombustible Construction</b>	
(2)	[F02-OS1.2] Applies to portion of Code text: "The <i>building</i> referred to in Sentence (1) shall be of <i>noncombustible construction</i> ..." [F02-OP1.2] Applies to portion of Code text: "The <i>building</i> referred to in Sentence (1) shall be of <i>noncombustible construction</i> ..." [F03-OS1.2] [F04-OS1.2,OS1.3] Applies to portion of Code text: "a ... floor assemblies shall be <i>fire separation</i> with a <i>fire-resistance rating</i> not less than 1 h, ..." and to Clause (d). [F03-OP1.2] [F04-OP1.2,OP1.3] Applies to portion of Code text: "... a ... floor assemblies shall be <i>fire separations</i> with a <i>fire-resistance rating</i> not less than 1 h, ..." and to Clause (d). (b),(d) [F04-OS1.3] (b),(d) [F04-OP1.3] (c),(d) [F04-OS1.3] (c),(d) [F04-OP1.3]
<b>3.2.2.50. Group C, up to 6 Storeys, Sprinklered</b>	
(1)	(a) [F02,F04-OS1.2,OS1.3] (a) [F02,F04-OP1.2,OP1.3]
(2)	[F03-OS1.2] [F04-OS1.2,OS1.3] Applies to portion of Code text: "a ... floor assemblies shall be <i>fire separations</i> with a <i>fire-resistance rating</i> not less than 1 h, ..." and to Clause (e). [F03-OP1.2] [F04-OP1.2,OP1.3] Applies to portion of Code text: "... a ... floor assemblies shall be <i>fire separations</i> with a <i>fire-resistance rating</i> not less than 1 h, ..." and to Clause (e). (b),(d),(e) [F04-OS1.3] (b),(d),(e) [F04-OP1.3] [F02-OS1.2] Applies to portion of Code text: "...c)... the roof assembly shall be constructed of <i>noncombustible construction</i> or <i>fire-retardant-treated wood</i> conforming to Article 3.1.4.5., ... [F02-OP1.2] Applies to portion of Code text: "...c)... the roof assembly shall be constructed of <i>noncombustible construction</i> or <i>fire-retardant-treated wood</i> conforming to Article 3.1.4.5., ..."
<b>3.2.2.51. Group C, up to 4 Storeys, Sprinklered</b>	
(1)	[F02,F04-OS1.2,OS1.3] Applies to portion of Code text: "... a ... the <i>building</i> is <i>sprinklered</i> throughout ..." [F02,F04-OP1.2,OP1.3] Applies to portion of Code text: "... a ... the <i>building</i> is <i>sprinklered</i> throughout ..."
(2)	[F03-OS1.2] [F04-OS1.2,OS1.3] Applies to portion of Code text: "...a ... floor assemblies shall be <i>fire separations</i> with a <i>fire-resistance rating</i> not less than 1 h, ..." and to Clause (c). [F03-OP1.2] [F04-OP1.2,OP1.3] Applies to portion of Code text: "...a ... floor assemblies shall be <i>fire separations</i> with a <i>fire-resistance rating</i> not less than 1 h, ..." and to Clause (c). (b),(c) [F04-OS1.3] (b),(c) [F04-OP1.3]

Table 3.10.1.1. (Continued)

Functional Statements and Objectives <sup>(1)</sup>	
<b>3.2.2.52. Group C, up to 3 Storeys, Increased Area</b>	
(2)	[F03-OS1.2] [F04-OS1.2,OS1.3] Applies to portion of Code text: "... a) ... floor assemblies shall be <i>fire separations</i> with a <i>fire-resistance rating</i> not less than 1 h, ..." and to Clause (d).
	[F03-OP1.2] [F04-OP1.2,OP1.3] Applies to portion of Code text: "... a) ... floor assemblies shall be <i>fire separations</i> with a <i>fire-resistance rating</i> not less than 1 h, ..." and to Clause (d).
	(b),(d) [F04-OS1.3]
	(b),(d) [F04-OP1.3]
	(c),(d) [F04-OS1.3]
	(c),(d) [F04-OP1.3]
<b>3.2.2.53. Group C, up to 3 Storeys</b>	
(2)	[F03-OS1.2] [F04-OS1.2,OS1.3] Applies to portion of Code text: "... a) ... floor assemblies shall be <i>fire separations</i> with a <i>fire-resistance rating</i> not less than 45 min, ..." and to Clause c).
	[F03-OP1.2] [F04-OP1.2,OP1.3] Applies to portion of Code text: "...a) ... floor assemblies shall be <i>fire separations</i> with a <i>fire-resistance rating</i> not less than 45 min, ..." and to Clause (d)
	(b),(c) [F04-OS1.3]
	(b),(c) [F04-OP1.3]
<b>3.2.2.54. Group C, up to 3 Storeys, Sprinklered</b>	
(1)	[F02,F04-OS1.2,OS1.3] Applies to portion of Code text: "... a) ... the <i>building</i> is <i>sprinklered</i> throughout ..."
	[F02,F04-OP1.2,OP1.3] Applies to portion of Code text: "... a) ... the <i>building</i> is <i>sprinklered</i> throughout ..."
(2)	[F03-OS1.2] [F04-OS1.2,OS1.3] Applies to portion of Code text: "... a) ... floor assemblies shall be <i>fire separations</i> with a <i>fire-resistance rating</i> not less than 45 min, ..." and to Clause (c).
	[F03-OP1.2] [F04-OP1.2,OP1.3] Applies to portion of Code text: "... a) ... floor assemblies shall be <i>fire separations</i> with a <i>fire-resistance rating</i> not less than 45 min, ..." and to Clause (c).
	(b),(c) [F04-OS1.3]
	(b),(c) [F04-OP1.3]
<b>3.2.2.55. Group D, Any Height, Any Area, Sprinklered</b>	
(2)	[F02-OS1.2] Applies to portion of Code text: "... the <i>building</i> referred to in Sentence (1) shall be of <i>noncombustible construction</i> ..."
	[F02-OP1.2] Applies to portion of Code text: "... the <i>building</i> referred to in Sentence (1) shall be of <i>noncombustible construction</i> ..."
	[F02,F04-OS1.2,OS1.3] Applies to portion of Code text: "... a) ... the <i>building</i> shall be <i>sprinklered</i> throughout ..."
	[F02,F04-OP1.2,OP1.3] Applies to portion of Code text: "... a) ... the <i>building</i> shall be <i>sprinklered</i> throughout ..."
	(b),(d) [F03-OS1.2] [F04-OS1.2,OS1.3]
	(b),(d) [F03-OP1.2] [F04-OP1.2,OP1.3]
	(c),(d) [F04-OS1.3]
	(c),(d) [F04-OP1.3]

Table 3.10.1.1. (Continued)

Functional Statements and Objectives <sup>(1)</sup>	
<b>3.2.2.56. Group D, up to 6 Storeys</b>	
(2)	[F02-OS1.2] Applies to portion of Code text: "The <i>building</i> referred to in Sentence (1) shall be of <i>noncombustible construction</i> ..."
	[F02-OP1.2] Applies to portion of Code text: "The <i>building</i> referred to in Sentence (1) shall be of <i>noncombustible construction</i> ..."
	(a),(d) [F03-OS1.2] [F04-OS1.2,OS1.3]
	(a),(d) [F03-OP1.2] [F04-OP1.2,OP1.3]
	(b),(d) [F04-OS1.3]
	(b),(d) [F04-OP1.3]
	[F04-OS1.3] Applies to portion of Code text: "... c) roof assemblies shall have a <i>fire-resistance rating</i> not less than 1 h ..." and to Clause (d).
	[F04-OP1.3] Applies to portion of Code text: "... c) roof assemblies shall have a <i>fire-resistance rating</i> not less than 1 h, ..." and to Clause (d).
<b>3.2.2.57. Group D, up to 6 Storeys, Sprinklered, Noncombustible Construction</b>	
(1)	[F02,F04-OS1.2,OS1.3] Applies to portion of Code text: "... a) ... the <i>building</i> is <i>sprinklered</i> throughout ..."
	[F02,F04-OP1.2,OP1.3] Applies to portion of Code text: "... a) ... the <i>building</i> is <i>sprinklered</i> throughout ..."
(2)	[F02-OS1.2] Applies to portion of Code text: "... the <i>building</i> referred to in Sentence (1) shall be of <i>noncombustible construction</i> ..."
	[F02-OP1.2] Applies to portion of Code text: "... the <i>building</i> referred to in Sentence (1) shall be of <i>noncombustible construction</i> ..."
	(a),(c) [F03-OS1.2] [F04-OS1.2,OS1.3]
	(a),(c) [F03-OP1.2] [F04-OP1.2,OP1.3]
	(b),(c) [F04-OS1.3]
	(b),(c) [F04-OP1.3]
<b>3.2.2.58. Group D, up to 6 Storeys, Sprinklered</b>	
(1)	(a) [F02,F04-OS1.2,OS1.3]
	(a) [F02,F04-OP1.2,OP1.3]
(2)	(a),(e) [F03-OS1.2] [F04-OS1.3,OS1.2]
	(a),(e) [F03-OP1.2] [F04-OP1.2,OP1.3]
	(b),(d),(e) [F04-OS1.3]
	(b),(d),(e) [F04-OP1.3]
	[F02-OS1.2] Applies to portion of Code text: "...c)... the roof assembly shall be constructed of <i>noncombustible construction</i> or <i>fire-retardant-treated wood</i> conforming to Article 3.1.4.5., ...
	[F02-OP1.2] Applies to portion of Code text: "...c)... the roof assembly shall be constructed of <i>noncombustible construction</i> or <i>fire-retardant-treated wood</i> conforming to Article 3.1.4.5., ...

**Table 3.10.1.1. (Continued)**

Functional Statements and Objectives <sup>(1)</sup>	
<b>3.2.2.59. Group D, up to 4 Storeys, Sprinklered</b>	
(1)	[F02,F04-OS1.2,OS1.3] Applies to portion of Code text: "... a ... the <i>building</i> is <i>sprinklered</i> throughout ..." [F02,F04-OP1.2,OP1.3] Applies to portion of Code text: "... a ... the <i>building</i> is <i>sprinklered</i> throughout ..."
(2)	(a),(c) [F03-OS1.2] [F04-OS1.2,OS1.3] (a),(c) [F03-OP1.2] [F04-OP1.2,OP1.3] (b),(c) [F04-OS1.3] (b),(c) [F04-OP1.3]
<b>3.2.2.60. Group D, up to 3 Storeys</b>	
(2)	[F04-OS1.3] Applies to portion of Code text: "... c) roof assemblies shall have, if of <i>combustible construction</i> , a <i>fire-resistance rating</i> not less than 45 min, ..." and to Clause (d). [F04-OP1.3] Applies to portion of Code text: "... c) roof assemblies shall have, if of <i>combustible construction</i> , a <i>fire-resistance rating</i> not less than 45 min, ..." and to Clause (d). (a) [F03-OS1.2] Applies to the requirement that <i>noncombustible</i> floor assemblies be <i>fire separations</i> . (a) [F03-OP1.2] Applies to the requirement that <i>noncombustible</i> floor assemblies be <i>fire separations</i> . (a),(d) [F03-OS1.2] [F04-OS1.2,OS1.3] (a),(d) [F03-OP1.2] [F04-OP1.2,OP1.3] (b),(d) [F04-OS1.3] (b),(d) [F04-OP1.3]
<b>3.2.2.61. Group D, up to 3 Storeys, Sprinklered</b>	
(1)	[F02,F04-OS1.2,OS1.3] Applies to portion of Code text: "... a ... the <i>building</i> is <i>sprinklered</i> throughout ..." [F02,F04-OP1.2,OP1.3] Applies to portion of Code text: "... a ... the <i>building</i> is <i>sprinklered</i> throughout ..."
(2)	(a) [F03-OS1.2] Applies to the requirement that <i>noncombustible</i> floor assemblies be <i>fire separations</i> . (a) [F03-OP1.2] Applies to the requirement that <i>noncombustible</i> floor assemblies be <i>fire separations</i> . (a),(c) [F03-OS1.2] [F04-OS1.2,OS1.3] (a),(c) [F03-OP1.2] [F04-OP1.2,OP1.3] (b),(c) [F04-OS1.3] (b),(c) [F04-OP1.3]
<b>3.2.2.62. Group D, up to 2 Storeys</b>	
(2)	(a) [F03-OS1.2] Applies to the requirement that <i>noncombustible</i> floor assemblies be <i>fire separations</i> . (a) [F03-OP1.2] Applies to the requirement that <i>noncombustible</i> floor assemblies be <i>fire separations</i> . [F03-OS1.2] [F04-OS1.2,OS1.3] [F03-OP1.2] [F04-OP1.2,OP1.3]

**Table 3.10.1.1. (Continued)**

Functional Statements and Objectives <sup>(1)</sup>	
<b>3.2.2.63. Group D, up to 2 Storeys, Sprinklered</b>	
(1)	[F02,F04-OS1.2,OS1.3] Applies to portion of Code text: "... a ... the <i>building</i> is <i>sprinklered</i> throughout ..." [F02,F04-OP1.2,OP1.3] Applies to portion of Code text: "... a ... the <i>building</i> is <i>sprinklered</i> throughout ..."
(2)	(a) [F03-OS1.2] Applies to the requirement that <i>noncombustible</i> floor assemblies be <i>fire separations</i> . (a) [F03-OP1.2] Applies to the requirement that <i>noncombustible</i> floor assemblies be <i>fire separations</i> . [F03-OS1.2] [F04-OS1.2,OS1.3] [F03-OP1.2] [F04-OP1.2,OP1.3]
<b>3.2.2.64. Group E, Any Height, Any Area, Sprinklered</b>	
(2)	[F02-OS1.2] Applies to portion of Code text: "... the <i>building</i> referred to in Sentence (1) shall be of <i>noncombustible construction</i> ..." [F02-OP1.2] Applies to portion of Code text: "... the <i>building</i> referred to in Sentence (1) shall be of <i>noncombustible construction</i> ..." [F02,F04-OS1.2,OS1.3] Applies to portion of Code text: "... a ... the <i>building</i> shall be <i>sprinklered</i> throughout ..." [F02,F04-OP1.2,OP1.3] Applies to portion of Code text: "... a ... the <i>building</i> shall be <i>sprinklered</i> throughout ..." (b),(d) [F03-OS1.2] [F04-OS1.2,OS1.3] (b),(d) [F03-OP1.2] [F04-OP1.2,OP1.3] (c),(d) [F04-OS1.3] (c),(d) [F04-OP1.3]
<b>3.2.2.65. Group E, up to 4 Storeys, Sprinklered</b>	
(1)	[F02,F04-OS1.2,OS1.3] Applies to portion of Code text: "... a ... the <i>building</i> is <i>sprinklered</i> throughout ..." [F02,F04-OP1.2,OP1.3] Applies to portion of Code text: "... a ... the <i>building</i> is <i>sprinklered</i> throughout ..."
(2)	(a),(c) [F03-OS1.2] [F04-OS1.2,OS1.3] (a),(c) [F03-OP1.2] [F04-OP1.2,OP1.3] (b),(c) [F04-OS1.3] (b),(c) [F04-OP1.3]
<b>3.2.2.66. Group E, up to 3 Storeys</b>	
(2)	(a),(e) [F03-OS1.2] [F04-OS1.2,OS1.3] (a),(e) [F03-OP1.2] [F04-OP1.2,OP1.3] (b),(d) [F04-OS1.3] (b),(d) [F04-OP1.3] (c),(d) [F04-OS1.3] (c),(d) [F04-OP1.3]
<b>3.2.2.67. Group E, up to 3 Storeys, Sprinklered</b>	
(1)	[F02,F04-OS1.2,OS1.3] Applies to portion of Code text: "... a ... the <i>building</i> is <i>sprinklered</i> throughout ..." [F02,F04-OP1.2,OP1.3] Applies to portion of Code text: "... a ... the <i>building</i> is <i>sprinklered</i> throughout ..."

Table 3.10.1.1. (Continued)

Functional Statements and Objectives <sup>(1)</sup>	
(2)	(a),(d) [F03-OS1.2] [F04-OS1.2,OS1.3]
	(a),(d) [F03-OP1.2] [F04-OP1.2,OP1.3]
	(b),(c) [F04-OS1.3]
	(b),(c) [F04-OP1.3]
<b>3.2.2.68. Group E, up to 2 Storeys</b>	
(2)	[F03-OS1.2] [F04-OS1.2,OS1.3]
	(a),(b) [F03-OP1.2] [F04-OP1.2,OP1.3]
<b>3.2.2.69. Group E, up to 2 Storeys, Sprinklered</b>	
(1)	[F02,F04-OS1.2,OS1.3] Applies to portion of Code text: "... a) ... the <i>building</i> is <i>sprinklered</i> throughout ..."
	[F02,F04-OP1.2,OP1.3] Applies to portion of Code text: "... a) ... the <i>building</i> is <i>sprinklered</i> throughout ..."
(2)	[F03-OS1.2] [F04-OS1.2,OS1.3]
	(a),(b) [F03-OP1.2] [F04-OP1.2,OP1.3]
<b>3.2.2.70. Group F, Division 1, up to 4 Storeys, Sprinklered</b>	
(2)	(c),(d) [F04-OP1.3]
	[F02-OS1.2] Applies to portion of Code text: "... the <i>building</i> referred to in Sentence (1) shall be of <i>noncombustible construction</i> ..."
	[F02-OP1.2] Applies to portion of Code text: "... the <i>building</i> referred to in Sentence (1) shall be of <i>noncombustible construction</i> ..."
	[F02,F04-OS1.2,OS1.3] Applies to portion of Code text: "... a) ... the <i>building</i> shall be <i>sprinklered</i> throughout ..."
	[F02,F04-OP1.2,OP1.3] Applies to portion of Code text: "... a) ... the <i>building</i> shall be <i>sprinklered</i> throughout ..."
	(b),(d) [F03-OS1.2] [F04-OS1.2,OS1.3]
	(b),(d) [F03-OP1.2] [F04-OP1.2,OP1.3]
	(c),(d) [F04-OS1.3]
<b>3.2.2.71. Group F, Division 1, up to 3 Storeys, Sprinklered</b>	
(1)	[F02,F04-OS1.2,OS1.3] Applies to portion of Code text: "... a) ... the <i>building</i> is <i>sprinklered</i> throughout ..."
	[F02,F04-OP1.2,OP1.3] Applies to portion of Code text: "... a) ... the <i>building</i> is <i>sprinklered</i> throughout ..."
(2)	[F02-OS1.2] Applies to portion of Code text: "The <i>building</i> referred to in Sentence (1) is permitted to be of <i>heavy timber construction</i> or <i>noncombustible construction</i> used singly or in combination ..."
	[F02-OP1.2] Applies to portion of Code text: "The <i>building</i> referred to in Sentence (1) is permitted to be of <i>heavy timber construction</i> or <i>noncombustible construction</i> used singly or in combination ..."
	[F03-OS1.2] [F04-OS1.2,OS1.3]
	[F03-OP1.2] [F04-OP1.2,OP1.3]
<b>3.2.2.72. Group F, Division 1, up to 2 Storeys, Sprinklered</b>	
(1)	[F02,F04-OS1.2,OS1.3] Applies to portion of Code text: "... a) ... the <i>building</i> is <i>sprinklered</i> throughout ..."
	[F02,F04-OP1.2,OP1.3] Applies to portion of Code text: "... a) ... the <i>building</i> is <i>sprinklered</i> throughout ..."

Table 3.10.1.1. (Continued)

Functional Statements and Objectives <sup>(1)</sup>	
(2)	[F03-OS1.2] Applies to portion of Code text: "... a) [ <i>noncombustible</i> ] floor assemblies shall be <i>fire separations</i> ..."
	[F03-OP1.2] Applies to portion of Code text: "... a) [ <i>noncombustible</i> ] floor assemblies shall be <i>fire separations</i> ..."
	[F03-OS1.2] [F04-OS1.2,OS1.3]
	[F03-OP1.2] [F04-OP1.2,OP1.3]
<b>3.2.2.74. Group F, Division 2, Any Height, Any Area, Sprinklered</b>	
(2)	[F02-OS1.2] Applies to portion of Code text: "... the <i>building</i> referred to in Sentence (1) shall be of <i>noncombustible construction</i> ..."
	[F02-OP1.2] Applies to portion of Code text: "... the <i>building</i> referred to in Sentence (1) shall be of <i>noncombustible construction</i> ..."
	[F02,F04-OS1.2,OS1.3] Applies to portion of Code text: "... a) ... the <i>building</i> shall be <i>sprinklered</i> throughout ..."
	[F02,F04-OP1.2,OP1.3] Applies to portion of Code text: "... a) ... the <i>building</i> shall be <i>sprinklered</i> throughout ..."
	(b),(d) [F03-OS1.2] [F04-OS1.2,OS1.3]
	(b),(d) [F03-OP1.2] [F04-OP1.2,OP1.3]
	(c),(d) [F04-OS1.3]
	(c),(d) [F04-OP1.3]
<b>3.2.2.75. Group F, Division 2, up to 4 Storeys, Increased Area, Sprinklered</b>	
(1)	[F02,F04-OS1.2,OS1.3] Applies to portion of Code text: "... a) ... the <i>building</i> is <i>sprinklered</i> throughout ..."
	[F02,F04-OP1.2,OP1.3] Applies to portion of Code text: "... a) ... the <i>building</i> is <i>sprinklered</i> throughout ..."
(2)	[F02-OS1.2] Applies to portion of Code text: "... the <i>building</i> referred to in Sentence (1) shall be of <i>noncombustible construction</i> ..."
	[F02-OP1.2] Applies to portion of Code text: "... the <i>building</i> referred to in Sentence (1) shall be of <i>noncombustible construction</i> ..."
	(a),(c) [F03-OS1.2] [F04-OS1.2,OS1.3]
	(a),(c) [F03-OP1.2] [F04-OP1.2,OP1.3]
(b),(c) [F04-OS1.3]	
	(b),(c) [F04-OP1.3]
<b>3.2.2.76. Group F, Division 2, up to 3 Storeys</b>	
(2)	(a),(e) [F03-OS1.2] [F04-OS1.2,OS1.3]
	(a),(e) [F03-OP1.2] [F04-OP1.2,OP1.3]
	(b),(d) [F04-OS1.3]
	(b),(d) [F04-OP1.3]
	[F04-OS1.3] Applies to portion of Code text: "... c) roof assemblies shall have, if of <i>combustible construction</i> , a <i>fire-resistance rating</i> not less than 45 min ..." and to Clause (d).
	[F04-OP1.3] Applies to portion of Code text: "... c) roof assemblies shall have, if of <i>combustible construction</i> , a <i>fire-resistance rating</i> not less than 45 min, ..." and to Clause (d).

Copyright © NRC 1941 - 2021 World Rights Reserved © CNRC 1941-2021 Droits réservés pour tous pays

**Table 3.10.1.1. (Continued)**

Functional Statements and Objectives <sup>(1)</sup>	
<b>3.2.2.77. Group F, Division 2, up to 4 Storeys, Sprinklered</b>	
(1)	[F02,F04-OS1.2,OS1.3] Applies to portion of Code text: "... a) ... the <i>building</i> is <i>sprinklered</i> throughout ..." [F02,F04-OP1.2,OP1.3] Applies to portion of Code text: "... a) ... the <i>building</i> is <i>sprinklered</i> throughout ..."
(2)	(a),(d) [F03-OS1.2] [F04-OS1.2,OS1.3] (a),(d) [F03-OP1.2] [F04-OP1.2,OP1.3] (b),(c) [F04-OS1.3] (b),(c) [F04-OP1.3]
<b>3.2.2.78. Group F, Division 2, up to 2 Storeys</b>	
(2)	(a) [F03-OS1.2] Applies to the requirement that <i>noncombustible</i> floor assemblies be <i>fire separations</i> . (a) [F03-OP1.2] Applies to the requirement that <i>noncombustible</i> floor assemblies be <i>fire separations</i> . [F03-OS1.2] [F04-OS1.2,OS1.3] [F03-OP1.2] [F04-OP1.2,OP1.3]
<b>3.2.2.79. Group F, Division 2, up to 2 Storeys, Sprinklered</b>	
(1)	[F02,F04-OS1.2,OS1.3] Applies to portion of Code text: "... a) ... the <i>building</i> is <i>sprinklered</i> throughout ..." [F02,F04-OP1.2,OP1.3] Applies to portion of Code text: "... a) ... the <i>building</i> is <i>sprinklered</i> throughout ..."
(2)	(a) [F03-OS1.2] Applies to the requirement that <i>noncombustible</i> floor assemblies be <i>fire separations</i> . (a) [F03-OP1.2] Applies to the requirement that <i>noncombustible</i> floor assemblies be <i>fire separations</i> . [F03-OS1.2] [F04-OS1.2,OS1.3] [F03-OP1.2] [F04-OP1.2,OP1.3]
<b>3.2.2.80. Group F, Division 3, Any Height, Any Area, Sprinklered</b>	
(2)	[F02-OS1.2] Applies to portion of Code text: "... the <i>building</i> referred to in Sentence (1) shall be of <i>noncombustible construction</i> ..." [F02-OP1.2] Applies to portion of Code text: "... the <i>building</i> referred to in Sentence (1) shall be of <i>noncombustible construction</i> ..." [F02,F04-OS1.2,OS1.3] Applies to portion of Code text: "... a) ... the <i>building</i> shall be <i>sprinklered</i> throughout ..." [F02,F04-OP1.2,OP1.3] Applies to portion of Code text: "... a) ... the <i>building</i> shall be <i>sprinklered</i> throughout ..." (b),(d) [F03-OS1.2] [F04-OS1.2,OS1.3] (b),(d) [F03-OP1.2] [F04-OP1.2,OP1.3] (c),(d) [F04-OS1.3] (c),(d) [F04-OP1.3]

**Table 3.10.1.1. (Continued)**

Functional Statements and Objectives <sup>(1)</sup>	
<b>3.2.2.81. Group F, Division 3, up to 6 Storeys</b>	
(2)	[F02-OS1.2] Applies to portion of Code text: "The <i>building</i> referred to in Sentence (1) shall be of <i>noncombustible construction</i> ..." [F02-OP1.2] Applies to portion of Code text: "The <i>building</i> referred to in Sentence (1) shall be of <i>noncombustible construction</i> ..." (a),(d) [F03-OS1.2] [F04-OS1.2,OS1.3] (a),(d) [F03-OP1.2] [F04-OP1.2,OP1.3] (b),(d) [F04-OS1.3] (b),(d) [F04-OP1.3] (c),(d) [F04-OS1.3] (c),(d) [F04-OP1.3]
<b>3.2.2.82. Group F, Division 3, up to 6 Storeys, Sprinklered</b>	
(1)	[F02,F04-OS1.2,OS1.3] Applies to portion of Code text: "... a) ... the <i>building</i> is <i>sprinklered</i> throughout ..." [F02,F04-OP1.2,OP1.3] Applies to portion of Code text: "... a) ... the <i>building</i> is <i>sprinklered</i> throughout ..."
(2)	[F02-OS1.2] Applies to portion of Code text: "... the <i>building</i> referred to in Sentence (1) shall be of <i>noncombustible construction</i> ..." [F02-OP1.2] Applies to portion of Code text: "... the <i>building</i> referred to in Sentence (1) shall be of <i>noncombustible construction</i> ..." (a),(c) [F03-OS1.2] [F04-OS1.2,OS1.3] (a),(c) [F03-OP1.2] [F04-OP1.2,OP1.3] (b),(c) [F04-OS1.3] (b),(c) [F04-OP1.3]
<b>3.2.2.83. Group F, Division 3, up to 4 Storeys</b>	
(2)	[F04-OS1.3] Applies to portion of Code text: "... c) roof assemblies shall have, if of <i>combustible construction</i> , a <i>fire-resistance rating</i> not less than 45 min ..." and to Clause (d). [F04-OP1.3] Applies to portion of Code text: "... c) roof assemblies shall have, if of <i>combustible construction</i> , a <i>fire-resistance rating</i> not less than 45 min, ..." and to Clause (d). (a) [F03-OS1.2] Applies to the requirement that <i>noncombustible</i> floor assemblies be <i>fire separations</i> . (a) [F03-OP1.2] Applies to the requirement that <i>noncombustible</i> floor assemblies be <i>fire separations</i> . (a),(d) [F03-OS1.2] [F04-OS1.2,OS1.3] (a),(d) [F03-OP1.2] [F04-OP1.2,OP1.3] (b),(d) [F04-OS1.3] (b),(d) [F04-OP1.3]
<b>3.2.2.84. Group F, Division 3, up to 4 Storeys, Sprinklered</b>	
(1)	[F02,F04-OS1.2,OS1.3] Applies to portion of Code text: "... a) ... the <i>building</i> is <i>sprinklered</i> throughout ..." [F02,F04-OP1.2,OP1.3] Applies to portion of Code text: "... a) ... the <i>building</i> is <i>sprinklered</i> throughout ..."

Table 3.10.1.1. (Continued)

Functional Statements and Objectives <sup>(1)</sup>	
(2)	(a) [F03-OS1.2] Applies to the requirement that <i>noncombustible</i> floor assemblies be <i>fire separations</i> .
	(a) [F03-OP1.2] Applies to the requirement that <i>noncombustible</i> floor assemblies be <i>fire separations</i> .
	(a),(c) [F03-OS1.2] [F04-OS1.2,OS1.3]
	(a),(c) [F03-OP1.2] [F04-OP1.2,OP1.3]
	(b),(c) [F04-OS1.3]
	(b),(c) [F04-OP1.3]
<b>3.2.2.85. Group F, Division 3, up to 2 Storeys</b>	
(2)	(a) [F03-OS1.2] Applies to the requirement that <i>noncombustible</i> floor assemblies be <i>fire separations</i> .
	(a) [F03-OP1.2] Applies to the requirement that <i>noncombustible</i> floor assemblies be <i>fire separations</i> .
	[F03-OS1.2] [F04-OS1.2,OS1.3]
	[F03-OP1.2] [F04-OP1.2,OP1.3]
<b>3.2.2.86. Group F, Division 3, up to 2 Storeys, Sprinklered</b>	
(1)	[F02,F04-OS1.2,OS1.3] Applies to portion of Code text: "... a) ... the <i>building</i> is <i>sprinklered</i> throughout ..."
	[F02,F04-OP1.2,OP1.3] Applies to portion of Code text: "... a) ... the <i>building</i> is <i>sprinklered</i> throughout ..."
(2)	(a) [F03-OS1.2] Applies to the requirement that <i>noncombustible</i> floor assemblies be <i>fire separations</i> .
	(a) [F03-OP1.2] Applies to the requirement that <i>noncombustible</i> floor assemblies be <i>fire separations</i> .
	[F03-OS1.2] [F04-OS1.2,OS1.3]
	[F03-OP1.2] [F04-OP1.2,OP1.3]
<b>3.2.2.87. Group F, Division 3, One Storey</b>	
(1)	[F02-OS1.2] Applies to portion of Code text: "A <i>building</i> classified as Group F, Division 3 is permitted to be of <i>heavy timber construction</i> or <i>noncombustible construction</i> used singly or in combination ..."
	[F02-OP1.2] Applies to portion of Code text: "A <i>building</i> classified as Group F, Division 3 is permitted to be of <i>heavy timber construction</i> or <i>noncombustible construction</i> used singly or in combination ..."
<b>3.2.2.88. Group F, Division 3, One Storey, Sprinklered</b>	
(1)	[F02-OS1.2] Applies to portion of Code text: "A <i>building</i> classified as Group F, Division 3 is permitted to be of <i>heavy timber construction</i> or <i>noncombustible construction</i> used singly or in combination ..."
	[F02-OP1.2] Applies to portion of Code text: "A <i>building</i> classified as Group F, Division 3 is permitted to be of <i>heavy timber construction</i> or <i>noncombustible construction</i> used singly or in combination ..."
	[F02,F04-OS1.2,OS1.3] Applies to portion of Code text: "... a) ... the <i>building</i> is <i>sprinklered</i> throughout ..."
	[F02,F04-OP1.2,OP1.3] Applies to portion of Code text: "... a) ... the <i>building</i> is <i>sprinklered</i> throughout ..."

Table 3.10.1.1. (Continued)

Functional Statements and Objectives <sup>(1)</sup>	
<b>3.2.2.89. Group F, Division 3, One Storey, Any Area, Low Fire Load Occupancy</b>	
(2)	[F02-OS1.2]
	[F02-OP1.2]
<b>3.2.2.90. Group F, Division 3, Storage Garages up to 22 m High</b>	
(1)	[F02-OS1.2] Applies to portion of Code text: "A <i>building</i> used as a <i>storage garage</i> with all <i>storeys</i> constructed as <i>open-air storeys</i> and having no other <i>occupancy</i> above it is permitted to have its floor, wall, ceiling and roof assemblies constructed without a <i>fire-resistance rating</i> provided it is: a) of <i>noncombustible construction</i> ..."
	[F02-OP1.2] Applies to portion of Code text: "A <i>building</i> used as a <i>storage garage</i> with all <i>storeys</i> constructed as <i>open-air storeys</i> and having no other <i>occupancy</i> above it is permitted to have its floor, wall, ceiling and roof assemblies constructed without a <i>fire-resistance rating</i> provided it is: a) of <i>noncombustible construction</i> ..."
<b>3.2.3.1. Limiting Distance and Area of Unprotected Openings</b>	
(1)	[F03-OP3.1]
(5)	[F03-OP3.1]
(6)	[F03-OP3.1]
(8)	[F03-OP3.1]
(9)	[F03-OP3.1]
(10)	[F03-OP3.1]
<b>3.2.3.2. Area of Exposing Building Face</b>	
(2)	[F03-OP3.1]
(3)	[F03-OP3.1]
<b>3.2.3.4. Party Wall</b>	
(1)	[F03-OP3.1]
<b>3.2.3.5. Wall with Limiting Distance Less Than 1.2 m</b>	
(1)	[F03-OP3.1]
(2)	[F03-OP3.1]
<b>3.2.3.6. Combustible Projections</b>	
(1)	[F03-OP3.1]
(2)	[F03-OP3.1]
(3)	[F03-OP3.1]
(5)	[F03-OP3.1]
<b>3.2.3.7. Construction of Exposing Building Face</b>	
(1)	[F03,F02-OP3.1]
(2)	[F03,F02-OP3.1]
(3)	[F02,F03-OP3.1]
(4)	[F03,F02-OP3.1]
<b>3.2.3.8. Protection of Exterior Building Face</b>	
(1)	[F03,F02-OP3.1]
<b>3.2.3.9. Protection of Structural Members</b>	
(1)	[F04-OS1.3]
	[F04-OP1.3]



**Table 3.10.1.1. (Continued)**

Functional Statements and Objectives <sup>(1)</sup>	
<b>3.2.3.10. Unlimited Unprotected Openings</b>	
(1)	[F03-OP3.1]
(2)	[F03-OP3.1]
<b>3.2.3.11. Low Fire Load, One Storey Building</b>	
(1)	(b) [F03-OP3.1] (a) [F04-OP3.1]
<b>3.2.3.12. Area Increase for Unprotected Openings</b>	
(1)	[F03-OP3.1]
<b>3.2.3.13. Protection of Exit Facilities</b>	
(4)	[F06-OS1.2] [F05-OS1.5] [F06-OP1.2]
<b>3.2.3.14. Wall Exposed to Another Wall</b>	
(1)	[F03-OS1.2] [F03-OP1.2] [F03-OP3.1]
(2)	[F03-OS1.2] [F03-OP1.2] [F03-OP3.1]
<b>3.2.3.15. Wall Exposed to Adjoining Roof</b>	
(1)	[F03-OS1.2] [F03-OP1.2]
<b>3.2.3.16. Protection of Soffits</b>	
(1)	[F03-OS1.2] [F03-OP1.2]
(2)	[F03-OS1.2] [F03-OP1.2]
(3)	[F03-OS1.2] [F03-OP1.2]
(4)	[F02-OS1.2] [F02-OP1.2]
<b>3.2.3.17. Canopy Protection for Vertically Separated Openings</b>	
(1)	[F03-OS1.2] [F03-OP1.2]
(2)	[F03-OS1.2] [F03-OP1.2]
(3)	[F02-OS1.2] [F02-OP1.2]
<b>3.2.3.18. Covered Vehicular Passageway</b>	
(1)	[F03-OP3.1]
(2)	[F02-OP3.1]
<b>3.2.3.19. Walkway between Buildings</b>	
(1)	[F03-OP3.1]
(2)	[F02-OP3.1]

**Table 3.10.1.1. (Continued)**

Functional Statements and Objectives <sup>(1)</sup>	
(3)	[F02,F12-OP3.1]
<b>3.2.3.20. Underground Walkway</b>	
(1)	[F01,F02-OP3.1]
(2)	[F03-OP3.1]
(3)	[F02-OP3.1] Applies to portion of Code text: "An underground walkway shall be of <i>noncombustible construction</i> ..." [F80-OP2.3] Applies to portion of Code text: "An underground walkway shall be ... suitable for an underground location."
(4)	(a) [F05-OS1.5] [F06-OS1.2] (b) [F10-OS1.5] [F12-OS1.2]
<b>3.2.3.22. Installation of Service Lines Under Buildings</b>	
(1)	[F01-OS1.1] [F01-OP1.1]
<b>3.2.4.1. Determination of Requirement for a Fire Alarm System</b>	
(1)	[F11-OS1.5] [F13-OS1.5,OS1.2] [F13-OP1.2]
(4)	[F11-OS1.5]
<b>3.2.4.2. Continuity of Fire Alarm System</b>	
(1)	[F11-OS1.5]
(2)	[F11-OS1.5]
(3)	[F11-OS1.5]
(4)	[F10-OS1.5] [F03-OS1.2]
(5)	[F11,F13-OS1.2]
(6)	[F11-OS1.5]
<b>3.2.4.3. Types of Fire Alarm Systems</b>	
(1)	(a) [F11-OS1.5] (b) [F11-OS1.4] [F13-OS1.5] (c),(d) [F11-OS1.5]
<b>3.2.4.4. Description of Fire Alarm Systems</b>	
(1)	[F11-OS1.5]
(2)	(a) [F11-OS1.4] [F13-OS1.5] (b),(c) [F11-OS1.5]
(3)	[F13-OS1.5]
(4)	[F13-OS1.5]
<b>3.2.4.5. Installation and Verification of Fire Alarm Systems</b>	
(1)	[F11,F81-OS1.5] [F13,F12,F81-OS1.5,OS1.2] [F12,F11-OS3.7] Applies to voice communication systems.
(2)	[F82-OS1.5]
<b>3.2.4.6. Silencing of Alarm Signals</b>	
(1)	[F11-OS1.5]
(2)	[F81,F34-OS1.5]
<b>3.2.4.7. Signals to Fire Department</b>	
(1)	[F13-OS1.5,OS1.2] [F13-OP1.2]

Table 3.10.1.1. (Continued)

Functional Statements and Objectives <sup>(1)</sup>	
(2)	[F13-OS1.5,OS1.2] [F13-OP1.2]
(3)	[F13-OS1.5,OS1.2] [F13-OP1.2]
(4)	[F81,F13-OS1.5,OS1.2] [F81,F13-OP1.2]
(5)	[F13-OS1.5,OS1.2] [F13-OP1.2]
(6)	[F13-OP1.2] [F13-OS1.2]
<b>3.2.4.8. Annunciator and Zone Indication</b>	
(1)	[F12-OS1.5,OS1.2]
(2)	[F12-OS1.5,OS1.2]
(4)	[F12-OS1.2,OS1.5]
(7)	[F12-OS1.5,OS1.2]
<b>3.2.4.9. Electrical Supervision</b>	
(1)	[F82-OS1.5,OS1.2]
(2)	[F82-OS1.2] [F82-OP1.2]
(3)	(a),(d),(e),(f),(g) [F82-OS1.2] (a),(d),(e),(f),(g) [F82-OP1.2] (b),(c) [F82-OS1.5]
(4)	[F81-OP1.2] [F82-OS1.2]
(5)	[F82-OS1.2] [F82-OP1.2]
<b>3.2.4.10. Fire Detectors</b>	
(1)	[F11-OS1.5]
(2)	[F11-OS1.5]
(3)	[F02-OS1.2] [F11-OS1.5]
(4)	[F11-OS1.5]
<b>3.2.4.11. Smoke Detectors</b>	
(1)	[F11-OS1.5]
(3)	[F12-OS1.5]
(4)	[F10-OS1.5]
(5)	[F11-OS1.5]
(7)	[F11-OS1.4,OS1.5]
<b>3.2.4.12. Prevention of Smoke Circulation</b>	
(1)	[F03-OS1.2]
<b>3.2.4.13. Vacuum Cleaning System Shutdown</b>	
(1)	[F03-OS1.2]
<b>3.2.4.14. Elevator Emergency Return</b>	
(1)	[F10-OS1.5]

Table 3.10.1.1. (Continued)

Functional Statements and Objectives <sup>(1)</sup>	
(2)	[F11-OS1.5]
(3)	[F02-OS1.2]
<b>3.2.4.15. System Monitoring</b>	
(1)	[F11-OS1.5] [F12-OS1.5,OS1.2] [F12-OP1.2]
(2)	[F11-OS1.5] [F13-OS1.5,OS1.2] [F13-OP1.2]
(3)	[F12-OS1.2,OS1.5] [F12-OP1.2]
<b>3.2.4.16. Manual Stations</b>	
(1)	[F11-OS1.5]
(2)	[F02-OS1.2] [F12-OS1.2,OS1.5] [F10-OS1.5]
(3)	[F02-OS1.2] [F12-OS1.2,OS1.5] [F10-OS1.5]
(4)	[F11-OS1.5]
(5)	[F11-OS1.5]
<b>3.2.4.17. Alert and Alarm Signals</b>	
(2)	[F11-OS1.5]
(3)	[F11-OS1.5]
<b>3.2.4.18. Audibility of Alarm Systems</b>	
(1)	[F11-OS1.5]
(2)	[F11-OS1.5]
(3)	[F11-OS1.5]
(4)	[F33-OS3.5]
(5)	[F11-OS1.5]
(6)	[F11-OS1.5]
(7)	[F11,F81-OS1.5]
(8)	[F11,F81-OS1.5]
(9)	[F11,F81-OS1.5]
(10)	[F11-OS1.5]
(12)	[F11-OS1.5]
<b>3.2.4.19. Visual Signals</b>	
(1)	[F11-OS1.5]
(2)	[F11-OS1.5]
<b>3.2.4.20. Smoke Alarms</b>	
(2)	[F81,F11-OS1.5]
(3)	[F11-OS1.5]
(4)	[F11-OS1.5]
(5)	[F11-OS1.5]
(6)	[F11-OS1.5]
(7)	[F11,F81-OS1.5]
(8)	[F11,F81-OS1.5]
(10)	[F11-OS1.5]
(11)	[F81,F11-OS1.5]

**Table 3.10.1.1. (Continued)**

Functional Statements and Objectives <sup>(1)</sup>	
(12)	[F11,F81-OS1.5]
(14)	[F11-OS1.5]
<b>3.2.4.21. Residential Fire Warning Systems</b>	
(1)	[F81,F11-OS1.5]
<b>3.2.4.22. Voice Communication Systems</b>	
(1)	[F12,F11-OS3.7]
(2)	[F11-OS1.5]
(3)	[F11-OS1.5] [F13-OS1.4,OS1.5]
(4)	[F11-OS1.5]
(5)	[F12-OS3.7]
(6)	[F11-OS1.5]
(7)	[F11-OS1.5]
(8)	[F11-OS1.5]
(9)	[F11-OS1.5]
<b>3.2.5.1. Access to Above-Grade Storeys</b>	
(1)	[F12-OS1.5,OS1.2]
	[F12-OP1.2]
(2)	[F12-OS1.5,OS1.2]
	[F12-OP1.2]
(3)	[F12-OS1.5,OS1.2]
	[F12-OP1.2]
<b>3.2.5.2. Access to Basements</b>	
(1)	[F12-OS1.5,OS1.2]
	[F12-OP1.2]
(2)	[F12-OS1.5,OS1.2]
	[F12-OP1.2]
<b>3.2.5.3. Roof Access</b>	
(1)	[F12-OS1.2]
	[F12-OP1.2]
<b>3.2.5.4. Access Routes</b>	
(1)	[F12-OS1.5,OS1.2]
	[F12-OP1.2]
<b>3.2.5.5. Location of Access Routes</b>	
(1)	[F12-OS1.5,OS1.2] [F06-OS1.1]
	[F12-OP1.2]
(2)	[F12-OS1.2]
	[F12-OP1.2]
(4)	[F12-OS1.2]
	[F12-OP1.2]
<b>3.2.5.6. Access Route Design</b>	
(1)	[F12-OS1.2]
	[F12-OP1.2]

**Table 3.10.1.1. (Continued)**

Functional Statements and Objectives <sup>(1)</sup>	
(2)	[F02,F12-OS1.2]
	[F02,F12,F03-OP1.2]
	[F02,F12,F03-OP3.1]
<b>3.2.5.7. Water Supply</b>	
(1)	[F02-OS1.2]
	[F02-OP1.2]
	[F02-OP3.1]
<b>3.2.5.8. Standpipe Systems</b>	
(1)	[F02-OS1.2]
	[F02-OP1.2]
<b>3.2.5.9. Standpipe System Design</b>	
(1)	[F02-OS1.2]
	[F02-OP1.2]
(2)	[F12-OS1.2]
	[F12-OP1.2]
(5)	[F02-OS1.2]
	[F02-OP1.2]
(6)	[F12-OS1.2]
	[F12-OP1.2]
<b>3.2.5.10. Hose Connections</b>	
(1)	[F03-OS1.2] [F05,F06-OS1.5,OS1.2]
	[F03,F06-OP1.2]
(3)	[F12-OS1.2]
	[F12-OP1.2]
(4)	[F02-OS1.2]
	[F02-OP1.2]
<b>3.2.5.11. Hose Stations</b>	
(1)	[F02-OS1.2]
	[F02-OP1.2]
(2)	[F02-OS1.2]
	[F02-OP1.2]
(3)	[F02,F12-OS1.2]
	[F02,F12-OP1.2]
(4)	[F03-OS1.2]
	[F03-OP1.2]
(5)	[F10-OS1.5]
(6)	[F02-OS1.2]
	[F02-OP1.2]
(7)	[F01-OS1.1]
<b>3.2.5.12. Automatic Sprinkler Systems</b>	
(1)	[F02,F81,F82-OS1.2]
	[F02,F81,F82-OP1.2]

Copyright © NRC 1941 - 2021 World Rights Reserved © CNRC 1941-2021 Droits réservés pour tous pays

Table 3.10.1.1. (Continued)

Functional Statements and Objectives <sup>(1)</sup>	
(2)	[F02,F81-OS1.2]
	[F02,F81-OP1.2]
(3)	[F02,F81-OS1.2]
	[F02,F81-OP1.2]
(4)	[F02-OS1.2]
	[F02-OP1.2]
(5)	[F81-OS1.2]
	[F81-OP1.2]
(6)	[F02-OS1.2]
	[F02-OP1.2]
(7)	[F03-OS1.2]
	[F03-OP1.2]
	[F03-OP3.1]
(8)	[F81-OS3.3,OS3.6]
<b>3.2.5.13. Combustible Sprinkler Piping</b>	
(2)	[F02,F81-OS1.2]
	[F02,F81-OP1.2]
(3)	[F06-OS1.2]
	[F06-OP1.2]
(4)	[F06-OS1.2]
	[F06-OP1.2]
<b>3.2.5.14. Sprinklered Service Space</b>	
(1)	[F02-OS1.2]
	[F02-OP1.2]
(2)	[F12-OS1.2]
	[F12-OP1.2]
(3)	[F11-OS1.5] [F12-OS1.5,OS1.2]
	[F12-OP1.2]
<b>3.2.5.15. Fire Department Connections</b>	
(1)	[F12-OS1.2]
	[F12-OP1.2]
(2)	[F12-OS1.2]
	[F12-OP1.2]
<b>3.2.5.16. Portable Fire Extinguishers</b>	
(1)	[F02,F12,F81-OS1.2]
	[F02,F12,F81-OP1.2]
(2)	[F12-OS1.2]
	[F12-OP1.2]
<b>3.2.5.17. Protection from Freezing</b>	
(1)	[F81-OS1.2]
	[F81-OP1.2]

Table 3.10.1.1. (Continued)

Functional Statements and Objectives <sup>(1)</sup>	
<b>3.2.5.18. Fire Pumps</b>	
(1)	[F02,F81-OS1.2] [F81-OS1.4]
	[F02,F81-OP1.2] [F81-OP1.4]
<b>3.2.6.2. Limits to Smoke Movement</b>	
(1)	[F02-OS1.2,OS1.5]
	[F02-OP1.2]
(2)	[F06-OS1.2,OS1.5] [F05-OS1.5]
	[F06-OP1.2]
(3)	[F06-OS1.5,OS1.2] [F05-OS1.5]
	[F06-OP1.2]
(4)	[F03-OS1.2,OS1.5]
	[F03-OP1.2]
(5)	[F03-OS1.2,OS1.5]
	[F03-OP1.2]
(6)	[F03,F12-OS1.2,OS1.5]
	[F03,F12-OP1.2]
<b>3.2.6.3. Connected Buildings</b>	
(1)	[F03-OS1.2,OS1.5]
	[F03-OP1.2]
	[F03-OP3.1]
<b>3.2.6.4. Emergency Operation of Elevators</b>	
(1)	[F12-OS1.2,OS1.5]
	[F12-OP1.2]
(2)	[F12-OS1.2,OS1.5]
	[F12-OP1.2]
(3)	[F12-OS1.2,OS1.5]
	[F12-OP1.2]
(4)	[F12-OS1.2,OS1.5]
	[F12-OP1.2]
<b>3.2.6.5. Elevator for Use by Firefighters</b>	
(1)	[F12,F06-OS1.2,OS1.5]
	[F12,F06-OP1.2]
(2)	[F12-OS1.2,OS1.5]
	[F12-OP1.2]
(3)	[F06-OS1.2,OS1.5]
	[F06-OP1.2]
(4)	[F12-OS1.2,OS1.5]
	[F12-OP1.2]
(5)	[F12-OS1.2,OS1.5]
	[F12-OP1.2]
(6)	[F06-OS1.2,OS1.5]
	[F06-OP1.2]

**Table 3.10.1.1. (Continued)**

Functional Statements and Objectives <sup>(1)</sup>	
<b>3.2.6.6. Venting to Aid Firefighting</b>	
(1)	[F06-OS1.2,OS1.5] [F06-OP1.2]
(2)	[F30-OS3.1]
(3)	[F12-OS1.2,OS1.5] [F12-OP1.2]
(4)	[F03-OS1.2] [F12-OS1.2,OS1.5]
<b>3.2.6.7. Central Alarm and Control Facility</b>	
(1)	[F12-OS1.2,OS1.5] [F12-OP1.2]
(2)	[F12-OS1.2,OS1.5] [F11-OS1.5] [F12-OP1.2]
<b>3.2.6.8. Voice Communication System</b>	
(1)	[F12,F11-OS3.7]
<b>3.2.6.9. Testing</b>	
(1)	[F82-OS1.2,OS1.5] [F82-OP1.2]
<b>3.2.7.1. Minimum Lighting Requirements</b>	
(1)	[F30-OS3.1] [F10-OS3.7]
(2)	[F30-OS3.1] [F10-OS3.7]
<b>3.2.7.2. Recessed Lighting Fixtures</b>	
(1)	[F01-OS1.1,OS1.2] [F01-OP1.1,OP1.2]
<b>3.2.7.3. Emergency Lighting</b>	
(1)	[F30-OS3.1] [F10-OS3.7]
(2)	[F30-OS3.1] [F10-OS3.7]
(3)	[F30-OS3.1] [F10-OS3.7]
(4)	[F30-OS3.1] [F10-OS3.7]
<b>3.2.7.4. Emergency Power for Lighting</b>	
(1)	[F30-OS3.1] [F10-OS3.7]
(2)	[F30,F81-OS3.1] [F10,F81-OS3.7]
<b>3.2.7.5. Emergency Power Supply Installation</b>	
(1)	[F81,F06,F11,F02,F03,F10,F12-OS1.2,OS1.5] [F81,F06,F02,F03-OP1.2] [F81,F06,F02-OP3.1] [F81,F30-OS3.1] [F81,F11,F10,F12-OS3.7]
<b>3.2.7.6. Emergency Power for Treatment Occupancies</b>	
(1)	[F81,F06,F11,F02,F03,F10,F12-OS1.2,OS1.5] [F81,F06,F02,F03-OP1.2] [F81,F06,F02-OP3.1] [F81,F30-OS3.1] [F81,F11,F10,F12-OS3.7]

**Table 3.10.1.1. (Continued)**

Functional Statements and Objectives <sup>(1)</sup>	
<b>3.2.7.7. Fuel Supply Shut-off Valves</b>	
(1)	[F12-OS1.1,OS1.2] Applies to the requirement for a suitably identified shut-off valve outside the <i>building</i> . [F12-OP1.2] Applies to the requirement for a suitably identified shut-off valve outside the <i>building</i> . [F12-OH5] Applies to the requirement for a suitably identified shut-off valve outside the <i>building</i> . [F81-OS1.2,OS1.5] Applies to the requirement for a suitably identified separate shut-off valve. [F81-OS3.1,OS3.7] Applies to the requirement for a suitably identified separate shut-off valve.
<b>3.2.7.8. Emergency Power for Fire Alarm Systems</b>	
(1)	[F11-OS1.5] [F13-OS1.5,OS1.2] [F13-OP1.2] Applies to the requirement for fire alarm systems, including those with a voice communication system, to be provided with an emergency power supply.
(2)	[F11-OS1.5] [F13-OS1.2,OS1.5] [F13-OP1.2]
(3)	[F11-OS1.5] [F13-OS1.5,OS1.2] [F13-OP1.2]
(4)	[F13-OP1.2] [F11-OS1.5] [F13-OS1.2,OS1.5]
<b>3.2.7.9. Emergency Power for Building Services</b>	
(1)	[F12,F02,F03-OS1.5,OS1.2] [F12,F02,F03-OP1.2] (b) [F02-OP3.1] (a) [F36-OS3.6] [F12,F10-OS3.7]
(2)	[F12-OS1.5,OS1.2] [F12-OP1.2] [F36-OS3.6] [F12-OS3.7]
<b>3.2.7.10. Protection of Electrical Conductors</b>	
(2)	[F06-OS1.2,OS1.5] [F06-OP1.2]
(3)	[F06-OS1.2,OS1.5] [F06-OP1.2]
(4)	[F06-OS1.2,OS1.5] [F06-OP1.2]
(6)	[F06-OS1.2,OS1.5] [F06-OP1.2]
(8)	[F06-OS1.2,OS1.5] [F06-OP1.2]
(10)	[F06-OS1.4] [F06-OP1.2] [F10-OS3.7]

Table 3.10.1.1. (Continued)

Functional Statements and Objectives <sup>(1)</sup>	
<b>3.2.8.1. Application</b>	
(1)	[F03,F06-OS1.2] [F05-OS1.5] [F03,F06-OP1.2]
<b>3.2.8.2. Exceptions to Special Protection</b>	
(3)	[F03-OS1.2] [F03-OP1.2]
(5)	[F02,F03-OS1.2] [F02,F03-OP1.2]
<b>3.2.8.3. Sprinklers</b>	
(1)	[F02-OS1.2] [F02-OP1.2]
<b>3.2.8.4. Vestibules</b>	
(1)	[F06-OS1.2] [F05-OS1.5] [F06,F03-OP1.2]
<b>3.2.8.5. Protected Floor Space</b>	
(1)	[F05-OS1.2] [F06-OS1.5]
<b>3.2.8.6. Draft Stops</b>	
(1)	[F02-OS1.2] [F11-OS1.5] [F13-OS1.5,OS1.2] [F02,F13-OP1.2]
<b>3.2.8.7. Mechanical Exhaust System</b>	
(1)	[F03-OS1.5,OS1.2] [F03-OP1.2]
(2)	[F12-OS1.5,OS1.2] [F12-OP1.2]
<b>3.2.8.8. Combustible Content Limits</b>	
(1)	[F02-OS1.2] [F02-OP1.2]
<b>3.2.9.1. Testing</b>	
(1)	[F02,F81,F82-OS1.2,OS1.5] [F02,F81,F82-OP1.2]
<b>3.3.1.1. Separation of Suites</b>	
(1)	[F03-OS1.2] [F03-OP1.2]
(3)	[F02-OS1.2] [F02-OP1.2]
<b>3.3.1.2. Hazardous Substances, Equipment and Processes</b>	
(1)	[F01,F02,F03-OS1.1,OS1.2] [F01,F02,F03-OP1.1,OP1.2] [F43-OS3.4]
(3)	[F43-OS3.7] [F05-OS1.5]
<b>3.3.1.3. Means of Egress</b>	
(3)	[F10-OS3.7]

Table 3.10.1.1. (Continued)

Functional Statements and Objectives <sup>(1)</sup>	
(4)	[F10,F12,F05,F06-OS3.7]
(5)	[F10,F12-OS3.7]
(6)	[F10,F12,F05,F06-OS3.7]
(7)	[F10,F12,F05,F06-OS3.7]
(8)	[F05-OS1.5]
(9)	[F10,F12,F05,F06-OS3.7]
<b>3.3.1.4. Public Corridor Separations</b>	
(1)	[F03,F05-OS1.5] [F06-OS1.5,OS1.2] [F03,F06-OP1.2]
(2)	[F03,F05-OS1.5] [F06-OS1.5,OS1.2] [F03,F06-OP1.2]
(3)	[F03,F05-OS1.5] [F06-OS1.2,OS1.5] [F03,F06-OP1.2]
(4)	(a),(b) [F03,F05,F10-OS1.5] [F06,F12-OS1.2,OS1.5] (c) [F03,F05-OS1.5] [F03,F06-OS1.5,OS1.2] (a),(b) [F03,F06,F12-OP1.2] (c) [F03,F06-OP1.2]
<b>3.3.1.5. Egress Doorways</b>	
(1)	[F10,F05-OS1.5]
(2)	[F05,F10-OS1.5]
<b>3.3.1.6. Travel Distance</b>	
(1)	[F10-OS1.5]
<b>3.3.1.7. Protection on Floor Areas with a Barrier-Free Path of Travel</b>	
(1)	[F10,F05-OS1.5] (a) [F06-OS1.5]
(2)	[F03-OS1.2] [F06-OS1.5]
(4)	(a) [F10,F73-OS1.5] (b),(c) [F10-OS1.5]
<b>3.3.1.9. Corridors</b>	
(1)	[F10,F12-OS3.7]
(2)	[F10,F12-OS3.7]
(3)	[F30,F73-OS3.1]
(5)	[F10,F12-OS3.7]
(6)	(a) [F10,F12-OS3.7] (b) [F05-OS1.5] [F06-OS1.5,OS1.2]
<b>3.3.1.11. Door Swing</b>	
(1)	[F10-OS3.7]
(2)	[F10-OS3.7]
(3)	[F10-OS3.7]
(4)	[F10-OS3.7]
<b>3.3.1.12. Sliding Doors</b>	
(1)	(b) [F10-OS3.7]

**Table 3.10.1.1. (Continued)**

Functional Statements and Objectives <sup>(1)</sup>	
<b>3.3.1.13. Doors and Door Hardware</b>	
(1)	(a),(b) [F10,F12-OS3.7]
	(c) [F10-OS3.7] [F30-OS3.1]
(2)	[F30-OS3.1] [F10-OS3.7]
(3)	[F10-OS3.7]
(4)	[F10-OS3.7]
	[F73-OA1]
(8)	[F12-OS3.7]
(9)	[F12-OS3.7]
(10)	[F12-OS3.7]
<b>3.3.1.16. Tapered Treads in a Curved Flight</b>	
(2)	[F30-OS3.1] [F10-OS3.7]
(3)	[F30-OS3.1] [F10-OS3.7]
(4)	[F30-OS3.1] [F10-OS3.7]
<b>3.3.1.17. Capacity of Access to Exits</b>	
(2)	[F10-OS3.7]
(3)	[F10-OS3.7]
(4)	[F10-OS3.7]
(6)	[F10-OS3.7]
<b>3.3.1.18. Guards</b>	
(1)	[F30-OS3.1]
(2)	[F30-OS3.1]
(3)	[F30-OS3.1]
(4)	[F30-OS3.1]
<b>3.3.1.19. Transparent Doors and Panels</b>	
(1)	[F30-OS3.1] [F10-OS3.7]
(2)	[F30-OS3.1] [F10-OS3.7]
(3)	[F20-OS3.1]
(4)	[F30-OS3.1] [F10-OS3.7]
(6)	[F30-OS3.1] [F10-OS3.7]
(8)	[F30-OS3.1]
<b>3.3.1.20. Exhaust Ventilation and Explosion Venting</b>	
(1)	[F01-OS1.1]
(2)	(a) [F02-OS1.2]
	(a) [F02-OP1.2]
(3)	[F02-OS1.3] Applies to the requirement for explosion-relief devices and vents.
	[F02-OP1.3] Applies to the requirement for explosion-relief devices and vents.
<b>3.3.1.21. Janitors' Rooms</b>	
(1)	[F03-OS1.2]
	[F03-OP1.2]

**Table 3.10.1.1. (Continued)**

Functional Statements and Objectives <sup>(1)</sup>	
(3)	[F02-OS1.2]
	[F02-OP1.2]
<b>3.3.1.22. Common Laundry Rooms</b>	
(1)	[F03-OS1.2]
	[F03-OP1.2]
(3)	[F02-OS1.2]
	[F02-OP1.2]
<b>3.3.1.23. Obstructions</b>	
(1)	[F10-OS3.7]
<b>3.3.1.24. Signs in Service Spaces</b>	
(1)	[F10-OS3.7]
<b>3.3.1.25. Welding and Cutting</b>	
(1)	[F03,F02-OS1.2]
	[F03,F02-OP1.2]
<b>3.3.2.1. Scope</b>	
(2)	[F30-OS3.1] [F10-OS3.7]
(3)	[F30-OS3.1] [F10-OS3.7]
<b>3.3.2.2. Fire Separations</b>	
(1)	[F03-OS1.2]
(3)	[F03-OS1.2] Applies where space under tiers of seats is not <i>sprinklered</i> .
	[F03-OS1.2] Applies where space under tiers of seats is <i>sprinklered</i> .
<b>3.3.2.4. Fixed Seats</b>	
(1)	[F30-OS3.1] [F10-OS3.7]
(3)	[F10-OS3.7]
<b>3.3.2.5. Aisles</b>	
(2)	[F10-OS3.7]
(4)	[F10-OS3.7]
(5)	[F10-OS3.7]
(6)	[F10-OS3.7]
(7)	[F10-OS3.7]
(8)	[F10-OS3.7] [F30-OS3.1]
(9)	[F10-OS3.7] [F30-OS3.1]
(10)	[F10-OS3.7] [F30-OS3.1]
(11)	[F10-OS3.7] [F30-OS3.1]
(12)	[F10-OS3.7] [F30-OS3.1]
(13)	[F10-OS3.7] [F30-OS3.1]
(14)	[F10-OS3.7] [F30-OS3.1]
(15)	[F10-OS3.7] [F30-OS3.1]
(16)	[F10-OS3.7] [F30-OS3.1]
<b>3.3.2.6. Corridors</b>	
(1)	[F03,F05-OS1.5] [F06-OS1.5,OS1.2]
	[F03,F06-OP1.2]

Table 3.10.1.1. (Continued)

Functional Statements and Objectives <sup>(1)</sup>	
(3)	[F03,F05-OS1.5] [F06-OS1.5,OS1.2] [F03,F06-OP1.2]
(4)	[F10-OS3.7]
<b>3.3.2.7. Doors</b>	
(1)	[F10-OS3.7]
<b>3.3.2.8. Fixed Bench-Type Seats without Arms</b>	
(1)	[F10-OS3.7] [F10-OS3.7]
<b>3.3.2.10. Handrails in Aisles with Steps</b>	
(1)	[F30-OS3.1] [F10-OS3.7]
(2)	[F30-OS3.1] [F10-OS3.7]
<b>3.3.2.11. Outdoor Places of Assembly</b>	
(1)	[F10-OS3.7]
(2)	[F10-OS3.7]
(3)	[F10-OS3.7]
(5)	[F10-OS3.7]
<b>3.3.2.12. Bleachers</b>	
(1)	[F10-OS3.7] [F30-OS3.1]
(2)	[F10-OS3.7] [F30-OS3.1]
(4)	[F10-OS3.7] [F30-OS3.1]
(5)	[F30-OS3.1]
<b>3.3.2.13. Libraries</b>	
(1)	[F03-OS1.2] [F03-OP1.2]
(2)	[F02-OS1.2] [F02-OP1.2]
<b>3.3.2.14. Stages for Theatrical Performances</b>	
(1)	[F02-OS1.2] [F02-OP1.2]
(2)	[F03-OS1.2] [F03-OP1.2]
(3)	[F03-OS1.2] [F03-OP1.2]
(4)	[F03-OS1.2] [F03-OP1.2]
(5)	[F02-OS1.2] [F06-OS1.2,OS1.5] [F02,F06-OP1.2]
(6)	[F03-OS1.2,OS1.5] [F03-OP1.2]
<b>3.3.2.15. Risers for Stairs</b>	
(1)	[F30-OS3.1]

Table 3.10.1.1. (Continued)

Functional Statements and Objectives <sup>(1)</sup>	
<b>3.3.2.16. Storage Rooms</b>	
(1)	[F12-OS1.2] [F12-OP1.2]
<b>3.3.3.2. Separations between Care, Treatment or Detention Occupancies and Repair Garages</b>	
(1)	[F44-OS3.4] [F03-OS1.2]
<b>3.3.3.3. Corridors</b>	
(1)	[F10-OS3.7]
(2)	[F10-OS3.7]
(3)	[F10,F12-OS3.7]
(4)	(a) [F10-OS3.7] (b) [F10,F12-OS3.7]
<b>3.3.3.4. Doorway Width</b>	
(1)	[F10,F12-OS3.7]
(2)	[F10,F12-OS3.7]
<b>3.3.3.5. Compartments and Fire Separations</b>	
(2)	[F05-OS1.5] [F06-OS1.5,OS1.2] [F06-OP1.2]
(4)	[F05-OS1.2] [F06-OS1.2,OS1.5] [F03,F06-OP1.2]
(6)	[F10-OS1.5]
(7)	[F10-OS1.5]
(8)	[F03,F05-OS1.2] [F06-OS1.5]
(12)	[F03,F05-OS1.2] [F06-OS1.5]
(16)	[F02,F03-OS1.2] [F44-OS1.1] [F02,F03-OP1.2]
<b>3.3.3.6. Areas of Refuge</b>	
(1)	[F03-OS1.2]
<b>3.3.3.7. Contained Use Areas</b>	
(2)	[F03-OS1.2] [F06-OS1.5,OS1.2] [F03,F06-OP1.2]
(3)	[F02-OS1.2] [F06-OS1.5,OS1.2] [F02,F06-OP1.2]
(4)	[F02-OS1.2] [F06-OS1.5,OS1.2] [F02,F06-OP1.2]
(5)	[F10-OS3.7]
<b>3.3.4.2. Fire Separations</b>	
(1)	[F03-OS1.2] [F05-OS1.5] [F06-OS1.5,OS1.2] [F03,F06-OP1.2]
(4)	[F02,F03-OS1.2] [F44-OS1.1] (a),(b) [F02,F03-OP1.2]



**Table 3.10.1.1. (Continued)**

Functional Statements and Objectives <sup>(1)</sup>	
(5)	[F03-OS1.2] [F01-OS1.1]
	(a) [F03-OP1.2]
	[F44-OS3.4]
<b>3.3.4.3. Storage Rooms</b>	
(1)	[F02-OS1.2]
	[F02-OP1.2]
(2)	[F03-OS1.2]
	[F03-OP1.2]
(4)	[F12-OS1.2]
	[F12-OP1.2]
<b>3.3.4.4. Egress from Dwelling Units</b>	
(2)	[F10,F05-OS3.7]
(3)	[F10-OS3.7]
(4)	[F05-OS1.2,OS1.5]
(5)	[F10,F05-OS3.7]
(6)	[F10,F05-OS3.7]
<b>3.3.4.5. Automatic Locking Prohibition</b>	
(1)	[F10-OS3.7]
<b>3.3.4.8. Protection of Openable Windows</b>	
(1)	[F30-OS3.1]
<b>3.3.5.2. Fire Extinguishing Systems</b>	
(1)	[F03-OS1.2]
	[F03-OP1.2]
<b>3.3.5.3. Basements</b>	
(1)	[F12-OS1.2,OS1.5] [F01-OS1.1]
	[F12-OP1.2]
(2)	[F06-OS1.5,OS1.2] Applies to the separation of entrances to <i>basements</i> and to rooms containing <i>building services</i> from the remainder of the <i>building</i> .
	[F06-OP1.2] Applies to the separation of entrances from the remainder of the <i>building</i> .
	[F05-OS1.5] [F06-OS1.2,OS1.5] Applies to the separation of <i>exits</i> from the remainder of the <i>building</i> .
	[F06-OP1.2] Applies to the separation of <i>exits</i> from the remainder of the <i>building</i> .
(3)	[F44-OS1.1]
<b>3.3.5.4. Repair and Storage Garages</b>	
(2)	[F30-OS3.1] [F10,F12-OS3.7]
(5)	[F30-OS3.1]
(6)	[F30-OS3.1]
(8)	[F02-OS1.2]
	[F02-OP1.2]
<b>3.3.5.5. Repair Garage Separation</b>	
(1)	[F03-OS1.2]
	[F03-OP1.2]

**Table 3.10.1.1. (Continued)**

Functional Statements and Objectives <sup>(1)</sup>	
<b>3.3.5.6. Storage Garage Separation</b>	
(1)	[F03-OS1.2]
	[F03-OP1.2]
<b>3.3.5.7. Vestibules</b>	
(4)	[F44-OS3.4]
	[F44-OS1.1]
<b>3.3.5.8. Dispensing of Fuel</b>	
(1)	[F01-OS1.1]
(2)	[F01-OS1.1]
<b>3.3.5.9. Multiple-Tenant Self-Storage Warehouses</b>	
(1)	[F03-OS1.2]
	[F03-OP1.2]
<b>3.3.6.2. Storage of Dangerous Goods</b>	
(1)	[F03-OP1.2]
	[F03-OS1.2]
(2)	[F03-OS1.2]
	[F03-OP1.2]
(3)	[F01,F02,F03,F81-OS1.1,OS1.2]
(4)	[F01-OS1.1]
	[F01-OP1.1]
<b>3.3.6.3. Indoor Storage of Anhydrous Ammonia and Flammable, Toxic and Oxidizing Gases</b>	
(1)	(a) [F03-OS1.2] [F44-OS1.1]
	(a) [F03-OP1.2]
	(a) [F44-OS1.2,OS1.5,OS1.1] Applies to gas-tight <i>fire separations</i> .
	(b) [F12-OS1.2] [F01-OS1.1] [F02-OS1.3]
	(b) [F02-OP1.3]
	(c) [F12-OS1.1]
	(d) [F44-OS1.1]
(2)	(a) [F03-OP1.2]
	(a) [F03-OS1.2] [F44-OS1.1]
	(a) [F44-OS1.2,OS1.5,OS1.1] Applies to gas-tight <i>fire separations</i> .
	(b) [F12-OS1.2] [F01-OS1.1]
	(c) [F12-OS1.1]
	(d) [F44-OS1.1]
<b>3.3.6.4. Storage and Dispensing Rooms for Flammable Liquids and Combustible Liquids</b>	
(1)	[F03-OS1.2]
	[F03-OP1.2]
(2)	[F02-OS1.3]
	[F02-OP1.3]

Table 3.10.1.1. (Continued)

Functional Statements and Objectives <sup>(1)</sup>	
<b>3.3.6.5. Tire Storage</b>	
(1)	[F03-OS1.2] [F03-OP1.2]
<b>3.3.6.6. Ammonium Nitrate Storage</b>	
(2)	[F01-OS1.1] [F02,F12-OS1.2] [F01-OP1.1] [F02,F12-OP1.2]
(3)	[F03-OS1.2] [F01-OS1.1] [F03-OP1.2] [F01-OP1.1]
(4)	[F12,F02-OS1.1] [F12,F02-OP1.2]
(5)	[F44-OH5] [F01-OS1.1] [F02-OS1.2] [F43-OS3.4]
(6)	[F01,F81-OS1.1]
<b>3.3.6.7. Flooring Materials</b>	
(1)	[F43-OS3.4] [F44-OH5] [F01-OS1.1]
<b>3.3.6.8. Fire Separations in Process Plants</b>	
(1)	[F03-OP1.2] [F03-OS1.2]
<b>3.3.6.9. Basements and Pits</b>	
(1)	[F01-OS1.1] [F01-OP1.1]
<b>3.4.1.2. Separation of Exits</b>	
(1)	[F10,F12,F05,F06-OS3.7] [F12,F06-OP1.2] [F12,F06-OS1.5,OS1.2]
(2)	[F10-OS3.7]
<b>3.4.1.5. Exterior Exit Passageways</b>	
(1)	[F10-OS3.7]
<b>3.4.1.6. Restricted Use of Horizontal Exits</b>	
(1)	[F10-OS3.7]
(2)	[F10,F05-OS3.7]
<b>3.4.1.7. Slide Escapes</b>	
(1)	[F10-OS3.7]
<b>3.4.1.9. Mirrors near Exits</b>	
(1)	[F10-OS3.7] [F30-OS3.1]
<b>3.4.1.10. Combustible Glazing in Exits</b>	
(1)	[F05-OS1.2] [F06-OS1.2,OS1.5] [F03,F06-OP1.2]

Table 3.10.1.1. (Continued)

Functional Statements and Objectives <sup>(1)</sup>	
<b>3.4.2.1. Minimum Number of Exits</b>	
(1)	[F10,F12,F05,F06-OS3.7] [F12,F06-OS1.2] [F12,F06-OP1.2]
(3)	[F10-OS3.7]
<b>3.4.2.2. Means of Egress from Mezzanines</b>	
(1)	[F05-OS1.5]
<b>3.4.2.3. Distance between Exits</b>	
(1)	[F10,F05-OS1.5]
(4)	[F10-OS3.7]
<b>3.4.2.4. Travel Distance</b>	
(3)	[F10-OS3.7]
<b>3.4.2.5. Location of Exits</b>	
(1)	[F10-OS3.7]
(3)	[F10-OS3.7]
<b>3.4.2.6. Principal Entrances</b>	
(1)	[F10-OS3.7]
(2)	[F10-OS3.7]
<b>3.4.3.1. Exit Width Based on Occupant Load</b>	
(2)	[F10-OS3.7]
<b>3.4.3.2. Exit Width</b>	
(1)	[F10-OS3.7]
(2)	[F10-OS3.7]
(3)	[F10-OS3.7]
(6)	[F10-OS3.7]
(7)	[F10-OS3.7]
(8)	[F12,F10-OS3.7] [F30-OS3.1] [F12-OP1.2] [F12-OS1.2]
<b>3.4.3.3. Exit Width Reduction</b>	
(1)	[F10,F12-OS3.7] [F30-OS3.1] [F12-OP1.2] [F12-OS1.2]
(2)	[F10,F12-OS3.7] [F12-OP1.2] [F12-OS1.2]
(3)	[F10,F12-OS3.7] [F12-OP1.2] [F12-OS1.2]
(4)	[F10,F12-OS3.7] [F12-OP1.2] [F12-OS1.2]

**Table 3.10.1.1. (Continued)**

Functional Statements and Objectives <sup>(1)</sup>	
<b>3.4.3.4. Headroom Clearance</b>	
(1)	[F30-OS3.1] [F10,F12-OS3.7]
	[F12-OP1.2]
	[F12-OS1.2]
(4)	[F30-OS3.1] [F10,F12-OS3.7]
	[F12-OP1.2]
	[F12-OS1.2]
(5)	[F30-OS3.1] [F10,F12-OS3.7]
	[F12-OP1.2]
	[F12-OS1.2]
<b>3.4.4.1. Fire-Resistance Rating of Exit Separations</b>	
(1)	[F05-OS1.5] [F06-OS1.5,OS1.2] [F03-OS1.2]
	[F06,F03-OP1.2]
<b>3.4.4.2. Exits through Lobbies</b>	
(1)	[F05,F06-OS1.5]
(2)	[F12,F10,F05,F06-OS1.5]
<b>3.4.4.3. Exterior Passageway Exceptions</b>	
(1)	[F05,F06,F10-OS1.5]
<b>3.4.4.4. Integrity of Exits</b>	
(1)	[F05-OS1.5] [F06-OS1.5,OS1.2] [F03-OS1.2]
	[F06,F03-OP1.2]
(2)	[F05-OS1.5] [F06-OS1.5,OS1.2]
	[F06-OP1.2]
(3)	[F05-OS1.5] [F06-OS1.5,OS1.2]
	[F06-OP1.2]
(4)	[F05-OS1.5] [F06-OS1.5,OS1.2]
	[F06-OP1.2]
	[F43-OS3.7]
(5)	[F05-OS1.5] [F06-OS1.5,OS1.2] [F03-OS1.2]
	[F03,F06-OP1.2]
(6)	[F10,F12-OS3.7] [F30-OS3.1] [F31-OS3.2] [F32-OS3.3] [F43-OS3.4]
	[F10,F05-OS1.5] [F12-OS1.5,OS1.2]
	[F12-OP1.2]
(7)	[F05-OS1.5] [F06-OS1.5,OS1.2]
	[F06-OP1.2]
	[F43-OS3.7]
(8)	[F05-OS1.5] [F06-OS1.5,OS1.2]
	[F06-OP1.2]
(9)	[F05-OS1.5] [F06-OS1.5,OS1.2]
	[F06-OP1.2]
<b>3.4.5.1. Exit Signs</b>	
(1)	[F10-OS3.7]

**Table 3.10.1.1. (Continued)**

Functional Statements and Objectives <sup>(1)</sup>	
(2)	[F10-OS3.7]
(3)	[F10,F81-OS3.7]
(4)	[F10,F81-OS3.7]
(5)	[F10-OS3.7]
(6)	[F10-OS3.7]
(7)	[F10-OS3.7]
<b>3.4.5.2. Signs for Stairs and Ramps at Exit Level</b>	
(1)	[F10-OS3.7]
<b>3.4.6.1. Slip Resistance of Ramps and Stairs</b>	
(1)	(a) [F10-OS3.7] [F30-OS3.1]
	(b) [F10-OS3.7] [F30-OS3.1]
(2)	[F10,F12-OS3.7] [F30-OS3.1]
	[F12-OP1.2]
	[F12-OS1.2,OS1.5]
<b>3.4.6.2. Minimum Number of Risers</b>	
(1)	[F30-OS3.1]
<b>3.4.6.3. Maximum Vertical Rise of Stair Flights and Required Landings</b>	
(1)	[F10-OS3.7]
(2)	[F10-OS3.7] [F30-OS3.1]
(3)	[F10,F12-OS3.7] [F30-OS3.1]
<b>3.4.6.4. Dimensions of Landings</b>	
(1)	[F10,F12-OS3.7] [F30-OS3.1]
	[F12-OP1.2]
	[F12-OS1.2,OS1.5]
(2)	[F10,F12-OS3.7] [F30-OS3.1]
	[F12-OP1.2] [F12-OS1.2,OS1.5]
(4)	[F10,F12-OS3.7] [F30-OS3.1]
(5)	[F10,F12-OS3.7] [F30-OS3.1]
<b>3.4.6.5. Handrails</b>	
(1)	[F30-OS3.1] [F10-OS3.7]
(2)	[F30-OS3.1] [F10-OS3.7]
(3)	[F10-OS3.7] [F30-OS3.1]
(4)	[F30-OS3.1] [F10-OS3.7]
(5)	[F30-OS3.1] [F10-OS3.7]
(7)	[F30-OS3.1] [F10-OS3.7]
(9)	[F30-OS3.1] [F10-OS3.7]
(10)	[F30-OS3.1] [F10-OS3.7]
	[F73-OA1]
(11)	[F30-OS3.1] [F10-OS3.7]
(12)	[F30-OS3.1] [F10-OS3.7]
	[F73-OA1]

Table 3.10.1.1. (Continued)

Functional Statements and Objectives <sup>(1)</sup>	
(13)	[F30-OS3.1] [F10-OS3.7]
(15)	[F30-OS3.1] [F10-OS3.7]
<b>3.4.6.6. Guards</b>	
(1)	[F30-OS3.1] [F10-OS3.7]
(2)	[F30-OS3.1] [F10-OS3.7]
(4)	[F30-OS3.1] [F10-OS3.7]
(5)	[F30-OS3.1]
(6)	[F30-OS3.1]
(7)	[F30-OS3.1]
<b>3.4.6.7. Ramp Slope</b>	
(1)	[F10-OS3.7] [F30-OS3.1]
<b>3.4.6.8. Treads and Risers</b>	
(1)	[F10-OS3.7] [F30-OS3.1]
(2)	[F10-OS3.7] [F30-OS3.1]
(3)	[F10-OS3.7] [F30-OS3.1] [F73-OA1]
(4)	[F10-OS3.7] [F30-OS3.1]
(5)	[F30-OS3.1] [F10-OS3.7]
(6)	[F30-OS3.1] [F10-OS3.7]
(7)	[F30-OS3.1] [F10-OS3.7]
(8)	[F30-OS3.1]
(9)	[F10-OS3.7] [F30-OS3.1]
(10)	[F30-OS3.1]
<b>3.4.6.9. Curved Flights in Exits</b>	
(1)	[F10-OS3.7] [F30-OS3.1]
(2)	[F10-OS3.7] [F30-OS3.1]
(3)	[F30-OS3.1] [F10-OS3.7]
(4)	[F30-OS3.1] [F10-OS3.7]
<b>3.4.6.10. Horizontal Exits</b>	
(1)	[F10-OS3.7]
(2)	[F10-OS3.7]
(4)	[F10,F73-OS3.7]
(5)	[F10-OS3.7]
<b>3.4.6.11. Doors</b>	
(1)	[F30-OS3.1] [F10-OS3.7]
(2)	[F30-OS3.1] [F10-OS3.7]
(3)	[F30-OS3.1] [F10-OS3.7] Applies to portion of Code text: "No exit door shall open directly onto a step ..." [F81,F10-OS3.7] Applies where there is a danger of blockage from ice or snow.
(4)	[F10-OS3.7]
(5)	[F10,F12-OS3.7]
(6)	[F10-OS3.7]

Table 3.10.1.1. (Continued)

Functional Statements and Objectives <sup>(1)</sup>	
<b>3.4.6.12. Direction of Door Swing</b>	
(1)	[F10-OS3.7]
<b>3.4.6.13. Self-closing Devices</b>	
(1)	[F05-OS1.5] [F06-OS1.5,OS1.2] [F06,F03-OP1.2]
<b>3.4.6.14. Sliding Doors</b>	
(2)	[F12-OS3.7]
<b>3.4.6.15. Revolving Doors</b>	
(1)	(a) [F30-OS3.1] [F10-OS3.7] (b) [F10,F12-OS3.7] (c) [F10-OS3.7] (d) [F30-OS3.1] [F10-OS3.7] (e) [F20-OS3.1]
(2)	[F10-OS3.7]
(3)	(a),(b),(d),(e) [F10,F81-OS3.7] [F20,F30-OS3.1]
<b>3.4.6.16. Door Release Hardware</b>	
(1)	[F10-OS3.7]
(2)	[F10-OS3.7]
(3)	[F10-OS3.7]
(4)	[F10,F81-OS3.7]
(5)	[F10,F81-OS3.7]
(6)	[F10-OS3.7] [F73-OA1]
<b>3.4.6.17. Security for Banks and Mercantile Floor Areas</b>	
(1)	[F02-OS1.2] Applies to <i>sprinklered buildings</i> . [F10,F81-OS3.7] Applies to <i>exit</i> and egress doors that comply with the stated Sentences.
(2)	[F10-OS3.7]
(3)	[F81-OS3.7]
(5)	[F10-OS1.5]
(6)	[F10-OS3.7]
(9)	[F10,F81-OS3.7]
<b>3.4.6.18. Emergency Crossover Access to Floor Areas</b>	
(1)	[F10-OS3.7]
(3)	[F10-OS3.7]
(4)	[F10,F12-OS3.7] [F12-OP1.2] [F12-OS1.2,OS1.5]
(5)	[F10-OS3.7]

**Table 3.10.1.1. (Continued)**

Functional Statements and Objectives <sup>(1)</sup>	
<b>3.4.6.19. Floor Numbering</b>	
(1)	[F10,F12,F73-OS3.7]
	[F73-OA1]
	[F12-OP1.2]
	[F12-OS1.2]
<b>3.4.7.1. Scope</b>	
(1)	[F10,F12-OS3.7]
(2)	[F10-OS3.7] [F30-OS3.1]
	[F10-OS1.5] [F12-OS1.2]
<b>3.4.7.2. Fire Escape Construction</b>	
(1)	[F05-OS1.5] [F06-OS1.2] Applies to the combustibility of materials used in the construction of fire escapes.
	[F10,F12-OS3.7] [F20-OS3.1] Applies to the type and construction of fire escapes.
	[F20-OS2.1] Applies to the type and construction of fire escapes.
<b>3.4.7.3. Access to Fire Escapes</b>	
(1)	[F10-OS3.7] Applies to portion of Code text: "Access to fire escapes shall be from corridors through doors at floor level ..."
(2)	[F30-OS3.1] [F10-OS3.7]
<b>3.4.7.4. Protection of Fire Escapes</b>	
(1)	[F05,F06-OS1.5]
<b>3.4.7.5. Stairs</b>	
(1)	[F10-OS3.7]
(2)	[F10-OS3.7]
(3)	[F10-OS3.7] Applies to the reduction in width permitted under certain conditions.
(4)	[F10-OS3.7] [F30-OS3.1]
<b>3.4.7.6. Guards and Railings</b>	
(1)	[F10-OS3.7] [F30-OS3.1]
(2)	[F10-OS3.7] [F30-OS3.1]
(3)	[F10-OS3.7] [F30-OS3.1]
(4)	[F30-OS3.1]
(5)	[F30-OS3.1]
<b>3.5.2.1. Elevators, Escalators and Dumbwaiters</b>	
(1)	[F30,F81-OS3.1] [F32,F81-OS3.3] [F36,F81-OS3.6]
(2)	[F82-OS3.1,OS3.3,OS3.6]
(3)	[F73-OA1]
<b>3.5.3.1. Fire Separations for Elevator Hoistways</b>	
(1)	[F03-OS1.2]
	[F03-OP1.2]
<b>3.5.3.2. Vertical Service Spaces for Dumbwaiters</b>	
(1)	[F03-OS1.2]
	[F03-OP1.2]

**Table 3.10.1.1. (Continued)**

Functional Statements and Objectives <sup>(1)</sup>	
<b>3.5.3.3. Fire Separations for Elevator Machine Rooms</b>	
(1)	[F03-OS1.2]
	[F03-OP1.2]
(2)	[F03-OS1.2]
	[F03-OP1.2]
<b>3.5.4.1. Elevator Car Dimensions</b>	
(1)	[F12-OS3.7]
(2)	[F12-OS3.7]
<b>3.5.4.2. Floor Numbering</b>	
(1)	[F73-OA1]
<b>3.6.1.2. Electrical Wiring and Equipment</b>	
(1)	[F01-OS1.1] [F02,F03-OS1.2] [F81-OS1.4]
	[F01-OP1.1] [F02,F03-OP1.2] [F81-OP1.4]
	[F32-OS3.3]
<b>3.6.1.3. Lightning Protection Systems</b>	
(1)	[F01,F81-OS1.1]
	[F01,F81-OP1.1]
<b>3.6.1.4. Storage Use Prohibition</b>	
(1)	[F01-OS1.1] [F02-OS1.2]
<b>3.6.1.5. Appliances Installed outside a Building</b>	
(1)	[F03-OS1.2]
	(b) [F03-OP1.2]
	(a) [F03-OP3.1]
<b>3.6.2.1. Fire Separations around Service Rooms</b>	
(1)	[F03-OS1.2,OS1.4]
	[F03-OP1.2,OP1.4]
(3)	[F01-OS1.1] [F03-OS1.2]
	[F01-OP1.1] [F03-OP1.2]
(4)	[F03-OS1.2,OS1.4]
	[F03-OP1.2,OP1.4]
(5)	[F03-OS1.2,OS1.4]
	[F03-OP1.2,OP1.4]
(6)	[F03-OS1.2,OS1.4]
	[F03-OP1.2,OP1.4]
(7)	[F03-OS1.2,OS1.4]
	[F03-OP1.2,OP1.4]
<b>3.6.2.2. Service Rooms under Exits</b>	
(1)	[F06,F05-OS3.7]
	[F02-OS1.2]
<b>3.6.2.4. Incinerator Rooms</b>	
(1)	[F02-OS1.2]

Table 3.10.1.1. (Continued)

Functional Statements and Objectives <sup>(1)</sup>	
<b>3.6.2.5. Combustible Refuse Storage</b>	
(1)	[F03-OS1.2]
	[F03-OP1.2]
<b>3.6.2.6. Door Swing for Service Rooms</b>	
(1)	[F10-OS1.5] Applies to portion of Code text: "A swing-type door from a <i>service room</i> containing a <i>boiler</i> or incinerator shall swing outward from the room ..."
	[F30-OS3.1] Applies to portion of Code text: "A swing-type door from a <i>service room</i> containing a <i>boiler</i> or incinerator shall swing ... inward if the door opens onto a corridor or any room used for an <i>assembly occupancy</i> ."
<b>3.6.2.7. Electrical Equipment Vaults</b>	
(2)	[F03-OS1.2,OS1.4]
	[F03-OP1.2,OP1.4]
(3)	[F02-OS1.2] [F11-OS1.5] [F03-OS1.4]
	[F02-OP1.2] [F03-OP1.4]
(4)	[F03-OS1.2,OS1.4]
	[F03-OP1.2,OP1.4]
(6)	[F81-OS1.1]
(7)	[F03-OS1.2]
(8)	[F44-OS1.1] [F03-OS1.2]
(9)	[F34-OS1.1]
	[F34-OS3.3]
	[F34-OP1.1]
<b>3.6.2.8. Emergency Power Installations</b>	
(1)	[F03-OS1.2,OS1.4] [F06-OS1.2,OS1.5]
	[F03-OP1.2,OP1.4] [F06-OP1.2]
<b>3.6.3.1. Fire Separations for Vertical Service Spaces</b>	
(1)	[F03-OS1.2]
	[F03-OP1.2]
(2)	[F03-OS1.2]
	[F03-OP1.2]
(3)	[F03-OS1.2]
	[F03-OP1.2]
(4)	[F03-OS1.2]
	[F03-OP1.2]
(5)	[F03-OS1.2]
	[F03-OP1.2]
<b>3.6.3.2. Foamed Plastic Protection</b>	
(1)	[F02-OS1.2]
<b>3.6.3.3. Linen and Refuse Chutes</b>	
(1)	(d),(e) [F02-OS1.2]
	(a),(b),(c) [F41-OH2.4,OH2.5]
(2)	[F03-OS1.2]
	[F03-OP1.2]

Table 3.10.1.1. (Continued)

Functional Statements and Objectives <sup>(1)</sup>	
(3)	[F03-OS1.2]
(4)	(b) [F03-OS1.2]
	(a) [F41-OH2.4,OH2.5]
(5)	(a) [F81,F03-OS1.2]
	(a) [F81,F41-OH2.4,OH2.5]
	(a) [F81,F03-OP1.2]
	(b) [F03-OS1.2]
	(b) [F03-OP1.2]
	(c) [F01,F02-OS1.2]
	(c) [F01,F02-OP1.2]
	(d) [F05-OS1.5] [F06-OS1.5,OS1.2]
	(d) [F06-OP1.2]
	(6)
[F02-OP1.2]	
(7)	[F03-OS1.2]
	[F03-OP1.2]
(8)	[F02-OS1.2]
	[F41-OH2.4,OH2.5]
(9)	[F03-OS1.2]
	[F03-OP1.2]
(10)	[F81,F03-OS1.2] Applies to portion of Code text: "The room or bin into which a refuse chute discharges shall be of sufficient size to contain the refuse between normal intervals of emptying ..."
	[F81,F41-OH2.4,OH2.5] Applies to portion of Code text: "The room or bin into which a refuse chute discharges shall be of sufficient size to contain the refuse between normal intervals of emptying ..."
	[F41-OH2.4,OH2.5] Applies to portion of Code text: "The room or bin into which a refuse chute discharges shall be ... impervious to moisture and be equipped with a water connection and floor drain for washing-down purposes."
(11)	[F01,F02-OS1.2]
<b>3.6.3.4. Exhaust Duct Negative Pressure</b>	
(1)	[F03-OS1.2]
<b>3.6.3.5. Grease Duct Enclosures</b>	
(1)	[F02,F03-OS1.2]
	[F02,F03-OP1.2]
(2)	[F02,F03-OS1.2]
	[F02,F03-OP1.2]
<b>3.6.4.2. Fire Separations for Horizontal Service Spaces</b>	
(2)	[F03-OS1.2]
	[F03-OP1.2]
<b>3.6.4.3. Plenum Requirements</b>	
(1)	[F02-OS1.2]

**Table 3.10.1.1. (Continued)**

Functional Statements and Objectives <sup>(1)</sup>	
(2)	[F03-OS1.2,OS1.3] [F03-OP1.2,OP1.3]
<b>3.6.4.4. Attic or Roof Space Access</b>	
(1)	[F01,F02,F12-OS1.2] [F01,F02,F12-OP1.2]
<b>3.6.4.5. Horizontal Service Space Access</b>	
(1)	[F01,F02,F12-OS1.2] [F01,F02,F12-OP1.2]
<b>3.6.4.6. Crawl Space Access</b>	
(1)	[F01,F02,F12-OS1.2] [F01,F02,F12-OP1.2]
<b>3.6.5.1. Duct Materials</b>	
(1)	[F01,F02-OS1.2]
(2)	[F02-OS1.2]
(4)	[F02-OS1.2]
(5)	[F02-OS1.2]
<b>3.6.5.2. Vibration Isolation Connectors</b>	
(1)	[F01,F02-OS1.2]
(2)	[F02-OS1.2]
<b>3.6.5.3. Tape</b>	
(1)	[F02-OS1.2]
<b>3.6.5.4. Coverings, Linings, Adhesives and Insulation</b>	
(1)	[F02-OS1.2]
(2)	[F02-OS1.2]
(3)	[F02-OS1.2]
(4)	[F02-OS1.2]
(5)	[F02-OS1.2]
(6)	[F02-OS1.2]
(7)	[F01,F02-OS1.2]
<b>3.6.5.5. Insulation and Coverings</b>	
(1)	[F01,F02-OS1.2]
(2)	[F02-OS1.2]
(3)	[F02-OS1.2]
(4)	[F02-OS1.2]
<b>3.6.5.6. Clearance of Ducts and Plenums</b>	
(2)	[F01-OS1.2]
(3)	[F01-OS1.2]
(4)	[F01-OS1.2]
(5)	[F01-OS1.2]
<b>3.6.5.7. Supply, Return, Intake and Exhaust-Air Openings</b>	
(1)	[F02-OS1.2]
<b>3.6.5.8. Return-Air System</b>	
(1)	[F02-OS1.2]

**Table 3.10.1.1. (Continued)**

Functional Statements and Objectives <sup>(1)</sup>	
(2)	[F01,F02-OS1.2]
(3)	[F01,F02-OS1.2]
(4)	[F01,F02-OS1.2]
<b>3.7.1.1. Room and Space Height</b>	
(1)	[F30-OS3.1]
<b>3.7.2.1. Plumbing and Drainage Systems</b>	
(1)	[F72-OH2.1]
(2)	[F72-OH2.1]
<b>3.7.2.2. Water Closets</b>	
(1)	[F72-OH2.1] Applies to portion of Code text: "... water closets shall be provided ..."
(6)	[F72-OH2.1]
(7)	[F72-OH2.1]
(8)	[F72-OH2.1]
(9)	[F72-OH2.1]
(10)	[F72-OH2.1]
(11)	[F72-OH2.1]
(12)	[F72-OH2.1]
(13)	[F72-OH2.1]
(14)	[F72-OH2.1]
(15)	[F72-OH2.1]
(16)	[F72-OH2.1]
<b>3.7.2.3. Lavatories</b>	
(1)	[F71-OH2.3]
(3)	[F30-OS3.1]
(4)	[F71-OH2.3]
<b>3.7.2.4. Mobile Home Facilities</b>	
(1)	[F72-OH2.1] [F71-OH2.3]
(2)	[F72-OH2.1]
(3)	[F71-OH2.3] Applies to the minimum number of laundry trays or similar facilities, and of bathtubs or showers for each sex.
<b>3.7.2.5. Safety Glass</b>	
(1)	[F20-OS3.1]
<b>3.7.2.6. Surface Protection</b>	
(1)	[F72-OH2.1] [F40-OH2.4]
(2)	[F72-OH2.1] [F40-OH2.4]
<b>3.7.2.7. Floor Drain</b>	
(1)	[F40-OH2.4] [F30-OS3.1]
<b>3.7.2.8. Grab Bars</b>	
(1)	[F20-OS3.1]

Table 3.10.1.1. (Continued)

Functional Statements and Objectives <sup>(1)</sup>	
<b>3.7.2.9. Bathtubs</b>	
(1)	[F74-OA2]
	(b) [F31-OS3.2]
	(d) [F30-OS3.1]
<b>3.7.3.1. Medical Gas Piping</b>	
(1)	[F43,F81,F82-OS3.4]
	[F01,F02-OS1.1]
	[F01,F02-OP1.1]
<b>3.8.2.2. Entrances</b>	
(1)	[F73-OA1]
(2)	[F73-OA1]
(5)	[F73-OA1]
<b>3.8.2.3. Areas Requiring a Barrier-Free Path of Travel</b>	
(1)	[F73-OA1]
(3)	[F74-OA2]
<b>3.8.2.4. Access to Storeys Served by Escalators and Moving Walks</b>	
(1)	[F73-OA1]
(2)	[F73-OA1]
<b>3.8.2.5. Access to Parking Areas and Exterior Passenger-Loading Zones</b>	
(1)	[F73-OA1]
(2)	[F73-OA1]
<b>3.8.2.7. Power Door Operators</b>	
(1)	[F73-OA1]
<b>3.8.2.8. Plumbing Facilities</b>	
(1)	[F74-OA2]
	[F72-OH2.1] [F71-OH2.3]
(3)	[F72-OH2.1]
	[F73-OA1]
<b>3.8.2.10. Signs and Indicators</b>	
(1)	[F74-OA2]
(2)	[F74-OA2]
<b>3.8.2.11. Counters and Counters for Telephones</b>	
(1)	[F74-OA2]
(2)	[F74-OA2]
<b>3.8.3.2. Barrier-Free Path of Travel</b>	
(1)	[F73-OA1]
(2)	(a),(b) [F30-OS3.1]
	(a),(b) [F73-OA1]
	(c),(d) [F73-OA1]
	(e),(f) [F73-OA1]
	(e),(f) [F30-OS3.1]
	(c),(d) [F30-OS3.1]

Table 3.10.1.1. (Continued)

Functional Statements and Objectives <sup>(1)</sup>	
(4)	[F73-OA1]
<b>3.8.3.3. Exterior Walks</b>	
(1)	(a) [F73-OA1]
	(a) [F30-OS3.1]
	(b) [F73-OA1]
<b>3.8.3.4. Exterior Passenger-Loading Zones</b>	
(1)	(a) [F74-OA2]
	(b) [F73-OA1]
	(c) [F74-OA2]
<b>3.8.3.5. Ramps</b>	
(1)	(b),(e) [F73-OA1]
	(d) [F30-OS3.1]
	(c) [F73-OA1]
	(d) [F73-OA1]
	(b),(e) [F30-OS3.1]
	(c) [F30-OS3.1]
(4)	(a) [F73-OA1]
	(b) and (c) [F30-OS3.1]
(5)	[F30-OS3.1]
<b>3.8.3.6. Doorways and Doors</b>	
(2)	[F73-OA1]
(3)	[F74-OA2]
(4)	[F74-OA2]
	[F10-OS3.7]
(5)	[F74-OA2]
	[F10-OS3.7]
(6)	[F73-OA1]
(7)	[F30,F73-OS3.1]
(8)	[F73-OA1]
(10)	[F30-OS3.1]
	[F73-OA1]
(11)	[F73-OA1]
(12)	[F30-OS3.1]
	[F73-OA1]
(14)	[F73-OA1]
<b>3.8.3.7. Passenger-Elevating Devices</b>	
(1)	[F30-OS3.1] [F10-OS3.7]
<b>3.8.3.8. Controls</b>	
(1)	[F74-OA2]
	[F10-OS3.7]
<b>3.8.3.9. Accessibility Signs</b>	
(1)	[F74-OA2]
	[F73-OA1]

Copyright © NRC 1941 - 2021 World Rights Reserved © CNRC 1941-2021 Droits réservés pour tous pays



**Table 3.10.1.1. (Continued)**

Functional Statements and Objectives <sup>(1)</sup>	
<b>3.8.3.10. Drinking Fountains</b>	
(1)	[F74-OA2]
<b>3.8.3.11. Water-Closet Stalls</b>	
(1)	[F74-OA2]
	[F72-OH2.1]
	(c)(i) [F74-OA2]
	(e) and (f) [F30,F20-OS3.1]
	(g) [F30-OS3.1] Applies to portion of Code text: "... be equipped with a coat hook ... projecting not more than 50 mm from the wall ..."
<b>3.8.3.12. Universal Washrooms</b>	
(1)	[F74-OA2]
	(b) [F10-OS3.7]
	(f) [F30-OS3.1] Applies to the requirement for a coat hook.
	(h) [F74-OA2] Applies to the requirement for a shelf.
	[F72-OH2.1] [F71-OH2.3]
	(b) [F74-OA2] Applies to portion of Code text: "... b) ... a door capable of being locked from the inside ..."
<b>3.8.3.13. Water Closets</b>	
(1)	[F74-OA2]
	[F72-OH2.1]
<b>3.8.3.14. Urinals</b>	
(1)	[F74-OA2]
	(f) [F30-OS3.1]
<b>3.8.3.15. Lavatories and Mirrors</b>	
(1)	[F74-OA2]
	[F71-OH2.3]
	(e) [F31-OS3.2]
(2)	[F74-OA2]
<b>3.8.3.16. Showers</b>	
(1)	[F74-OA2]
	(d),(e) [F30-OS3.1]
	(f) [F30-OS3.1]
	(h) [F31-OS3.2]
<b>3.8.3.17. Bathtubs</b>	
(1)	[F74-OA2]
<b>3.8.3.18. Assistive Listening Devices</b>	
(1)	[F74-OA2]
	[F11-OS3.7]
<b>3.8.3.19. Counters</b>	
(1)	[F74-OA2]
<b>3.8.3.20. Shelves or Counters for Telephones</b>	
(1)	[F74-OA2]
(2)	[F74-OA2]

**Table 3.10.1.1. (Continued)**

Functional Statements and Objectives <sup>(1)</sup>	
<b>3.8.3.21. Spaces in Seating Area</b>	
(1)	[F74-OA2] Applies to entire Sentence except for portion of Code text: "... without infringing on egress from any row of seating or any aisle requirements ..."
	[F30-OS3.1] Applies to portion of Code text: "... level, or level with removable seats ..."
	(d) [F10-OS3.7]
<b>3.9.2.2. Spatial Separation</b>	
(2)	[F12-OP3.1]
(3)	[F12-OP3.1]
<b>3.9.3.1. Safety Requirements Within Floor Areas</b>	
(2)	[F02-OS1.2]
(3)	[F03-OS1.2]
	[F03-OP1.2]
(6)	[F02-OP1.2]
<b>3.9.3.2. Sanitary Facilities</b>	
(1)	[F72-OH2.1]
	[F71-OH2.3]

**Notes to Table 3.10.1.1.:**

(1) See Parts 2 and 3 of Division A.



# Notes to Part 3

## Fire Protection, Occupant Safety and Accessibility

**A-3 Application of Part 3.** In applying the requirements of this Part, it is intended that they be applied with discretion to buildings of unusual configuration that do not clearly conform to the specific requirements, or to buildings in which processes are carried out which make compliance with particular requirements in this Part impracticable. The definition of “building” as it applies to this Code is general and encompasses most structures, including those which would not normally be considered as buildings in the layman’s sense. This occurs more often in industrial uses, particularly those involving manufacturing facilities and equipment that require specialized design that may make it impracticable to follow the specific requirements of this Part. Steel mills, aluminum plants, refining, power generation and liquid storage facilities are examples. A water tank or an oil refinery, for example, has no floor area, so it is obvious that requirements for exits from floor areas would not apply. Requirements for structural fire protection in large steel mills and pulp and paper mills, particularly in certain portions, may not be practicable to achieve in terms of the construction normally used and the operations for which the space is to be used. In other portions of the same building, however, it may be quite reasonable to require that the provisions of this Part be applied (e.g., the office portions). Similarly, areas of industrial occupancy which may be occupied only periodically by service staff, such as equipment penthouses, normally would not need to have the same type of exit facility as floor areas occupied on a continuing basis. It is expected that judgment will be exercised in evaluating the application of a requirement in those cases when extenuating circumstances require special consideration, provided the occupants’ safety is not endangered.

The provisions in this Part for fire protection features installed in buildings are intended to provide a minimum acceptable level of public safety. It is intended that all fire protection features of a building, whether required or not, will be designed in conformance with good fire protection engineering practice and will meet the appropriate installation requirements in relevant standards. Good design is necessary to ensure that the level of public safety established by the Code requirements will not be reduced by a voluntary installation.

### Firefighting Assumptions

The requirements of this Part are based on the assumption that firefighting capabilities are available in the event of a fire emergency. These firefighting capabilities may take the form of a paid or volunteer public fire department or in some cases a private fire brigade. If these firefighting capabilities are not available, additional fire safety measures may be required.

Firefighting capability can vary from municipality to municipality. Generally, larger municipalities have greater firefighting capability than smaller ones. Similarly, older, well established municipalities may have better firefighting facilities than newly formed or rapidly growing ones. The level of municipal fire protection considered to be adequate will normally depend on both the size of the municipality (i.e., the number of buildings to be protected) and the size of buildings within that municipality. Since larger buildings tend to be located in larger municipalities, they are generally, but not always, favoured with a higher level of municipal protection.

Although it is reasonable to consider that some level of municipal firefighting capability was assumed in developing the fire safety provisions in Part 3, this was not done on a consistent or defined basis. The requirements in the Code, while developed in the light of commonly prevailing municipal fire protection levels, do not attempt to relate the size of building to the level of municipal protection. The responsibility for controlling the maximum size of building to be permitted in a municipality in relation to local firefighting capability rests with the municipality. If a proposed building is too large, either in terms of floor area or building height, to receive reasonable protection from the municipal fire department, fire protection requirements in addition to those prescribed in this Code, may be necessary to compensate for this deficiency. Automatic sprinkler protection may be one option to be considered.

---

These Notes are included for explanatory purposes only and do not form part of the requirements. The number that introduces each Note corresponds to the applicable requirement in this Part.

Alternatively, the municipality may, in light of its firefighting capability, elect to introduce zoning restrictions to ensure that the maximum building size is related to available municipal fire protection facilities. This is, by necessity, a somewhat arbitrary decision and should be made in consultation with the local firefighting service, who should have an appreciation of their capability to fight fires.

The requirements of Subsection 3.2.3. are intended to prevent fire spread from thermal radiation assuming there is adequate firefighting available. It has been found that periods of from 10 to 30 minutes usually elapse between the outbreak of fire in a building that is not protected with an automatic sprinkler system and the attainment of high radiation levels. During this period, the specified spatial separations should prove adequate to inhibit ignition of an exposed building face or the interior of an adjacent building by radiation. Subsequently, however, reduction of the fire intensity by firefighting and the protective wetting of the exposed building face will often be necessary as supplementary measures to inhibit fire spread.

In the case of a building that is sprinklered throughout, the automatic sprinkler system should control the fire to an extent that radiation to neighbouring buildings should be minimal. Although there will be some radiation effect on a sprinklered building from a fire in a neighbouring building, the internal sprinkler system should control any fires that might be ignited in the building and thereby minimize the possibility of the fire spreading into the exposed building. NFPA 80A, "Protection of Buildings from Exterior Fire Exposures," provides additional information on the possibility of fire spread at building exteriors.

The water supply requirements for fire protection installations depend on the requirements of any automatic sprinkler installations and also on the number of fire streams that may be needed at any fire, having regard to the length of time the streams will have to be used. Both these factors are largely influenced by the conditions at the building to be equipped, and the quantity and pressure of water needed for the protection of both the interior and exterior of the building must be ascertained before the water supply is decided upon. Acceptable water supplies may be a public waterworks system that has adequate pressure and discharge capacity, automatic fire pumps, pressure tanks, manually controlled fire pumps in combination with pressure tanks, gravity tanks, and manually controlled fire pumps operated by remote control devices at each hose station.

**A-3.1.2. Use Classification.** The purpose of classification is to determine which requirements apply. This Code requires classification in accordance with every major occupancy for which the building is used or intended to be used. Where necessary, an application clause has been inserted in this Part to explain how to choose between the alternative requirements which multiple occupancy classification may present.

**A-3.1.2.1.(1) Major Occupancy Classification.** The following are examples of the major occupancy classifications described in Table 3.1.2.1.:

**Group A, Division 1**

- Motion picture theatres
- Opera houses
- Television studios admitting a viewing audience
- Theatres, including experimental theatres

**Group A, Division 2**

- Art galleries
- Auditoria
- Bowling alleys
- Churches and similar places of worship
- Clubs, nonresidential
- Community halls
- Courtrooms
- Dance halls
- Exhibition halls (other than classified in Group E)
- Gymnasias
- Lecture halls
- Libraries
- Licensed beverage establishments
- Museums
- Passenger stations and depots
- Recreational piers
- Restaurants
- Schools and colleges, nonresidential

Undertaking premises

**Group A, Division 3**

Arenas

Indoor swimming pools, with or without spectator seating

Rinks

**Group A, Division 4**

Amusement park structures (not elsewhere classified)

Bleachers

Grandstands

Reviewing stands

Stadia

**Group B, Division 1**

Jails

Penitentiaries

Police stations with detention quarters

Prisons

Psychiatric hospitals with detention quarters

Reformatories with detention quarters

**Group B, Division 2**

Care facilities with treatment

Convalescent /recovery/rehabilitation centres with treatment

Hospices with treatment

Hospitals

Infirmaries

Nursing homes with treatment

Psychiatric hospitals without detention quarters

Respite centres with treatment

**Group B, Division 3**

Assisted/supportive living facilities

Care facilities without treatment

Children's custodial homes

Convalescent/recovery/rehabilitation centres without treatment

Group homes

Hospices without treatment

Nursing homes without treatment

Reformatories without detention quarters

Respite centres without treatment

**Group C**

Apartments

Boarding houses

Clubs, residential

Colleges, residential

Convents

Dormitories

Hotels

Houses

Lodging houses

Monasteries

Motels

Schools, residential

**Group D**

Banks

Barber and hairdressing shops

Beauty parlours

Dental offices

Dry cleaning establishments, self-service, not using flammable or explosive solvents or cleaners

Laundries, self-service

Medical offices

Offices  
Police stations without detention quarters  
Radio stations  
Small tool and appliance rental and service establishments

**Group E**

Department stores  
Exhibition halls  
Markets  
Shops  
Stores  
Supermarkets

**Group F, Division 1**

Bulk plants for flammable liquids  
Bulk storage warehouses for hazardous substances  
Cereal mills  
Chemical manufacturing or processing plants  
Distilleries  
Dry cleaning plants  
Feed mills  
Flour mills  
Grain elevators  
Lacquer factories  
Mattress factories  
Paint, varnish and pyroxylin product factories  
Rubber processing plants  
Spray painting operations  
Waste paper processing plants

**Group F, Division 2**

Aircraft hangars  
Box factories  
Candy plants  
Cold storage plants  
Dry cleaning establishments not using flammable or explosive solvents or cleaners  
Electrical substations  
Factories  
Freight depots  
Helicopter landing areas on roofs  
Laboratories  
Laundries, except self-service  
Mattress factories  
Planing mills  
Printing plants  
Repair garages  
Salesrooms  
Service stations  
Storage rooms  
Television studios not admitting a viewing audience  
Warehouses  
Wholesale rooms  
Woodworking factories  
Workshops

**Group F, Division 3**

Creameries  
Factories  
Laboratories  
Light-aircraft hangars (storage only)  
Power plants  
Salesrooms  
Sample display rooms

Storage garages, including open air parking garages  
Storage rooms  
Warehouses  
Workshops

**A-3.1.2.3.(1) Arena Regulation.** The use of an arena is regulated in the NFC.

**A-3.1.3.2.(3) to (5) Occupancy Combinations in Hybrid Structures.** Buildings conforming to Article 3.2.2.50. or 3.2.2.58. may be entirely constructed of combustible construction and incorporate the occupancies specifically permitted by Sentence 3.2.2.7.(3). Alternatively, the requirements of Articles 3.2.2.4. to 3.2.2.8. for superimposed major occupancies can be applied, resulting in buildings of mixed (hybrid) construction where the lower storeys are of noncombustible construction and the upper storeys are of combustible construction. For example, Group A, Division 2 or Group E major occupancies could be located on the first 2 storeys of a 5- or 6-storey Group C building constructed in accordance with Article 3.2.2.50., provided that these 2 storeys are constructed of noncombustible construction in accordance with Article 3.2.2.23. or 3.2.2.24. in the case of a Group A, Division 2 major occupancy, and Article 3.2.2.62. in the case of a Group E major occupancy. (See also Clause 3.2.2.7.(3)(b).)

**A-3.1.4.1.(1) Combustible Construction and Materials Permitted.** The permission to use combustible construction or combustible materials stated in Articles 3.1.4.1., 3.1.5.5., 3.1.5.14. and 3.1.5.15. does not waive the requirements regarding construction type and cladding stated in Article 3.2.3.7.

**A-3.1.4.2. Protection of Penetrations.** Where foamed plastics are required to be protected from adjacent spaces within a building, the protection should be continuous so as to cover the foamed plastics so they are not exposed to the interior of the building. However, minor penetrations of the protective covering by small electrical and mechanical components, such as electrical outlets and fixtures, sprinkler piping, and mechanical vents, are acceptable because the penetrant and associated fittings and seals will prevent the small amount of foamed plastic surrounding the penetration from being exposed to the interior of the building.

Foamed plastics that are penetrated by larger components or assemblies, such as windows, are unlikely to be exposed to the interior of the building as they are protected by associated framing and finishes and/or the installation of a closure.

Small amounts of foamed plastics, such as air sealants used between major components of exterior wall construction, are not required to be protected (see Sentence 3.1.5.2.(1)).

Penetrations of a fire separation or of a membrane forming part of an assembly required to have a fire-resistance rating are nevertheless required to be provided with a fire stop in accordance with Subsection 3.1.9.

**A-3.1.4.2.(1) Concealed Space.** The term “concealed space” includes any space that is not visibly apparent and that is provided with an opening to allow access for repair and periodic inspections.

**A-3.1.4.2.(1)(c) Thermal Barrier in Combustible Construction.** Any thermal barrier that is accepted under the requirements of Sentence 3.1.5.15.(2) for noncombustible construction is also acceptable for combustible construction.

**A-3.1.4.2.(2) and 3.1.5.7.(3) Walk-in Coolers and Freezers.** Sentences 3.1.4.2.(2) and 3.1.5.7.(3) are intended to apply to walk-in coolers and freezers that are constructed as stand-alone structures within a building.

**A-3.1.4.3.(1)(b)(i) Raceway Definition.** The term raceway is defined in CSA C22.1, “Canadian Electrical Code, Part I,” and includes both rigid and flexible conduit.

**A-3.1.4.3.(1) Wire and Cable Equivalence.** Electrical wires and cables that conform to the requirements of Sentence 3.1.5.21.(1) are deemed to satisfy the requirements of Sentence 3.1.4.3.(1).

**A-3.1.4.8.(1) Exterior Cladding.** The requirements in Sentence 3.1.4.8.(1) are intended to limit the potential for fire spread on the exterior cladding of buildings of combustible construction through the use of noncombustible finishes on the exterior of the wall assembly or the use of a cladding/wall assembly that has been assessed with regard to its ability to resist flame propagation up the outside of a building. These cladding and wall assembly combinations can be used as infill or panel-type walls between structural elements, or attached directly to a loadbearing structural system. Note that these requirements apply independently of the provisions contained in Subsection 3.2.3. regarding spatial separation and exposure protection.

**A-3.1.5.4.(1) Skylight Spacing.** The minimum spacing dimensions for skylight assemblies are based on the distance that flame must travel along a flat ceiling surface. If ceilings have projecting beams or other features that would increase the distance the flame would have to travel along the surface, the distances specified may be measured accordingly.

**A-3.1.5.5.(1)(b) Combustible Cladding on Exterior Walls.** The performance of the wall assembly is assessed with regard to its ability to resist flame propagation up the outside of a building.

**A-3.1.5.5.(1)(b)(i) Flame-Spread Distance.** The maximum flame-spread distance referred to in Subclause 3.1.5.5.(1)(b)(i) means the distance between the top of the opening and the highest observable instance of flaming along the wall assembly; thus, intermittent flaming to a height of 5 m above the opening is acceptable.

**A-3.1.5.5.(1)(b)(ii) Heat Flux Measurement.** The heat flux to the assembly referred to in Subclause 3.1.5.5.(1)(b)(ii) is the maximum one-minute averaged heat flux measured by transducers located 3.5 m above the top of the opening. The intent of this criterion is to limit the spread of fire on the wall assembly to a height of 3.5 m above the opening.

Fire tests have shown that flame does not spread on the exterior surface of a wall assembly where the heat flux is less than 35 kW/m<sup>2</sup> above the opening.

**A-3.1.5.14.(5)(d) Foamed Plastic Insulation Protection.** The standard fire exposure temperature in CAN/ULC-S101, "Fire Endurance Tests of Building Construction and Materials," is the same as in CAN/ULC-S124, "Test for the Evaluation of Protective Coverings for Foamed Plastic." A thermal barrier that, when tested in conformance with CAN/ULC-S101, does not exceed an average temperature rise of 140°C on its unexposed face after a period of 10 min satisfies this requirement.

**A-3.1.5.21.(1) Wire and Cable Flammability.** In regulating the flammability characteristics of electrical wires and cables installed in a building, it is intended that the requirements of this Sentence and of other similar Sentences in the Code apply to wires and cables that are essentially a part of the distribution systems for power or communications. These distribution systems will normally include branch circuits that terminate at an outlet box in the space to be served and at that location cable terminators or plugs for individual items of equipment will be plugged in.

**A-3.1.6. Tents and Air-Supported Structures.** The requirements in this Subsection are intended to be limited to certain types of structure. For instance, the word "tent" as used in the Code is intended to refer to a temporary shelter which is used at an open air event such as a fair or an exhibition. A tent will normally be constructed of a fabric held up by poles and attached to the ground by ties. The requirements for tents, however, are not intended to be applied to fabric structures located on buildings.

The term "air-supported structure," as used in the Code, refers to an envelope which is held up by air pressure alone and which is erected on the ground or above a basement. The structure will usually require ballast or a positive ground anchorage system around the entire perimeter to secure it to the ground or basement. To reinforce this intent, the Code prohibits the location of an air-supported structure above the first storey of any building.

The requirements of Subsection 3.1.6. are not intended to apply to air-supported roof assemblies on buildings, such as domed stadia, or to other types of air-supported structures, such as those over swimming pools situated on the roofs of buildings, which would not be anchored at or near ground level. These assemblies or structures are normally designed and evaluated on the basis of alternative solutions as permitted by Article 1.2.1.1. of Division A.

**A-3.1.8.1.(1)(b) Barrier to Control Smoke Spread.** Although a fire separation is not always required to have a fire-resistance rating, the fire separation should act as a barrier to the spread of smoke and fire until some response is initiated.



When choosing products for fire stopping, the physical characteristics of the material used at the joints as well as the nature of the assembly and its potential movement should be taken into consideration.

If the fire-resistance rating of a fire separation is waived on the basis of the presence of an automatic sprinkler system, it is intended that the fire separation will be constructed so that it will remain in place and act as a barrier against the spread of smoke for a period of time until the sprinklers have actuated and controlled the fire.

**A-3.1.8.1.(2) Installation of Closures.** Although there is no explicit performance statement in the NBC that means of egress should be free of smoke, it is the intent that during the period when occupants are using a means of egress to evacuate from a floor area, the smoke contamination should not reach levels that would inhibit movement to the exit. This is particularly critical for persons with disabilities, who may not move at the same rate as other persons and who could be more susceptible to the effects of smoke contamination. NFPA 80, "Fire Doors and Other Opening Protectives," requires that a fire door protecting a means of egress be designed to minimize the possibility of smoke passing through the opening.

Although self-closing devices are not required for all doors in a fire separation (see Article 3.1.8.13.), it is assumed that in a fire situation every door in a fire separation is closed. Article 3.3.3.5. prohibits grilles and similar openings for certain doors in hospitals and nursing homes with treatment.

Although fire dampers that release on the fusion of a fusible link will help to control the spread of fire, a substantial quantity of smoke could have passed through the opening before that event. They are frequently located below the upper levels of a room and so the release of the fusible link of the fire damper that protects an opening will be delayed until the temperature at the level of the opening becomes high enough to fuse the link.

Similar concern has to be considered for other closure devices that are permitted to remain open on fusible links, and their location should be restricted in accordance with NFPA 80 and the NBC, except where their installation in another location will not allow the products of combustion to spread into means of egress.

**A-3.1.8.3.(4) Fire Separation Continuity.** The continuity of a fire separation where it abuts against another fire separation, a floor, a ceiling or an exterior wall assembly is maintained by filling all openings at the juncture of the assemblies with a material that will ensure the integrity of the fire separation at that location.

**A-3.1.8.10.(1) Combination Smoke/Fire Dampers.** A combination smoke/fire damper may be used in lieu of a fire damper to meet the requirement of Sentence 3.1.8.10.(3).

**A-3.1.8.10.(5) Damper Access.** It is intended that an access door be provided in the duct and, if the duct is enclosed with an architectural finish, that a second access door be provided through that finish.

**A-3.1.8.18.(1) Wired Glass and Glass Block.** The permission to include wired glass and glass block in doors and fire separations between an exit and the adjacent floor area does not permit the inclusion of those items in fire separations between exits and other parts of the building that are not included in the floor area. Examples include other exit facilities and vertical service spaces, including those used for building services and elevator hoistways.

**A-3.1.8.19.(1) Fire-Protection Rating for Doors.** The provisions in Articles 3.1.8.17., 3.1.8.18. and 3.1.8.19. do not waive a requirement for a door to have a fire-protection rating. To achieve this rating in a door test, it may be necessary to limit the area of glass in the door. If this area is less than the area limits of Article 3.1.8.18., it is the governing criterion. Conversely, if the area limits of Article 3.1.8.18. are less than the area required to achieve a fire-protection rating, then the area limits of this Article govern.

**A-3.1.9. Penetrations.** In the application of Subsection 3.1.9., a building service is considered to penetrate an assembly if it passes into or through the assembly. In some situations a service item enters an assembly through a membrane at one location, runs within the assembly, and then leaves the assembly through a membrane at another location.

The term "membrane penetration" usually designates an opening made through one side (wall, floor or ceiling membrane) of an assembly, whereas the term "through-penetration" designates an opening that passes through an entire assembly. Fire stopping of membrane penetrations involves installing a material, device or construction to resist for a prescribed time period the passage of flame and heat through openings in a protective membrane caused by cables, cable trays, conduit, tubing, pipes or similar items. Fire stopping of a through-penetration involves installing an assemblage of specific materials or products that are designed, tested and fire-resistance rated to resist for a prescribed period of time the spread of fire through penetrations.

Products for fire stopping within a barrier are required to address movement of the assembly and to control smoke spread; as such, the flexibility of the material used at the flexible joints as well as the nature of the assembly and its potential movement must be taken into consideration.

**A-3.1.9.1.(1)(b) Penetration.** The intention behind the use of the term “cast in place” is to reinforce that there are to be no gaps between the building service or penetrating item and the membrane or assembly it penetrates. The term “cast in place” describes a typical means of fire stopping for a service penetration through a concrete slab or wall.

**A-3.1.9.2.(1) Penetration of Fire Separations by Electrical Boxes.** The provisions dealing with outlet boxes assume size, quantities and concentrations of partial depth penetrations that would not significantly affect the fire resistance of the assembly, including the temperature rise on the unexposed side of a wall. Sentence 3.1.9.2.(1) is not intended to allow large electrical distribution and control boxes to be recessed into an assembly required to have a fire-resistance rating unless they were incorporated in the assembly at the time of testing.

**A-3.1.9.4. Outlet Boxes.** For the purposes of Article 3.1.9.4., outlet boxes include, but are not limited to, electrical boxes, junction boxes, high and low voltage outlets, switches, enclosures for electrical equipment, laundry boxes, and shower diverters.

**A-3.1.10.2.(4) Firewall Construction.** Inherent in the use of a firewall is the intent that this specialized wall construction provide the required fire-resistance rating while also being designed to resist physical damage—arising out of normal use—that would compromise the rating of the assembly. Traditionally, this has been accomplished by prescribing the use of noncombustible materials, which was in fact restricted to concrete or masonry. Sentences 3.1.10.2.(3) and (4) are intended to retain both of the characteristics of firewalls, while permitting greater flexibility in the use of materials and designs. The fire-resistance rating and damage protection attributes of a firewall may be provided by a single fire- and damage-resistant material such as concrete or masonry, by a fire- and damage-resistant membrane on a structural frame, or by separate components—one that provides the fire-resistance rating and another one that protects the firewall against damage.

If the firewall is composed of separate components, the fire-resistance rating of the fire-resistive component needs to be determined for this assembly on its own. In addition, if the damage protection component is physically attached to the fire-resistive component (for example, as a sacrificial layer), then for the purposes of determining the overall performance of the assembly, it is also necessary to determine through testing whether failure of the damage protection component during a fire affects the performance of the fire-resistive component.

**A-3.1.11.5.(1) Fire Blocks in Combustible Construction.** Combustible construction referred to in Sentence 3.1.11.5.(1) includes all types of construction that do not comply with the requirements for noncombustible construction. All the elements within the concealed space can be combustible, unless required to be of noncombustible materials (e.g., certain categories of pipework and ducts), but the value of the flame-spread rating of the combustible materials determines the permitted extent of the concealed space between fire blocks. The materials to be considered include all construction materials regulated by this Code, including the framing and building services that are located in the concealed space. When designing fire blocking, consideration should be given to avoid restricting venting capabilities within concealed spaces. (See also Note A-5.6.2.1.)

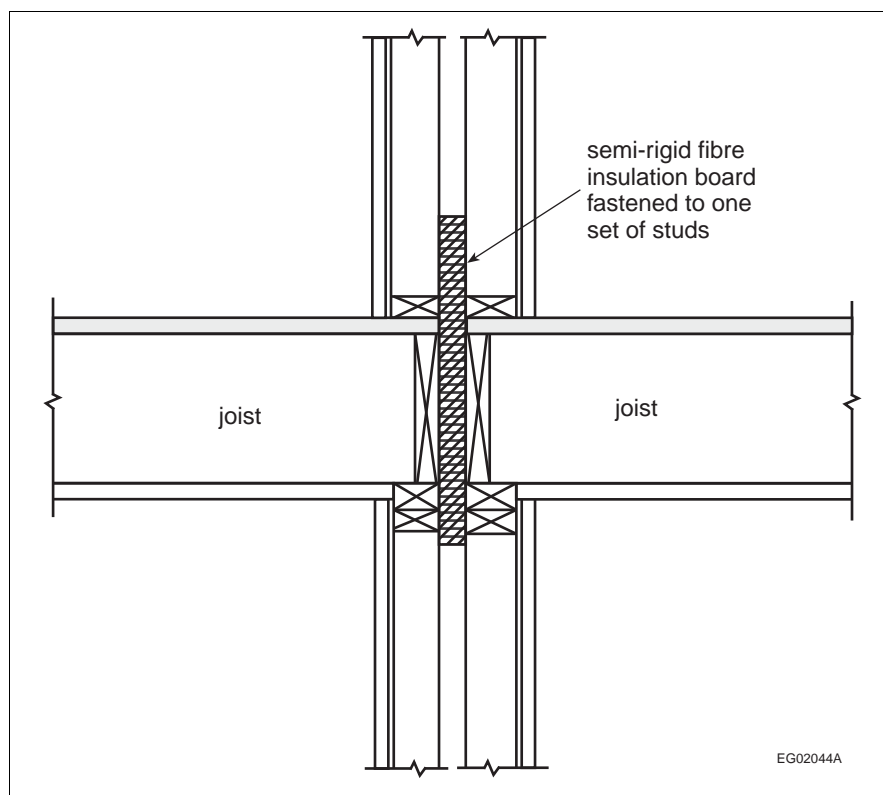
**A-3.1.11.5.(3) Fire Blocks in Concealed Spaces.** To reduce the risk of fire spread in combustible concealed spaces within the types of buildings referred to in Sentence 3.1.11.5.(3), fire blocking is required regardless of whether the horizontal concealed space is protected by sprinklers or not, unless the space is filled with noncombustible insulation so that any air gap at the top of the insulation is very small. See also Note A-3.1.11.5.(1) for roof venting.

A 5- or 6-storey building constructed in accordance with Article 3.2.2.50. and buildings constructed in accordance with Article 3.2.2.58. are required to be sprinklered in accordance with NFPA 13, “Installation of Sprinkler Systems” (see Article 3.2.5.12.). NFPA 13 generally requires sprinklering of any concealed spaces of combustible construction or where large amounts of combustibles are present. However, NFPA 13 allows combustible concealed spaces to be unsprinklered in certain cases, including where concealed spaces are filled almost entirely with noncombustible insulation, where spaces contain only materials with a low flame-spread rating, and where limited access or the size of the space makes it impractical to install sprinklers. For certain

types of construction in unsprinklered combustible concealed spaces, NFPA 13 mandates fire blocking beyond the minimum specified in Sentence 3.1.11.5.(3).

**A-3.1.11.7.(6) Integrity of Fire Blocks.** Sentence 3.1.11.7.(6) together with Article 3.1.9.1., is intended to ensure that the integrity of fire blocks is maintained at areas where they are penetrated. This requirement is satisfied by the use of generic fire stops such as mineral wool, gypsum plaster or Portland cement mortar, as well as rated fire stops.

**A-3.1.11.7.(7) Fire Blocks.** Figure A-3.1.11.7.(7) shows the location of the semi-rigid fibre insulation board at the intersection between walls and floors in wood-frame construction. The figure is intended to illustrate the fire block detail and not a design of a fire separation.



**Figure A-3.1.11.7.(7)**  
**Fire block**

**A-3.1.13.2.(2) Folding Partition.** Folding partitions used to divide a space into separate rooms are not considered as doors for the purposes of this Sentence.

**A-3.2.1.1.(3)(a) Mezzanine Area.** The permitted area of the mezzanine for the purposes of determining the allowable percentage is to be based on the open area of the floor of the space in which the mezzanine is located. The Code does not restrict the enclosing of space below the mezzanine but the enclosed area must be deducted from the area of the overall space before applying the percentage allowance.

**A-3.2.1.1.(8) Accessible Service Space.** These service spaces are often referred to as interstitial spaces and are designed to allow service personnel to enter and undertake maintenance or installation within the space. Catwalks or flooring are usually included to provide a walking or access surface. Even when flooring is included, it is not intended that the interstitial space should be considered as a storey for the purposes of the Code unless the space is used for purposes other than servicing or the storage of materials and equipment to be used for building services within that space.

**A-3.2.2.2.(1) Special and Unusual Structures.** Examples of structures which cannot be identified with the descriptions of buildings in Articles 3.2.2.20. to 3.2.2.90. include grain elevators, refineries and towers. Publications that may be consulted to establish good engineering practice for the purposes of Article 3.2.2.2. include the NFPA “Fire Protection Handbook,” Factory Mutual Data Sheets, and publications of the Society for Fire Protection Engineering.

**A-3.2.2.18.(2) Sprinkler Extent.** A literal interpretation of Article 3.2.2.6. and Sentences 3.2.2.4.(1) and (2) could require installation of an automatic sprinkler system throughout all storeys of a building regardless of options in Articles 3.2.2.20. to 3.2.2.90. to construct one or more storeys without installation of sprinklers. It is the intent of the Code that all storeys below a storey in which an automatic sprinkler system is installed should also be protected by an automatic sprinkler system to ensure that a fire in a lower storey does not incapacitate the automatic sprinkler system or overwhelm an automatic sprinkler system in an upper storey. Persons in an upper storey in which waivers or reductions of other fire safety systems are permitted would be exposed to an increased risk from a fire on a lower storey. This concept also applies to situations in which an automatic sprinkler system has been installed within a floor area in order to modify other safety requirements applying within the floor area. If the uppermost storey or storeys of a building can be constructed without the installation of an automatic sprinkler system it is not necessary that an automatic sprinkler system required in a lower storey be extended into the upper storey or storeys.

**A-3.2.2.35.(4) Sprinkler Requirements.** Spaces in a building of Group A, Division 4 occupancy that are intended to be equipped with sprinklers include, but are not limited to, dressing and changing rooms, concession stands and areas, toilet rooms, locker rooms, storage areas, service rooms, offices and other spaces that provide service to the building. The enclosure of seating areas with glazing needs special consideration in determining the requirements for sprinklers. For example, if the enclosed area is used for the consumption of food and beverages, it should be classified as Group A, Division 2 and the appropriate requirements of that classification applied. Enclosure of limited spaces above seating areas for press and media purposes is not considered to require the installation of sprinklers.

**A-3.2.3. Fire Protection Related to Limiting Distance versus Separation Between Buildings.** Code provisions that address protection against fire spread from building to building use the limiting distance (see the definition in Article 1.4.1.2. of Division A) for a building rather than using the distance between adjacent buildings on separate properties, since this would result in situations where the design and construction of a building on one property affects the design and construction of a building on an adjacent property.

The Code requirements that deal with reducing the probability of building-to-building fire spread were originally developed based on the assumption that the exposing building faces of adjacent buildings are of similar size and configuration, and are equidistant from the shared property line. Where buildings are of different sizes, the smaller building may be subject to a higher heat flux in the event of a fire compared to the larger building. Where buildings are closely spaced and not equidistant from the property line, the construction of the building with the greater limiting distance does not recognize the proximity of the building with the lesser limiting distance.

The Code has more stringent requirements for buildings with lesser limiting distance as regards the maximum area and spacing of unprotected openings, and the construction, cladding and fire resistance of walls. This increased stringency recognizes that the fire hazard is greater where buildings are closer together and that adjacent buildings may have exposing building faces of different sizes, configurations or limiting distances, which could further increase the hazard.

The authority having jurisdiction may also address limiting distances through legal agreements with the parties involved that stipulate that the limiting distance be measured to a line that is not the property line. Such agreements would normally be registered with the titles of both properties.

**A-3.2.3.1.(4) Spatial Separation Design.** In the application of Sentences 3.2.3.1.(3) and (4), it is intended that Sentence (3) be used first to establish the basic requirements for the exterior wall in terms of fire-resistance rating, type of construction and type of cladding. The percentage of unprotected openings determined from the application of Sentence (3) would be unnecessarily restrictive if the actual unprotected openings occur in a plane that is set back from the front of the building face.

Sentence (4) applies to the calculation of the allowable percentage of unprotected openings based upon projection onto a plane that is in front of all unprotected openings. The application of these two Sentences is

shown in Figure A-3.2.3.1.(4). The modifications permitted by Article 3.2.3.12. would be applied, if applicable, to the area of unprotected openings derived from Sentence (4).

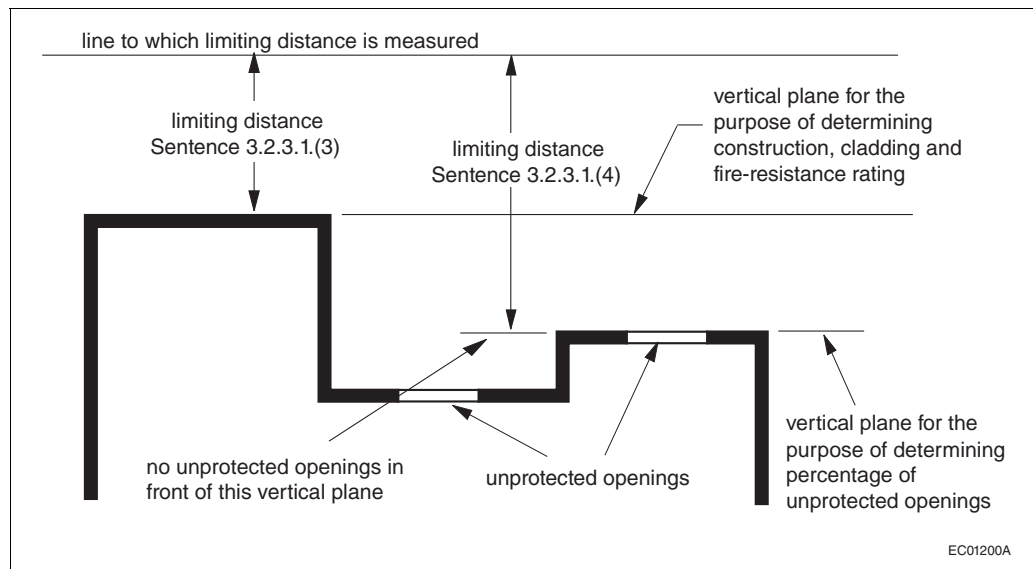


Figure A-3.2.3.1.(4)  
Spatial separation design

**A-3.2.3.1.(8) Intervention Time and Limiting Distance.** The total time from the start of a fire until fire suppression by the fire department depends on the time taken for a series of actions. Sentence 3.2.3.1.(8) is only concerned with the time from receipt of notification of a fire by the fire department until the arrival of the first fire department vehicle at the building. It specifies a 10-min time limit which must be met in more than 90% of the calls to the building served by the fire department. This reliability level and provision for flexibility is essentially consistent with NFPA 1710, “Organization and Deployment of Fire Suppression Operations, Emergency Medical Operations, and Special Operations to the Public by Career Fire Departments.”

Clause 4.1.2.1 of NFPA 1710 establishes “time objectives” for fire incidents as follows:

- 1 min (60 s) for turn-out of responders after receipt of notification of a fire, and
- 4 min (240 s) or less for arrival of the first arriving engine company at a fire suppression incident and/or 8 min (480 s) or less for the deployment of a full first alarm assignment at a fire suppression incident.

The standard requires that the fire department establish a “performance objective” of not less than 90% for each response time objective. This reliability level is referred to in NFPA 1710 as a “performance objective.”

Where the 10-min limit cannot be met by the fire department at least 90% of the time, Sentence 3.2.3.1.(8) specifies that a value corresponding to half the actual limiting distance be used in requirements that depend on limiting distance to define other criteria.

For new subdivisions, legal agreements may be made for the construction of fire stations to serve those areas. The fire department response time in those subdivisions may temporarily exceed 10 min until the fire station is constructed.

See also Sentences 9.10.14.3.(1) and 9.10.15.3.(1).

**A-3.2.3.4.(1) Party Walls.** By definition, a party wall is a wall jointly owned and used by two parties under easement agreement or by right in law, and is erected at or upon a line that separates two parcels of land that are, or are capable of being, separate real estate entities. With the exception of some Part 9 residential occupancies, both Part 3 and Part 9 of the Code require that, where party walls are constructed on property lines, they be constructed as a 2- or 4-hour firewall (see also Article 9.10.11.1.). Buildings on each side of a party wall that is constructed as a firewall are considered as separate buildings (see Article 1.3.3.4. of Division A).

In a Part 9 residential building that has no dwelling unit above another, a party wall constructed on a property line between two dwelling units need not be constructed as a firewall, but must be constructed as a continuous fire separation that extends from the top of the footings to the underside of the roof, with a fire-resistance rating of at least 1 hour (see Article 9.10.11.2.). These party walls do not create separate buildings.

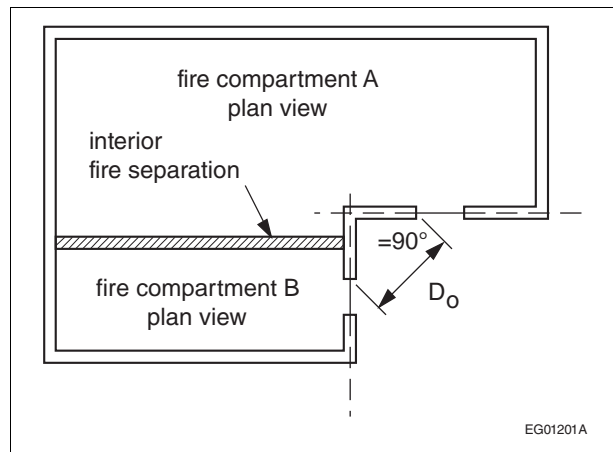
Where two parties share a party wall on a property line, each party is responsible for fire safety in their unit, but is still subject to possible fire risks from activities in the adjoining units. The separating party wall is intended to provide a significant degree of fire protection between the adjacent units, often exceeding even that required between suites in multiple-unit residential and non-residential occupancies.

When a building spans a property line, constructing a party wall on the property line is not mandated by the Code, but subdividing the building at the property line is an option the owner can consider. The Code permits a building constructed on more than one property to be designed as a single undivided building, whether the properties have a common owner or not. However, if a subdividing wall is constructed on the property line within the building for the purpose of separating the two real estate entities and is shared by two different owners, the wall would, by definition, be deemed a party wall. As such, this party wall would need to meet the construction requirements described above, depending on the building's occupancy classification and size.

A building that spans two or more properties, but that does not have a party wall at the property line, may need to address the Code requirements for party walls in the future.

**A-3.2.3.6.(2) Protection of Roof Soffits Near Property Lines.** Sentences 3.2.3.6.(2) to (5) and parallel Sentences 9.10.14.5.(5) to (7) and 9.10.15.5.(5) to (7) provide requirements for the protection of soffits where the soffit of the subject building is located close to the property line or to an imaginary line between two buildings on the same property. Fire from inside the roof space of the subject building can exit unprotected soffits and expose the adjacent building to flames.

**A-3.2.3.14.(1) Wall Exposed to Another Wall.** The requirements of Article 3.2.3.14. are to ensure that the control of fire spread by the interior fire separations between fire compartments is not defeated through the spread of fire by thermal radiation outside the building. Minimum spatial separations are specified between the openings in separate fire compartments where the exterior faces of these compartments are deemed to expose each other to a thermal radiation hazard. This situation may arise where the angle,  $\theta$ , between the intersecting planes of the exposing building faces is  $135^\circ$  or less. Examples of situations that would be addressed by this Article are shown in Figures A-3.2.3.14.(1)-A, A-3.2.3.14.(1)-B and A-3.2.3.14.(1)-C.



**Figure A-3.2.3.14.(1)-A**  
**Openings in walls at a right-angle corner**

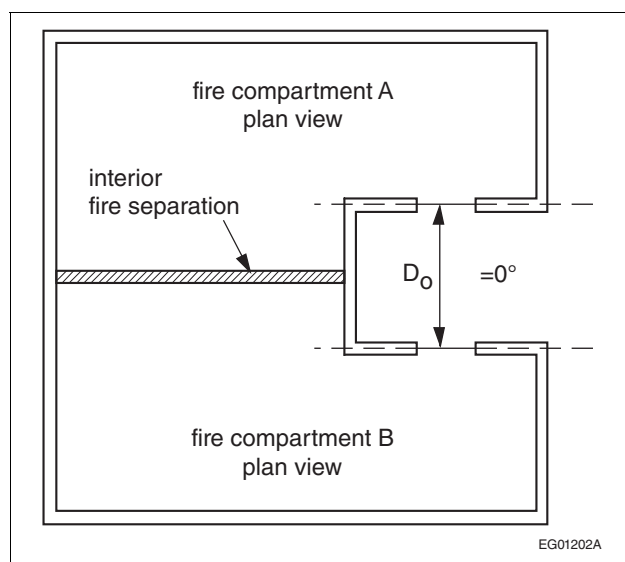


Figure A-3.2.3.14.(1)-B  
Openings in walls that are parallel to one another

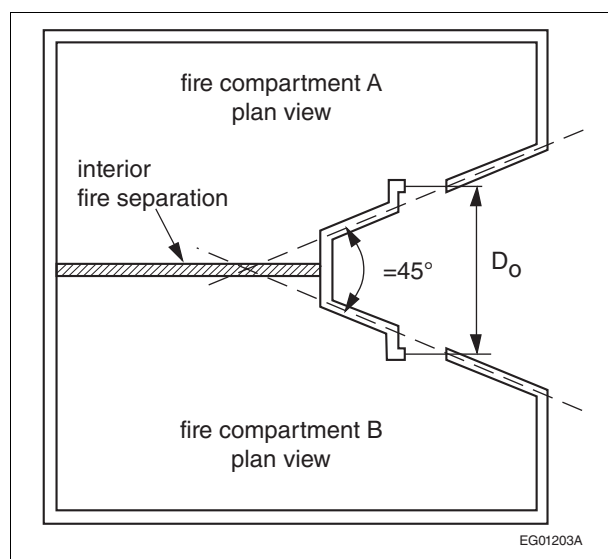


Figure A-3.2.3.14.(1)-C  
Openings in walls with an included angle of 45°

**A-3.2.4. Fire Alarm System.** The term “fire alarm system” used in this Subsection applies to fire alarm systems with or without voice communication capability.

**A-3.2.4.4.(1) Single Stage Fire Alarm System.** This requirement, in combination with Article 3.2.4.22., is intended to allow for the provision of voice communication capability as an integral part of a single stage fire alarm system.

**A-3.2.4.4.(2)(c) Fire Alarm Alert Signal.** In a 2-stage fire alarm system described in Sentence 3.2.4.4.(2), the alert signal may be transmitted to audible signal devices in designated locations or to audible signal devices throughout the building. If actuated, the second stage alarm signal in a 2-stage fire alarm system may sound throughout all zones in the building. All manual station key switches would typically initiate the alarm signal.

Sentence 3.2.4.4.(2) also allows the implementation of a “zoned 2-stage” sequence of operation, whereby the alarm signal sounds in the zone of key switch actuation (and perhaps in the adjacent zones, which may be the storey above and the storey below) and the alert signal sounds throughout the rest of the building. This sequencing would be created automatically by the fire alarm control unit.

The key or special device referred to in Clause 3.2.4.4.(2)(c) should be immediately available to all persons on duty who have been given authority to sound an alarm signal.

**A-3.2.4.4.(2) Two-Stage Fire Alarm System.** Sentence 3.2.4.4.(2), in combination with Article 3.2.4.22., is intended to allow for the provision of voice communication capability as an integral part of a 2-stage fire alarm system.

**A-3.2.4.6.(2) Access to Silencing Switches.** This requirement is intended to prevent easy access to silencing switches. The satisfactory operation of a fire alarm system to alert the occupants of a building to an emergency is predicated on the assumption that the alarm signal will be silenced only after responsible staff have verified that no emergency exists. Details on the emergency procedures to be used in case of fire are contained in the NFC.

**A-3.2.4.7.(4) Design and Installation of Fire Department Notification.** In some jurisdictions, the fire department may utilize, or have available, a municipal fire alarm system or equipment intended for receiving notification by means of a direct connection. If used, it is expected that these systems and installations conform to the requirements of Sentence (4) so as to achieve and provide a uniform and reliable level of service. It is also intended that a proprietary central station as well as a fire brigade used by a large corporation, university campus or similar site comply with Sentence (4).

CAN/ULC-S561, "Installation and Services for Fire Signal Receiving Centres and Systems," which is referenced in Sentence 3.2.4.7.(4), and CAN/ULC-S524, "Installation of Fire Alarm Systems," which is referenced in Sentence 3.2.4.5.(1), go hand-in-hand: conformity to CAN/ULC-S561 entails conformity with the fire alarm system components required in that standard, which include the fire alarm transmitter (signal transmitting unit), the interconnections, and the communication path.

**A-3.2.4.7.(5)(b) Emergency Telephone Number.** In many municipalities an emergency telephone number, for example 911, is used for all emergency services and it is preferable to post that number.

**A-3.2.4.8.(2) Fire Alarm Zones.** Alarm initiating devices referred to in this Sentence include fire detectors, waterflow switches and manual stations. If a room or space in a building extends through more than one storey of the building, as in the case of multi-level dwelling units and machinery rooms, judgment must be exercised in the zoning and annunciation of the fire detectors in that room or space. In general, the lowest storey on which access is provided into the room or space should be indicated on the annunciator to avoid unnecessary delays for the responding firefighters. Consideration should also be given to the use of numbers or letters on the annunciator that correspond to those used in the building elevators.

**A-3.2.4.9.(3)(f) Supervision for Fire Pumps.** Specific electrical supervision for fire pumps is stated in NFPA 20, "Installation of Stationary Pumps for Fire Protection," which is referenced in NFPA 13, "Installation of Sprinkler Systems."

**A-3.2.4.11.(1) Smoke Detector Location.** In the design and installation of the smoke detection system, consideration must be given to all features which could have a bearing on the location and sensitivity of the detectors, including ceiling height, sloped ceilings, diffusion from air conditioning and ventilating currents, obstructions, baffles, and other pertinent physical configurations that might interfere with the proper operation of the system.

**A-3.2.4.11.(3) Visible Signals.** If staff located in each zone or compartment can see each sleeping room door, visible signals may be located above each door. If staff cannot see every door, it is intended that the visible signals be provided at the location where the staff are normally in attendance. The audible signal is intended to alert staff of the need to check the visible signals.

**A-3.2.4.16.(1) Manual Station.** Only one manual station need be provided near a group of doors serving as a principal entrance or as a single exit facility.

**A-3.2.4.18. Acoustic Measurement and Terminology.** The following notes on acoustic measurement and terminology are intended to assist in the application of the requirements for audibility of fire alarm system sounding devices.

The background or ambient measurement should be a spatial averaged A-weighted equivalent sound level measured for 60 s. This can be obtained using an integrating sound level meter with the integration time set



to 60 s. During the measurement period the meter should be slowly moved about so as to sample the space uniformly but coming no closer than 0.5 m from any solid wall, floor or ceiling. Alternatively, measurements can be made at 3 or more positions throughout the space and an energy average calculated.

The measurement of the alarm level depends on the type of alarm signal. If the signal is a continuous signal from a bell or siren, the spatial averaged A-weighted equivalent sound level should be obtained. The integration time should be long enough to obtain a reasonable spatial average of the space, but not less than 10 s.

If the alarm has a temporal pattern, then the A-weighted sound level should be measured using the 'fast' time constant during the 'on' part of the cycle. In this situation it is not appropriate to use an integrating sound level meter. Since the duty cycle of the alarm is only 37.5% at best, that type of meter would give a reading that is 4 or more decibels lower than the level while the alarm is 'on.' A number of measurements should be made about the space in question and the average value used to obtain a good spatial representation. Strictly speaking, the energy average of the measurements should be used; however, the frequency spectrum associated with most alarms is of a type that should give little variation about the space. If the measured levels don't vary by more than 2 to 3 dB, then an arithmetic average rather than an energy average can be used.

### Effect of Furnishings

The final inspection of a fire alarm system is seldom made when the building is furnished and ready for occupancy. This results in measured levels which may be several decibels higher than will be found in the occupied building. The importance of this difference depends on the situation.

If the building is complete except for furnishings, so that the sources of ambient noise are present, then the amount by which the alarm signal exceeds the ambient level will not change appreciably with the introduction of furnishings. In this case both levels will be reduced by about the same amount.

If the primary source of ambient noise will be office equipment and workers, as would be expected in an open plan office, then measurements made prior to occupancy may differ substantially from those made afterwards. This may be true for both the absolute sound levels and the difference between the alarm level and the ambient.

A problem arises in trying to estimate what the absolute sound levels will be after the building is occupied.

In general, if the measurement is made in a totally bare room then the level will be about 3 dB higher than if the room were carpeted, assuming a reasonable carpet with an underlay. In most cases this will account for most of the absorption in the room and no further correction will be necessary. Adding heavy drapes and absorptive furnishings to a carpeted room can reduce the sound level by a further 2 to 3 dB.

Commercial buildings are more problematic. For example, if an open plan office is measured before any office screens are installed, there could be a substantial difference in the before and after levels, depending on the distance to the nearest alarm device.

### Glossary of Acoustical Terms

**Audible:** A signal is usually considered to be clearly audible if the A-weighted sound level exceeds the level of ambient noise by 15 dB or more.

**Awakening threshold:** The level of sound that will awaken a sleeping subject 50% of the time.

**A-weighted:** A frequency weighting network which emphasizes the middle frequency components similar to the response of the human ear. The A-weighted sound level correlates well with subjective assessment of the disturbing effects of sounds. The quantity is expressed in dBA.

**Masked threshold:** The level of sound at which a signal is just audible in ambient noise.

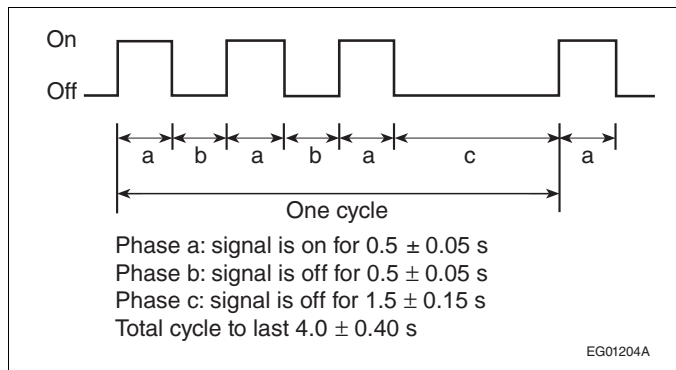
**Sound level:** A sound pressure level obtained using a signal to which a standard frequency-weighting has been applied.

**Sound pressure:** A fluctuating pressure superimposed on the static pressure by the presence of sound. The unqualified term means the root-mean-square sound pressure. In air, the static pressure is barometric pressure.

**Sound pressure level:** Ten times the common logarithm of the ratio of the square of the sound pressure under consideration to the square of the standard reference pressure of 20 mPa. The quantity obtained is expressed in decibels.

**A-3.2.4.18.(1) Alert and Alarm Signals.** Alert signals are part of a 2 stage fire alarm system. The intent of the first, alert, stage is to notify persons in authority of a potential threat to building occupants. If a continuously staffed location is available, the alert signal can be restricted to that location.

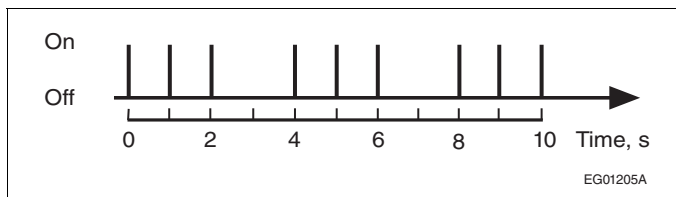
**A-3.2.4.18.(2) Alarm Signal Temporal Pattern.** The temporal pattern of an alarm signal relates to the time during which the signal is produced and the intervals between the individual signal pulses. The international standard ISO 8201, “Acoustics – Audible emergency evacuation signal,” includes a pattern that is becoming widely used in different countries and it is appropriate for this pattern to be adopted in Canada. The temporal pattern can be produced on most signalling devices. Most existing alarm systems can be modified, and this pattern could be phased in when the systems require modification. The characteristic of the pattern is a 3-pulse phase followed by an off phase. The 3 pulses each consist of an on phase lasting for  $0.5 \pm 0.05$  s followed by an off phase lasting for  $0.5 \pm 0.05$  s sounded for 3 successive on periods and then followed by an off phase lasting for  $1.5 \pm 0.15$  s. Figure A-3.2.4.18.(2)-A indicates the pattern that is intended.



**Figure A-3.2.4.18.(2)-A**  
**Temporal pattern for fire alarm signal**

Although the diagram shows a square wave form, the wave can have other shapes that produce a similar effect.

If single stroke bells are to be used, the temporal pattern can be produced by having the bell struck three times at a rate of one stroke per second followed by an interval of 2 s of silence. Figure A-3.2.4.18.(2)-B shows the pattern that results.



**Figure A-3.2.4.18.(2)-B**  
**Temporal pattern imposed on a single stroke bell or chime**

**Note to Figure A-3.2.4.18.(2)-B:**

- (1) The on phase represents the time that the striker mechanism is actuated. The sound produced by the bell or chime will continue at a level that decreases until the striker mechanism is re-actuated.

**A-3.2.4.18.(3) Audibility of Alarm Systems.** It is very difficult to specify exactly what types of sound patterns are considered to be “significantly different” from one another. The intent is to ensure that there is a noticeable or measurable difference between the alert signals and the alarm signals such that it reduces the possibility of confusion.

**A-3.2.4.18.(4) Sound Pressure Level.** For the purposes of this requirement, an audible signalling device should not produce a sound pressure level more than 110 dBA when measured at a distance of 3 m.

**A-3.2.4.18.(5) Residential Sound Level.** In a building in which corridors or hallways serve more than one suite or dwelling unit, there will be situations in which an audible signal device cannot be placed in the corridor or hallway to alert persons sleeping in suites and dwelling units, because the sound level in the vicinity of the device would exceed that permitted by Sentence 3.2.4.18.(4). In these situations it will be necessary to supplement the building fire alarm system with an audible signal device in the suite or dwelling unit. These devices could be piezoelectric devices similar to the sounding units in many smoke alarms, subject to the device emitting the appropriate temporal pattern required by Sentence 3.2.4.18.(2).

**A-3.2.4.18.(7) Disconnect Device for Dwelling Units.** In order to minimize the annoyance caused by false and unwanted alarms, the disconnect will permit a person to silence the local audible device within the dwelling unit. At that time the person would be aware of sounds from devices in common spaces and could plan appropriate action. The disconnect will reduce the possibility of tampering with the audible devices.

**A-3.2.4.18.(8) and (9) Signal Circuits.** Clause 3.2.4.18.(8)(a) permits Class A wiring, or Class B wiring with signal circuit isolators located outside of the suites, to serve audible signal devices within residential suites.

Clause 3.2.4.18.(8)(b) permits a separate signal circuit to serve each suite without the need for signal circuit isolators or Class A wiring.

Open circuits and Class A and Class B wiring circuits are terms defined in CAN/ULC-S524, "Installation of Fire Alarm Systems."

**A-3.2.4.19.(2) Visual Alarm Signal.** CAN/ULC-S526, "Visible Signal Devices for Fire Alarm Systems, Including Accessories," applies to visual signalling units. This document is referenced by the most recent standard for the installation of fire alarm systems and would automatically apply. Current Canadian technology does not integrate visual and audible alarms to have the same temporal pattern. Visual and audible alarms should have as close a temporal pattern as possible but without interference beats that might have a deleterious effect on some persons. Visual signalling devices with the same temporal pattern as required for audible devices are available from some sources and they should become available in Canada. Not all units that comply with the ULC standard will have sufficient power to adequately cover large areas; care will have to be taken to specify units with adequate power when large spaces are being designed.

**A-3.2.4.20.(7)(a) Smoke Alarm Installation.** CSA C22.1, "Canadian Electrical Code, Part I," permits a smoke alarm to be installed on most residential circuits that carry lighting outlets and receptacles. It is the intent of the NBC that any other item on a circuit with a smoke alarm should be unlikely to be overloaded and trip the breaker with a resultant loss of power that is not sufficiently annoying for the breaker to be restored to the on position. It is considered that an interior bathroom light or a kitchen light fulfills this intent, but that circuits restricted to receptacles do not fulfill this intent.

**A-3.2.4.20.(8) Smoke Detectors in lieu of Smoke Alarms.** It is intended that the smoke detector in this application will function as per the requirements of a smoke alarm; specifically, it will be a localized alarm to that suite. The advantage of this type of installation is that the detector would be monitored by the fire alarm panel, which would provide notification to supervisory personnel and be inspected as per CAN/ULC-S524, "Installation of Fire Alarm Systems."

**A-3.2.4.22.(1)(b) Voice Messages.** The concept of intelligibility expressed in Clause 3.2.4.22.(1)(b) is intended to mean that a person with average hearing and cognitive abilities is able to understand the messages that are transmitted into the space occupied by the person. There is no absolute measure to predetermine the effect of loudspeakers and it may be necessary, once the building has been furnished and occupied, to increase the number of loudspeakers to improve the quality of the messages.

The intelligibility of the message depends on the speech level, the background level, and the reverberation time of the space. ISO 7731, "Ergonomics – Danger signals for public and work areas – Auditory danger signals," addresses audibility. The standard suggests that an A-weighted sound level at least 15 dBA above the ambient is required for audibility, but allows for more precise calculations using octave or 1/3 octave band frequencies to tailor the alarm signal for particular ambient noise conditions. Design of the alarm system is limited to ensuring that all areas receive an adequately loud alarm signal.

If a public address system is to be used to convey instructions during an emergency, then the requirements of the system are less straightforward. In general, however, a larger number of speakers operating at lower sound levels would be required.

Additional guidance on how to design and evaluate the intelligibility of a communication system can be found in the following documents:

- IEC 60268-16, “Sound System Equipment – Part 16: Objective Rating of Speech Intelligibility by Speech Transmission Index”
- ISO 7240-19, “Fire Detection and Alarm Systems – Part 19: Design, Installation, Commissioning and Service of Sound Systems for Emergency Purposes”
- NEMA SB 50, “Emergency Communications Audio Intelligibility Applications Guide”
- Annex A.7.4.1.4 of NFPA 72, “National Fire Alarm and Signaling Code”

**A-3.2.5.4.(1) Fire Department Access for Detention Buildings.** Buildings of Group B, Division 1 used for housing persons who are under restraint include security measures that would prevent normal access by local fire departments. These security measures include fencing around the building site, exterior walls without openings or openings which are either very small or fitted with bars, and doors that are equipped with security hardware that would prevent easy entry. These buildings would have firefighting equipment installed and the staff would be trained to handle any small incipient fires. It is expected that appropriate fire safety planning would be undertaken in conjunction with local fire departments in order that special emergencies could be handled in a cooperative manner.

**A-3.2.5.6.(1) Fire Department Access Route.** The design and construction of fire department access routes involves the consideration of many variables, some of which are specified in the requirements in the Code. All these variables should be considered in relation to the type and size of fire department vehicles available in the municipality or area where the building will be constructed. It is appropriate, therefore, that the local fire department be consulted prior to the design and construction of access routes.

**A-3.2.5.7.(1) Water Supply.** The intent of Sentence 3.2.5.7.(1) is that an adequate water supply for firefighting be readily available and of sufficient volume and pressure to enable emergency response personnel to control fire growth so as to enable the safe evacuation of occupants and the conduct of search and rescue operations, prevent the fire from spreading to adjacent buildings, and provide a limited measure of property protection.

The water supply requirements for buildings containing internal fire suppression systems, including sprinkler systems and standpipe systems, are contained in specific standards referenced in the Code. Compliance with the referenced standard, including any variations made by this Code, is deemed to satisfy the intent of Sentence 3.2.5.7.(1). However, it will be necessary to verify that an adequate source of water is available at the building site to meet the required quantities and pressures.

For a building with no internal fire suppression system, the determination of the minimum requirements applicable to the water supply for firefighting is relevant mainly to building sites not serviced by municipal water supply systems. For building sites serviced by municipal water supply systems, where the water supply duration is not a concern, water supply flow rates at minimum pressures is the main focus of this provision. However, where municipal water supply capacities are limited, it may be necessary for buildings to have supplemental water supplies on site or readily available.

The sources of water supply for firefighting purposes may be natural or developed. Natural sources may include ponds, lakes, rivers, streams, bays, creeks, and springs. Developed sources may include aboveground tanks, elevated gravity tanks, cisterns, swimming pools, wells, reservoirs, aqueducts, artesian wells, tankers, hydrants served by a public or private water system, and canals. Consideration should be given to ensuring that water sources will be accessible to fire department equipment under all climatic conditions.

The volume of on-site water supply is dependent on the building size, construction, occupancy, exposure and environmental impact potential, and should be sufficient to allow at least 30 minutes of fire department hose stream use.

**A-3.2.5.9.(5)(c) Fire Department Pumping Equipment.** Availability of appropriate pumping equipment from the local fire department or, in the case of industrial plants or complexes, from their fire brigade, is considered sufficient to meet the intent of this requirement.

**A-3.2.5.11.(2) Hose Stations.** A building that is partially sprinklered may have some floor areas where local sprinklers are installed that do not cover the entire floor area. It is intended that hose stations be provided in these floor areas to allow emergency responders to fight fires that cannot be controlled by local sprinklers.

**A-3.2.5.12.(1) Sprinkler System Design.** In NFPA 13, "Installation of Sprinkler Systems," reference is made to other NFPA standards that contain additional sprinkler design criteria. These criteria apply to industrial occupancies with high fire loads and industrial occupancies intended for the use, manufacture or storage of highly flammable materials. Therefore, while only NFPA 13 is called up directly by Sentence 3.2.5.12.(1), the additional criteria in the other NFPA standards are included automatically.

In some NFPA standards, certain aspects of sprinkler protection are dependent on the fire-resistance rating of the vertical structural members. In these cases, the sprinkler system design options can be affected by the fire-resistance rating of these elements. For example, in buildings used for the storage of rubber tires, sprinklers directed at the sides of a column are required if the column does not have the required fire-resistance rating.

Other NFPA standards may require that certain occupancies be sprinklered in conformance with NFPA 13, as in the case of some garages. These requirements do not supersede the requirements in the Code. An occupancy is required to be sprinklered only when this is specified in the Code, but when it is so required, it must be sprinklered in conformance with NFPA 13 and its referenced standards.

Additionally, while Part 4 contains seismic force provisions that apply to the design of sprinklers, NFPA 13 contains other structural requirements for sprinklers that are also required to be met.

**A-3.2.5.12.(2) Sprinklering of Residential Buildings above a Storage Garage Considered as a Separate Building.** For the purpose of determining whether NFPA 13R, "Installation of Sprinkler Systems in Low-Rise Residential Occupancies," applies to a residential building constructed over a storage garage, it is not intended that a storage garage constructed as a separate building in accordance with Article 3.2.1.2. be considered as a storey when determining the building height of the residential building. Similarly, this would not preclude the use of NFPA 13D, "Installation of Sprinkler Systems in One- and Two-Family Dwellings and Manufactured Homes," for any one- or two-family home constructed above such a storage garage.

**A-3.2.5.12.(6) Sprinklering of Roof Assemblies.** Sprinkler protection for roof assemblies in lieu of fire resistance is based on the assumption that the sprinklers will protect the roof assembly from the effects of fire in spaces below the roof. If a ceiling membrane is installed, the sprinklers would have to be located below the membrane in order to react quickly to the fire. In certain instances, however, sprinklers may be required within the concealed spaces as well as below the membrane. NFPA 13, "Installation of Sprinkler Systems," requires sprinklers in certain concealed spaces.

According to NFPA 13 and 13R, some small rooms and closets within a dwelling unit in a sprinklered building, including those that may be in the storey immediately below the roof assembly, do not require sprinklers. However, the NBC requires sprinkler protection within all rooms and closets immediately below the roof so as to control any fire that might start in that space and thereby limit the probability of the fire spreading into the roof assembly.

Moreover, NFPA 13D, "Installation of Sprinkler Systems in One- and Two-Family Dwellings and Manufactured Homes," also allows the omission of sprinklers in such rooms and closets under certain circumstances, provided the building is sprinklered in conformance with this standard. In this case, the NBC concurs with the provisions of the NFPA 13D standard.

**A-3.2.5.12.(7) Balconies and Decks.** The intent of Sentence 3.2.5.12.(7) is to suppress or control the spread of a fire originating from a balcony or deck to the roof assembly or other parts of the building.

**A-3.2.5.12.(8) Sprinkler Rating.** The requirements of this Sentence can be met by using sprinklers with a rating of 79°C to 107°C.

**A-3.2.5.13.(1) Hazard Classification for Sprinkler Selection.** The reference to light hazard occupancies is based on the descriptions of these occupancies given in NFPA 13, "Installation of Sprinkler Systems," and is intended only for use in the design of sprinkler systems. These descriptions should not be confused with the occupancy classifications in the Code.

In NFPA 13, a light hazard occupancy is one in which the quantity or combustibility of contents is low and fires with relatively low rates of heat release are expected. Typical buildings or parts of buildings include: churches; clubs; eaves and overhangs, if of combustible construction with no combustibles beneath; educational buildings; hospitals; institutional buildings; libraries, except very large stack rooms; museums; nursing or convalescent homes; offices, including data processing rooms; residential buildings; restaurant seating areas; theatres and auditoria, excluding stages and proscenias; and unused attics.

Although NFPA 13R, “Installation of Sprinkler Systems in Low-Rise Residential Occupancies,” and NFPA 13D, “Installation of Sprinkler Systems in One- and Two-Family Dwellings and Manufactured Homes,” as referenced by NFPA 13, are concerned with specific types of residential occupancy, namely apartment buildings up to four storeys, one and two family dwellings, and mobile homes, for the purpose of acceptance of combustible sprinkler piping these occupancies are considered to be included in the category of residential buildings under light hazard occupancies.

**A-3.2.5.18.(1) Fire Pumps.** In order to ensure an adequate water supply, it may be necessary to install a fire pump for a building that has either a standpipe system or an automatic sprinkler system installed.

**A-3.2.6. Smoke Control for High Buildings.** Experience with high buildings has shown that the time required for complete evacuation can exceed that which is considered necessary for the safe egress of all occupants. Studies of the “chimney effect” and observations of smoke movement in actual fires have shown that fire compartmentation to contain a fire on any one storey will not usually prevent the movement of smoke through elevator, stair and other vertical shafts to the upper floors of a high building. Occupants of a high building in which an automatic sprinkler system is not installed, and particularly those on upper storeys, could be faced with severe smoke conditions from fires occurring in storeys below them before their own evacuation is possible. The requirements of Subsection 3.2.6. are intended to maintain safe conditions for occupants of a high building who may have to remain in the building during a fire, and to assist the firefighters by providing efficient access to the fire floor. The Notes for Subsection 3.2.6. are intended to assist a designer in complying with the requirements of Subsection 3.2.6. The knowledge requirements are well within the capabilities of a competent designer. The designer should appreciate, however, that successful application requires a clear understanding of the principles that govern smoke movement. Subsection 3.2.6. contains only those items that relate to the design and construction of a building; operation of the facilities and recommended actions to be taken by the building owner, occupant and fire department are covered by the NFC.

The designer is cautioned that the tabular and graphical information in the Notes for Subsection 3.2.6. was developed for buildings having conventional configurations. The designer has to judge the extent to which the building under consideration has characteristics that will allow the application of this information; this is particularly true of designs employing air-handling systems for which a realistic assessment of the leakage characteristics of the enclosures of spaces may be critical.

It is assumed that buildings regulated by Subsection 3.2.6. will be in an area served by a fire department capable of an early response and that all firefighting and rescue situations will be under the direct control of the officer-in-charge of the fire department responding to the emergency. It is important that firefighters be provided with a smoke-free access to fire floors below grade. Provisions are included to separate exit stairways serving storeys above grade from those serving storeys below grade, and to limit entry of smoke into these shafts. Similarly, elevator hoistways and service shafts are required to be provided with a separation near grade, or be designed to limit their functioning as paths of smoke movement into upper floor areas from storeys below grade.

It is assumed that in the event of fire, occupants of the floor on which the fire occurs will leave by exit stairs immediately following the sounding of a fire alarm, and that occupants of the floor immediately above the floor on which the fire occurs will be advised to leave by the first fire department officer on the scene or other person assigned this responsibility. Occupants of all other floors may remain on their floors unless otherwise directed. It is also assumed that the owner of the building has complied with the Emergency Planning Section of the NFC by preparing a comprehensive fire safety plan to safeguard the building occupants and that the building supervisory staff are familiar with the requirements of Subsection 3.2.6. and with their responsibilities under the fire safety plan.

The NBC requires that a check be made of the smoke control and mechanical venting systems. Testing will indicate deficiencies caused by inexact estimates of the leakage characteristics or of air supply requirements and, in all but the most extreme cases, will provide an opportunity for appropriate adjustments before the system is put into service.

**A-3.2.6.2.(2) Stairway Protection Below Lowest Exit Level.** A stairway serving floors below the lowest exit level is considered to comply with the intent of Sentence 3.2.6.2.(2) if the following conditions are satisfied.

- 1) The stairway has a vent or door to the outdoors at or near the top of the stair shaft that has an openable area of not less than 0.1 m<sup>2</sup> for each storey served by the stairway, less 0.01 m<sup>2</sup> for each weatherstripped door and 0.02 m<sup>2</sup> for each door that is not weatherstripped opening into the stairway.
- 2) The stairway is enclosed in a shaft that

- a) does not pass through the floor above the lowest exit level and is separate from a shaft that contains a stairway serving upper storeys, or
- b) contains a stairway serving upper storeys, but is separated from that stairway at the lowest exit level by a fire separation having a fire-resistance rating not less than that required for the shaft enclosure.

**3)** The stairway is provided with equipment capable of maintaining a flow of air introduced at or near the bottom of the stair shaft, at a rate equal to 0.47 m<sup>3</sup>/s for each storey served by the stairway.

**A-3.2.6.2.(3) Pressurization of Stair Shafts.** The purpose of providing open doors and vents at the bottom of a stair shaft is to create a positive pressure in the shaft relative to adjacent floor areas and thus keep it free of smoke. The pressure depends on the temperature differential between the interior and the exterior of the building which is most pronounced during winter months when stack effect is greatest. If a shaft does not have a direct opening to the exterior, alternative means must be provided to achieve smoke control. If a corridor or vestibule is used as a link between the exit level of an interior stair shaft and the outdoors to provide a venting system, it will be necessary to assess the reliability of the overall system. The probability of all doors or closures being opened at the same time has to be addressed, as well as the size of the vestibule and its impact on the overall smoke control system.

If mechanical methods are used to develop a positive pressure in a stair shaft, a minimum pressure differential of 12 Pa is recommended to prevent smoke migration from floor areas in a sprinklered building where fire temperatures are controlled and smoke movement may be dominated by stack effect in a stair shaft. During a fire emergency, persons will be entering and exiting a stair shaft as they move to a place of safety and under these conditions the number of doors open to the stair shaft cannot be predetermined. The number will vary depending on the occupancy of the building, population density and the evacuation plan for the building. It should be assumed that two doors are open. This is based in part as a practical level for most buildings and considers the positive fire experience in sprinklered buildings.

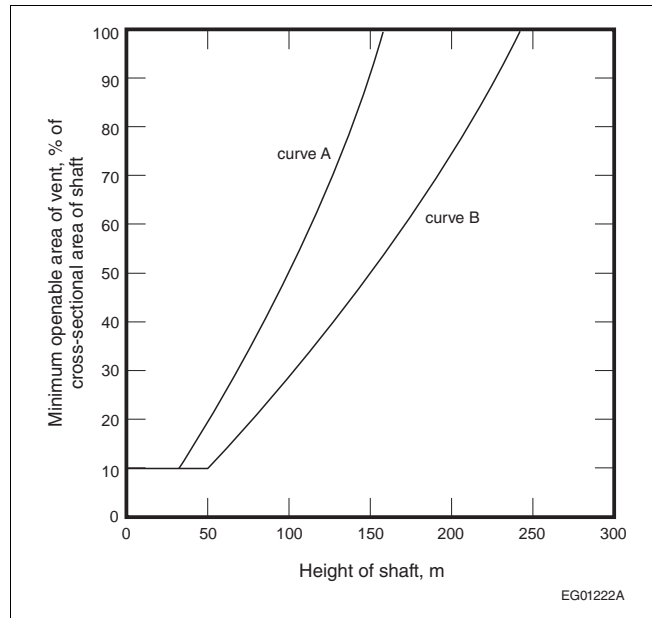
The maximum pressure differential created by a mechanical system should not prevent doors to the stair shafts from being opened. A specific maximum value cannot be given, as this value will depend on the door opening force and size of the door. These values should be calculated for each specific case. Although a maximum value of 130 N is suggested by research as the force that can be opened by the majority of people in most occupancies, this value is above the maximum value of 90 N generally specified in this Code. The use of values below 130 N can create a practical problem in achieving effective smoke control as it is difficult to design for the acceptable minimum and maximum pressure differential range. Special consideration may need to be given for doors located in a barrier-free path of travel.

Care should be taken by designers and by building and fire officials in implementation of these requirements. Assumptions involved in the design of a smoke control system may be different from final construction conditions. For this reason each system should be tested after installation to ensure that the design intent is met. The minimum pressure differential is not intended to apply to locations in stair shafts when doors in their proximity are open to adjacent floor areas.

**A-3.2.6.2.(4) Limiting Smoke Movement.** Measures to prevent the migration of smoke from floor areas below the lowest exit storey into upper storeys include the following.

**1)** An elevator hoistway that passes through the floor above the lowest exit storey should not penetrate the floor of the storey immediately below the lowest exit storey, unless there is a vestibule between the shaft and each floor area below the lowest exit storey that

- a) has a fire separation, with a fire-resistance rating not less than 45 min, between the vestibule and any public corridor,
- b) has a fire separation, with a fire-resistance rating not less than that required for an exit by Article 3.4.4.1., between the vestibule and any stair or elevator enclosure or any part of a floor area, other than a public corridor, and
- c) except for elevator hoistway entrances, has a self-closing device on any door through the fire separation required by Clauses (a) and (b), with the door opening in the direction of travel from the floor area to the exit stairway.



**Figure A-3.2.6.2.(4)-A**  
**Vent to a vertical service space with no other pressurized shaft in the building**

**Notes to Figure A-3.2.6.2.(4)-A:**

- (1) Curve A applies to a vertical service space that is enclosed by unplastered unit masonry or by plaster and steel stud construction with all openings in the shaft sealed to the degree required by Articles 3.1.9.1. to 3.1.9.5.
- (2) Curve B applies to a vertical service space that is enclosed by monolithic concrete or by plastered unit masonry with all openings in the shaft sealed tightly to minimize air leakage.
- (3) A shaft having a vent that is 100% of the cross-sectional area of the shaft is acceptable for buildings up to 1.5 times the height shown by the appropriate curve in Figures A-3.2.6.2.(4)-A and A-3.2.6.2.(4)-B.
- (4) The total leakage area, based on measurements in typical high buildings, is assumed to be 0.025 m<sup>2</sup> for every 10 m<sup>2</sup> of shaft wall area in the case of Curve A and 0.015 m<sup>2</sup> for every 10 m<sup>2</sup> of shaft wall area in the case of Curve B.

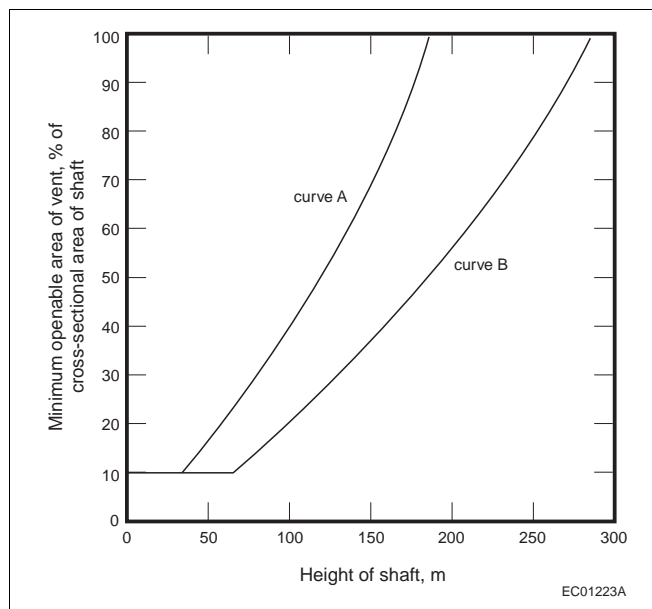
**2)** A vertical service space, other than an elevator hoistway, that passes through the floor assembly above the lowest exit storey, should be provided with a tight-fitting noncombustible seal or fire stop at the floor assembly of the storey immediately below the lowest exit storey, unless

- a) the vertical service space is vented to the outdoors at the top and the vent has an openable area that is not less than
  - i) that obtained from Figure A-3.2.6.2.(4)-A if the vertical service space is in a building in which other shafts are not mechanically pressurized, or
  - ii) that obtained from Figure A-3.2.6.2.(4)-B if the vertical service space is in a building in which other shafts are mechanically pressurized,
- b) for a shaft that serves floor areas above the lowest exit storey, a vent is located
  - i) at or near the top of the shaft if the shaft is above the mid-height of the building, or
  - ii) at or near the foot of the shaft at or near the exit level if the top of the shaft is below the mid-height of the building, or
- c) for a shaft that serves floor areas below the lowest exit storey, a vent is located at or near the top of the shaft.

**3)** Any closure provided for a vent opening referred to in Sentence (2) must be openable:

- a) manually,
- b) on a signal from a smoke detector located at or near the top of the shaft, and
- c) by a control device located at the central alarm and control facility.





**Figure A-3.2.6.2.(4)-B**  
**Vent to a vertical service space with other pressurized shafts in the building**

**Notes to Figure A-3.2.6.2.(4)-B:**

- (1) Curve A applies to a vertical service space that is enclosed by unplastered unit masonry or by plaster and steel stud construction with all openings in the shaft sealed to the degree required by Articles 3.1.9.1. to 3.1.9.5.
- (2) Curve B applies to a vertical service space that is enclosed by monolithic concrete or by plastered unit masonry with all openings in the shaft sealed tightly to minimize air leakage.
- (3) A shaft having a vent that is 100% of the cross-sectional area of the shaft is acceptable for buildings up to 1.5 times the height shown by the appropriate curve in Figures A-3.2.6.2.(4)-A and A-3.2.6.2.(4)-B.
- (4) The total leakage area, based on measurements in typical high buildings, is assumed to be 0.025 m<sup>2</sup> for every 10 m<sup>2</sup> of shaft wall area in the case of Curve A and 0.015 m<sup>2</sup> for every 10 m<sup>2</sup> of shaft wall area in the case of Curve B.

**A-3.2.6.3.(1) Connected Buildings.** The measures described here are intended to prevent movement of smoke from one building to another. They are of particular significance for two buildings of unequal height that are joined together. The techniques suggested are the provision of a large opening to the outdoors in a connecting vestibule so that smoke entering through leakage areas around doors will be vented to the outdoors, or pressurization to maintain a higher pressure in the vestibule than in adjacent spaces, as illustrated in Figures A-3.2.6.3.(1)-A, A-3.2.6.3.(1)-B and A-3.2.6.3.(1)-C.

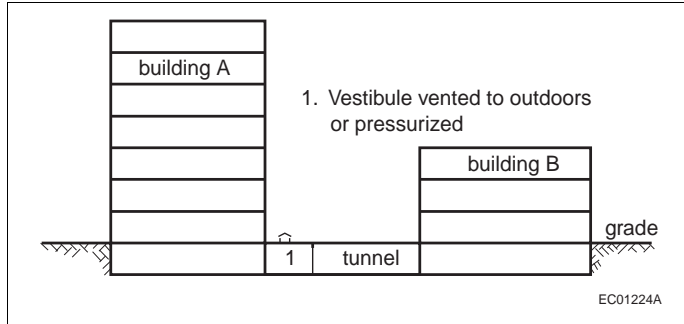
The provisions for protection of openings are described in terms appropriate to a doorway. Openings other than doorways should be avoided if possible. Openings should be protected by an airlock that gives the same standard of protection as the vestibule referred to below.

The requirement of Article 3.2.6.3. that limits movement of smoke from one building to another may be met by incorporating in the link between the buildings the provisions of Sentences (1) and (2).

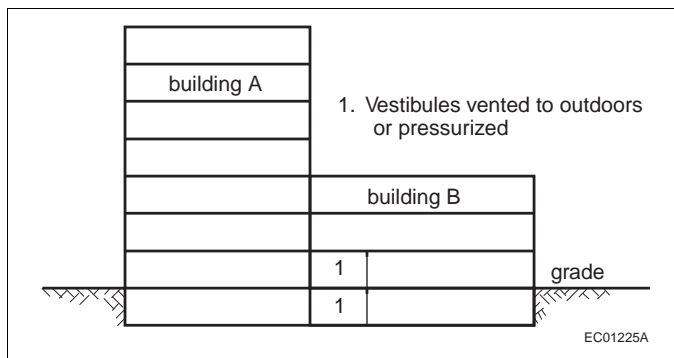
- 1)** A firewall conforming to Subsection 3.1.10. is constructed between one building and the other with any opening in the firewall protected against the passage of smoke by a vestibule that has
  - a) a fire separation between the vestibule and a public corridor with a fire-resistance rating not less than 45 min,
  - b) a fire separation between the vestibule and the remainder of the floor area, other than a public corridor, with a fire-resistance rating not less than that required by Article 3.4.4.1. for an exit,
  - c) a fire separation between the vestibule and a stair enclosure or elevator hoistway with a fire-resistance rating not less than that required by Article 3.4.4.1. for an exit, and
  - d) any door in the fire separation required by Clauses (a), (b) or (c), except for an elevator entrance, provided with a self-closing device as required by Article 3.1.8.13. and opening in the direction of travel from the floor area to the exit stairway.
- 2)** The vestibule referred to in Sentence (1) should have
  - a) a vent to the outdoors that has a net area of  $10(0.023 d + 0.00045 a)$  m<sup>2</sup>, where 'd' is the number of doors having a perimeter not more than 6 m that open into the vestibule, or if the perimeter of doors exceeds 6 m, the value 'd' is increased in direct proportion to the increase in the perimeter, and 'a' is

the area in square metres of enclosing walls, floors and ceilings whose outer face is in contact with the outside air, except that where the outer face of a wall is in contact with the ground or fill, it is assumed that there is no leakage through that portion, and the value of 'a' is assumed to be zero, or

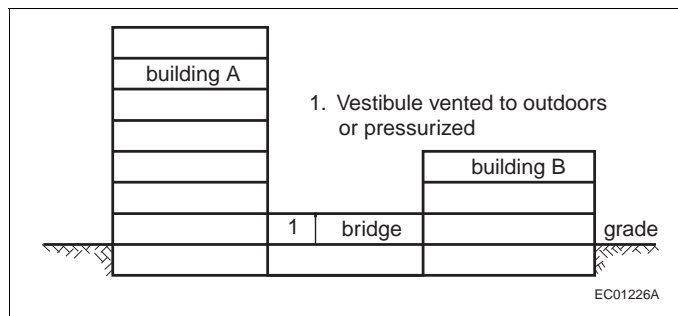
b) equipment capable of maintaining a supply of air into the vestibule sufficient to ensure that the air pressure in the vestibule when the doors are closed is higher by at least 12 Pa than that in adjacent floor areas when the outdoor temperature is equal to the January design temperature on a 2.5% basis.



**Figure A-3.2.6.3.(1)-A**  
Buildings connected by a tunnel



**Figure A-3.2.6.3.(1)-B**  
Buildings connected at a firewall



**Figure A-3.2.6.3.(1)-C**  
Buildings connected by a bridge

**A-3.2.6.5.(6)(b) Electrical Cable Protection.** Electrical cables that provide continuous operation for 1 h when subjected to the fire exposure of the time/temperature curve of CAN/ULC-S101, “Fire Endurance Tests of Building Construction and Materials,” do not need additional protection against exposure to fire.

**A-3.2.6.6.(1) Venting to Aid Firefighting.** The requirements of Sentence 3.2.6.6.(1) are met by incorporating in a floor area windows or wall panels, as described in Sentence (1), by smoke shafts as described in Sentences (2) to (8), or by the use of building exhaust systems as described in Sentence (9).

- 1) If windows or wall panels are used for venting, they must

- a) be uniformly distributed along the exterior wall of each storey,
  - b) have a total area not less than 1% of the exterior wall area of each storey,
  - c) be readily openable from the interior without the use of wrenches or keys,
  - d) be readily identified from the interior, and from the exterior where they are accessible to firefighters, and
  - e) be designed so that when opened they will not endanger persons outside the building during a fire.
- 2)** If one or more smoke shafts or vertical service spaces are used for venting, they must
- a) have an opening or openings into each storey with an aggregate area not less than that obtained from Table A-3.2.6.6.(1)-A for the height of the building and the area of the largest floor area served by the smoke shaft, and the leakage characteristics of the shaft wall and closures obtained from Tables A-3.2.6.6.(1)-B and A-3.2.6.6.(1)-C,
  - b) have an aggregate unobstructed cross-sectional area equal to that required by Clause (a), and
  - c) be designed to comply with the requirements of Sentence (3).
- 3)** Each smoke shaft or vertical service space described in Sentence (2) must
- a) be separated from the remainder of the building by a fire separation that has a fire-resistance rating not less than that required for the floor assembly through which it passes, or be designed as a chimney conforming to Part 6, except that flue liners need not be provided,
  - b) have an opening to the outdoors at the top that has an area not less than the cross-sectional area of the shaft, with the opening protected from the weather,
  - c) terminate not less than 900 mm above the roof surface where it penetrates the roof, and
  - d) contain no combustible material, fuel lines or services that are required for use in an emergency.
- 4)** Each opening required by Clause (2)(a) must be located so that the top of the opening is not more than 250 mm below the ceiling, except that the opening may be above the ceiling if the ceiling freely allows passage of air.
- 5)** The opening into the smoke shaft must be provided with a closure that
- a) has a fire-protection rating conforming to Sentence 3.1.8.4.(2), except that the temperature on the unexposed face of the closure shall be not more than 250 °C after 30 min during the fire test used to determine its rating,
  - b) is no closer to combustible material, except for paint or tightly-adhering paper covering not more than 1 mm thick applied to a noncombustible backing, than the distances described in Table A-3.2.6.6.(1)-D,
  - c) can be opened from a remote location such as a stair shaft, the storey immediately below, or the central alarm and control facility, and
  - d) does not open automatically on any floor, other than the fire floor, when smoke and hot gases pass through the shaft.
- 6)** Closures for openings described in Clause (3)(b) must
- a) be openable from outside the shaft, and
  - b) open automatically
    - i) on a signal from a smoke detector in the shaft,
    - ii) by operation of the fire alarm system, and
    - iii) when the closure required by Sentence (5) opens.
- 7)** A smoke shaft opening referred to in Sentence (2) that is less than 1 070 mm above the floor must conform to Article 3.3.1.18.
- 8)** If a closure is required to comply with Sentence (5), the leakage area between closure components and between closure and frame must not be more than 3% of the openable area of the closure.
- 9)** The building air handling system may be used for smoke venting, provided
- a) the system can maintain an exhaust to the outdoors at the rate of 6 air changes per hour from any floor area, and
  - b) emergency power to the fans providing the exhaust required by Clause (a) is provided as described in Article 3.2.7.9.

**Table A-3.2.6.6.(1)-A**  
**Minimum Size of Vent Openings into Smoke Shafts from Each Floor Area, m<sup>2</sup>(1)(2)**  
 Forming Part of Note A-3.2.6.6.(1)

Floor Area, m <sup>2</sup>	Leakage Area, % <sup>(3)</sup>	Building Height, m								
		18	37	73	110	146	183	220	256	293
200	0	0.10	0.11	0.13	0.15	0.16	0.18	0.19	0.20	0.22
500		0.22	0.25	0.29	0.32	0.36	0.37	0.39	0.41	0.43
1 000		0.43	0.48	0.53	0.59	0.63	0.67	0.71	0.75	0.77
2 000		0.83	0.91	1.01	1.08	1.16	1.22	1.29	1.34	1.39
3 000		1.21	1.33	1.46	1.55	1.67	1.75	1.82	1.90	1.97
4 000		1.62	1.75	1.90	2.02	2.15	2.25	2.35	2.44	2.53
5 000		2.01	2.17	2.34	2.46	2.63	2.74	2.86	2.88	3.07
6 000		2.39	2.57	2.76	2.91	3.10	3.23	3.37	3.47	3.58
200	1	0.10	0.12	0.15	0.19	0.22	0.27	0.35	0.43	0.55
500		0.23	0.27	0.35	0.40	0.49	0.57	0.69	0.83	1.04
1 000		0.44	0.50	0.71	0.72	0.86	1.01	1.19	1.43	1.73
2 000		0.85	0.97	1.15	1.33	1.56	1.81	2.10	2.48	2.95
3 000		1.26	1.42	1.67	1.91	2.23	2.56	2.97	3.47	4.08
4 000		1.66	1.88	2.18	2.49	2.37	3.28	3.79	4.40	5.16
5 000		2.07	2.32	2.69	3.05	3.51	3.99	4.60	5.32	6.21
6 000		2.47	2.76	3.18	3.59	4.14	4.68	5.37	6.20	7.23
200	2	0.10	0.13	0.18	0.24	0.37	0.61	1.28	4.60	89.57
500		0.24	0.29	0.39	0.52	0.75	1.13	2.10	6.11	94.50
1 000		0.46	0.55	0.72	0.94	1.30	1.90	3.27	8.29	102.11
2 000		0.88	1.05	1.34	1.73	2.32	3.28	5.36	12.14	116.80
3 000		1.31	1.53	1.95	2.47	3.29	4.58	7.28	15.63	130.83
4 000		1.73	2.01	2.55	3.20	4.23	5.83	9.12	19.97	144.03
5 000		2.15	2.49	3.13	3.92	5.15	7.05	10.90	22.15	157.05
6 000		2.57	2.96	3.73	4.63	6.07	8.26	12.65	25.39	169.29
200	3	0.11	0.14	0.21	0.37	0.88	2.06			
500		0.25	0.31	0.47	0.76	1.58	9.00			
1 000		0.47	0.59	0.86	1.33	2.60	11.99			
2 000		0.91	1.12	1.60	2.41	4.47	17.46			
3 000		1.35	1.64	2.31	3.43	5.21	22.48			
4 000		1.79	2.17	3.02	4.43	7.91	27.29			
5 000		2.22	2.68	3.71	5.42	9.55	31.95			
6 000		2.65	3.20	4.40	6.39	11.18	36.47			
200	4	0.11	0.15	0.28	0.70	24.83				
500		0.25	0.34	0.58	1.33	29.18				
1 000		0.49	0.63	1.06	2.27	36.07				
2 000		0.95	1.21	1.97	3.99	48.56				
3 000		1.41	1.78	2.84	6.63	60.15				
4 000		1.86	2.34	3.70	7.22	71.15				
5 000		2.21	2.90	4.55	8.79	81.81				
6 000		2.75	3.46	5.40	10.33	90.05				

Copyright © NRC 1941 - 2021 World Rights Reserved © CNRC 1941-2021 Droits réservés pour tous pays

**Table A-3.2.6.6.(1)-A (Continued)**

Floor Area, m <sup>2</sup>	Leakage Area, % <sup>(3)</sup>	Building Height, m								
		18	37	73	110	146	183	220	256	293
200	5	0.11	0.16	0.36	3.33					
500		0.28	0.36	0.76	5.09					
1 000		0.50	0.69	1.37	7.67					
2 000		0.99	1.31	2.54	12.35					
3 000		1.46	1.94	3.65	16.75					
4 000		1.92	2.55	4.75	20.99					
5 000		2.40	3.16	5.84	25.11					
6 000		2.87	3.74	6.92	29.11					

**Notes to Table A-3.2.6.6.(1)-A:**

- (1) The minimum size of a vent opening into a smoke shaft is obtained from Table A-3.2.6.6.(1)-A and is dependant on the floor area and total leakage area of the smoke shaft walls and closures. This total leakage area may be estimated by adding the leakage areas for the shaft wall obtained from Table A-3.2.6.6.(1)-B and for the dampered openings obtained from Table A-3.2.6.6.(1)-C, provided the cross-sectional area of the smoke shaft, the opening into the shaft and the opening to the outdoors at the top of the shaft are equal.
- (2) The size of the vent opening refers to the free or unobstructed area of the opening.
- (3) Leakage area is the total of the leakage area of smoke shaft wall obtained from Table A-3.2.6.6.(1)-B and the leakage area of openings in smoke shafts obtained from Table A-3.2.6.6.(1)-C.

**Table A-3.2.6.6.(1)-B  
Leakage Area of Smoke Shaft Wall  
Forming Part of Note A-3.2.6.6.(1)**

Wall Construction	Leakage Area as % of Wall Area
Monolithic concrete	0.5
Masonry wall unplastered	1.5
Masonry wall plastered	0.5
Gypsum board on steel studs	1.0

**Table A-3.2.6.6.(1)-C  
Leakage Area of Closures in Openings into Smoke Shaft  
Forming Part of Note A-3.2.6.6.(1)**

Type of Closure	Leakage Area as % of Closure Area <sup>(1)(2)</sup>
Curtain fire damper	2.5
Single-blade fire damper	3.5
Multi-blade fire damper	4.5

**Notes to Table A-3.2.6.6.(1)-C:**

- (1) Values include allowance for 0.5% leakage between frame and wall construction.
- (2) These leakage data are based on clearances applicable to closures that have been tested in accordance with CAN/ULC-S112, "Fire Test of Fire Damper Assemblies."

**Table A-3.2.6.6.(1)-D**  
**Minimum Distance from Closure to Combustible Material**  
 Forming Part of Note A-3.2.6.6.(1)

Area of Closure <sup>(1)</sup> , m <sup>2</sup>	Minimum Distance in Front of or Above Closure, m	Minimum Distance to the Sides or Below Closure, m
0.5	0.35	0.20
1.0	0.50	0.25
1.5	0.60	0.30
2.0	0.70	0.35
2.5 <sup>(2)</sup>	0.80	0.40

**Notes to Table A-3.2.6.6.(1)-D:**

- (1) For closure areas between those given in Table A-3.2.6.6.(1)-D, interpolation may be used to determine the appropriate distances.
- (2) For closure areas greater than 2.5 m<sup>2</sup>, the minimum distance in front of or above the closure shall be one half of the square root of the closure area, and the minimum distance to the sides or below the closure shall be one quarter of the square root of the closure area.

**A-3.2.6.7.(1) Protection of Central Control Room.** The design of a room provided for a central alarm and control facility should take into account the nature and sensitivity of the electronic components of the equipment and the room should be adequately protected from fire and smoke. The room should be ventilated with a supply of fresh air so that it has a clean environment and should be provided with adequate lighting.

**A-3.2.6.7.(2) Central Control Room Air Control.** Depending on the method of mechanical venting and air control that is selected for the building, additional controls may be required at the central alarm and control facility. These additional controls include those with a capability of opening closures to vents in shafts, stopping air-handling systems, and initiating mechanical air supply to stair shafts.

**A-3.2.6.9.(1) Testing for Smoke Control.** The efficiency of a smoke control system may be checked by measuring pressure differences and the directions of airflow around doors and through separating walls of compartments. A pressure meter can be used to measure pressure differences on either side of a door or partition. Where this is impracticable, a punk stick held near a crack will indicate the direction of airflow. Measurements of airflow may be taken on the intake side of supply fans or in supply ducts to determine whether the specified airflow is being provided. In general, airflow should be from the spaces which may be occupied for various lengths of time during a fire emergency (e.g., vestibules, stair shafts, and elevator hoistways) toward the space in which the fire is assumed to have occurred. Measurements may be taken at certain critical locations to check the overall efficiency of the smoke control system.

In buildings where protection is obtained by venting corridors or vestibules to the outdoors, inspection of the building to determine whether the requirements have been met should be sufficient. Where service shafts are vented to the outdoors at the top, a check may be made of the wall between the shaft and the uppermost occupied floor areas, to ensure that the direction of flow is from each floor area into the shaft, when the vent to the outside is open and the outdoor air temperature is significantly less than that indoors. Where mechanically pressurized vestibules are used, a check may be made to ensure that the pressure in each vestibule or area of refuge is greater than that in the adjacent floor areas at each floor level.

Doors to stair shafts, elevator hoistways and vestibules in locations subject to pressure differences that may interfere with normal opening should be checked when the outdoor temperature is near the January design temperature, with the air injection system operating and a number of windows open to the outdoors on each floor in turn.

**A-3.2.7.4.(1) Emergency Power Reliability.** In some areas power outages are frequent and may be of long duration. These local conditions should be taken into account in determining the type of system for supplying emergency power for lighting. This should be studied at the planning stage of a building project in conjunction with the local fire safety and building officials.

Copyright © NRC 1941 - 2021 World Rights Reserved © CNRC 1941-2021 Droits réservés pour tous pays

**A-3.2.7.6.(1) Emergency Power for Treatment Occupancies.** CSA Z32, “Electrical Safety and Essential Electrical Systems in Health Care Facilities,” contains requirements for three classes of health care facilities—Class A, Class B and Class C. The intent of Article 3.2.7.6. is to apply specific requirements to emergency equipment for Class A facilities, which are designated as hospitals by the authorities having jurisdiction and where patients are accommodated on the basis of medical need and are provided with continuing medical care and supporting diagnostic and therapeutic services.

**A-3.2.7.8.(3) Emergency Power Duration.** The times indicated in this Sentence are the durations for which emergency power must be available for a building under fire emergency conditions. Additional fuel for generators or additional battery capacity is required to handle normal testing of the equipment, as indicated in the NFC. If the operation of emergency generators or batteries is intended for other than fire emergency conditions, such as power failures, fuel supplies or battery capacity must be increased to compensate for that use.

**A-3.2.7.9.(1) Emergency Power Reliability.** In some areas power outages are frequent and may be of long duration. These local conditions should be taken into account in determining the type of system for supplying emergency power for building services. This should be studied at the planning stage of a building project in conjunction with the local fire safety and building officials.

**A-3.2.7.10.(2)(a) and (3)(a) Protection of Electrical Conductors.** It is important to understand that electrical conductors are part of a system that includes—among other components—raceways, conduits, splices, couplings, vertical supports, grounds and pulling lubricants. When selecting electrical conductors to provide a circuit integrity rating, it is therefore important to understand how they will be installed and to know if the fire performance of the system as a whole was tested.

**A-3.2.7.10.(5)(b) Electrical Conductors in the Same Room.** If the distribution panel and the equipment it serves are within the same room, only the electrical conductors leading up to the distribution panel need to be protected. It is assumed that the distribution panel and the equipment it serves are within sufficient proximity to each other such that a fire in the same area of origin would affect both.

**A-3.2.7.10.(7) Fire Alarm Branch Circuits.** In order to ensure continuous operation of the fire alarm and voice communication systems in a high-rise building for a sufficient duration of time to control and direct the evacuation of building occupants, a level of protection is required by Sentence 3.2.7.10.(2) for those electrical conductors interconnecting the major elements of the fire alarm system. Sentence 3.2.7.10.(7) permits the protection of electrical conductors to be waived for portions connecting a transponder or fault isolation device to fire alarm input devices (fire detectors, manual stations, etc.) or a voice communication transponder to a fire alarm audible signalling device, provided all circuits or portions of the circuits are contained within the same storey.

**A-3.2.8.2.(3) Special Protection of Opening.** In manufacturing operations involving the use of conveyor systems to transport material through fire separations, it may not be possible to use standard closure devices. NFPA 80, “Fire Doors and Other Opening Protectives,” includes appendix information concerning protection of openings through vertical fire separations. NFPA 13, “Installation of Sprinkler Systems,” includes methods of protecting openings through floor assemblies, however, it is assumed by that standard that the remainder of the building would be sprinklered. Combinations of methods may be required to ensure that the level of safety inherent in the requirements of the Code is maintained.

**A-3.2.8.2.(6)(b) Restriction on Size of Openings Through Floors.** The phrase “used only for stairways, escalators or moving walks” is intended to restrict the size of a floor opening to what is necessary to accommodate the stairway, escalator or moving walk.

**A-3.2.8.2.(6)(c) Waiver of Occupancy Separation Continuity.** The typical application of this Sentence is to buildings with a mixture of occupancies that are randomly located throughout the building. Examples include shopping centres, podia of large commercial and business complexes, and recreational buildings that are combined with mercantile and business operations. A shopping mall with two interconnected storeys is an example that is frequently encountered in many jurisdictions. The permission to breach the floor assembly between the storeys does not override requirements for separation of specific suites or occupancies. For instance, although storage garages are Group F, Division 3 occupancies, the requirement in Article 3.3.5.6. for the storage garage to be separated from other occupancies by a fire separation with at least a 1.5 h fire-resistance rating must be observed. In a similar manner, a theatre or cinema (Group A, Division 1 occupancy) must be separated from other occupancies in accordance with Sentence 3.3.2.2.(1) and seats in an arena-type building (Group A, Division 3) must be separated from space below in accordance with Sentence 3.3.2.2.(3).

**A-3.2.8.4.(1)(c) Contamination of Vestibule.** The vestibule should have equipment capable of maintaining a supply of air into the vestibule that is sufficient to ensure that the air pressure in the vestibule when the doors are closed is higher by at least 12 Pa than the air pressure in the adjacent floor areas when the outdoor temperature is equal to the January design temperature on a 2.5% basis.

**A-3.2.8.7.(1) Smoke Exhaust System.** The mechanical exhaust system is intended as an aid to firefighters in removing smoke and is to be designed to be actuated manually by the responding fire department. Although smoke is normally removed from the top of the interconnected floor space, exhaust outlets at other locations may be satisfactory.

**A-3.2.9.1.(1) Testing of Fire Protection and Life Safety Systems.** Building owners should verify that fire protection and life safety systems and their components (i.e. fire alarm systems, sprinklers, standpipes, smoke control, ventilation, pressurization, door hold-open devices, elevator recalls, smoke and fire shutters and dampers, emergency power, emergency lighting, fire pumps, generators, etc.), including their interconnections with other building systems, are functioning according to the intent of their design. CAN/ULC-S1001, "Integrated Systems Testing of Fire Protection and Life Safety Systems," provides the methodology for verifying and documenting that interconnections between building systems satisfy the intent of their design and that the systems function as intended by the Code.

Clause 6.1.5 of CAN/ULC-S1001 allows the Integrated Testing Coordinator to accept documented evidence of any tests that have been performed on a system as part of its acceptance testing for the purpose of demonstrating compliance with the integrated testing requirements of that standard, so as to avoid duplication of work.

**A-3.3. Safety Within Floor Areas.** Section 3.3. regulates safety within floor areas including rooms and other spaces within a building. The requirements are grouped according to the occupancy of the floor area, room or space, which is not necessarily the same as the major occupancy for which the building is classified. For example, a building may be classified by major occupancy as an office building; therefore, the provisions for structural fire protection and fire protection equipment for office buildings prescribed in Section 3.2. apply. However, within that building, a room or floor area may be used for mercantile, care, treatment, detention, business, residential, industrial or other occupancy.

Life safety for the occupants of any floor area depends in the first instance on the use or occupancy of that floor area. The risks to the occupants occur in the early stages of a fire. These special life risks differ from one occupancy to another and, consequently, must be regulated differently. Section 3.3. regulates risks within floor areas: these requirements apply regardless of the major occupancy of the building that contains the floor areas. For example, an assembly room must comply with the requirements for assembly occupancy whether it is contained in an office building, hospital, hotel, theatre, industrial building or other major occupancy.

Since this Code regulates new construction, alterations and changes of occupancy, the construction of kiosks and similar structures in public corridors must take into consideration all the requirements that apply to the remainder of the building, including structural fire protection, construction type, finish materials, egress widths and sprinkler installations. Special activities of an occasional nature that were not contemplated in the original design of a public corridor and that represent only a temporary change in occupancy are regulated by the NFC. These regulations include maintaining egress paths clear of obstructions, controlling combustible contents and providing measures to ensure quick response for firefighting.



**A-3.3.1.2.(1) Hazardous Substances.** The term “hazardous substances” refers to dangerous goods that are regulated by TC SOR/2008-34, “Transportation of Dangerous Goods Regulations (TDGR),” or that are classified as “controlled products” under the “Workplace Hazardous Materials Information System (WHMIS)” established to meet the requirements of HC SOR/2015-17, “Hazardous Products Regulations.” It also refers to materials and products that are not regulated by the TDGR or WHMIS, but that pose a fire or explosion hazard due to their own properties or because of the manner in which they are stored, handled or used. These include combustible products, rubber tires, combustible fibres, combustible dusts, products producing flammable vapours or gases, etc.

**A-3.3.1.2.(2) Cooking Equipment Ventilation.** Cooking equipment manufactured for use in dwelling units and other residential suites is often installed in buildings used for assembly and care, treatment or detention purposes. It is not obvious from the Code requirements or those of NFPA 96, “Ventilation Control and Fire Protection of Commercial Cooking Operations,” whether a ventilation and grease removal system is required in all assembly and care, treatment or detention uses. If the equipment is to be used in a manner that will produce grease-laden vapours that are substantially more than would be produced in a normal household environment, then it would be appropriate to apply the requirements of NFPA 96. If the equipment is used primarily for reheating food prepared elsewhere or is used occasionally for demonstration or educational purposes, there would be no expectation of applying the requirements of NFPA 96. In all cases the circumstances should be reviewed with the authority having jurisdiction.

**A-3.3.1.7.(1) Temporary Refuge for Persons with Disabilities.** These measures are intended to provide temporary refuge for persons with disabilities. It is acknowledged, however, that the measures cannot provide absolute safety for all occupants in the fire area. It may, therefore, be necessary to develop special arrangements in the fire safety plan to evacuate persons with disabilities from these areas. Details for a suitable plan are contained in the NFC.

The protected elevator referred to in Clause 3.3.1.7.(1)(a) is intended to be used by firefighters as a means for evacuating persons with disabilities. It is not intended that this elevator be used by persons with disabilities as a means of egress without the assistance of firefighters.

If an estimate is to be made of the number of persons with disabilities in a floor area who can be accommodated in each zone in Clause 3.3.1.7.(1)(b), this estimate may be based on Table 3.8.2.3., which is used to determine the minimum number of spaces to be provided for wheelchair occupants in fixed seating areas. If more precise information is available, it should be used for sizing the zones.

**A-3.3.1.7.(1)(b) Zones.** The floor area on either side of a horizontal exit conforming to Article 3.4.6.10. may be considered as a zone in applying the requirements of Article 3.3.1.7.

**A-3.3.1.9.(4) Obstruction in Corridor.** The sweep of a cane used by blind or visually impaired persons normally detects obstructions that are within 680 mm of the floor. Any obstruction above this height would not normally be detected and can, therefore, create a hazard if it projects more than 100 mm into the path of travel.

**A-3.3.1.12.(3) Movable Partitions.** Should an emergency situation arise outside of normal working hours but when occupants are still in the space, they could be left without a clear way out. This could occur during inventory or after closing time when all occupants have not yet left, but staff close the door to prevent other persons from entering. In many small tenant areas, the movable partitions (store fronts) provide the only way out. There should always be a second way out or a swinging door within or adjacent to the sliding partitions.

**A-3.3.1.13.(4) Door Hardware.** The permission to have additional door releasing devices is intended to allow the use of a security chain, night latch or dead bolt to supplement the normal door latching device. These are permitted for dwelling units and locations where guests in a hotel or motel require additional security. The height of these items is also governed by the maximum height stipulated in Sentence 3.3.1.13.(5) to ensure that they can be operated by persons with physical disabilities. This additional hardware should not require appreciable dexterity by the user and the general requirements on the ability to operate the device without the use of keys, special tools or specialized knowledge still apply.

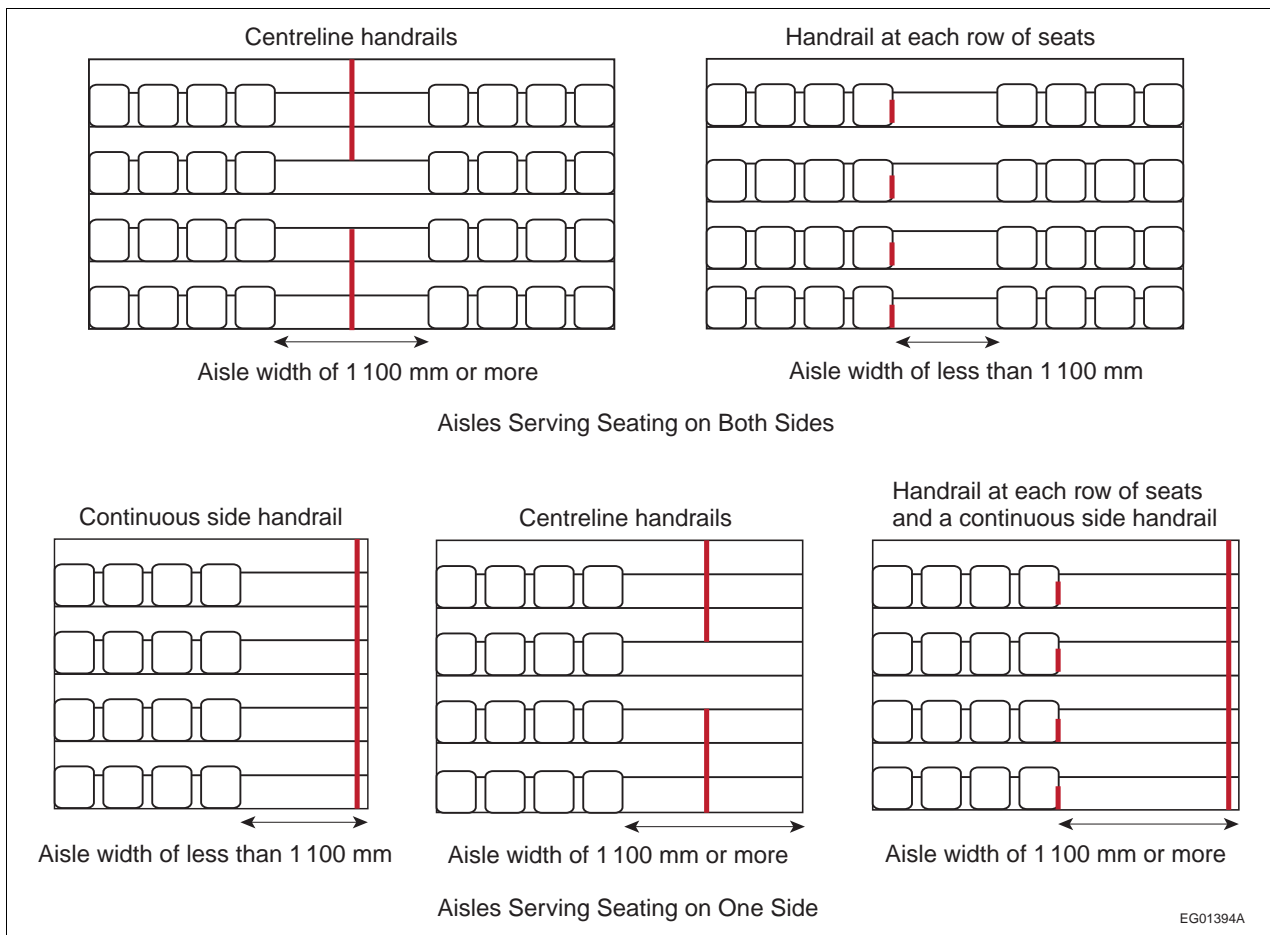
**A-3.3.1.13.(6) Controlled Egress Doors.** It is intended that Sentence 3.3.1.13.(6) apply to doors used at the perimeter of a contained use area or an impeded egress zone. If the contained use area consists of a single room, the requirements would apply to that room. In the case of individual cells within a contained use area, exterior keyed locks could be used on the cell doors consistent with the fire safety plan and continuous supervision by staff who can release the doors in an emergency.

**A-3.3.1.23.(1) Obstructions in Means of Egress.** Obstructions including posts, counters or turnstiles should not be located in a manner that would restrict the width of a normal means of egress from a floor area or part of a floor area unless an alternative means of egress is provided adjacent to and plainly visible from the restricted means of egress.

**A-3.3.2.1.(2) Use of NFPA 101.** The intention of Sentence (2) is to allow Code users the option of using NFPA 101, "Life Safety Code," to address the following issues: means of egress; egress routes within assembly occupancies; aisles and access serving seating not at tables; guards and railings; life safety evaluation; and smoke-protected assembly seating. However, opting to use NFPA 101 under this application entails adherence to all the provisions listed in Sentence (2); it is not intended that Code users randomly select and apply a mix of provisions from both the NBC and the NFPA.

**A-3.3.2.4.(2) Tablet Arms.** Although it is intended that the motion to raise the tablet arm be essentially a single fluid motion, it is acceptable that the motion be a compound motion of raising the tablet arm and including an articulation to allow the tablet to fall back alongside the arm rest.

**A-3.3.2.10. Installation Configurations of Handrails in Aisles with Steps.** Figure A-3.3.2.10. illustrates possible installation configurations of handrails serving aisles with steps.



**Figure A-3.3.2.10.**  
**Handrail installation configurations**

**A-3.3.3.1.(1) Safety in Care, Treatment and Detention Occupancies.** Fire safety for patients in bedroom areas in hospitals and nursing homes with treatment is predicated on the ability of staff to carry out at all times essential life safety functions in accordance with the fire safety plan. Details for a plan are contained in the NFC.

Many factors may affect the ability of staff to carry out life safety functions, including the mobility of patients who cannot fend for themselves and the built-in protection for patients who cannot be moved except under exceptional circumstances.

Should a patient area in a hospital or nursing home with treatment contain factors which would increase the time normally required for staff to evacuate patients or to undertake other life safety measures, consideration should be given to providing additional fire protection measures to ensure that equivalent safety is available.

**A-3.3.3.4.(2) Doorway Width.** The 1 050 mm minimum clear width of doorways accounts for door stops and, thus, is intended to allow for the use of 1 100 mm doors.

**A-3.3.3.5.(9) Intercommunicating Rooms.** Rooms that are interconnected can include more than one sleeping room, together with ensuite toilet rooms, shower rooms, and storage closets used for the storage of personal items of the persons occupying the sleeping rooms. It is not intended that storage rooms for other purposes be included within the group of interconnected rooms.

**A-3.3.3.5.(13) Grilles and Louvres.** In order to permit the supply of make-up air to compensate for the removal of exhaust air from these toilet rooms, shower rooms and similar spaces, it is permitted to incorporate grilles and louvres for the transfer of air provided the air movement cannot allow smoke to pass through these spaces to other parts of the building. It is considered that in normal designs the air is exhausted directly to the exterior and is not circulated. If air is to be circulated back to other parts of the building, smoke operated dampers should be included in the air circulating system.

**A-3.3.4.4.(1) Landing in Egress Stairway.** A landing level used in an egress stairway from a dwelling unit is not considered to be a storey of that dwelling unit if the landing is used only for pedestrian travel purposes.

**A-3.3.4.5.(1) Automatic Locking Prohibited.** Doors that must be manually reset to lock them when they are opened from the inside meet the intent of this requirement.

**A-3.3.6.1.(1) Design of Buildings Containing Dangerous Goods.** Subsection 3.3.6. applies to the short- or long-term storage of products, whether raw or waste materials, goods in process, or finished goods.

This Subsection does not deal with products or materials that are directly supplied to appliances, equipment or apparatus through piping, hose, ducts, etc. For example, the gas cylinders that are mounted on propane barbecues are not covered by Subsection 3.3.6.; they are considered to be “in use” as opposed to “in storage” and are not intended to be regulated by the storage requirements stated in the NFC.

**A-3.3.6.2.(2) Storage of Reactive Materials.** Reactive materials include various classes of unstable or reactive dangerous goods, such as flammable solids, pyrophoric materials, oxidizers, corrosives, water-reactive substances and organic peroxides.

In general, it is unsafe to store highly reactive oxidizers close to liquids with low flash points, combustible products or chemically incompatible products. Quantities of oxidizers or other dangerously reactive materials should therefore be limited and the storage area should be constructed of noncombustible materials, should be kept cool and ventilated, and should not impede egress.

In some cases, depending on the quantity and nature of the oxidizing agent, normal fire protection measures (e.g. sprinklers, fire hose and extinguishers) are ineffective due to the self-yielding of oxygen by the oxidizing agent.

When containers of highly reactive oxidizers become damaged or are exposed to excessive heat, humidity or contamination (e.g. sawdust, petroleum products, or other chemicals), a very violent fire or explosion can result.

The following oxidizing substances, among others, are known to supply oxygen: organic and inorganic peroxides; pool chemicals (e.g. calcium hypochlorite, sodium dichloroisocyanurate); oxides; permanganates; perrhenates; chlorates; perchlorates; persulfates; organic and inorganic nitrates; bromates; iodates; periodates; perselenates; chromates, dichromates; ozone; perborates.

When containers of dangerously reactive materials become damaged or are exposed to water or humidity, a flammable gas (such as hydrogen, ammonia or methane) or a toxic gas (such as hydrogen chloride, hydrogen bromide or phosphine) can be released.

The following dangerously reactive materials, among others, are known to release a flammable gas in reaction to contact with water or humidity: alkali metals (e.g. sodium, potassium, cesium); reactive metals (e.g. zinc, aluminum, magnesium); metallic hydride (e.g. sodium borohydride, germanium tetrahydride, calcium hydride).

The following dangerously reactive materials, among others, are known to release a toxic gas in reaction to contact with water or humidity: organic and inorganic chloride (e.g. phosphorus trichloride, phosphorus oxide trichloride, acetyl chloride); organic and inorganic bromide (e.g. phosphorus tribromide, aluminum tribromide, acetyl bromide).

**A-3.3.6.2.(4) Wiring and Electrical Equipment in Hazardous Locations.** In addition to the general requirements of CSA C22.1, "Canadian Electrical Code, Part I," special attention must be given to Sections 18, 20 and 22: Section 18 specifies wiring requirements for Class I, II and III hazardous locations; Section 20 provides specific requirements for areas where flammable or combustible liquids are stored or dispensed; Section 22 specifies wiring requirements for areas where corrosive liquids or vapours or excessive moisture are present.

**A-3.3.6.4.(2) Explosion Venting in Hazardous Locations.** When a flammable mixture of air and vapour/gas/dust is ignited and causes an explosion, the exothermic reaction results in the rapid expansion of heated gases and the corresponding pressure waves travel through the mixture at sonic or supersonic velocities. The pressures developed by an explosion very rapidly reach levels that most buildings and equipment cannot withstand unless specifically designed to do so. Explosion venting consists of devices designed to open at a predetermined pressure to relieve internal pressure build-up inside a room or enclosure, hence limiting the structural and mechanical damage.

The major parameters to be considered in designing an explosion venting system for a building are:

- the physical and chemical properties of the flammable air mixture, such as the particle size or the droplet diameter, the moisture content, the minimum ignition temperature and explosive concentration, the burning velocity or explosibility classification, the maximum explosion pressure and the rate of pressure rise,
- the concentration and dispersion of the flammable mixture in the room,
- the turbulence and physical obstructions in the room,
- the size and shape of the room, the type of construction and its ability to withstand internal pressures, and
- the type, size and location of relief panels, which should also be designed to reduce the possibility of injury to people in the immediate vicinity of the panels.

**A-3.3.6.5.(1) Measurement of Tire Storage Volume.** The volume of tires in a storage area can be determined by measuring to the nearest 0.1 m the length, width and height of the piles or racks intended to contain the tires. In racks, the top shelf is assumed to be loaded to maximum possible height, while observing required clearances between structural elements and sprinklers.

**A-3.3.6.6.(6) Products Stored with Ammonium Nitrate.** Copper and its alloys should not be used where they can come into contact with ammonium nitrate. The presence of copper represents the single biggest hazard with respect to the accidental detonation of ammonium nitrate during a fire.

Steel and wood can be protected with special coatings such as sodium silicate, epoxy, or polyvinyl chloride.

Asphalt and similar hydrocarbon-based roof coverings should not be used. Stored ammonium nitrate may become sensitized during a fire if such roof coverings melt and leak into the interior of the building, causing burning droplets to fall on the stored product.

**A-3.4.1.1.(1) Type of Exit Facility.** The requirements for exits in Section 3.4. were developed for new construction. If alterations are made to an existing building or changes of occupancy occur, other design solutions than those in Section 3.4. may have to be developed to maintain an acceptable level of safety if it is not practicable to fully conform to the requirements of this Section. In some cases the use of fire escapes to supplement the existing exit facilities may be the only practicable solution. Because of the variety of conditions that may be encountered in existing buildings, it is difficult to standardize or codify such requirements. Alternative means of providing acceptable levels of safety may have to be tailored to the particular building design. In all cases, however, the requirements described in Section 3.4. are intended to provide the level of safety to be achieved. If alternative measures are used, they should develop the level of safety implied in these requirements.

**A-3.4.1.6.(2) Sleeping Area.** Areas serving patients' sleeping rooms include sleeping areas and areas where patients are taken for treatment.

**A-3.4.2.3.(1) Least Distance Between Exits.** The least distance measurement does not apply to each combination of exits on a multi-exit storey. It only applies to at least 2 of the required exits from that storey.

**A-3.4.3.2.(6) Evacuation of Interconnected Floor Space.** This Sentence ensures that egress facilities allow for the simultaneous evacuation of all portions of an interconnected floor space. It does not contemplate the phased evacuation of occupants; thus in buildings where that type of evacuation is intended, fire protection requirements in addition to those prescribed in the Code may be necessary.

In the first instance, this Sentence provides for cumulative exiting that can accommodate the efficient movement of all occupants in the exit stairs. Clause 3.4.3.2.(6)(a) permits an alternative approach that will accommodate all the occupants in the stairs but will restrict the egress flow rate. Clause 3.4.3.2.(6)(b) provides a second alternative that assumes the occupants must queue before entering the stair. A "protected floor space" conforming to Article 3.2.8.5. is intended to provide an intermediate area of safety that is protected from the hazards of the interconnected floor space. It does not provide a holding or refuge area for all occupants of a floor area for an extended period of time.

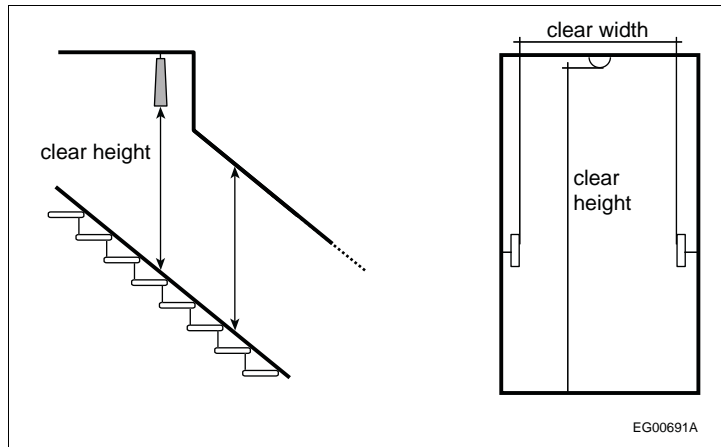
To ensure that evacuation is not unduly delayed and that queuing of the occupants in the protected floor space can be accommodated, requires careful consideration in the design of the interface between the interconnected floor space/protected floor space/exit.

It is not appropriate, for example, to share a common vestibule in complying with Sentences 3.2.8.4.(1) and 3.2.8.5.(1). Under evacuation conditions, occupants entering the vestibule would flow towards the exit, as opposed to the protected floor space, thus resulting in queuing outside the vestibule and potential exposure to fire. To comply with the intent, it is necessary to design the egress path such that the occupants enter the protected floor space through a vestibule, then in turn enter the exit stair from the protected floor space. In addition, sufficient space should be provided between the vestibule and the exit to allow for the queuing of occupants in the protected floor space.

**A-3.4.3.2.(6)(a) Temporary Safety Area.** The objective of Clause 3.4.3.2.(6)(a) is to provide an area of temporary safety in the exit stair shafts for the occupants of the interconnected floor space. This requirement is considered to be met if 0.3 m<sup>2</sup> per person is provided in the stair shaft between the floor level served and the floor level immediately beneath it.

**A-3.4.3.4. Clear Height and Width.** Clear height is intended to be measured from a line tangent to the nosings extended to the underside of the lowest element above the walking surface, over the clear width of the exit (see Figure A-3.4.3.4.). Examples of low elements above the walking surface include light fixtures or sprinkler heads and piping.

Clear width is intended to be measured from a line tangent to horizontal protrusions such as handrails.



**Figure A-3.4.3.4.**  
**Measuring clear height**

**A-3.4.4.2.(2)(e) Requirements for Lobby.** If an exit is permitted to lead through a lobby, the lobby must provide a level of protection approaching that of the exit. As well as meeting the width and height requirements for exits, the lobby must be separated from the remainder of the building by a fire separation having a fire-resistance rating at least equal to that required for the exit, unless one of the exceptions in this Clause is applied.

**A-3.4.5.1.(2)(c) Graphical Symbols for Exit Signs.** ISO 7010, “Graphical symbols – Safety colours and safety signs – Registered safety signs,” identifies the following internationally recognized symbols for use at required exits.



**Figure A-3.4.5.1.(2)(c)-A**  
**“Emergency exit left” (E001) symbol from ISO 7010**



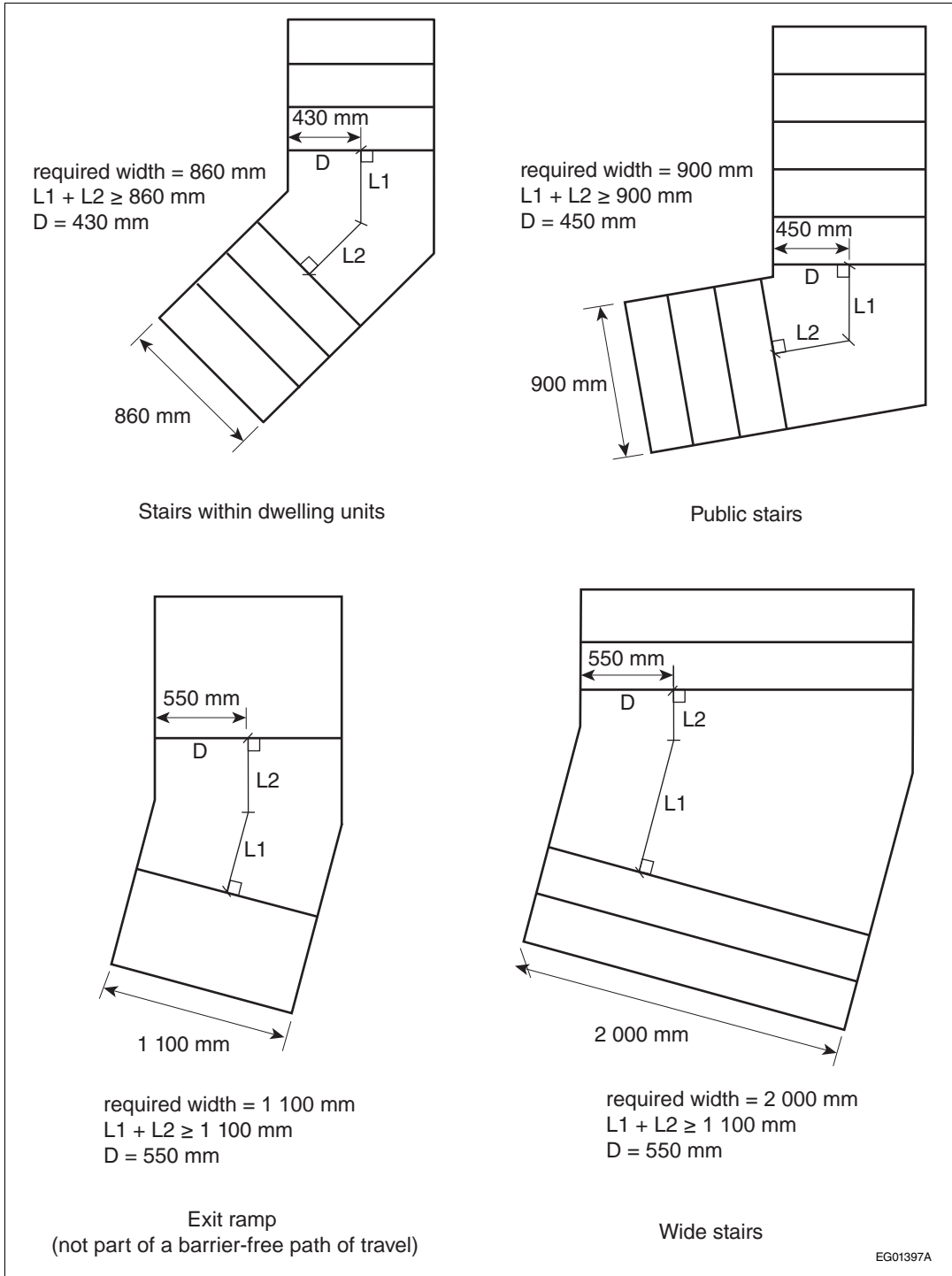
**Figure A-3.4.5.1.(2)(c)-B**  
**90-degree directional arrow (E005) from ISO 7010**

**A-3.4.5.1.(4) Externally Illuminated Signs.** An external lighting source is required to properly charge photoluminescent signs. These types of signs must be lit in conformance with the charging requirements indicated on the exit signs in accordance with CAN/ULC-S572, "Photoluminescent and Self-Luminous Exit Signs and Path Marking Systems."

**A-3.4.6. Application to Means of Egress.** The requirements in Subsection 3.4.6. apply to interior and exterior exits, as well as to ramps, stairways and passageways used by the public as access to exit. The treads, risers, landings, handrails and guards for the latter access to exit facilities must thus be provided in conformance with the appropriate requirements for exit facilities.

**A-3.4.6.4. Dimensions of Landings.** A landing is a floor area provided at the top or bottom of a flight of stairs or a ramp, or a platform built as part of a stairway or ramp. Landings provide a safe surface for users to rest upon, allow design flexibility, and facilitate a change in direction.

Figure A-3.4.6.4. illustrates how to measure the length of a landing for various landing configurations turning less than 90°, including straight landings.



**Figure A-3.4.6.4.**  
**Landing configurations**  
**Notes to Figure A-3.4.6.4.:**

- (1)  $L1 + L2$  = length of the landing  
 = the lesser of the required width of the stair or ramp, or 1 100 mm  
 See Sentences 3.4.6.4.(2) and 9.8.6.3.(2).
- (2)  $D$  = distance from the narrow edge where the length of the landing is measured  
 = half the required length of the landing  
 See Sentences 3.4.6.4.(3) and 9.8.6.3.(3).



**A-3.4.6.5.(4) Wider Stairs than Required.** The intent of Sentence 3.4.6.5.(4) is that handrails be installed in relation to the required exit width only, regardless of the actual width of the stair and ramp. The required handrails are provided along the assumed natural path of travel to and from the building.

**A-3.4.6.5.(10) Continuity of Handrail.** Blind or visually-impaired persons rely on handrails to guide them on stairways. A continuous handrail will assist them in negotiating stairs at changes in direction. The extended handrail is useful to persons with physical disabilities to steady themselves before using the stairs. Handrails should, however, return to the wall, floor or post, so as not to constitute a hazard to blind or visually-impaired persons.

**A-3.4.6.10.(5) Door Swing.** Although it is required that the door on the right hand side of a pair of doors shall swing in the direction of travel through the exit, the direction of swing of the door on the left side will depend on the function of the horizontal exit. If the horizontal exit provides for movement from one building to the adjacent building but does not require movement in the reverse direction, both doors must swing in the direction of travel to the adjacent building. If the design is based upon both buildings providing complementary movement in either direction, then the doors must swing in opposite directions. Location of a required exit sign directly above a door that swings in the direction of travel is deemed to meet the intent of Clause 3.4.6.10.(5)(b).

**A-3.4.6.11.(4) Exit Concealment.** Hangings or draperies placed over exit doors may conceal or obscure them.

**A-3.4.6.16.(1) Fastening Device.** Turnpieces of a type which must be rotated through an angle of more than 90° before releasing a locking bolt are not considered to be readily openable. The release of a locking bolt should allow the door to open without having to operate other devices on the door.

**A-3.4.6.16.(4) Electromagnetic Lock.** Electromagnetic locks are intended for use where there is a need for security additional to that provided by traditional exit hardware. They are not intended for indiscriminate use as alternative locking devices. The design of these devices requires evaluation to ensure that their operation will be fail-safe in allowing exiting in the event of foreseeable emergencies. If more than one locking device is used in a building, it is expected that one switch will release and reset all devices simultaneously.

**A-3.4.6.16.(5) Electromagnetic Locks in Care and Treatment Occupancies.** The installation of electromagnetic locks in care and treatment occupancies requires special provisions to address the compromised condition of residents and the nature of daily operations. Accordingly, to reduce the incidence of false operation by residents, transparent boxes that set off an audible signal when opened can be installed to cover the manual stations. Also, one optional additional release device (e.g. swipe card device, key pad) can be installed to facilitate the free movement of staff and visitors in the building.

**A-3.4.6.17.(1) Special Security for Doors.** The need for security in banks and in mercantile occupancies requires the ability to use positive locking devices on doors that may not readily be opened from inside the building. In a fully sprinklered building, the risk to persons inside the building is substantially reduced. The provisions of Sentences 3.4.6.17.(2) to (9) assume that the area is illuminated and that a means of communication is available to any occupant during times that the doors are locked.

**A-3.4.6.19.(1)(d) Colour Contrast.** The identification of floor and other signs intended to facilitate orientation for visually-impaired persons should offer maximum colour contrast to be effective. For this reason, it is recommended that white on black or black on white be used, as this combination produces the best legibility. It is also recommended that the sign surfaces be processed to prevent glare.

**A-3.5.2.1.(1) Elevator Design.** The reference to ASME A17.1/CSA B44, "Safety Code for Elevators and Escalators," in this Sentence implies conformance with all requirements of that standard for elevator cars, hoistways, pits and machine rooms, including restrictions on other services in these areas and detailed design criteria.

**A-3.5.4.1.(1) Elevator Car Dimensions.** In some circumstances it is necessary to maintain a patient on a stretcher in the prone position during transit to a hospital or to treatment facilities. Inclining the stretcher to load it into an elevator could be fatal or at the very least detrimental to the patient's health. Many ambulance services use a mobile patient stretcher whose size is 2 010 mm long and 610 mm wide. As well as space for the stretcher in the elevator, there should be sufficient additional space for at least two attendants who may also be providing treatment during transit. Common elevator units that can satisfy this requirement include:

- a 1 134 kg elevator car with minimum interior dimensions of 2 032 mm wide and 1 295 mm deep with a right or left hand access door. The minimum access door width is 1 067 mm and it must be on the 2 032 mm side of the car.
- a 1 134 kg elevator car with minimum interior dimensions of 2 032 mm deep and 1 295 mm wide with a minimum 915 mm wide access door located on the 1 295 mm side.

**A-3.6.2.5.(1) Combustible Refuse Storage.** Storage of refuse consisting of combustible materials including waste paper, cardboard and plastic, and noncombustible materials such as glass and metallic containers can be accumulated in these rooms for the purpose of recycling. This storage is allowed in consideration of a less stringent collection schedule when compared to that of garbage or refuse, which is collected regularly.

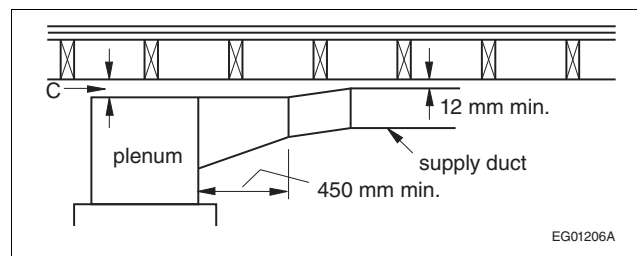
**A-3.6.2.7.(5) Explosion Relief.** Examples of good engineering practice for this application can be found in NFPA 68, “Explosion Protection by Deflagration Venting,” NFPA 69, “Explosion Prevention Systems,” and the NFPA “Fire Protection Handbook.”

**A-3.6.3.1.(1) Vertical Service Spaces.** Sentence 3.6.3.1.(1) does not prohibit the internal subdivision of a vertical service space to allow different building services to be installed in physically separated spaces unless other requirements apply (see, for example, Sentences 3.2.7.10.(2) and (3)). Fire separation requirements apply to the perimeter of the group of service spaces. Article 3.6.3.3. has special requirements for linen chutes and refuse chutes.

**A-3.6.3.5. Grease Duct Enclosures.** NFPA 96, “Ventilation Control and Fire Protection of Commercial Cooking Operations,” presents two options for enclosing grease ducts for commercial cooking equipment: the first option is to use continuous fire-rated building component assemblies to enclose the ducts and the second one consists of installing proprietary, fire-rated, field-applied or factory-built grease duct assemblies in accordance with the manufacturer’s instructions. These types of enclosure assemblies are evaluated for their resistance to fire and their ability to protect adjacent combustibles through reduced clearances. Although NFPA 96 references other standards that deal with grease duct assemblies, Sentence 3.6.3.5.(2) requires that CAN/ULC-S144, “Fire Resistance Test – Grease Duct Assemblies,” be used to determine the fire-resistance rating of factory-built and field-applied grease duct assemblies.

**A-3.6.4.2.(2) Ceiling Membrane Rating.** In construction assemblies that utilize membrane ceiling protection and have been assigned a fire-resistance rating on the basis of a fire test, the membrane is only one of the elements that contribute to the performance of the assembly and does not in itself provide the protection implied by the rating. For the fire-resistance rating of membrane materials used in this form of construction, reference should be made to the results of fire tests which have been conducted to specifically evaluate the performance of this element.

**A-3.6.5.6.(2) Clearance for Warm-Air Supply Ducts.** Applicable to forced-air furnaces where permissible clearance C above plenum is 75 mm or less.



**Figure A-3.6.5.6.(2)**  
**Clearance for warm-air supply ducts**

**A-3.6.5.6.(3) Clearance for Warm-Air Supply Ducts.** Applicable to forced-air furnaces where permissible clearance C above plenum is more than 75 mm but not more than 150 mm.

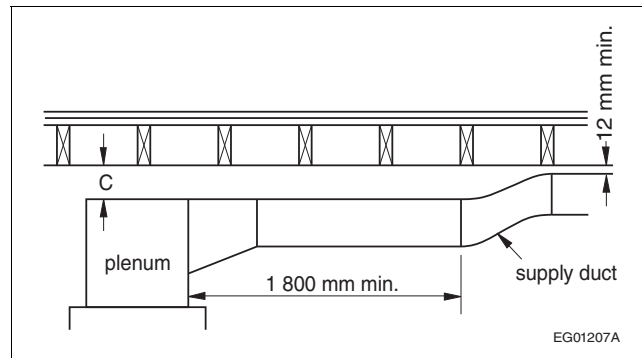


Figure A-3.6.5.6.(3)  
Clearance for warm-air supply ducts

**A-3.6.5.6.(4) Clearance for Warm-Air Supply Ducts.** Applicable to forced-air furnaces where permissible clearance C above plenum is more than 150 mm.

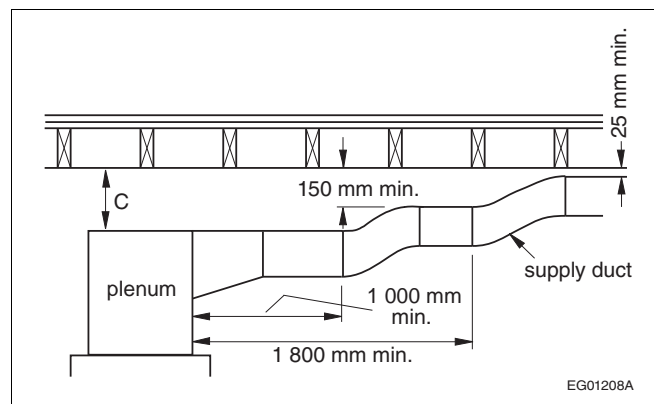


Figure A-3.6.5.6.(4)  
Clearance for warm-air supply ducts

**A-3.7.2.2.(1) Water Closets.** Sentence 3.7.2.2.(1) assumes that there will be a sufficient number of persons in the building to justify the provision of separate water closet facilities for both males and females. In some circumstances overall low occupant loads would not require more than one water closet for males and one water closet for females and yet the building has more than one storey. It is deemed that rooms each containing a single water closet available for both males and females would satisfy the intent of the Code. The total number of water closets must be adequate for the total number of occupants. Requirements for barrier free accessibility also need to be considered. If the entrance storey is accessible and the upper storeys are not required to be accessible, a room in the accessible storey must meet the requirements of Section 3.8. and can serve both males and females. If provided, a nonaccessible room, designed to serve both males and females, in each nonaccessible upper storey would be acceptable. Sentence 3.7.2.2.(4) permits a single water closet to serve both males and females if the total occupant load is low.

**A-3.8. Barrier-Free Design Assumptions.** This Section contains minimum provisions to accommodate a person using a typical manual wheelchair or other manual mobility assistance devices such as walking aids, including canes, crutches, braces and artificial limbs.

**A-3.8.2.1. Accessibility.** Industrial buildings often pose a greater risk to their occupants due to the presence of significant quantities of dangerous materials or the use of hazardous processes. For example, plants which are classified as Group F, Division 2 or 3, may store and use toxic or highly flammable substances in significant quantities, or house processes which involve very high temperatures and which have a high degree of automation. In some facilities, particularly in primary industries such as forestry and metallurgy, the construction normally used and the operations carried out within the space can make compliance with the requirements of Section 3.8. impracticable. It is therefore intended that these requirements be applied with discretion in buildings of Group F, Division 2 or 3 major occupancy. However, where industrial buildings contain subsidiary occupancies, such as offices or showrooms, it is reasonable to require that accessibility be provided in these spaces.

**A-3.8.2.2. Entrances.** An accessible route should exist from the sidewalk or roadway and parking area to an accessible building entrance. This route should be located so that persons with physical disabilities do not have to pass behind parked cars.

To provide more general access to buildings, not less than 50% of the pedestrian entrances are required to be barrier-free. This should include a principal entrance. If the 50% calculation results in a fraction, the number of barrier-free entrances should be the next higher unit value. For the purpose of determining the number of entrances to a building, several adjacent doors in a bank of doors are considered to be a single entrance.

**A-3.8.2.3. Access to Rooms and Facilities.** If barrier-free access is required into suites or rooms in Subsection 3.8.2., it is intended that access be provided, with some exceptions identified in Sentence 3.8.2.3.(2), throughout each room or suite. Some examples of where barrier-free access is required are as follows:

- within each suite (subject to Clauses 3.8.2.3.(2)(j) to (l)),
- within rooms or areas that serve the public or are designated for use by visitors, including areas in assembly occupancies with fixed seats, display areas and merchandising departments,
- within rooms or areas for student use in assembly occupancies,
- within general work areas, including office areas,
- within general use or general service areas, including shared laundry areas in residential occupancies, recreational areas, cafeterias, lounge rooms, lunch rooms and infirmaries,
- within sleeping rooms in hospitals and nursing homes with treatment,
- (if installed), into at least one passenger elevator or elevating device conforming to Articles 3.5.2.1. and 3.8.3.7.,
- into washrooms described in Sentences 3.8.2.8.(1) to (4),
- to any facility required by this Section to be designed to accommodate persons with physical disabilities,
- onto every balcony provided in conformance with Clause 3.3.1.7.(1)(c), and
- to service counters used by the general public (examples include ticket counters, refreshment stands, drinking fountains, cafeteria counters, checkout counters and bank service counters).

The permission to waive a barrier-free path of travel for wheelchair access to certain specified areas of a building is not intended to waive accessibility requirements for persons whose physical disabilities do not require special provision for access to raised or sunken levels. Persons with visual or hearing disabilities that do not require the use of a wheelchair can be expected to move throughout a building.

The concept of providing similar amenities and facilities applies, among other things, to food, beverage, and entertainment facilities within restaurants, to smoking and non-smoking areas permitted in accordance with local regulations, and to window areas providing a view of an exterior attraction.

Availability of specific spaces depends on reservation policy and the sequence in which patrons arrive at a restaurant or other facility, and therefore is beyond the scope of this Code.

Accessibility “within” a floor area means that in general all normally occupied spaces are to be accessible, except those areas which are deemed not to require barrier-free access. Examples of excluded floor areas are small raised office areas in retail and industrial premises and storage platforms in industrial and other occupancies.

The concept of wheelchair accessibility does not extend to building service facilities, nor to all floor levels within a storey, e.g., mezzanines not served by an elevator. Mezzanines that are accessible by an elevator are therefore not excluded.

**A-3.8.2.4.(1) Access to Storeys Served by Escalators and Moving Walks.** In some buildings, escalators and inclined moving walks are installed to provide transportation from one floor level to another floor level so as to increase the capacity to move large numbers of persons. Some buildings located on a sloping site are accessible from street level on more than one storey and an escalator or inclined moving walk is provided for internal movement from floor to floor. In both these situations, a person with a physical disability must be provided with an equally convenient means of moving between the same floor levels within the building. This can be accomplished by providing elevators or a platform-equipped passenger-elevating device.

**A-3.8.2.5. Parking Areas.** In localities where local regulations or bylaws do not govern the provision of or dimensions of barrier-free parking spaces, the following provides guidance to determine appropriate provisions. If more than 50 parking spaces are provided, parking spaces for use by persons with physical disabilities should be provided in the ratio of one for every 100 parking spaces or part thereof. Parking spaces for use by persons with physical disabilities should

- (1) be not less than 2 400 mm wide and provided on one side with an access aisle not less than 1 500 mm wide,
- (2) have a firm, slip-resistant and level surface,
- (3) be located close to an entrance required to conform to Article 3.8.2.2.,
- (4) be clearly marked as being for the use of persons with physical disabilities, and
- (5) be identified by a sign located not less than 1 500 mm above ground level, with the International Symbol of Access and the words “Permit Required” (Figure A-3.8.2.5.-A).



**Figure A-3.8.2.5.-A**  
**“Permit Required” sign**

Asphalt, concrete and gravel are acceptable parking surfaces. Curb ramps should be not less than 920 mm wide. Parallel parking spaces should be not less than 7 000 mm long. If more than one parking space is provided for persons with physical disabilities, a single access aisle can serve two adjacent parking spaces. The arrangement shown in Figure A-3.8.2.5.-B allows the shared use of an access aisle to serve two adjacent parking spaces provided for use by persons with physical disabilities.

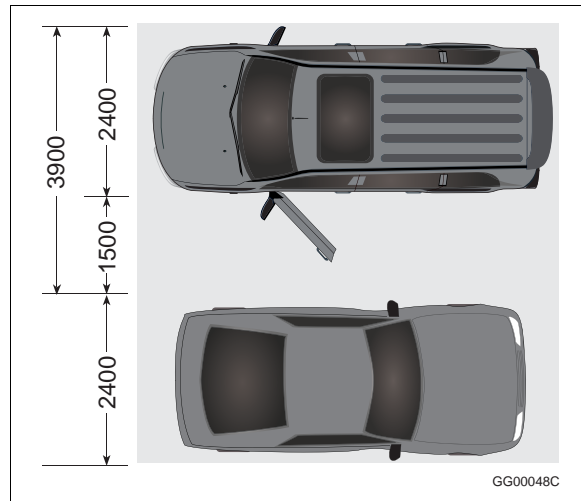


Figure A-3.8.2.5-B  
Shared access aisle

**A-3.8.2.5.(1) Access to Exterior Parking.** It is not intended that a separate accessible entrance must be provided from the exterior parking area. The designer may choose to designate the entrance leading to the exterior parking area as the required entrance or to provide a properly identified and unobstructed path of travel from the parking area to the entrance which is accessible. The entrance chosen should, in any case, be one normally used by the occupants of the building. Long paths of travel are not recommended.

**A-3.8.2.6.(1) Application to Security Access Systems.** Sentence 3.8.2.6.(1) is not intended to reduce the functionality of security devices that limit access to secure areas and are addressed by other Sections of the NBC.

**A-3.8.2.8.(1) to (4) Washrooms.** The primary intent of this requirement is that all regular washrooms be made accessible to all persons, including persons with disabilities, primarily persons who must use a wheelchair. Well-designed washrooms which can accommodate disabled persons need not be much larger than conventional washrooms.

The exception in Clause 3.8.2.8.(2)(b) recognizes situations where several washrooms may be provided on a large floor area. In such a case, not all washrooms need to be barrier-free, provided that a barrier-free washroom is available within a reasonable distance (45 m) of one that is not and that the location of that barrier-free washroom is clearly indicated as required by Sentence 3.8.2.10.(2).

Clause 3.8.2.8.(2)(c) is intended to address “strip malls” (a shopping mall with no public corridor). Section 3.7., which requires plumbing facilities, does not address the concept of suite and could permit, for instance, a shopping mall containing only Group E occupancies (assuming the mall is more than 100 m<sup>2</sup>) to have only one washroom for each sex located in any one of the suites. It is desirable, however, that washrooms be located so as to be accessible at all times, since the owner or tenant of one suite has no control over the activities of another. These buildings may have either public barrier-free washrooms in a central location or washrooms which can accommodate persons with physical disabilities in each suite. This arrangement relieves any one tenant from having to provide “public” washrooms. Hence, the exception for suites of less than 500 m<sup>2</sup> is meant as a relaxation to avoid an unnecessary burden on small facilities but should not be construed as meaning that these buildings need not provide accessible washrooms.

Sentence 3.8.2.8.(4) clarifies that universal washrooms (“unisex”) should not be used as a substitute for making regular washrooms accessible. These washrooms are an alternative which the authority having jurisdiction could require in the course of renovations to an existing building to satisfy the requirements of Sentence 3.8.2.8.(1), where modifying existing washrooms proves impracticable or where Section 3.7. permits the use of a single washroom for both sexes. This does not preclude the provision of special washrooms in addition to barrier-free regular washrooms; “unisex” washrooms are desirable in large shopping complexes and multiple use complexes, as well as transportation terminals, where persons must be accompanied by an attendant because of their degree of disability. These facilities are convenient because they may be used regardless of the gender of the person with the disability or of the attendant.

**A-3.8.2.11.(1) Counters with Work Surfaces.** It is not intended that all counters be barrier-free, but that sufficient barrier-free counter space be available. Examples of counters that should be barrier-free include check-in counters and those in financial institutions and reception areas as well as any counter at which processing and signing of documents takes place. The provision is not intended to apply to work surfaces in industrial occupancies.

**A-3.8.3.1.(1) Barrier-free Design Standards.** Code users who opt to apply the CSA B651 provisions listed in Table 3.8.3.1. must do so without exception: they cannot randomly select and apply a mix of provisions from the NBC and that standard.

**A-3.8.3.2.(2) Surfaces in a Barrier-free Path of Travel.** Floor finishes, including walk-off mats and carpet, should be selected, installed and securely fixed to provide a firm and stable surface so that persons using wheelchairs, walkers or other mobility aids can easily travel over them without tripping or expending undue energy. Other than very high-density, short-pile carpeting, most carpeting does not meet these criteria.

Furthermore, where the path of travel is exposed to intense light conditions, such as daylight or directional lighting, a low-glare or matte floor surface should be selected, as glare from floor surfaces can influence all users' perception and be particularly problematic for persons with low vision. For the same reasons, heavily patterned flooring should also be avoided.

**A-3.8.3.5.(1)(b) Ramp Slopes.** Ramps with a slope of more than 1 in 16 can be very difficult for persons with physical disabilities with upper body mobility to manage. Even though they pose less of a problem for persons in motorized wheelchairs, these ramps can be unsafe to descend, especially in cold climates. Although Article 3.8.3.5. permits slopes on ramps as great as 1 in 12 for distances of up to 9 m, slopes of 1 in 20 are safer and less strenuous. When limited space is available, as may be the case during renovations, ramps with a slope of up to 1 in 12 should be restricted to lengths not exceeding 3 m whenever possible. A strip contrasting in colour and texture should be used at the top and bottom of ramps to warn persons with low or no vision.

**A-3.8.3.5.(1)(c) Landing Design at Doorways Leading to Ramps.**

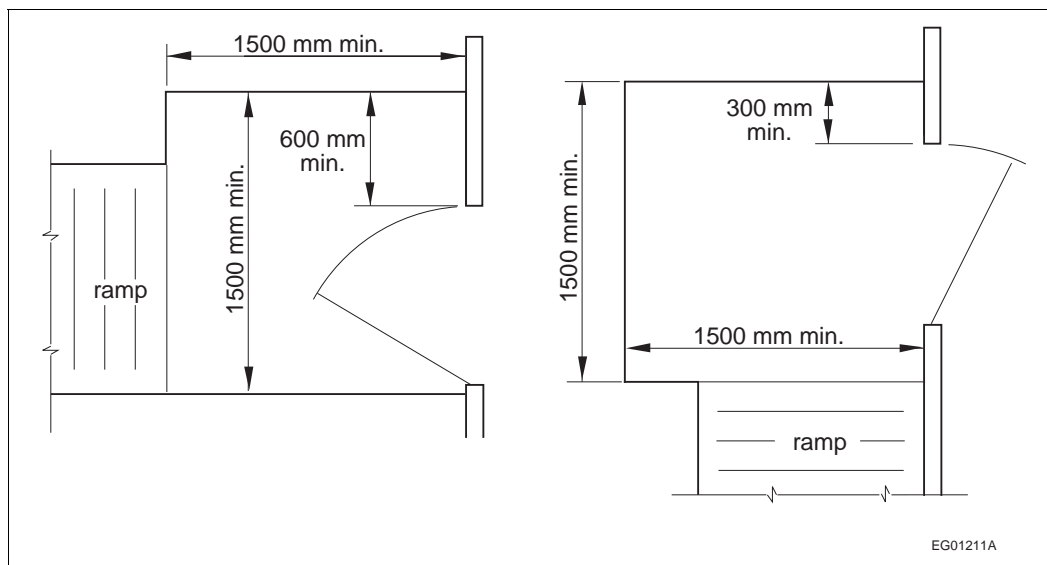
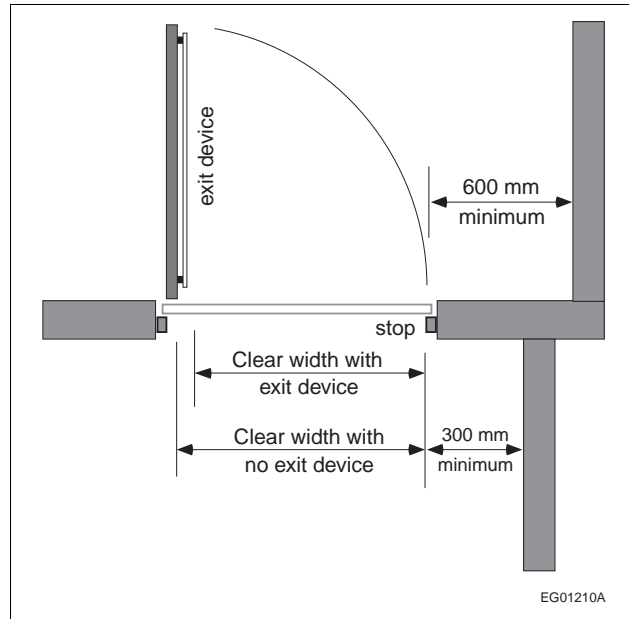


Figure A-3.8.3.5.(1)(c)  
Landing design at doorways leading to ramps

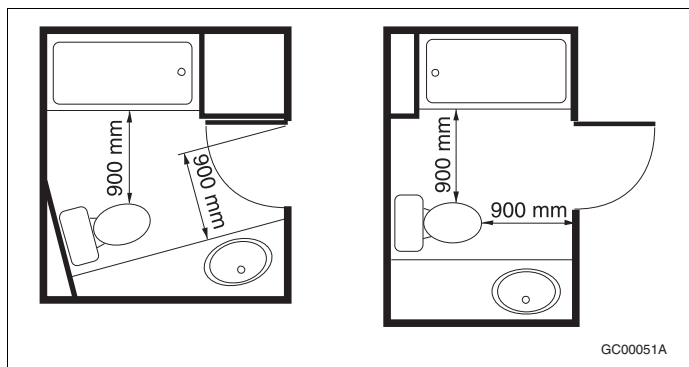
**A-3.8.3.5.(4)(a) Surface of Ramps.** Sentence 3.8.3.2.(2) requires that all walking surfaces in a barrier-free path of travel be stable and firm to limit the effort required by persons using wheelchairs or other mobility aids. Therefore, Sentence 3.8.3.5.(4) requires that hard or resilient flooring be used on the surfaces of steeper ramps. Furthermore, carpet and like materials should not be installed on any ramp.

**A-3.8.3.6.(2) Doorway Width.** Standard wheelchair width specifications indicate a range of sizes from 584 mm overall to 685 mm overall. Every doorway that is located in a barrier-free path of travel must have a clear width of not less than 800 mm when the door is in the open position and therefore it is important that this dimension be measured correctly. Figure A-3.8.3.6.(2) shows a door opened to 90°. It is clear that the door, and to a lesser extent the stop, impinges on the space within the door frame. The clear width of not less than 800 mm is measured from the face of the door to the outside edge of the stop on the door frame. It is not sufficient just to measure the inside width of the door frame. Other factors, including location of door stops other than on the door frame, and the installation of door closers and exit devices, should be taken into account. The intrusion of a door handle into the space is of lesser importance. It is recognized that there are many types of door frame and door mounts but the overall objective is to maintain a clear width of not less than 800 mm. The diagram depicts a somewhat restrictive scenario, as many doors can open wider than 90°, however, a door smaller than 864 mm would not be wide enough to ensure the minimum clear width of 800 mm that is required.



**Figure A-3.8.3.6.(2)**  
**Clear doorway width**

**A-3.8.3.6.(3) Washrooms in Residential Occupancies.** This requirement ensures that the doorway to the washroom in a dwelling unit or a hotel or motel suite is at least large enough to accommodate someone using a wheelchair. The Code does not require these washrooms to be barrier-free, in order to avoid a set of prescriptive requirements which could limit design flexibility. It is relatively simple to make washrooms accessible through careful planning and positioning of fixtures and this can be achieved in an area not much larger than that of conventional washrooms.



**Figure A-3.8.3.6.(3)**  
**Residential washrooms**



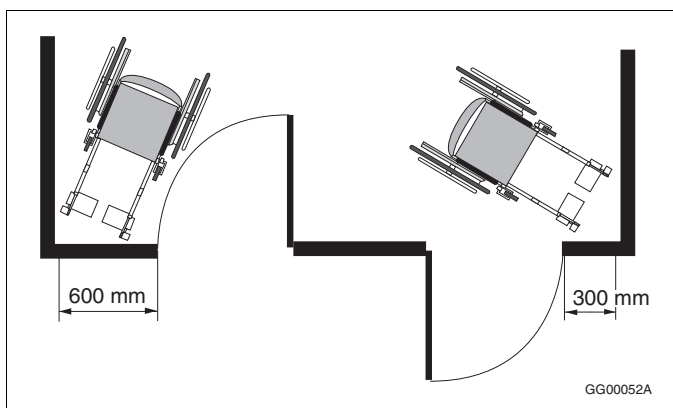
**A-3.8.3.6.(4) Lever Handles.** Lever handles are usable by most persons with limited hand mobility and will meet the intent of this requirement. Lever handles with an end return towards the door are less prone to catch the clothing of someone passing through the doorway.

**A-3.8.3.6.(6) and (7) Doors with Power Operators.** Doors equipped with a power operator actuated by a pressure plate identified with the international symbol for accessibility or, where security is required, by a key, card or radio transmitter, and that can otherwise be opened manually, meet the intent of the requirement. The location of these actuating devices should ensure that a wheelchair will not interfere with the operation of the door once it is actuated. Swinging doors equipped with power operators which are actuated automatically and open into passing pedestrian traffic should be provided with a guard or other device designed to prevent pedestrians from stepping in the swing area of the door. These guards or devices should be detectable by blind persons. For example, inverted U-shaped guards should have an additional rail at a height not more than 680 mm so that it is detectable by the long cane. These doors should also have a device (mat or other sensor) on the swing side to prevent the door from opening if someone is standing in the swing area.

**A-3.8.3.6.(9) Air Pressure Differences.** Differences in air pressure on opposite sides of a door may be due to the operation of mechanical systems such as those associated with smoke control. So-called “stack action” in buildings in winter can also cause differential pressures due to the buoyancy of warm air. Stack action is usually most noticeable between stairwells and the remainder of the building, and at the entrances to buildings; the taller the building, the greater the effect. Doors with automatic closers have to operate with sufficient opening force to allow the return action to overcome the differential pressure.

**A-3.8.3.6.(10) Delayed Action on Door Closers.** In some circumstances, closers with a delay feature which keeps the door open for several seconds before it begins to close might be desirable. However, closers with this feature have limited back-check, a feature of a normal door closer where resistance to opening increases as the door reaches the full arc of swing. Doors equipped with a delayed action closer are therefore more susceptible to damage should the door be opened with too much force or should someone try to force it closed, thinking the closer has failed to operate. Delayed action closers are not recommended for such occupancies as schools.

**A-3.8.3.6.(11) Clearance at Doorways.** Sufficient clearance must be provided on the latch side of doors for a user to operate the door-opening mechanism and open the door without interference from the wheelchair. This is particularly important for a door swinging towards the approach side. See Figure A-3.8.3.6.(11).



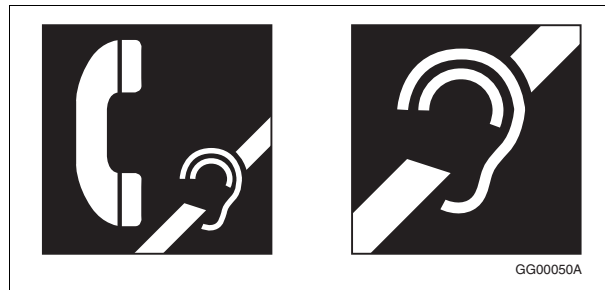
**Figure A-3.8.3.6.(11)**  
**Doorway clearance**

**A-3.8.3.9.(1) Accessibility Signs.** The International Symbol of Access shown in Figure A-3.8.3.9.(1)-A indicates to persons with physical disabilities that they will have reasonable freedom of movement within a building so signed. The symbol is usually white on a blue background; where these colours do not stand out, the sign can be set on a white background. An arrow can be added to indicate direction or the location of an accessible space or facility.



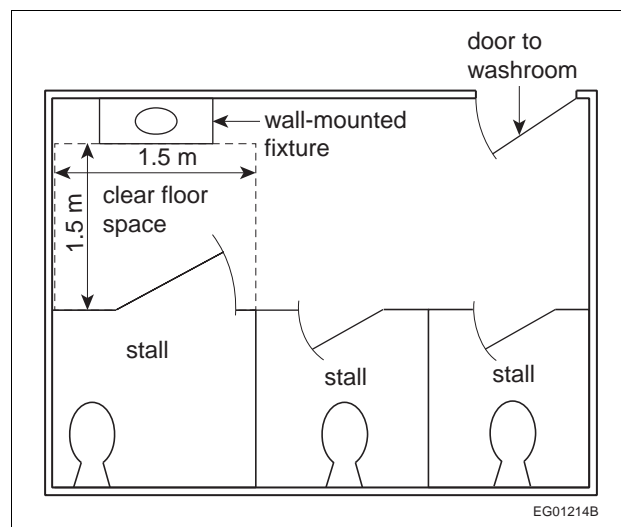
**Figure A-3.8.3.9.(1)-A**  
**Signs indicating accessible facilities**

The International Symbol of Access for Hearing Loss shown in Figure A-3.8.3.9.(1)-B, which indicates accessibility for persons with hearing loss, should be used to indicate the availability of variable volume controls on telephones, assistive listening systems, and text telephones (TT). These latter devices may also be referred to as teletypewriters (TTY) or telecommunications devices for the deaf (TDD).



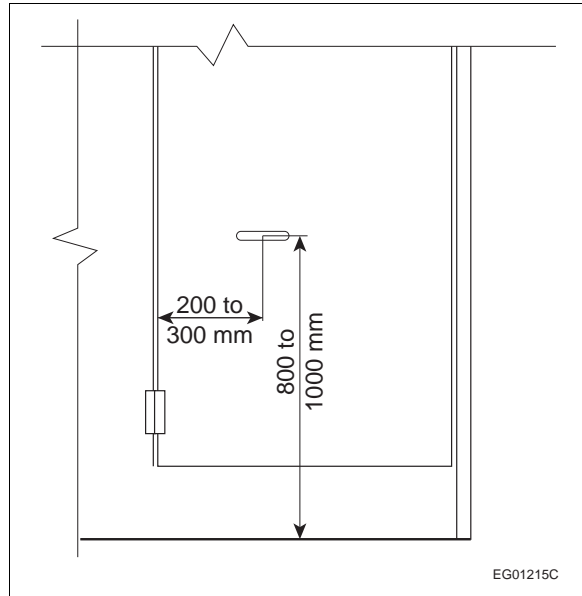
**Figure A-3.8.3.9.(1)-B**  
**Signs for assistive listening facilities**

**A-3.8.3.11.(1)(c)(v) Water-closet Stalls.** Doors to water-closet stalls for persons with physical disabilities should swing outward, preferably against a side wall.

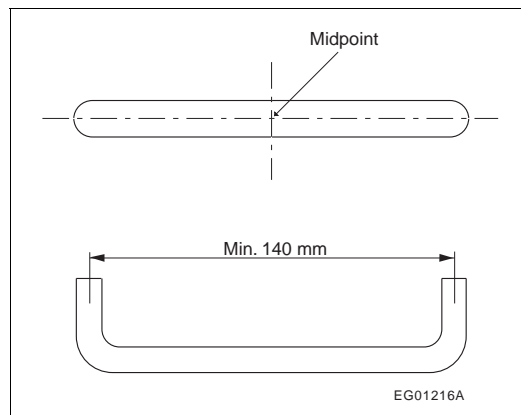


**Figure A-3.8.3.11.(1)(c)(v)**  
**Water-closet stalls**

**A-3.8.3.11.(1)(c)(vi) Door Pulls.** The door pull should consist of a D-shaped handle mounted horizontally. The centre lines are the lines drawn through the long axis and the short axis of the handle. The midpoint of the handle must be located horizontally at 200 to 300 mm from the hinged side of the door and vertically at 800 to 1 000 mm above the finished floor surface.



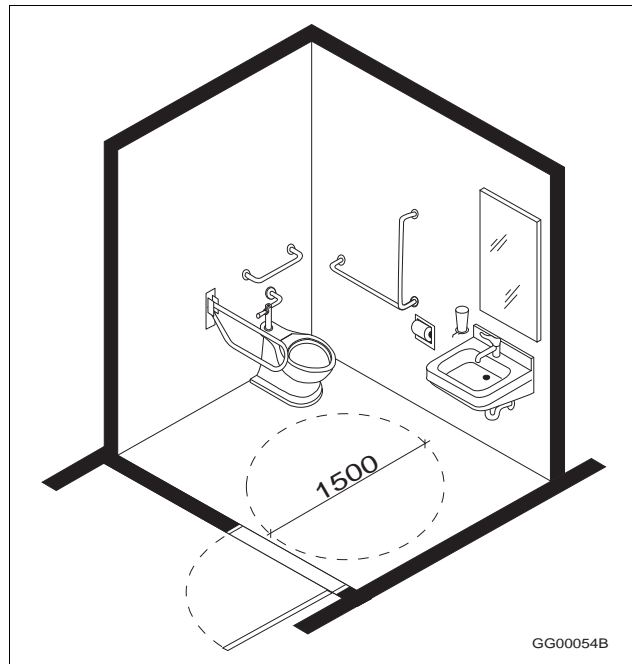
**Figure A-3.8.3.11.(1)(c)(vi)-A**  
Door pull location



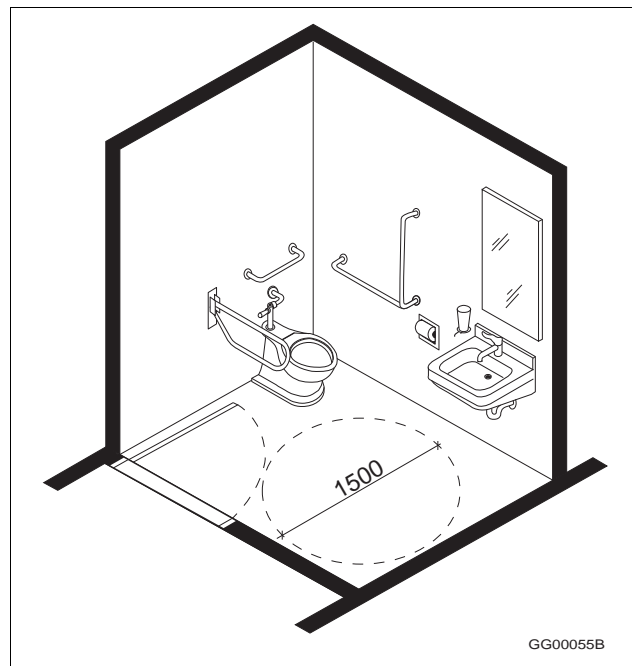
**Figure A-3.8.3.11.(1)(c)(vi)-B**  
Door pull details

**A-3.8.3.11.(1)(e)(ii) Additional Grab Bars.** It is the designer’s prerogative to exceed the minimum requirements found in the NBC and specify the installation of additional grab bars in other locations. These additional grab bars may be of different configurations and can be installed in other orientations.

**A-3.8.3.12. Universal Washrooms.** Unobstructed areas in front of the lavatory, in front of the water closet and on one side of the water closet are necessary for maneuverability of a wheelchair. Although outward swinging doors are preferable for accessibility, inward swinging doors are also permitted. Figures A-3.8.3.12.-A and A-3.8.3.12.-B show design options that meet the intent of Article 3.8.3.12.



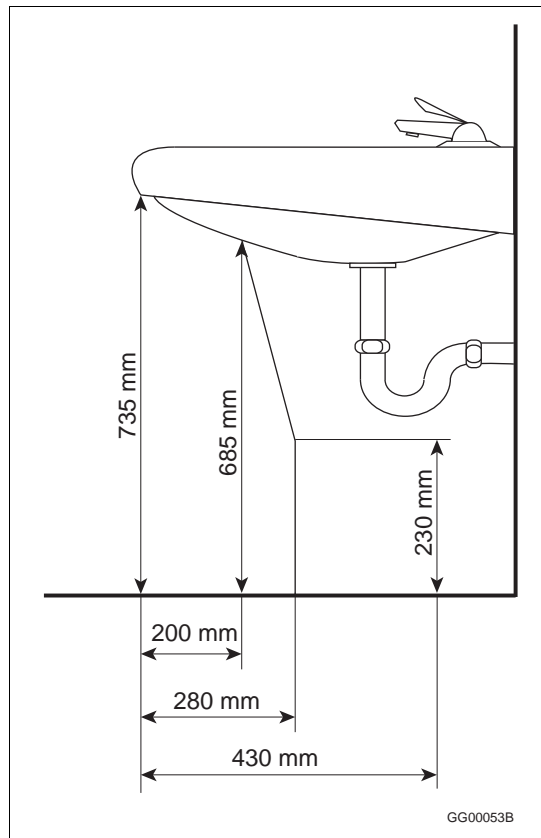
**Figure A-3.8.3.12.-A**  
**Universal washroom with outward swinging door**



**Figure A-3.8.3.12.-B**  
**Universal washroom with inward swinging door**

**A-3.8.3.13.(1) Water Closets.** Wall- or floor-mounted water closets with recessed bases are preferable because they provide the least amount of obstruction.

**A-3.8.3.15.(1)(d) Clearances Beneath a Lavatory.**

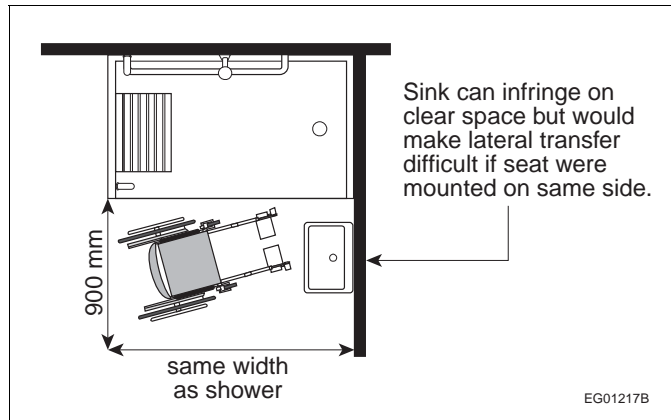


**Figure A-3.8.3.15.(1)(d)**  
Clearances beneath a lavatory

**A-3.8.3.15.(1)(e) Pipe Protection.** The pipes referred to in Clause 3.8.3.15.(1)(e) include both supply and waste pipes. The hazard can be prevented by insulating the pipes, by locating the pipes in enclosures, or avoided by limiting the temperature of the hot water to a maximum of 45°C.

**A-3.8.3.15.(1)(f) Soap Dispenser Location.** The location of accessories, such as soap dispensers and faucets, serving barrier-free lavatories should be established while taking into consideration that their controls must be usable by and within the direct reach of a person in a seated position directly in front of the accessible lavatory.

**A-3.8.3.16.(1)(b) Clear Space at Entrances to Showers.** The clear space at the entrance to a shower may be encroached upon by fixtures such as a wall hung sink which does not interfere with the leg rests of the wheelchair. However, this sink could restrict movement for persons who need to make a lateral transfer if it were installed at the seat end of the shower.



**Figure A-3.8.3.16.(1)(b)**  
Shower design

**A-3.8.3.16.(1)(f) Grab Bars.** One L-shaped grab bar is required to be installed on the wall next to the seat. A grab bar behind the seat would prevent the user from leaning back against the wall, while one located on the wall opposite the seat cannot be reached from the seated position. The seat itself may be used in conjunction with the bar for transfer. If design flexibility is required, fold away grab bars can be used as an alternative.

**A-3.8.3.18. Assistive Listening Systems.** Wireless sound transmission systems, including FM, infrared or magnetic induction loop systems, improve sound reception for persons with hearing disabilities by providing amplification which can be adjusted by each user while blocking out unwanted background noise. These systems transmit a signal that is picked up by a special receiver available for use by a person with a hearing disability, whether or not a hearing aid is used. Neither system interferes with the listening enjoyment of others.

The transmitter can be jacked into an existing P.A. system amplifier or used independently with microphones. The induction loop system requires users to sit in the area circumscribed by the loop; though installation of the loop is relatively simple, the installer should be knowledgeable about these systems if proper functioning is to be achieved. FM or infrared systems can be designed to broadcast signals which cover the entire room and thus do not restrict seating to any one area. Figures A-3.8.3.18.-A and A-3.8.3.18.-B show the general configuration of FM and infrared systems. Although portable systems (FM in particular) are available, these are best suited to small audiences. Generally, the systems installed in church halls, auditoria, theatres and similar places of assembly are not easily portable, as they are installed in a fixed location by a sound technician and form an integral part of the P.A. system of the room or building.

Hard-wired systems (where a jack is provided at a particular seat) will not meet this requirement unless adequate provisions are made to accommodate persons with hearing aids. In choosing the most appropriate system, a number of factors must be taken into account including cost, installation and maintenance, suitability to the audience, ease of operation and the need for privacy. Information on designers and suppliers of these systems may be obtained from the Canadian Hearing Society.

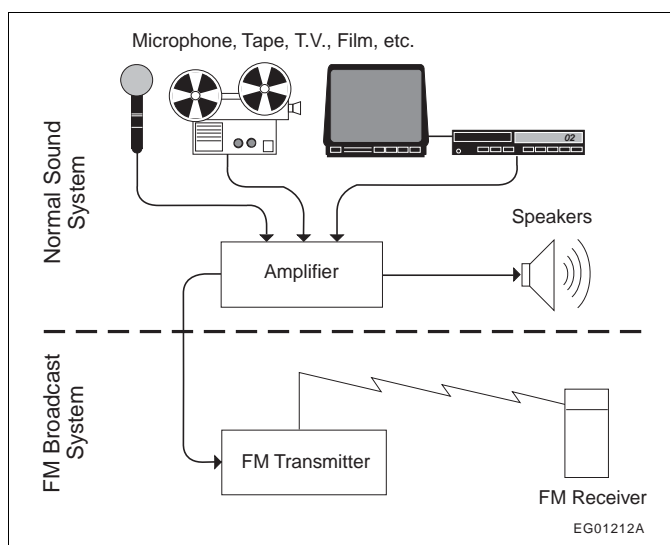


Figure A-3.8.3.18.-A  
FM sound transmission system

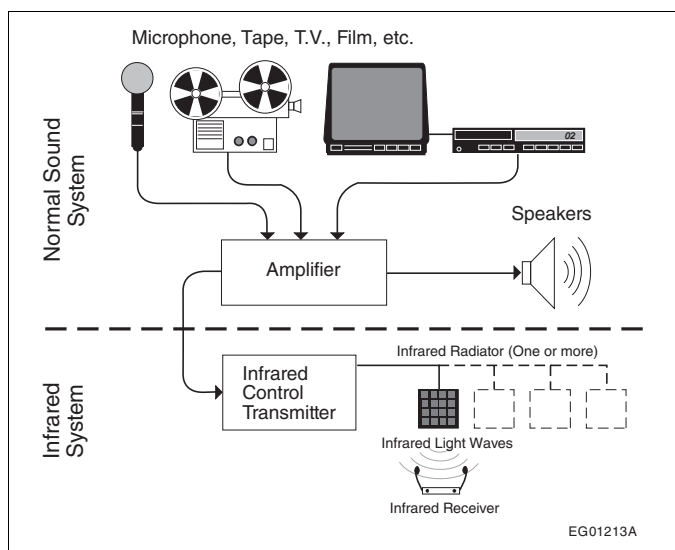
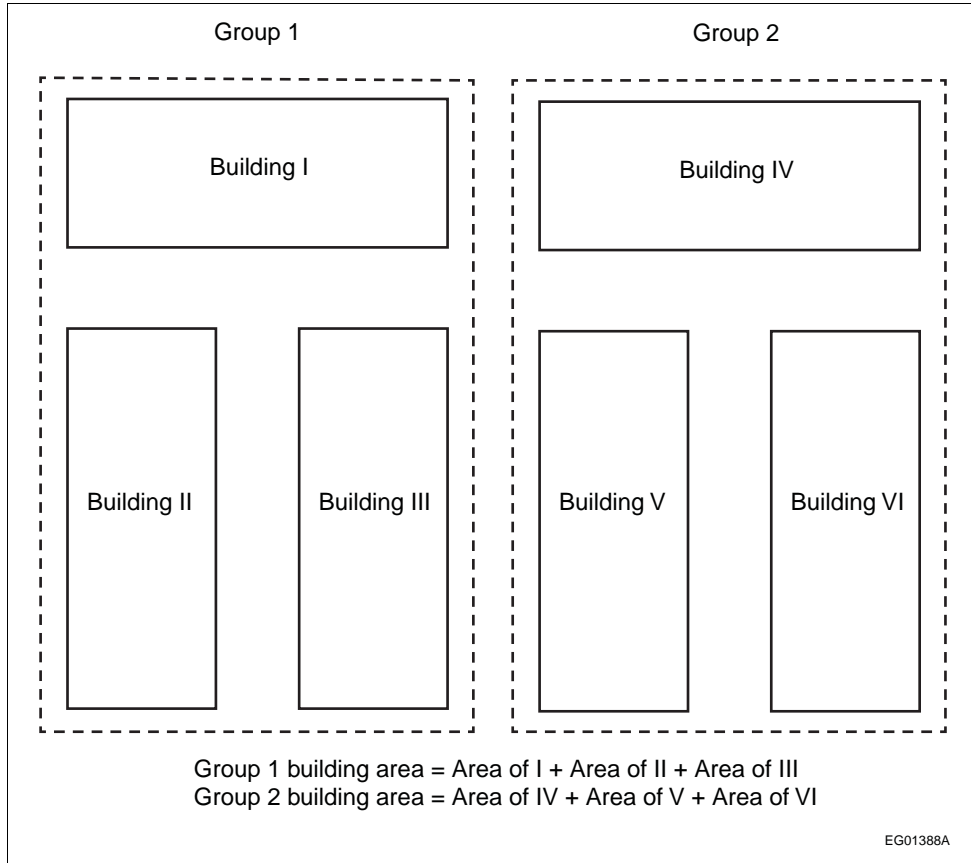


Figure A-3.8.3.18.-B  
Infrared sound transmission system

**A-3.8.3.20. Telephone Shelves or Counters.** Built-in shelves or counters for public telephones must be designed to accommodate persons using text telephones (TT). These devices may also be referred to as teletypewriters (TTY) or telecommunication devices for the deaf (TDD). These devices require a level surface at least 305 mm deep by 250 mm wide with no obstruction above that space within 250 mm. If a wall-hung telephone or other obstruction extends to less than 250 mm from the shelf or counter, an equivalent clear space must be provided on either side of each telephone. At least one telephone should be equipped with a volume control on a receiver that generates a magnetic field compatible with the T-switch of a hearing aid. The lower portion of the shelf or counter is intended for persons using a wheelchair; therefore all parts of the operating mechanism of the telephone above this portion should be within reach of a wheelchair user.

**A-3.9.2.1.(1) Building Area of Self-service Storage Buildings.** Sentence 3.9.2.1.(1) permits a group of self-service storage buildings to be treated as a single building for determining the construction requirements and number of streets that the group faces under Subsection 3.2.2. This can often result in more stringent construction criteria for the individual buildings than would be required if their construction requirements were determined based on each building's individual area.



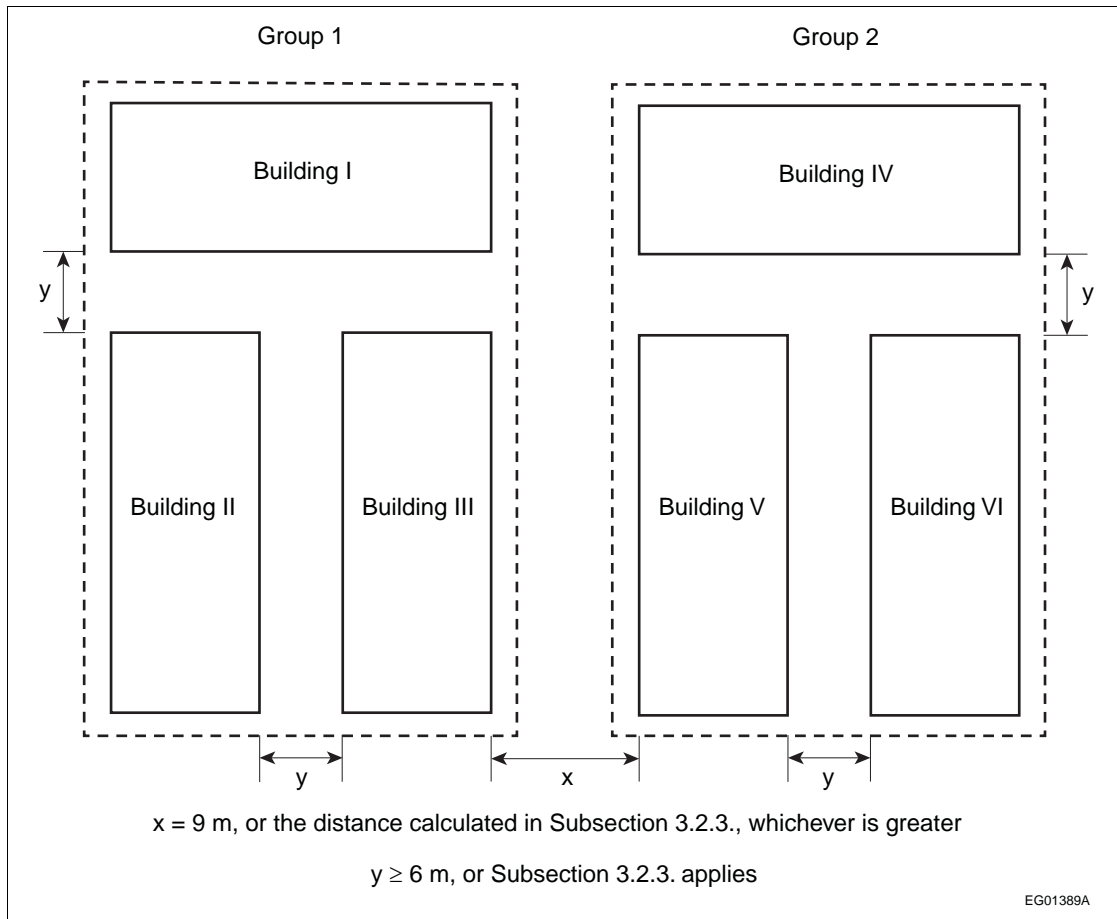
**Figure A-3.9.2.1.(1)**  
**Building area of self-service storage buildings**



**A-3.9.2.2. Spatial Separation Between Self-service Storage Buildings.** Where a group of self-service storage buildings is treated as a single building as permitted in Sentence 3.9.2.1.(1), buildings within the same group are exempted from the spatial separation requirements in Subsection 3.2.3. as long as a minimum distance of 6 m is provided between each of them. If the owner wants less distance between the buildings, the requirements of Subsection 3.2.3. must be applied.

In addition, where there are multiple groups of buildings on a single property, the minimum distance required to separate one group from another group is the greater of 9 m and the limiting distance calculated in Subsection 3.2.3.

Except as provided in Article 3.9.2.2., Subsection 3.2.3. applies to each building within a group.



**Figure A-3.9.2.2.**  
Spatial separation between self-service storage buildings

**A-3.9.3.1.(1) Storage of Flammable and Combustible Liquids.** Refer to Subsection 4.2.12. of Division B of the NBC for requirements regarding the storage of flammable and combustible liquids in individual self-service storage units.

**A-3.9.3.2.(1) Sanitary Facilities.** Properties with self-service storage buildings on them may have multiple buildings or one large building. Due to the low occupant load of these types of buildings, only one building on the property is required to have a pair of washrooms.



# Part 4

## Structural Design

<b>4.1.</b>	<b>Structural Loads and Procedures</b>	
4.1.1.	General .....	4-1
4.1.2.	Specified Loads and Effects .....	4-2
4.1.3.	Limit States Design .....	4-3
4.1.4.	Dead Loads .....	4-7
4.1.5.	Live Loads Due to Use and Occupancy .....	4-7
4.1.6.	Loads Due to Snow and Rain .....	4-13
4.1.7.	Wind Load .....	4-27
4.1.8.	Earthquake Load and Effects .....	4-43
<b>4.2.</b>	<b>Foundations</b>	
4.2.1.	General .....	4-72
4.2.2.	Subsurface Investigations, Drawings and Reviews .....	4-72
4.2.3.	Materials Used in Foundations .....	4-72
4.2.4.	Design Requirements .....	4-74
4.2.5.	Excavations .....	4-75
4.2.6.	Shallow Foundations .....	4-76
4.2.7.	Deep Foundations .....	4-77
4.2.8.	Special Foundations .....	4-78
<b>4.3.</b>	<b>Design Requirements for Structural Materials</b>	
4.3.1.	Wood .....	4-78
4.3.2.	Plain and Reinforced Masonry .....	4-78
4.3.3.	Plain, Reinforced and Pre-stressed Concrete .....	4-78
4.3.4.	Steel .....	4-79
4.3.5.	Aluminum .....	4-79
4.3.6.	Glass .....	4-79
<b>4.4.</b>	<b>Design Requirements for Special Structures</b>	
4.4.1.	Air-Supported Structures .....	4-79
4.4.2.	Parking Structures .....	4-79
<b>4.5.</b>	<b>Objectives and Functional Statements</b>	
4.5.1.	Objectives and Functional Statements .....	4-80
	<b>Notes to Part 4 .....</b>	<b>4-91</b>



# Part 4

## Structural Design

### Section 4.1. Structural Loads and Procedures

#### 4.1.1. General

##### 4.1.1.1. Scope

- 1) The scope of this Part shall be as described in Subsection 1.3.3. of Division A.

##### 4.1.1.2. Definitions

- 1) Words that appear in italics in this Part are defined in Article 1.4.1.2. of Division A.

##### 4.1.1.3. Design Requirements

- 1) *Buildings* and their structural members and connections, including formwork and falsework, shall be designed to have sufficient structural capacity and structural integrity to safely and effectively resist all loads, effects of loads and influences that may reasonably be expected, having regard to the expected service life of *buildings*, and shall in any case satisfy the requirements of this Section. (See Note A-4.1.1.3.(1).)

- 2) *Buildings* and their structural members shall be designed for serviceability, in accordance with Articles 4.1.3.4., 4.1.3.5. and 4.1.3.6. (See Note A-4.1.1.3.(2).)

- 3) All permanent and temporary structural members, including the formwork and falsework of a *building*, shall be protected against loads exceeding the specified loads during the construction period except when, as verified by analysis or test, temporary overloading of a structural member would result in no impairment of that member or any other member.

- 4) Falsework, scaffolding, and formwork shall be designed in conformance with
  - a) CSA S269.1, "Falsework for Construction Purposes,"
  - b) CAN/CSA-S269.2-M, "Access Scaffolding for Construction Purposes," or
  - c) CAN/CSA-S269.3-M, "Concrete Formwork."

- 5) Precautions shall be taken during all phases of construction to ensure that the *building* is not damaged or distorted due to loads applied during construction.

##### 4.1.1.4. Structural Drawings and Related Documents

- 1) Structural drawings and related documents shall conform to the appropriate requirements of Section 2.2. of Division C. (See Subsection 2.2.4. of Division C.)

##### 4.1.1.5. Design Basis

- 1) Except as provided in Sentence (2), *buildings* and their structural members shall be designed in conformance with the procedures and practices provided in this Part.

- 2) Provided the design is carried out by a person especially qualified in the specific methods applied and provided the design demonstrates a level of safety and performance in accordance with the requirements of Part 4, *buildings* and their

structural components falling within the scope of Part 4 that are not amenable to analysis using a generally established theory may be designed by

- a) evaluation of a full-scale structure or a prototype by a loading test, or
- b) studies of model analogues.

(See Note A-4.1.1.5.(2).)

## 4.1.2. Specified Loads and Effects

### 4.1.2.1. Loads and Effects

(See Note A-4.1.2.1.)

**1)** Except as provided in Article 4.1.2.2., the following categories of loads, specified loads and effects shall be taken into consideration in the design of a *building* and its structural members and connections:

- D ..... *dead load* – a permanent load due to the weight of *building* components, as specified in Subsection 4.1.4.,
- E ..... earthquake load and effects – a rare load due to an earthquake, as specified in Subsection 4.1.8.,
- H ..... a permanent load due to lateral earth pressure, including *groundwater*,
- L ..... *live load* – a variable load due to intended use and *occupancy* (including loads due to cranes and the pressure of liquids in containers), as specified in Subsection 4.1.5.,
- L<sub>XC</sub> ..... *live load* exclusive of crane loads,
- C ..... *live load* due to cranes including self weight,
- C<sub>d</sub> ..... self weight of all cranes positioned for maximum effects,
- C<sub>7</sub> ..... crane bumper impact load,
- P ..... permanent effects caused by pre-stress,
- S ..... variable load due to snow, including ice and associated rain, as specified in Article 4.1.6.2., or due to rain, as specified in Article 4.1.6.4.,
- T ..... effects due to contraction, expansion, or deflection caused by temperature changes, shrinkage, moisture changes, creep, ground settlement, or a combination thereof (see Note A-4.1.2.1.(1)), and
- W ..... wind load – a variable load due to wind, as specified in Subsection 4.1.7.,

where

- a) load means the imposed deformations (i.e. deflections, displacements or motions that induce deformations and forces in the structure), forces and pressures applied to the *building* structure,
- b) permanent load is a load that changes very little once it has been applied to the structure, except during repair,
- c) variable load is a load that frequently changes in magnitude, direction or location, and
- d) rare load is a load that occurs infrequently and for a short time only.

**2)** Minimum specified values of the loads described in Sentence (1), as set forth in Subsections 4.1.4. to 4.1.8., shall be increased to account for dynamic effects where applicable.

**3)** For the purpose of determining specified loads S, W or E in Subsections 4.1.6., 4.1.7. and 4.1.8., *buildings* shall be assigned an Importance Category based on intended use and *occupancy*, in accordance with Table 4.1.2.1. (See Note A-4.1.2.1.(3).)

**Table 4.1.2.1.**  
**Importance Categories for Buildings**  
 Forming Part of Sentence 4.1.2.1.(3)

Use and <i>Occupancy</i>	Importance Category
<p><i>Buildings</i> that represent a low direct or indirect hazard to human life in the event of failure, including:</p> <ul style="list-style-type: none"> <li>• low human-<i>occupancy buildings</i>, where it can be shown that collapse is not likely to cause injury or other serious consequences</li> <li>• minor storage <i>buildings</i></li> </ul>	Low <sup>(1)</sup>
All <i>buildings</i> except those listed in Importance Categories Low, High and Post-disaster	Normal
<p><i>Buildings</i> that are likely to be used as post-disaster shelters, including <i>buildings</i> whose primary use is:</p> <ul style="list-style-type: none"> <li>• as an elementary, middle or secondary school</li> <li>• as a community centre</li> </ul> <p>Manufacturing and storage facilities containing toxic, explosive or other hazardous substances in sufficient quantities to be dangerous to the public if released<sup>(1)</sup></p>	High
<p><i>Post-disaster buildings</i> are <i>buildings</i> that are essential to the provision of services in the event of a disaster, and include:</p> <ul style="list-style-type: none"> <li>• hospitals, emergency treatment facilities and blood banks</li> <li>• telephone exchanges</li> <li>• power generating stations and electrical substations</li> <li>• control centres for air, land and marine transportation</li> <li>• public water treatment and storage facilities, and pumping stations</li> <li>• sewage treatment facilities and <i>buildings</i> having critical national defence functions</li> <li>• <i>buildings</i> of the following types, unless exempted from this designation by the <i>authority having jurisdiction</i>:<sup>(2)</sup> <ul style="list-style-type: none"> <li>• emergency response facilities</li> <li>• fire, rescue and police stations, and housing for vehicles, aircraft or boats used for such purposes</li> <li>• communications facilities, including radio and television stations</li> </ul> </li> </ul>	Post-disaster

**Notes to Table 4.1.2.1.:**

(1) See Note A-Table 4.1.2.1.

(2) See Note A-1.4.1.2.(1), Post-disaster Buildings, in Division A.

**4.1.2.2. Loads Not Listed**

**1)** Where a *building* or structural member can be expected to be subjected to loads, forces or other effects not listed in Article 4.1.2.1., such effects shall be taken into account in the design based on the most appropriate information available.

**4.1.3. Limit States Design**

(See Note A-4.1.3.)

**4.1.3.1. Definitions**

- 1)** In this Subsection, the term
- a) limit states means those conditions of a *building* structure that result in the *building* ceasing to fulfill the function for which it was designed (those limit states concerning safety are called ultimate limit states (ULS) and include exceeding the load-carrying capacity, overturning, sliding and fracture; those limit states that restrict the intended use and *occupancy* of the *building* are called serviceability limit states (SLS) and include deflection, vibration, permanent deformation and local structural damage such as cracking; and those limit states that represent failure under repeated loading are called fatigue limit states),
  - b) specified loads (**C, D, E, H, L, P, S, T** and **W**) means those loads defined in Article 4.1.2.1.,
  - c) principal load means the specified variable load or rare load that dominates in a given load combination,
  - d) companion load means a specified variable load that accompanies the principal load in a given load combination,

- e) service load means a specified load used for the evaluation of a serviceability limit state,
- f) principal-load factor means a factor applied to the principal load in a load combination to account for the variability of the load and load pattern and the analysis of its effects,
- g) companion-load factor means a factor that, when applied to a companion load in the load combination, gives the probable magnitude of a companion load acting simultaneously with the factored principal load,
- h) importance factor,  $I$ , means a factor applied in Subsections 4.1.6., 4.1.7. and 4.1.8. to obtain the specified load and take into account the consequences of failure as related to the limit state and the use and *occupancy* of the *building*,
- i) factored load means the product of a specified load and its principal-load factor or companion-load factor,
- j) effects refers to forces, moments, deformations or vibrations that occur in the structure,
- k) nominal resistance,  $R$ , of a member, connection or structure, is based on the geometry and on the specified properties of the structural materials,
- l) resistance factor,  $\phi$ , means a factor applied to a specified material property or to the resistance of a member, connection or structure, and that, for the limit state under consideration, takes into account the variability of dimensions and material properties, workmanship, type of failure and uncertainty in the prediction of resistance, and
- m) factored resistance,  $\phi R$ , means the product of nominal resistance and the applicable resistance factor.

#### 4.1.3.2. Strength and Stability

**1)** A *building* and its structural components shall be designed to have sufficient strength and stability so that the factored resistance,  $\phi R$ , is greater than or equal to the effect of factored loads, which shall be determined in accordance with Sentence 4.1.3.2.(2).

**2)** Except as provided in Sentence (3), the effect of factored loads for a *building* or structural component shall be determined in accordance with the requirements of this Article and the following load combination cases, the applicable combination being that which results in the most critical effect:

- a) for load cases without crane loads, the load combinations listed in Table 4.1.3.2.-A, and
- b) for load cases with crane loads, the load combinations listed in Table 4.1.3.2.-B.

(See Note A-4.1.3.2.(2).)

**3)** Other load combinations that must also be considered are the principal loads acting with the companion loads taken as zero.

**4)** Where the effects due to lateral earth pressure,  $H$ , restraint effects from pre-stress,  $P$ , and imposed deformation,  $T$ , affect the structural safety, they shall be taken into account in the calculations, with load factors of 1.5, 1.0 and 1.25 assigned to  $H$ ,  $P$  and  $T$  respectively. (See Note A-4.1.3.2.(4).)

**5)** Except as provided in Sentence 4.1.8.16.(2), the counteracting factored *dead load*— $0.9D$  in load combination cases 2, 3 and 4 and  $1.0D$  in load combination case 5 in Table 4.1.3.2.-A, and  $0.9D$  in load combination cases 1 to 5 and  $1.0D$  in load combination case 6 in Table 4.1.3.2.-B—shall be used when the *dead load* acts to resist overturning, uplift, sliding, failure due to stress reversal, and to determine anchorage requirements and the factored resistance of members. (See Note A-4.1.3.2.(5).)

**6)** The principal-load factor 1.5 for *live loads*  $L$  in Table 4.1.3.2.-A and  $L_{XC}$  in Table 4.1.3.2.-B may be reduced to 1.25 for liquids in tanks.

**7)** The companion-load factor for *live loads*  $L$  in Table 4.1.3.2.-A and  $L_{XC}$  in Table 4.1.3.2.-B shall be increased by 0.5 for storage areas, and equipment areas and *service rooms* referred to in Table 4.1.5.3.



**Table 4.1.3.2.-A**  
**Load Combinations Without Crane Loads for Ultimate Limit States**  
 Forming Part of Sentences 4.1.3.2.(2) and (5) to (10)

Case	Load Combination <sup>(1)</sup>	
	Principal Loads	Companion Loads
1	1.4D <sup>(2)</sup>	—
2	(1.25D <sup>(3)</sup> or 0.9D <sup>(4)</sup> ) + 1.5L <sup>(5)</sup>	1.0S <sup>(6)</sup> or 0.4W
3	(1.25D <sup>(3)</sup> or 0.9D <sup>(4)</sup> ) + 1.5S	1.0L <sup>(6)(7)</sup> or 0.4W
4	(1.25D <sup>(3)</sup> or 0.9D <sup>(4)</sup> ) + 1.4W	0.5L <sup>(7)</sup> or 0.5S
5	1.0D <sup>(4)</sup> + 1.0E <sup>(8)</sup>	0.5L <sup>(6)(7)</sup> + 0.25S <sup>(6)</sup>

**Notes to Table 4.1.3.2.-A:**

- (1) See Sentences 4.1.3.2.(2), (3) and (4).
- (2) See Sentence 4.1.3.2.(9).
- (3) See Sentence 4.1.3.2.(8).
- (4) See Sentence 4.1.3.2.(5).
- (5) See Sentence 4.1.3.2.(6).
- (6) See Article 4.1.5.5.
- (7) See Sentence 4.1.3.2.(7).
- (8) See Sentence 4.1.3.2.(10).

**Table 4.1.3.2.-B**  
**Load Combinations With Crane Loads for Ultimate Limit States**  
 Forming Part of Sentences 4.1.3.2.(2), (5) to (8), and (10)

Case	Load Combination <sup>(1)</sup>	
	Principal Loads	Companion Loads
1	(1.25D <sup>(2)</sup> or 0.9D <sup>(3)</sup> ) + (1.5C + 1.0L <sub>XC</sub> )	1.0S <sup>(4)</sup> or 0.4W
2	(1.25D <sup>(2)</sup> or 0.9D <sup>(3)</sup> ) + (1.5L <sub>XC</sub> <sup>(5)</sup> + 1.0C)	1.0S <sup>(4)</sup> or 0.4W
3	(1.25D <sup>(2)</sup> or 0.9D <sup>(3)</sup> ) + 1.5S	1.0C + 1.0L <sub>XC</sub> <sup>(4)(6)</sup>
4	(1.25D <sup>(2)</sup> or 0.9D <sup>(3)</sup> ) + 1.4W	(1.0C <sup>(7)</sup> + 0.5L <sub>XC</sub> <sup>(4)(6)</sup> )
5	(1.25D <sup>(2)</sup> or 0.9D <sup>(3)</sup> ) + C <sub>7</sub>	—
6	1.0D <sup>(3)</sup> + 1.0E <sup>(8)</sup>	1.0C <sub>d</sub> + 0.5L <sub>XC</sub> <sup>(4)(6)</sup> + 0.25S <sup>(4)</sup>

**Notes to Table 4.1.3.2.-B:**

- (1) See Sentences 4.1.3.2.(2), (3) and (4).
- (2) See Sentence 4.1.3.2.(8).
- (3) See Sentence 4.1.3.2.(5).
- (4) See Article 4.1.5.5.
- (5) See Sentence 4.1.3.2.(6).
- (6) See Sentence 4.1.3.2.(7).
- (7) Side thrust due to cranes need not be combined with full wind load.
- (8) See Sentence 4.1.3.2.(10).

**8)** Except as provided in Sentence (9), the load factor 1.25 for *dead load, D*, for *soil*, superimposed earth, plants and trees given in Tables 4.1.3.2.-A and 4.1.3.2.-B shall be increased to 1.5, except that when the *soil* depth exceeds 1.2 m, the factor may be reduced to  $1 + 0.6/h_s$  but not less than 1.25, where  $h_s$  is the depth of *soil* in metres supported by the structure.

**9)** A principal-load factor of 1.5 shall be applied to the weight of saturated *soil* used in load combination case 1 of Table 4.1.3.2.-A.

**10)** Earthquake load, *E*, in load combination cases 5 of Table 4.1.3.2.-A and 6 of Table 4.1.3.2.-B includes horizontal earth pressure due to earthquake determined in accordance with Sentence 4.1.8.16.(7).

**11)** Provision shall be made to ensure adequate stability of the structure as a whole and adequate lateral, torsional and local stability of all structural parts.

**12)** Sway effects produced by vertical loads acting on the structure in its displaced configuration shall be taken into account in the design of *buildings* and their structural members.

#### 4.1.3.3. Fatigue

**1)** A *building* and its structural components, including connections, shall be checked for fatigue failure under the effect of cyclical loads, as required in the standards listed in Section 4.3. (See Note A-4.1.3.3.(1).)

**2)** Where vibration effects, such as resonance and fatigue resulting from machinery and equipment, are likely to be significant, a dynamic analysis shall be carried out. (See Note A-4.1.3.3.(2).)

#### 4.1.3.4. Serviceability

**1)** A *building* and its structural components shall be checked for serviceability limit states as defined in Clause 4.1.3.1.(1)(a) under the effect of service loads for serviceability criteria specified or recommended in Articles 4.1.3.5. and 4.1.3.6. and in the standards listed in Section 4.3. (See Note A-4.1.3.4.(1).)

#### 4.1.3.5. Deflection

**1)** In proportioning structural members to limit serviceability problems resulting from deflections, consideration shall be given to

- a) the intended use of the *building* or member,
- b) limiting damage to non-structural members made of materials whose physical properties are known at the time of design,
- c) limiting damage to the structure itself, and
- d) creep, shrinkage, temperature changes and pre-stress.

(See Note A-4.1.3.5.(1).)

**2)** The lateral deflection of *buildings* due to service wind and gravity loads shall be checked to ensure that structural elements and non-structural elements whose nature is known at the time the structural design is carried out will not be damaged.

**3)** Except as provided in Sentence (4), the total drift per *storey* under service wind and gravity loads shall not exceed 1/500 of the *storey* height unless other drift limits are specified in the design standards referenced in Section 4.3. (See Note A-4.1.3.5.(3).)

**4)** The deflection limits required in Sentence (3) do not apply to industrial *buildings* or sheds if experience has proven that greater movement will have no significant adverse effects on the strength and function of the *building*.

**5)** The *building* structure shall be designed for lateral deflection due to E, in accordance with Article 4.1.8.13.

#### 4.1.3.6. Vibration

**1)** Floor systems susceptible to vibration shall be designed so that vibrations will have no significant adverse effects on the intended *occupancy* of the *building*. (See Note A-4.1.3.6.(1).)

**2)** Where the fundamental vibration frequency of a structural system supporting an *assembly occupancy* used for rhythmic activities, such as dancing, concerts, jumping exercises or gymnastics, is less than 6 Hz, the effects of resonance shall be investigated by means of a dynamic analysis. (See Note A-4.1.3.6.(2).)

**3)** A *building* susceptible to lateral vibration under wind load shall be designed in accordance with Article 4.1.7.1. so that the vibrations will have no significant adverse effects on the intended use and *occupancy* of the *building*. (See Note A-4.1.3.6.(3).)

**4.1.4. Dead Loads**

**4.1.4.1. Dead Loads**

- 1)** The specified *dead load* for a structural member consists of
  - a) the weight of the member itself,
  - b) the weight of all materials of construction incorporated into the *building* to be supported permanently by the member,
  - c) the weight of *partitions*,
  - d) the weight of permanent equipment, and
  - e) the vertical load due to earth, plants and trees.
  
- 2)** Except as provided in Sentence (5), in areas of a *building* where *partitions*, other than permanent *partitions*, are shown on the drawings, or where *partitions* might be added in the future, allowance shall be made for the weight of such *partitions*.
  
- 3)** The *partition* weight allowance referred to in Sentence (2) shall be determined from the actual or anticipated weight of the *partitions* placed in any probable position, but shall be not less than 1 kPa over the area of floor being considered.
  
- 4)** *Partition* loads used in design shall be shown on the drawings as provided in Clause 2.2.4.3.(1)(d) of Division C.
  
- 5)** In cases where the *dead load* of the *partition* is counteractive, the load allowances referred to in Sentences (2) and (3) shall not be included in the design calculations.
  
- 6)** Except for structures where the *dead load* of *soil* is part of the load-resisting system, where the *dead load* due to *soil*, superimposed earth, plants and trees is counteractive, it shall not be included in the design calculations. (See Note A-4.1.4.1.(6).)

**4.1.5. Live Loads Due to Use and Occupancy**

**4.1.5.1. Loads Due to Use of Floors and Roofs**

- 1)** Except as provided in Sentence (2), the specified *live load* on an area of floor or roof depends on the intended use and *occupancy*, and shall not be less than either the uniformly distributed load patterns listed in Article 4.1.5.3., the loads due to the intended use and *occupancy*, or the concentrated loads listed in Article 4.1.5.9., whichever produces the most critical effect. (See Note A-4.1.5.1.(1).)
  
- 2)** For *buildings* in the Low Importance Category as described in Table 4.1.2.1., a factor of 0.8 may be applied to the *live load*.

**4.1.5.2. Uses Not Stipulated**

- 1)** Except as provided in Sentence (2), where the use of an area of floor or roof is not provided for in Article 4.1.5.3., the specified *live loads* due to the use and *occupancy* of the area shall be determined from an analysis of the loads resulting from the weight of
  - a) the probable assembly of persons,
  - b) the probable accumulation of equipment and furnishings, and
  - c) the probable storage of materials.
  
- 2)** For *buildings* in the Low Importance Category as described in Table 4.1.2.1., a factor of 0.8 may be applied to the *live load*.

**4.1.5.3. Full and Partial Loading**

- 1)** The uniformly distributed *live load* shall be not less than the value listed in Table 4.1.5.3., which may be reduced as provided in Article 4.1.5.8., applied uniformly over the entire area or on any portions of the area, whichever produces the most critical effects in the members concerned.

**Table 4.1.5.3.**  
**Specified Uniformly Distributed Live Loads on an Area of Floor or Roof**  
 Forming Part of Sentence 4.1.5.3.(1)

Use of Area of Floor or Roof	Minimum Specified Load, kPa
<b>Assembly Areas</b> a) Except for the areas listed under b), c), d) and e), assembly areas with or without fixed seats including Arenas <sup>(1)</sup> (areas without fixed seats that have backs) Auditoria Churches (areas without fixed seats that have backs) Dance floors Dining areas <sup>(2)</sup> Foyers and entrance halls Grandstands <sup>(1)</sup> (areas without fixed seats that have backs), reviewing stands and bleachers Gymnasia Lecture halls <sup>(1)</sup> (areas without fixed seats that have backs) Museums Promenades Rinks Stadia <sup>(1)</sup> (areas without fixed seats that have backs) Theatres (areas without fixed seats that have backs) Other areas with similar uses	4.8
b) Classrooms and courtrooms with or without fixed seats <sup>(1)</sup>	2.4
c) Portions of assembly areas with fixed seats that have backs for the following uses: Arenas Grandstands Stadia	2.9 <sup>(1)</sup>
d) Portions of assembly areas with fixed seats that have backs for the following uses: Churches Lecture halls <sup>(1)</sup> Theatres	2.4
e) Vomitories, exits, lobbies and corridors <sup>(1)</sup>	4.8
<b>Attics<sup>(1)</sup></b> Accessible by a stairway in <i>residential occupancies</i> only Having limited accessibility so that there is no storage of equipment or material	1.4 0.5
<b>Balconies</b> Exterior Interior and <i>mezzanines</i> that could be used by an assembly of people as a viewing area <sup>(1)</sup> Interior and <i>mezzanines</i> other than above	4.8 4.8 (3)
<b>Corridors, lobbies and aisles<sup>(1)</sup></b> Other than those listed below Not more than 1 200 mm in width and all upper floor corridors of residential areas only of apartments, hotels and motels (that cannot be used by an assembly of people as a viewing area) <sup>(1)</sup>	4.8 (1)(3)
<b>Equipment areas and service rooms including</b> Generator rooms Mechanical equipment exclusive of elevators Machine rooms Pump rooms Transformer vaults Ventilating or air-conditioning equipment	3.6 <sup>(4)</sup>

**Table 4.1.5.3. (Continued)**

Use of Area of Floor or Roof	Minimum Specified Load, kPa
<i>Exits</i> and fire escapes	4.8
Factories	6.0 <sup>(4)</sup>
Footbridges	4.8
Garages for	
Vehicles not exceeding 4 000 kg gross weight	2.4
Vehicles exceeding 4 000 kg but not exceeding 9 000 kg gross weight	6.0
Vehicles exceeding 9 000 kg gross weight	12.0 <sup>(1)</sup>
Kitchens (other than residential)	4.8
Libraries	
Stack rooms	7.2
Reading and study rooms	2.9
Office areas (not including record storage and computer rooms) located in	
<i>Basement</i> and the <i>first storey</i>	4.8
Floors above the <i>first storey</i>	2.4
Operating rooms and laboratories	3.6
Patients' bedrooms	1.9
Recreation areas that cannot be used for assembly purposes including	
Billiard rooms	
Bowling alleys	
Pool rooms	3.6
Residential areas (within the scope of Article 1.3.3.2. of Division A)	
Sleeping and living quarters in apartments, hotels, motels, boarding schools and colleges	1.9
Residential areas (within the scope of Article 1.3.3.3. of Division A)	
Bedrooms	1.9
Other areas	1.9
Stairs within <i>dwelling units</i>	1.9
Retail and wholesale areas	4.8
Roofs	1.0 <sup>(1)</sup> <sup>(5)</sup>
Sidewalks and driveways over areaways and <i>basements</i>	12.0 <sup>(1)</sup> <sup>(5)</sup>
Storage areas	4.8 <sup>(4)</sup>
Toilet areas	2.4
Underground slabs with earth cover	<sup>(5)</sup>
Warehouses	4.8 <sup>(4)</sup>

**Notes to Table 4.1.5.3.:**

- (1) See Note A-Table 4.1.5.3.
- (2) See Article 4.1.5.6.
- (3) See Article 4.1.5.4.
- (4) See Sentence 4.1.5.1.(1).
- (5) See Article 4.1.5.5.

**4.1.5.4. Loads for Occupancy Served**

**1)** The following shall be designed to carry not less than the specified load required for the *occupancy* they serve, provided they cannot be used by an assembly of people as a viewing area:

- a) corridors, lobbies and aisles not more than 1 200 mm wide,
- b) all corridors above the *first storey* of residential areas of apartments, hotels and motels, and
- c) interior balconies and *mezzanines*.

**4.1.5.5. Loads on Exterior Areas**

(See Note A-4.1.5.5.)

**1)** Exterior areas accessible to vehicular traffic shall be designed for their intended use, including the weight of firefighting equipment, but not for less than the snow and rain loads prescribed in Subsection 4.1.6.

**2)** Except as provided in Sentences (3) and (4), roofs shall be designed for either the uniform *live loads* specified in Table 4.1.5.3., the concentrated *live loads* listed in Table 4.1.5.9., or the snow and rain loads prescribed in Subsection 4.1.6., whichever produces the most critical effects in the members concerned.

**3)** Exterior areas accessible to pedestrian traffic, but not vehicular traffic, shall be designed for their intended use, but not for less than the greater of

- a) the *live load* prescribed for assembly areas in Table 4.1.5.3., or
- b) the snow and rain loads prescribed in Subsection 4.1.6.

**4)** Roof parking decks shall be designed for either the uniformly distributed *live loads* specified in Table 4.1.5.3., the concentrated *live loads* listed in Table 4.1.5.9., or the roof snow load, whichever produces the most critical effect in the members concerned.

**4.1.5.6. Loads for Dining Areas**

**1)** The minimum specified *live load* listed in Table 4.1.5.3. for dining areas may be reduced to 2.4 kPa for areas in *buildings* that are being converted to dining areas, provided that the *floor area* does not exceed 100 m<sup>2</sup> and the dining area will not be used for other assembly purposes, including dancing.

**4.1.5.7. More Than One Occupancy**

**1)** Where an area of floor or roof is intended for 2 or more *occupancies* at different times, the value to be used from Table 4.1.5.3. shall be the greatest value for any of the *occupancies* concerned.

**4.1.5.8. Variation with Tributary Area**

(See Note A-4.1.5.8.)

**1)** An area used for *assembly occupancies* designed for a *live load* of less than 4.8 kPa and roofs designed for the minimum loading specified in Table 4.1.5.3. shall have no reduction for tributary area.

**2)** Where a structural member supports a tributary area of a floor or a roof, or a combination thereof, that is greater than 80 m<sup>2</sup> and either used for *assembly occupancies* designed for a *live load* of 4.8 kPa or more, or used for storage, manufacturing, retail stores, garages or as a footbridge, the specified *live load* due to use and *occupancy* is the load specified in Article 4.1.5.3. multiplied by

$$0.5 + \sqrt{20/A}$$

where A is the tributary area in square metres for this type of use and *occupancy*.

**3)** Where a structural member supports a tributary area of a floor or a roof, or a combination thereof, that is greater than 20 m<sup>2</sup> and used for any use or *occupancy* other than those indicated in Sentences (1) and (2), the specified *live load* due to use and *occupancy* is the load specified in Article 4.1.5.3. multiplied by

$$0.3 + \sqrt{9.8/B}$$

where B is the tributary area in square metres for this type of use and *occupancy*.

**4)** Where the specified *live load* for a floor is reduced in accordance with Sentence (2) or (3), the structural drawings shall indicate that a *live load* reduction factor for tributary area has been applied.

**4.1.5.9. Concentrated Loads**

1) The specified *live load* due to possible concentrations of load resulting from the use of an area of floor or roof shall not be less than that listed in Table 4.1.5.9. applied over the loaded area noted and located so as to cause maximum effects, except that for *occupancies* not listed in Table 4.1.5.9., the concentrations of load shall be determined in accordance with Article 4.1.5.2.

**Table 4.1.5.9.**  
**Specified Concentrated Live Loads on an Area of Floor or Roof**  
 Forming Part of Sentence 4.1.5.9.(1)

Area of Floor or Roof	Minimum Specified Concentrated Load, kN	Loaded Area, mm x mm
Roof surfaces	1.3	200 x 200
Floors of classrooms	4.5	750 x 750
Floors of offices, manufacturing <i>buildings</i> , hospital wards and <i>stages</i>	9.0	750 x 750
Floors and areas used by vehicles not exceeding 4 000 kg gross weight	18	120 x 120
Floors and areas used by vehicles exceeding 4 000 kg but not exceeding 9 000 kg gross weight	36	120 x 120
Floors and areas used by vehicles exceeding 9 000 kg gross weight	54 <sup>(1)</sup>	250 x 600 <sup>(1)</sup>
Driveways and sidewalks over areaways and <i>basements</i>	54 <sup>(1)</sup>	250 x 600 <sup>(1)</sup>

**Notes to Table 4.1.5.9.:**

(1) See Note A-Table 4.1.5.9.

**4.1.5.10. Sway Forces in Assembly Occupancies**

1) The floor assembly and other structural elements that support fixed seats in any *building* used for *assembly occupancies* accommodating large numbers of people at one time, such as grandstands, stadia and *theatre* balconies, shall be designed to resist a horizontal force equal to not less than 0.3 kN for each metre length of seats acting parallel to each row of seats, and not less than 0.15 kN for each metre length of seats acting at right angles to each row of seats, based on the assumption that these forces are acting independently of each other.

**4.1.5.11. Crane-Supporting Structures and Impact of Machinery and Equipment**

(See Note A-4.1.5.11.)

1) The minimum specified load due to equipment, machinery or other objects that may produce impact shall be the sum of the weight of the equipment or machinery and its maximum lifting capacity, multiplied by an appropriate factor listed in Table 4.1.5.11.

2) Crane-supporting structures shall be designed for the appropriate load combinations listed in Article 4.1.3.2.

3) Crane runway structures shall be designed to resist a horizontal force applied normal to the top of the rails equal to not less than 20% of the sum of the weights of the lifted load and the crane trolley (excluding other parts of the crane).

4) The force described in Sentence (3) shall be equally distributed on each side of the runway and shall be assumed to act in either direction.

5) Crane runway structures shall be designed to resist a horizontal force applied parallel to the top of the rails equal to not less than 10% of the maximum wheel loads of the crane.

**Table 4.1.5.11.**  
**Factors for the Calculation of Impact Loads**  
 Forming Part of Sentence 4.1.5.11.(1)

Cause of Impact	Factor
Operation of cab or radio-operated cranes	1.25
Operation of pendant or hand-operated cranes	1.10
Operation of elevators	(1)
Supports for light machinery, shaft or motor-driven	1.20
Supports for reciprocating machinery (e.g. compressors)	1.50
Supports for power-driven units (e.g. piston engines)	1.50

**Notes to Table 4.1.5.11.:**

(1) See ASME A17.1/CSA B44, "Safety Code for Elevators and Escalators."

**4.1.5.12. Bleachers**

**1)** Bleacher seats shall be designed for a uniformly distributed *live load* of 1.75 kN for each linear metre or for a concentrated load of 2.2 kN distributed over a length of 0.75 m, whichever produces the most critical effect on the supporting members.

**2)** Bleachers shall be checked by the erector after erection to ensure that all structural members, including bracing specified in the design, have been installed.

**3)** Telescopic bleachers shall be provided with locking devices to ensure stability while in use.

**4.1.5.13. Helicopter Landing Areas**

**1)** Helicopter landing areas on roofs shall be constructed in conformance with the requirements for heliports contained in TC SOR/96-433, "Canadian Aviation Regulations – Part III."

**4.1.5.14. Loads on Guards and Handrails**

(See Note A-4.1.5.14. and 4.1.5.15.(1).)

**1)** The minimum specified horizontal load applied outward at the minimum required height of every required *guard* shall be

- a) 3.0 kN/m for open viewing stands without fixed seats and for *means of egress* in grandstands, stadia, bleachers and arenas,
- b) a concentrated load of 1.0 kN applied at any point, so as to produce the most critical effect, for access ways to equipment platforms, contiguous stairs and similar areas where the gathering of many people is improbable, and
- c) 0.75 kN/m or a concentrated load of 1.0 kN applied at any point so as to produce the most critical effect, whichever governs for locations other than those described in Clauses (a) and (b).

**2)** The minimum specified horizontal load applied inward at the minimum required height of every required *guard* shall be half that specified in Sentence (1).

**3)** Individual elements within the *guard*, including solid panels and pickets, shall be designed for a load of 0.5 kN applied outward over an area of 100 mm by 100 mm located at any point in the element or elements so as to produce the most critical effect.

**4)** The size of the opening between any two adjacent vertical elements within a *guard* shall not exceed the limits required by Part 3 when each of these elements is subjected to a specified *live load* of 0.1 kN applied in opposite directions in the in-plane direction of the *guard* so as to produce the most critical effect.

**5)** The loads required in Sentence (3) need not be considered to act simultaneously with the loads provided for in Sentences (1), (2) and (6).



**6)** The minimum specified load applied vertically at the top of every required *guard* shall be 1.5 kN/m and need not be considered to act simultaneously with the horizontal load provided for in Sentence (1).

**7)** Handrails and their supports shall be designed and constructed to withstand the following loads, which need not be considered to act simultaneously:

- a) a concentrated load not less than 0.9 kN applied at any point and in any direction for all handrails, and
- b) a uniform load not less than 0.7 kN/m applied in any direction to handrails not located within *dwelling units*.

#### 4.1.5.15. Loads on Vehicle Guardrails

**1)** Vehicle guardrails shall be designed for a concentrated load of 22 kN applied horizontally outward at any point 500 mm above the floor surface so as to produce the most critical effect. (See Note A-4.1.5.14. and 4.1.5.15.(1).)

**2)** The loads required in Sentence (1) need not be considered to act simultaneously with the loads provided for in Article 4.1.5.14.

#### 4.1.5.16. Loads on Walls Acting As Guards

**1)** Where the floor elevation on one side of a wall, including a wall around a shaft, is more than 600 mm higher than the elevation of the floor or ground on the other side, the wall shall be designed to resist the appropriate outward lateral design loads prescribed elsewhere in Subsection 4.1.5. or 0.5 kPa acting outward, whichever produces the more critical effect.

#### 4.1.5.17. Firewalls

(See Note A-4.1.5.17.)

- 1)** *Firewalls* shall be designed to resist the maximum effect due to
  - a) the appropriate lateral design loads prescribed elsewhere in this Section, or
  - b) a factored lateral load of 0.5 kPa under fire conditions, as described in Sentence (2).

**2)** Under fire conditions, where the *fire-resistance rating* of the structure is less than that of the *firewall*,

- a) lateral support shall be assumed to be provided by the structure on one side only, or
- b) another structural support system capable of resisting the loads imposed by a fire on either side of the *firewall* shall be provided.

### 4.1.6. Loads Due to Snow and Rain

#### 4.1.6.1. Specified Load Due to Rain or to Snow and Associated Rain

**1)** The specified load on a roof or any other *building* surface subject to snow and associated rain shall be the snow load specified in Article 4.1.6.2., or the rain load specified in Article 4.1.6.4., whichever produces the more critical effect.

#### 4.1.6.2. Specified Snow Load

(See Note A-4.1.6.2.)

**1)** The specified load, *S*, due to snow and associated rain accumulation on a roof or any other *building* surface subject to snow accumulation shall be calculated using the formula

$$S = I_s [S_s (C_b C_w C_s C_a) + S_r]$$

where

- $I_s$  = importance factor for snow load as provided in Table 4.1.6.2.-A,  
 $S_s$  = 1-in-50-year ground snow load, in kPa, determined in accordance with Subsection 1.1.3.,

- $C_b$  = basic roof snow load factor in Sentence (2),  
 $C_w$  = wind exposure factor in Sentences (3) and (4),  
 $C_s$  = slope factor in Sentences (5), (6) and (7),  
 $C_a$  = accumulation factor in Sentence (8), and  
 $S_r$  = 1-in-50-year associated rain load, in kPa, determined in accordance with Subsection 1.1.3., but not greater than  $S_s(C_b C_w C_s C_a)$ .

**Table 4.1.6.2.-A**  
**Importance Factor for Snow Load,  $I_s$**   
 Forming Part of Sentence 4.1.6.2.(1)

Importance Category	Importance Factor, $I_s$	
	ULS	SLS
Low	0.8	0.9
Normal	1	0.9
High	1.15	0.9
Post-disaster	1.25	0.9

- 2)** The basic roof snow load factor,  $C_b$ , shall  
 a) be determined as follows:  
 i)

$$C_b = 0.8 \text{ for } l_c \leq \left( \frac{70}{C_w^2} \right), \text{ and}$$

ii)

$$C_b = \frac{1}{C_w} \left[ 1 - (1 - 0.8C_w) \exp \left( -\frac{l_c C_w^2 - 70}{100} \right) \right] \text{ for } l_c > \left( \frac{70}{C_w^2} \right)$$

where

- $l_c$  = characteristic length of the upper or lower roof,  
 defined as  $2w - w^2/l$ , in m,  
 $w$  = smaller plan dimension of the roof, in m, and  
 $l$  = larger plan dimension of the roof, in m, or

- b) conform to Table 4.1.6.2.-B, using linear interpolation for intermediate values of  $l_c C_w^2$ .  
 (See Note A-4.1.6.2.(2).)

- 3)** Except as provided for in Sentence (4), the wind exposure factor,  $C_w$ , shall be 1.0.

- 4)** For *buildings* in the Low and Normal Importance Categories as set out in Table 4.1.2.1., the wind exposure factor,  $C_w$ , given in Sentence (3) may be reduced to 0.75 for rural areas only, or to 0.5 for exposed areas north of the treeline, where

- a) the *building* is exposed on all sides to wind over open terrain as defined in Clause 4.1.7.3.(5)(a), and is expected to remain so during its life,  
 b) the area of roof under consideration is exposed to the wind on all sides with no significant obstructions on the roof, such as parapet walls, within a distance of at least 10 times the difference between the height of the obstruction and  $C_b C_w S_s / \gamma$  metres, where  $\gamma$  is the specific weight of snow on roofs as specified in Article 4.1.6.13., and  
 c) the loading does not involve the accumulation of snow due to drifting from adjacent surfaces.

- 5)** Except as provided for in Sentences (6) and (7), the slope factor,  $C_s$ , shall be

- a) 1.0 where the roof slope,  $\alpha$ , is equal to or less than  $30^\circ$ ,  
 b)  $(70^\circ - \alpha)/40^\circ$  where  $\alpha$  is greater than  $30^\circ$  but not greater than  $70^\circ$ , and  
 c) 0 where  $\alpha$  exceeds  $70^\circ$ .

**Table 4.1.6.2-B**  
**Basic Roof Snow Load Factor for  $l_c > (70/C_w^2)$**   
 Forming Part of Sentence 4.1.6.2.(2)

Value of $l_c C_w^2$	Value of $C_w$		
	1.0	0.75	0.5
	Value of $C_b$		
70	0.80	0.80	0.80
80	0.82	0.85	0.91
100	0.85	0.94	1.11
120	0.88	1.01	1.27
140	0.90	1.07	1.40
160	0.92	1.12	1.51
180	0.93	1.16	1.60
200	0.95	1.19	1.67
220	0.96	1.21	1.73
240	0.96	1.24	1.78
260	0.97	1.25	1.82
280	0.98	1.27	1.85
300	0.98	1.28	1.88
320	0.98	1.29	1.90
340	0.99	1.30	1.92
360	0.99	1.30	1.93
380	0.99	1.31	1.95
400	0.99	1.31	1.96
420	0.99	1.32	1.96
440	1.00	1.32	1.97
460	1.00	1.32	1.98
480	1.00	1.32	1.98
500	1.00	1.33	1.98
520	1.00	1.33	1.99
540	1.00	1.33	1.99
560	1.00	1.33	1.99
580	1.00	1.33	1.99
600	1.00	1.33	1.99
620	1.00	1.33	2.00

**6)** The slope factor,  $C_{sr}$ , for unobstructed slippery roofs where snow and ice can slide completely off the roof shall be

- a) 1.0 where the roof slope,  $\alpha$ , is equal to or less than  $15^\circ$ ,
- b)  $(60^\circ - \alpha)/45^\circ$  where  $\alpha$  is greater than  $15^\circ$  but not greater than  $60^\circ$ , and
- c) 0 where  $\alpha$  exceeds  $60^\circ$ .

**7)** Unless otherwise stated in this Subsection, the slope factor,  $C_{sr}$ , shall be 1.0 when used in conjunction with accumulation factors for increased snow loads.

**8)** The accumulation factor,  $C_a$ , shall be 1.0, which corresponds to the uniform snow load case, except that where appropriate for the shape of the roof, it shall be assigned other values that account for

- a) increased non-uniform snow loads due to snow drifting onto a roof that is at a level lower than other parts of the same *building* or at a level lower than another *building* within 5 m of it horizontally, as prescribed in Articles 4.1.6.5., 4.1.6.6. and 4.1.6.8.,

- b) increased non-uniform snow loads on areas adjacent to roof projections, such as penthouses, large *chimneys* and equipment, as prescribed in Articles 4.1.6.7. and 4.1.6.8.,
- c) non-uniform snow loads on gable, arch or curved roofs and domes, as prescribed in Articles 4.1.6.9. and 4.1.6.10.,
- d) increased snow or ice loads due to snow sliding as prescribed in Article 4.1.6.11.,
- e) increased snow loads in roof valleys, as prescribed in Article 4.1.6.12., and
- f) increased snow or ice loads due to meltwater draining from adjacent *building* elements and roof projections.

**9)** For shapes not addressed in Sentence (8),  $C_a$  corresponding to the non-uniform snow load case shall be established based on applicable field observations, special analyses including local climatic effects, appropriate model tests, or a combination of these methods.

#### 4.1.6.3. Full and Partial Loading

**1)** A roof or other *building* surface and its structural members subject to loads due to snow accumulation shall be designed for the specified load given in Sentence 4.1.6.2.(1), distributed over the entire loaded area.

**2)** In addition to the distribution mentioned in Sentence (1), flat roofs and shed roofs, gable roofs of 15° slope or less, and arch or curved roofs shall be designed for the specified uniform snow load indicated in Sentence 4.1.6.2.(1), which shall be calculated using the accumulation factor  $C_a = 1.0$ , distributed on any one portion of the loaded area and half of this load on the remainder of the loaded area, in such a way as to produce the most critical effects on the member concerned. (See Note A-4.1.6.3.(2).)

#### 4.1.6.4. Specified Rain Load

**1)** Except as provided in Sentence (4), the specified load,  $S$ , due to the accumulation of rainwater on a surface whose position, shape and deflection under load make such an accumulation possible, is that resulting from the one-day rainfall determined in conformance with Subsection 1.1.3. and applied over the horizontal projection of the surface and all tributary surfaces. (See Note A-4.1.6.4.(1).)

**2)** The provisions of Sentence (1) apply whether or not the surface is provided with a means of drainage, such as rainwater leaders.

**3)** Except as provided in Sentence 4.1.6.2.(1), loads due to rain need not be considered to act simultaneously with loads due to snow. (See Note A-4.1.6.4.(3).)

**4)** Where scuppers are provided and where the position, shape and deflection of the loaded surface make an accumulation of rainwater possible, the loads due to rain shall be the lesser of either the one-day rainfall determined in conformance with Subsection 1.1.3. or a depth of rainwater equal to 30 mm above the level of the scuppers, applied over the horizontal projection of the surface and tributary areas.

#### 4.1.6.5. Multi-level Roofs

**1)** The drifting load of snow on a roof adjacent to a higher roof shall be taken as trapezoidal, as shown in Figure 4.1.6.5.-A, and the accumulation factor,  $C_a$ , shall be determined as follows:

$$C_a = C_{a0} - (C_{a0} - 1)(x/x_d) \text{ for } 0 \leq x \leq x_d,$$

or

$$C_a = 1.0 \text{ for } x > x_d$$

where

$C_{a0}$  = peak value of  $C_a$  at  $x = 0$  determined in accordance with Sentences (3) and (4) and as shown in Figure 4.1.6.5.-B,

$x$  = distance from roof step as shown in Figure 4.1.6.5.-A, and

$x_d$  = length of drift determined in accordance with Sentence (2) and as shown in Figure 4.1.6.5.-A.

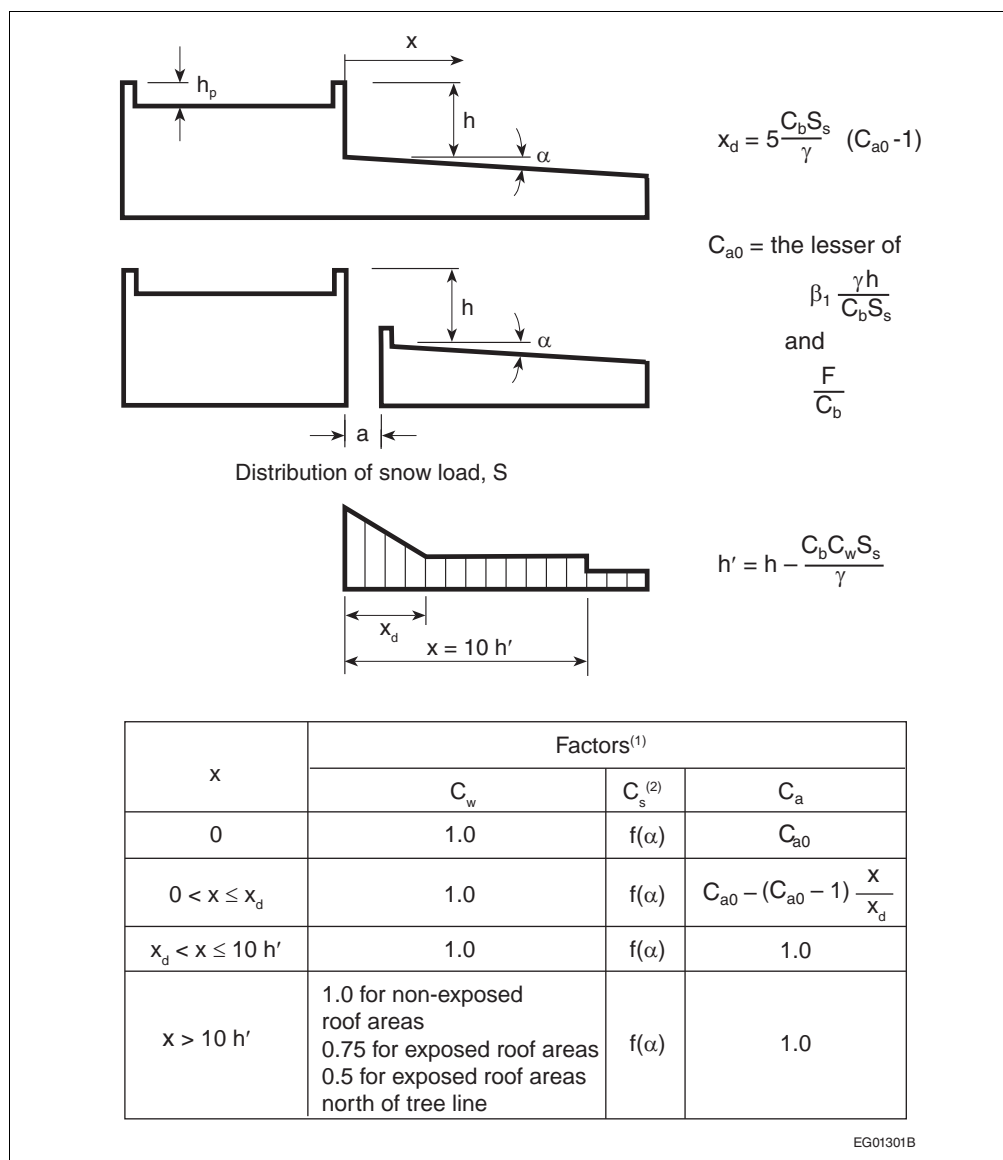
2) The length of the drift,  $x_d$ , shall be calculated as follows:

$$x_d = 5 \frac{C_b S_s}{\gamma} (C_{a0} - 1)$$

where

$\gamma$  = specific weight of snow as specified in Article 4.1.6.13.

**Figure 4.1.6.5-A**  
**Snow load factors for lower level roofs**  
 Forming Part of Sentences 4.1.6.5.(1) and (3) and 4.1.6.6.(1)



**Notes to Figure 4.1.6.5-A:**

- (1) If  $a > 5$  m or  $h \leq 0.8 S_s / \gamma$ , drifting from the higher roof need not be considered.
- (2) For lower roofs with parapets,  $C_s = 1.0$ , otherwise it varies as a function of slope  $\alpha$  as defined in Sentences 4.1.6.2.(5) and (6).

- 3)** The value of  $C_{a0}$  for each of Cases I, II, and III shall be the lesser of

$$C_{a0} = \beta \frac{\gamma h}{C_b S_s}$$

and

$$C_{a0} = \frac{F}{C_b}$$

where

$\beta = 1.0$  for Case I, and  $0.67$  for Cases II and III,

$h$  = difference in elevation between the lower roof surface and the top of the parapet on the upper roof as shown in Figure 4.1.6.5.-A, and

$$F = 0.35\beta \sqrt{\frac{\gamma(l_{cs} - 5h'_p)}{S_s}} + C_b, \text{ but } F \leq 5 \text{ for } C_{ws} = 1.0$$

where

$C_{ws}$  = value of  $C_w$  applicable to the source of drifting,

$l_{cs}$  = characteristic length of the source area for drifting, defined as  $l_{cs} = 2w_s - \frac{w_s^2}{l_s}$ , where  $w_s$  and  $l_s$  are respectively the shorter and longer dimensions of the relevant source areas for snow drifting shown in Figure 4.1.6.5.-B for Cases I, II and III, and

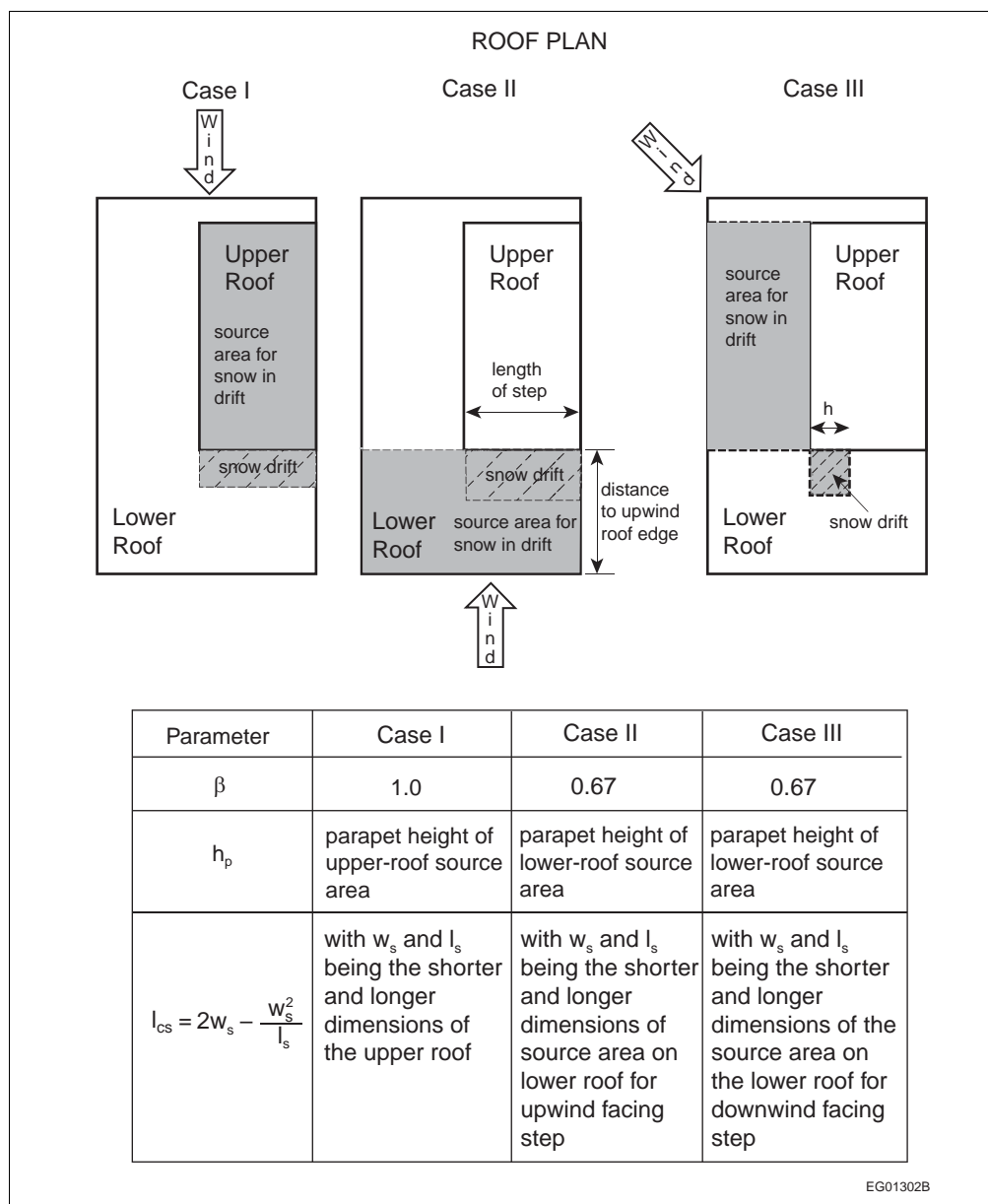
$$h'_p = h_p - \left( \frac{0.8S}{\gamma} \right), \text{ but } 0 \leq h'_p \leq \left( \frac{l_{cs}}{5} \right)$$

where

$h_p$  = height of the roof perimeter parapet of the source area, to be taken as zero unless all the roof edges of the source area have parapets.

- 4)** The value of  $C_{a0}$  shall be the highest of Cases I, II and III, considering the different roof source areas for drifting snow, as specified in Sentence (3) and Figure 4.1.6.5.-B.

**Figure 4.1.6.5-B**  
**Snow load cases I, II and III for lower level roofs**  
 Forming Part of Sentences 4.1.6.5.(1), (3) and (4)



**4.1.6.6. Horizontal Gap between a Roof and a Higher Roof**

**1)** Where the roof of one *building* is separated by a distance,  $a$ , from an adjacent *building* with a higher roof as shown in Figure 4.1.6.5.-A, the influence of the adjacent *building* on the value of the accumulation factor,  $C_a$ , for the lower roof shall be determined as follows:

- a) if  $a > 5$  m, the influence of the adjacent *building* on  $C_a$  for the lower roof can be ignored, and
- b) if  $a \leq 5$  m,  $C_a$  for the lower roof shall be calculated in accordance with Article 4.1.6.5. for values of  $x \geq a$ .

**4.1.6.7. Areas Adjacent to Roof Projections**

**1)** Except as provided in Sentences (2) and (3), the accumulation factor,  $C_a$ , for areas adjacent to roof-mounted vertical projections shall be calculated in accordance

with Sentence 4.1.6.5.(1) using the following values for the peak accumulation factor,  $C_{a0}$ , and the drift length,  $x_d$ :

- a)  $C_{a0}$  shall be taken as the lesser of

$$0.67 \frac{\gamma h}{C_b S_s} \text{ and } \frac{\gamma l_0}{7.5 C_b S_s} + 1, \text{ and}$$

- b)  $x_d$  shall be taken as the lesser of  $3.35h$  and  $(2/3)l_0$ , where  
 $h$  = height of the projection, and  
 $l_0$  = longest horizontal dimension of the projection.

(See Note A-4.1.6.7.(1).)

**2)**  $C_a$  is permitted to be calculated in accordance with Article 4.1.6.5. for larger projections. (See Note A-4.1.6.7.(2).)

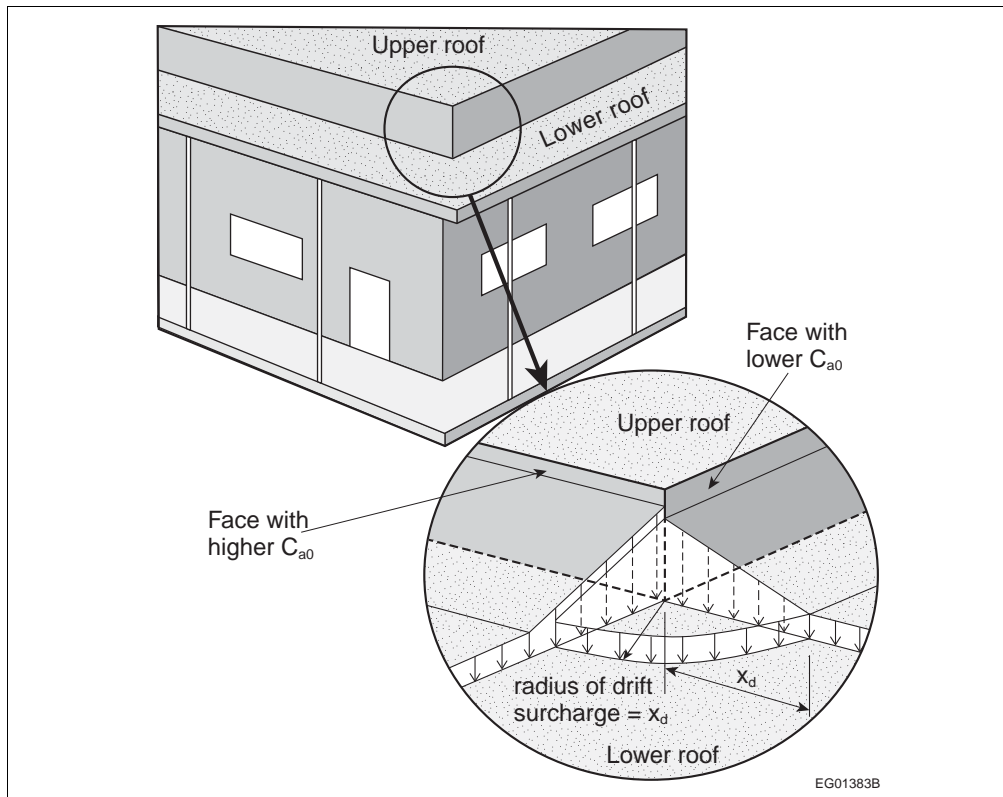
**3)** Where the longest horizontal dimension of the roof projection,  $l_0$ , is less than 3 m, the drift surcharge adjacent to the projection need not be considered.

**4.1.6.8. Snow Drift at Corners**

**1)** The drift loads on the lower level roof against the two faces of an outside corner of an upper level roof or roof obstruction shall be extended radially around the corner as shown in Figure 4.1.6.8.-A and may be taken as the least severe of the drift loads lying against the two faces of the corner.

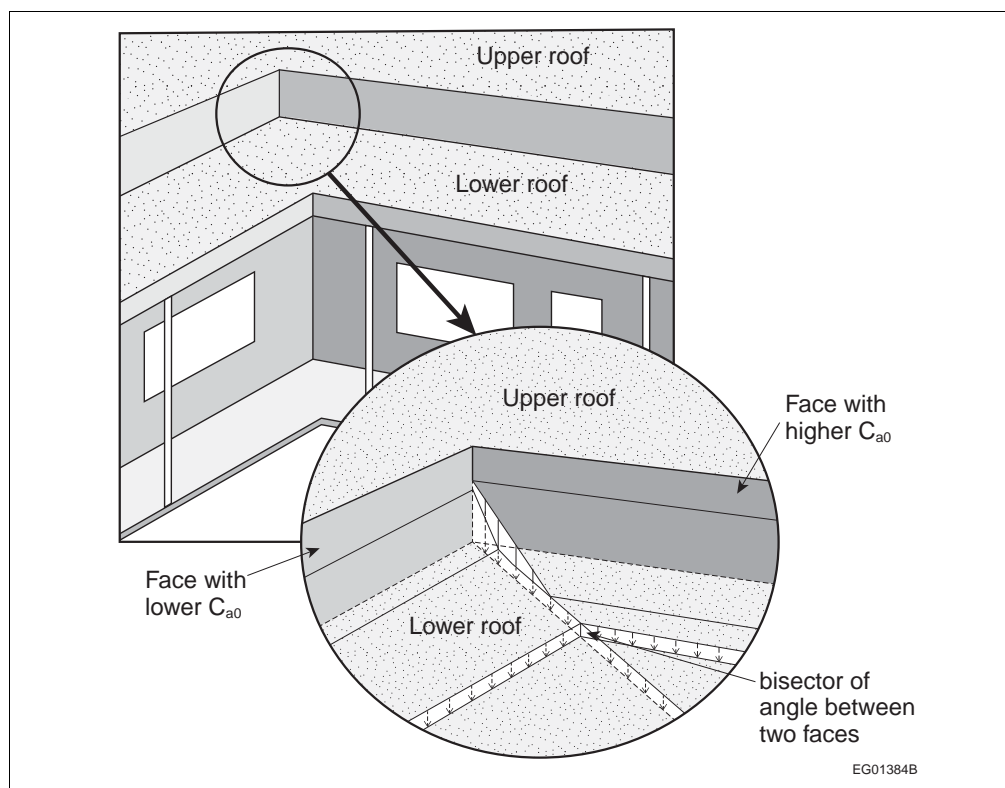
**2)** The drift loads on the lower level roof against the two faces of an inside corner of an upper level roof or a parapet shall be calculated for each face and applied as far as the bisector of the corner angle as shown in Figure 4.1.6.8.-B.

**Figure 4.1.6.8.-A**  
**Snow load at outside corner**  
 Forming Part of Sentence 4.1.6.8.(1)





**Figure 4.1.6.8.-B**  
**Snow load at inside corner**  
 Forming Part of Sentence 4.1.6.8.(2)



**4.1.6.9. Gable Roofs**

(See Note A-4.1.6.9.)

**1)** For all gable roofs, the full and partial load cases defined in Article 4.1.6.3. shall be considered.

**2)** For gable roofs with a slope  $\alpha > 15^\circ$ , the unbalanced load case shall also be considered by setting the values of the accumulation factor,  $C_a$ , as follows:

- a) on the upwind side of the roof peak,  $C_a$  shall be taken as 0, and
- b) on the downwind side of the roof peak,  $C_a$  shall be taken as
  - i)  $0.25 + \alpha/20$ , where  $15^\circ \leq \alpha \leq 20^\circ$ , and
  - ii) 1.25, where  $20^\circ < \alpha \leq 90^\circ$ .

**3)** For all gable roofs, the slope factor,  $C_s$ , shall be as prescribed in Sentences 4.1.6.2.(5) and (6).

- 4)** For all gable roofs, the wind exposure factor,  $C_w$ , shall be
  - a) as prescribed in Sentences 4.1.6.2.(3) and (4) for the full and partial load cases, and
  - b) 1.0 for the unbalanced load case referred to in Sentence (2).

**4.1.6.10. Arch Roofs, Curved Roofs and Domes**

**1)** For all arch roofs, curved roofs and domes, the full and partial load cases defined in Article 4.1.6.3. shall be considered.

**2)** For arch roofs, curved roofs and domes with a rise-to-span ratio  $h/b > 0.05$  (see Figure 4.1.6.10.-A), the load cases provided in Sentences (3) to (7) shall also be considered.

- 3) For arch roofs with a slope at the edge  $\alpha_e \leq 30^\circ$  (see Figure 4.1.6.10.-A and Table 4.1.6.10.),  $C_a$  shall be
- taken as 0 on the upwind side of the peak, and
  - on the downwind side of the peak, taken as

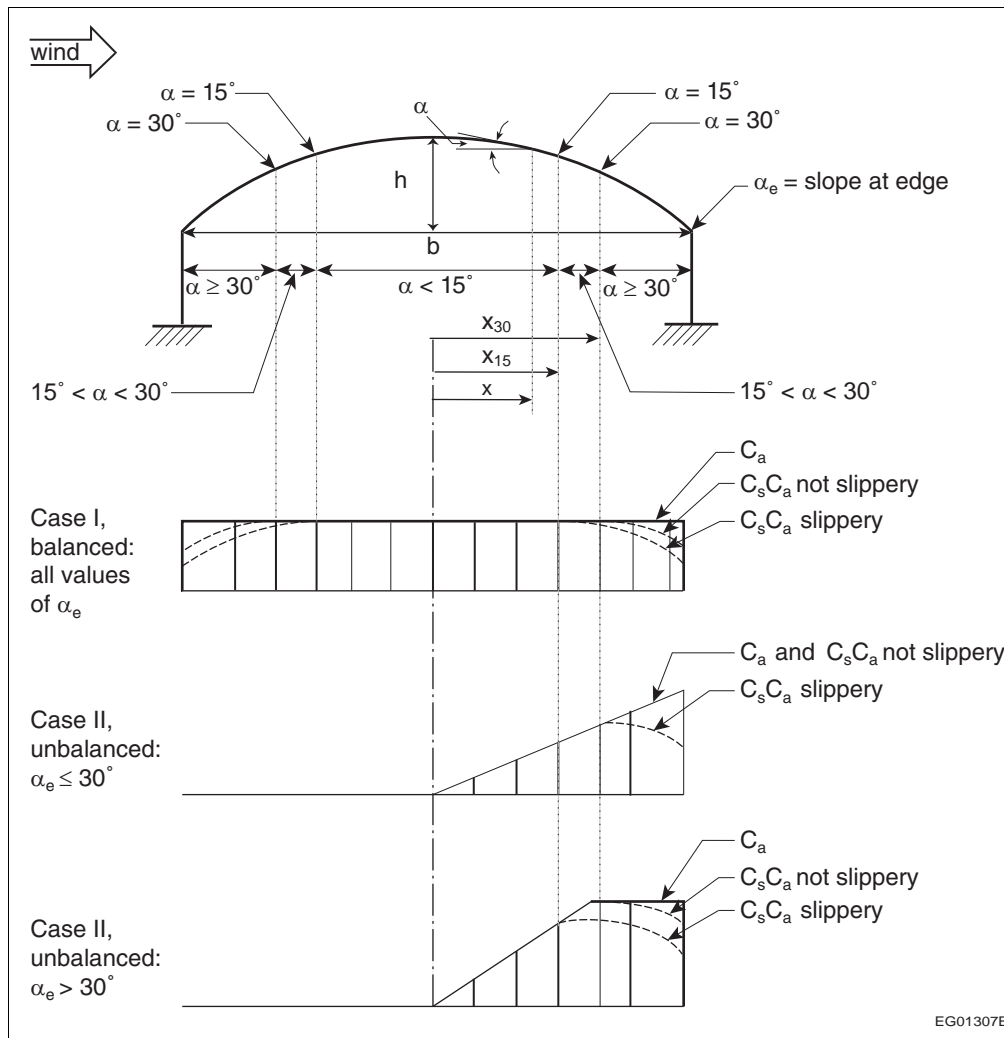
$$C_a = \frac{xh}{0.03C_b b^2} \text{ for } 0.05 < \frac{h}{b} \leq 0.12 \text{ and}$$

$$C_a = \frac{4x}{C_b b} \text{ for } \frac{h}{b} > 0.12$$

where

- x = horizontal distance from the roof peak,
- h = height of arch, and
- b = width of arch.

**Figure 4.1.6.10.-A**  
**Accumulation factors for arch roofs and curved roofs**  
 Forming Part of Sentences 4.1.6.10.(2) to (4)



**Note to Figure 4.1.6.10.-A:**

- Refer to Table 4.1.6.10. for applicable values of  $C_w$  and Sentences 4.1.6.2.(5) and (6) for applicable values of  $C_s$ .

EG01307B

- 4)** For arch roofs with a slope at the edge  $\alpha_e > 30^\circ$  (see Figure 4.1.6.10.-A and Table 4.1.6.10.),  $C_a$  shall be
- a) taken as 0 on the upwind side of the peak, and
  - b) on the downwind side of the peak,
    - i) for the part of the roof between the peak and point where the slope  $\alpha = 30^\circ$ , taken as

$$C_a = \frac{xh}{0.06C_b x_{30} b} \text{ for } 0.05 < \frac{h}{b} \leq 0.12, \text{ and}$$

$$C_a = \frac{2x}{C_b x_{30}} \text{ for } \frac{h}{b} > 0.12$$

where

- $x, h, b$  = as specified in Sentence (2), and
- $x_{30}$  = value of  $x$  where the slope  $\alpha = 30^\circ$ , and
- ii) for the part of the roof where the slope  $\alpha > 30^\circ$ , taken as

$$C_a = \frac{h}{0.06C_b b} \text{ for } 0.05 < \frac{h}{b} \leq 0.12, \text{ and}$$

$$C_a = \frac{2}{C_b} \text{ for } \frac{h}{b} > 0.12$$

- 5)** Except as provided in Sentence (6),  $C_a$  for curved roofs shall be determined in accordance with the requirements for arch roofs stated in Sentences (3) and (4).

**Table 4.1.6.10.**  
**Load Cases for Arch Roofs, Curved Roofs and Domes**  
 Forming Part of Sentences 4.1.6.10.(3), (4) and (9)

Load Case	Range of Application	Factors			
		All Arch or Curved Roofs and Domes	Arch and Curved Roofs		Domes
		$C_w$	$C_a$ Upwind Side	$C_a$ Downwind Side	$C_a$ Downwind Side
Case I	All values of $h/b$	As stated in 4.1.6.2.(3) and (4)	1.0	1.0	1.0
Case II	Slope at edge $\leq 30^\circ$ $h/b > 0.05$ all values of $x$	1.0	0.0	$C_a = \frac{xh}{0.03C_b b^2} \text{ for } \frac{h}{b} \leq 0.12$ $C_a = \frac{4x}{C_b b} \text{ for } \frac{h}{b} > 0.12$	$C_a(x, y) = C_a(x, 0) \left(1 - \frac{y}{r}\right)$
	Slope at edge $> 30^\circ$ $h/b > 0.05$ $0 < x < x_{30}$	1.0	0.0	$C_a = \frac{xh}{0.06C_b x_{30} b} \text{ for } \frac{h}{b} \leq 0.12$ $C_a = \frac{2x}{C_b x_{30}} \text{ for } \frac{h}{b} > 0.12$	
	Slope at edge $> 30^\circ$ $h/b > 0.05$ $x \geq x_{30}$	1.0	0.0	$C_a = \frac{xh}{0.06C_b b} \text{ for } \frac{h}{b} \leq 0.12$ $C_a = \frac{2}{C_b} \text{ for } \frac{h}{b} > 0.12$	

- 6) Where the slope,  $\alpha$ , of a curved roof at its peak is greater than  $10^\circ$ ,  $C_a$  shall be determined in accordance with the requirements for gable roofs stated in Article 4.1.6.9. using a slope equal to the mean slope of the curved roof.
- 7) For domes of circular plan form (see Figure 4.1.6.10.-B),  $C_a$  shall
  - a) along the central axis parallel to the wind, vary in the same way as for an arch roof with the same rise-to-span ratio,  $h/b$ , and
  - b) off this axis, vary according to

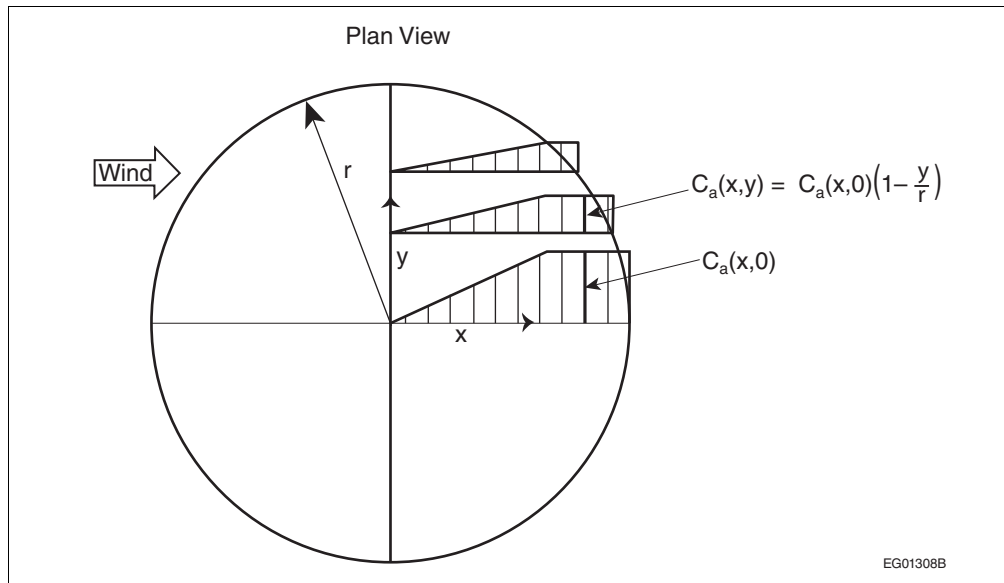
$$C_a(x, y) = C_a(x, 0) \left(1 - \frac{y}{r}\right)$$

where

- $C_a(x, y)$  = value of  $C_a$  at location  $(x, y)$ ,
- $C_a(x, 0)$  = value of  $C_a$  on the central axis parallel to the wind,
- $x$  = distance along the central axis parallel to the wind,
- $y$  = horizontal coordinate normal to the  $x$  direction, and
- $r$  = radius of dome.

- 8) For all arch roofs, curved roofs and domes, the slope factor,  $C_{sr}$ , shall be as prescribed in Sentences 4.1.6.2.(5) and (6).
- 9) For all arch roofs, curved roofs and domes, the wind exposure factor,  $C_{wr}$ , shall be as prescribed in Table 4.1.6.10.

**Figure 4.1.6.10.-B**  
**Unbalanced snow accumulation factor on a circular dome**  
 Forming Part of Sentence 4.1.6.10.(7)



**Notes to Figure 4.1.6.10.-B:**

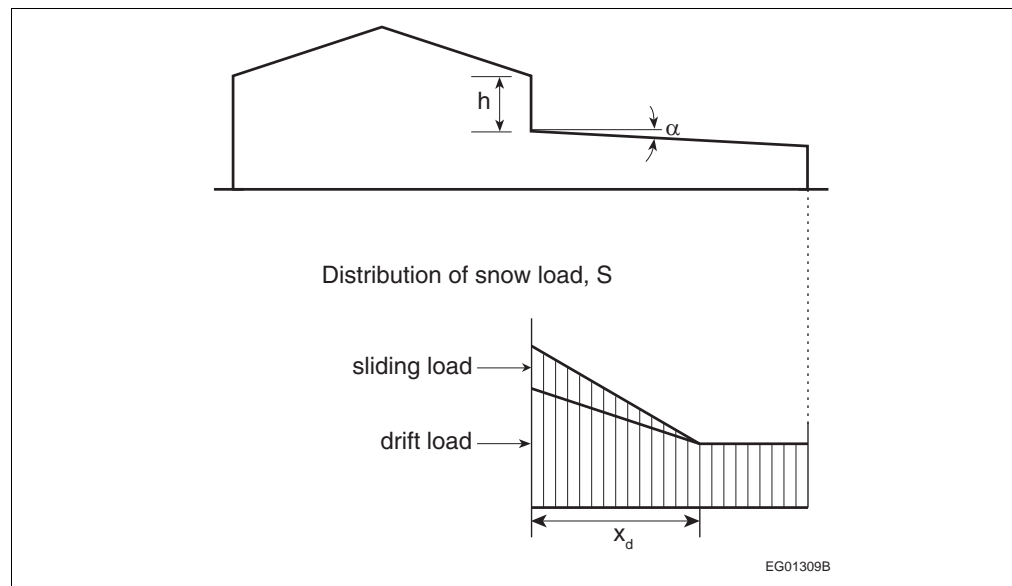
- (1) Refer to Table 4.1.6.10. for applicable values of  $C_w$  and Sentences 4.1.6.2.(5) and (6) for applicable values of  $C_s$ .
- (2) Refer to Sentences 4.1.6.10.(3) and (4) for the calculation of  $C_a(x, 0)$ .

**4.1.6.11. Snow Loads Due to Sliding**

- 1) Except as provided in Sentence (2), where an upper roof, or part thereof, slopes downwards with a slope  $\alpha > 0$  towards a lower roof, the snow load,  $S$ , on the lower roof, determined in accordance with Articles 4.1.6.2. and 4.1.6.5., shall be augmented in accordance with Sentence (3) to account for the additional load resulting from sliding snow.

- 2)** Sentence (1) need not apply where
  - a) snow from the upper roof is prevented from sliding by a parapet or other effective means, or
  - b) the upper roof is not considered slippery and has a slope of less than 20°.
- 3)** The total weight of additional snow resulting from sliding shall be taken as half the total weight of snow resulting from the uniform load case prescribed in Article 4.1.6.2. with
  - a) the accumulation factor  $C_a = 1.0$  for the relevant part of the upper roof,
  - b) the slope factor,  $C_s$ , based on the slope of the lower roof, as prescribed in Sentences 4.1.6.2.(5) and (6), and
  - c) the sliding snow distributed on the lower roof such that it is a maximum for  $x = 0$  and decreases linearly to 0 at  $x = x_d$ , as shown in Figure 4.1.6.11., where  $x$  and  $x_d$  are as defined in Article 4.1.6.5.

**Figure 4.1.6.11.**  
**Snow distribution on lower roof with sloped upper roof**  
 Forming Part of Sentence 4.1.6.11.(3)



**4.1.6.12. Valleys in Curved or Sloped Roofs**

**1)** For valleys in curved or sloped roofs with a slope  $\alpha > 10^\circ$ , in addition to the full and partial load cases defined in Article 4.1.6.3., the non-uniform load cases II and III presented in Sentences (2) and (3) shall be considered to account for sliding, creeping and movement of meltwater.

**2)** For case II (see Figure 4.1.6.12.), the accumulation factor,  $C_a$ , shall be calculated as follows:

$$C_a = \frac{1}{C_b} \text{ for } 0 < x \leq b/4, \text{ and}$$

$$C_a = \frac{0.5}{C_b} \text{ for } b/4 < x \leq b/2$$

where

- $x$  = horizontal distance from the bottom of the valley, and
- $b$  = twice the horizontal distance between the bottom of the valley and the peak of the roof surface in question.

3) For case III (see Figure 4.1.6.12.),  $C_a$  shall be calculated as follows:

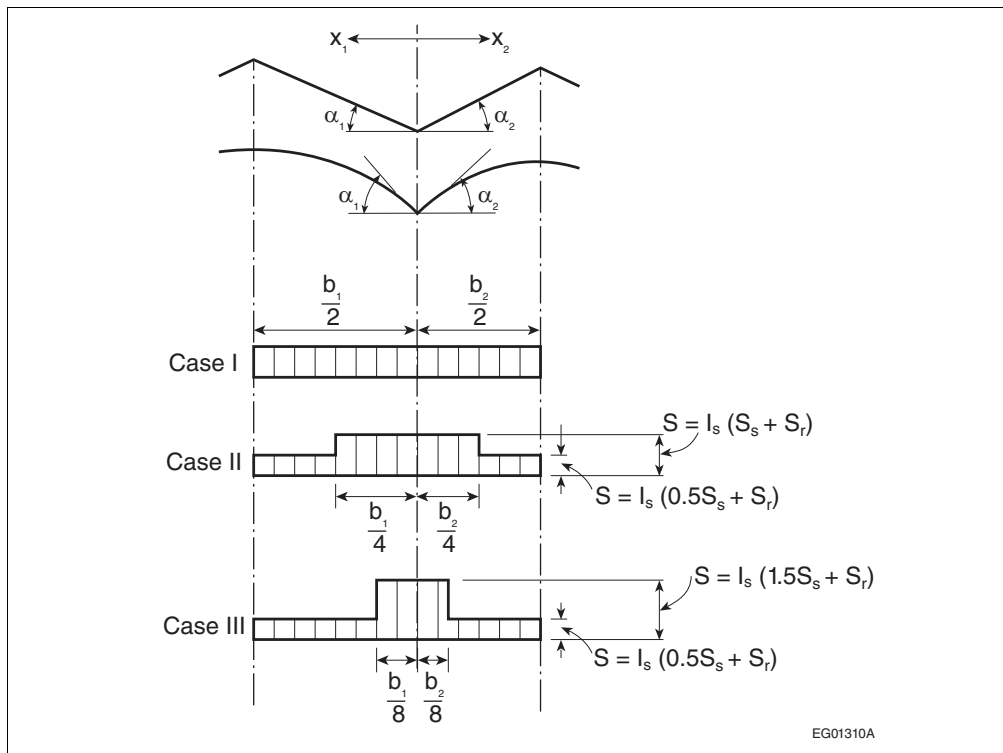
$$C_a = \frac{1.5}{C_b} \text{ for } 0 < x \leq b/8, \text{ and}$$

$$C_a = \frac{0.5}{C_b} \text{ for } b/8 < x \leq b/2$$

where

$x, b$  = as specified in Sentence (2).

**Figure 4.1.6.12.**  
**Snow loads in valleys of sloped or curved roofs**  
 Forming Part of Sentences 4.1.6.12.(2) and (3)



Notes to Figure 4.1.6.12.:

- (1)  $C_w = 1$ , as per Sentence 4.1.6.2.(3).
- (2)  $C_s = 1$ , as per Sentence 4.1.6.2.(7).

**4.1.6.13. Specific Weight of Snow**

1) For the purposes of calculating snow loads in drifts, the specific weight of snow,  $\gamma$ , shall be taken as  $4.0 \text{ kN/m}^3$  or  $0.43S_s + 2.2 \text{ kN/m}^3$ , whichever is lesser.

**4.1.6.14. Snow Removal**

1) Snow removal by mechanical, thermal, manual or other means shall not be used as a rationale to reduce design snow loads.

**4.1.6.15. Ice Loading of Structures**

1) For lattice structures connected to the *building*, and other *building* components or appurtenances involving small width elements subject to significant ice accretion, the weight of ice accretion and the effective area presented to wind shall be as prescribed in CSA S37, "Antennas, Towers, and Antenna-Supporting Structures."

**4.1.7. Wind Load**

**4.1.7.1. Specified Wind Load**

- 1)** The specified wind loads for a *building* and its components shall be determined using the Static, Dynamic or Wind Tunnel Procedure as stated in Sentences (2) to (5).
- 2)** For the design of *buildings* that are not dynamically sensitive, as defined in Sentence 4.1.7.2.(1), one of the following procedures shall be used to determine the specified wind loads:
  - a) the Static Procedure described in Article 4.1.7.3.,
  - b) the Dynamic Procedure described in Article 4.1.7.8., or
  - c) the Wind Tunnel Procedure described in Article 4.1.7.12.
- 3)** For the design of *buildings* that are dynamically sensitive, as defined in Sentence 4.1.7.2.(2), one of the following procedures shall be used to determine the specified wind loads:
  - a) the Dynamic Procedure described in Article 4.1.7.8., or
  - b) the Wind Tunnel Procedure described in Article 4.1.7.12.
- 4)** For the design of *buildings* that may be subject to wake buffeting or channelling effects from nearby *buildings*, or that are very dynamically sensitive, as defined in Sentence 4.1.7.2.(3), the Wind Tunnel Procedure described in Article 4.1.7.12., shall be used to determine the specified wind loads.
- 5)** For the design of cladding and secondary structural members, one of the following procedures shall be used to determine the specified wind loads:
  - a) the Static Procedure described in Article 4.1.7.3., or
  - b) the Wind Tunnel Procedure described in Article 4.1.7.12.
- 6)** Computational fluid dynamics shall not be used to determine the specified wind loads for a *building* and its components. (See Note A-4.1.7.1.(6).)

**4.1.7.2. Classification of Buildings**

- 1)** Except as provided in Sentences (2) and (3), a *building* is permitted to be classified as not dynamically sensitive.
- 2)** A *building* shall be classified as dynamically sensitive if
  - a) its lowest natural frequency is less than 1 Hz and greater than 0.25 Hz,
  - b) its height is greater than 60 m, or
  - c) its height is greater than 4 times its minimum effective width, where the effective width, *w*, of a *building* shall be taken as

$$w = \frac{\sum h_i w_i}{\sum h_i}$$

where the summations are over the height of the *building* for a given wind direction, *h<sub>i</sub>* is the height above grade to level *i*, and *w<sub>i</sub>* is the width normal to the wind direction at height *h<sub>i</sub>*; the minimum effective width is the lowest value of the effective width considering all wind directions.

- 3)** A *building* shall be classified as very dynamically sensitive if
  - a) its lowest natural frequency is less than or equal to 0.25 Hz, or
  - b) its height is more than 6 times its minimum effective width as defined in Clause (2)(c).

**4.1.7.3. Static Procedure**

- 1)** The specified external pressure or suction due to wind on part or all of a surface of a *building* shall be calculated as follows:

$$p = I_W q C_e C_t C_g C_p$$

where

- $p$  = specified external pressure acting statically and in a direction normal to the surface, considered positive when the pressure acts towards the surface and negative when it acts away from the surface,
- $I_w$  = importance factor for wind load, as provided in Table 4.1.7.3.,
- $q$  = reference velocity pressure, as provided in Sentence (4),
- $C_e$  = exposure factor, as provided in Sentences (5) and (7),
- $C_t$  = topographic factor, as provided in Article 4.1.7.4.,
- $C_g$  = gust effect factor, as provided in Sentence (8), and
- $C_p$  = external pressure coefficient, as provided in Articles 4.1.7.5. and 4.1.7.6.

**Table 4.1.7.3.**  
**Importance Factor for Wind Load,  $I_w$**   
 Forming Part of Sentences 4.1.7.3.(1) and (3)

Importance Category	Importance Factor, $I_w$	
	ULS	SLS
Low	0.8	0.75
Normal	1	0.75
High	1.15	0.75
Post-disaster	1.25	0.75

**2)** The net wind load for the *building* as a whole shall be the algebraic difference of the loads on the windward and leeward surfaces, and in some cases, may be calculated as the sum of the products of the external pressures or suction and the areas of the surfaces over which they are averaged as provided in Sentence (1).

**3)** The net specified pressure due to wind on part or all of a surface of a *building* shall be the algebraic difference, such as to produce the most critical effect, of the external pressure or suction calculated in accordance with Sentence (1) and the specified internal pressure or suction due to wind calculated as follows:

$$p_i = I_w q C_{ei} C_t C_{gi} C_{pi}$$

where

- $p_i$  = specified internal pressure acting statically and in a direction normal to the surface, either as a pressure directed towards the surface or as a suction directed away from the surface,
- $I_w, q, C_t$  = as defined in Sentence (1),
- $C_{ei}$  = exposure factor for internal pressure, as provided in Sentence (7),
- $C_{gi}$  = internal gust effect factor, as provided in Sentence (10), and
- $C_{pi}$  = internal pressure coefficient, as provided in Article 4.1.7.7.

**4)** The reference velocity pressure,  $q$ , shall be the appropriate value determined in conformance with Subsection 1.1.3., based on a probability of being exceeded in any one year of 1 in 50.

**5)** The exposure factor,  $C_e$ , shall be based on the reference height,  $h$ , determined in accordance with Sentence (6), for the surface or part of the surface under consideration and shall be

- a)  $(h/10)^{0.2}$  but not less than 0.9 for open terrain, where open terrain is level terrain with only scattered *buildings*, trees or other obstructions, open water or shorelines thereof,
- b)  $0.7(h/12)^{0.3}$  but not less than 0.7 for rough terrain, where rough terrain is suburban, urban or wooded terrain extending upwind from the *building* uninterrupted for at least 1 km or 20 times the height of the *building*, whichever is greater, or
- c) an intermediate value between the two exposures defined in Clauses (a) and (b) in cases where the site is less than 1 km or 20 times the height of the



*building* from a change in terrain conditions, whichever is greater, provided an appropriate interpolation method is used (see Note A-4.1.7.3.(5)(c)).

- 6)** The reference height,  $h$ , shall be determined as follows:
  - a) for *buildings* whose height is less than or equal to 20 m and less than the smaller plan dimension,  $h$  shall be the mid-height of the roof above *grade*, but not less than 6 m,
  - b) for other *buildings*,  $h$  shall be
    - i) the actual height above *grade* of the point on the windward wall for which external pressures are being calculated,
    - ii) the mid-height of the roof for pressures on surfaces parallel to the wind direction, and
    - iii) the mid-height of the *building* for pressures on the leeward wall, and
  - c) for any structural element exposed to wind,  $h$  shall be the mid-height of the element above the ground.
- 7)** The exposure factor for internal pressures,  $C_{ei}$ , shall be determined as follows:
  - a) for *buildings* whose height is greater than 20 m and that have a dominant opening,  $C_{ei}$  shall be equal to the exposure factor for external pressures,  $C_e$ , calculated at the mid-height of the dominant opening, and
  - b) for other *buildings*,  $C_{ei}$  shall be the same as the exposure factor for external pressures,  $C_e$ , calculated for a reference height,  $h$ , equal to the mid-height of the *building* or 6 m, whichever is greater.
- 8)** Except as provided in Sentences (9) and 4.1.7.6.(1), the gust effect factor,  $C_g$ , shall be one of the following values:
  - a) 2.0 for the *building* as a whole and main structural members, or
  - b) 2.5 for external pressures and suctions on secondary structural members, including cladding.
- 9)** For cases where  $C_g$  and  $C_p$  are combined into a single product,  $C_p C_g$ , the values of  $C_p$  and  $C_g$  need not be independently specified. (See Article 4.1.7.6.)
- 10)** The internal gust effect factor,  $C_{gi}$ , shall be 2.0, except it is permitted to be calculated using the following equation for large structures enclosing a single large unpartitioned volume that does not have numerous overhead doors or openings:

$$C_{gi} = 1 + \frac{1}{\sqrt{1 + \frac{V_0}{6950A}}}$$

where

$V_0$  = internal volume, in  $m^3$ , and

$A$  = total area of all exterior openings of the volume, in  $m^2$ .

(See Note A-4.1.7.3.(10).)

**4.1.7.4. Topographic Factor**

- 1)** Except as provided in Sentence (2), the topographic factor,  $C_t$ , shall be taken as 1.0.
- 2)** For *buildings* on hills or escarpments with a slope,  $H_h/(2L_h)$ , greater than 0.1 (see Figure 4.1.7.4.), the topographic factor,  $C_t$ , shall be calculated as follows:

$$C_t = \left(1 + \frac{\Delta S}{C_g}\right) (1 + \Delta S)$$

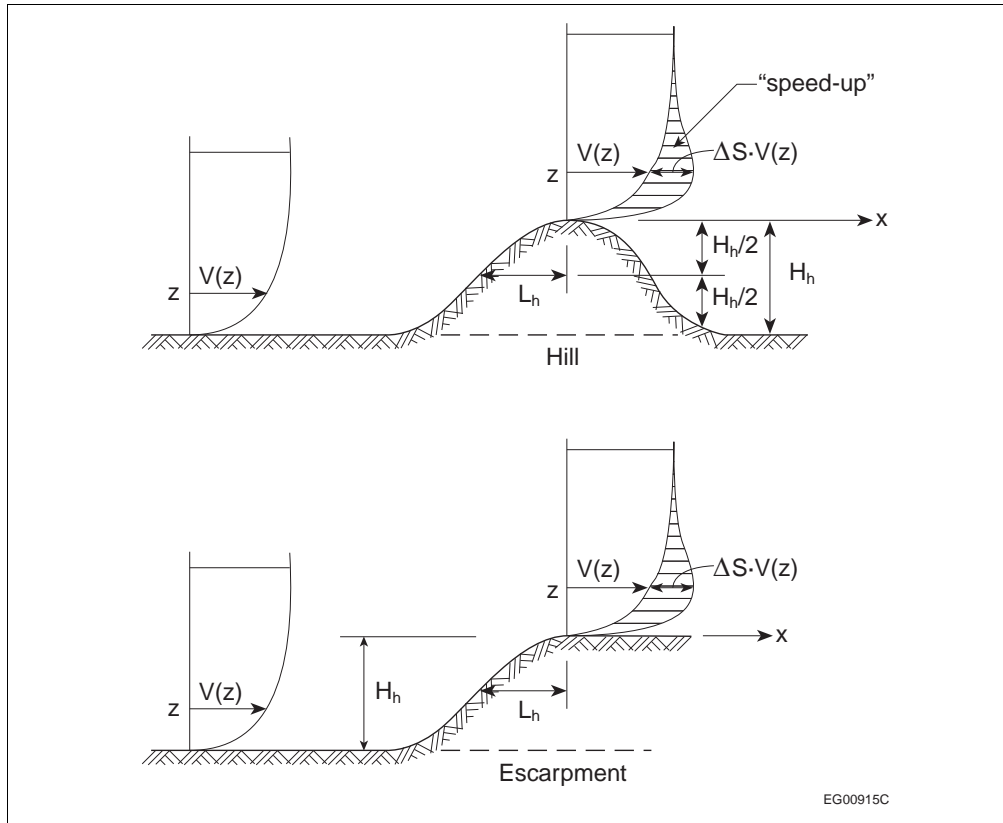
where

$$\Delta S = \Delta S_{\max} \left(1 - \frac{|x|}{kL_h}\right) \exp(-\alpha z/L_h)$$

where

- $\Delta S_{max}$  = applicable value from Table 4.1.7.4.,
- $x$  = horizontal distance from the peak of the hill or escarpment,
- $L_h$  = horizontal distance upwind from the peak to the point where the ground surface lies at half the height of the hill or escarpment, or  $2H_h$  (where  $H_h$  = height of hill or escarpment), whichever is greater,
- $z$  = height above ground, and
- $k$  and  $\alpha$  = applicable constants from Table 4.1.7.4. based on shape of hill or escarpment.

**Figure 4.1.7.4.**  
**Speed-up of mean velocity on a hill or escarpment**  
 Forming Part of Sentence 4.1.7.4.(2)



**Note to Figure 4.1.7.4.:**

(1)  $V(z)$  = wind speed

**Table 4.1.7.4.**  
**Parameters for Maximum Speed-up Over Hills and Escarpments**  
 Forming Part of Sentence 4.1.7.4.(2)

Shape of Hill or Escarpment	$\Delta S_{max}^{(1)}$	$\alpha$	$k$	
			$x < 0$	$x \geq 0$
2-dimensional hill	$2.2 H_h/L_h$	3	1.5	1.5
2-dimensional escarpment	$1.3 H_h/L_h$	2.5	1.5	4
3-dimensional axi-symmetrical hill	$1.6 H_h/L_h$	4	1.5	1.5

**Notes to Table 4.1.7.4.:**

(1) For  $H_h/L_h > 0.5$ , assume  $H_h/L_h = 0.5$  and substitute  $2 H_h$  for  $L_h$  in the equation for  $\Delta S$ .

**4.1.7.5. External Pressure Coefficients**

- 1)** Applicable values of external pressure coefficients,  $C_p$ , are provided in
- Sentences (2) to (5), and
  - Article 4.1.7.6. for certain shapes of low *buildings*.

**2)** For the design of the main structural system, the value of  $C_p$  shall be established as follows, where  $H$  is the height of the *building* and  $D$  is the width of the *building* parallel to the wind direction:

- on the windward face,
 
$$C_p = 0.6 \text{ for } H/D < 0.25$$

$$= 0.27(H/D + 2) \text{ for } 0.25 \leq H/D < 1.0, \text{ and}$$

$$= 0.8 \text{ for } H/D \geq 1.0,$$
- on the leeward face,
 
$$C_p = -0.3 \text{ for } H/D < 0.25,$$

$$= -0.27(H/D + 0.88) \text{ for } 0.25 \leq H/D < 1.0, \text{ and}$$

$$= -0.5 \text{ for } H/D \geq 1.0, \text{ and}$$
- on the walls parallel to the wind,  $C_p = -0.7$ .

(See Note A-4.1.7.5.(2) and (3).)

**3)** For the design of roofs, the value of  $C_p$  shall be established as follows, where  $x$  is the distance from the upwind edge of the roof:

- for  $H/D \geq 1.0$ ,  $C_p = -1.0$ , and
- for  $H/D < 1.0$ ,
 
$$C_p = -1.0 \text{ for } x \leq H, \text{ and}$$

$$= -0.5 \text{ for } x > H.$$

(See Note A-4.1.7.5.(2) and (3).)

**4)** For the design of the cladding and of secondary structural elements supporting the cladding, the value of  $C_p$  shall be established as follows, where  $W$  and  $D$  are the widths of the *building*:

- on walls,  $C_p$  shall be taken as  $\pm 0.9$ , except that within a distance equal to the larger of  $0.1D$  and  $0.1W$  from a *building* corner, the negative value of  $C_p$  shall be taken as  $-1.2$ ,
- on walls where vertical ribs deeper than 1 m are placed on the facade,  $C_p$  shall be taken as  $\pm 0.9$ , except that, within a distance equal to the larger of  $0.2D$  and  $0.2W$  from a *building* corner, the negative value of  $C_p$  shall be taken as  $-1.4$ , and
- on roofs,  $C_p$  shall be taken as  $-1.0$ , except that
  - within a distance equal to the larger of  $0.1D$  and  $0.1W$  from a roof edge,  $C_p$  shall be taken as  $-1.5$ ,
  - in a zone that is within a distance equal to the larger of  $0.2W$  and  $0.2D$  from a roof corner,  $C_p$  shall be taken as  $-2.3$  but is permitted to be taken as  $-2.0$  for roofs with perimeter parapets that are higher than 1 m, and
  - on lower levels of flat stepped roofs, positive pressure coefficients established for the walls of the steps apply for a distance  $b$  (see Figure 4.1.7.6.-D for the definition of  $b$ ).

(See Note A-4.1.7.5.(4).)

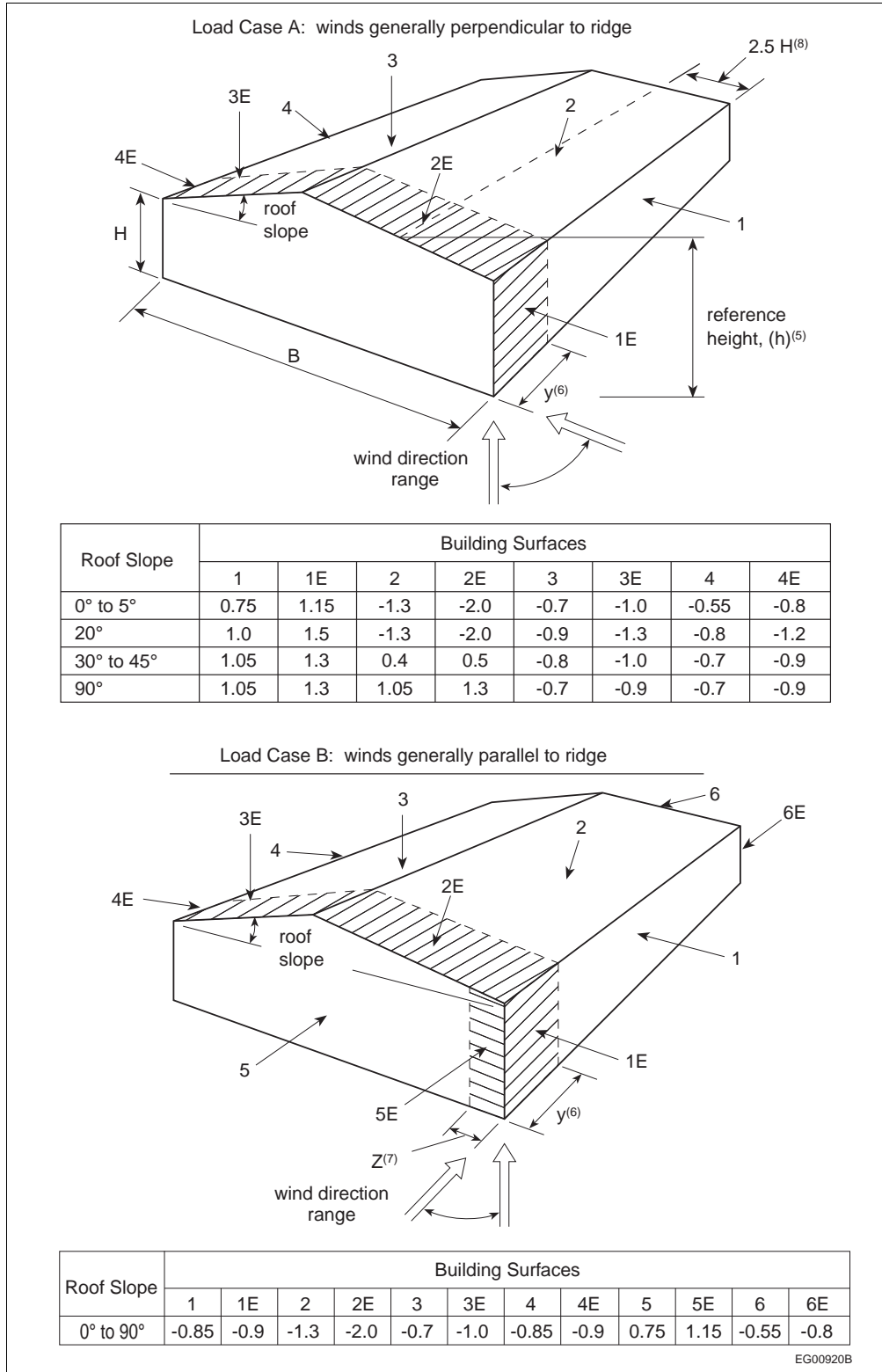
**5)** For the design of balcony *guards*, the internal pressure coefficient,  $C_{pi}$ , shall be taken as zero and the value of  $C_p$  shall be taken as  $\pm 0.9$ , except that within a distance equal to the larger of  $0.1W$  and  $0.1D$  from a *building* corner,  $C_p$  shall be taken as  $\pm 1.2$ .

**4.1.7.6. External Pressure Coefficients for Low Buildings**

**1)** For the design of *buildings* with a height,  $H$ , that is both less than or equal to 20 m and less than the smaller plan dimension, the values of the product of the pressure coefficient and gust factor,  $C_p C_g$ , provided in Sentences (2) to (9) are permitted to be used.

**2)** For the design of the main structural system of the *building*, which is affected by wind pressures on more than one surface, the values of  $C_p C_g$  are provided in Figure 4.1.7.6.-A.

**Figure 4.1.7.6.-A**  
**External peak values of  $C_p C_g$  for primary structural actions arising from wind load acting simultaneously on all surfaces of low buildings ( $H \leq 20$  m)**  
 Forming Part of Sentence 4.1.7.6.(2)



Copyright © NRC 1941 - 2021 World Rights Reserved © CNRC 1941-2021 Droits réservés pour tous pays

**Notes to Figure 4.1.7.6-A:**

- (1) The *building* must be designed for all wind directions. Each corner must be considered in turn as the windward corner shown in the sketches. For all roof slopes, Load Case A and Load Case B are required as two separate loading conditions to generate the wind actions, including torsion, to be resisted by the structural system.
- (2) For values of roof slope not shown, the coefficient ( $C_p C_g$ ) can be interpolated linearly.
- (3) Positive coefficients denote forces toward the surface, whereas negative coefficients denote forces away from the surface.
- (4) For the design of *foundations*, exclusive of anchorages to the frame, only 70% of the effective load is to be considered.
- (5) The reference height,  $h$ , for pressures is the mid-height of the roof or 6 m, whichever is greater. The eave height,  $H$ , may be substituted for the mid-height of the roof if the roof slope is less than  $7^\circ$ .
- (6) End-zone width  $y$  should be the greater of 6 m or  $2z$ , where  $z$  is the width of the gable-wall end zone defined for Load Case B below. Alternatively, for *buildings* with frames, the end zone  $y$  may be the distance between the end and the first interior frame.
- (7) End-zone width  $z$  is the lesser of 10% of the least horizontal dimension and 40% of height,  $H$ , but not less than 4% of the least horizontal dimension or 1 m.
- (8) For  $B/H > 5$  in Load Case A, the listed negative coefficients on surfaces 2 and 2E should only be applied on an area whose width is  $2.5H$  measured from the windward eave. The pressures on the remainder of the windward roof should be reduced to the pressures for the leeward roof.

**3)** For the design of individual walls and wall cladding, the values of  $C_p C_g$  are provided in Figure 4.1.7.6.-B.

**4)** For the design of roofs with a slope less than or equal to  $7^\circ$ , the values of  $C_p C_g$  are provided in Figure 4.1.7.6.-C.

**5)** For the design of flat roofs with steps in elevation, the values of  $C_p C_g$  are provided in Figure 4.1.7.6.-D.

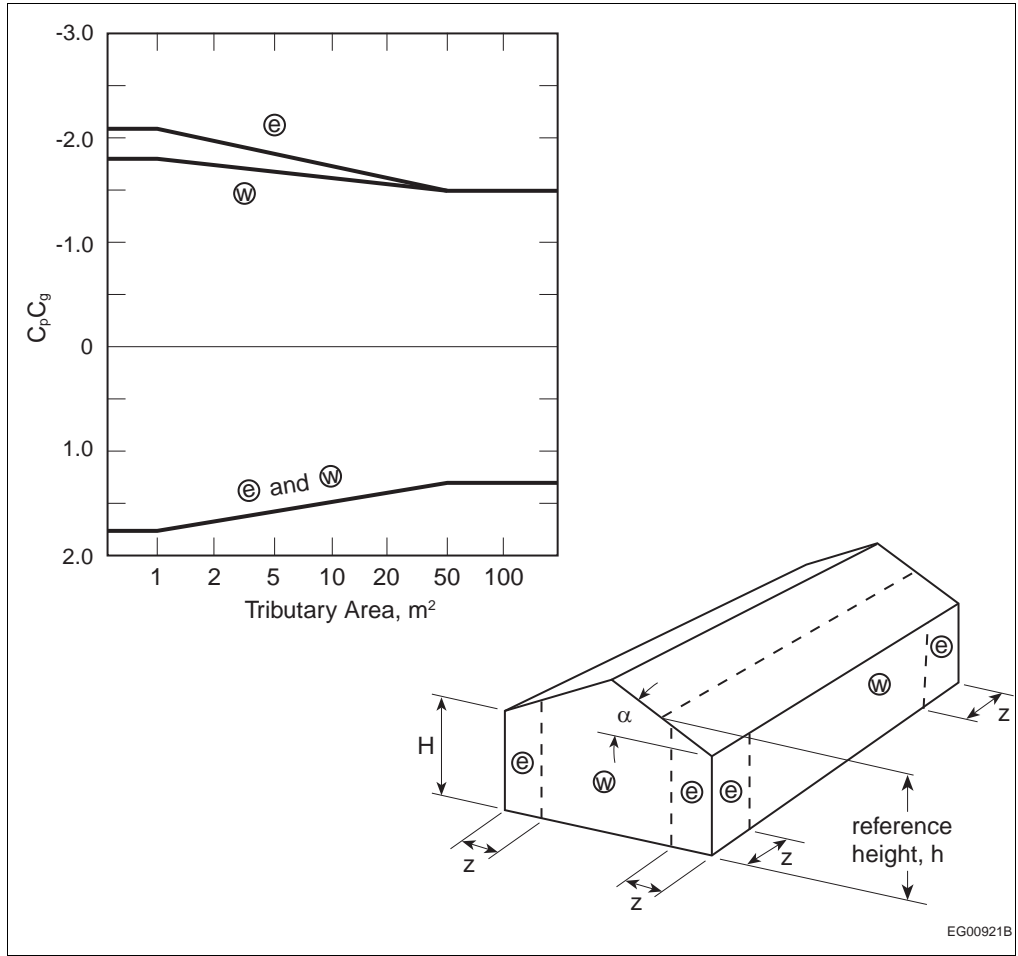
**6)** For the design of gabled or hipped, single-ridge roofs with a slope greater than  $7^\circ$ , the values of  $C_p C_g$  are provided in Figure 4.1.7.6.-E.

- 7)** For the design of gabled, multi-ridge roofs, the values of  $C_p C_g$  are provided in
- a) Figure 4.1.7.6.-C for roofs with a slope less than or equal to  $10^\circ$ , and
  - b) Figure 4.1.7.6.-F for roofs with a slope greater than  $10^\circ$ .

- 8)** For monosloped roofs, the values of  $C_p C_g$  are provided in
- a) Figure 4.1.7.6.-C for roofs with a slope less than or equal to  $3^\circ$ , and
  - b) Figure 4.1.7.6.-G for roofs with a slope greater than  $3^\circ$  and less than or equal to  $30^\circ$ .

- 9)** For sawtooth roofs, the values of  $C_p C_g$  are provided in
- a) Figure 4.1.7.6.-C for roofs with a slope less than or equal to  $10^\circ$ , and
  - b) Figure 4.1.7.6.-H for roofs with a slope greater than  $10^\circ$ .

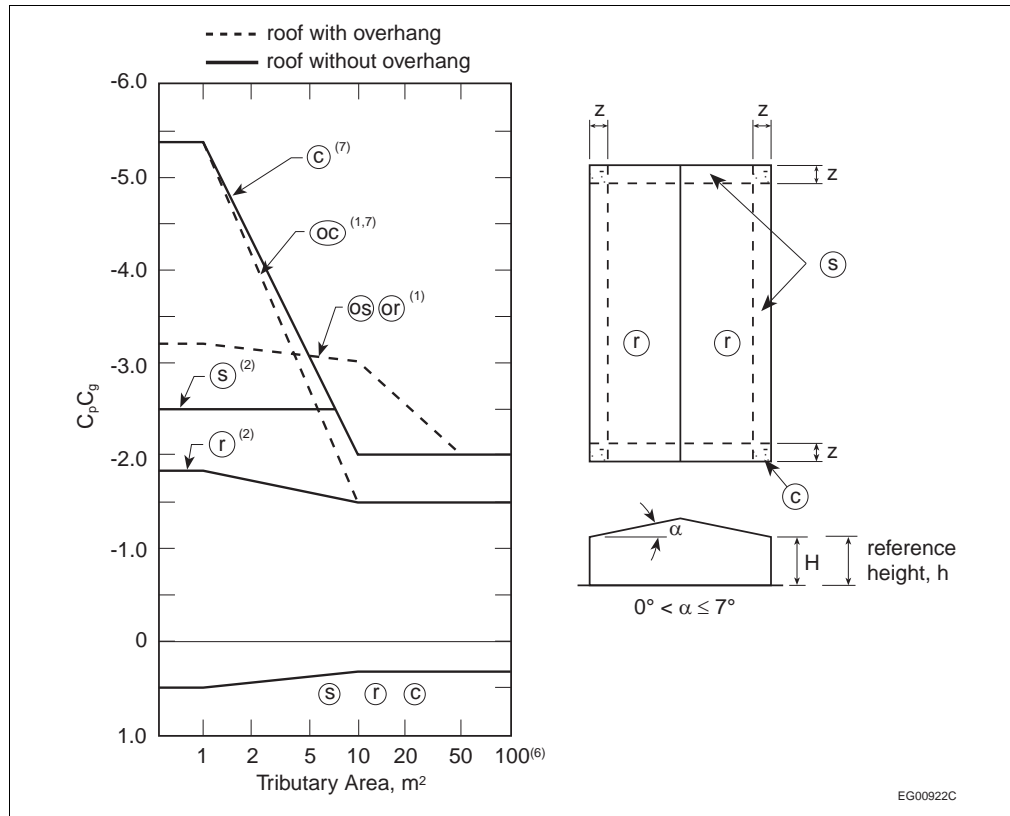
**Figure 4.1.7.6.-B**  
**External peak values of  $C_p C_g$  on individual walls for the design of cladding and secondary structural members**  
 Forming Part of Sentence 4.1.7.6.(3)



- Notes to Figure 4.1.7.6.-B:**
- (1) These coefficients apply for any roof slope,  $\alpha$ .
  - (2) End-zone width  $z$  is the lesser of 10% of the least horizontal dimension and 40% of height,  $H$ , but not less than 4% of the least horizontal dimension or 1 m.
  - (3) Combinations of external and internal pressures must be evaluated to obtain the most severe loading.
  - (4) Positive coefficients denote forces toward the surface, whereas negative coefficients denote forces away from the surface. Each structural element must be designed to withstand forces of both signs.
  - (5) Pressure coefficients generally apply for facades with architectural features; however, where vertical ribs deeper than 1 m are placed on a facade, a local  $C_p C_g$  of  $-2.8$  applies to zone e.

Copyright © NRC 1941 - 2021 World Rights Reserved © CNRC 1941-2021 Droits réservés pour tous pays

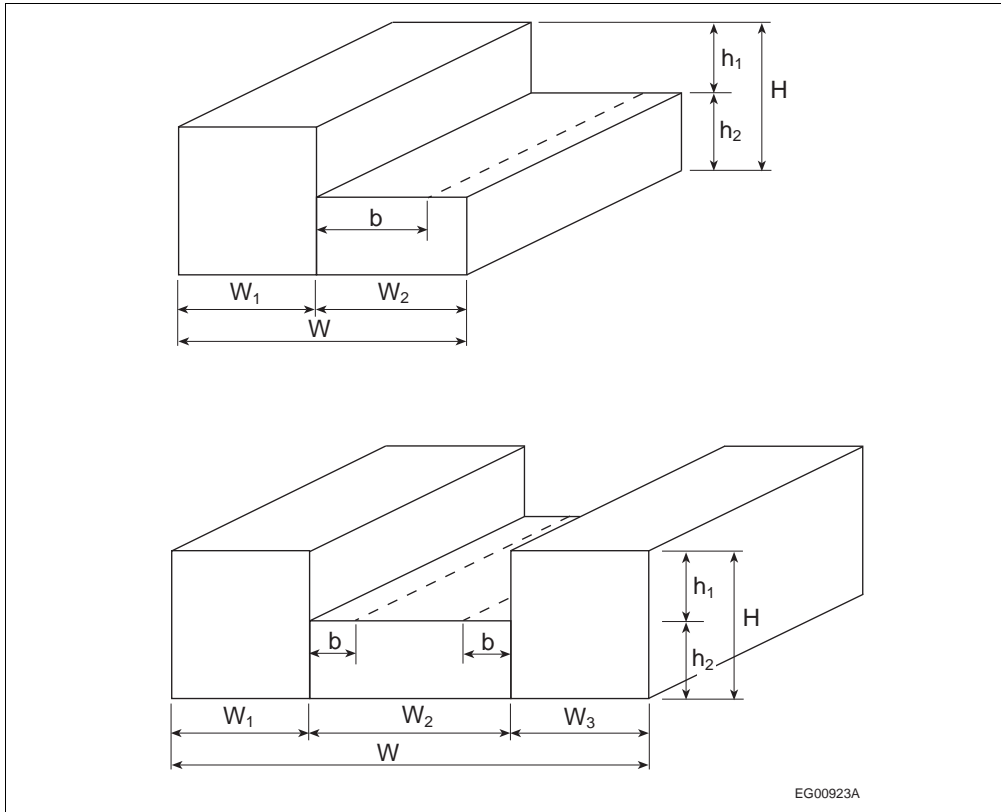
**Figure 4.1.7.6.-C**  
**External peak values of  $C_p C_g$  on roofs with a slope of  $7^\circ$  or less for the design of structural components and cladding**  
 Forming Part of Sentences 4.1.7.6.(4), (7), (8) and (9)



**Notes to Figure 4.1.7.6.-C:**

- (1) Coefficients for overhung roofs have the prefix "o" and refer to the same roof areas as referred to by the corresponding symbol without a prefix. They include contributions from both upper and lower surfaces. In the case of overhangs, the walls are inboard of the roof outline.
- (2) s and r apply to both roofs and upper surfaces of canopies.
- (3) End-zone width  $z$  is the lesser of 10% of the least horizontal dimension and 40% of height,  $H$ , but not less than 4% of the least horizontal dimension or 1 m.
- (4) Combinations of external and internal pressures must be evaluated to obtain the most severe loading.
- (5) Positive coefficients denote forces toward the surface, whereas negative coefficients denote forces away from the surface. Each structural element must be designed to withstand forces of both signs.
- (6) For calculating the uplift forces on tributary areas larger than  $100 m^2$  on unobstructed nearly-flat roofs with low parapets, and where the centre of the tributary area is at least twice the height of the *building* from the nearest edge, the value of  $C_p C_g$  may be reduced from  $-1.5$  to  $-1.1$  at  $x/H = 2$  and further reduced linearly to  $-0.6$  at  $x/H = 5$ , where  $x$  is the distance to the nearest edge and  $H$  is the height of the *building*.
- (7) For roofs having a perimeter parapet with a height of 1 m or greater, the corner coefficients  $C_p C_g$  for tributary areas less than  $1 m^2$  can be reduced from  $-5.4$  to  $-4.4$ .

**Figure 4.1.7.6.-D**  
**External peak values of  $C_p C_g$  for the design of the structural components and cladding of buildings with stepped roofs**  
 Forming Part of Sentence 4.1.7.6.(5)

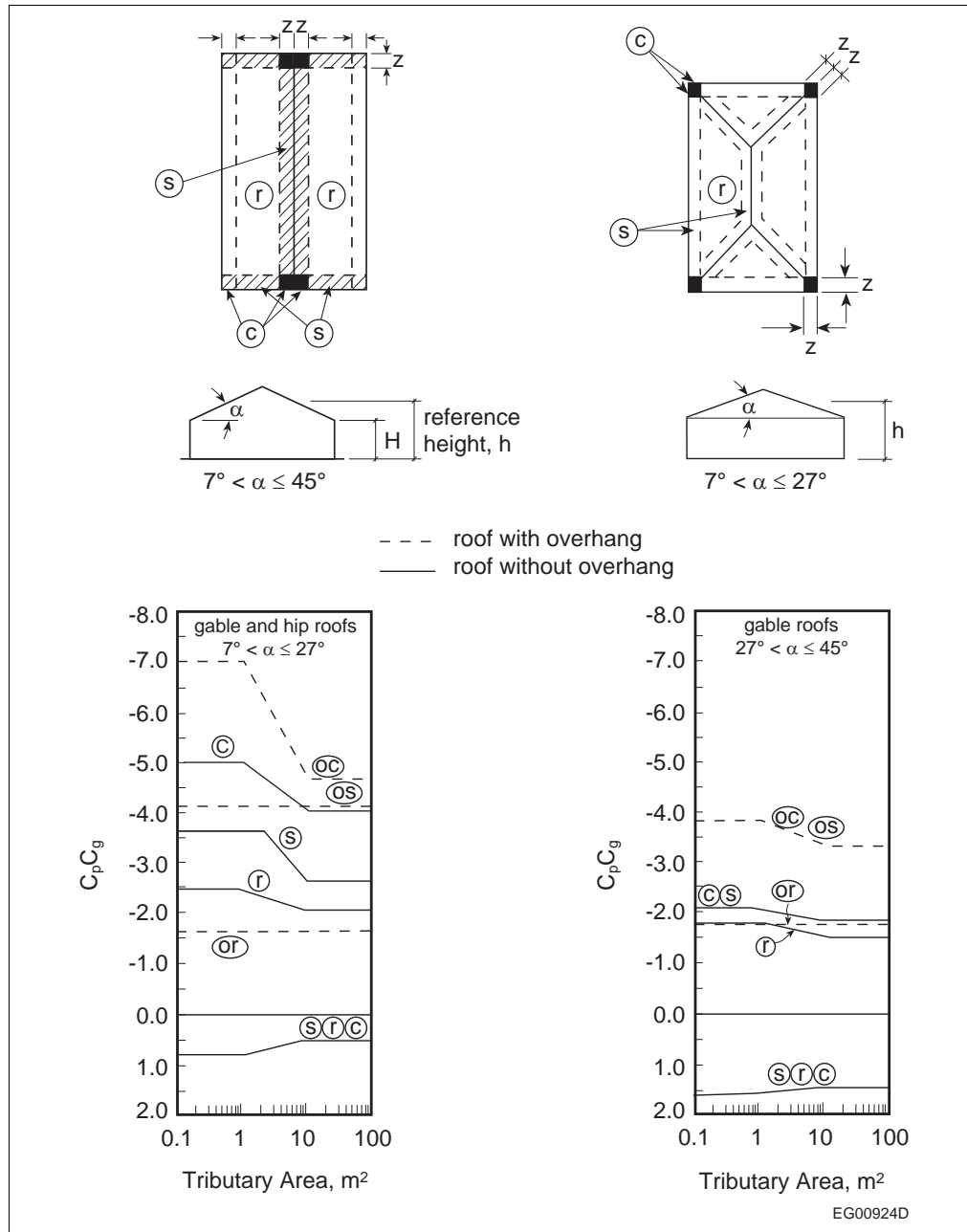


**Notes to Figure 4.1.7.6.-D:**

- (1) The zone designations, pressure-gust coefficients and notes provided in Figure 4.1.7.6.-C apply on both the upper and lower levels of flat stepped roofs, except that on the lower levels, positive pressure-gust coefficients equal to those in Figure 4.1.7.6.-B for walls apply for a distance,  $b$ , where  $b$  is equal to  $1.5h_1$  but not greater than 30 m. For all walls in Figure 4.1.7.6.-D, zone designations and pressure coefficients provided for walls in Figure 4.1.7.6.-B apply.
- (2) Note (1) above applies only when the following conditions are met:  $h_1 \geq 0.3H$ ,  $h_1 \geq 3$  m, and  $W_1$ ,  $W_2$ , or  $W_3$  is greater than  $0.25W$  but not greater than  $0.75W$ .



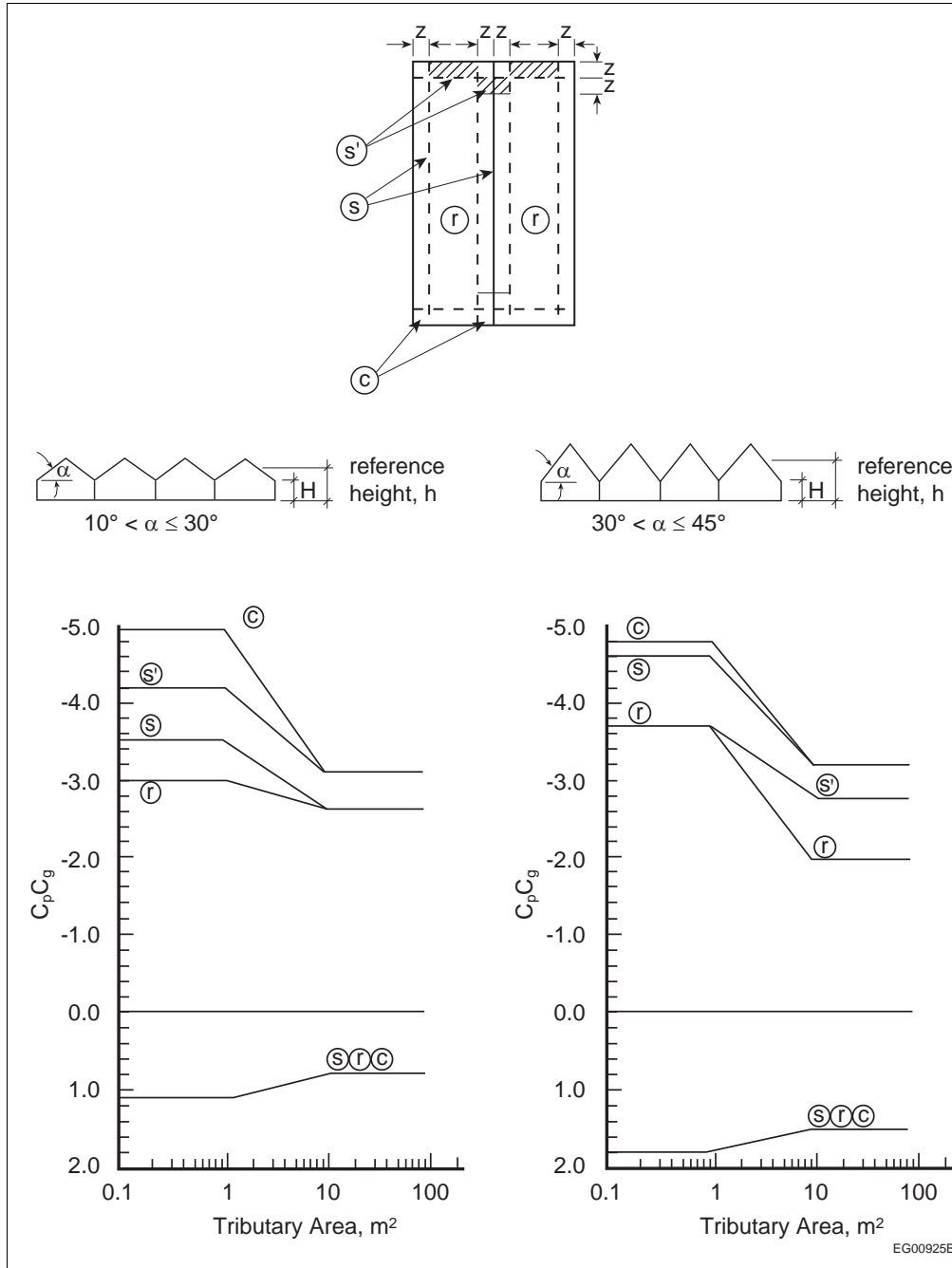
**Figure 4.1.7.6.-E**  
**External peak values of  $C_p C_g$  on single-span gabled and hipped roofs with a slope greater than  $7^\circ$**   
**for the design of structural components and cladding**  
 Forming Part of Sentence 4.1.7.6.(6)



**Notes to Figure 4.1.7.6.-E:**

- (1) Coefficients for overhung roofs have the prefix "o" and refer to the same roof areas as referred to by the corresponding symbol without a prefix. They include contributions from both upper and lower surfaces.
- (2) End-zone width  $z$  is the lesser of 10% of the least horizontal dimension and 40% of height,  $H$ , but not less than 4% of the least horizontal dimension or 1 m.
- (3) Combinations of external and internal pressures must be evaluated to obtain the most severe loading.
- (4) Positive coefficients denote forces towards the surface, whereas negative coefficients denote forces away from the surface. Each structural element must be designed to withstand forces of both signs.
- (5) For hipped roofs with  $7^\circ < \alpha \leq 27^\circ$ , edge/ridge strips and pressure-gust coefficients for ridges of gabled roofs apply along each hip.

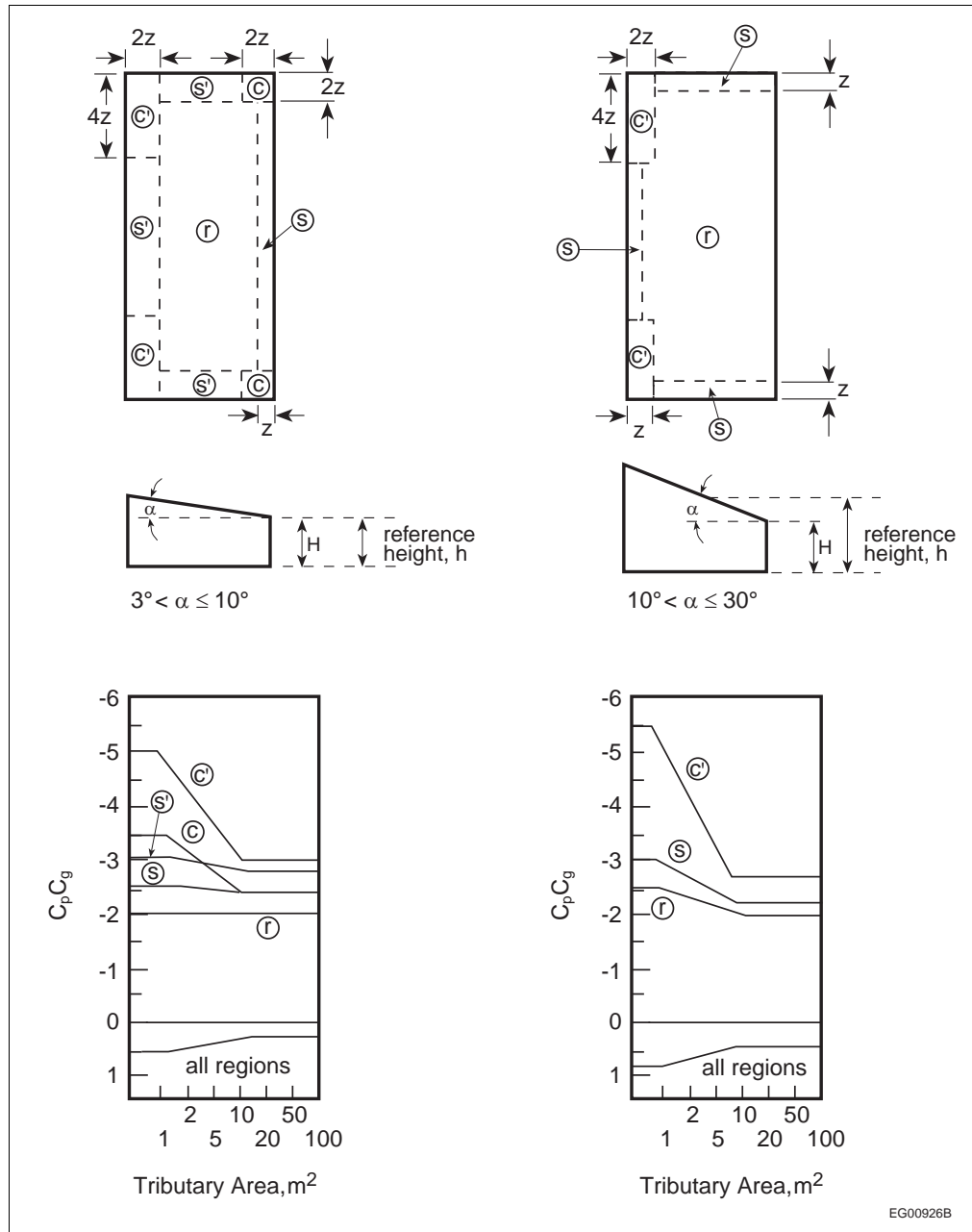
**Figure 4.1.7.6.-F**  
**External peak values of  $C_p C_g$  on multi-span gabled (folded) roofs with a slope greater than  $10^\circ$  for the design of structural components and cladding**  
 Forming Part of Sentence 4.1.7.6.(7)



**Notes to Figure 4.1.7.6.-F:**

- (1) End-zone width  $z$  is the lesser of 10% of the least horizontal dimension and 40% of height,  $H$ , but not less than 4% of the least horizontal dimension or 1 m.
- (2) Combinations of external and internal pressures must be evaluated to obtain the most severe loading.
- (3) Positive coefficients denote forces towards the surface, whereas negative coefficients denote forces away from the surface. Each structural element must be designed to withstand forces of both signs.
- (4) For  $\alpha \leq 10^\circ$ , the coefficients given in Figure 4.1.7.6.-C apply, but for cases where  $\alpha >$  than  $7^\circ$ , use  $\alpha = 7^\circ$ .

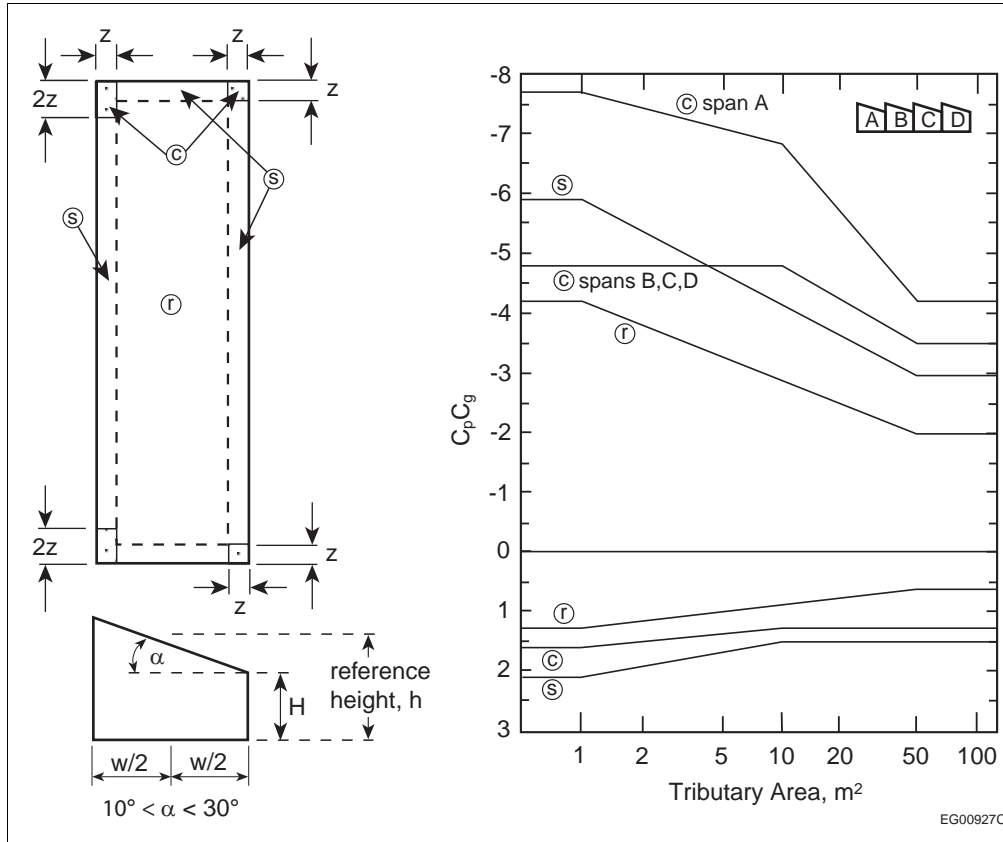
**Figure 4.1.7.6.-G**  
**External peak values of  $C_p C_g$  on monoslope roofs for the design of structural components and cladding**  
 Forming Part of Sentence 4.1.7.6.(8)



**Notes to Figure 4.1.7.6.-G:**

- (1) End-zone width  $z$  is the lesser of 10% of the least horizontal dimension and 40% of height,  $H$ , but not less than 4% of the least horizontal dimension or 1 m.
- (2) Combinations of external and internal pressures must be evaluated to obtain the most severe loading.
- (3) Positive coefficients denote forces towards the surface, whereas negative coefficients denote forces away from the surface. Each structural element must be designed to withstand forces of both signs.
- (4) For  $\alpha \leq 3^\circ$ , the coefficients given in Figure 4.1.7.6.-C apply.

**Figure 4.1.7.6.-H**  
**External peak values of  $C_p C_g$  on sawtooth roofs with a slope greater than  $10^\circ$  for the design of structural components and cladding**  
 Forming Part of Sentence 4.1.7.6.(9)



**Notes to Figure 4.1.7.6.-H:**

- (1) End-zone width  $z$  is the lesser of 10% of the least horizontal dimension and 40% of height,  $H$ , but not less than 4% of the least horizontal dimension or 1 m.
- (2) Combinations of external and internal pressures must be evaluated to obtain the most severe loading.
- (3) Positive coefficients denote forces towards the surface, whereas negative coefficients denote forces away from the surface. Each structural element must be designed to withstand forces of both signs.
- (4) Negative coefficients on the corner zones of Span A differ from those on Spans B, C, and D.
- (5) For  $\alpha \leq 10^\circ$ , the coefficients given in Figure 4.1.7.6.-C apply, but for cases where  $\alpha >$  than  $7^\circ$ , use  $\alpha = 7^\circ$ .

**4.1.7.7. Internal Pressure Coefficient**

- 1) The internal pressure coefficient,  $C_{pi}$ , shall be as prescribed in Table 4.1.7.7.

**Table 4.1.7.7.**  
**Internal Pressure Coefficients**  
 Forming Part of Sentence 4.1.7.7.(1)

Building Openings	Values for $C_{pi}$
Uniformly distributed small openings amounting to less than 0.1% of the total surface area of the building	-0.15 to 0.0
Non-uniformly distributed openings of which none is significant or significant openings that are wind-resistant and closed during storms	-0.45 to +0.30
Large openings likely to remain open during storms	-0.70 to +0.70

**4.1.7.8. Dynamic Procedure**

**1)** For the application of the Dynamic Procedure, the provisions of Article 4.1.7.3. shall be followed, except that the exposure factor,  $C_e$ , shall be as prescribed in Sentences (2) and (3), and the gust effect factor,  $C_g$ , shall be as prescribed in Sentence (4), when determining the wind loads on the main structural system.

**2)** For *buildings* in open terrain, as defined in Clause 4.1.7.3.(5)(a), the value of  $C_e$  for the design of the main structural system shall be calculated as follows:

$$C_e = \left(\frac{h}{10}\right)^{0.28}, \text{ but } 1.0 \leq C_e \leq 2.5$$

(See Note A-4.1.7.8.(2) and (3).)

**3)** For *buildings* in rough terrain, as defined in Clause 4.1.7.3.(5)(b), the value of  $C_e$  for the design of the main structural system shall be calculated as follows:

$$C_e = 0.5 \left(\frac{h}{12.7}\right)^{0.50}, \text{ but } 0.5 \leq C_e \leq 2.5$$

(See Note A-4.1.7.8.(2) and (3).)

**4)** For the design of the main structural system,  $C_g$  shall be calculated as follows:

$$C_g = 1 + g_p \frac{\sigma}{\mu}$$

where

$g_p$  = peak factor calculated as  $\sqrt{2 \ln(\nu T) + \frac{0.577}{\sqrt{2 \ln(\nu T)}}$ , and

$$\sigma/\mu = \sqrt{\frac{K}{C_{eH}} \left(B + \frac{sF}{\beta}\right)},$$

where

$\nu$  = average fluctuation rate calculated as  $f_{nD} \sqrt{\frac{sF}{sF + \beta B}}$ ,

$T$  = 3 600 s,

$K$  = 0.08 for open terrain and 0.10 for rough terrain,

$C_{eH}$  = exposure factor evaluated at reference height  $h = H$ ,

$B$  = background turbulence factor, a function of  $w/H$  determined from Figure 4.1.7.8.,

$$s = \text{size reduction factor calculated as } \frac{\pi}{3} \left[ \frac{1}{1 + \frac{8f_n H}{3V_H}} \right] \left[ \frac{1}{1 + \frac{10f_n W}{V_H}} \right],$$

$F$  = gust energy ratio calculated as  $\frac{x_0^2}{(1+x_0^2)^{4/3}}$ , where  $x_0 = (1\ 220\ f_n/V_H)$ , and

$\beta$  = damping ratio, which shall be determined by a rational method, or may be taken to be 0.01 for steel structures, 0.02 for concrete structures, and 0.015 for composite structures,

where

$f_{nD}$  = natural frequency of vibration of the *building* in the along-wind direction, in Hz,

$f_n$  = lowest natural frequency of the *building*, in Hz, as defined in Sentences 4.1.7.2.(2) and (3),

$H$  = height of the *building*,

$w$  = effective width of windward face of the *building* calculated as  $\frac{\sum h_i w_i}{\sum h_i}$ , where  $w_i$  = width normal to wind direction at height  $h_i$ , and

$V_H$  = mean wind speed at the top of the structure, in m/s, calculated as  $\bar{V} \sqrt{C_{eH}}$ ,

where

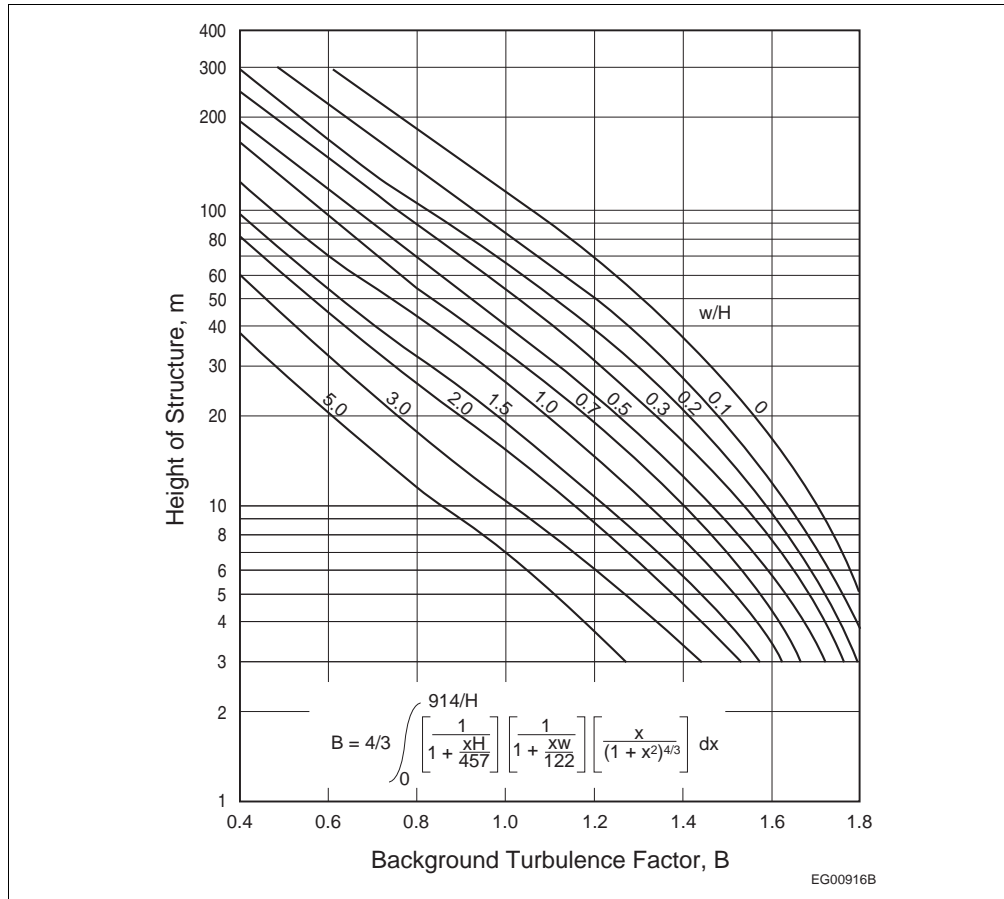
$\bar{V}$  = reference wind speed at a height of 10 m, in m/s, calculated as  $\sqrt{\frac{2 \cdot I_W \cdot q}{\rho} C_{eH}}$ ,

where

$I_W$  = importance factor,

$q$  = reference velocity pressure, in Pa, and  
 $\rho$  = air density = 1.2929 kg/m<sup>3</sup>.  
 (See Note A-4.1.7.8.(4).)

**Figure 4.1.7.8.**  
**Background turbulence factor, B**  
 Forming Part of Sentence 4.1.7.8.(4)



**4.1.7.9. Full and Partial Wind Loading**

**1)** Except where the wind loads are derived from the combined  $C_p C_g$  values determined in accordance with Article 4.1.7.6., *buildings* and structural members shall be capable of withstanding the effects of the following loads:

- a) the full wind loads acting along each of the 2 principal horizontal axes considered separately,
- b) the wind loads described in Clause (a) but with 100% of the load removed from any one portion of the area,
- c) the wind loads described in Clause (a) but with both axes considered simultaneously at 75% of their full value, and
- d) the wind loads described in Clause (c) but with 50% of these loads removed from any portion of the area.

(See Note A-4.1.7.9.(1).)

**4.1.7.10. Interior Walls and Partitions**

**1)** In the design of interior walls and *partitions*, due consideration shall be given to differences in air pressure on opposite sides of the wall or *partition* which may result from

- a) pressure differences between the windward and leeward sides of a *building*,

- b) stack effects due to a difference in air temperature between the exterior and interior of the *building*, and
- c) air pressurization by the mechanical services of the *building*.

#### 4.1.7.11. Exterior Ornamentations, Equipment and Appendages

(See Note A-4.1.7.11.)

**1)** The effects of wind loads on exterior ornamentations, equipment and appendages, including the increase in exposed area as a result of ice buildup as prescribed in CSA S37, "Antennas, Towers, and Antenna-Supporting Structures," shall be considered in the structural design of the connections and the *building*.

**2)** Where there are a number of similar components, the net increase in force is permitted to be based on the total area for all similar components as opposed to the summation of forces of individual elements.

#### 4.1.7.12. Wind Tunnel Procedure

**1)** Except as provided in Sentences (2) and (3), wind tunnel tests on scale models to determine wind loads on *buildings* shall be conducted in accordance with ASCE/SEI 49, "Wind Tunnel Testing for Buildings and Other Structures."

**2)** Where an adjacent *building* provides substantial sheltering effect, the wind loads for the main structural system shall be no lower than 80% of the loads determined from tests referred to in Sentence (1) with the effect of the sheltering *building* removed as applied to

- a) the base shear force for *buildings* with a ratio of height to minimum effective width, as defined in Sentence 4.1.7.2.(2), less than or equal to 1.0, or
- b) the base moment for *buildings* with a ratio of height to minimum effective width greater than 1.0.

**3)** For the design of cladding and secondary structural members, the exterior wind loads determined from the wind tunnel tests shall be no less onerous than those determined by analysis in accordance with Article 4.1.7.3. using the following assumptions:

- a)  $C_p = \pm 0.72$  and  $C_g = 2.5$ , where the *building's* height is greater than 20 m or greater than its minimum effective width, and
- b)  $C_p C_g = 80\%$  of the values for zones w and r provided in Article 4.1.7.6., where the *building's* height is less than or equal to 20 m and no greater than its minimum effective width.

### 4.1.8. Earthquake Load and Effects

#### 4.1.8.1. Analysis

**1)** Except as permitted in Sentence (2), the deflections and specified loading due to earthquake motions shall be determined according to the requirements of Articles 4.1.8.2. to 4.1.8.22.

**2)** Where  $I_E F_s S_a(0.2)$  and  $I_E F_s S_a(2.0)$  are less than 0.16 and 0.03 respectively, the deflections and specified loading due to earthquake motions are permitted to be determined in accordance with Sentences (3) to (15), where

- a)  $I_E$  is the earthquake importance factor and has a value of 0.8, 1.0, 1.3 and 1.5 for *buildings* of Low, Normal, High and Post-Disaster importance respectively,
- b)  $F_s$  is the site coefficient based on the average  $N_{60}$  or  $S_u$ , as defined in Article 4.1.8.2., for the top 30 m of *soil* below the footings, pile caps, or mat *foundations* and has a value of
  - i) 1.0 for *rock* sites or when  $N_{60} > 50$  or  $S_u > 100$  kPa,
  - ii) 1.6 when  $15 \leq N_{60} \leq 50$  or  $50 \text{ kPa} \leq S_u \leq 100$  kPa, and
  - iii) 2.8 for all other cases, and
- c)  $S_a(T)$  is the 5% damped spectral response acceleration value for period T, determined in accordance with Subsection 1.1.3.

- 3)** The structure shall have a clearly defined
- Seismic Force Resisting System (SFRS) to resist the earthquake loads and their effects, and
  - load path (or paths) that will transfer the inertial forces generated by the earthquake to the *foundations* and supporting ground.
- 4)** An unreinforced masonry SFRS shall not be permitted where
- $I_E$  is greater than 1.0, or
  - the height above *grade* is greater than or equal to 30 m.
- 5)** The height above *grade* of SFRS designed in accordance with CSA S136, "North American Specification for the Design of Cold-Formed Steel Structural Members," shall be less than 15 m.
- 6)** Earthquake forces shall be assumed to act horizontally and independently about any two orthogonal axes.
- 7)** The minimum lateral earthquake design force,  $V_s$ , at the base of the structure in the direction under consideration shall be calculated as follows:

$$V_s = F_s S_a(T_s) I_E W_t / R_s$$

where

$S_a(T_s)$  = value of  $S_a$  at  $T_s$  determined by linear interpolation between the value of  $S_a$  at 0.2 s, 0.5 s, and 1.0 s, and  
 =  $S_a(0.2)$  for  $T_s \leq 0.2$  s,

$W_t$  = sum of  $W_i$  over the height of the *building*, where  $W_i$  is defined in Article 4.1.8.2., and

$R_s = 1.5$ , except  $R_s = 1.0$  for structures where the *storey* strength is less than that in the *storey* above and for an unreinforced masonry SFRS,

where

$T_s$  = fundamental lateral period of vibration of the *building*, as defined in Article 4.1.8.2.,

=  $0.085(h_n)^{3/4}$  for steel moment frames,

=  $0.075(h_n)^{3/4}$  for concrete moment frames,

= 0.1 N for other moment frames,

=  $0.025h_n$  for braced frames, and

=  $0.05(h_n)^{3/4}$  for shear walls and other structures,

where

$h_n$  = height above the base, in m, as defined in Article 4.1.8.2.,  
 except that  $V_s$  shall not be less than  $F_s S_a(1.0) I_E W_t / R_s$  and, in cases where  $R_s = 1.5$ ,  $V_s$  need not be greater than  $F_s S_a(0.5) I_E W_t / R_s$ .

- 8)** The total lateral earthquake design force,  $V_s$ , shall be distributed over the height of the *building* in accordance with the following formula:

$$F_x = V_s W_x h_x / \left( \sum_{i=1}^n W_i h_i \right)$$

where

$F_x$  = force applied through the centre of mass at level  $x$ ,

$W_x$   $W_i$  = portion of  $W$  that is located at or is assigned to level  $x$  or  $i$  respectively, and

$h_x$   $h_i$  = height, in m, above the base of level  $x$  and level  $i$  as per Article 4.1.8.2.

- 9)** Accidental torsional effects applied concurrently with  $F_x$  shall be considered by applying torsional moments about the vertical axis at each level for each of the following cases considered separately:

a)  $+0.1D_{nx}F_x$  and

b)  $-0.1D_{nx}F_x$ .

- 10)** Deflections obtained from a linear analysis shall include the effects of torsion and be multiplied by  $R_s/I_E$  to get realistic values of expected deflections.



**11)** The deflections referred to in Sentence (10) shall be used to calculate the largest interstorey deflection, which shall not exceed

- a)  $0.01h_s$  for *post-disaster buildings*,
- b)  $0.02h_s$  for High Importance Category *buildings*, and
- c)  $0.025h_s$  for all other *buildings*,

where  $h_s$  is the interstorey height as defined in Article 4.1.8.2.

**12)** When earthquake forces are calculated using  $R_s = 1.5$ , the following elements in the SFRS shall have their design forces due to earthquake effects increased by 33%:

- a) diaphragms and their chords, connections, struts and collectors,
- b) tie downs in wood or drywall shear walls,
- c) connections and anchor bolts in steel- and wood-braced frames,
- d) connections in precast concrete, and
- e) connections in steel moment frames.

**13)** Except as provided in Sentence (14), where cantilever parapet walls, other cantilever walls, exterior ornamentation and appendages, towers, chimneys or penthouses are connected to or form part of a *building*, they shall be designed, along with their connections, for a lateral force,  $V_{sp}$ , distributed according to the distribution of mass of the element and acting in the lateral direction that results in the most critical loading for design using the following equation:

$$V_{sp} = 0.1F_s I_E W_p$$

where  $W_p$  = weight of a portion of a structure as defined in Article 4.1.8.2.

**14)** The value of  $V_{sp}$  shall be doubled for unreinforced masonry elements.

**15)** Structures designed in accordance with this Article need not comply with the seismic requirements stated in the applicable design standard referenced in Section 4.3.

**4.1.8.2. Notation**

**1)** In this Subsection

- $A_r$  = response amplification factor to account for type of attachment of mechanical/electrical equipment, as defined in Sentence 4.1.8.18.(1),
- $A_x$  = amplification factor at level  $x$  to account for variation of response of mechanical/electrical equipment with elevation within the *building*, as defined in Sentence 4.1.8.18.(1),
- $B_x$  = ratio at level  $x$  used to determine torsional sensitivity, as defined in Sentence 4.1.8.11.(10),
- $B$  = maximum value of  $B_x$ , as defined in Sentence 4.1.8.11.(10),
- $C_p$  = seismic coefficient for mechanical/electrical equipment, as defined in Sentence 4.1.8.18.(1),
- $D_{nx}$  = plan dimension of the *building* at level  $x$  perpendicular to the direction of seismic loading being considered,
- $e_x$  = distance measured perpendicular to the direction of earthquake loading between centre of mass and centre of rigidity at the level being considered (see Note A-4.1.8.2.(1)),
- $F_a$  = site coefficient for application in Subsection 4.1.8., as defined in Sentence 4.1.8.4.(7),
- $F(\text{PGA})$  = site coefficient for PGA, as defined in Sentence 4.1.8.4.(5),
- $F(\text{PGV})$  = site coefficient for PGV, as defined in Sentence 4.1.8.4.(5),
- $F_s$  = site coefficient as defined in Sentence 4.1.8.1.(2) for application in Article 4.1.8.1.,
- $F(\text{T})$  = site coefficient for spectral acceleration, as defined in Sentence 4.1.8.4.(5),
- $F_t$  = portion of  $V$  to be concentrated at the top of the structure, as defined in Sentence 4.1.8.11.(7),
- $F_v$  = site coefficient for application in Subsection 4.1.8., as defined in Sentence 4.1.8.4.(7),
- $F_x$  = lateral force applied to level  $x$ , as defined in Sentence 4.1.8.11.(7),

- $h_i, h_n, h_x$  = the height above the base ( $i = 0$ ) to level  $i, n$ , or  $x$  respectively, where the base of the structure is the level at which horizontal earthquake motions are considered to be imparted to the structure,
- $h_s$  = interstorey height ( $h_i - h_{i-1}$ ),
- $I_E$  = earthquake importance factor of the structure, as described in Sentence 4.1.8.5.(1),
- $J$  = numerical reduction coefficient for base overturning moment, as defined in Sentence 4.1.8.11.(6),
- $J_x$  = numerical reduction coefficient for overturning moment at level  $x$ , as defined in Sentence 4.1.8.11.(8),
- Level  $i$  = any level in the *building*,  $i = 1$  for first level above the base,
- Level  $n$  = level that is uppermost in the main portion of the structure,
- Level  $x$  = level that is under design consideration,
- $M_v$  = factor to account for higher mode effect on base shear, as defined in Sentence 4.1.8.11.(6),
- $M_x$  = overturning moment at level  $x$ , as defined in Sentence 4.1.8.11.(8),
- $N$  = total number of *storeys* above exterior *grade* to level  $n$ ,
- $\bar{N}_{60}$  = Average Standard Penetration Resistance for the top 30 m, corrected to a rod energy efficiency of 60% of the theoretical maximum,
- PGA = Peak Ground Acceleration expressed as a ratio to gravitational acceleration, as defined in Sentence 4.1.8.4.(1),
- $PGA_{ref}$  = reference PGA for determining  $F(T)$ ,  $F(PGA)$  and  $F(PGV)$ , as defined in Sentence 4.1.8.4.(4),
- PGV = Peak Ground Velocity, in m/s, as defined in Sentence 4.1.8.4.(1),
- $PI$  = plasticity index for clays,
- $R_d$  = ductility-related force modification factor reflecting the capability of a structure to dissipate energy through reversed cyclic inelastic behaviour, as given in Article 4.1.8.9.,
- $R_o$  = overstrength-related force modification factor accounting for the dependable portion of reserve strength in a structure designed according to these provisions, as defined in Article 4.1.8.9.,
- $R_s$  = combined overstrength and ductility-related modification factor, as defined in Sentence 4.1.8.1.(7), for application in Article 4.1.8.1.,
- $S_p$  = horizontal force factor for part or portion of a *building* and its anchorage, as given in Sentence 4.1.8.18.(1),
- $S(T)$  = design spectral response acceleration, expressed as a ratio to gravitational acceleration, for a period of  $T$ , as defined in Sentence 4.1.8.4.(9),
- $S_a(T)$  = 5% damped spectral response acceleration, expressed as a ratio to gravitational acceleration, for a period of  $T$ , as defined in Sentence 4.1.8.4.(1),
- SFRS = Seismic Force Resisting System(s) is that part of the structural system that has been considered in the design to provide the required resistance to the earthquake forces and effects defined in Subsection 4.1.8.,
- $s_u$  = average undrained shear strength in the top 30 m of *soil*,
- $T$  = period in seconds,
- $T_a$  = fundamental lateral period of vibration of the *building* or structure, in s, in the direction under consideration, as defined in Sentence 4.1.8.11.(3),
- $T_s$  = fundamental lateral period of vibration of the *building* or structure, in s, in the direction under consideration, as defined in Sentence 4.1.8.1.(7),
- $T_x$  = floor torque at level  $x$ , as defined in Sentence 4.1.8.11.(11),
- TDD = Total Design Displacement of any point in a seismically isolated structure, within or above the isolation system, obtained by calculating the mean + ( $I_E \times$  the standard deviation) of the peak horizontal displacements from all sets of ground motion histories analyzed, but not less than  $\sqrt{I_E} \times$  the mean, where the peak horizontal displacement is based on the vector sum of the two orthogonal horizontal displacements considered for each time step,
- $V$  = lateral earthquake design force at the base of the structure, as determined by Article 4.1.8.11.,
- $V_d$  = lateral earthquake design force at the base of the structure, as determined by Article 4.1.8.12.,

- $V_e$  = lateral earthquake elastic force at the base of the structure, as determined by Article 4.1.8.12.,
- $V_{ed}$  = lateral earthquake design elastic force at the base of the structure, as determined by Article 4.1.8.12.,
- $V_p$  = lateral force on a part of the structure, as determined by Article 4.1.8.18.,
- $V_s$  = lateral earthquake design force at the base of the structure, as determined by Sentence 4.1.8.1.(7), for application in Article 4.1.8.1.,
- $\bar{V}_{s30}$  = average shear wave velocity in the top 30 m of *soil* or *rock*,
- $W$  = *dead load*, as defined in Article 4.1.4.1., except that the minimum *partition* load as defined in Sentence 4.1.4.1.(3) need not exceed 0.5 kPa, plus 25% of the design snow load specified in Subsection 4.1.6., plus 60% of the storage load for areas used for storage, except that *storage garages* need not be considered storage areas, and the full contents of any tanks (see Note A-4.1.8.2.(1)),
- $W_i$ ,  $W_x$  = portion of  $W$  that is located at or is assigned to level  $i$  or  $x$  respectively,
- $W_p$  = weight of a part or portion of a structure, e.g., cladding, *partitions* and appendages,
- $W_t$  = sum of  $W_i$  over the height of the *building*, for application in Sentence 4.1.8.1.(7),
- $\delta_{ave}$  = average displacement of the structure at level  $x$ , as defined in Sentence 4.1.8.11.(10), and
- $\delta_{max}$  = maximum displacement of the structure at level  $x$ , as defined in Sentence 4.1.8.11.(10).

### 4.1.8.3. General Requirements

- 1) The *building* shall be designed to meet the requirements of this Subsection and of the design standards referenced in Section 4.3.
- 2) Structures shall be designed with a clearly defined load path, or paths, that will transfer the inertial forces generated in an earthquake to the supporting ground.
- 3) The structure shall have a clearly defined Seismic Force Resisting System(s) (SFRS), as defined in Article 4.1.8.2.
- 4) The SFRS shall be designed to resist 100% of the earthquake loads and their effects. (See Note A-4.1.8.3.(4).)
- 5) All structural framing elements not considered to be part of the SFRS must be investigated and shown to behave elastically or to have sufficient non-linear capacity to support their gravity loads while undergoing earthquake-induced deformations calculated from the deflections determined in Article 4.1.8.13.
- 6) Stiff elements that are not considered part of the SFRS, such as concrete, masonry, brick or precast walls or panels, shall be
  - a) separated from all structural elements of the *building* such that no interaction takes place as the *building* undergoes deflections due to earthquake effects as calculated in this Subsection, or
  - b) made part of the SFRS and satisfy the requirements of this Subsection. (See Note A-4.1.8.3.(6).)
- 7) Stiffness imparted to the structure from elements not part of the SFRS, other than those described in Sentence (6), shall not be used to resist earthquake deflections but shall be accounted for
  - a) in calculating the period of the structure for determining forces if the added stiffness decreases the fundamental lateral period by more than 15%,
  - b) in determining the irregularity of the structure, except the additional stiffness shall not be used to make an irregular SFRS regular or to reduce the effects of torsion (see Note A-4.1.8.3.(7)(b) and (c)), and
  - c) in designing the SFRS if inclusion of the elements not part of the SFRS in the analysis has an adverse effect on the SFRS (see Note A-4.1.8.3.(7)(b) and (c)).
- 8) Structural modelling shall be representative of the magnitude and spatial distribution of the mass of the *building* and of the stiffness of all elements of the SFRS,

including stiff elements that are not separated in accordance with Sentence 4.1.8.3.(6), and shall account for

- a) the effect of cracked sections in reinforced concrete and reinforced masonry elements,
- b) the effect of the finite size of members and joints,
- c) sway effects arising from the interaction of gravity loads with the displaced configuration of the structure, and
- d) other effects that influence the lateral stiffness of the *building*.

(See Note A-4.1.8.3.(8).)

**4.1.8.4. Site Properties**

**1)** The peak ground acceleration (PGA), peak ground velocity (PGV), and the 5% damped spectral response acceleration values,  $S_a(T)$ , for the reference ground conditions (Site Class C in Table 4.1.8.4.-A) for periods T of 0.2 s, 0.5 s, 1.0 s, 2.0 s, 5.0 s and 10.0 s shall be determined in accordance with Subsection 1.1.3. and are based on a 2% probability of exceedance in 50 years.

**Table 4.1.8.4.-A**  
**Site Classification for Seismic Site Response**  
 Forming Part of Sentences 4.1.8.4.(1) to (3)

Site Class	Ground Profile Name	Average Properties in Top 30 m, as per Note A-4.1.8.4.(3) and Table 4.1.8.4.-A		
		Average Shear Wave Velocity, $\bar{V}_{s30}$ , m/s	Average Standard Penetration Resistance, $\bar{N}_{60}$	Soil Undrained Shear Strength, $s_u$
A	Hard rock <sup>(1)(2)</sup>	$\bar{V}_{s30} > 1500$	n/a	n/a
B	Rock <sup>(1)</sup>	$760 < \bar{V}_{s30} \leq 1500$	n/a	n/a
C	Very dense soil and soft rock	$360 < \bar{V}_{s30} < 760$	$\bar{N}_{60} > 50$	$s_u > 100$ kPa
D	Stiff soil	$180 < \bar{V}_{s30} < 360$	$15 \leq \bar{N}_{60} \leq 50$	$50$ kPa $< s_u \leq 100$ kPa
E	Soft soil	$\bar{V}_{s30} < 180$	$\bar{N}_{60} < 15$	$s_u < 50$ kPa
		Any profile with more than 3 m of soil with the following characteristics: <ul style="list-style-type: none"> <li>• plasticity index: <math>PI &gt; 20</math></li> <li>• moisture content: <math>w \geq 40\%</math>, and</li> <li>• undrained shear strength: <math>s_u &lt; 25</math> kPa</li> </ul>		
F	Other soils <sup>(3)</sup>	Site-specific evaluation required		

**Notes to Table 4.1.8.4.-A:**

- (1) Site Classes A and B, hard rock and rock, are not to be used if there is more than 3 m of softer materials between the rock and the underside of footing or mat foundations. The appropriate Site Class for such cases is determined on the basis of the average properties of the total thickness of the softer materials (see Note A-4.1.8.4.(3) and Table 4.1.8.4.-A).
- (2) Where  $\bar{V}_{s30}$  has been measured in-situ, the F(T) values for Site Class A derived from Tables 4.1.8.4.-B to 4.1.8.4.-G are permitted to be multiplied by the factor  $0.04 + (1500/\bar{V}_{s30})^{0.2}$ .
- (3) Other soils include:
  - (a) liquefiable soils, quick and highly sensitive clays, collapsible weakly cemented soils, and other soils susceptible to failure or collapse under seismic loading,
  - (b) peat and/or highly organic clays greater than 3 m in thickness,
  - (c) highly plastic clays ( $PI > 75$ ) more than 8 m thick, and
  - (d) soft to medium stiff clays more than 30 m thick.

**2)** Site classifications for ground shall conform to Table 4.1.8.4.-A and shall be determined using  $\bar{V}_{s30}$ , or where  $\bar{V}_{s30}$  is not known, using Sentence (3).

**3)** If average shear wave velocity,  $\bar{V}_{s30}$ , is not known, Site Class shall be determined from energy-corrected Average Standard Penetration Resistance,  $\bar{N}_{60}$ , or from soil average undrained shear strength,  $s_u$ , as noted in Table 4.1.8.4.-A,  $\bar{N}_{60}$  and  $s_u$  being calculated based on rational analysis. (See Note A-4.1.8.4.(3) and Table 4.1.8.4.-A.)

**4)** For the purpose of determining the values of  $F(T)$  to be used in the calculation of design spectral acceleration,  $S(T)$ , in Sentence (9), and the values of  $F(PGA)$  and  $F(PGV)$ , the value of  $PGA_{ref}$  to be used with Tables 4.1.8.4.-B to 4.1.8.4.-I shall be taken as

- a)  $0.8 PGA$ , where the ratio  $S_a(0.2)/PGA < 2.0$ , and
- b)  $PGA$ , otherwise.

**5)** The values of the site coefficient for design spectral acceleration at period  $T$ ,  $F(T)$ , and of similar coefficients  $F(PGA)$  and  $F(PGV)$  shall conform to Tables 4.1.8.4.-B to 4.1.8.4.-I using linear interpolation for intermediate values of  $PGA_{ref}$ .

**6)** Site-specific evaluation is required to determine  $F(T)$ ,  $F(PGA)$  and  $F(PGV)$  for Site Class F. (See Note A-4.1.8.4.(3) and Table 4.1.8.4.-A.)

**7)** For all applications in Subsection 4.1.8.,  $F_a = F(0.2)$  and  $F_v = F(1.0)$ .

**8)** For structures with a fundamental period of vibration equal to or less than 0.5 s that are built on liquefiable soils, Site Class and the corresponding values of  $F(T)$  may be determined as described in Tables 4.1.8.4.-A, 4.1.8.4.-B, and 4.1.8.4.-C by assuming that the soils are not liquefiable. (See Note A-4.1.8.4.(3) and Table 4.1.8.4.-A.)

**9)** The design spectral acceleration values of  $S(T)$  shall be determined as follows, using linear interpolation for intermediate values of  $T$ :

$$S(T) = F(0.2)S_a(0.2) \text{ or } F(0.5)S_a(0.5), \text{ whichever is larger, for } T \leq 0.2 \text{ s}$$

$$= F(0.5)S_a(0.5) \text{ for } T = 0.5 \text{ s}$$

$$= F(1.0)S_a(1.0) \text{ for } T = 1.0 \text{ s}$$

$$= F(2.0)S_a(2.0) \text{ for } T = 2.0 \text{ s}$$

$$= F(5.0)S_a(5.0) \text{ for } T = 5.0 \text{ s}$$

$$= F(10.0)S_a(10.0) \text{ for } T \geq 10.0 \text{ s}$$

**Table 4.1.8.4.-B**  
**Values of  $F(0.2)$  as a Function of Site Class and  $PGA_{ref}$**   
 Forming Part of Sentences 4.1.8.4.(4) and (5)

Site Class	Values of $F(0.2)$				
	$PGA_{ref} \leq 0.1$	$PGA_{ref} = 0.2$	$PGA_{ref} = 0.3$	$PGA_{ref} = 0.4$	$PGA_{ref} \geq 0.5$
A	0.69	0.69	0.69	0.69	0.69
B	0.77	0.77	0.77	0.77	0.77
C	1.00	1.00	1.00	1.00	1.00
D	1.24	1.09	1.00	0.94	0.90
E	1.64	1.24	1.05	0.93	0.85
F	(1)	(1)	(1)	(1)	(1)

**Notes to Table 4.1.8.4.-B:**

(1) See Sentence 4.1.8.4.(6).

**Table 4.1.8.4.-C**  
**Values of  $F(0.5)$  as a Function of Site Class and  $PGA_{ref}$**   
 Forming Part of Sentences 4.1.8.4.(4) and (5)

Site Class	Values of $F(0.5)$				
	$PGA_{ref} \leq 0.1$	$PGA_{ref} = 0.2$	$PGA_{ref} = 0.3$	$PGA_{ref} = 0.4$	$PGA_{ref} \geq 0.5$
A	0.57	0.57	0.57	0.57	0.57
B	0.65	0.65	0.65	0.65	0.65
C	1.00	1.00	1.00	1.00	1.00
D	1.47	1.30	1.20	1.14	1.10
E	2.47	1.80	1.48	1.30	1.17
F	(1)	(1)	(1)	(1)	(1)

**Notes to Table 4.1.8.4.-C:**

(1) See Sentence 4.1.8.4.(6).

**Table 4.1.8.4-D**  
**Values of F(1.0) as a Function of Site Class and  $PGA_{ref}$**   
 Forming Part of Sentences 4.1.8.4.(4) and (5)

Site Class	Values of F(1.0)				
	$PGA_{ref} \leq 0.1$	$PGA_{ref} = 0.2$	$PGA_{ref} = 0.3$	$PGA_{ref} = 0.4$	$PGA_{ref} \geq 0.5$
A	0.57	0.57	0.57	0.57	0.57
B	0.63	0.63	0.63	0.63	0.63
C	1.00	1.00	1.00	1.00	1.00
D	1.55	1.39	1.31	1.25	1.21
E	2.81	2.08	1.74	1.53	1.39
F	(1)	(1)	(1)	(1)	(1)

**Notes to Table 4.1.8.4-D:**

(1) See Sentence 4.1.8.4.(6).

**Table 4.1.8.4-E**  
**Values of F(2.0) as a Function of Site Class and  $PGA_{ref}$**   
 Forming Part of Sentences 4.1.8.4.(4) and (5)

Site Class	Values of F(2.0)				
	$PGA_{ref} \leq 0.1$	$PGA_{ref} = 0.2$	$PGA_{ref} = 0.3$	$PGA_{ref} = 0.4$	$PGA_{ref} \geq 0.5$
A	0.58	0.58	0.58	0.58	0.58
B	0.63	0.63	0.63	0.63	0.63
C	1.00	1.00	1.00	1.00	1.00
D	1.57	1.44	1.36	1.31	1.27
E	2.90	2.24	1.92	1.72	1.58
F	(1)	(1)	(1)	(1)	(1)

**Notes to Table 4.1.8.4-E:**

(1) See Sentence 4.1.8.4.(6).

**Table 4.1.8.4-F**  
**Values of F(5.0) as a Function of Site Class and  $PGA_{ref}$**   
 Forming Part of Sentences 4.1.8.4.(4) and (5)

Site Class	Values of F(5.0)				
	$PGA_{ref} \leq 0.1$	$PGA_{ref} = 0.2$	$PGA_{ref} = 0.3$	$PGA_{ref} = 0.4$	$PGA_{ref} \geq 0.5$
A	0.61	0.61	0.61	0.61	0.61
B	0.64	0.64	0.64	0.64	0.64
C	1.00	1.00	1.00	1.00	1.00
D	1.58	1.48	1.41	1.37	1.34
E	2.93	2.40	2.14	1.96	1.84
F	(1)	(1)	(1)	(1)	(1)

**Notes to Table 4.1.8.4-F:**

(1) See Sentence 4.1.8.4.(6).

**Table 4.1.8.4-G**  
**Values of F(10.0) as a Function of Site Class and  $PGA_{ref}$**   
 Forming Part of Sentences 4.1.8.4.(4) and (5)

Site Class	Values of F(10.0)				
	$PGA_{ref} \leq 0.1$	$PGA_{ref} = 0.2$	$PGA_{ref} = 0.3$	$PGA_{ref} = 0.4$	$PGA_{ref} \geq 0.5$
A	0.67	0.67	0.67	0.67	0.67
B	0.69	0.69	0.69	0.69	0.69
C	1.00	1.00	1.00	1.00	1.00
D	1.49	1.41	1.37	1.34	1.31
E	2.52	2.18	2.00	1.88	1.79
F	(1)	(1)	(1)	(1)	(1)

**Notes to Table 4.1.8.4-G:**

(1) See Sentence 4.1.8.4.(6).

**Table 4.1.8.4-H**  
**Values of F(PGA) as a Function of Site Class and  $PGA_{ref}$**   
 Forming Part of Sentences 4.1.8.4.(4) and (5)

Site Class	Values of F(PGA)				
	$PGA_{ref} \leq 0.1$	$PGA_{ref} = 0.2$	$PGA_{ref} = 0.3$	$PGA_{ref} = 0.4$	$PGA_{ref} \geq 0.5$
A	0.90	0.90	0.90	0.90	0.90
B	0.87	0.87	0.87	0.87	0.87
C	1.00	1.00	1.00	1.00	1.00
D	1.29	1.10	0.99	0.93	0.88
E	1.81	1.23	0.98	0.83	0.74
F	(1)	(1)	(1)	(1)	(1)

**Notes to Table 4.1.8.4-H:**

(1) See Sentence 4.1.8.4.(6).

**Table 4.1.8.4-I**  
**Values of F(PGV) as a Function of Site Class and  $PGA_{ref}$**   
 Forming Part of Sentences 4.1.8.4.(4) and (5)

Site Class	Values of F(PGV)				
	$PGA_{ref} \leq 0.1$	$PGA_{ref} = 0.2$	$PGA_{ref} = 0.3$	$PGA_{ref} = 0.4$	$PGA_{ref} \geq 0.5$
A	0.62	0.62	0.62	0.62	0.62
B	0.67	0.67	0.67	0.67	0.67
C	1.00	1.00	1.00	1.00	1.00
D	1.47	1.30	1.20	1.14	1.10
E	2.47	1.80	1.48	1.30	1.17
F	(1)	(1)	(1)	(1)	(1)

**Notes to Table 4.1.8.4-I:**

(1) See Sentence 4.1.8.4.(6).

**4.1.8.5. Importance Factor**

1) The earthquake importance factor,  $I_E$ , shall be determined according to Table 4.1.8.5.

**Table 4.1.8.5.**  
**Importance Factor for Earthquake Loads and Effects,  $I_E$**   
Forming Part of Sentence 4.1.8.5.(1)

Importance Category	Importance Factor, $I_E$	
	ULS	SLS <sup>(1)</sup>
Low	0.8	
Normal	1.0	(2)
High	1.3	
Post-disaster	1.5	

**Notes to Table 4.1.8.5.:**

(1) See Article 4.1.8.13.

(2) See Note A-Table 4.1.8.5.

**4.1.8.6. Structural Configuration**

1) Structures having any of the features listed in Table 4.1.8.6. shall be designated irregular.

2) Structures not classified as irregular according to Sentence 4.1.8.6.(1) may be considered regular.

3) Except as required by Article 4.1.8.10., in cases where  $I_E F_a S_a(0.2)$  is equal to or greater than 0.35, structures designated as irregular must satisfy the provisions referenced in Table 4.1.8.6.

**Table 4.1.8.6.**  
**Structural Irregularities<sup>(1)</sup>**  
Forming Part of Sentence 4.1.8.6.(1)

Type	Irregularity Type and Definition	Notes
1	<b>Vertical Stiffness Irregularity</b> Vertical stiffness irregularity shall be considered to exist when the lateral stiffness of the SFRS in a <i>storey</i> is less than 70% of the stiffness of any adjacent <i>storey</i> , or less than 80% of the average stiffness of the three <i>storeys</i> above or below.	(2)(3)(4)
2	<b>Weight (mass) Irregularity</b> Weight irregularity shall be considered to exist where the weight, $W_i$ , of any <i>storey</i> is more than 150% of the weight of an adjacent <i>storey</i> . A roof that is lighter than the floor below need not be considered.	(2)
3	<b>Vertical Geometric Irregularity</b> Vertical geometric irregularity shall be considered to exist where the horizontal dimension of the SFRS in any <i>storey</i> is more than 130% of that in an adjacent <i>storey</i> .	(2)(3)(4)(5)
4	<b>In-Plane Discontinuity in Vertical Lateral-Force-Resisting Element</b> Except for braced frames and moment-resisting frames, an in-plane discontinuity shall be considered to exist where there is an offset of a lateral-force-resisting element of the SFRS or a reduction in lateral stiffness of the resisting element in the <i>storey</i> below.	(2)(3)(4)(5)
5	<b>Out-of-Plane Offsets</b> Discontinuities in a lateral force path, such as out-of-plane offsets of the vertical elements of the SFRS.	(2)(3)(4)(5)
6	<b>Discontinuity in Capacity - Weak Storey</b> A weak <i>storey</i> is one in which the <i>storey</i> shear strength is less than that in the <i>storey</i> above. The <i>storey</i> shear strength is the total strength of all seismic-resisting elements of the SFRS sharing the <i>storey</i> shear for the direction under consideration.	(2)(3)



Table 4.1.8.6. (Continued)

Type	Irregularity Type and Definition	Notes
7	<b>Torsional Sensitivity (to be considered when diaphragms are not flexible)</b> Torsional sensitivity shall be considered to exist when the ratio B calculated according to Sentence 4.1.8.11.(10) exceeds 1.7.	(2)(3)(4)(6)
8	<b>Non-orthogonal Systems</b> A non-orthogonal system irregularity shall be considered to exist when the SFRS is not oriented along a set of orthogonal axes.	(2)(4)(7)
9	<b>Gravity-Induced Lateral Demand Irregularity</b> Gravity-induced lateral demand irregularity on the SFRS shall be considered to exist where the ratio, $\alpha$ , calculated in accordance with Sentence 4.1.8.10.(5), exceeds 0.1 for an SFRS with self-centering characteristics and 0.03 for other systems.	(2)(3)(4)(7)

**Notes to Table 4.1.8.6.:**

- (1) One-storey penthouses with a weight of less than 10% of the level below need not be considered in the application of this Table.
- (2) See Article 4.1.8.7.
- (3) See Article 4.1.8.10.
- (4) See Note A-Table 4.1.8.6.
- (5) See Article 4.1.8.15.
- (6) See Sentences 4.1.8.11.(10), (11) and 4.1.8.12.(4).
- (7) See Article 4.1.8.8.

**4.1.8.7. Methods of Analysis**

1) Analysis for design earthquake actions shall be carried out in accordance with the Dynamic Analysis Procedure described in Article 4.1.8.12. (see Note A-4.1.8.7.(1)), except that the Equivalent Static Force Procedure described in Article 4.1.8.11. may be used for structures that meet any of the following criteria:

- a) in cases where  $I_E F_a S_a(0.2)$  is less than 0.35,
- b) regular structures that are less than 60 m in height and have a fundamental lateral period,  $T_{av}$  less than 2 s in each of two orthogonal directions as defined in Article 4.1.8.8., or
- c) structures with structural irregularity, of Type 1, 2, 3, 4, 5, 6 or 8 as defined in Table 4.1.8.6., that are less than 20 m in height and have a fundamental lateral period,  $T_{av}$  less than 0.5 s in each of two orthogonal directions as defined in Article 4.1.8.8.

**4.1.8.8. Direction of Loading**

1) Earthquake forces shall be assumed to act in any horizontal direction, except that the following shall be considered to provide adequate design force levels in the structure:

- a) where components of the SFRS are oriented along a set of orthogonal axes, independent analyses about each of the principal axes of the structure shall be performed,
- b) where the components of the SFRS are not oriented along a set of orthogonal axes and  $I_E F_a S_a(0.2)$  is less than 0.35, independent analyses about any two orthogonal axes is permitted, or
- c) where the components of the SFRS are not oriented along a set of orthogonal axes and  $I_E F_a S_a(0.2)$  is equal to or greater than 0.35, analysis of the structure independently in any two orthogonal directions for 100% of the prescribed earthquake loads applied in one direction plus 30% of the prescribed earthquake loads in the perpendicular direction, with the combination requiring the greater element strength being used in the design.

**4.1.8.9. SFRS Force Reduction Factors, System Overstrength Factors, and General Restrictions**

- 1) Except as provided in Sentence 4.1.8.20.(7), the values of  $R_d$  and  $R_o$  and the corresponding system restrictions shall conform to Table 4.1.8.9. and the requirements of this Subsection.
- 2) When a particular value of  $R_d$  is required by this Article, the corresponding  $R_o$  shall be used.
- 3) For combinations of different types of SFRS acting in the same direction in the same storey,  $R_d R_o$  shall be taken as the lowest value of  $R_d R_o$  corresponding to these systems.
- 4) For vertical variations of  $R_d R_o$ , excluding rooftop structures not exceeding two storeys in height whose weight is less than the greater of 10% of  $W$  and 30% of  $W_i$  of the level below, the value of  $R_d R_o$  used in the design of any storey shall be less than or equal to the lowest value of  $R_d R_o$  used in the given direction for the storeys above, and the requirements of Sentence 4.1.8.15.(6) must be satisfied. (See Note A-4.1.8.9.(4).)
- 5) If it can be demonstrated through testing, research and analysis that the seismic performance of a structural system is at least equivalent to one of the types of SFRS mentioned in Table 4.1.8.9., then such a structural system will qualify for values of  $R_d$  and  $R_o$  corresponding to the equivalent type in that Table. (See Note A-4.1.8.9.(5).)

**Table 4.1.8.9.**  
**SFRS Ductility-Related Force Modification Factors,  $R_d$ , Overstrength-Related Force Modification Factors,  $R_o$ , and General Restrictions<sup>(1)</sup>**  
 Forming Part of Sentence 4.1.8.9.(1)

Type of SFRS	$R_d$	$R_o$	Restrictions <sup>(2)</sup>				
			Cases Where $I_e F_a S_a(0.2)$				Cases Where $I_e F_v S_a(1.0)$
			< 0.2	$\geq 0.2$ to < 0.35	$\geq 0.35$ to $\leq 0.75$	> 0.75	> 0.3
Steel Structures Designed and Detailed According to CSA S16 <sup>(3)(4)</sup>							
Ductile moment-resisting frames	5.0	1.5	NL	NL	NL	NL	NL
Moderately ductile moment-resisting frames	3.5	1.5	NL	NL	NL	NL	NL
Limited ductility moment-resisting frames	2.0	1.3	NL	NL	60	30	30
Moderately ductile concentrically braced frames							
Tension-compression braces	3.0	1.3	NL	NL	40	40	40
Tension only braces	3.0	1.3	NL	NL	20	20	20
Limited ductility concentrically braced frames							
Tension-compression braces	2.0	1.3	NL	NL	60	60	60
Tension only braces	2.0	1.3	NL	NL	40	40	40
Ductile buckling-restrained braced frames	4.0	1.2	NL	NL	40	40	40
Ductile eccentrically braced frames	4.0	1.5	NL	NL	NL	NL	NL
Ductile plate walls	5.0	1.6	NL	NL	NL	NL	NL
Limited ductility plate walls	2.0	1.5	NL	NL	60	60	60
Conventional construction of moment-resisting frames, braced frames or plate walls							
<i>Assembly occupancies</i>	1.5	1.3	NL	NL	15	15	15
<i>Other occupancies</i>	1.5	1.3	NL	NL	60	40	40
Other steel SFRS(s) not defined above	1.0	1.0	15	15	NP	NP	NP

**Table 4.1.8.9. (Continued)**

Type of SFRS	$R_d$	$R_o$	Restrictions <sup>(2)</sup>				
			Cases Where $I_e F_a S_a(0.2)$				Cases Where $I_e F_v S_a(1.0)$
			< 0.2	$\geq 0.2$ to < 0.35	$\geq 0.35$ to $\leq 0.75$	> 0.75	> 0.3
<b>Concrete Structures Designed and Detailed According to CSA A23.3</b>							
Ductile moment-resisting frames	4.0	1.7	NL	NL	NL	NL	NL
Moderately ductile moment-resisting frames	2.5	1.4	NL	NL	60	40	40
Ductile coupled walls	4.0	1.7	NL	NL	NL	NL	NL
Moderately ductile coupled walls	2.5	1.4	NL	NL	NL	60	60
Ductile partially coupled walls	3.5	1.7	NL	NL	NL	NL	NL
Moderately ductile partially coupled walls	2.0	1.4	NL	NL	NL	60	60
Ductile shear walls	3.5	1.6	NL	NL	NL	NL	NL
Moderately ductile shear walls	2.0	1.4	NL	NL	NL	60	60
Conventional construction							
Moment-resisting frames	1.5	1.3	NL	NL	20	15	10 <sup>(5)</sup>
Shear walls	1.5	1.3	NL	NL	40	30	30
Two-way slabs without beams	1.3	1.3	20	15	NP	NP	NP
Tilt-up construction							
Moderately ductile walls and frames	2.0	1.3	30	25	25	25	25
Limited ductility walls and frames	1.5	1.3	30	25	20	20	20 <sup>(6)</sup>
Conventional walls and frames	1.3	1.3	25	20	NP	NP	NP
Other concrete SFRS(s) not listed above	1.0	1.0	15	15	NP	NP	NP
<b>Timber Structures Designed and Detailed According to CSA O86</b>							
Shear walls							
Nailed shear walls: wood-based panel	3.0	1.7	NL	NL	30	20	20
Shear walls: wood-based and gypsum panels in combination	2.0	1.7	NL	NL	20	20	20
Braced or moment-resisting frames with ductile connections							
Moderately ductile	2.0	1.5	NL	NL	20	20	20
Limited ductility	1.5	1.5	NL	NL	15	15	15
Other wood- or gypsum-based SFRS(s) not listed above	1.0	1.0	15	15	NP	NP	NP
<b>Masonry Structures Designed and Detailed According to CSA S304</b>							
Ductile shear walls	3.0	1.5	NL	NL	60	40	40
Moderately ductile shear walls	2.0	1.5	NL	NL	60	40	40
Conventional construction							
Shear walls	1.5	1.5	NL	60	30	15	15
Moment-resisting frames	1.5	1.5	NL	30	NP	NP	NP
Unreinforced masonry	1.0	1.0	30	15	NP	NP	NP
Other masonry SFRS(s) not listed above	1.0	1.0	15	NP	NP	NP	NP

Table 4.1.8.9. (Continued)

Type of SFRS	$R_d$	$R_o$	Restrictions <sup>(2)</sup>				
			Cases Where $I_E F_a S_a(0.2)$				Cases Where $I_E F_v S_a(1.0)$
			< 0.2	$\geq 0.2$ to < 0.35	$\geq 0.35$ to $\leq 0.75$	> 0.75	> 0.3
Cold-Formed Steel Structures Designed and Detailed According to CSA S136							
Shear walls							
Screw-connected shear walls – wood-based panels	2.5	1.7	20	20	20	20	20
Screw-connected shear walls – wood-based and gypsum panels in combination	1.5	1.7	20	20	20	20	20
Diagonal strap concentrically braced walls							
Limited ductility	1.9	1.3	20	20	20	20	20
Conventional construction	1.2	1.3	15	15	NP	NP	NP
Other cold-formed SFRS(s) not defined above	1.0	1.0	15	15	NP	NP	NP

**Notes to Table 4.1.8.9.:**

- (1) See Article 4.1.8.10.
- (2) NP = system is not permitted.  
 NL = system is permitted and not limited in height as an SFRS.  
 Numbers in this Table are maximum height limits above *grade*, in m.  
 Height may be limited in other Parts of the Code.  
 The most stringent requirement governs.
- (3) Higher design force levels are prescribed in CSA S16 for some heights of *buildings*.
- (4) See Note A-Table 4.1.8.9.
- (5) Frames limited to a maximum of 2 *storeys*.
- (6) Frames limited to a maximum of 3 *storeys*.

**4.1.8.10. Additional System Restrictions**

**1)** Except as required by Clause (2)(b), structures with a Type 6 irregularity, Discontinuity in Capacity - Weak Storey, as described in Table 4.1.8.6., are not permitted unless  $I_E F_a S_a(0.2)$  is less than 0.2 and the forces used for design of the SFRS are multiplied by  $R_d R_o$ .

**2)** *Post-disaster buildings* shall

- not have any irregularities conforming to Types 1, 3, 4, 5, 7 and 9 as described in Table 4.1.8.6., in cases where  $I_E F_a S_a(0.2)$  is equal to or greater than 0.35,
- not have a Type 6 irregularity as described in Table 4.1.8.6.,
- have an SFRS with an  $R_d$  of 2.0 or greater, and
- have no *storey* with a lateral stiffness that is less than that of the *storey* above it.

**3)** For *buildings* having fundamental lateral periods,  $T_{av}$ , of 1.0 s or greater, and where  $I_E F_v S_a(1.0)$  is greater than 0.25, shear walls that are other than wood-based and form part of the SFRS shall be continuous from their top to the *foundation* and shall not have irregularities of Type 4 or 5 as described in Table 4.1.8.6.

**4)** For *buildings* constructed with more than 4 *storeys* of continuous wood construction and where  $I_E F_a S_a(0.2)$  is equal to or greater than 0.35, timber SFRS consisting of shear walls with wood-based panels or of braced or moment-resisting frames as defined in Table 4.1.8.9. within the continuous wood construction shall not have Type 4 or Type 5 irregularities as described in Table 4.1.8.6. (See Note A-4.1.8.10.(4).)

**5)** The ratio,  $\alpha$ , for a Type 9 irregularity as described in Table 4.1.8.6. shall be determined independently for each orthogonal direction using the following equation:

$$\alpha = Q_G/Q_y$$

where

$Q_G$  = gravity-induced lateral demand on the SFRS at the critical level of the yielding system, and

$Q_y$  = the resistance of the yielding mechanism required to resist the minimum earthquake loads, which need not be taken as less than  $R_o$ , multiplied by the minimum lateral earthquake force as determined in Article 4.1.8.11. or 4.1.8.12., as appropriate.

(See Note A-4.1.8.10.(5).)

**6)** For *buildings* with a Type 9 irregularity as described in Table 4.1.8.6. and where  $I_E F_a S_a(0.2)$  is equal to or greater than 0.5, deflections determined in accordance with Article 4.1.8.13. shall be multiplied by 1.2.

**7)** Structures where the value of  $\alpha$ , as determined in accordance with Sentence (5), exceeds twice the limits specified in Table 4.1.8.6. for a Type 9 irregularity, and where  $I_E F_a S_a(0.2)$  is equal to or greater than 0.5 are not permitted unless determined to be acceptable based on non-linear dynamic analysis studies. (See Note A-4.1.8.10.(7).)

**4.1.8.11. Equivalent Static Force Procedure for Structures Satisfying the Conditions of Article 4.1.8.7.**

**1)** The static loading due to earthquake motion shall be determined according to the procedures given in this Article.

**2)** Except as provided in Sentence (12), the minimum lateral earthquake force,  $V$ , shall be calculated using the following formula:

$$V = S(T_a) M_v I_E W / (R_d R_o)$$

except

a) for walls, coupled walls and wall-frame systems,  $V$  shall not be less than

$$S(4.0) M_v I_E W / (R_d R_o)$$

b) for moment-resisting frames, braced frames, and other systems,  $V$  shall not be less than

$$S(2.0) M_v I_E W / (R_d R_o)$$

c) for *buildings* located on a site other than Class F and having an SFRS with an  $R_d$  equal to or greater than 1.5,  $V$  need not be greater than the larger of

$$\frac{2}{3} S(0.2) I_E W / (R_d R_o) \text{ and}$$

$$S(0.5) I_E W / (R_d R_o)$$

**3)** Except as provided in Sentence (4), the fundamental lateral period,  $T_a$ , in the direction under consideration in Sentence (2), shall be determined as:

a) for moment-resisting frames that resist 100% of the required lateral forces and where the frame is not enclosed by or adjoined by more rigid elements that would tend to prevent the frame from resisting lateral forces, and where  $h_n$  is in metres:

i)  $0.085 (h_n)^{3/4}$  for steel moment frames,

- ii)  $0.075 (h_n)^{3/4}$  for concrete moment frames, or
- iii)  $0.1 N$  for other moment frames,
- b)  $0.025h_n$  for braced frames where  $h_n$  is in metres,
- c)  $0.05 (h_n)^{3/4}$  for shear wall and other structures where  $h_n$  is in metres, or
- d) other established methods of mechanics using a structural model that complies with the requirements of Sentence 4.1.8.3.(8), except that
  - i) for moment-resisting frames,  $T_a$  shall not be taken greater than 1.5 times that determined in Clause (a),
  - ii) for braced frames,  $T_a$  shall not be taken greater than 2.0 times that determined in Clause (b),
  - iii) for shear wall structures,  $T_a$  shall not be taken greater than 2.0 times that determined in Clause (c),
  - iv) for other structures,  $T_a$  shall not be taken greater than that determined in Clause (c), and
  - v) for the purpose of calculating the deflections, the period without the upper limit specified in Subclauses (d)(i) to (d)(iv) may be used, except that, for walls, coupled walls and wall-frame systems,  $T_a$  shall not exceed 4.0 s, and for moment-resisting frames, braced frames, and other systems,  $T_a$  shall not exceed 2.0 s.

(See Note A-4.1.8.11.(3).)

**4)** For single-storey buildings with steel deck or wood roof diaphragms, the fundamental lateral period,  $T_{av}$  in the direction under consideration is permitted to be taken as

- a)  $0.05 (h_n)^{3/4} + 0.004 L$  for shear walls,
- b)  $0.035 h_n + 0.004 L$  for steel moment frames and steel braced frames, or
- c) the value obtained from methods of mechanics using a structural model that complies with the requirements of Sentence 4.1.8.3.(8), except that  $T_a$  shall not be greater than 1.5 times the value determined in Clause (a) or (b), as applicable,

where  $L$  is the shortest length of the diaphragm, in m, between adjacent vertical elements of the SFRS in the direction perpendicular to the direction under consideration.

**5)** The weight,  $W$ , of the building shall be calculated using the following formula:

$$W = \sum_{i=1}^n W_i$$

**6)** The higher mode factor,  $M_{vr}$  and its associated base overturning moment reduction factor,  $J$ , shall conform to Table 4.1.8.11.

**7)** The total lateral seismic force,  $V$ , shall be distributed such that a portion,  $F_t$ , shall be assumed to be concentrated at the top of the building, where  $F_t$  is equal to  $0.07 T_a V$  but need not exceed  $0.25 V$  and may be considered as zero where the fundamental lateral period,  $T_{av}$  does not exceed  $0.7$  s; the remainder,  $V - F_t$ , shall be distributed along the height of the building, including the top level, in accordance with the following formula:

$$F_x = (V - F_t) W_x h_x / \left( \sum_{i=1}^n W_i h_i \right)$$

**Table 4.1.8.11.**  
**Higher Mode Factor,  $M_v$ , and Base Overturning Reduction Factor,  $J^{(1)(2)(3)(4)}$**   
 Forming Part of Sentence 4.1.8.11.(6)

S(0.2)/S(5.0)	$M_v$ for $T_a \leq 0.5$	$M_v$ for $T_a = 1.0$	$M_v$ for $T_a = 2.0$	$M_v$ for $T_a \geq 5.0$	J for $T_a \leq 0.5$	J for $T_a = 1.0$	J for $T_a = 2.0$	J for $T_a \geq 5.0$
<b>Moment-Resisting Frames</b>								
5	1	1	1	<sup>(5)</sup>	1	0.97	0.92	<sup>(5)</sup>
20	1	1	1	<sup>(5)</sup>	1	0.93	0.85	<sup>(5)</sup>
40	1	1	1	<sup>(5)</sup>	1	0.87	0.78	<sup>(5)</sup>
65	1	1	1.03	<sup>(5)</sup>	1	0.80	0.70	<sup>(5)</sup>
<b>Coupled Walls<sup>(6)</sup></b>								
5	1	1	1	1 <sup>(7)</sup>	1	0.97	0.92	0.80 <sup>(8)</sup>
20	1	1	1	1.08 <sup>(7)</sup>	1	0.93	0.85	0.65 <sup>(8)</sup>
40	1	1	1	1.30 <sup>(7)</sup>	1	0.87	0.78	0.53 <sup>(8)</sup>
65	1	1	1.03	1.49 <sup>(7)</sup>	1	0.80	0.70	0.46 <sup>(8)</sup>
<b>Braced Frames</b>								
5	1	1	1	<sup>(5)</sup>	1	0.95	0.89	<sup>(5)</sup>
20	1	1	1	<sup>(5)</sup>	1	0.85	0.78	<sup>(5)</sup>
40	1	1	1	<sup>(5)</sup>	1	0.79	0.70	<sup>(5)</sup>
65	1	1.04	1.07	<sup>(5)</sup>	1	0.71	0.66	<sup>(5)</sup>
<b>Walls, Wall Frame Systems</b>								
5	1	1	1	1.25 <sup>(7)</sup>	1	0.97	0.85	0.55 <sup>(8)</sup>
20	1	1	1.18	2.30 <sup>(7)</sup>	1	0.80	0.60	0.35 <sup>(8)</sup>
40	1	1.19	1.75	3.70 <sup>(7)</sup>	1	0.63	0.46	0.28 <sup>(8)</sup>
65	1	1.55	2.25	4.65 <sup>(7)</sup>	1	0.51	0.39	0.23 <sup>(8)</sup>
<b>Other Systems</b>								
5	1	1	1	<sup>(5)</sup>	1	0.97	0.85	<sup>(5)</sup>
20	1	1	1.18	<sup>(5)</sup>	1	0.80	0.60	<sup>(5)</sup>
40	1	1.19	1.75	<sup>(5)</sup>	1	0.63	0.46	<sup>(5)</sup>
65	1	1.55	2.25	<sup>(5)</sup>	1	0.51	0.39	<sup>(5)</sup>

**Notes to Table 4.1.8.11.:**

- (1) For intermediate values of the spectral ratio S(0.2)/S(5.0),  $M_v$  and J shall be obtained by linear interpolation.
- (2) For intermediate values of the fundamental lateral period,  $T_a$ ,  $S(T_a)M_v$  shall be obtained by linear interpolation using the values of  $M_v$  obtained in accordance with Note (1).
- (3) For intermediate values of the fundamental lateral period,  $T_a$ , J shall be obtained by linear interpolation using the values of J obtained in accordance with Note (1).
- (4) For a combination of different seismic force resisting systems (SFRS) not given in Table 4.1.8.11. that are in the same direction under consideration, use the highest  $M_v$  factor of all the SFRS and the corresponding value of J.
- (5) For fundamental lateral periods,  $T_a$ , greater than 2.0 s, use the 2.0 s values obtained in accordance with Note (1). See Clause 4.1.8.11.(2)(b).
- (6) A "coupled" wall is a wall system with coupling beams, where at least 66% of the base overturning moment resisted by the wall system is carried by the axial tension and compression forces resulting from shear in the coupling beams.
- (7) For fundamental lateral periods,  $T_a$ , greater than 4.0 s, use the 4.0 s values of  $S(T_a)M_v$  obtained by interpolation between 2.0 s and 5.0 s using the value of  $M_v$  obtained in accordance with Note (1). See Clause 4.1.8.11.(2)(a).
- (8) For fundamental lateral periods,  $T_a$ , greater than 4.0 s, use the 4.0 s values of J obtained by interpolation between 2.0 s and 5.0 s using the value of J obtained in accordance with Note (1). See Clause 4.1.8.11.(2)(a).

**8)** The structure shall be designed to resist overturning effects caused by the earthquake forces determined in Sentence (7) and the overturning moment at level  $x$ ,  $M_x$ , shall be determined using the following equation:

$$M_x = J_x \sum_{i=x}^n F_i (h_i - h_x)$$

where

$$J_x = 1.0 \text{ for } h_x \geq 0.6h_n, \text{ and}$$

$$J_x = J + (1 - J)(h_x / 0.6h_n) \text{ for } h_x < 0.6h_n$$

where

$J$  = base overturning moment reduction factor conforming to Table 4.1.8.11.

**9)** Torsional effects that are concurrent with the effects of the forces mentioned in Sentence (7) and are caused by the simultaneous actions of the following torsional moments shall be considered in the design of the structure according to Sentence (11):

- a) torsional moments introduced by eccentricity between the centres of mass and resistance and their dynamic amplification, and
- b) torsional moments due to accidental eccentricities.

**10)** Torsional sensitivity shall be determined by calculating the ratio  $B_x$  for each level  $x$  according to the following equation for each orthogonal direction determined independently:

$$B_x = \delta_{\max} / \delta_{\text{ave}}$$

where

$B$  = maximum of all values of  $B_x$  in both orthogonal directions, except that the  $B_x$  for one-storey penthouses with a weight less than 10% of the level below need not be considered,

$\delta_{\max}$  = maximum storey displacement at the extreme points of the structure, at level  $x$  in the direction of the earthquake induced by the equivalent static forces acting at distances  $\pm 0.10 D_{nx}$  from the centres of mass at each floor, and

$\delta_{\text{ave}}$  = average of the displacements at the extreme points of the structure at level  $x$  produced by the above-mentioned forces.

**11)** Torsional effects shall be accounted for as follows:

- a) for a *building* with  $B \leq 1.7$  or where  $I_E F_a S_a(0.2)$  is less than 0.35, by applying torsional moments about a vertical axis at each level throughout the *building*, derived for each of the following load cases considered separately:

- i)  $T_x = F_x(e_x + 0.10 D_{nx})$ , and

- ii)  $T_x = F_x(e_x - 0.10 D_{nx})$

where  $F_x$  is the lateral force at each level determined according to Sentence (7) and where each element of the *building* is designed for the most severe effect of the above load cases, or

- b) for a *building* with  $B > 1.7$ , in cases where  $I_E F_a S_a(0.2)$  is equal to or greater than 0.35, by a Dynamic Analysis Procedure as specified in Article 4.1.8.12.

**12)** Where the fundamental lateral period,  $T_a$ , is determined in accordance with Clause (3)(d) and the *building* is constructed with more than 4 storeys of continuous wood construction and has a timber SFRS consisting of shear walls with wood-based panels or of braced or moment-resisting frames as defined in Table 4.1.8.9., the lateral earthquake force,  $V$ , as determined in accordance with Sentence (2) shall be multiplied by 1.2 but need not exceed the value determined by using Clause (2)(c). (See Note A-4.1.8.10.(4).)



**4.1.8.12. Dynamic Analysis Procedure**

- 1)** Except as provided in Articles 4.1.8.19. and 4.1.8.21., the Dynamic Analysis Procedure shall be in accordance with one of the following methods:
- Linear Dynamic Analysis by either the Modal Response Spectrum Method or the Numerical Integration Linear Time History Method using a structural model that complies with the requirements of Sentence 4.1.8.3.(8) (see Note A-4.1.8.12.(1)(a)), or
  - Non-linear Dynamic Analysis, in which case a special study shall be performed (see Note A-4.1.8.12.(1)(b)).
- 2)** The spectral acceleration values used in the Modal Response Spectrum Method shall be the design spectral acceleration values,  $S(T)$ , defined in Sentence 4.1.8.4.(9).
- 3)** The ground motion histories used in the Numerical Integration Linear Time History Method shall be compatible with a response spectrum constructed from the design spectral acceleration values,  $S(T)$ , defined in Sentence 4.1.8.4.(9). (See Note A-4.1.8.12.(3).)
- 4)** The effects of accidental torsional moments acting concurrently with the lateral earthquake forces that cause them shall be accounted for by the following methods:
- the static effects of torsional moments due to  $(\pm 0.10 D_{nx})F_x$  at each level  $x$ , where  $F_x$  is either determined from the elastic dynamic analysis or determined from Sentence 4.1.8.11.(7) multiplied by  $R_d R_o / I_E$ , shall be combined with the effects determined by dynamic analysis (see Note A-4.1.8.12.(4)(a)), or
  - if  $B$ , as defined in Sentence 4.1.8.11.(10), is less than 1.7, it is permitted to use a three-dimensional dynamic analysis with the centres of mass shifted by a distance of  $-0.05 D_{nx}$  and  $+0.05 D_{nx}$ .
- 5)** Except as provided in Sentence (6), the design elastic base shear,  $V_{edr}$ , shall be equal to the elastic base shear,  $V_e$ , obtained from a Linear Dynamic Analysis.
- 6)** For structures located on sites other than Class F that have an SFRS with  $R_d$  equal to or greater than 1.5, the elastic base shear obtained from a Linear Dynamic Analysis may be multiplied by the larger of the following factors to obtain the design elastic base shear,  $V_{ed}$ :

$$\frac{2S(0.2)}{3S(T_a)} \leq 1.0 \text{ and}$$

$$S(0.5) / S(T_a) \leq 1.0$$

- 7)** The design elastic base shear,  $V_{edr}$ , shall be multiplied by the importance factor,  $I_E$ , as determined in Article 4.1.8.5., and shall be divided by  $R_d R_o$ , as determined in Article 4.1.8.9., to obtain the design base shear,  $V_d$ .
- 8)** Except as required by Sentence (9) or (12), if the base shear,  $V_d$ , obtained in Sentence (7) is less than 80% of the lateral earthquake design force,  $V$ , of Article 4.1.8.11.,  $V_d$  shall be taken as 0.8  $V$ .
- 9)** For irregular structures requiring dynamic analysis in accordance with Article 4.1.8.7.,  $V_d$  shall be taken as the larger of the  $V_d$  determined in Sentence (7) and 100% of  $V$ .
- 10)** Except as required by Sentence (11), the values of elastic *storey* shears, *storey* forces, member forces, and deflections obtained from the Linear Dynamic Analysis, including the effect of accidental torsion determined in Sentence (4), shall be multiplied by  $V_d/V_e$  to determine their design values, where  $V_d$  is the base shear.
- 11)** For the purpose of calculating deflections, it is permitted to use a value for  $V$  based on the value for  $T_a$  determined in Clause 4.1.8.11.(3)(d) to obtain  $V_d$  in Sentences (8) and (9).
- 12)** For *buildings* constructed with more than 4 *storeys* of continuous wood construction, having a timber SFRS consisting of shear walls with wood-based panels or braced or moment-resisting frames as defined in Table 4.1.8.9., and whose

fundamental lateral period,  $T_a$ , is determined in accordance with Clause 4.1.8.11.(3)(d), the design base shear,  $V_d$ , shall be taken as the larger value of  $V_d$  determined in accordance with Sentence (7) and 100% of  $V$ . (See Note A-4.1.8.10.(4).)

#### 4.1.8.13. Deflections and Drift Limits

**1)** Except as provided in Sentences (5) and (6), lateral deflections of a structure shall be calculated in accordance with the loads and requirements defined in this Subsection.

**2)** Lateral deflections obtained from a linear elastic analysis using the methods given in Articles 4.1.8.11. and 4.1.8.12. and incorporating the effects of torsion, including accidental torsional moments, shall be multiplied by  $R_d R_o / I_E$  and increased as required in Sentences 4.1.8.10.(6) and 4.1.8.16.(1) to give realistic values of anticipated deflections.

**3)** Based on the lateral deflections calculated in Sentences (2), (5) and (6), the largest *interstorey* deflection at any level shall be limited to  $0.01 h_s$  for *post-disaster buildings*,  $0.02 h_s$  for High Importance Category *buildings*, and  $0.025 h_s$  for all other *buildings*.

**4)** The deflections calculated in Sentence (2) shall be used to account for sway effects as required by Sentence 4.1.3.2.(12). (See Note A-4.1.8.13.(4).)

**5)** The lateral deflections of a seismically isolated structure shall be calculated in accordance with Article 4.1.8.20.

**6)** The lateral deflections of a structure with supplemental energy dissipation shall be calculated in accordance with Article 4.1.8.22.

#### 4.1.8.14. Structural Separation

**1)** Adjacent structures shall either be separated by the square root of the sum of the squares of their individual deflections calculated in Sentence 4.1.8.13.(2), or shall be connected to each other.

**2)** The method of connection required in Sentence (1) shall take into account the mass, stiffness, strength, ductility and anticipated motion of the connected *buildings* and the character of the connection.

**3)** Rigidly connected *buildings* shall be assumed to have the lowest  $R_d R_o$  value of the *buildings* connected.

**4)** *Buildings* with non-rigid or energy-dissipating connections require special studies.

#### 4.1.8.15. Design Provisions

**1)** Except as provided in Sentences (2) and (3), diaphragms, collectors, chords, struts and connections shall be designed so as not to yield, and the design shall account for the shape of the diaphragm, including openings, and for the forces generated in the diaphragm due to the following cases, whichever one governs (see Note A-4.1.8.15.(1)):

- a) forces due to loads determined in Article 4.1.8.11. or 4.1.8.12. applied to the diaphragm are increased to reflect the lateral load capacity of the SFRS, plus forces in the diaphragm due to the transfer of forces between elements of the SFRS associated with the lateral load capacity of such elements and accounting for discontinuities and changes in stiffness in these elements, or
- b) a minimum force corresponding to the design-based shear divided by  $N$  for the diaphragm at level  $x$ .

**2)** Steel deck roof diaphragms in *buildings* of less than 4 *storeys* or wood diaphragms that are designed and detailed according to the applicable referenced design standards to exhibit ductile behaviour shall meet the requirements of Sentence (1), except that they may yield and the forces shall be

- a) for wood diaphragms acting in combination with vertical wood shear walls, equal to the lateral earthquake design force,

- b) for wood diaphragms acting in combination with other SFRS, not less than the force corresponding to  $R_d R_o = 2.0$ , and
- c) for steel deck roof diaphragms, not less than the force corresponding to  $R_d R_o = 2.0$ .

**3)** Where diaphragms are designed in accordance with Sentence (2), the struts shall be designed in accordance with Clause 4.1.8.15.(1)(a) and the collectors, chords and connections between the diaphragms and the vertical elements of the SFRS shall be designed for forces corresponding to the capacity of the diaphragms in accordance with the applicable CSA standards. (See Note A-4.1.8.15.(3).)

**4)** For single-storey buildings with steel deck or wood roof diaphragms designed with a value of  $R_d$  greater than 1.5 and where the calculated maximum relative deflection,  $\Delta_D$ , of the diaphragm under lateral loads exceeds 50% of the average storey drift,  $\Delta_B$ , of the adjoining vertical elements of the SFRS, dynamic magnification of the inelastic response due to the in-plane diaphragm deformations shall be accounted for in the design as follows:

- a) the vertical elements of the SFRS shall be designed and detailed to any one of the following:
  - i) to accommodate the anticipated magnified lateral deformations taken as  $R_o R_d (\Delta_B + \Delta_D) - R_o \Delta_D$ ,
  - ii) to resist the forces magnified by  $R_d (1 + \Delta_D / \Delta_B) / (R_d + \Delta_D / \Delta_B)$ , or
  - iii) by a special study, and
- b) the roof diaphragm and chords shall be designed for in-plane shears and moments determined while taking into consideration the inelastic higher mode response of the structure.

(See Note A-4.1.8.15.(4).)

**5)** In cases where  $I_E F_a S_a (0.2)$  is equal to or greater than 0.35, the elements supporting any discontinuous wall, column or braced frame shall be designed for the lateral load capacity of the components of the SFRS they support. (See Note A-4.1.8.15.(5).)

**6)** Where structures have vertical variations of  $R_d R_o$  satisfying Sentence 4.1.8.9.(4), the elements of the SFRS below the level where the change in  $R_d R_o$  occurs shall be designed for the forces associated with the lateral load capacity of the SFRS above that level. (See Note A-4.1.8.15.(6).)

**7)** Where earthquake effects can produce forces in a column or wall due to lateral loading along both orthogonal axes, account shall be taken of the effects of potential concurrent yielding of other elements framing into the column or wall from all directions at the level under consideration and as appropriate at other levels. (See Note A-4.1.8.15.(7).)

**8)** The design forces associated with the lateral capacity of the SFRS need not exceed the forces determined in accordance with Sentence 4.1.8.7.(1) with  $R_d R_o$  taken as 1.0, unless otherwise provided by the applicable referenced design standards for elements, in which case the design forces associated with the lateral capacity of the SFRS need not exceed the forces determined in accordance with Sentence 4.1.8.7.(1) with  $R_d R_o$  taken as less than or equal to 1.3. (See Note A-4.1.8.15.(8).)

**9)** Foundations need not be designed to resist the lateral load overturning capacity of the SFRS, provided the design and the  $R_d$  and  $R_o$  for the type of SFRS used conform to Table 4.1.8.9. and that the foundation is designed in accordance with Sentence 4.1.8.16.(4).

**10)** Foundation displacements and rotations shall be considered as required by Sentence 4.1.8.16.(1).

#### 4.1.8.16. Foundation Provisions

**1)** The increased displacements of the structure resulting from foundation movement shall be shown to be within acceptable limits for both the SFRS and the structural framing elements not considered to be part of the SFRS. (See Note A-4.1.8.16.(1).)

**2)** Except as provided in Sentences (3) and (4), *foundations* shall be designed to have factored shear and overturning resistances greater than the lateral load capacity of the SFRS. (See Note A-4.1.8.16.(2).)

**3)** The shear and overturning resistances of the *foundation* determined using a bearing stress equal to 1.5 times the factored bearing strength of the *soil* or *rock* and all other resistances equal to 1.3 times the factored resistances need not exceed the design forces determined in Sentence 4.1.8.7.(1) using  $R_dR_o = 1.0$ , except that the factor of 1.3 shall not apply to the portion of the resistance to uplift or overturning resulting from gravity loads.

**4)** A *foundation* is permitted to have a factored overturning resistance less than the lateral load overturning capacity of the supported SFRS, provided the following requirements are met:

- a) neither the *foundation* nor the supported SFRS are constrained against rotation, and
- b) the design overturning moment of the *foundation* is
  - i) not less than 75% of the overturning capacity of the supported SFRS, and
  - ii) not less than that determined in Sentence 4.1.8.7.(1) using  $R_dR_o = 2.0$ .

(See Note A-4.1.8.16.(4).)

**5)** The design of *foundations* shall be such that they are capable of transferring earthquake loads and effects between the *building* and the ground without exceeding the capacities of the *soil* and *rock*.

**6)** In cases where  $I_EF_aS_a(0.2)$  is equal to or greater than 0.35, the following requirements shall be satisfied:

- a) *piles* or *pile caps*, drilled piers, and *caissons* shall be interconnected by continuous ties in not less than two directions (see Note A-4.1.8.16.(6)(a)),
- b) *piles*, drilled piers, and *caissons* shall be embedded a minimum of 100 mm into the *pile cap* or structure, and
- c) *piles*, drilled piers, and *caissons*, other than wood *piles*, shall be connected to the *pile cap* or structure for a minimum tension force equal to 0.15 times the factored compression load on the *pile*.

**7)** At sites where  $I_EF_aS_a(0.2)$  is equal to or greater than 0.35, *basement walls* shall be designed to resist earthquake lateral pressures from backfill or natural ground. (See Note A-4.1.8.16.(7).)

**8)** At sites where  $I_EF_aS_a(0.2)$  is greater than 0.75, the following requirements shall be satisfied:

- a) *piles*, drilled piers, or *caissons* shall be designed and detailed to accommodate cyclic inelastic behaviour when the design moment in the element due to earthquake effects is greater than 75% of its moment capacity (see Note A-4.1.8.16.(8)(a)), and
- b) spread footings founded on *soil* defined as Site Class E or F shall be interconnected by continuous ties in not less than two directions.

**9)** Each segment of a tie between elements that is required by Clauses (6)(a) or (8)(b) shall be designed to carry by tension or compression a horizontal force at least equal to the greatest factored *pile cap* or column vertical load in the elements it connects, multiplied by a factor of 0.10  $I_EF_aS_a(0.2)$ , unless it can be demonstrated that equivalent restraints can be provided by other means. (See Note A-4.1.8.16.(9).)

**10)** The potential for liquefaction of the *soil* and its consequences, such as significant ground displacement and loss of *soil* strength and stiffness, shall be evaluated based on the ground motion parameters referenced in Subsection 1.1.3., as modified by Article 4.1.8.4., and shall be taken into account in the design of the structure and its *foundations*. (See Note A-4.1.8.16.(10).)

#### 4.1.8.17. Site Stability

**1)** The potential for slope instability and its consequences, such as slope displacement, shall be evaluated based on site-specific material properties and ground

motion parameters referenced in Subsection 1.1.3., as modified by Article 4.1.8.4., and shall be taken into account in the design of the structure and its *foundations*. (See Note A-4.1.8.17.(1).)

**4.1.8.18. Elements of Structures, Non-structural Components and Equipment**

(See Note A-4.1.8.18.)

**1)** Except as provided in Sentences (2), (7) and (16), elements and components of *buildings* described in Table 4.1.8.18. and their connections to the structure shall be designed to accommodate the *building* deflections calculated in accordance with Article 4.1.8.13. and the element or component deflections calculated in accordance with Sentence (9), and shall be designed for a lateral force,  $V_p$ , distributed according to the distribution of mass:

$$V_p = 0.3 F_a S_a (0.2) I_E S_p W_p$$

where

- $F_a$  = as defined in Sentence 4.1.8.4.(7),
- $S_a(0.2)$  = spectral response acceleration value at 0.2 s, as defined in Sentence 4.1.8.4.(1),
- $I_E$  = importance factor for the *building*, as defined in Article 4.1.8.5.,
- $S_p = C_p A_r A_x / R_p$  (the maximum value of  $S_p$  shall be taken as 4.0 and the minimum value of  $S_p$  shall be taken as 0.7), where
  - $C_p$  = element or component factor from Table 4.1.8.18.,
  - $A_r$  = element or component force amplification factor from Table 4.1.8.18.,
  - $A_x$  = height factor ( $1 + 2 h_x / h_n$ ),
  - $R_p$  = element or component response modification factor from Table 4.1.8.18.,
  - and
- $W_p$  = weight of the component or element.

**Table 4.1.8.18.**  
**Elements of Structures and Non-structural Components and Equipment<sup>(1)</sup>**  
 Forming Part of Sentences 4.1.8.18.(1), (2), (3), (6) and (7)

Category	Part or Portion of <i>Building</i>	$C_p$	$A_r$	$R_p$
1	All exterior and interior walls except those in Category 2 or 3	1.00	1.00	2.50
2	Cantilever parapet and other cantilever walls except retaining walls	1.00	2.50	2.50
3	Exterior and interior ornamentations and appendages	1.00	2.50	2.50
4	Floors and roofs acting as diaphragms <sup>(2)</sup>	-	-	-
5	Towers, <i>chimneys</i> , smokestacks and penthouses when connected to or forming part of a <i>building</i>	1.00	2.50	2.50
6	Horizontally cantilevered floors, balconies, beams, etc.	1.00	1.00	2.50
7	Suspended ceilings, light fixtures and other attachments to ceilings with independent vertical support	1.00	1.00	2.50
8	Masonry veneer connections	1.00	1.00	1.50
9	Access floors	1.00	1.00	2.50
10	Masonry or concrete fences more than 1.8 m tall	1.00	1.00	2.50
11	Machinery, fixtures, equipment and tanks (including contents)			
	that are rigid and rigidly connected	1.00	1.00	1.25
	that are flexible or flexibly connected	1.00	2.50	2.50
12	Machinery, fixtures, equipment and tanks (including contents) containing toxic or explosive materials, materials having a <i>flash point</i> below 38°C or firefighting fluids			
	that are rigid and rigidly connected	1.50	1.00	1.25
	that are flexible or flexibly connected	1.50	2.50	2.50
13	Flat bottom tanks (including contents) attached directly to a floor at or below <i>grade</i> within a <i>building</i>	0.70	1.00	2.50
14	Flat bottom tanks (including contents) attached directly to a floor at or below <i>grade</i> within a <i>building</i> containing toxic or explosive materials, materials having a <i>flash point</i> below 38°C or firefighting fluids	1.00	1.00	2.50
15	Pipes, ducts (including contents)	1.00	1.00	3.00

Table 4.1.8.18. (Continued)

Category	Part or Portion of <i>Building</i>	$C_p$	$A_r$	$R_p$
16	Pipes, ducts (including contents) containing toxic or explosive materials	1.50	1.00	3.00
17	Electrical cable trays, bus ducts, conduits	1.00	2.50	5.00
18	Rigid components with ductile material and connections	1.00	1.00	2.50
19	Rigid components with non-ductile material or connections	1.00	1.00	1.00
20	Flexible components with ductile material and connections	1.00	2.50	2.50
21	Flexible components with non-ductile material or connections	1.00	2.50	1.00
22	Elevators and escalators <sup>(3)</sup>			
	machinery and equipment	as per category 11		
	elevator rails	1.00	1.00	2.50
23	Floor-mounted steel pallet storage racks <sup>(4)</sup>	1.00	2.50	2.50
24	Floor-mounted steel pallet storage racks on which are stored toxic or explosive materials or materials having a flash point below 38°C <sup>(4)</sup> .	1.50	2.50	2.50

**Notes to Table 4.1.8.18.:**

- (1) See Note A-Table 4.1.8.18..
- (2) See Sentence (8).
- (3) See also ASME A17.1/CSA B44, "Safety Code for Elevators and Escalators."
- (4) See Sentence (13) and Note A-Table 4.1.8.18..

**2)** For *buildings* other than *post-disaster buildings*, seismically isolated *buildings*, and *buildings* with supplemental energy dissipation systems, where  $I_E F_a S_a(0.2)$  is less than 0.35, the requirements of Sentence (1) need not apply to Categories 6 through 22 of Table 4.1.8.18.

**3)** For the purpose of applying Sentence (1) for Categories 11 and 12 of Table 4.1.8.18., elements or components shall be assumed to be flexible or flexibly connected unless it can be shown that the fundamental period of the element or component and its connection is less than or equal to 0.06 s, in which case the element or component is classified as being rigid or rigidly connected.

**4)** The weight of access floors shall include the *dead load* of the access floor and the weight of permanent equipment, which shall not be taken as less than 25% of the floor *live load*.

**5)** When the mass of a tank plus its contents or the mass of a flexible or flexibly connected piece of machinery, fixture or equipment is greater than 10% of the mass of the supporting floor, the lateral forces shall be determined by rational analysis.

**6)** Forces shall be applied in the horizontal direction that results in the most critical loading for design, except for Category 6 of Table 4.1.8.18., where the forces shall be applied up and down vertically.

**7)** Connections to the structure of elements and components listed in Table 4.1.8.18. shall be designed to support the component or element for gravity loads, shall conform to the requirements of Sentence (1), and shall also satisfy these additional requirements:

- a) friction due to gravity loads shall not be considered to provide resistance to seismic forces,
- b)  $R_p$  for non-ductile connections, such as adhesives or power-actuated fasteners, shall be taken as 1.0,
- c)  $R_p$  for anchorage using shallow expansion, chemical, epoxy or cast-in-place anchors shall be 1.5, where shallow anchors are those with a ratio of embedment length to diameter of less than 8,
- d) power-actuated fasteners and drop-in anchors shall not be used for tension loads,

- e) connections for non-structural elements or components of Category 1, 2 or 3 of Table 4.1.8.18. attached to the side of a *building* and above the first level above *grade* shall satisfy the following requirements:
  - i) for connections where the body of the connection is ductile, the body shall be designed for values of  $C_p$ ,  $A_r$  and  $R_p$  given in Table 4.1.8.18., and all of the other parts of the connection, such as anchors, welds, bolts and inserts, shall be capable of developing 2.0 times the nominal yield resistance of the body of the connection, and
  - ii) connections where the body of the connection is not ductile shall be designed for values of  $C_p = 2.0$ ,  $R_p = 1.0$  and  $A_r$  given in Table 4.1.8.18., and
- f) a ductile connection is one where the body of the connection is capable of dissipating energy through cyclic inelastic behaviour.

**8)** Floors and roofs acting as diaphragms shall satisfy the requirements for diaphragms stated in Article 4.1.8.15.

**9)** Lateral deflections of elements or components shall be based on the loads defined in Sentence (1) and lateral deflections obtained from an elastic analysis shall be multiplied by  $R_p/I_E$  to give realistic values of the anticipated deflections.

**10)** The elements or components shall be designed so as not to transfer to the structure any forces unaccounted for in the design, and rigid elements such as walls or panels shall satisfy the requirements of Sentence 4.1.8.3.(6).

**11)** Seismic restraint for suspended equipment, pipes, ducts, electrical cable trays, etc. shall be designed to meet the force and displacement requirements of this Article and be constructed in a manner that will not subject hanger rods to bending.

**12)** Isolated suspended equipment and components, such as pendent lights, may be designed as a pendulum system provided that adequate chains or cables capable of supporting 2.0 times the weight of the suspended component are provided and the deflection requirements of Sentence (10) are satisfied.

**13)** Free-standing steel pallet storage racks are permitted to be designed to resist earthquake effects using rational analysis, provided the design achieves the minimum performance level required by Subsection 4.1.8. (See Note A-4.1.8.18.(14).)

**14)** Except as provided in Sentence (15), the relative displacement of glass in glazing systems,  $D_{fallout}$  shall be equal to the greater of

- a)  $D_{fallout} \geq 1.25I_E D_p$ , where
  - $D_{fallout}$  ..... = relative displacement at which glass fallout occurs, and
  - $D_p$  ..... = relative earthquake displacement that the component must be designed to accommodate, calculated in accordance with Article 4.1.8.13. and applied over the height of the glass component, or

b) 13 mm.

(See Note A-4.1.8.18.(15) and (16)(c).)

**15)** Glass need not comply with Sentence (14), provided at least one of the following conditions is met:

- a)  $I_E F_a S_a(0.2) < 0.35$ ,
- b) the glass has sufficient clearance from its frame such that  $D_{clear} \geq 1.25 D_p$  calculated as follows:

$$D_{clear} = 2C_1 (1 + h_p C_2 / (b_p C_1))$$

where

- $D_{clear}$  = relative horizontal displacement measured over the height of the glass panel, which causes initial glass-to-frame contact,
- $C_1$  = average of the clearances on both sides between the vertical glass edges and the frame,
- $h_p$  = height of the rectangular glass panel,

$C_2$  = averages of the top and bottom clearances between the horizontal glass edges and the frame, and

$b_p$  = width of the rectangular glass panel,

- c) the glass is fully tempered, monolithic, installed in a non-*post-disaster building*, and no part of the glass is located more than 3 m above a walking surface (see Note A-4.1.8.18.(15) and (16)(c)), or
- d) the glass is annealed or heat-strengthened laminated glass in a single thickness with an interlayer no less than 0.76 mm and captured mechanically in a wall system glazing pocket with the perimeter secured to the frame by a wet, glazed, gunable, curing, elastomeric sealant perimeter bead of 13 mm minimum glass contact width.

**16)** For structures with supplemental energy dissipation, the following criteria shall apply:

- a) the value of  $S_a(0.2)$  used in Sentence (1) shall be determined from the mean 5% damped floor spectral acceleration values at 0.2 s by averaging the individual 5% damped floor spectra at the base of the structure determined using Non-Linear Dynamic Analysis, and
- b) the value of  $F_a$  used in Sentence (1) shall be 1.

#### 4.1.8.19. Seismic Isolation

**1)** For the purposes of this Article and Article 4.1.8.20., the following terms shall have the meanings stated herein:

- a) “seismic isolation” is an alternative seismic design concept that consists of installing an isolation system with low horizontal stiffness, thereby substantially increasing the fundamental period of the structure;
- b) “isolation system” is a collection of structural elements at the level of the isolation interface that includes all individual isolator units, all structural elements that transfer force between elements of the isolation system, all connections to other structural elements, and may also include a wind-restraint system, energy-dissipation devices, and a displacement restraint system;
- c) “seismically isolated structure” includes the upper portion of the structure above the isolation system, the isolation system, and the portion of the structure below the isolation system;
- d) “isolator unit” is a structural element of the isolation system that permits large lateral deformations under lateral earthquake design forces and is characterized by vertical-load-carrying capability combined with increased horizontal flexibility and high vertical stiffness, energy dissipation (hysteretic or viscous), self-centering capability, and lateral restraint (sufficient elastic stiffness) under non-seismic service lateral loads;
- e) “isolation interface” is the boundary between the isolated upper portion of the structure above the isolation system and the lower portion of the structure below the isolation system; and
- f) “wind-restraint system” is the collection of structural elements of the isolation system that provides restraint of the seismically isolated structure for wind loads and is permitted to be either an integral part of the isolator units or a separate device.

**2)** Every seismically isolated structure and every portion thereof shall be analyzed and designed in accordance with

- a) the loads and requirements prescribed in this Article and Article 4.1.8.20.,
- b) other applicable requirements of this Subsection, and
- c) appropriate engineering principles and current engineering practice.

(See Note A-4.1.8.19.(2))

**3)** For the analysis and modeling of the seismically isolated structure, the following criteria shall apply:

- a) a three-dimensional Non-linear Dynamic Analysis of the structure shall be performed in accordance with Article 4.1.8.12. (see Note A-4.1.8.19.(3)(a)),
- b) unless verified from rational analysis, the inherent equivalent viscous damping—excluding the hysteretic damping provided by the isolation



system or supplemental energy dissipation devices—used in the analysis shall not be taken as more than 2.5% of the critical damping at the significant modes of vibration,

- c) all individual isolator units shall be modeled with sufficient detail to account for their non-linear force-deformation characteristics, including effects of the relevant loads, and with consideration of variations in material properties over the design life of the structure, and
  - d) except for elements of the isolation system, other components of the seismically isolated structure shall be modeled using elastic material properties in accordance with Sentence 4.1.8.3.(8).
- 4)** The ground motion histories used in Sentence (3) shall be
- a) appropriately selected and scaled following good engineering practice,
  - b) compatible with
    - i) a response spectrum derived from the design spectral acceleration values,  $S(T)$ , defined in Sentence 4.1.8.4.(9) for ground conditions of Site Classes A, B and C, and
    - ii) a 5% damped response spectrum based on a site-specific evaluation for ground conditions of Site Classes D, E and F, and
  - c) amplitude-scaled in an appropriate manner over the period range of  $0.2 T_1$  to  $1.5 T_1$ , where  $T_1$  is the period of the isolated structure determined using the post-yield stiffness of the isolation system in the horizontal direction under consideration, or the period specified in Sentence 4.1.8.20.(1) if the post-yield stiffness of the isolation system is not well defined.

(See Note A-4.1.8.19.(4).)

#### 4.1.8.20. Seismic Isolation Design Provisions

**1)** The period of the isolated structure, determined using the post-yield stiffness of the isolation system in the horizontal direction under consideration, shall be greater than three times the period of the structure above the isolation interface calculated as a fixed base.

**2)** The isolation system shall be configured to produce a restoring force such that the lateral force at the TDD at the centre of mass of the isolated structure above the isolation interface is at least  $0.025W_b$  greater than the lateral force at 50% of the TDD at the same location, in each horizontal direction, where  $W_b$  is the portion of  $W$  above the isolation interface.

**3)** The values of *storey* shears, *storey* forces, member forces, and deflections used in the design of all structural framing elements and components of the isolation system shall be obtained from analysis conforming to Sentence 4.1.8.19.(3) using one of the following values, whichever produces the most critical effect:

- a) mean plus  $I_E$  times the standard deviation of results of all Non-linear Dynamic Analyses, or
- b)  $\sqrt{I_E}$  times the mean of the results of all Non-linear Dynamic Analyses.

**4)** The force-deformation and damping characteristics of the isolation system used in the analysis and design of the seismically isolated structures shall be validated by testing at least two full-size specimens of each predominant type and size of isolator unit of the isolation system, which shall include

- a) the individual isolator units,
- b) separate supplemental damping devices, if used, and
- c) separate sacrificial wind-restraint systems, if used.

**5)** The force-deformation characteristics and damping value of a representative sample of the isolator units installed in the *building* shall be validated by tests prior to their installation.

**6)** A diaphragm or horizontal structural elements shall provide continuity immediately above the isolation interface to transmit forces due to non-uniform ground motions from one part of the structure to another.

- 7)** All structural framing elements shall be designed for the forces described in Sentence (3) with  $R_d R_o = 1.0$ , except
- for structures with  $I_E < 1.5$ , all SFRS shall be detailed in accordance with the requirements for  $R_d \geq 1.5$  and the applicable referenced design standards, and
  - for structures with  $I_E = 1.5$ , all SFRS shall be detailed in accordance with the requirements for  $R_d \geq 2.0$  and the applicable referenced design standards.
- 8)** The height restrictions noted in Table 4.1.8.9. need not apply to seismically isolated structures.
- 9)** All isolator units shall be
- designed for the forces described in Sentence (3), and
  - able to accommodate the TDD determined at the specific location of each isolator unit.
- 10)** The isolation system, including a separate wind-restraint system if used, shall limit lateral displacement due to wind loads across the isolation interface to a value equal to that required for the least *storey* height in accordance with Sentence 4.1.3.5.(3).

#### 4.1.8.21. Supplemental Energy Dissipation

- 1)** For the purposes of this Article and Article 4.1.8.22., the following terms shall have the meanings stated herein:
- “supplemental energy dissipation device” is a dedicated structural element of the supplemental energy dissipation system that dissipates energy due to relative motion of each of its ends or by alternative means, and includes all pins, bolts, gusset plates, brace extensions and other components required to connect it to the other elements of the structure; a device may be classified as either displacement-dependent or velocity-dependent, or a combination thereof, and may be configured to act in either a linear or non-linear manner, and
  - “supplemental energy dissipation system” is a collection of energy dissipation devices installed in a structure that supplement the energy dissipation of the SFRS.
- 2)** Every structure with a supplemental energy dissipation system and every portion thereof shall be designed and constructed in accordance with
- the loads and requirements prescribed in this Article and Article 4.1.8.22.,
  - other applicable requirements of this Subsection, and
  - appropriate engineering principles and current engineering practice. (See Note A-4.1.8.21.(2).)
- 3)** Where supplemental energy dissipation devices are used across the isolation interface of a seismically isolated structure, displacements, velocities, and accelerations shall be determined in accordance with Article 4.1.8.20.
- 4)** For the analysis and modeling of structures with supplemental energy dissipation devices, the following criteria shall apply:
- a three-dimensional Non-linear Dynamic Analysis of the structure shall be performed in accordance with Article 4.1.8.12. (see Note A-4.1.8.21.(4)(a)),
  - for SFRS with  $R_d > 1.0$ , the non-linear hysteretic behaviour of the SFRS shall be explicitly—with sufficient detail—accounted for in the modeling and analysis of the structure,
  - unless verified from rational analysis, the inherent equivalent viscous damping—excluding the damping provided by the supplemental energy dissipation devices—used in the analysis shall not be taken as more than 2.5% of the critical damping at the significant modes of vibration,
  - all supplemental energy dissipation devices shall be modeled with sufficient detail to account for their non-linear force deformation characteristics, including effects of the relevant loads, and with consideration of variations in their properties over the design life of the structure, and
  - except for the SFRS and elements of the supplemental energy dissipation system, other components of the structure shall be modeled using elastic material properties in accordance with Sentence 4.1.8.3.(8).

- 5) The ground motion histories used in Sentence (4) shall be
  - a) appropriately selected and scaled following good engineering practice,
  - b) compatible with a 5% damped response spectrum derived from the design spectral acceleration values,  $S(T)$ , defined in Sentence 4.1.8.4.(9), and
  - c) amplitude-scaled in an appropriate manner over the period range of  $0.2 T_1$  to  $1.5 T_1$ , where  $T_1$  is the fundamental lateral period of the structure with the supplemental energy dissipation system.

(See Note A-4.1.8.21.(5).)

#### 4.1.8.22. Supplemental Energy Dissipation Design Considerations

1) The values of *storey* shears, *storey* forces, member forces, and deflections for the design of all structural framing elements and all supplemental energy dissipation devices shall be obtained from analysis conforming to Sentence 4.1.8.21.(4) using one of the following values, whichever produces the most critical effect:

- a) mean plus  $I_E$  times the standard deviation of the results of all Non-linear Dynamic Analyses, or
- b)  $\sqrt{I_E}$  times the mean of the results of all Non-linear Dynamic Analyses.

2) The largest interstorey deflection at any level of the structure as determined in accordance with Sentence (1) shall conform to the limits stated in Sentence 4.1.8.13.(3).

3) The force-deformation and force-velocity characteristics of the supplemental energy dissipation devices used in the analysis and design of structures with supplemental energy dissipation systems shall be validated by testing at least two full-size specimens of each type of supplementary energy dissipation device.

4) The force-deformation and force-velocity characteristics and damping values of a representative sample of the supplemental energy dissipation devices installed in the *building* shall be validated by tests prior to their installation.

5) Elements of the supplemental energy dissipation system, except the supplemental energy dissipation devices themselves, shall be designed to remain elastic for the design loads.

6) All structural framing elements shall be designed

- a) for an SFRS with  $R_d = 1.0$ , using the forces referred to in Sentence (1) with  $R_d R_o = 1.0$ , except that the SFRS shall be detailed in accordance with the requirements for  $R_d \geq 1.5$  and the applicable referenced design standards, or
- b) for an SFRS with  $R_d > 1.0$ , using the forces referred to in Sentence (1) with  $R_d R_o = 1.0$ , except that the SFRS shall be detailed in accordance with the requirements for the selected  $R_d$  and the applicable referenced design standards.

7) Supplemental energy dissipation devices and other components of the supplemental energy dissipation system shall be designed in accordance with Sentence (1) with consideration of the following:

- a) low-cycle, large-displacement degradation due to seismic loads,
- b) high-cycle, small-displacement degradation due to wind, thermal, or other cyclic loads,
- c) forces or displacements due to gravity loads,
- d) adhesion of device parts due to corrosion or abrasion, biodegradation, moisture, or chemical exposure,
- e) exposure to environmental conditions, including, but not limited to, temperature, humidity, moisture, radiation (e.g., ultraviolet light), and reactive or corrosive substances (e.g., salt water),
- f) devices subject to failure due to low-cycle fatigue must resist wind forces without slip, movement, or inelastic cycling,
- g) the range of thermal conditions, device wear, manufacturing tolerances, and other effects that cause device properties to vary during the design life of the device, and
- h) connection points of devices must provide sufficient articulation to accommodate simultaneous longitudinal, lateral, and vertical displacements of the supplemental energy dissipation system.

8) Means of access for inspection and removal for replacement of all supplemental energy dissipation devices shall be provided.

## Section 4.2. Foundations

### 4.2.1. General

#### 4.2.1.1. Application

1) This Section applies to *excavations* and *foundation* systems for *buildings*.

### 4.2.2. Subsurface Investigations, Drawings and Reviews

#### 4.2.2.1. Subsurface Investigation

1) A *subsurface investigation*, including *groundwater* conditions, shall be carried out by or under the direction of a professional engineer having knowledge and experience in planning and executing such investigations to a degree appropriate for the *building* and its use, the ground and the surrounding site conditions. (See Note A-4.2.2.1.(1).)

#### 4.2.2.2. Drawings

1) Drawings associated with *foundations* and *excavations* shall conform to the appropriate requirements of Section 2.2. of Division C. (See Article 2.2.4.6. of Division C.)

#### 4.2.2.3. Field Review

1) A field review shall be carried out by the *designer* or by another suitably qualified person to ascertain that the subsurface conditions are consistent with the design and that construction is carried out in accordance with the design and good engineering practice. (See Note A-4.2.2.3.(1).)

2) The review required by Sentence (1) shall be carried out

- a) on a continuous basis
  - i) during the construction of all *deep foundation units* with all pertinent information recorded for each *foundation unit*,
  - ii) during the installation and removal of retaining structures and related backfilling operations, and
  - iii) during the placement of engineered *fills* that are to be used to support the *foundation units*, and
- b) as required, unless otherwise directed by the *authority having jurisdiction*,
  - i) in the construction of all *shallow foundation units*, and
  - ii) in excavating, dewatering and other related works.

#### 4.2.2.4. Altered Subsurface Condition

1) If, during construction, the *soil*, *rock* or *groundwater* is found not to be of the type or in the condition used in design and as indicated on the drawings, the design shall be reassessed by the *designer*.

2) If, during construction, climatic or any other conditions change the properties of the *soil*, *rock* or *groundwater*, the design shall be reassessed by the *designer*.

### 4.2.3. Materials Used in Foundations

#### 4.2.3.1. Wood

1) Wood used in *foundations* or in support of *soil* or *rock* shall conform with the appropriate requirements of Subsection 4.3.1.

**4.2.3.2. Preservation Treatment of Wood**

1) Wood exposed to *soil* or air above the lowest anticipated *groundwater* table shall be treated with preservative in conformance with CAN/CSA-O80 Series, "Wood Preservation," and the requirements of the appropriate commodity standard as follows:

- a) CAN/CSA-O80.2, "Processing and Treatment,"
- b) CAN/CSA-O80.3, "Preservative Formulations," or
- c) CSA O80.15, "Preservative Treatment of Wood for Building Foundation Systems, Basements, and Crawl Spaces by Pressure Processes."

2) Where timber has been treated as required in Sentence (1), it shall be cared for as provided in AWPA M4, "Care of Preservative-Treated Wood Products," as revised by Clause 6 of CAN/CSA-O80 Series, "Wood Preservation."

**4.2.3.3. Plain and Reinforced Masonry**

1) Plain or reinforced masonry used in *foundations* or in support of *soil* or *rock* shall conform with the requirements of Subsection 4.3.2.

**4.2.3.4. Prevention of Deterioration of Masonry**

1) Where plain or reinforced masonry in *foundations* or in structures supporting *soil* or *rock* may be subject to conditions conducive to deterioration, protection shall be provided to prevent such deterioration.

**4.2.3.5. Concrete**

1) Plain, reinforced or pre-stressed concrete used in *foundations* or in support of *soil* or *rock* shall conform with the requirements of Subsection 4.3.3.

**4.2.3.6. Protection Against Chemical Attack**

1) Where concrete in *foundations* may be subject to chemical attack, it shall be treated in conformance with the requirements in CSA A23.1, "Concrete Materials and Methods of Concrete Construction."

**4.2.3.7. Steel**

1) Steel used in *foundations* or in support of *soil* or *rock* shall conform with the appropriate requirements of Subsection 4.3.3. or 4.3.4., unless otherwise specified in this Section.

**4.2.3.8. Steel Piles**

1) Where steel *piles* are used in *deep foundations* and act as permanent load-carrying members, the steel shall conform with one of the following standards:

- a) ASTM A 252, "Welded and Seamless Steel Pipe Piles,"
- b) ASTM A 283/A 283M, "Low and Intermediate Tensile Strength Carbon Steel Plates,"
- c) ASTM A 1008/A 1008M, "Steel, Sheet, Cold-Rolled, Carbon, Structural, High-Strength Low-Alloy, High-Strength Low-Alloy with Improved Formability, Solution Hardened, and Bake Hardenable,"
- d) ASTM A 1011/A 1011M, "Steel, Sheet and Strip, Hot-Rolled, Carbon, Structural, High-Strength Low-Alloy, High-Strength Low-Alloy with Improved Formability, and Ultra-High Strength," or
- e) CSA G40.21, "Structural Quality Steel."

**4.2.3.9. High Strength Steel Tendons**

1) Where high strength steel is used for tendons in anchor systems used for the permanent support of a *foundation* or in the erection of temporary support of *soil* or *rock* adjacent to an *excavation*, it shall conform with the requirements of CSA A23.1, "Concrete Materials and Methods of Concrete Construction."

**4.2.3.10. Corrosion of Steel**

1) Where conditions are corrosive to steel, adequate protection of exposed steel shall be provided. (See Article 1.2.1.1. of Division A for use of other materials.)

**4.2.4. Design Requirements****4.2.4.1. Design Basis**

1) The design of *foundations*, *excavations* and *soil-* and *rock-*retaining structures shall be based on a *subsurface investigation* carried out in conformance with the requirements of this Section, and on any of the following, as appropriate:

- a) application of generally accepted geotechnical and civil engineering principles by a professional engineer especially qualified in this field of work, as provided in this Section and other Sections of Part 4,
- b) established local practice, where such practice includes successful experience both with *soils* and *rocks* of similar type and condition and with a *foundation* or *excavation* of similar type, construction method, size and depth, or
- c) in situ testing of *foundation units*, such as the load testing of *piles*, anchors or footings, carried out by a person competent in this field of work.

(See Note A-4.2.4.1.(1).)

2) The *foundations* of a *building* shall be capable of resisting all the loads stipulated in Section 4.1., in accordance with limit states design in Subsection 4.1.3.

3) For the purpose of the application of the load combinations given in Table 4.1.3.2.-A, the geotechnical components of loads and the factored geotechnical resistances at ULS shall be determined by a suitably qualified and experienced professional engineer. (See Note A-4.2.4.1.(3).)

4) Geotechnical components of service loads and geotechnical reactions for SLS shall be determined by a suitably qualified and experienced professional engineer.

5) The *foundation* of a *building* shall be designed to satisfy SLS requirements within the limits that the *building* is designed to accommodate, including total settlement and differential settlement, heave, lateral movement, tilt or rotation. (See Note A-4.2.4.1.(5).)

6) Communication, interaction and coordination between the *designer* and the professional engineer responsible for the geotechnical aspects of the project shall take place to a degree commensurate with the complexity and requirements of the project.

**4.2.4.2. Subsurface Investigation**

1) A *subsurface investigation* shall be carried out to the depth and extent to which the *building* or *excavation* will significantly change the stress in the *soil* or *rock*, or to such a depth and extent as to provide all the necessary information for the design and construction of the *excavation* or the *foundations*.

**4.2.4.3. Identification**

1) The identification and classification of *soil*, *rock* and *groundwater* and descriptions of their engineering and physical properties shall be in accordance with a widely accepted system.

**4.2.4.4. Depth of Foundations**

1) Except as permitted in Sentence (2), the *bearing surface* of a *foundation* shall be below the level of potential damage, including damage resulting from *frost action*, and the *foundation* shall be designed to prevent damage resulting from *adfreezing* and frost jacking. (See Note A-4.2.4.4.(1).)

2) The *bearing surface* of a *foundation* need not be below the level of potential damage from frost where the *foundation*

- a) is designed against *frost action*, or
- b) overlies material not susceptible to *frost action*.

**4.2.4.5. Sloping Ground**

1) Where a *foundation* is to rest on, in or near sloping ground, this particular condition shall be provided for in the design.

**4.2.4.6. Eccentric and Inclined Loads**

1) Where there is eccentricity or inclination of loading in *foundation units*, this effect shall be fully investigated and provided for in the design.

**4.2.4.7. Dynamic Loading**

1) Where dynamic loading conditions apply, the effects shall be assessed by a special investigation of these conditions and provided for in the design.

**4.2.4.8. Hydrostatic Uplift**

1) Where a *foundation* or any part of a *building* is subject to hydrostatic uplift, the effects shall be provided for in the design.

**4.2.4.9. Groundwater Level Change**

1) Where proposed construction will result in a temporary or permanent change in the *groundwater level*, the effects of this change on adjacent *buildings* shall be fully investigated and provided for in the design.

**4.2.4.10. Permafrost**

1) Where conditions of permafrost are encountered or proven to exist, the design of the *foundation* shall be based upon analysis of these conditions by a person especially qualified in that field of work.

**4.2.4.11. Swelling and Shrinking Soils**

1) Where swelling or shrinking *soils*, in which movements resulting from moisture content changes may be sufficient to cause damage to a structure, are encountered or known to exist, such a condition shall be fully investigated and provided for in the design.

**4.2.4.12. Expanding and Deteriorating Rock**

1) Where *rock* that expands or deteriorates when subjected to unfavourable environmental conditions or to stress release is known to exist, this condition shall be fully investigated and provided for in the design.

**4.2.4.13. Construction on Fill**

- 1) *Buildings* may be placed on *fill* if it can be shown by *subsurface investigation* that
- a) the *fill* is or can be made capable of safely supporting the *building*,
  - b) detrimental movement of the *building* or of services leading to the *building* will not occur, and
  - c) explosive gases can be controlled or do not exist.

**4.2.4.14. Structural Design**

1) The structural design of the *foundation* of a *building*, the procedures and construction practices shall conform with the appropriate Sections of this Code unless otherwise specified in this Section.

**4.2.5. Excavations****4.2.5.1. Design of Excavations**

1) The design of *excavations* and of supports for the sides of *excavations* shall conform with Subsection 4.2.4. and with this Subsection. (See Note A-4.2.5.1.(1).)

**4.2.5.2. Excavation Construction**

- 1) Every *excavation* shall be undertaken in such a manner as to
  - a) prevent movement that would cause damage to adjacent *buildings* at all phases of construction, and
  - b) comply with the appropriate requirements of Part 8.
- 2) Material shall not be placed nor shall equipment be operated or placed in or adjacent to an *excavation* in a manner that may endanger the integrity of the *excavation* or its supports.

**4.2.5.3. Supported Excavations**

- 1) The sides of an *excavation* in *soil* or *rock* shall be supported by a retaining structure conforming with the requirements of Articles 4.2.5.1. and 4.2.5.2., except as permitted in Article 4.2.5.4.

**4.2.5.4. Unsupported Excavations**

- 1) The sides of an *excavation* in *soil* or *rock* may be unsupported where a design is prepared in conformance with the requirements of Articles 4.2.5.1. and 4.2.5.2.

**4.2.5.5. Control of Water around Excavations**

- 1) Surface water, all *groundwater*, *perched groundwater* and in particular *artesian groundwater* shall be kept under control at all phases of *excavation* and construction.

**4.2.5.6. Loss of Ground**

- 1) At all phases of *excavation* and construction, loss of ground due to water or any other cause shall be prevented.

**4.2.5.7. Protection and Maintenance at Excavations**

- 1) All sides of an *excavation*, supported and unsupported, shall be continuously maintained and protected from possible deterioration by construction activity or by the action of frost, rain and wind.

**4.2.5.8. Backfilling**

- 1) Where an *excavation* is backfilled, the backfill shall be placed so as to
  - a) provide lateral support to the *soil* adjacent to the *excavation*, and
  - b) prevent detrimental movements.
- 2) The material used as backfill or *fill* supporting a footing, *foundation* or a floor on *grade* shall be of a type that is not subject to detrimental volume change with changes in moisture content and temperature.

**4.2.6. Shallow Foundations****4.2.6.1. Design of Shallow Foundations**

- 1) The design of *shallow foundations* shall be in conformance with Subsection 4.2.4. and the requirements of this Subsection. (See Note A-4.2.6.1.(1).)

**4.2.6.2. Support of Shallow Foundations**

- 1) Where a *shallow foundation* is to be placed on *soil* or *rock*, the *soil* or *rock* shall be cleaned of loose and unsound material and shall be adequate to support the design load taking into account temperature, precipitation, construction activities and other factors that may lead to changes in the properties of *soil* or *rock*.



**4.2.6.3. Incorrect Placement of Shallow Foundations**

- 1) Where a *shallow foundation unit* has not been placed or located as indicated on the drawings,
  - a) the error shall be corrected, or
  - b) the design of the *foundation unit* shall be recalculated for the altered conditions by the *designer* and action taken as required in Article 2.2.4.7. of Division C.

**4.2.6.4. Damaged Shallow Foundations**

- 1) If a *shallow foundation unit* is damaged,
  - a) it shall be repaired, or
  - b) the design of the *foundation unit* shall be recalculated for the damaged condition by the *designer* and action taken as required in Article 2.2.4.7. of Division C.

**4.2.7. Deep Foundations****4.2.7.1. General**

- 1) A *deep foundation* shall provide support for a *building* by transferring loads by end-bearing to a competent stratum at considerable depth below the structure, or by mobilizing resistance by adhesion or friction, or both, in the *soil* or *rock* in which it is placed. (See Note A-4.2.7.1.(1).)

**4.2.7.2. Design of Deep Foundations**

- 1) *Deep foundations* shall be designed in conformance with Subsection 4.2.4. and this Subsection. (See Note A-4.2.7.2.(1).)
- 2) Where *deep foundation units* are load tested, as required in Clause 4.2.4.1.(1)(c), the determination of the number and type of load test and the interpretation of the results shall be carried out by a professional engineer especially qualified in this field of work. (See Note A-4.2.7.2.(2).)
- 3) The design of *deep foundations* shall be determined on the basis of geotechnical considerations taking into account
  - a) the method of installation,
  - b) the degree of inspection,
  - c) the spacing of *foundation units* and group effects,
  - d) other requirements in this Subsection, and
  - e) the appropriate structural requirements in Section 4.1. and Subsections 4.3.1., 4.3.3. and 4.3.4.
- 4) The portion of a *deep foundation unit* permanently in contact with *soil* or *rock* shall be structurally designed as a laterally supported compression member.
- 5) The portion of a *deep foundation unit* that is not permanently in contact with *soil* or *rock* shall be structurally designed as a laterally unsupported compression member.
- 6) The structural design of prefabricated *deep foundation units* shall allow for all stresses resulting from driving, handling and testing.

**4.2.7.3. Tolerance in Alignment and Location**

- 1) Permissible deviations from the design alignment and the location of the top of *deep foundation units* shall be determined by design analysis and shall be indicated on the drawings.

**4.2.7.4. Incorrect Alignment and Location**

- 1) Where a *deep foundation unit* has not been placed within the permissible deviations referred to in Article 4.2.7.3., the condition of the *foundation* shall be assessed by the *designer*, any necessary changes made and action taken as required in Article 2.2.4.7. of Division C.

**4.2.7.5. Installation of Deep Foundations**

- 1) *Deep foundation units* shall be installed in such a manner as not to impair
  - a) the strength of the *deep foundation units* and the properties of the *soil* or *rock* on or in which they are placed beyond the calculated or anticipated limits,
  - b) the integrity of previously installed *deep foundation units*, or
  - c) the integrity of neighbouring *buildings*.

**4.2.7.6. Damaged Deep Foundation Units**

- 1) Where inspection shows that a *deep foundation unit* is damaged or not consistent with design or good engineering practice,
  - a) such a unit shall be reassessed by the *designer*,
  - b) any necessary changes shall be made, and
  - c) action shall be taken as required in Article 2.2.4.7. of Division C.

**4.2.8. Special Foundations****4.2.8.1. General**

- 1) Where special *foundation* systems are used, such systems shall conform to Subsection 4.2.4., Sentence 4.1.1.5.(2) and Article 1.2.1.1. of Division A.

**4.2.8.2. Use of Existing Foundations**

- 1) Existing *foundations* may be used to support new or altered *buildings* provided they comply with all pertinent requirements of this Section.

**Section 4.3. Design Requirements for Structural Materials****4.3.1. Wood****4.3.1.1. Design Basis for Wood**

- 1) *Buildings* and their structural members made of wood shall conform to CSA O86, "Engineering Design in Wood."

**4.3.1.2. Glued-Laminated Members**

- 1) Glued-laminated members shall be fabricated in plants conforming to CSA O177, "Qualification Code for Manufacturers of Structural Glued-Laminated Timber."

**4.3.1.3. Termites**

- 1) In areas known to be infested by termites, the requirements in Articles 9.3.2.9., 9.12.1.1. and 9.15.5.1. shall apply.

**4.3.2. Plain and Reinforced Masonry****4.3.2.1. Design Basis for Plain and Reinforced Masonry**

- 1) *Buildings* and their structural members made of plain and reinforced masonry shall conform to CSA S304, "Design of Masonry Structures."

**4.3.3. Plain, Reinforced and Pre-stressed Concrete****4.3.3.1. Design Basis for Plain, Reinforced and Pre-stressed Concrete**

- 1) *Buildings* and their structural members made of plain, reinforced and pre-stressed concrete shall conform to CSA A23.3, "Design of Concrete Structures." (See Note A-4.3.3.1.(1).)

**4.3.4. Steel****4.3.4.1. Design Basis for Structural Steel**

1) *Buildings* and their structural members made of structural steel shall conform to CSA S16, "Design of Steel Structures." (See Note A-4.3.4.1.(1).)

**4.3.4.2. Design Basis for Cold-Formed Steel**

1) *Buildings* and their structural members made of cold-formed steel shall conform to CSA S136, "North American Specification for the Design of Cold-Formed Steel Structural Members." (See Note A-4.3.4.2.(1).)

**4.3.4.3. Steel Building Systems**

1) Steel *building* systems shall be manufactured by companies certified in accordance with the requirements of CSA A660, "Certification of Manufacturers of Steel Building Systems."

**4.3.5. Aluminum****4.3.5.1. Design Basis for Aluminum**

1) *Buildings* and their structural members made of aluminum shall conform to CAN/CSA-S157/S157.1, "Strength Design in Aluminum/Commentary on CSA S157-05, Strength Design in Aluminum," using the loads stipulated in Section 4.1., in accordance with limit states design in Subsection 4.1.3.

**4.3.6. Glass****4.3.6.1. Design Basis for Glass**

1) Glass used in *buildings* shall be designed in conformance with

- CAN/CGSB-12.20-M, "Structural Design of Glass for Buildings," using an adjustment factor on the wind load,  $W$ , of not less than 0.75, or
- ASTM E 1300, "Determining Load Resistance of Glass in Buildings," using an adjustment factor on the wind load,  $W$ , of not less than 1.0.

(See Note A-4.3.6.1.(1).)

**Section 4.4. Design Requirements for Special Structures****4.4.1. Air-Supported Structures****4.4.1.1. Design Basis for Air-Supported Structures**

1) The structural design of *air-supported structures* shall conform to CSA S367, "Air-, Cable-, and Frame-Supported Membrane Structures," using the loads stipulated in Section 4.1., in accordance with limit states design in Subsection 4.1.3.

**4.4.2. Parking Structures****4.4.2.1. Design Basis for Parking Structures and Repair Garages**

1) Parking structures and *repair garages* shall be designed in conformance with CSA S413, "Parking Structures." (See Note A-4.4.2.1.(1).)

## Section 4.5. Objectives and Functional Statements

### 4.5.1. Objectives and Functional Statements

#### 4.5.1.1. Attributions to Acceptable Solutions

1) For the purpose of compliance with this Code as required in Clause 1.2.1.1.(1)(b) of Division A, the objectives and functional statements attributed to the acceptable solutions in this Part shall be the objectives and functional statements listed in Table 4.5.1.1. (See Note A-1.1.2.1.(1).)

**Table 4.5.1.1.**  
**Objectives and Functional Statements Attributed to the**  
**Acceptable Solutions in Part 4**  
 Forming Part of Sentence 4.5.1.1.(1)

Functional Statements and Objectives <sup>(1)</sup>	
<b>4.1.1.3. Design Requirements</b>	
(1)	[F20-OS2.1]
(2)	[F22-OP2.4]
	[F22-OH4]
(3)	[F20-OS2.1] Applies to structural members where temporary overloading during construction may result in impairment of that or any other member.
(4)	[F20,F80,F82-OS2.1]
(5)	[F20-OP2.1] [F22-OP2.4]
	[F20-OS2.3,OS2.4]
<b>4.1.1.5. Design Basis</b>	
(2)	[F20-OS2.1] [F22-OS2.4,OS2.5]
	[F20-OP2.1] [F22-OP2.4,OP2.5]
	[F22-OH4]
<b>4.1.2.1. Loads and Effects</b>	
(1)	[F20-OS2.1]
	[F20-OP2.1] [F22-OP2.4]
	[F22-OH4]
(2)	[F20-OS2.1]
(3)	[F20-OS2.1]
<b>4.1.2.2. Loads Not Listed</b>	
(1)	[F20-OS2.1]
	[F20-OP2.1] [F22-OP2.4]
	[F22-OH4]
<b>4.1.3.2. Strength and Stability</b>	
(1)	[F20-OP2.1] [F22-OP2.4]
	[F20-OS2.1]
(2)	[F20-OS2.1]
	[F22-OS2.4,OS2.5] Applies to the stabilizing resistance of the <i>dead load</i> .
	[F20-OP2.1] [F22-OP2.4,OP2.5]

**Table 4.5.1.1. (Continued)**

Functional Statements and Objectives <sup>(1)</sup>	
(3)	[F20-OS2.1] [F22-OS2.4,OS2.5] Applies to the stabilizing resistance of the <i>dead load</i> .
	[F20-OP2.1] [F22-OP2.4,OP2.5]
(4)	[F20-OS2.1]
	[F20-OP2.1] [F22-OP2.4]
(5)	[F20-OS2.1] [F22-OS2.4,OS2.5]
	[F20-OP2.1] [F22-OP2.4,OP2.5]
(8)	[F20-OS2.1]
	[F20-OP2.1] [F22-OP2.4]
(9)	[F20-OS2.1]
	[F20-OP2.1] [F22-OP2.4]
(11)	[F20-OS2.1] [F22-OS2.4,OS2.5]
(12)	[F20-OS2.1]
	[F20-OP2.1] [F22-OP2.4]
<b>4.1.3.3. Fatigue</b>	
(1)	[F20-OS2.1]
	[F20-OP2.1] [F22-OP2.4]
(2)	[F20-OS2.1]
	[F20-OP2.1,OP2.4] [F22-OP2.4]
	[F22-OH4]
<b>4.1.3.4. Serviceability</b>	
(1)	[F22-OP2.4]
	[F22-OH4]
<b>4.1.3.5. Deflection</b>	
(1)	(b),(c),(d) [F22-OP2.4]
	[F22-OP2.4]
	[F22-OH4]
(2)	[F22-OS2.3,OS2.4]
	[F22-OP2.4]
(3)	[F22-OP2.4]
(5)	[F22-OS2.3,OS2.4]
	[F22-OP2.3,OP2.4]

**Table 4.5.1.1. (Continued)**

Functional Statements and Objectives <sup>(1)</sup>	
<b>4.1.3.6. Vibration</b>	
(1)	[F22-OP2.4]
	[F22-OH4]
(2)	[F20-OS2.1]
	[F20-OP2.1,OP2.4] [F22-OP2.4]
	[F22-OH4]
<b>4.1.4.1. Dead Loads</b>	
(2)	[F20-OS2.1]
	[F20-OP2.1] [F22-OP2.4]
(3)	[F20-OS2.1]
	[F20-OP2.1] [F22-OP2.4]
(5)	[F20-OS2.1]
	[F20-OP2.1] [F22-OP2.4]
(6)	[F20-OS2.1] [F22-OS2.4,OS2.5]
<b>4.1.5.1. Loads Due to Use of Floors and Roofs</b>	
(1)	[F20-OS2.1]
	[F20-OP2.1] [F22-OP2.4]
	[F22-OH4]
<b>4.1.5.2. Uses Not Stipulated</b>	
(1)	[F20-OS2.1]
	[F20-OP2.1] [F22-OP2.4]
	[F22-OH4]
<b>4.1.5.3. Full and Partial Loading</b>	
(1)	[F20-OS2.1]
	[F20-OP2.1] [F22-OP2.4]
	[F22-OH4]
<b>4.1.5.4. Loads for Occupancy Served</b>	
(1)	[F20-OS2.1]
	[F20-OP2.1] [F22-OP2.4]
	[F22-OH4]
<b>4.1.5.5. Loads on Exterior Areas</b>	
(1)	[F20-OS2.1]
	[F20-OP2.1] [F22-OP2.4]
	[F22-OH4]
(2)	[F20-OS2.1]
	[F20-OP2.1] [F22-OP2.4]
	[F22-OH4]
(3)	[F20-OS2.1]
	[F20-OP2.1] [F22-OP2.4]
	[F22-OH4]
(4)	[F20-OS2.1]
	[F20-OP2.1] [F22-OP2.4]
	[F22-OH4]

**Table 4.5.1.1. (Continued)**

Functional Statements and Objectives <sup>(1)</sup>	
<b>4.1.5.7. More Than One Occupancy</b>	
(1)	[F20-OS2.1]
	[F20-OP2.1] [F22-OP2.4]
	[F22-OH4]
<b>4.1.5.8. Variation with Tributary Area</b>	
(1)	[F20-OS2.1]
	[F20-OP2.1] [F22-OP2.4]
	[F22-OH4]
<b>4.1.5.9. Concentrated Loads</b>	
(1)	[F20-OS2.1]
	[F20-OP2.1] [F22-OP2.4]
<b>4.1.5.10. Sway Forces in Assembly Occupancies</b>	
(1)	[F20-OS2.1]
	[F20-OP2.1,OP2.4]
<b>4.1.5.11. Crane-Supporting Structures and Impact of Machinery and Equipment</b>	
(1)	[F20-OS2.1]
	[F20-OP2.1,OP2.4] [F22-OP2.4]
(3)	[F20-OS2.1]
	[F20-OP2.1,OP2.4]
(4)	[F20-OS2.1]
	[F20-OP2.1,OP2.4]
(5)	[F20-OS2.1]
	[F20-OP2.1,OP2.4]
<b>4.1.5.12. Bleachers</b>	
(1)	[F20-OS2.1]
	[F20-OP2.1] [F22-OP2.4]
(3)	[F20-OS2.4]
<b>4.1.5.13. Helicopter Landing Areas</b>	
(1)	[F20-OS2.1]
	[F20-OP2.1] [F22-OP2.4]
<b>4.1.5.14. Loads on Guards</b>	
(1)	[F20-OS2.1]
(2)	[F20-OS2.1]
(3)	[F20-OS2.1,OS2.4]
(4)	[F22-OS2.4]
(6)	[F20-OS2.1]
(7)	[F20-OS2.1]
<b>4.1.5.15. Loads on Vehicle Guardrails</b>	
(1)	[F20-OS2.1]
<b>4.1.5.16. Loads on Walls Acting As Guards</b>	
(1)	[F20-OS2.1]

Table 4.5.1.1. (Continued)

Functional Statements and Objectives <sup>(1)</sup>	
<b>4.1.5.17. Firewalls</b>	
(1)	[F20-OS1.2]
	[F20-OP1.2]
	[F20-OP3.1]
(2)	[F04-OS1.2]
	[F04-OP1.2]
	[F04-OP3.1]
<b>4.1.6.2. Specified Snow Load</b>	
(1)	[F20-OS2.1]
	[F20-OP2.1] [F22-OP2.4]
(2)	[F20-OS2.1]
	[F20-OP2.1] [F22-OP2.4]
(3)	[F20-OS2.1]
	[F20-OP2.1] [F22-OP2.4]
(5)	[F20-OS2.1]
	[F20-OP2.1] [F22-OP2.4]
(6)	[F20-OS2.1]
	[F20-OP2.1] [F22-OP2.4]
(7)	[F20-OS2.1]
	[F20-OP2.1] [F22-OP2.4]
(8)	[F20-OS2.1] Applies to portion of Code text: "The shape accumulation factor, $C_a$ , shall be 1.0, ..."
	[F20-OP2.1] [F22-OP2.4] Applies to portion of Code text: "The shape accumulation factor, $C_a$ , shall be 1.0,..."
	(a) to (e) [F20-OS2.1] Applies to roof shapes and configurations that call for a higher shape accumulation factor.
	(a) to (e) [F20-OP2.1] [F22-OP2.4] Applies to roof shapes and configurations that call for a higher shape accumulation factor.
(9)	[F20-OS2.1]
	[F20-OP2.1] [F22-OP2.4]
<b>4.1.6.3. Full and Partial Loading</b>	
(1)	[F20-OS2.1]
	[F20-OP2.1] [F22-OP2.4]
(2)	[F20-OS2.1]
	[F20-OP2.1] [F22-OP2.4]
<b>4.1.6.4. Specified Rain Load</b>	
(1)	[F20-OS2.1]
	[F20-OP2.1] [F22-OP2.4]
(2)	[F20-OS2.1]
	[F20-OP2.1] [F22-OP2.4]
(4)	[F20-OS2.1]
	[F20-OP2.1] [F22-OP2.4]

Table 4.5.1.1. (Continued)

Functional Statements and Objectives <sup>(1)</sup>	
<b>4.1.6.5. Multi-level Roofs</b>	
(1)	[F20-OS2.1]
	[F20-OP2.1] [F22-OP2.4]
(2)	[F20-OS2.1]
	[F20-OP2.1] [F22-OP2.4]
(3)	[F20-OS2.1]
	[F20-OP2.1] [F22-OP2.4]
(4)	[F20-OS2.1]
	[F20-OP2.1] [F22-OP2.4]
<b>4.1.6.6. Horizontal Gap between a Roof and a Higher Roof</b>	
(1)	[F20-OS2.1]
	[F20-OP2.1] [F22-OP2.4]
<b>4.1.6.7. Areas Adjacent to Roof Projections</b>	
(1)	[F20-OS2.1]
	[F20-OP2.1] [F22-OP2.4]
<b>4.1.6.8. Snow Drift at Corners</b>	
(1)	[F20-OS2.1]
	[F20-OP2.1] [F22-OP2.4]
(2)	[F20-OS2.1]
	[F20-OP2.1] [F22-OP2.4]
<b>4.1.6.9. Gable Roofs</b>	
(1)	[F20-OS2.1]
	[F20-OP2.1] [F22-OP2.4]
(2)	[F20-OS2.1]
	[F20-OP2.1] [F22-OP2.4]
(4)	[F20-OS2.1]
	[F20-OP2.1] [F22-OP2.4]
<b>4.1.6.10. Arch Roofs, Curved Roofs and Domes</b>	
(1)	[F20-OS2.1]
	[F20-OP2.1] [F22-OP2.4]
(2)	[F20-OS2.1]
	[F20-OP2.1] [F22-OP2.4]
(3)	[F20-OS2.1]
	[F20-OP2.1] [F22-OP2.4]
(4)	[F20-OS2.1]
	[F20-OP2.1] [F22-OP2.4]
(5)	[F20-OS2.1]
	[F20-OP2.1] [F22-OP2.4]
(6)	[F20-OS2.1]
	[F20-OP2.1] [F22-OP2.4]
(7)	[F20-OS2.1]
	[F20-OP2.1] [F22-OP2.4]

**Table 4.5.1.1. (Continued)**

Functional Statements and Objectives <sup>(1)</sup>	
(9)	[F20-OS2.1] [F20-OP2.1] [F22-OP2.4]
<b>4.1.6.11. Snow Loads Due to Sliding</b>	
(1)	[F20-OS2.1] [F20-OP2.1] [F22-OP2.4]
(3)	[F20-OS2.1] [F20-OP2.1] [F22-OP2.4]
<b>4.1.6.12. Valleys in Curved or Sloped Roofs</b>	
(1)	[F20-OS2.1] [F20-OP2.1] [F22-OP2.4]
(2)	[F20-OS2.1] [F20-OP2.1] [F22-OP2.4]
(3)	[F20-OS2.1] [F20-OP2.1] [F22-OP2.4]
<b>4.1.6.13. Specific Weight of Snow</b>	
(1)	[F20-OS2.1] [F20-OP2.1] [F22-OP2.4]
<b>4.1.6.14. Snow Removal</b>	
(1)	[F20-OS2.1] [F20-OP2.1] [F22-OP2.4]
<b>4.1.6.15. Ice Loading of Structures</b>	
(1)	[F20-OS2.1] [F20-OP2.1] [F22-OP2.4]
<b>4.1.7.1. Specified Wind Load</b>	
(2)	[F20-OS2.1] [F20-OP2.1] [F22-OP2.4] [F22-OH4]
(3)	[F20-OS2.1] [F20-OP2.1] [F22-OP2.4] [F22-OH4]
(4)	[F20-OS2.1] [F20-OP2.1] [F22-OP2.4] [F22-OH4]
(5)	[F20-OS2.1] [F20-OP2.1] [F22-OP2.4]
(6)	[F20-OS2.1] [F20-OP2.1] [F22-OP2.4] [F22-OH4]
<b>4.1.7.2. Classification of Buildings</b>	
(1)	[F20-OS2.1] [F20-OP2.1] [F22-OP2.4] [F22-OH4]

**Table 4.5.1.1. (Continued)**

Functional Statements and Objectives <sup>(1)</sup>	
(2)	[F20-OS2.1] [F20-OP2.1] [F22-OP2.4] [F22-OH4]
(3)	[F20-OS2.1] [F20-OP2.1] [F22-OP2.4] [F22-OH4]
<b>4.1.7.3. Static Procedure</b>	
(1)	[F20-OS2.1] [F20-OP2.1] [F22-OP2.4] [F22-OH4]
(2)	[F20-OS2.1] [F20-OP2.1] [F22-OP2.4] [F22-OH4]
(3)	[F20-OS2.1] [F20-OP2.1] [F22-OP2.4] [F22-OH4]
(4)	[F20-OS2.1] [F20-OP2.1] [F22-OP2.4] [F22-OH4]
(5)	[F20-OS2.1] [F20-OP2.1] [F22-OP2.4] [F22-OH4]
(6)	[F20-OS2.1] [F20-OP2.1] [F22-OP2.4] [F22-OH4]
(7)	[F20-OS2.1] [F20-OP2.1] [F22-OP2.4] [F22-OH4]
(8)	[F20-OS2.1] [F20-OP2.1] [F22-OP2.4] [F22-OH4]
(10)	[F20-OS2.1] [F20-OP2.1] [F22-OP2.4] [F22-OH4]
<b>4.1.7.4. Topographic Factor</b>	
(1)	[F20-OS2.1] [F20-OP2.1] [F22-OP2.4] [F22-OH4]
(2)	[F20-OS2.1] [F20-OP2.1] [F22-OP2.4] [F22-OH4]

Table 4.5.1.1. (Continued)

Functional Statements and Objectives <sup>(1)</sup>	
<b>4.1.7.5. External Pressure Coefficients</b>	
(2)	[F20-OS2.1]
	[F20-OP2.1] [F22-OP2.4]
	[F22-OH4]
(3)	[F20-OS2.1]
	[F20-OP2.1] [F22-OP2.4]
	[F22-OH4]
(4)	[F20-OS2.1]
	[F20-OP2.1] [F22-OP2.4]
	[F22-OH4]
(5)	[F20-OS2.1]
<b>4.1.7.6. External Pressure Coefficients for Low Buildings</b>	
(2)	[F20-OS2.1]
	[F20-OP2.1] [F22-OP2.4]
	[F22-OH4]
(3)	[F20-OS2.1]
	[F20-OP2.1] [F22-OP2.4]
	[F22-OH4]
(4)	[F20-OS2.1]
	[F20-OP2.1] [F22-OP2.4]
	[F22-OH4]
(5)	[F20-OS2.1]
	[F20-OP2.1] [F22-OP2.4]
	[F22-OH4]
(6)	[F20-OS2.1]
	[F20-OP2.1] [F22-OP2.4]
	[F22-OH4]
(7)	[F20-OS2.1]
	[F20-OP2.1] [F22-OP2.4]
	[F22-OH4]
(8)	[F20-OS2.1]
	[F20-OP2.1] [F22-OP2.4]
	[F22-OH4]
(9)	[F20-OS2.1]
	[F20-OP2.1] [F22-OP2.4]
	[F22-OH4]
<b>4.1.7.7. Internal Pressure Coefficient</b>	
(1)	[F20-OS2.1]
	[F20-OP2.1] [F22-OP2.4]
	[F22-OH4]

Table 4.5.1.1. (Continued)

Functional Statements and Objectives <sup>(1)</sup>	
<b>4.1.7.8. Dynamic Procedure</b>	
(1)	[F20-OS2.1]
	[F20-OP2.1] [F22-OP2.4]
	[F22-OH4]
(2)	[F20-OS2.1]
	[F20-OP2.1] [F22-OP2.4]
	[F22-OH4]
(3)	[F20-OS2.1]
	[F20-OP2.1] [F22-OP2.4]
	[F22-OH4]
(4)	[F20-OS2.1]
	[F20-OP2.1] [F22-OP2.4]
	[F22-OH4]
<b>4.1.7.9. Full and Partial Wind Loading</b>	
(1)	[F20-OS2.1]
	[F20-OP2.1] [F22-OP2.4]
	[F22-OH4]
<b>4.1.7.10. Interior Walls and Partitions</b>	
(1)	[F20-OS2.1]
	[F20-OP2.1] [F22-OP2.4]
<b>4.1.7.11. Exterior Ornamentations, Equipment and Appendages</b>	
(1)	[F20-OS2.1]
	[F20-OP2.1] [F22-OP2.4]
<b>4.1.7.12. Wind Tunnel Procedure</b>	
(1)	[F20-OS2.1]
	[F20-OP2.1] [F22-OP2.4]
	[F22-OH4]
(2)	[F20-OS2.1]
	[F20-OP2.1] [F22-OP2.4]
	[F22-OH4]
(3)	[F20-OS2.1]
	[F20-OP2.1] [F22-OP2.4]
	[F22-OH4]
<b>4.1.8.1. Analysis</b>	
(2)	(a) [F20-OS2.1]
	(a) [F20-OP2.1,OP2.3] [F22-OP2.4]
	(b) [F20-OS2.1]
(3)	(b) [F20-OP2.1] [F22-OP2.4]
	[F20-OS2.1]
(4)	[F20-OP2.1,OP2.4]
	[F20-OS2.1]
(4)	[F20-OP2.1] [F22-OP2.4]



**Table 4.5.1.1. (Continued)**

Functional Statements and Objectives <sup>(1)</sup>	
(5)	[F20-OS2.1]
	[F20-OP2.1] [F22-OP2.4]
(6)	[F20-OS2.1]
	[F20-OP2.1] [F22-OP2.4]
(7)	[F20-OS2.1]
	[F20-OP2.1] [F22-OP2.4]
(8)	[F20-OS2.1]
	[F20-OP2.1] [F22-OP2.4]
(9)	[F20-OS2.1]
	[F20-OP2.1] [F22-OP2.4]
(10)	[F20-OS2.1]
	[F20-OP2.1] [F22-OP2.4]
(11)	[F20-OS2.1]
	[F20-OP2.1] [F22-OP2.4]
(12)	[F20-OS2.1]
	[F20-OP2.1] [F22-OP2.4]
(13)	[F20-OS2.1]
	[F20-OP2.3] [F22-OP2.3,OP2.4]
(14)	[F20-OS2.1]
	[F20-OP2.3] [F22-OP2.3,OP2.4]
<b>4.1.8.3. General Requirements</b>	
(2)	[F20-OS2.1]
	[F20-OP2.1,OP2.4]
(3)	[F20-OS2.1]
	[F20-OP2.1] [F22-OP2.4]
(4)	[F20-OS2.1]
	[F20-OP2.1] [F22-OP2.4]
(5)	[F20-OS2.1]
	[F20-OP2.1] [F22-OP2.4]
(6)	[F20-OS2.1]
	[F20-OP2.1] [F22-OP2.4]
(7)	[F20-OS2.1]
	[F20-OP2.1] [F22-OP2.4]
(8)	[F20-OS2.1]
	[F20-OP2.1] [F22-OP2.4]
<b>4.1.8.4. Site Properties</b>	
(1)	[F20-OS2.1]
	[F20-OP2.1] [F22-OP2.4]
(2)	[F20-OS2.1]
	[F20-OP2.1] [F22-OP2.4]
(4)	[F20-OS2.1]
	[F20-OP2.1] [F22-OP2.4]

**Table 4.5.1.1. (Continued)**

Functional Statements and Objectives <sup>(1)</sup>	
(5)	[F20-OS2.1]
	[F20-OP2.1] [F22-OP2.4]
(6)	[F20-OS2.1]
	[F20-OP2.1] [F22-OP2.4]
(9)	[F20-OS2.1]
	[F20-OP2.1] [F22-OP2.4]
<b>4.1.8.5. Importance Factor</b>	
(1)	[F20-OS2.1]
	[F20-OP2.1,OP2.3] [F22-OP2.4]
<b>4.1.8.6. Structural Configuration</b>	
(3)	[F20-OS2.1]
	[F20-OP2.1] [F22-OP2.4]
<b>4.1.8.7. Methods of Analysis</b>	
(1)	[F20-OS2.1]
	[F20-OP2.1] [F22-OP2.4]
<b>4.1.8.8. Direction of Loading</b>	
(1)	[F20-OS2.1]
	[F20-OP2.1] [F22-OP2.4]
<b>4.1.8.9. SFRS Force Reduction Factors, System Overstrength Factors, and General Restrictions</b>	
(1)	[F20-OS2.1]
	[F20-OP2.1] [F22-OP2.4]
(2)	[F20-OS2.1]
	[F20-OP2.1] [F22-OP2.4]
(3)	[F20-OS2.1]
	[F20-OP2.1] [F22-OP2.4]
(4)	[F20-OS2.1]
	[F20-OP2.1] [F22-OP2.4]
<b>4.1.8.10. Additional System Restrictions</b>	
(1)	[F20-OS2.1]
	[F20-OP2.1] [F22-OP2.4]
(2)	(a) [F20-OP2.3] [F22-OP2.4]
	(b) [F20-OP2.3] [F22-OP2.4]
	(c) [F20-OP2.3] [F22-OP2.4]
	(d) [F20-OP2.3] [F22-OP2.4]
(3)	[F20-OS2.1]
	[F20-OP2.1] [F22-OP2.4]
(4)	[F20-OS2.1]
	[F20-OP2.1] [F22-OP2.4]
(6)	[F22-OS2.3,OS2.4]
	[F22-OP2.3,OP2.4]
(7)	[F22-OS2.1]
	[F20-OP2.1] [F22-OP2.4]

Table 4.5.1.1. (Continued)

Functional Statements and Objectives <sup>(1)</sup>	
<b>4.1.8.11. Equivalent Static Force Procedure for Structures Satisfying the Conditions of Article 4.1.8.7.</b>	
(2)	[F20-OS2.1] [F20-OP2.1] [F22-OP2.4]
(3)	[F20-OS2.1] [F20-OP2.1] [F22-OP2.4]
(4)	[F20-OS2.1] [F20-OP2.1] [F22-OP2.4]
(5)	[F20-OS2.1] [F20-OP2.1] [F22-OP2.4]
(6)	[F20-OS2.1] [F20-OP2.1] [F22-OP2.4]
(7)	[F20-OS2.1] [F20-OP2.1] [F22-OP2.4]
(8)	[F20-OS2.1] [F20-OP2.1] [F22-OP2.4]
(9)	(a) [F20-OS2.1] (a) [F20-OP2.1] [F22-OP2.4] (b) [F20-OS2.1] (b) [F20-OP2.1] [F22-OP2.4]
(10)	[F20-OS2.1] [F20-OP2.1] [F22-OP2.4]
(11)	(a) [F20-OP2.1] [F22-OP2.4] (a) [F20-OS2.1] (b) [F20-OS2.1] (b) [F20-OP2.1] [F22-OP2.4]
(12)	[F20-OS2.1] [F20-OP2.1] [F22-OP2.4]
<b>4.1.8.12. Dynamic Analysis Procedure</b>	
(1)	[F20-OS2.1] [F20-OP2.1] [F22-OP2.4]
(2)	[F20-OS2.1] [F20-OP2.1] [F22-OP2.4]
(3)	[F20-OS2.1] [F20-OP2.1] [F22-OP2.4]
(4)	(a) [F20-OS2.1] (a) [F20-OP2.1] [F22-OP2.4]
(5)	[F20-OS2.1] [F20-OP2.1,OP2.3] [F22-OP2.4]
(7)	[F20-OS2.1] [F20-OP2.1,OP2.3] [F22-OP2.4]
(8)	[F20-OS2.1] [F20-OP2.1] [F22-OP2.4]

Table 4.5.1.1. (Continued)

Functional Statements and Objectives <sup>(1)</sup>	
(9)	[F20-OS2.1] [F20-OP2.1] [F22-OP2.4]
(10)	[F20-OS2.1] [F20-OP2.1] [F22-OP2.4]
(12)	[F20-OS2.1] [F20-OP2.1] [F22-OP2.4]
<b>4.1.8.13. Deflections and Drift Limits</b>	
(1)	[F22-OS2.3,OS2.4] [F22-OP2.3,OP2.4]
(2)	[F22-OS2.3,OS2.4] [F22-OP2.3,OP2.4]
(3)	[F22-OS2.3,OS2.4] [F22-OP2.3,OP2.4]
<b>4.1.8.14. Structural Separation</b>	
(1)	[F22-OS2.3,OS2.4] [F22-OP2.3,OP2.4] [F22-OP4.3]
(2)	[F20-OS2.1,OS2.3,OS2.4] [F20-OP2.1,OP2.3,OP2.4] [F20-OP4.3]
(3)	[F20-OS2.1,OS2.3,OS2.4] [F20-OP2.1,OP2.3,OP2.4] [F20-OP4.3]
(4)	[F20-OS2.1,OS2.3,OS2.4] [F20-OP2.1,OP2.3,OP2.4] [F20-OP4.3]
<b>4.1.8.15. Design Provisions</b>	
(1)	[F20-OS2.1] [F20-OP2.1,OP2.3,OP2.4]
(2)	[F20-OS2.1] [F20-OP2.1,OP2.3,OP2.4]
(3)	[F20-OS2.1] [F20-OP2.1,OP2.3,OP2.4]
(4)	[F20-OS2.1] [F20-OP2.1] [F22-OP2.4]
(5)	[F20-OS2.1] [F20-OP2.1,OP2.4]
(6)	[F20-OS2.1,OS2.4] [F20-OP2.1,OP2.4]
(7)	[F20-OS2.1] [F20-OP2.1] [F22-OP2.4]

**Table 4.5.1.1. (Continued)**

Functional Statements and Objectives <sup>(1)</sup>	
<b>4.1.8.16. Foundation Provisions</b>	
(1)	[F22-OS2.3,OS2.4]
	[F22-OP2.3,OP2.4]
(2)	[F20-OS2.1] Applies to portion of Code text: “Foundations shall be designed to resist the lateral load capacity of the SFRS...”
	[F20-OP2.1] Applies to portion of Code text: “Foundations shall be designed to resist the lateral load capacity of the SFRS...”
(5)	[F20-OS2.2,OS2.4]
	[F20-OP2.2,OP2.4]
(6)	(a) [F22-OS2.4]
	(a) [F22-OP2.4]
	(b) [F22-OS2.4]
	(b) [F22-OP2.4]
	(c) [F20-OS2.4]
	(c) [F20-OP2.4]
(7)	[F20-OS2.1]
	[F20-OP2.1,OP2.4]
(8)	(a) [F20-OS2.1]
	(a) [F20-OP2.1]
	(b) [F22-OS2.4]
	(b) [F22-OP2.4]
(9)	[F20-OS2.4]
	[F20-OP2.4]
(10)	[F20-OS2.2] [F22-OS2.4]
	[F20-OP2.2] [F22-OP2.4]
<b>4.1.8.17. Site Stability</b>	
(1)	[F20-OS2.1]
	[F20-OP2.1] [F22-OP2.4]
<b>4.1.8.18. Elements of Structures, Non-structural Components and Equipment</b>	
(1)	[F20,F22-OS2.4]
	[F20-OP2.3] [F22-OP2.3,OP2.4]
(4)	[F20,F22-OS2.4]
	[F20,F22-OP2.3,OP2.4]
(5)	[F20,F22-OS2.1]
	[F20,F22-OP2.1,OP2.4]
(6)	[F20,F22-OS2.4]
	[F20,F22-OP2.3,OP2.4]

**Table 4.5.1.1. (Continued)**

Functional Statements and Objectives <sup>(1)</sup>		
(7)	[F20,F22-OS2.4] Applies to portion of Code text: “Connections to the structure of elements and components listed in Table 4.1.8.18. shall be designed to support the component or element for gravity loads, shall conform to the requirements of Sentence 4.1.8.18.(1) ...”	
	[F20,F22-OP2.3,OP2.4] Applies to portion of Code text: “Connections to the structure of elements and components listed in Table 4.1.8.18. shall be designed to support the component or element for gravity loads, shall conform to the requirements of Sentence 4.1.8.18.(1)...”	
	(a) [F20,F22-OS2.4]	
	(a) [F20,F22-OP2.3,OP2.4]	
	(b),(c) [F20,F22-OS2.4]	
	(b),(c) [F20,F22-OP2.3,OP2.4]	
	(d) [F20,F22-OS2.4]	
	(d) [F20,F22-OP2.3,OP2.4]	
	(e) [F20,F22-OS2.4]	
	(e) [F20,F22-OP2.3,OP2.4]	
	(9)	[F22-OS2.3,OS2.4]
		[F22-OP2.3,OP2.4]
(10)	[F22-OS2.1,OS2.3,OS2.4]	
	[F22-OP2.1,OP2.3,OP2.4]	
(11)	[F20-OS2.1] [F22-OS2.4]	
	[F20,F22-OP2.3,OP2.4]	
(12)	[F20-OS2.1] [F22-OS2.3]	
	[F20-OP2.1] [F22-OP2.3]	
(14)	[F22-OS2.4]	
(16)	[F20,F22-OS2.4]	
	[F20-OP2.3] [F22-OP2.3,OP2.4]	
<b>4.1.8.19. Seismic Isolation</b>		
(2)	[F20-OS2.1] [F22-OS2.4]	
	[F20-OP2.1] [F22-OP2.4]	
(3)	[F20-OS2.1]	
	[F20-OP2.1] [F22-OP2.4]	
(4)	[F20-OS2.1]	
	[F20-OP2.1] [F22-OP2.4]	
<b>4.1.8.20. Seismic Isolation Design Provisions</b>		
(1)	[F20-OS2.1]	
	[F20-OP2.1] [F22-OP2.4]	
(2)	[F20-OS2.1]	
	[F20-OP2.1] [F22-OP2.4]	
(3)	[F20-OS2.1] [F22-OS2.4]	
	[F20-OP2.1] [F22-OP2.4]	
(4)	[F20-OS2.1] [F22-OS2.4]	
	[F20-OP2.1] [F22-OP2.4]	

Table 4.5.1.1. (Continued)

Functional Statements and Objectives <sup>(1)</sup>	
(5)	[F20-OS2.1] [F22-OS2.4]
	[F20-OP2.1] [F22-OP2.4]
(6)	[F20-OS2.1] [F22-OS2.4]
	[F20-OP2.1] [F22-OP2.4]
(7)	[F20-OS2.1]
	[F20-OP2.1] [F22-OP2.4]
(9)	[F20-OS2.1] [F22-OS2.4]
	[F20-OP2.1] [F22-OP2.4]
(10)	[F22-OS2.4]
	[F22-OP2.3,OP2.4]
<b>4.1.8.21. Supplemental Energy Dissipation</b>	
(2)	[F20-OS2.1] [F22-OS2.4]
	[F20-OP2.1] [F22-OP2.4]
(4)	[F20-OS2.1]
	[F20-OP2.1] [F22-OP2.4]
(5)	[F20-OS2.1]
	[F20-OP2.1] [F22-OP2.4]
<b>4.1.8.22. Supplemental Energy Dissipation Design Considerations</b>	
(1)	[F20-OS2.1] [F22-OS2.4]
	[F20-OP2.1] [F22-OP2.4]
(3)	[F20-OS2.1] [F22-OS2.4]
	[F20-OP2.1] [F22-OP2.4]
(4)	[F20-OS2.1] [F22-OS2.4]
	[F20-OP2.1] [F22-OP2.4]
(5)	[F20-OS2.1] [F22-OS2.4]
	[F20-OP2.1] [F22-OP2.4]
(6)	[F20-OS2.1]
	[F20-OP2.1] [F22-OP2.4]
(7)	[F20-OS2.1] [F22-OS2.4]
	[F20-OP2.1] [F22-OP2.4]
(8)	[F20-OS2.1] [F22-OS2.4]
	[F20-OP2.1] [F22-OP2.4]
<b>4.2.2.1. Subsurface Investigation</b>	
(1)	[F20-OS2.2,OS2.6] [F21-OS2.6]
	[F20-OP2.2] [F21-OP2.6]
	[F21-OP4.1,OP4.4]
<b>4.2.2.3. Field Review</b>	
(1)	[F20-OS2.2,OS2.6] [F21-OS2.6]
	[F20-OP2.2] [F21-OP2.5]
	[F21-OP4.1,OP4.4]

Table 4.5.1.1. (Continued)

Functional Statements and Objectives <sup>(1)</sup>	
<b>4.2.2.4. Altered Subsurface Condition</b>	
(1)	[F20-OS2.2,OS2.6] [F21-OS2.6]
	[F20-OP2.2] [F21-OP2.6]
	[F21-OP4.1,OP4.4]
(2)	[F20-OS2.2,OS2.6] [F21-OS2.6]
	[F20-OP2.2] [F21-OP2.6]
	[F21-OP4.1,OP4.4]
<b>4.2.3.2. Preservation Treatment of Wood</b>	
(1)	[F80-OS2.3]
	[F80-OP2.3]
(2)	[F82-OS2.3]
	[F82-OP2.3]
<b>4.2.3.4. Prevention of Deterioration of Masonry</b>	
(1)	[F80-OS2.3]
	[F80-OP2.3]
<b>4.2.3.6. Protection Against Chemical Attack</b>	
(1)	[F80-OS2.3]
	[F80-OP2.3]
<b>4.2.3.8. Steel Piles</b>	
(1)	[F20-OS2.3]
	[F20-OP2.3]
<b>4.2.3.9. High Strength Steel Tendons</b>	
(1)	[F20,F80-OS2.5,OS2.6]
	[F20,F80-OP2.6,OP2.5]
	[F20,F80-OP4.1,OP4.4]
<b>4.2.3.10. Corrosion of Steel</b>	
(1)	[F80-OS2.3]
	[F80-OP2.3]
	[F80-OP4.1]
<b>4.2.4.1. Design Basis</b>	
(1)	[F20-OS2.2,OS2.6] [F21-OS2.6]
	[F20-OP2.2] [F21-OP2.5]
	[F21-OP4.1,OP4.4]
(5)	[F21-OS2.5]
	[F21-OP2.4,OP2.5]
<b>4.2.4.2. Subsurface Investigation</b>	
(1)	[F20-OS2.2,OS2.6] [F21-OS2.6]
	[F20-OP2.2] [F21-OP2.6]
	[F21-OP4.1,OP4.4]
<b>4.2.4.3. Identification</b>	
(1)	[F20-OS2.2,OS2.6] [F21-OS2.6]
	[F20-OP2.2] [F21-OP2.6]
	[F21-OP4.1,OP4.4]

**Table 4.5.1.1. (Continued)**

Functional Statements and Objectives <sup>(1)</sup>	
<b>4.2.4.4. Depth of Foundations</b>	
(1)	[F21-OP2.4] Applies to portion of Code text: "... the bearing surface of a foundation shall be below the level of potential damage, including damage resulting from frost action ..."
	[F21-OP2.4] Applies to portion of Code text: "... the foundation shall be designed to prevent damage resulting from adfreezing and frost jacking."
(2)	[F21-OP2.4]
<b>4.2.4.5. Sloping Ground</b>	
(1)	[F21-OS2.2] [F21-OP2.2,OP2.6,OP2.4]
<b>4.2.4.6. Eccentric and Inclined Loads</b>	
(1)	[F20-OS2.1,OS2.2] [F20-OP2.1,OP2.2,OP2.4]
<b>4.2.4.7. Dynamic Loading</b>	
(1)	[F20-OS2.2] [F20-OP2.2,OP2.6,OP2.4] [F20-OH4]
<b>4.2.4.8. Hydrostatic Uplift</b>	
(1)	[F22-OP2.1,OP2.4]
<b>4.2.4.9. Groundwater Level Change</b>	
(1)	[F21-OP4.1]
<b>4.2.4.10. Permafrost</b>	
(1)	[F20-OS2.2] [F21-OS2.5] [F20-OP2.2,OP2.4] [F21-OP2.6,OP2.4]
<b>4.2.4.11. Swelling and Shrinking Soils</b>	
(1)	[F21-OP2.6,OP2.4]
<b>4.2.4.12. Expanding and Deteriorating Rock</b>	
(1)	[F21-OP2.6,OP2.4]
<b>4.2.4.13. Construction on Fill</b>	
(1)	(a) [F20-OS2.2] [F21-OS2.5] (b) [F20-OP2.2,OP2.4] [F21-OP2.6,OP2.4] (c) [F01-OS1.1]
<b>4.2.5.2. Excavation Construction</b>	
(1)	[F21-OP4.1]
(2)	[F20-OS2.6] [F20-OP2.3] [F20,F21-OP4.1]
<b>4.2.5.3. Supported Excavations</b>	
(1)	[F20-OS2.6] [F21-OP4.1]
<b>4.2.5.4. Unsupported Excavations</b>	
(1)	[F20-OS2.6] [F21-OP4.1]

**Table 4.5.1.1. (Continued)**

Functional Statements and Objectives <sup>(1)</sup>	
<b>4.2.5.5. Control of Water around Excavations</b>	
(1)	[F60-OS2.6] [F60-OP4.1,OP4.4]
<b>4.2.5.6. Loss of Ground</b>	
(1)	[F21-OP4.1]
<b>4.2.5.7. Protection and Maintenance at Excavations</b>	
(1)	[F80-OS2.6] [F80-OP4.1]
<b>4.2.5.8. Backfilling</b>	
(1)	(a) [F21-OS2.1] (a) [F21-OP2.1,OP2.4] [F21-OP4.1]
(2)	[F21-OP2.4]
<b>4.2.6.2. Support of Shallow Foundations</b>	
(1)	[F20-OS2.2] [F20-OP2.2,OP2.4] [F21-OP2.4]
<b>4.2.6.3. Incorrect Placement of Shallow Foundations</b>	
(1)	[F20-OS2.2] [F20-OP2.2,OP2.4] [F21-OP2.4]
<b>4.2.6.4. Damaged Shallow Foundations</b>	
(1)	[F20-OS2.1] [F20-OP2.1,OP2.4] [F22-OP2.4]
<b>4.2.7.2. Design of Deep Foundations</b>	
(3)	[F20-OS2.1,OS2.2] [F21-OS2.5] [F20-OP2.1,OP2.2] [F21,F22-OP2.4]
(5)	[F20-OS2.1] [F20-OP2.1,OP2.4] [F22-OP2.4]
(6)	[F20-OP2.1,OP2.4]
<b>4.2.7.3. Tolerance in Alignment and Location</b>	
(1)	[F20-OS2.1] [F20-OP2.1,OP2.4] [F22-OP2.4]
<b>4.2.7.4. Incorrect Alignment and Location</b>	
(1)	[F20-OS2.1] [F20-OP2.1,OP2.4] [F22-OP2.4]
<b>4.2.7.5. Installation of Deep Foundations</b>	
(1)	[F81-OS2.1] [F21-OS2.2,OS2.6] (c) [F21-OP4.1] (a),(b) [F81-OP2.1,OP2.4] [F21-OP2.2,OP2.4]
<b>4.2.7.6. Damaged Deep Foundation Units</b>	
(1)	[F20-OS2.1] [F20-OP2.1] [F22-OP2.4]

Table 4.5.1.1. (Continued)

Functional Statements and Objectives <sup>(1)</sup>	
<b>4.2.8.2. Use of Existing Foundations</b>	
(1)	[F20-OS2.1,OS2.2]
	[F20-OP2.1,OP2.2] [F22-OP2.4]
<b>4.3.1.1. Design Basis for Wood</b>	
(1)	[F22,F21,F80-OH4]
	[F20-OS2.1] [F80-OS2.3]
	[F20-OP2.1] [F21,F22-OP2.4] [F80-OP2.3,OP2.4]
<b>4.3.1.2. Glued-Laminated Members</b>	
(1)	[F20-OS2.1]
	[F20-OP2.1] [F21,F22-OP2.4]
	[F21,F22-OH4]
<b>4.3.2.1. Design Basis for Plain and Reinforced Masonry</b>	
(1)	[F21,F22,F80-OH4]
	[F20-OS2.1] [F80-OS2.3]
	[F20-OP2.1] [F22,F21-OP2.4] [F80-OP2.3,OP2.4]
<b>4.3.3.1. Design Basis for Plain, Reinforced and Pre-stressed Concrete</b>	
(1)	[F20-OS2.1] [F80,F81-OS2.3]
	[F20-OP2.1] [F21,F22-OP2.4] [F80,F81-OP2.3,OP2.4]
	[F21,F22,F80,F81-OH4]
<b>4.3.4.1. Design Basis for Structural Steel</b>	
(1)	[F20-OS2.1] [F80-OS2.3]
	[F20-OP2.1] [F20,F22-OP2.4] [F80-OP2.3,OP2.4]
	[F22,F80-OH4]
<b>4.3.4.2. Design Basis for Cold-Formed Steel</b>	
(1)	[F20-OS2.1] [F80-OS2.3]
	[F20-OP2.1] [F20,F22-OP2.4] [F80-OP2.3,OP2.4]
	[F22,F80-OH4]
<b>4.3.5.1. Design Basis for Aluminum</b>	
(1)	[F20-OS2.1] [F80-OS2.3]
	[F20-OP2.1] [F20,F22-OP2.4] [F80-OP2.3,OP2.4]
	[F22,F80-OH4]
<b>4.3.6.1. Design Basis for Glass</b>	
(1)	[F20-OS2.1]
	[F20-OP2.1]
<b>4.4.1.1. Design Basis for Air-Supported Structures</b>	
(1)	[F20-OS2.1] [F80-OS2.3]
	[F20-OP2.1] [F22-OP2.4] [F80-OP2.3]
	[F22-OH4]
<b>4.4.2.1. Design Basis for Parking Structures and Repair Garages</b>	
(1)	[F21,F61,F80-OS2.3]
	[F21,F61,F80-OP2.3,OP2.4]
	[F21,F61,F80-OH4]

Table 4.5.1.1. (Continued)

**Notes to Table 4.5.1.1.:**

(1) See Parts 2 and 3 of Division A.

# Notes to Part 4 Structural Design

**A-4.1.1.3.(1) Structural Integrity.** The requirements of Part 4, including the CSA design standards, generally provide a satisfactory level of structural integrity. Additional considerations may, however, be required for building systems made of components of different materials, whose interconnection is not covered by existing CSA design standards, buildings outside the scope of existing CSA design standards, and buildings exposed to severe accidental loads such as vehicle impact or explosion. Further guidance can be found in the Commentary entitled Structural Integrity in the “User’s Guide – NBC 2015, Structural Commentaries (Part 4 of Division B).”

**A-4.1.1.3.(2) Serviceability.** Information on serviceability can be found in the Commentary entitled Deflection and Vibration Criteria for Serviceability and Fatigue Limit States in the “User’s Guide – NBC 2015, Structural Commentaries (Part 4 of Division B).”

**A-4.1.1.5.(2) Structural Equivalents.** Sentence 4.1.1.5.(2) provides for the use of design methods not specified in Part 4, including full-scale testing and model analogues. This provision is usually used to permit the acceptance of new and innovative structures or to permit the acceptance of model tests such as those used to determine structural behaviour, or snow or wind loads. Sentence 4.1.1.5.(2) specifically requires that the level of safety and performance be at least equivalent to that provided by design to Part 4 and requires that loads and designs conform to Section 4.1.

Sentence 4.1.1.5.(2) and the provision for alternative solutions stated in Clause 1.2.1.1.(1)(b) of Division A are not intended to allow structural design using design standards other than those listed in Part 4. The acceptance of structures that have been designed to other design standards would require the designer to prove to the appropriate authority that the structure provides the level of safety and performance required by Clause 1.2.1.1.(1)(b) of Division A. The equivalence of safety and performance can only be established by analyzing the structure for the loads and load factors set out in Section 4.1. and by demonstrating that the structure at least meets the requirements of the design standards listed in Sections 4.3. and 4.4.

**A-4.1.2.1. Loads and Effects.** Information on the definitions can be found in the Commentary entitled Limit States Design in the “User’s Guide – NBC 2015, Structural Commentaries (Part 4 of Division B).”

**A-4.1.2.1.(1) Temperature Changes.** Information on effects due to temperature changes can be found in the Commentary entitled Effects of Deformations in Building Components in the “User’s Guide – NBC 2015, Structural Commentaries (Part 4 of Division B).”

**A-4.1.2.1.(3) Major Occupancies.** In a building containing more than one major occupancy and classified in more than one Importance Category, the classification of each independent structural system shall be the same as for any part of the building that is dependent on that structural system and for the highest usage group according to Table 4.1.2.1.

### **A-Table 4.1.2.1. Importance Categories for Buildings.**

#### **Low Importance Category Buildings**

Low human-occupancy farm buildings are defined in the National Farm Building Code of Canada 1995 as having an occupant load of 1 person or less per 40 m<sup>2</sup> of floor area. Minor storage buildings include only those storage buildings that represent a low direct or indirect hazard to human life in the event of structural

---

These Notes are included for explanatory purposes only and do not form part of the requirements. The number that introduces each Note corresponds to the applicable requirement in this Part.

failure, either because people are unlikely to be affected by structural failure, or because structural failure causing damage to materials or equipment does not present a direct threat to human life.

#### **Buildings Containing Hazardous Materials**

The following buildings contain sufficient quantities of toxic, explosive or other hazardous substances to be classified in the High Importance Category of use and occupancy:

- petrochemical facilities,
- fuel storage facilities (other than those required for post-disaster use), and
- manufacturing or storage facilities for dangerous goods.

The following types of buildings may be classified in the Normal Importance Category: buildings that are equipped with secondary containment of toxic, explosive or other hazardous substances, including but not limited to, double-wall tanks, dikes of sufficient size to contain a spill, or other means to contain a spill or a blast within the property boundary of the facility and prevent the release of harmful quantities of contaminants to the air, soil, groundwater, surface water or atmosphere, as the case may be.

**A-4.1.3. Limit States Design.** Information on limit states design can be found in the Commentary entitled Limit States Design in the “User’s Guide – NBC 2015, Structural Commentaries (Part 4 of Division B).”

#### **A-4.1.3.2.(2) Load Combinations.**

##### **Load Combination Equations**

The load combinations in Tables 4.1.3.2.-A and 4.1.3.2.-B apply to most situations for loadbearing building structures. Guidance on special situations such as load combinations for fire resistance and building envelopes is given in the Commentary entitled Limit States Design in the “User’s Guide – NBC 2015, Structural Commentaries (Part 4 of Division B).”

##### **Load Cases and Crane Load Effects**

The load combinations in Table 4.1.3.2.-A are to be evaluated for structures with crane load effects for the scenario where the crane loads are zero, and for structures without crane loads. The load combinations in Table 4.1.3.2.-B are to be evaluated for structures with crane loads for the scenario where the crane load effects are other than zero.

##### **Crane Loads**

Crane-supporting structures that have cranes in multiple parallel bays should be designed for the maximum vertical crane load with the cranes positioned for the most critical effect in conjunction with a lateral load with each crane in turn positioned for the most critical effect. For load combinations that include crane loads, additional guidance can be found in CISC/ICCA 2013, “Crane-Supporting Steel Structures: Design Guide.”

#### **A-4.1.3.2.(4) Effects of Lateral Earth Pressure, H, Pre-stress, P, and Imposed Deformation, T, in Design Calculations.**

##### **Effects of Lateral Earth Pressure, H, in Design Calculations**

For common building structures below ground level, such as walls, columns and frames, 1.5 H is added to load combinations 2 to 4. For cantilever retaining wall structures, see the Commentary entitled Limit States Design in the “User’s Guide – NBC 2015, Structural Commentaries (Part 4 of Division B).”

##### **Effects of Pre-stress, P, and Imposed Deformation, T, in Design Calculations**

For structures and building envelopes designed in accordance with the requirements specified in the standards listed in Section 4.3., with the exception of Clauses 8 and 18 of CSA A23.3, “Design of Concrete Structures,” P and T need not be included in the load combinations of Table 4.1.3.2.-A. For structures not within the scope of the standards listed in Section 4.3., including building envelopes, P and T must be taken into account in the design calculations. For recommended load combinations including T, see the Commentary entitled Limit States Design in the “User’s Guide – NBC 2015, Structural Commentaries (Part 4 of Division B).”



**A-4.1.3.2.(5) Overturning, Uplift or Sliding.** Information on overturning, uplift and sliding can be found in the Commentary entitled Limit States Design in the “User’s Guide – NBC 2015, Structural Commentaries (Part 4 of Division B).”

**A-4.1.3.3.(1) Failure due to Fatigue.** Failure due to fatigue of building structures referred to in Section 4.3. and designed for serviceability in accordance with Article 4.1.3.6. is, in general, unlikely except for girders supporting heavily used cranes, on which Article 4.1.5.11. provides guidance.

**A-4.1.3.3.(2) Vibration Effects.** Guidance on vibration effects can be found in the Commentary entitled Deflection and Vibration Criteria for Serviceability and Fatigue Limit States in the “User’s Guide – NBC 2015, Structural Commentaries (Part 4 of Division B).”

**A-4.1.3.4.(1) Loads and Load Combinations for Serviceability.** The loads and load combinations for serviceability depend on the serviceability limit states and on the properties of the structural materials. Information on loads and load combinations for the serviceability limit states, other than those controlled by deflection, can be found in the Commentary entitled Deflection and Vibration Criteria for Serviceability and Fatigue Limit States in the “User’s Guide – NBC 2015, Structural Commentaries (Part 4 of Division B).”

**A-4.1.3.5.(1) Deflections.** Serviceability criteria for deflections that cause damage to non-structural building components can be found in the standards listed in Section 4.3. Information on deflections can be found in the Commentary entitled Deflection and Vibration Criteria for Serviceability and Fatigue Limit States in the “User’s Guide – NBC 2015, Structural Commentaries (Part 4 of Division B).” Information on loads and load combinations for calculating deflection can be found in the Commentary entitled Limit States Design in the “User’s Guide – NBC 2015, Structural Commentaries (Part 4 of Division B).”

**A-4.1.3.5.(3) Lateral Deflection of Buildings.** The limitation of 1/500 drift per storey may be exceeded if it can be established that the drift as calculated will not result in damage to non-structural elements. Information on lateral deflection can be found in the Commentary entitled Wind Load and Effects in the “User’s Guide – NBC 2015, Structural Commentaries (Part 4 of Division B).”

**A-4.1.3.6.(1) Floor Vibration.** Information on floor vibration can be found in the Commentary entitled Deflection and Vibration Criteria for Serviceability and Fatigue Limit States in the “User’s Guide – NBC 2015, Structural Commentaries (Part 4 of Division B).” Information on loads and load combinations for the calculation of vibration can be found in the Commentary entitled Limit States Design in the “User’s Guide – NBC 2015, Structural Commentaries (Part 4 of Division B).”

**A-4.1.3.6.(2) Dynamic Analyses of Floor Vibrations.** Information on a dynamic analysis of floor vibrations from rhythmic activities can be found in the Commentary entitled Deflection and Vibration Criteria for Serviceability and Fatigue Limit States in the “User’s Guide – NBC 2015, Structural Commentaries (Part 4 of Division B).”

**A-4.1.3.6.(3) Lateral Vibration Under Wind Load.** Information on lateral vibrations and accelerations under dynamic wind loads can be found in the Commentary entitled Wind Load and Effects in the “User’s Guide – NBC 2015, Structural Commentaries (Part 4 of Division B).”

**A-4.1.4.1.(6) Counteracting Dead Load Due to Soil.** Examples of structures that traditionally employ the dead load of soil to resist loadings are pylon signs, tower structures, retaining walls, and deadmen, which resist wind uplift and overturning in light structures.

**A-4.1.5.1.(1) Loads Due to Use of Floors and Roofs.** In many areas of buildings, such as equipment areas, service rooms, factories, storage areas, warehouses, museums, and office filing areas, live loads due to their intended use may exceed the minimum specified loads listed in Table 4.1.5.3. In these instances, the probable live load shall be calculated and used as the specified live load for the design of that particular area.

#### **A-Table 4.1.5.3. Considerations for Live Loads.**

##### **Arenas, Grandstands and Stadia**

The designer should give special consideration to the effects of vibration.

**Attics - Limited Accessibility**

Attic live loading is not required when the ceiling below the attic consists of removable panels that permit access to the ceiling space without loading the ceiling supporting members. Attic live loading is not required in any area of the attic where the least dimension of the attic space is less than 500 mm.

**Corridors, Aisles and Rows of Seats**

The spaces between rows of seats are typically designed for the loads of the occupancy they serve. Rows of seats typically discharge into aisles that are designed for the loads used for the rows of seats. Corridors have a minimum width of 1 100 mm and may serve as collectors for aisles; they are therefore part of the exit system and are required to be designed for a minimum live load of 4.8 kPa.

**Floor Areas That Could Be Used As Viewing Areas**

Some interior balconies, mezzanines, corridors, lobbies and aisles that are not intended to be used by an assembly of people as viewing areas are sometimes used as such; consequently, they are subject to loadings much higher than those for the occupancies they serve. Floor areas that may be subject to such higher loads must, therefore, be designed for a loading of 4.8 kPa.

**Lecture Halls and Classrooms**

For the purposes of applying the requirements of Table 4.1.5.3., lecture halls with fixed seats are similar to theatres in configuration (the seats may have a writing tablet affixed to one arm). Classrooms are typically furnished with full-sized desks having separate or integrated seats.

**Minimum Roof Live Load**

Articles 4.1.5.3. and 4.1.5.10. stipulate a minimum uniform roof live load of 1.0 kPa and a minimum concentrated live load of 1.3 kN. These live loads are “use and occupancy loads” intended to provide for maintenance loadings: they are not reduced as a function of area or as a function of the roof slope due to their variability in distribution and location.

**Vehicle Loads**

A special study should be undertaken to determine the distributed loads to be used for the design of floors and areas used by vehicles exceeding 9 000 kg gross weight and of driveways and sidewalks over areaways and basements. Where appropriate, the designer should refer to CSA S6, “Canadian Highway Bridge Design Code.”

**A-4.1.5.5. Loads on Exterior Areas.** In Article 4.1.5.5., “accessible” refers to the lack of a physical barrier that prevents or restricts access by vehicles or persons to the site in the context of the specific use.

**A-4.1.5.8. Tributary Area.** Information on tributary area can be found in the Commentary entitled Live Loads in the “User’s Guide – NBC 2015, Structural Commentaries (Part 4 of Division B).”

**A-Table 4.1.5.9. Loads Due to Concentrations.** Special study is required to determine concentrated loads for the design of floors and areas used by vehicles exceeding 9 000 kg gross weight, and of driveways and sidewalks over areaways and basements. Where appropriate the designer should refer to CSA S6, “Canadian Highway Bridge Design Code.”

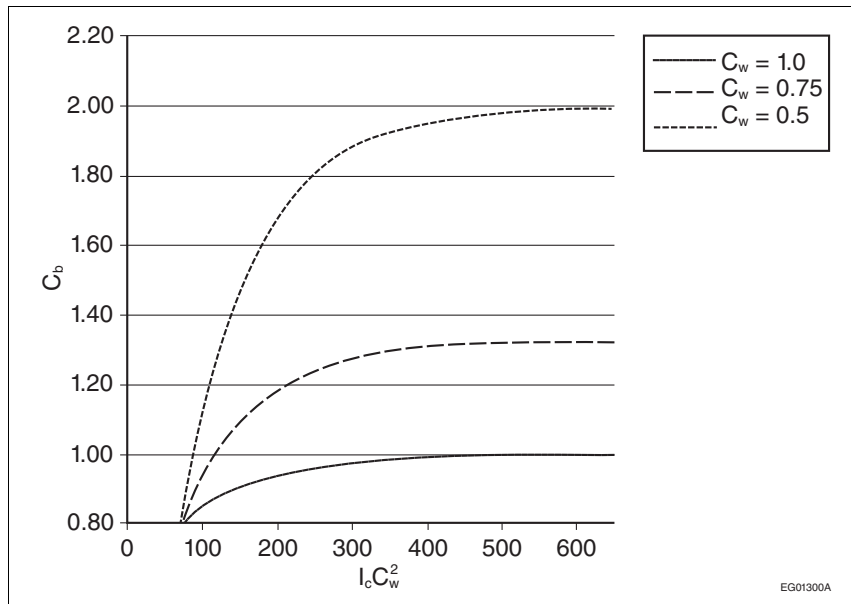
**A-4.1.5.11. Crane-Supporting Structures.** Guidance on crane-supporting structures can be found in CSA S16, “Design of Steel Structures.”

**A-4.1.5.14. and 4.1.5.15.(1) Design of Guards.** In the design of guards, due consideration should be given to the durability of the members and their connections.

**A-4.1.5.17. Loads on Firewalls.** Information on loads on firewalls can be found in the Commentary entitled Structural Integrity of Firewalls in the “User’s Guide – NBC 2015, Structural Commentaries (Part 4 of Division B).”

**A-4.1.6.2. Coefficients for Snow Loads on Roofs.** Information on coefficients for snow loads on roofs can be found in the Commentary entitled Snow Loads in the “User’s Guide – NBC 2015, Structural Commentaries (Part 4 of Division B).”

**A-4.1.6.2.(2) Basic Roof Snow Load Factor.** Figure A-4.1.6.2.(2) shows the basic roof snow load factor,  $C_b$ , plotted against  $I_c C_w^2$ .



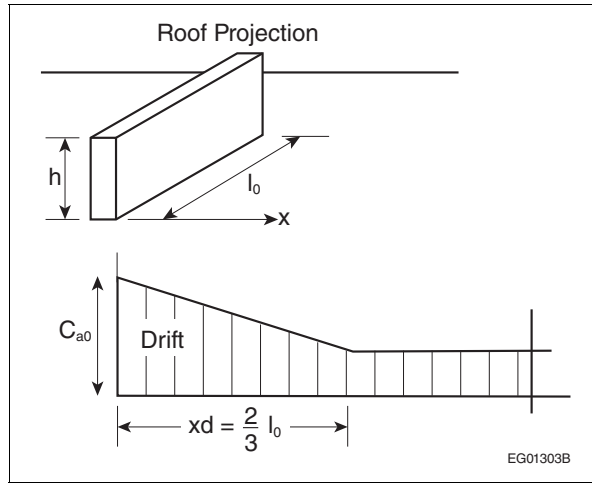
**Figure A-4.1.6.2.(2)**  
Basic roof snow load factor,  $C_b$

**A-4.1.6.3.(2) Full and Partial Loading under Snow Loads.** Information on full and partial snow loading on roofs can be found in the Commentary entitled Snow Loads in the “User’s Guide – NBC 2015, Structural Commentaries (Part 4 of Division B).”

**A-4.1.6.4.(1) Rain Loads.** Information on rain loads can be found in the Commentary entitled Rain Loads in the “User’s Guide – NBC 2015, Structural Commentaries (Part 4 of Division B).”

**A-4.1.6.4.(3) Flow Control Drains.** The National Plumbing Code of Canada 2015 (NPC) contains requirements regarding the use of flow control roof drains. The designer must ensure that the building complies with both the NPC and the NBC.

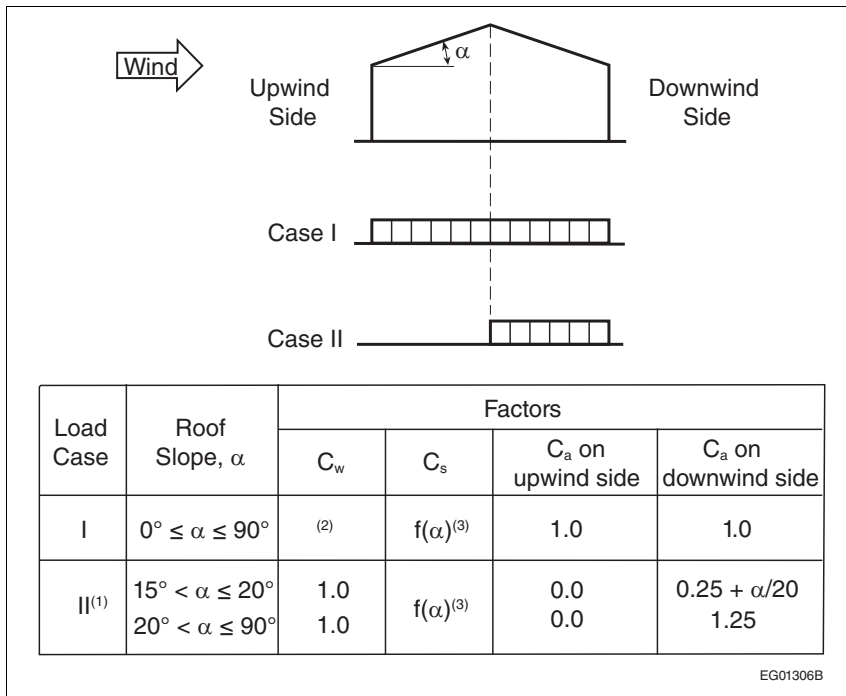
**A-4.1.6.7.(1) Roof Projections.** Elevator, air-conditioning and fan housings, small penthouses and wide chimneys are examples of roof projections.



**Figure A-4.1.6.7.(1)**  
Roof projections

**A-4.1.6.7.(2) Values of  $C_a$  for Small Roof Projections.** Calculating  $C_a$  in accordance with Article 4.1.6.5. rather than Sentence 4.1.6.7.(1) results in lower values for small projections.

**A-4.1.6.9. Snow on Gable Roofs.**



**Figure A-4.1.6.9.**  
Load cases for gable roofs

**Notes to Figure A-4.1.6.9.:**

- (1) Case II loading does not apply to gable roofs with slopes of 15° or less, to single-sloped (shed) roofs, or to flat roofs.
- (2) The value of  $C_w$  for load case I is as prescribed in Sentences 4.1.6.2.(3) and (4).
- (3) Varies as a function of slope,  $\alpha$ , as defined in Sentences 4.1.6.2.(5) and (6).

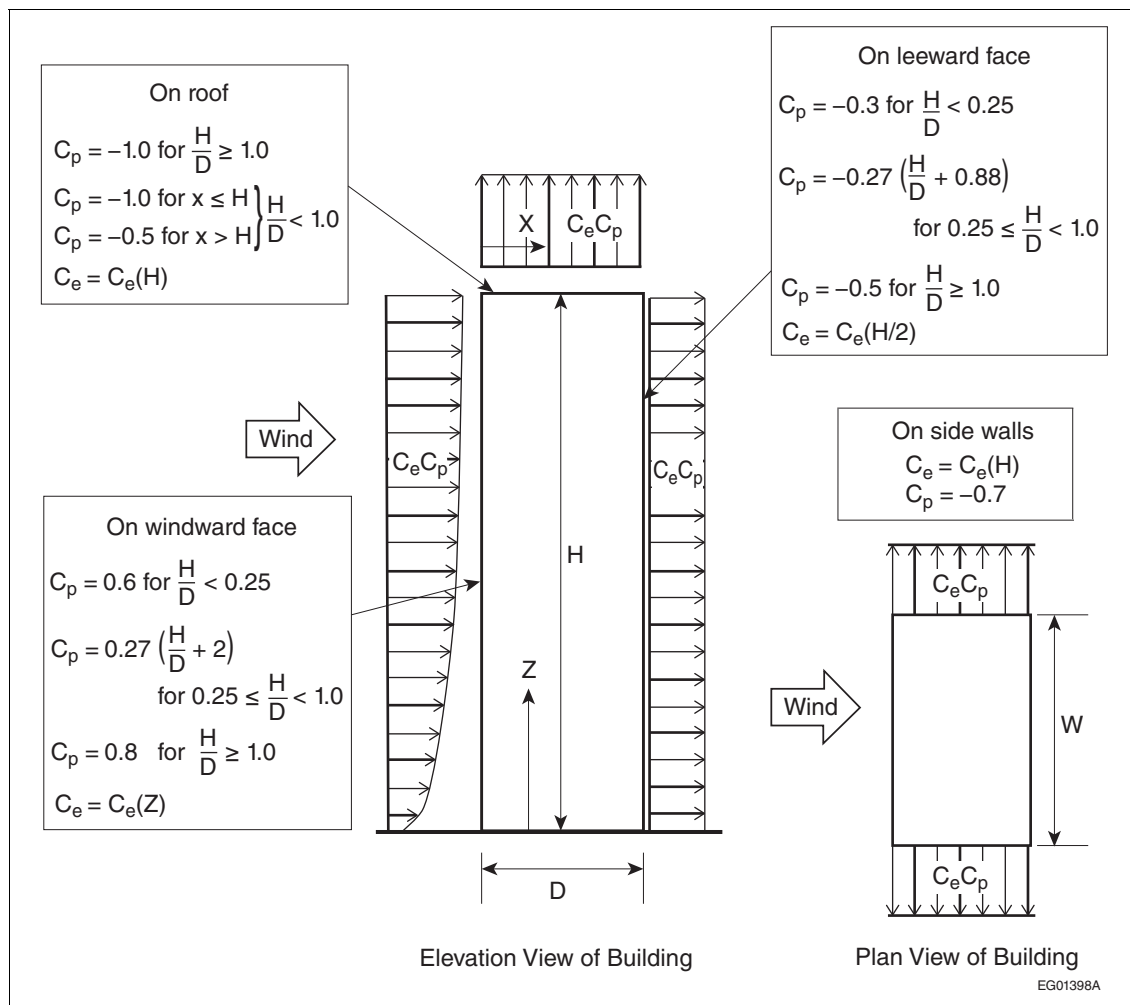
**A-4.1.7.1.(6) Computational Fluid Dynamics (CFD).** It is not currently possible to verify the reliability and accuracy of CFD and no standards address it; as such, this method is not permitted to be used to determine specified wind loads.

**A-4.1.7.2.(1) and (2) Natural Frequency.** Information on calculating the natural frequency of a building can be found in the Commentary entitled Wind Load and Effects in the “User’s Guide – NBC 2015, Structural Commentaries (Part 4 of Division B).”

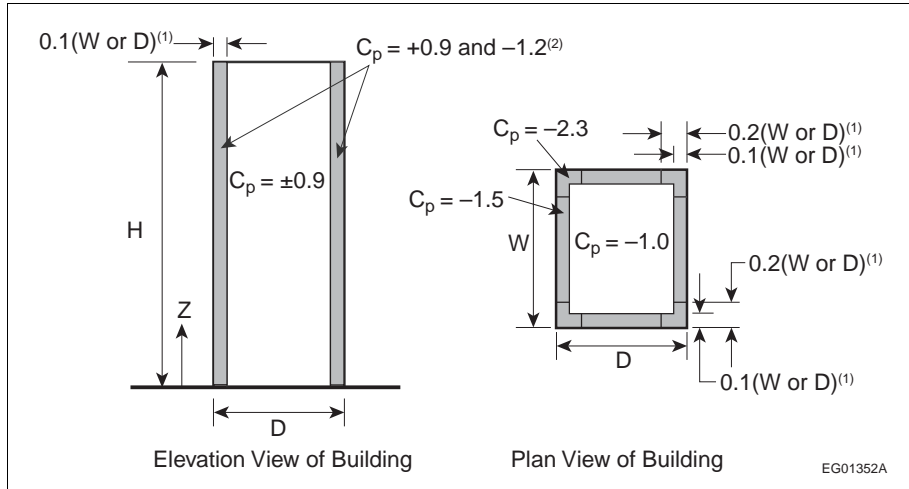
**A-4.1.7.3.(5)(c) Procedure for Calculating Intermediate  $C_e$ .** Information on calculating intermediate values of  $C_e$  between two exposures can be found in the Commentary entitled Wind Load and Effects in the “User’s Guide – NBC 2015, Structural Commentaries (Part 4 of Division B).”

**A-4.1.7.3.(10) Internal Gust Effect Factor,  $C_{gi}$ .** The effect of building envelope flexibility can be included in the calculation of  $C_{gi}$ . See the Commentary entitled Wind Load and Effects in the “User’s Guide – NBC 2015, Structural Commentaries (Part 4 of Division B).”

**A-4.1.7.5.(2) and (3) Pressure Coefficients for Main Structural System on Rectangular Buildings.**



**A-4.1.7.5.(4) Pressure coefficients for roof and wall claddings and secondary structural supports of cladding on rectangular buildings.**



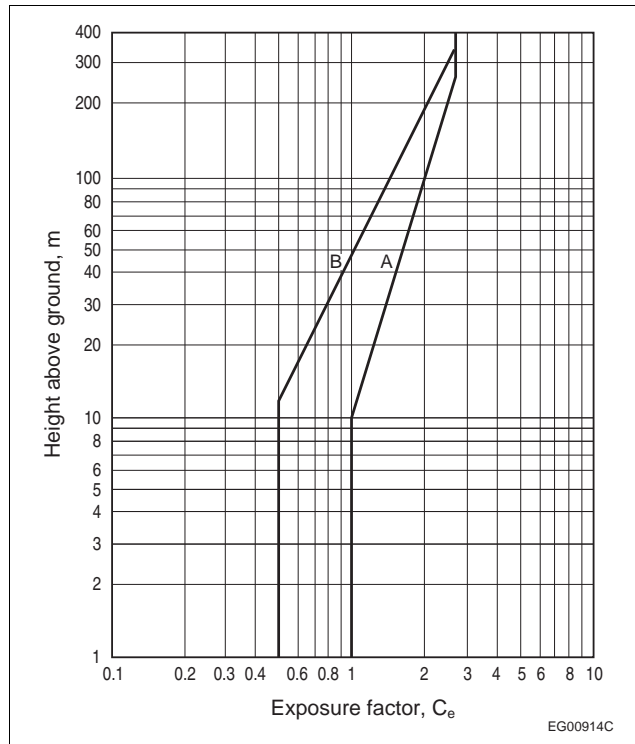
**Figure A-4.1.7.5.(4)**

**Values of  $C_p$  for roof and wall claddings and secondary structural supports of cladding on rectangular buildings**

**Notes to Figure A-4.1.7.5.(4):**

- (1) The larger of  $W$  or  $D$  is to be used.
- (2) Where vertical ribs deeper than 1 m are present on the walls, the dimensions  $0.1D$  and  $0.1W$  must be changed to  $0.2D$  and  $0.2W$  and the negative value of  $C_p$  must be changed from  $-1.2$  to  $-1.4$ .

**A-4.1.7.8.(2) and (3) Exposure Factor for Dynamic Procedure.**



**Figure A-4.1.7.8.(2) and (3)**

**Exposure factor,  $C_e$ , for dynamic procedure**

**Notes to Figure A-4.1.7.8.(2) and (3):**

- (1) Curve A represents  $C_e$  for open terrain, as defined in Clause 4.1.7.3.(5)(a).
- (2) Curve B represents  $C_e$  for rough terrain, as defined in Clause 4.1.7.3.(5)(b).

A-4.1.7.8.(4) Peak Factor, Size Reduction Factor and Gust Energy Ratio.

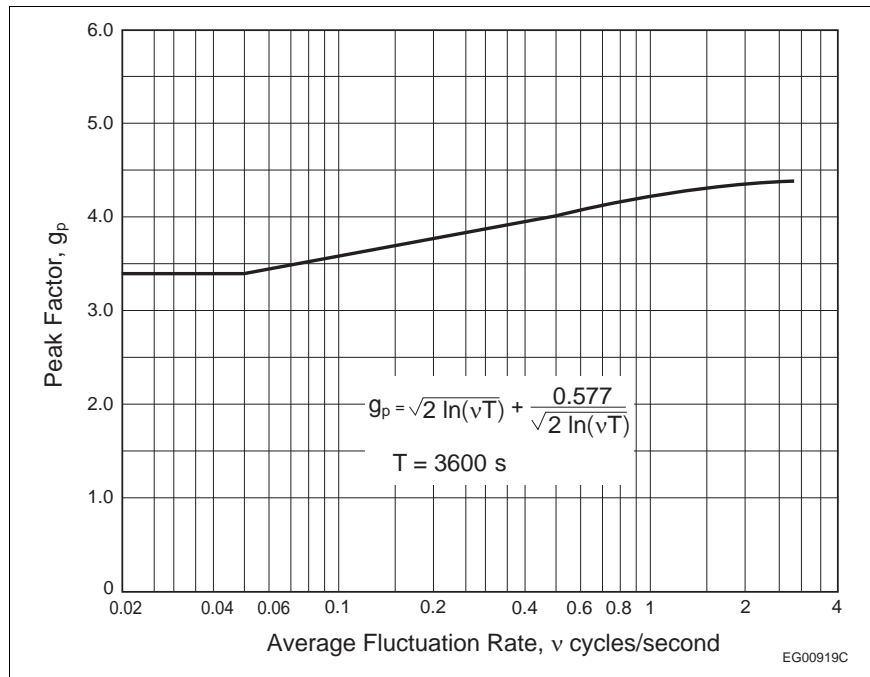


Figure A-4.1.7.8.(4)-A  
Peak factor,  $g_p$

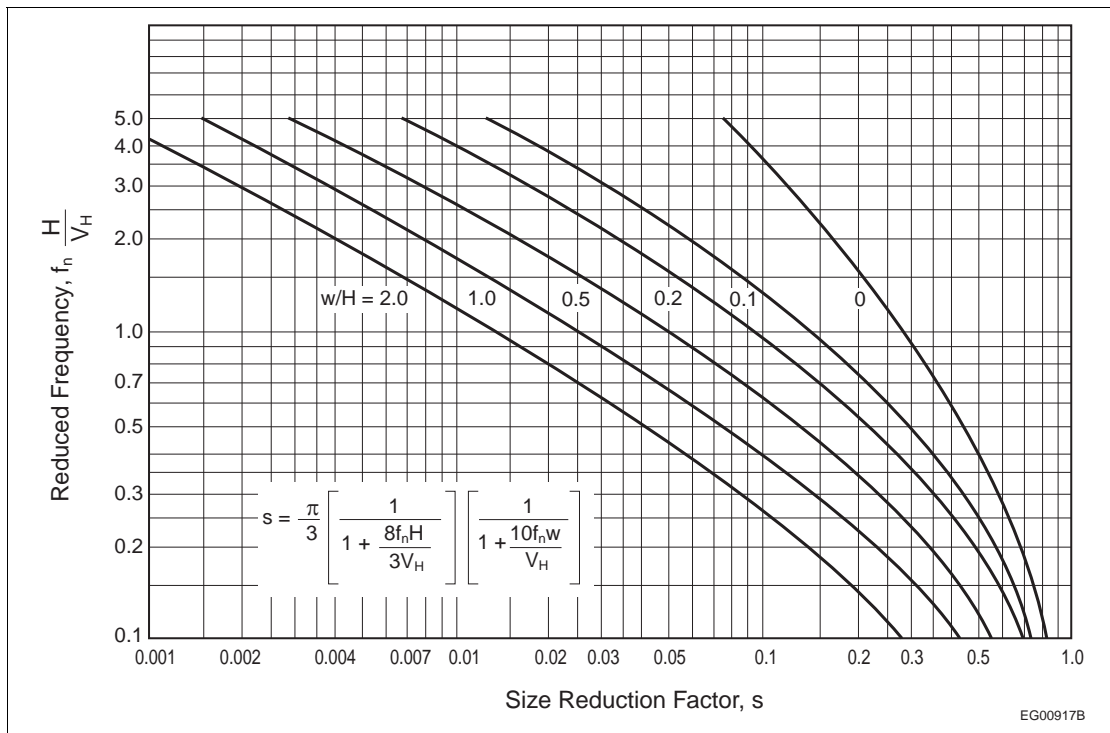


Figure A-4.1.7.8.(4)-B  
Size reduction factor,  $s$

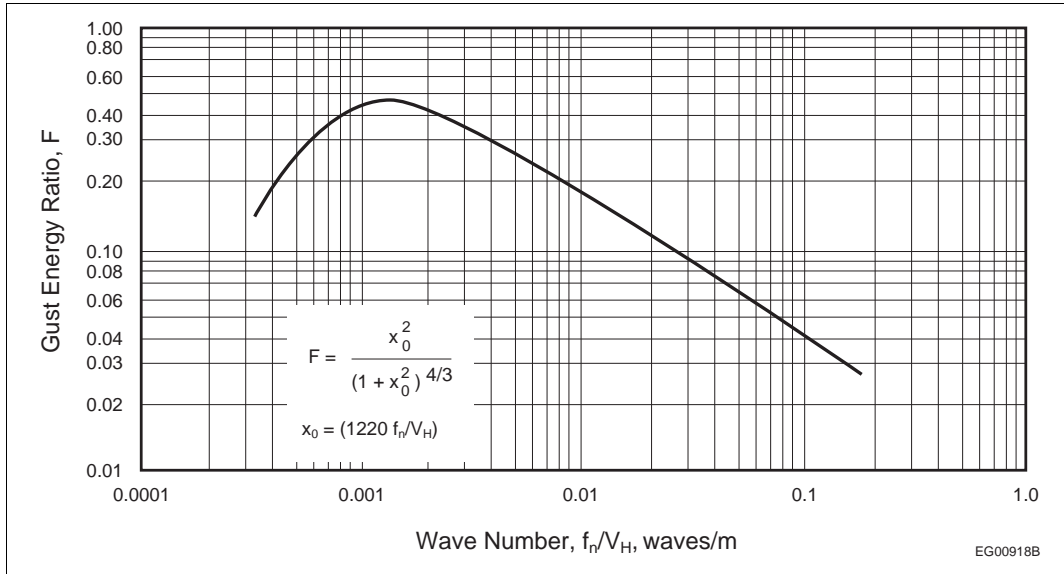


Figure A-4.1.7.8.(4)-C  
Gust energy ratio, F

**A-4.1.7.9.(1) Full and Partial Wind Loading.** Information on full and partial loading under wind loads can be found in the Commentary entitled Wind Load and Effects in the “User’s Guide – NBC 2015, Structural Commentaries (Part 4 of Division B).”

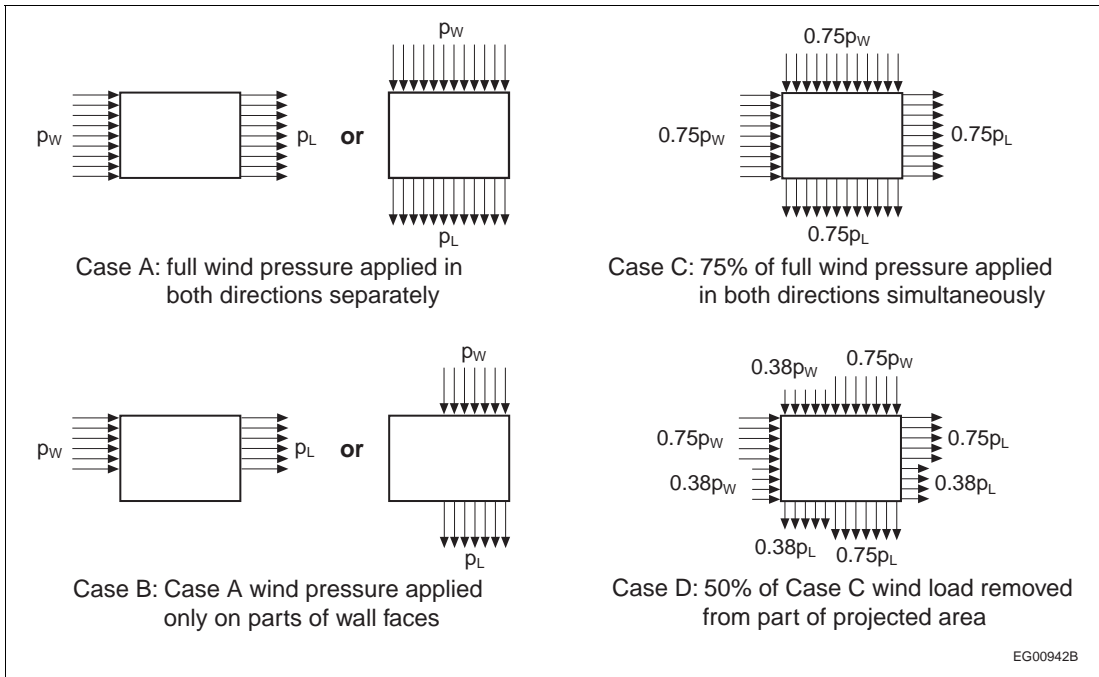


Figure A-4.1.7.9.(1)  
Full and partial wind loading

**A-4.1.7.11. Exterior Ornamentations, Equipment and Appendages.** Appendages may increase the overall forces in the design of the building structure and need to be accounted for.



**A-4.1.8.2.(1) Notation.****Definition of  $e_x$** 

Information on the calculation of torsional moments can be found in the Commentary entitled Design for Seismic Effects in the "User's Guide – NBC 2015, Structural Commentaries (Part 4 of Division B)."

**Definition of  $W$** 

Information on the definition of dead load,  $W$ , can be found in the Commentary entitled Design for Seismic Effects in the "User's Guide – NBC 2015, Structural Commentaries (Part 4 of Division B)."

**A-4.1.8.3.(4) General Design of the SFRS.** Information on the general design requirements for the SFRS can be found in the Commentary entitled Design for Seismic Effects in the "User's Guide – NBC 2015, Structural Commentaries (Part 4 of Division B)."

**A-4.1.8.3.(6) General Design of Stiff Elements.** Information on the general design requirements for stiff elements can be found in the Commentary entitled Design for Seismic Effects in the "User's Guide – NBC 2015, Structural Commentaries (Part 4 of Division B)."

**A-4.1.8.3.(7)(b) and (c) Stiffness Imparted to the Structure from Elements Not Part of the SFRS.** Information on stiffness imparted to the structure from elements not part of the SFRS can be found in the Commentary entitled Design for Seismic Effects in the "User's Guide – NBC 2015, Structural Commentaries (Part 4 of Division B)."

**A-4.1.8.3.(8) Structural Modelling.** Information on structural modelling can be found in the Commentary entitled Design for Seismic Effects in the "User's Guide – NBC 2015, Structural Commentaries (Part 4 of Division B)."

**A-4.1.8.4.(3) and Table 4.1.8.4.-A Site Class.** Information on Site Class can be found in the Commentary entitled Design for Seismic Effects in the "User's Guide – NBC 2015, Structural Commentaries (Part 4 of Division B)."

**A-Table 4.1.8.5. Serviceability Limit States for Earthquake.** Information on serviceability limit states for earthquake can be found in the Commentary entitled Design for Seismic Effects in the "User's Guide – NBC 2015, Structural Commentaries (Part 4 of Division B)."

**A-Table 4.1.8.6. Structural Irregularities.****Structural Irregularities**

Information on structural irregularities can be found in the Commentary entitled Design for Seismic Effects in the "User's Guide – NBC 2015, Structural Commentaries (Part 4 of Division B)."

**Gravity-Induced Lateral Demand – Type 9 Irregularity**

Uncoupled concrete and masonry shear walls where a large fraction of the overturning resistance is provided by axial compression, rather than through yielding of the longitudinal reinforcement, are less susceptible to amplified displacements due to gravity-induced lateral demands because the axial loads have a self-centering effect on the shear walls. Walls that are stronger than the foundation and other systems such as coupled walls, braced frames, and moment frames are more susceptible to amplified displacements due to gravity-induced lateral demands. A lower limit on  $\alpha$  is thus specified for such systems. Further information on the impacts of gravity-induced lateral demands on the seismic response of buildings can be found in the Commentary entitled Design for Seismic Effects in the "User's Guide – NBC 2015, Structural Commentaries (Part 4 of Division B)."

**A-4.1.8.7.(1) Dynamic Analysis Procedures.** Information on dynamic analysis procedures can be found in the Commentary entitled Design for Seismic Effects in the "User's Guide – NBC 2015, Structural Commentaries (Part 4 of Division B)."

**A-Table 4.1.8.9. Industrial-Type Steel Structures.** Guidance on the height limits, system restrictions and additional analysis and design requirements for steel SFRSs in industrial-type structures, intended essentially to support equipment, tanks or an industrial process, can be found in Annex M, Seismic Design of Industrial Steel Structures, of CSA S16, “Design of Steel Structures.”

**A-4.1.8.9.(4) Vertical Variations in  $R_dR_o$ .** Information on vertical variations in  $R_dR_o$  can be found in the Commentary entitled Design for Seismic Effects in the “User’s Guide – NBC 2015, Structural Commentaries (Part 4 of Division B).”

**A-4.1.8.9.(5)  $R_dR_o$  and Equivalent Systems.** Information on the  $R_dR_o$  of equivalent systems can be found in the Commentary entitled Design for Seismic Effects in the “User’s Guide – NBC 2015, Structural Commentaries (Part 4 of Division B).”

**A-4.1.8.10.(4) Mid-rise Timber SFRS.** Information on structural irregularities in mid-rise wood construction and on how to determine the number of storeys for application in Sentence 4.1.8.10.(4) can be found in the Commentary entitled Design for Seismic Effects in the “User’s Guide – NBC 2015, Structural Commentaries (Part 4 of Division B).”

**A-4.1.8.10.(5) Gravity-Induced Lateral Demand – Type 9 Irregularity.** Structural systems that include components such as inclined columns or horizontal floor cantilevers can induce lateral force demands on the SFRS under gravity loads. Buildings with such gravity-induced lateral demands on the SFRS are more likely to experience severe damage during strong ground shaking due to their tendency to drift only in one direction, leading to large residual displacements or instability. To determine if a building is susceptible to amplification of displacements due to gravity-induced lateral demands, the lateral resistance of the yielding mechanism to resist earthquake forces alone,  $Q_y$ , must be compared with the gravity-induced lateral demand,  $Q_G$ , at the same location. The force component selected for this comparison depends on the yielding mechanism for the SFRS. For example, for a coupled wall, the overturning moment resistance at the level of the expected plastic hinges should be compared with the overturning moment demand (at the same level) due to gravity loads alone, whereas for a steel-braced frame, the storey shear at the critical level of the yielding system should be compared with the storey shear demand (at the same level) due to the gravity loads alone. If the gravity-induced lateral demands exceed the limits prescribed in Sentence 4.1.8.10.(7), amplifications in seismic displacements due to gravity-induced lateral demands can only be identified through non-linear dynamic analyses using models that adequately represent the hysteretic behaviour of the SFRS. Further information on the impacts of gravity-induced lateral demands on the seismic response of buildings can be found in the Commentary entitled Design for Seismic Effects in the “User’s Guide – NBC 2015, Structural Commentaries (Part 4 of Division B).”

**A-4.1.8.10.(7) Gravity-Induced Lateral Demand – Non-Linear Dynamic Analysis.** Information on non-linear dynamic analysis can be found in the Commentary entitled Design for Seismic Effects in the “User’s Guide – NBC 2015, Structural Commentaries (Part 4 of Division B).”

**A-4.1.8.11.(3) Determination of the Fundamental Period,  $T_a$ .** Information on the determination of the fundamental period,  $T_a$ , can be found in the Commentary entitled Design for Seismic Effects in the “User’s Guide – NBC 2015, Structural Commentaries (Part 4 of Division B).”

**A-4.1.8.12.(1)(a) Linear Dynamic Analysis.** Information on Linear Dynamic Analysis can be found in the Commentary entitled Design for Seismic Effects in the “User’s Guide – NBC 2015, Structural Commentaries (Part 4 of Division B).”

**A-4.1.8.12.(1)(b) Non-linear Dynamic Analysis.** Information on Non-linear Dynamic Analysis can be found in the Commentary entitled Design for Seismic Effects in the “User’s Guide – NBC 2015, Structural Commentaries (Part 4 of Division B).”

**A-4.1.8.12.(3) Ground Motion Histories.** Information on ground motion histories can be found in the Commentary entitled Design for Seismic Effects in the “User’s Guide – NBC 2015, Structural Commentaries (Part 4 of Division B).”

**A-4.1.8.12.(4)(a) Accidental Torsional Moments.** Information on accidental torsional moments can be found in the Commentary entitled Design for Seismic Effects in the “User’s Guide – NBC 2015, Structural Commentaries (Part 4 of Division B).”

**A-4.1.8.13.(4) Deflections and Sway Effects.** Information on deflections and sway effects can be found in the Commentary entitled Design for Seismic Effects in the “User’s Guide – NBC 2015, Structural Commentaries (Part 4 of Division B).”

**A-4.1.8.15.(1) Diaphragms and their Connections.** Information on diaphragms and their connections can be found in the Commentary entitled Design for Seismic Effects in the “User’s Guide – NBC 2015, Structural Commentaries (Part 4 of Division B).”

**A-4.1.8.15.(3) Ductile Diaphragms.** Information on the design of struts, collectors, chords and connections for ductile diaphragms can be found in the Commentary entitled Design for Seismic Effects in the “User’s Guide – NBC 2015, Structural Commentaries (Part 4 of Division B).”

**A-4.1.8.15.(4) Influence of Dynamic Diaphragm In-plane Response.**

**Clause 4.1.8.15.(4)(a)**

In lieu of carrying out a special study as stated in Subclause 4.1.8.15.(4)(a)(iii), the anticipated total deformation demand on the vertical elements of the SFRS, including inelastic deformations, may be taken as equal to  $R_o R_d (\Delta_B + \Delta_D) - R_o \Delta_D$ , i.e., the difference between the total storey drift including inelastic deformation effects and diaphragm deformations,  $R_o R_d (\Delta_B + \Delta_D)$ , and the diaphragm deformation under  $R_o$  times the seismic load, where  $R_o$  may be replaced by the actual overstrength of the SFRS vertical elements. The design engineer must verify that the SFRS vertical elements have sufficient deformation capacity to accommodate the computed deformation demand. If the vertical elements of the SFRS do not have sufficient deformation capacity, the design forces for the vertical elements of the SFRS must be magnified by  $R_d(1 + \Delta_D/\Delta_B)/(R_d + \Delta_D/\Delta_B)$ . The calculation of the magnified design forces is iterative as the  $\Delta_D/\Delta_B$  ratio may change when using higher design forces for the vertical elements of the SFRS. Reducing the  $\Delta_D/\Delta_B$  ratio by increasing the stiffness of the roof diaphragm relative to that of the vertical elements of the SFRS may be considered to reduce the deformation demand on the vertical elements of the SFRS. Additional information can be found in the Commentary entitled Design for Seismic Effects in the “User’s Guide – NBC 2015, Structural Commentaries (Part 4 of Division B).”

**Clause 4.1.8.15.(4)(b)**

The dynamic response of the diaphragm with the vertical elements of the SFRS under seismic excitation involves several modes of vibration that affect both the amplitude and distribution of in-plane shears and bending moments in the roof diaphragm. The shape of the fundamental mode of vibration resembles the deflected shape of the diaphragm/vertical SFRS elements under a distributed lateral load while higher modes involve increasing numbers of zero crossings of the deflected shapes along the length of the diaphragm, similar to the modes of a simply supported beam with distributed mass. Shears and bending moments therefore deviate from the values obtained from the equivalent static force procedure essentially due to higher mode response. Modal contributions to shears and bending moments in the diaphragms can be obtained from a Linear Dynamic Analysis. The contribution from the higher modes is generally more pronounced when the  $\Delta_D/\Delta_B$  ratio, the period in the first mode, or the ratio  $S_a(0.2)/S_a(2.0)$  is increased. It also increases when the SFRS is designed with a higher  $R_d$  factor as inelastic deformations of the vertical elements of the SFRS attenuate the first mode response. Methods to take into account the inelastic higher mode effects on in-plane diaphragm shears and moments are discussed in the Commentary entitled Design for Seismic Effects in the “User’s Guide – NBC 2015, Structural Commentaries (Part 4 of Division B).”

**A-4.1.8.15.(5) Discontinuities.** Information on elements supporting discontinuities can be found in the Commentary entitled Design for Seismic Effects in the “User’s Guide – NBC 2015, Structural Commentaries (Part 4 of Division B).”

**A-4.1.8.15.(6) Vertical Variations in  $R_d R_o$ .** Information on elements of the SFRS below the variation in  $R_d R_o$  can be found in the Commentary entitled Design for Seismic Effects in the “User’s Guide – NBC 2015, Structural Commentaries (Part 4 of Division B).”

**A-4.1.8.15.(7) Concurrent Yielding.** Information on the effects of concurrent yielding of elements can be found in the Commentary entitled Design for Seismic Effects in the “User’s Guide – NBC 2015, Structural Commentaries (Part 4 of Division B).”

**A-4.1.8.15.(8) Design Force in Elements.** Information on the design force in elements can be found in the Commentary entitled Design for Seismic Effects in the “User’s Guide – NBC 2015, Structural Commentaries (Part 4 of Division B).”

**A-4.1.8.16.(1) Foundation Movement.** The bearing stress distribution in soil or rock that is used to determine the factored overturning resistance of the foundation influences the rotation of the foundation, which occurs due to the forces applied by the SFRS. Generally, all foundations will rotate on soil or rock. In particular, footings (a type of foundation unit) often undergo uplift at one end, and if the factored bearing stress at the other end is only over a short length, then the uplift and rotation of the footing can be significant. CSA A23.3, “Design of Concrete Structures,” contains design requirements for footings that rotate and uplift; see also the Commentary entitled Design for Seismic Effects in the “User’s Guide – NBC 2015, Structural Commentaries (Part 4 of Division B)” for guidance and methods to account for foundation movement.

**A-4.1.8.16.(2) Actual Lateral Load Capacity of the SFRS.** The actual lateral load capacity of the SFRS includes the effects of member overstrengths similar to those used to determine the  $R_o$  factors. The applicable CSA design standards include requirements on calculating the overstrengths and capacities, which may be based on the members’ nominal or probable resistance. The actual capacities are larger than the factored loads and factored resistances and, in many cases, can be significantly larger. Note that the foundations designed to develop the capacity of the SFRS will undergo movements and Sentence 4.1.8.16.(1) still applies.

**A-4.1.8.16.(4) Overturning Resistance of the Foundation.** For the special case where the foundation is a footing, and where it and the attached SFRS are not constrained against rotation, it is permitted, with certain limitations, to size the footing to have a factored overturning resistance less than the overturning capacity of the supported SFRS. This approach results in a smaller footing, increased footing rotations, increased drifts in the structure, and increased soil stresses, all of which are over and above those associated with footings sized to have a factored overturning resistance equal to or greater than the overturning capacity of the SFRS. The footing itself must have a factored resistance capable of developing the required soil or rock reactions. An example of a footing and SFRS that are not constrained against rotation is an SFRS on a footing near the ground surface such that it can rotate freely and is attached to a gravity-load-resisting system (non-SFRS) that is laterally flexible and provides little lateral resistance. For this case, the SFRS is usually analyzed on its own and the resulting displacements are imposed on the non-SFRS elements in order to assess the effects on them. Cases where the footing and SFRS are attached to a system that has significant lateral stiffness require careful analysis and engineering judgement, or the footing can be capacity-designed.

Limiting the overturning moment on the foundation and the  $R_d R_o$  value provides some control on the increase in lateral displacement, drift and stress in the soil or rock. Cases that exceed these limits require special study.

For the common case where the SFRS and/or the footing are constrained in some way against rotation, the footing’s factored resistance must be equal to or greater than the capacity of the supported SFRS. An example of an SFRS constrained against freely rotating with the footing is an SFRS attached to adjacent foundation walls by below-grade diaphragms. Examples of footings constrained against free rotation are footings that use soil anchors to resist overturning, footings on piles, and raft foundations. Note that Sentence 4.1.8.16.(1) still applies.

See CSA A23.3, “Design of Concrete Structures,” and the Commentary entitled Design for Seismic Effects in the “User’s Guide – NBC 2015, Structural Commentaries (Part 4 of Division B).”

**A-4.1.8.16.(6)(a) Interconnection of Foundation Elements.** Information on the interconnection of piles or pile caps, drilled piers, and caissons can be found in the Commentary entitled Design for Seismic Effects in the “User’s Guide – NBC 2015, Structural Commentaries (Part 4 of Division B).”

**A-4.1.8.16.(7) Earthquake Lateral Pressures from Backfill or Natural Ground.** Information on methods of computing the seismic lateral pressures from backfill or natural ground can be found in the Commentary entitled Design for Seismic Effects in the “User’s Guide – NBC 2015, Structural Commentaries (Part 4 of Division B).”

**A-4.1.8.16.(8)(a) Cyclic Inelastic Behaviour of Foundation Elements.** Information on the cyclic inelastic behaviour of piles or pile caps, drilled piers, and caissons can be found in the Commentary entitled Design for Seismic Effects in the “User’s Guide – NBC 2015, Structural Commentaries (Part 4 of Division B).”

**A-4.1.8.16.(9) Alternative Foundation Ties.** Alternative methods of tying foundations together, such as a properly reinforced floor slab capable of resisting the required tension and compression forces, may be used. Passive soil pressure against buried pile caps may not be used to resist these forces.

**A-4.1.8.16.(10) Liquefaction.** Information on liquefaction can be found in the Commentary entitled Design for Seismic Effects in the “User’s Guide – NBC 2015, Structural Commentaries (Part 4 of Division B).”

**A-4.1.8.17.(1) Slope Stability.** Information on slope instability can be found in the Commentary entitled Design for Seismic Effects in the “User’s Guide – NBC 2015, Structural Commentaries (Part 4 of Division B).”

**A-4.1.8.18. Elements of Structures, Non-structural Components and Equipment.** Information on the requirements of Article 4.1.8.18. can be found in the Commentary entitled Design for Seismic Effects in the “User’s Guide – NBC 2015, Structural Commentaries (Part 4 of Division B).”

**A-Table 4.1.8.18. Non-structural Components and Equipment.** The failure or detachment of non-structural components and equipment during an earthquake can present a major threat to life safety. The design requirements presented in Article 4.1.8.18. are intended to ensure that such components and their connections to the building will retain their integrity during strong ground shaking. Guidelines for the seismic risk reduction of such components are given in CAN/CSA-S832, “Seismic Risk Reduction of Operational and Functional Components (OFCs) of Buildings.”

**A-4.1.8.18.(14) Storage Racks.** Free-standing steel pallet storage racks contain only materials typically loaded by forklift. They are designed to store loaded pallets, however in some cases, the stored material does not sit on a pallet. There is no occupancy within the racks. Information on racks can be found in the Commentary entitled Design for Seismic Effects in the “User’s Guide – NBC 2015, Structural Commentaries (Part 4 of Division B).”

**A-4.1.8.18.(15) and (16)(c) Glass Fallout and Failure.** Information on glass fallout and testing for glass fallout can be found in AAMA 501.6, “Recommended Dynamic Test Method For Determining The Seismic Drift Causing Glass Fallout From A Wall System.” Every surface other than inaccessible areas or areas where occupancy is prevented or access is prevented should be considered a “walking surface.” Additional information can be found in ASCE/SEI 7, “Minimum Design Loads for Buildings and Other Structures,” in FEMA P-750, “NEHRP Recommended Seismic Provisions for New Buildings and Other Structures,” and FEMA 450-1, “NEHRP Recommended Provisions for Seismic Regulations for New Buildings and Other Structures,” and related commentaries, and in the Commentary entitled Design for Seismic Effects in the “User’s Guide – NBC 2015, Structural Commentaries (Part 4 of Division B).”

**A-4.1.8.19.(2) Design Review.** It is strongly recommended that a design review of the seismically isolated structure and its isolation system be carried out by an independent team of professional engineers and geoscientists experienced in seismic analysis methods and the theory and application of seismic isolation. The design review should include, but not be limited to, the following:

- (a) site-specific spectra,
- (b) ground motion time histories,
- (c) modeling and analyses,
- (d) testing program and results, and
- (e) final design of all structural framing elements and isolation system components.

**A-4.1.8.19.(3)(a) Non-Linear Dynamic Analysis.** Three-dimensional Non-Linear Dynamic Analysis is a complex process requiring special expertise. Guidance on Non-linear Dynamic Analysis can be found in the Commentary entitled Design for Seismic Effects in the “User’s Guide – NBC 2015, Structural Commentaries (Part 4 of Division B).”

**A-4.1.8.19.(4) Ground Motion Time Histories.** Ground motion time histories and their horizontal and vertical components must be appropriately selected and scaled according to accepted practice. Further information on ground motion time histories can be found in the Commentary entitled Design for Seismic Effects in the “User’s Guide – NBC 2015, Structural Commentaries (Part 4 of Division B).”

**A-4.1.8.21.(2) Design Review.** It is strongly recommended that a design review of the structure and the supplementary energy dissipation system be carried out by an independent team of professional engineers and geoscientists experienced in seismic analysis methods and the theory and application of supplementary energy dissipation. The design review should include, but not be limited to, the following:

- (a) ground motion time histories,
- (b) modeling and analyses,
- (c) testing program and results, and

(d) final design of all structural framing elements and supplemental energy dissipation system components.

**A-4.1.8.21.(4)(a) Non-linear Dynamic Analysis.** Three-dimensional Non-linear Dynamic Analysis is a complex process requiring special expertise. Guidance on Non-linear Dynamic Analysis can be found in the Commentary entitled Design for Seismic Effects in the “User’s Guide – NBC 2015, Structural Commentaries (Part 4 of Division B).”

**A-4.1.8.21.(5) Ground Motion Time Histories.** Ground motion time histories and their horizontal and vertical components must be appropriately selected and scaled according to accepted practice. Further information on ground motion time histories can be found in the Commentary entitled Design for Seismic Effects in the “User’s Guide – NBC 2015, Structural Commentaries (Part 4 of Division B).”

**A-4.2.2.1.(1) Subsurface Investigation.** Where acceptable information on subsurface conditions already exists, the investigation may not require further physical subsurface exploration or testing.

**A-4.2.2.3.(1) Responsibilities of the Designer as Defined in Part 4.** In certain situations, such as when the design is highly technical, it may be necessary for the “other suitably qualified person” to be someone responsible to the designer. In such cases the authority having jurisdiction may wish to order that the review be done by the designer.

**A-4.2.4.1.(1) Innovative Designs.** It is important that innovative approaches to foundation design be carried out by a person especially qualified in the specific method applied and that the design provide a level of safety and performance at least equivalent to that provided for or implicit in the design carried out by the methods referred to in Part 4. Provision must be made for monitoring the subsequent performance of such structures so that the long-term sufficiency of the design can be evaluated.

**A-4.2.4.1.(3) Ultimate Limit States for Foundations.** Information on ultimate limit states for foundations, including terminology and resistance factors, can be found in the Commentary entitled Foundations in the “User’s Guide – NBC 2015, Structural Commentaries (Part 4 of Division B).”

**A-4.2.4.1.(5) Design of Foundations for Differential Movements.** Information on the design of foundations for differential movements can be found in the Commentary entitled Foundations in the “User’s Guide – NBC 2015, Structural Commentaries (Part 4 of Division B).”

**A-4.2.4.4.(1) Depth of Foundations.** When adfreeze has occurred and subsequent freezing results in soil expansion beneath this area, the resulting uplift effect is sometimes referred to as frost jacking.

A heated building that is insulated to prevent heat loss through the foundation walls should be considered as an unheated structure unless the effect of the insulation is taken into account in determining the maximum depth of frost penetration.

**A-4.2.5.1.(1) Excavations.** Information on excavations can be found in the Commentary entitled Foundations in the “User’s Guide – NBC 2015, Structural Commentaries (Part 4 of Division B).”

**A-4.2.6.1.(1) Shallow Foundations.** Information on shallow foundations can be found in the Commentary entitled Foundations in the “User’s Guide – NBC 2015, Structural Commentaries (Part 4 of Division B).”

**A-4.2.7.1.(1) Deep Foundation Units.** A deep foundation unit can be pre-manufactured or cast-in-place; it can be driven, jacked, jetted, screwed, bored or excavated; it can be of wood, concrete or steel or a combination thereof.

**A-4.2.7.2.(1) Deep Foundations.** Information on deep foundations can be found in the Commentary entitled Foundations in the “User’s Guide – NBC 2015, Structural Commentaries (Part 4 of Division B).”

**A-4.2.7.2.(2) Load Testing of Piles.** ASTM D 1143/D 1143M, “Deep Foundations Under Static Axial Compressive Load,” defines routine load test procedures that have been extensively used.

**A-4.3.3.1.(1) Precast Concrete.** CSA A23.3, “Design of Concrete Structures,” requires precast concrete members to conform to CSA A23.4, “Precast Concrete – Materials and Construction.”

**A-4.3.4.1.(1) Welded Construction.** Qualification for fabricators and erectors of welded construction is found in Clause 24.3 of CSA S16, “Design of Steel Structures.”

**A-4.3.4.2.(1) Cold-Formed Stainless Steel Members.** There is currently no Canadian standard for the design of cold-formed stainless steel structural members. As an interim measure, design may be carried out using the limit states design provisions of ASCE/SEI 8, “Design of Cold-Formed Stainless Steel Structural Members,” except that load factors, load combinations and load combination factors shall be in accordance with Subsection 4.1.3.

**A-4.3.6.1.(1) Design Basis for Glass.** The load factors in Tables 4.1.3.2.-A and 4.1.3.2.-B must be applied to the adjusted wind load before designing in accordance with the referenced standard. Additional information is given in the Commentary entitled Wind Load and Effects in the “User’s Guide – NBC 2015, Structural Commentaries (Part 4 of Division B).”

**A-4.4.2.1.(1) Design Basis for Parking Structures and Repair Garages.** See the Commentary entitled Live Loads in the “User’s Guide – NBC 2015, Structural Commentaries (Part 4 of Division B).”





# Part 5

## Environmental Separation

<b>5.1.</b>	<b>General</b>	
5.1.1.	Scope .....	5-1
5.1.2.	Application .....	5-1
5.1.3.	Definitions .....	5-1
5.1.4.	Resistance to Loads and Deterioration .....	5-2
5.1.5.	Other Requirements .....	5-3
<b>5.2.</b>	<b>Loads and Procedures</b>	
5.2.1.	Environmental Loads and Design Procedures .....	5-3
5.2.2.	Structural Loads and Design Procedures .....	5-4
<b>5.3.</b>	<b>Heat Transfer</b>	
5.3.1.	Thermal Resistance of Assemblies .....	5-5
<b>5.4.</b>	<b>Air Leakage</b>	
5.4.1.	Air Barrier Systems .....	5-5
<b>5.5.</b>	<b>Vapour Diffusion</b>	
5.5.1.	Vapour Barriers .....	5-6
<b>5.6.</b>	<b>Precipitation</b>	
5.6.1.	Protection from Precipitation .....	5-7
5.6.2.	Sealing, Drainage, Accumulation and Disposal .....	5-8
<b>5.7.</b>	<b>Surface and Ground Water</b>	
5.7.1.	Site Factors .....	5-8
5.7.2.	Protection against Hydrostatic Pressure .....	5-9
5.7.3.	Protection against Ground Water ...	5-9
<b>5.8.</b>	<b>Sound Transmission</b>	
5.8.1.	Protection from Airborne Noise ....	5-10
<b>5.9.</b>	<b>Standards</b>	
5.9.1.	Applicable Standards .....	5-12
5.9.2.	Windows, Doors and Skylights ....	5-15
5.9.3.	Other Fenestration Assemblies ....	5-16
5.9.4.	Exterior Insulation Finish Systems .....	5-17
<b>5.10.</b>	<b>Objectives and Functional Statements</b>	
5.10.1.	Objectives and Functional Statements .....	5-18
	<b>Notes to Part 5 .....</b>	<b>5-21</b>



# **Part 5**

## **Environmental Separation**

(See Note A-5.)

### **Section 5.1. General**

#### **5.1.1. Scope**

##### **5.1.1.1. Scope**

- 1)** This Part is concerned with
  - a) the control of condensation
    - i) in *building* components and assemblies, and
    - ii) on *building* materials, components and assemblies, and
  - b) the transfer of heat, air, moisture and sound through
    - i) *building* materials, components and assemblies, and
    - ii) interfaces between *building* materials, components and assemblies.

(See Note A-5.1.1.1.(1).)

#### **5.1.2. Application**

##### **5.1.2.1. Exposure to Exterior Space or the Ground and Separation of Dissimilar Environments**

- 1)** This Part applies, as described in Subsection 1.3.3. of Division A, to
  - a) *building* materials, components and assemblies exposed to exterior space or the ground, including those separating interior space from exterior space or separating interior space from the ground,
  - b) *building* materials, components and assemblies separating environmentally dissimilar interior spaces (see Note A-5.8.), and
  - c) site materials, components, assemblies and grading that may affect environmental loads on *building* materials, components and assemblies exposed to exterior space or the ground.

(See Note A-5.1.2.1.(1).)

#### **5.1.3. Definitions**

##### **5.1.3.1. Defined Words**

- 1)** Words that appear in italics are defined in Article 1.4.1.2. of Division A.

## 5.1.4. Resistance to Loads and Deterioration

### 5.1.4.1. Structural and Environmental Loads

(See Note A-5.1.4.1.)

**1)** *Building* materials, components and assemblies that separate dissimilar environments or are exposed to the exterior shall have sufficient capacity and integrity to resist or accommodate

- a) all environmental loads, and effects of those loads, that may reasonably be expected having regard to
  - i) the intended use of the *building*, and
  - ii) the environment to which the materials, components and assemblies are subject, and
- b) all structural loads, and effects of those loads, that may reasonably be expected.

**2)** Where *building* materials, components or assemblies perform more than one function, they shall satisfy the requirements of all of those functions. (See Note A-5.1.4.1.(2).)

**3)** Compliance with Clause (1)(a) shall be demonstrated by design complying with Subsection 5.2.1. and construction conforming to that design.

**4)** Compliance with Clause (1)(b) shall be demonstrated by design complying with Subsection 5.2.2., and construction conforming to that design, with regard to

- a) materials, components and assemblies, and associated loads, that are identified in Part 4,
- b) air pressure loads imposed on *air barrier systems*,
- c) wind up-lift imposed on roofing, and
- d) hydrostatic pressure imposed on the means of protection from moisture in the ground.

**5)** For materials, components, assemblies and loads to which Sentence (4) does not apply, compliance with Clause (1)(b) shall be demonstrated

- a) by design complying with Subsection 5.2.2. for individual applicable loads and construction conforming to that design, or
- b) in the case of common materials, components and assemblies, and their installation, by proven past performance over a period of several years for individual applicable loads.

(See Note A-5.1.4.1.(5).)

**6)** Materials, components and assemblies separating dissimilar environments and assemblies exposed to the exterior, including their connections, that are subject to structural loads as defined in Article 5.2.2.1., shall

- a) transfer such loads to the *building* structure without adverse effects on the performance of other materials, components or assemblies,
- b) not deflect to a degree that adversely affects the performance of other materials, components or assemblies (see Note A-5.1.4.1.(6)(b) and (c)), and
- c) be designed, and constructed according to that design, to accommodate (see Note A-5.1.4.1.(6)(b) and (c))
  - i) the maximum relative structural movement that may reasonably be expected, and
  - ii) construction tolerances that may be reasonably expected.

(See Article 4.1.3.5., Sentence 4.1.3.3.(2) and Subsection 4.1.8. for information on different types of structural movements.) (See Note A-5.1.4.1.)

**5.1.4.2. Resistance to Deterioration**

(See Note A-5.1.4.2.)

**1)** Except as provided in Sentence (2), materials used in *building* components and assemblies that separate dissimilar environments, or in assemblies exposed to the exterior, shall be

- a) compatible with adjoining materials, and
- b) resistant to any mechanisms of deterioration that may reasonably be expected, given
  - i) the nature and function of the materials, and
  - ii) the exposure and climatic conditions in which they will be installed.

**2)** Material compatibility and deterioration resistance are not required where it can be shown that incompatibility or uncontrolled deterioration will not adversely affect any of

- a) the health or safety of *building* users,
- b) the intended use of the *building*, or
- c) the operation of *building* services.

**5.1.5. Other Requirements**

**5.1.5.1. Requirements in Other Parts of the Code**

- 1)** Structural and fire safety requirements in other Parts of the NBC shall apply.

**Section 5.2. Loads and Procedures**

**5.2.1. Environmental Loads and Design Procedures**

**5.2.1.1. Exterior Environmental Loads**

- 1)** Above ground climatic loads shall be determined according to Subsection 1.1.3.

**2)** Except as provided in Sentence (3), below ground exterior environmental loads not described in Subsection 1.1.3. shall be determined from existing geological and hydrological data or from site tests.

**3)** Where local design and construction practice has shown *soil* temperature analysis to be unnecessary, *soil* temperatures need not be determined. (See Note A-5.2.1.1.(3).)

**5.2.1.2. Interior Environmental Loads**

**1)** Interior environmental loads shall be determined in accordance with good practice as described in Sentence 6.2.1.1.(1) based on the intended use of the space. (See Note A-5.2.1.2.(1).)

**5.2.1.3. Environmental Load and Transfer Calculations**

**1)** Calculations related to the transfer of heat, air and moisture and the transmission of sound shall conform to good practice such as that described in the ASHRAE Handbooks.

**2)** For the purposes of any analysis conducted to indicate conformance to the thermal resistance levels required in Article 5.3.1.2., *soil* temperatures shall be determined based on annual average *soil* temperature, seasonal amplitude of variation and attenuation of variation with depth.

- 3)** Wind load calculations shall conform to Subsection 4.1.7.

## 5.2.2. Structural Loads and Design Procedures

### 5.2.2.1. Determination of Structural Loads and Effects

**1)** Where materials, components or assemblies that separate dissimilar environments or are exposed to the exterior, or their connections, are required to be designed to withstand structural loads, these loads shall be determined in accordance with Part 4. (See also Subsection 2.2.5. of Division C.)

**2)** Except as provided in Article 4.1.8.18., the structural loads referred to in Sentence (1) and their related effects shall include

- a) *dead loads* transferred from structural elements,
- b) wind, snow, rain, hydrostatic and earth pressures,
- c) earthquake effects for *post-disaster buildings*, depending on their intended function (see Note A-5.2.2.1.(2)(c)),
- d) *live loads* due to use and *occupancy*, and
- e) loads due to thermal or moisture-related expansion and contraction, deflection, deformation, creep, shrinkage, settlement, and differential movement.

**3)** Where materials, components or assemblies that separate dissimilar environments or are exposed to the exterior, or their connections, can be expected to be subject to loads or other effects not described in this Subsection or in Part 4, such loads or effects shall be taken into account in the design based on the most current and applicable information available.

### 5.2.2.2. Determination of Wind Load

(See Note A-5.2.2.2.)

**1)** This Article applies to the determination of wind load to be used in the design of materials, components and assemblies, including their connections, that separate dissimilar environments or are exposed to the exterior, where these are

- a) subject to wind load, and
- b) required to be designed to resist wind load.

**2)** Except as provided in Sentence (3), the wind load referred to in Sentence (1) shall be 100% of the specified wind load determined in accordance with Article 4.1.7.1.

**3)** Where it can be shown by test or analysis that a material, component, assembly or connection referred to in Sentence (1) will be subject to less than 100% of the specified wind load, the wind load referred to in Sentence (1) shall be not less than the load determined by test or analysis.

**4)** Except as provided in Sentence (5), the wind uplift resistance of membrane roofing assemblies shall be determined in accordance with the requirements of CAN/CSA-A123.21, "Dynamic Wind Uplift Resistance of Membrane-Roofing Systems." (See Note A-5.2.2.2.(4).)

**5)** Membrane roofing assemblies with proven past performance for the anticipated wind loads need not comply with Sentence (4). (See Note A-5.1.4.1.(5).)

### 5.2.2.3. Design Procedures

**1)** Structural design shall be carried out in accordance with Subsection 4.1.3. and other applicable requirements in Part 4.

## Section 5.3. Heat Transfer

(See Note A-5.3.)

### 5.3.1. Thermal Resistance of Assemblies

#### 5.3.1.1. Required Resistance to Heat Transfer

(See Note A-5.3.1.1.)

**1)** Except as provided in Sentence (2), where a *building* component or assembly will be subjected to an intended temperature differential, the component or assembly shall include materials to resist heat transfer or a means to dissipate transferred heat in accordance with the remainder of this Subsection.

**2)** The installation of materials to resist heat transfer in accordance with the remainder of this Subsection is not required where it can be shown that uncontrolled heat transfer will not adversely affect any of

- a) the health or safety of *building* users,
- b) the intended use of the *building*, or
- c) the operation of *building* services.

#### 5.3.1.2. Properties to Resist Heat Transfer or Dissipate Heat

(See Note A-5.3.1.2.)

**1)** Taking into account the conditions on either side of the environmental separator, materials and components installed to provide the required resistance to heat transfer or the means implemented to dissipate heat shall provide sufficient resistance or dissipation,

- a) to minimize surface condensation on the warm side of the component or assembly,
- b) in conjunction with other materials and components in the assembly, to minimize condensation within the component or assembly,
- c) in conjunction with systems installed for space conditioning, to meet the interior design thermal conditions for the intended *occupancy*, and
- d) to minimize ice damming on sloped roofs.

(See Note A-5.3.1.2.(1).)

#### 5.3.1.3. Location and Installation of Materials Providing Thermal Resistance

**1)** Where a material required by Article 5.3.1.1. is intersected by a *building* assembly, penetrated by a high conductance component or interrupted by expansion, control or construction joints, and where condensation is likely to occur at these intersections, penetrations or interruptions, sufficient thermal resistance shall be provided so as to minimize condensation at these locations.

**2)** Materials providing required thermal resistance shall have sufficient inherent resistance to airflow or be positioned in the assembly so as to prevent convective airflow through and around the material. (See Note A-5.3.1.3.(2).)

## Section 5.4. Air Leakage

### 5.4.1. Air Barrier Systems

#### 5.4.1.1. Required Resistance to Air Leakage

(See Note A-5.4.1.1.)

**1)** Where a *building* component or assembly separates interior *conditioned space* from exterior space, interior space from the ground, or environmentally dissimilar interior spaces, the properties and position of the materials and components in those components or assemblies shall be such that they control air leakage or permit venting to the exterior so as to

- a) provide acceptable conditions for the *building* occupants,

- b) maintain appropriate conditions for the intended use of the *building*,
- c) minimize the accumulation of condensation in and the penetration of precipitation into the *building* component or assembly,
- d) control heat transfer to roofs where ice damming can occur,
- e) minimize the ingress of airborne radon from the ground with an aim to controlling the indoor radon concentration to an acceptable level, and
- f) not compromise the operation of *building* services.

**2)** Except as provided in Sentence (3), an *air barrier system* shall be installed to provide the principal resistance to air leakage.

**3)** An *air barrier system* is not required where it can be shown that uncontrolled air leakage will not adversely affect any of

- a) the health or safety of *building* users,
- b) the intended use of the *building*, or
- c) the operation of *building* services.

#### 5.4.1.2. Air Barrier System Properties

**1)** Except as provided in Sentence (2), air barrier materials intended to provide the principal resistance to air leakage shall

- a) have an air leakage characteristic not greater than 0.02 L/(s·m<sup>2</sup>) measured at an air pressure difference of 75 Pa, when tested in accordance to ASTM E 2178, "Air Permeance of Building Materials," or
- b) conform to CAN/ULC-S741, "Air Barrier Materials – Specification."

(See Note A-5.4.1.2.(1) and (2).)

**2)** The air leakage limit specified in Sentence (1) is permitted to be increased where it can be shown that the higher rate of leakage will not adversely affect any of

- a) the health or safety of the *building* users,
- b) the intended use of the *building*, or
- c) the operation of *building* services.

(See Note A-5.4.1.2.(1) and (2).)

- 3)** The *air barrier system* shall be continuous
- a) across construction, control and expansion joints,
  - b) across junctions between different *building* assemblies, and
  - c) around penetrations through the *building* assembly.

**4)** The structural design of *air barrier systems* installed in assemblies subject to air pressure loads shall comply with Article 5.1.4.1. and Subsection 5.2.2.

## Section 5.5. Vapour Diffusion

### 5.5.1. Vapour Barriers

#### 5.5.1.1. Required Resistance to Vapour Diffusion

(See Note A-5.5.1.1.)

**1)** Where a *building* component or assembly is subjected to differentials in temperature and water vapour pressure, the properties and position of the materials and components in those components or assemblies shall be such that they control vapour diffusion or permit venting to the exterior so as to minimize the accumulation of condensation in the *building* component or assembly.

**2)** Except as provided in Sentence (3), a *vapour barrier* shall be installed to provide the principal resistance to water vapour diffusion.

**3)** A *vapour barrier* is not required where it can be shown that uncontrolled vapour diffusion will not adversely affect any of

- a) the health or safety of *building* users,
- b) the intended use of the *building*, or
- c) the operation of *building* services.



**5.5.1.2. Vapour Barrier Properties and Installation**

(See Note A-5.3.1.2.)

- 1)** The *vapour barrier* shall have sufficiently low permeance and shall be positioned in the *building* component or assembly so as to
  - a) minimize moisture transfer by diffusion, to surfaces within the assembly that would be cold enough to cause condensation at the design temperature and humidity conditions, or
  - b) reduce moisture transfer by diffusion, to surfaces within the assembly that would be cold enough to cause condensation at the design temperature and humidity conditions, to a rate that will not allow sufficient accumulation of moisture to cause deterioration or otherwise adversely affect any of
    - i) the health or safety of *building* users,
    - ii) the intended use of the *building*, or
    - iii) the operation of *building* services.

(See Note A-5.5.1.2.(1).)

**2)** Coatings applied to gypsum board to provide required resistance to vapour diffusion shall conform to the requirements of Sentence (1) when tested in accordance with CAN/CGSB-1.501-M, "Method for Permeance of Coated Wallboard."

**3)** Coatings applied to materials other than gypsum board to provide required resistance to vapour diffusion shall conform to the requirements of Sentence (1) when tested in accordance with ASTM E 96/E 96M, "Water Vapor Transmission of Materials," by the desiccant method (dry cup).

## Section 5.6. Precipitation

**5.6.1. Protection from Precipitation****5.6.1.1. Required Protection from Precipitation**

(See Note A-5.6.1.1.)

- 1)** Except as provided in Sentence (2), where a *building* component or assembly is exposed to precipitation, the component or assembly shall
  - a) minimize ingress of precipitation into the component or assembly, and
  - b) prevent ingress of precipitation into interior space.
- 2)** Protection from ingress of precipitation is not required where it can be shown that such ingress will not adversely affect any of
  - a) the health or safety of *building* users,
  - b) the intended use of the *building*, or
  - c) the operation of *building* services.

**5.6.1.2. Installation of Protective Materials**

**1)** Where protective materials are applied to assemblies to provide the required protection from precipitation, they shall be installed so as to shed precipitation or otherwise minimize its entry into the assembly and prevent its penetration through the assembly. (See Note A-5.6.1.2.(1).) (See also Clause 5.3.1.2.(1)(d).)

**2)** Where protective materials applied to assemblies to provide the required protection from precipitation are part of a vegetated roofing system, they shall be resistant to root and rhizome penetration when tested in accordance with ANSI/GRHC/SPRI VR-1, "Investigating Resistance to Root Penetration on Vegetative Roofs." (See Note A-5.6.1.2.(2).)

**5.6.2. Sealing, Drainage, Accumulation and Disposal****5.6.2.1. Sealing and Drainage**

(See Note A-5.6.2.1.)

**1)** Except as provided in Sentence (2), materials, components, assemblies, joints in materials, junctions between components and junctions between assemblies exposed to precipitation shall be

- a) sealed to prevent ingress of precipitation, or
- b) drained to direct precipitation to the exterior.

**2)** Sealing or drainage are not required where it can be shown that the omission of sealing and drainage will not adversely affect any of

- a) the health or safety of *building* users,
- b) the intended use of the *building*, or
- c) the operation of *building* services.

**5.6.2.2. Accumulation and Disposal**

**1)** Where water, snow or ice can accumulate on a *building*, provision shall be made to minimize the likelihood of hazardous conditions arising from such accumulation.

**2)** Where precipitation can accumulate on sloped or horizontal assemblies, provision shall be made for drainage conforming with the relevant provincial or territorial regulations or municipal bylaws or, in the absence of such regulations or bylaws, with Article 2.4.10.4. of Division B of the NPC.

**3)** Where downspouts are provided and are not connected to a sewer, provisions shall be made to

- a) divert the water from the *building*, and
- b) prevent *soil* erosion.

**4)** Junctions between vertical assemblies, and sloped or horizontal assemblies, shall be designed and constructed to minimize the flow of water from the sloped or horizontal assembly onto the vertical assembly.

**Section 5.7. Surface and Ground Water**

(See Note A-5.7.)

**5.7.1. Site Factors****5.7.1.1. Application**

**1)** This Subsection applies to the location of *buildings*, the grading of *building* sites, the directing of water away from *building* assemblies, and the provision of means for drainage.

**5.7.1.2. Required Protection**

**1)** The *building* shall be located, the *building* site shall be graded, or water shall be directed away from *building* assemblies so as to prevent or accommodate the accumulation of surface water against the *building* or adjacent *buildings*.

**2)** Drainage shall be provided to direct water away from assemblies separating interior space from the ground, except

- a) where the assembly is designed in accordance with Subsection 5.7.2. to withstand continuous hydrostatic pressure, or
- b) where it can be shown that the lack of drainage will not adversely affect
  - i) the health or safety of *building* users,
  - ii) the intended use of the *building*, or
  - iii) the operation of *building* services.

(See Note A-5.7.1.2.(2).)

**5.7.2. Protection against Hydrostatic Pressure****5.7.2.1. Application**

1) This Subsection applies to waterproofing materials, components, assemblies and systems applied to *building* assemblies that separate dissimilar environments and are subjected to hydrostatic pressure.

**5.7.2.2. Design of Building Elements Under Hydrostatic Loads**

1) Waterproofing materials, components, assemblies and systems described in Article 5.7.2.1. shall be designed in accordance with Subsection 5.1.4.

2) Hydrostatic design loads shall be determined in accordance with Subsection 5.2.2.

**5.7.2.3. Required Protection**

1) Waterproofing materials, components, assemblies and systems described in Article 5.7.2.1. shall comply with Article 5.7.3.2.

**5.7.3. Protection against Ground Water****5.7.3.1. Application**

1) This Subsection applies to the protection of *building* assemblies that separate interior space from the ground.

**5.7.3.2. Required Protection**

1) Except as provided in Sentence (2) and Article 5.7.3.4., *building* assemblies described in Article 5.7.3.1. shall be protected by waterproofing in accordance with Article 5.7.3.3. so as to prevent the ingress of water into the *building* or the accumulation of water against the *building*.

2) Waterproofing is not required where it can be shown that

- a) a *building* is designed to accommodate the ingress or accumulation of water, or
- b) the ingress or accumulation of water will not negatively affect
  - i) the health or safety of *building* users,
  - ii) the intended use of the *building*, or
  - iii) the operation of *building* services.

**5.7.3.3. Waterproofing**

1) Waterproofing materials, components, assemblies, or systems installed to provide the required protection shall form a continuous and impervious barrier to the ingress of water and be capable of accommodating

- a) imperfections, construction joints, control joints and expansion joints (see Note A-5.7.3.3.(1)(a)),
- b) junctions between different *building* assemblies, and
- c) elements penetrating *building* assemblies.

**5.7.3.4. Where Dampproofing is Permitted**

1) Vertical *building* assemblies that separate interior space from the ground are permitted to be dampproofed where

- a) such assemblies are not subjected to hydrostatic pressure,
- b) the substrate is cast-in-place concrete, and
- c) a drainage layer is installed between the *building* assembly and the *soil*.

(See Note A-5.7.3.4.(1).)

2) Joints, junctions and penetrations shall be designed and constructed to maintain the continuity of the dampproofing.

## Section 5.8. Sound Transmission

(See Note A-5.8.)

### 5.8.1. Protection from Airborne Noise

#### 5.8.1.1. Required Protection

- 1) Except as provided in Sentence (2), a *dwelling unit* shall be separated from every other space in a *building* in which noise may be generated by
  - a) a separating assembly and adjoining constructions, which, together, provide an *apparent sound transmission class (ASTC)* rating not less than 47, or
  - b) a separating assembly that provides a *sound transmission class (STC)* rating of not less than 50 and adjoining constructions that conform to Article 9.11.1.4.
- 2) Construction separating a *dwelling unit* from an elevator shaft or a refuse chute shall have an *STC* rating not less than 55.

#### 5.8.1.2. Determination of Sound Transmission Ratings

(See Note A-5.8.1.2.)

- 1) The *STC* ratings of separating assemblies shall be determined in accordance with ASTM E 413, "Classification for Rating Sound Insulation," using the results from measurements carried out in accordance with ASTM E 90, "Laboratory Measurement of Airborne Sound Transmission Loss of Building Partitions and Elements."
- 2) The *ASTC* ratings of separating assemblies and adjoining constructions shall be
  - a) determined in accordance with ASTM E 413, "Classification for Rating Sound Insulation," using the results from measurements carried out in accordance with ASTM E 336, "Measurement of Airborne Sound Attenuation between Rooms in Buildings," or
  - b) calculated in accordance with
    - i) the detailed method described in Article 5.8.1.4., or
    - ii) the simplified method described in Article 5.8.1.5.

#### 5.8.1.3. Compliance with Required Ratings

- 1) Compliance with the required *STC* ratings shall be demonstrated through
  - a) measurements carried out in accordance with Sentence 5.8.1.2.(1), or
  - b) the construction of separating assemblies conforming to those presented in Table 9.10.3.1.-A or 9.10.3.1.-B, as applicable.
- 2) Compliance with the required *ASTC* ratings shall be demonstrated through
  - a) measurements or calculations carried out in accordance with Sentence 5.8.1.2.(2), or
  - b) the construction of separating assemblies conforming to those presented in Table 9.10.3.1.-A or 9.10.3.1.-B, as applicable, that have an *STC* rating of not less than 50 in conjunction with flanking assemblies constructed in accordance with Article 9.11.1.4.

#### 5.8.1.4. Detailed Method for Calculating *ASTC*

(See Note A-5.8.1.4.)

- 1) The sound transmission loss measured in accordance with ASTM E 90, "Laboratory Measurement of Airborne Sound Transmission Loss of Building Partitions and Elements," shall be used in lieu of the sound reduction index required in ISO 15712-1, "Building Acoustics - Estimation of Acoustic Performance of Buildings From the Performance of Elements - Part 1: Airborne Sound Insulation Between Rooms."
- 2) The vibration reduction index for the junctions between separating assemblies shall be
  - a) determined using the equations presented in Annex E of ISO 15712-1, "Building Acoustics - Estimation of Acoustic Performance of Buildings

From the Performance of Elements - Part 1: Airborne Sound Insulation Between Rooms," or

- b) measured in accordance with Parts 1 to 4 of ISO 10848, "Acoustics - Laboratory Measurement of the Flanking Transmission of Airborne and Impact Sound Between Adjoining Rooms."

**3)** The normalized flanking level difference shall be measured in accordance with Parts 1 to 4 of ISO 10848, "Acoustics - Laboratory Measurement of the Flanking Transmission of Airborne and Impact Sound Between Adjoining Rooms."

**4)** The direct sound reduction index for the separating assembly in situ shall be determined using Clause (a) or (b), depending on the type of construction:

- a) for a lightweight separating wall or floor assembly with wood or steel framing, the index shall be taken as equal to the sound transmission loss, without correction;
- b) for a heavyweight separating wall or floor assembly of concrete or masonry, the index shall be determined in accordance with the detailed method for structure-borne transmission presented in ISO 15712-1, "Building Acoustics - Estimation of Acoustic Performance of Buildings From the Performance of Elements - Part 1: Airborne Sound Insulation Between Rooms."

**5)** The flanking sound reduction index for each flanking path at each edge of the separating assembly shall be determined using Clause (a), (b) or (c), depending on the type of construction:

- a) for a lightweight separating wall or floor assembly with wood or steel framing and connected lightweight flanking assemblies with wood or steel framing, the index shall be taken as equal to the normalized flanking level difference re-normalized for the *ASTC* field situation in accordance with Annex F of ISO 15712-1, "Building Acoustics - Estimation of Acoustic Performance of Buildings From the Performance of Elements - Part 1: Airborne Sound Insulation Between Rooms";
- b) for a heavyweight separating wall or floor assembly of concrete or masonry and connected flanking assemblies of concrete or masonry, the index shall be determined in accordance with the detailed method for structure-borne transmission presented in ISO 15712-1, "Building Acoustics - Estimation of Acoustic Performance of Buildings From the Performance of Elements - Part 1: Airborne Sound Insulation Between Rooms";
- c) for a mixture of lightweight framed assemblies and heavyweight concrete or masonry assemblies, the index shall be determined in accordance with Clause (a) or (b).

**6)** Once the pertinent indices and measurements referred to in Sentences (1) to (5) have been determined based on the type of construction, the apparent sound reduction index shall then be determined in accordance with ISO 15712-1, "Building Acoustics - Estimation of Acoustic Performance of Buildings From the Performance of Elements - Part 1: Airborne Sound Insulation Between Rooms."

**7)** The *ASTC* shall be calculated in accordance with ASTM E 413, "Classification for Rating Sound Insulation," using the apparent sound reduction index determined in Sentence (6), which shall be treated as equivalent to the values of apparent sound transmission loss measured in accordance with ASTM E 336, "Measurement of Airborne Sound Attenuation between Rooms in Buildings."

### 5.8.1.5. Simplified Method for Calculating *ASTC*

(See Note A-5.8.1.4.)

**1)** The *STC* rating shall be used in lieu of the weighted sound reduction index required in ISO 15712-1, "Building Acoustics - Estimation of Acoustic Performance of Buildings From the Performance of Elements - Part 1: Airborne Sound Insulation Between Rooms."

**2)** The vibration reduction index for the junctions between separating assemblies shall be

- a) determined using the equations presented in Annex E of ISO 15712-1, "Building Acoustics - Estimation of Acoustic Performance of Buildings

From the Performance of Elements - Part 1: Airborne Sound Insulation Between Rooms," or

- b) measured in accordance with Parts 1 to 4 of ISO 10848, "Acoustics - Laboratory Measurement of the Flanking Transmission of Airborne and Impact Sound Between Adjoining Rooms."

**3)** The weighted normalized flanking level difference shall be determined in accordance with ASTM E 413, "Classification for Rating Sound Insulation," using the results from measurements carried out in accordance with Parts 1 to 4 of ISO 10848, "Acoustics - Laboratory Measurement of the Flanking Transmission of Airborne and Impact Sound Between Adjoining Rooms."

**4)** The direct weighted sound reduction index for the separating assembly shall be taken as equal to the *STC*, without correction.

**5)** The weighted flanking sound reduction index for each flanking path at each edge of the separating assembly shall be determined using Clause (a) or (b), depending on the type of construction:

- a) for a lightweight separating wall or floor assembly with wood or steel framing and connected lightweight flanking assemblies with wood or steel framing, the index shall be taken as equal to the weighted normalized flanking level difference re-normalized for the *ASTC* field situation in accordance with Annex F of ISO 15712-1, "Building Acoustics - Estimation of Acoustic Performance of Buildings From the Performance of Elements - Part 1: Airborne Sound Insulation Between Rooms";
- b) for a heavyweight separating wall or floor assembly of concrete or masonry and connected flanking assemblies of concrete or masonry, the index shall be determined in accordance with the simplified method for structure-borne transmission presented in ISO 15712-1, "Building Acoustics - Estimation of Acoustic Performance of Buildings From the Performance of Elements - Part 1: Airborne Sound Insulation Between Rooms."

**6)** Once the pertinent indices and measurements referred to in Sentences (1) to (5) have been determined based on the type of construction, the *ASTC* shall then be calculated in accordance with ISO 15712-1, "Building Acoustics - Estimation of Acoustic Performance of Buildings From the Performance of Elements - Part 1: Airborne Sound Insulation Between Rooms."

## Section 5.9. Standards

### 5.9.1. Applicable Standards

#### 5.9.1.1. Compliance with Applicable Standards

**1)** Except as provided in Sentence (2) and elsewhere in this Part, materials and components, and their installation, shall conform to the requirements of the applicable standards in Table 5.9.1.1. where those materials or components are

- a) incorporated into environmental separators or assemblies exposed to the exterior, and
- b) installed to fulfill the requirements of this Part.

(See Note A-5.9.1.1.(1).)

**2)** The requirements for *flame-spread ratings* contained in thermal insulation standards shall be applied only as required in Part 3.

**Table 5.9.1.1.**  
**Standards Applicable to Environmental Separators and Assemblies Exposed to the Exterior**  
 Forming Part of Sentence 5.9.1.1.(1)

Issuing Agency	Document Number	Title of Document
ASME	B18.6.1	"Wood Screws (Inch Series)"
ASTM	A 123/A 123M	"Zinc (Hot-Dip Galvanized) Coatings on Iron and Steel Products"
ASTM	A 153/A 153M	"Zinc Coating (Hot-Dip) on Iron and Steel Hardware"
ASTM	A 653/A 653M	"Steel Sheet, Zinc-Coated (Galvanized) or Zinc-Iron Alloy-Coated (Galvannealed) by the Hot-Dip Process"
ASTM	C 4	"Clay Drain Tile and Perforated Clay Drain Tile"
ASTM	C 73	"Calcium Silicate Brick (Sand-Lime Brick)"
ASTM	C 126	"Ceramic Glazed Structural Clay Facing Tile, Facing Brick, and Solid Masonry Units"
ASTM	C 212	"Structural Clay Facing Tile"
ASTM	C 412M	"Concrete Drain Tile (Metric)"
ASTM	C 444M	"Perforated Concrete Pipe (Metric),"
ASTM	C 553	"Mineral Fiber Blanket Thermal Insulation for Commercial and Industrial Applications"
ASTM	C 612	"Mineral Fiber Block and Board Thermal Insulation"
ASTM	C 700	"Vitrified Clay Pipe, Extra Strength, Standard Strength, and Perforated"
ASTM	C 726	"Mineral Wool Roof Insulation Board"
ASTM	C 834 <sup>(1)</sup>	"Latex Sealants"
ASTM	C 840	"Application and Finishing of Gypsum Board"
ASTM	C 920 <sup>(1)</sup>	"Elastomeric Joint Sealants"
ASTM	C 991	"Flexible Fibrous Glass Insulation for Metal Buildings"
ASTM	C 1002	"Steel Self-Piercing Tapping Screws for the Application of Gypsum Panel Products or Metal Plaster Bases to Wood Studs or Steel Studs"
ASTM	C 1177/C 1177M	"Glass Mat Gypsum Substrate for Use as Sheathing"
ASTM	C 1178/C 1178M	"Coated Glass Mat Water-Resistant Gypsum Backing Panel"
ASTM	C 1184 <sup>(1)</sup>	"Structural Silicone Sealants"
ASTM	C 1311 <sup>(1)</sup>	"Solvent Release Sealants"
ASTM	C 1330 <sup>(1)</sup>	"Cylindrical Sealant Backing for Use with Cold Liquid-Applied Sealants"
ASTM	C 1396/C 1396M <sup>(2)</sup>	"Gypsum Board"
ASTM	C 1658/C 1658M <sup>(3)</sup>	"Glass Mat Gypsum Panels"
ASTM	D 1227	"Emulsified Asphalt Used as a Protective Coating for Roofing"
ASTM	D 2178/D 2178M	"Asphalt Glass Felt Used in Roofing and Waterproofing"
ASTM	D 3019 <sup>(4)</sup>	"Lap Cement Used with Asphalt Roll Roofing, Non-Fibered, Asbestos-Fibered, and Non-Asbestos-Fibered"
ASTM	D 4479/D 4479M	"Asphalt Roof Coatings – Asbestos-Free"
ASTM	D 4637/D 4637M	"EPDM Sheet Used In Single-Ply Roof Membrane"
ASTM	D 4811/D 4811M	"Nonvulcanized (Uncured) Rubber Sheet Used as Roof Flashing"
ASTM	D 6878/D 6878M	"Thermoplastic Polyolefin Based Sheet Roofing"
ASTM	E 2190	"Insulating Glass Unit Performance and Evaluation"
BNQ	BNQ 3624-115	"Polyethylene (PE) Pipe and Fittings – Flexible Pipes for Drainage – Characteristics and Test Methods"
CGSB	CAN/CGSB-11.3-M	"Hardboard"
CGSB	CAN/CGSB-11.5-M	"Hardboard, Precoated, Factory Finished, for Exterior Cladding"
CGSB	CAN/CGSB-12.1-M	"Tempered or Laminated Safety Glass"
CGSB	CAN/CGSB-12.2-M	"Flat, Clear Sheet Glass"
CGSB	CAN/CGSB-12.3-M	"Flat, Clear Float Glass"

Table 5.9.1.1. (Continued)

Issuing Agency	Document Number	Title of Document
CGSB	CAN/CGSB-12.4-M	"Heat Absorbing Glass"
CGSB	CAN/CGSB-12.8	"Insulating Glass Units"
CGSB	CAN/CGSB-12.10-M	"Glass, Light and Heat Reflecting"
CGSB	CAN/CGSB-12.11-M	"Wired Safety Glass"
CGSB	37-GP-9Ma	"Primer, Asphalt, Unfilled, for Asphalt Roofing, Dampproofing and Waterproofing"
CGSB	CAN/CGSB-37.50-M	"Hot-Applied, Rubberized Asphalt for Roofing and Waterproofing"
CGSB	CAN/CGSB-37.54	"Polyvinyl Chloride Roofing and Waterproofing Membrane"
CGSB	37-GP-56M	"Membrane, Modified, Bituminous, Prefabricated, and Reinforced for Roofing"
CGSB	CAN/CGSB-37.58-M	"Membrane, Elastomeric, Cold-Applied Liquid, for Non-Exposed Use in Roofing and Waterproofing"
CGSB	CAN/CGSB-41.24	"Rigid Vinyl Siding, Soffits and Fascia"
CGSB	CAN/CGSB-51.32-M	"Sheathing, Membrane, Breather Type"
CGSB	CAN/CGSB-51.33-M	"Vapour Barrier Sheet, Excluding Polyethylene, for Use in Building Construction"
CGSB	CAN/CGSB-51.34-M	"Vapour Barrier, Polyethylene Sheet for Use in Building Construction"
CGSB	CAN/CGSB-93.1-M	"Sheet, Aluminum Alloy, Prefinished, Residential"
CGSB	CAN/CGSB-93.2-M	"Prefinished Aluminum Siding, Soffits, and Fascia, for Residential Use"
CGSB	CAN/CGSB-93.3-M	"Prefinished Galvanized and Aluminum-Zinc Alloy Steel Sheet for Residential Use"
CGSB	CAN/CGSB-93.4	"Galvanized Steel and Aluminum-Zinc Alloy Coated Steel Siding, Soffits and Fascia, Prefinished, Residential"
CSA	A23.1	"Concrete Materials and Methods of Concrete Construction"
CSA	CAN/CSA-A82	"Fired Masonry Brick Made from Clay or Shale"
CSA	CAN3-A93-M	"Natural Airflow Ventilators for Buildings"
CSA	A123.1/A123.5	"Asphalt Shingles Made From Organic Felt and Surfaced with Mineral Granules/Asphalt Shingles Made From Glass Felt and Surfaced with Mineral Granules"
CSA	CAN/CSA-A123.2	"Asphalt-Coated Roofing Sheets"
CSA	A123.3	"Asphalt Saturated Organic Roofing Felt"
CSA	CAN/CSA-A123.4	"Asphalt for Constructing Built-Up Roof Coverings and Waterproofing Systems"
CSA	A123.17	"Asphalt Glass Felt Used in Roofing and Waterproofing"
CSA	CAN3-A123.51-M	"Asphalt Shingle Application on Roof Slopes 1:3 and Steeper"
CSA	CAN3-A123.52-M	"Asphalt Shingle Application on Roof Slopes 1:6 to Less Than 1:3"
CSA	A165.1	"Concrete Block Masonry Units"
CSA	A165.2	"Concrete Brick Masonry Units"
CSA	A165.3	"Prefaced Concrete Masonry Units"
CSA	A179	"Mortar and Grout for Unit Masonry"
CSA	CAN/CSA-A220	"Concrete Roof Tiles"
CSA	A371	"Masonry Construction for Buildings"
CSA	A3001	"Cementitious Materials for Use in Concrete"
CSA	CAN/CSA-B182.1	"Plastic Drain and Sewer Pipe and Pipe Fittings"
CSA	G40.21	"Structural Quality Steel"
CSA	G401	"Corrugated Steel Pipe Products"
CSA	CAN/CSA-O80 Series	"Wood Preservation"
CSA	O118.1	"Western Red Cedar Shakes and Shingles"
CSA	O118.2	"Eastern White Cedar Shingles"
CSA	O121	"Douglas Fir Plywood"



**Table 5.9.1.1. (Continued)**

Issuing Agency	Document Number	Title of Document
CSA	O141	“Softwood Lumber”
CSA	O151	“Canadian Softwood Plywood”
CSA	O153	“Poplar Plywood”
CSA	O325	“Construction Sheathing”
CSA	O437.0	“OSB and Waferboard”
HPVA	ANSI/HPVA HP-1	“Hardwood and Decorative Plywood”
ULC	CAN/ULC-S701	“Thermal Insulation, Polystyrene, Boards and Pipe Covering”
ULC	CAN/ULC-S702	“Mineral Fibre Thermal Insulation for Buildings”
ULC	CAN/ULC-S703	“Cellulose Fibre Insulation for Buildings”
ULC	CAN/ULC-S704	“Thermal Insulation, Polyurethane and Polyisocyanurate, Boards, Faced”
ULC	CAN/ULC-S705.1	“Thermal Insulation – Spray Applied Rigid Polyurethane Foam, Medium Density – Material – Specification”
ULC	CAN/ULC-S705.2	“Thermal Insulation – Spray Applied Rigid Polyurethane Foam, Medium Density – Application”
ULC	CAN/ULC-S706	“Wood Fibre Insulating Boards for Buildings”
ULC	CAN/ULC-S710.1	“Thermal Insulation – Bead-Applied One Component Polyurethane Air Sealant Foam, Part 1: Material Specification”
ULC	CAN/ULC-S711.1	“Thermal Insulation – Bead-Applied Two Component Polyurethane Air Sealant Foam, Part 1: Material Specification”

**Notes to Table 5.9.1.1.:**

- (1) See Note A-Table 5.9.1.1.
- (2) The *flame-spread rating* of gypsum board shall be determined in accordance with CAN/ULC-S102 in lieu of ASTM E 84 as indicated in ASTM C 1396/C 1396M.
- (3) The *flame-spread rating* of glass mat gypsum panels shall be determined in accordance with CAN/ULC-S102 in lieu of ASTM E 84 as indicated in ASTM C 1658/C 1658M.
- (4) For the purpose of compliance with Part 5, ASTM D 3019 shall only apply to the non-fibered and non-asbestos-fibered types of asphalt roll roofing.

**5.9.2. Windows, Doors and Skylights**

**5.9.2.1. General**

- 1)** This Subsection applies to windows, doors and skylights, including their components, that separate
  - a) interior space from exterior space, or
  - b) environmentally dissimilar interior spaces.
- 2)** For the purpose of this Subsection, the term “skylight” refers to unit skylights, roof windows and tubular daylighting devices.
- 3)** Where a wired glass assembly is installed in a required *fire separation*, it need not conform to the requirements of this Subsection. (See Note A-5.9.2.1.(3).)

**5.9.2.2. Applicable Standards**

(See Note A-5.9.2.2.)

- 1)** Windows, doors and skylights shall conform to the requirements in
  - a) AAMA/WDMA/CSA 101/I.S.2/A440, “NAFS – North American Fenestration Standard/Specification for Windows, Doors, and Skylights,” and
  - b) CSA A440S1, “Canadian Supplement to AAMA/WDMA/CSA 101/I.S.2/A440, NAFS – North American Fenestration Standard/Specification for Windows, Doors, and Skylights.”
- 2)** Performance grades for windows, doors and skylights shall be selected according to the Canadian Supplement referenced in Clause (1)(b) so as to be

appropriate for the conditions and geographic location in which the window, door or skylight will be installed.

**3)** Windows, doors and skylights shall conform to the performance grades selected in Sentence (2) when tested in accordance with the Harmonized Standard referenced in Clause (1)(a).

### 5.9.2.3. Structural and Environmental Loads, Air Leakage and Water Penetration

**1)** Windows, doors, skylights and their components shall be designed and constructed in accordance with

- a) Article 5.1.4.1., Section 5.4. and Section 5.6., or
- b) Article 5.9.2.2., where they are covered in the scope of the standards listed in Sentence 5.9.2.2.(1).

(See Note A-5.9.2.3.(1).)

### 5.9.2.4. Heat Transfer

**1)** Windows, doors and skylights shall meet the heat transfer performance requirements stated in Section 5.3. (See Note A-5.3.1.2.)

**2)** Except as provided in Sentence (3), all metal-framed glazed assemblies separating interior *conditioned space* from interior unconditioned space or exterior space shall incorporate a thermal break to minimize condensation.

**3)** Metal-framed glazed assemblies need not comply with Sentence (2) where these assemblies are

- a) storm windows or doors, or
- b) windows or doors that are required to have a *fire-protection rating*.

(See Note A-5.9.2.4.(3).)

### 5.9.3. Other Fenestration Assemblies

(See Note A-5.9.3.)

#### 5.9.3.1. General

**1)** For the purpose of this Subsection, the term “other fenestration assemblies” refers to curtain walls, window walls, storefronts and glazed architectural structures. (See Note A-5.9.3.1.(1).)

#### 5.9.3.2. Structural and Environmental Loads

**1)** Other fenestration assemblies and their components shall be designed and constructed in accordance with Article 5.1.4.1. (See Note A-5.9.3.2.(1).)

#### 5.9.3.3. Heat Transfer

**1)** Other fenestration assemblies and their components shall meet the heat transfer performance requirements stated in Section 5.3. (See Note A-5.9.3.3.(1).)

**2)** Other fenestration assemblies using metal framing that separate interior *conditioned space* from interior unconditioned space or exterior space shall incorporate a thermal break to minimize condensation.

#### 5.9.3.4. Air Leakage

**1)** Other fenestration assemblies and their components shall be designed and constructed in accordance with Section 5.4.

**2)** Except as provided in Sentence (3), other fenestration assemblies and their components shall have an air leakage characteristic, measured at an air pressure difference of 75 Pa, when tested in accordance with ASTM E 283, “Determining Rate of

Air Leakage Through Exterior Windows, Curtain Walls, and Doors Under Specified Pressure Differences Across the Specimen," that is not greater than

- a) 0.2 L/(s·m<sup>2</sup>) for fixed portions, including any opaque portions, and
- b) 1.5 L/(s·m<sup>2</sup>) for operable portions.

(See Note A-5.9.3.4.(2).)

**3)** The following systems need not comply with Sentence (2):

- a) interior windows and interior doors that do not serve as environmental separators,
- b) vehicular access doors (garage doors),
- c) storm windows and storm doors,
- d) commercial entrance systems,
- e) revolving doors,
- f) smoke and relief air vents,
- g) site-built door systems, and
- h) commercial steel doors.

(See Note A-5.9.3.4.(3).)

**5.9.3.5. Water Penetration**

**1)** Other fenestration assemblies and their components shall be designed and constructed in accordance with Section 5.6.

**2)** Except as provided in Sentence (4), other fenestration assemblies and their components not covered in Article 5.9.2.2. shall resist water penetration when tested in accordance with

- a) ASTM E 331, "Water Penetration of Exterior Windows, Skylights, Doors, and Curtain Walls by Uniform Static Air Pressure Difference," or
- b) ASTM E 547, "Water Penetration of Exterior Windows, Skylights, Doors, and Curtain Walls by Cyclic Static Air Pressure Difference."

(See Note A-5.9.3.5.(2).)

**3)** Tests referred to in Sentence (2) shall be carried out at the driving rain wind pressure as calculated in accordance with CSA A440S1, "Canadian Supplement to AAMA/WDMA/CSA 101/I.S.2/A440, NAFS – North American Fenestration Standard/Specification for Windows, Doors, and Skylights." (See Note A-5.9.3.5.(3).)

**4)** The following systems need not comply with Sentence (2):

- a) interior windows and interior doors,
- b) vehicular access doors (garage doors),
- c) storm windows and storm doors,
- d) commercial entrance systems,
- e) revolving doors,
- f) smoke and relief air vents,
- g) site-built door systems, and
- h) commercial steel doors.

(See Note A-5.9.3.5.(4).)

**5.9.4. Exterior Insulation Finish Systems**

**5.9.4.1. Structural Loads, Heat Transfer, Air Leakage, Vapour Diffusion and Water Penetration**

**1)** Exterior insulation finish systems and their components shall comply with

- a) Subsection 5.1.4. and Sections 5.3. to 5.6., and
- b) CAN/ULC-S716.1, "Exterior Insulation and Finish Systems (EIFS) - Materials and Systems," where covered in the scope of that standard.

(See Note A-5.9.4.1.(1).)

# Section 5.10. Objectives and Functional Statements

## 5.10.1. Objectives and Functional Statements

### 5.10.1.1. Attributions to Acceptable Solutions

1) For the purpose of compliance with this Code as required in Clause 1.2.1.1.(1)(b) of Division A, the objectives and functional statements attributed to the acceptable solutions in this Part shall be the objectives and functional statements listed in Table 5.10.1.1. (See Note A-1.1.2.1.(1).)

**Table 5.10.1.1.**  
**Objectives and Functional Statements Attributed to the**  
**Acceptable Solutions in Part 5**  
Forming Part of Sentence 5.10.1.1.(1)

Functional Statements and Objectives <sup>(1)</sup>		
<b>5.1.4.1. Structural and Environmental Loads</b>		
(1)	(a) [F55,F61,F63-OH1.1,OH1.2,OH1.3] [F20-OS3.1] Applies to snow fences and sloped glazing. [F61-OH4]	
	(a) [F60,F61,F63-OS2.2,OS2.3]	
	(a) [F20,F51,F55-OS1.4] Applies where required life safety systems are incorporated in environmental separators.	
	(b) [F20-OS2.1] [F21,F22-OS2.3,OS2.4]	
	(b) [F20,F21,F22-OH1.1,OH1.2,OH1.3]	
	(b) [F20-OH4]	
	(4)	[F20-OS2.1] [F21,F22-OS2.3,OS2.4] [F20,F21,F22-OH1.1,OH1.2,OH1.3]
(5)	(a) [F20-OS2.1] [F21,F22-OS2.3,OS2.4]	
	(a) [F20,F21,F22-OH1.1,OH1.2,OH1.3]	
	(b) [F20-OS2.1] [F21,F22-OS2.3,OS2.4]	
	(b) [F20,F21,F22-OH1.1,OH1.2,OH1.3]	
(6)	[F20,F21,F22-OH1.1,OH1.2,OH1.3]	
	(a) [F20-OS2.1,OS2.3]	
	(b) and (c) [F21,F22-OS2.3]	
	(b) and (c) [F22-OH4]	
<b>5.1.4.2. Resistance to Deterioration</b>		
(1)	[F80,F81-OH1.1,OH1.2,OH1.3] [F80,F81-OS3.1] Applies to floor assemblies. [F80,F81-OH4] Applies to floor assemblies. [F80,F81-OS2.3] [F80,F81-OS1.4] Applies where required life safety systems are incorporated in environmental separators.	
	<b>5.2.1.1. Exterior Environmental Loads</b>	
	(2)	[F40,F20-OH1.1] [F20-OH1.2,OH1.3] [F20-OS2.1]

**Table 5.10.1.1. (Continued)**

Functional Statements and Objectives <sup>(1)</sup>			
<b>5.2.1.2. Interior Environmental Loads</b>			
(1)	[F51,F55,F61,F63-OH1.1,OH1.2] [F55,F61,F63-OS2.3] [F51,F61,F63,F55-OS1.4] Applies where required life safety systems are incorporated in environmental separators.		
	<b>5.2.1.3. Environmental Load and Transfer Calculations</b>		
	(1)	[F56-OH3.1] Applies to sound transmission calculations. [F61,F51,F63,F55-OH1.1,OH1.2] [F51,F61-OH1.3] Applies to heat, air and moisture transfer calculations. [F61,F51,F63-OS2.3] Applies to heat, air and moisture transfer calculations.	
(3)		[F61,F63,F55-OH1.1,OH1.2] [F61,F55-OH1.3] [F20-OS1.4] Applies where required life safety systems are incorporated in environmental separators. [F20-OS2.1]	
		<b>5.2.2.1. Determination of Structural Loads and Effects</b>	
(1)	[F20-OS2.1] [F21,F22-OS2.3,OS2.4] [F20,F21,F22-OH1.1,OH1.2,OH1.3] [F20,F21,F22-OH4]		
	(3)	[F20-OS2.1] [F21,F22-OS2.3,OS2.4] [F20,F21,F22-OH1.1,OH1.2,OH1.3] [F20,F21,F22-OH4]	
		<b>5.2.2.2. Determination of Wind Load</b>	
(2)		[F20-OS2.1] [F22-OS2.3,OS2.4] [F20,F22-OH1.1,OH1.2,OH1.3] [F20,F22-OH4]	
	(3)	[F20-OS2.1] [F22-OS2.3,OS2.4] [F20,F22-OH1.1,OH1.2,OH1.3] [F20,F22-OH4]	
		(4)	[F20,F55,F61-OH1.1,OH1.2,OH1.3] [F20,F55,F61-OS2.1,OS2.3]
			<b>5.2.2.3. Design Procedures</b>
(1)	[F20-OS2.1] [F22-OS2.3,OS2.4] [F20,F22-OH1.1,OH1.2,OH1.3] [F20,F22-OH4]		

**Table 5.10.1.1. (Continued)**

Functional Statements and Objectives <sup>(1)</sup>	
<b>5.3.1.1. Required Resistance to Heat Transfer</b>	
(1)	[F63-OH1.1] [F51,F63-OH1.2]
	[F63-OS2.3]
	[F51,F63-OS1.4] Applies where required life safety systems are incorporated in environmental separators.
<b>5.3.1.2. Properties to Resist Heat Transfer or Dissipate Heat</b>	
(1)	(a),(b) [F51,F63-OH1.1] (c) [F51-OH1.2]
	(b) and (d) [F51,F63-OS2.3]
	(b) [F51,F63-OS1.4] Applies where required life safety systems are incorporated in environmental separators.
	(d) [F30-OS3.1]
<b>5.3.1.3. Location and Installation of Materials Providing Thermal Resistance</b>	
(1)	[F51,F63-OH1.1]
	[F63-OS2.3]
(2)	[F51,F63-OH1.1,OH1.2]
	[F63-OS2.3]
	[F51,F63-OS1.4] Applies where required life safety systems are incorporated in environmental separators.
<b>5.4.1.1. Required Resistance to Air Leakage</b>	
(1)	(a),(b),(f) [F51,F52,F54,F55-OH1.2] (a),(b),(c),(e) [F40,F55-OH1.1] (c) [F55,F61,F63-OH1.3]
	(c) and (d) [F61,F62,F63,F55-OS2.3]
	(d) [F55,F62-OS3.1]
	(f) [F55,F62-OS1.4] Applies where required life safety systems are incorporated in environmental separators.
	[F51,F55-OS1.4] Applies where required life safety systems are incorporated in environmental separators.
(2)	[F40-OH1.1] [F52,F54-OH1.2] [F51,F55,F61,F63-OH1.1,OH1.2,OH1.3]
	[F61,F63-OS2.3]
	[F51,F55-OS1.4] Applies where required life safety systems are incorporated in environmental separators.
<b>5.4.1.2. Air Barrier System Properties</b>	
(1)	[F55-OH1.1,OH1.2,OH1.3]
	[F55-OS2.3]
	[F55-OS1.4] Applies where required life safety systems are incorporated in environmental separators.
(3)	[F61,F51,F63,F55-OH1.1,OH1.2] [F55,F61-OH1.3]
	[F61,F63-OS2.3]
	[F61,F51,F63-OS1.4] Applies where required life safety systems are incorporated in environmental separators.
<b>5.5.1.1. Required Resistance to Vapour Diffusion</b>	
(1)	[F63-OH1.1,OH1.2]
	[F63-OS2.3]
(2)	[F63-OH1.1,OH1.2]
	[F63-OS2.3]

**Table 5.10.1.1. (Continued)**

Functional Statements and Objectives <sup>(1)</sup>	
<b>5.5.1.2. Vapour Barrier Properties and Installation</b>	
(1)	[F63-OH1.1,OH1.2]
	[F63-OS2.3]
(2)	[F63-OH1.1,OH1.2]
	[F63-OS2.3]
(3)	[F63-OH1.1,OH1.2]
	[F63-OS2.3]
<b>5.6.1.1. Required Protection from Precipitation</b>	
(1)	[F61-OH1.1,OH1.2,OH1.3]
	[F61-OS2.3]
<b>5.6.1.2. Installation of Protective Materials</b>	
(1)	[F61-OH1.1,OH1.2,OH1.3]
	[F61-OS2.3]
(2)	[F61-OH1.1,OH1.2,OH1.3]
	[F61-OS2.3]
<b>5.6.2.1. Sealing and Drainage</b>	
(1)	[F61,F62-OH1.1,OH1.2,OH1.3]
	[F61,F62-OS2.3]
<b>5.6.2.2. Accumulation and Disposal</b>	
(1)	[F30-OS3.1]
(2)	[F61-OH1.1,OH1.2,OH1.3]
	[F61-OS2.3]
(3)	[F61-OH1.1,OH1.2,OH1.3]
	[F60-OS2.3] [F21-OS2.2]
	(b) [F21-OP2.6]
(4)	[F61-OH1.1,OH1.2,OH1.3]
	[F61-OS2.3]
<b>5.7.1.2. Required Protection</b>	
(1)	[F60-OH1.1,OH1.2,OH1.3]
	[F60-OS2.3]
(2)	[F60-OH1.1,OH1.2,OH1.3]
	[F60-OS2.2,OS2.3]
<b>5.7.3.2. Required Protection</b>	
(1)	[F61-OH1.1,OH1.2,OH1.3]
	[F61-OS2.3]
<b>5.7.3.3. Waterproofing</b>	
(1)	[F61-OH1.1,OH1.2,OH1.3]
	[F61-OS2.3]
<b>5.7.3.4. Where Dampproofing is Permitted</b>	
(1)	[F61-OH1.1,OH1.2,OH1.3]
	[F61-OS2.3]
(2)	[F61-OH1.1,OH1.2,OH1.3]
	[F61-OS2.3]

Table 5.10.1.1. (Continued)

Functional Statements and Objectives <sup>(1)</sup>	
<b>5.8.1.1. Required Protection</b>	
(1)	[F56-OH3.1]
(2)	[F56-OH3.1]
<b>5.8.1.2. Determination of Sound Transmission Ratings</b>	
(1)	[F56-OH3.1]
(2)	[F56-OH3.1]
<b>5.8.1.4. Detailed Method for Calculating ASTC</b>	
(1)	[F56-OH3.1]
(2)	[F56-OH3.1]
(3)	[F56-OH3.1]
(4)	[F56-OH3.1]
(5)	[F56-OH3.1]
(6)	[F56-OH3.1]
(7)	[F56-OH3.1]
<b>5.8.1.5. Simplified Method for Calculating ASTC</b>	
(1)	[F56-OH3.1]
(2)	[F56-OH3.1]
(3)	[F56-OH3.1]
(4)	[F56-OH3.1]
(5)	[F56-OH3.1]
(6)	[F56-OH3.1]
<b>5.9.1.1. Compliance with Applicable Standards</b>	
(1)	[F20,F22,F51,F54,F55,F61,F63,F80-OH1.1,OH1.2] [F41,F55-OH1.1] [F55,F61,F80-OH1.3]
	[F20,F80-OS2.1] [F20,F22,F51,F61,F63,F80-OS2.3] [F51-OS2.5]
	[F80,F61,F63-OS3.1]
	[F80,F61,F63-OH4] Applies to floor assemblies.
	(a) [F61,F63-OS1.4] Applies where required life safety systems are incorporated in environmental separators.
	[F20,F80-OP2.1,OP2.3] [F22,F80-OP2.4]
	[F42-OH2.5]
<b>5.9.2.2. Applicable Standards</b>	
(1)	[F20,F55,F61,F63-OH1.1,OH1.3] [F20,F55,F61,F63,F81-OH1.2]
	[F20,F55,F61-OS2.3]
	[F20,F55,F61-OP2.3]
<b>5.9.2.4. Heat Transfer</b>	
(2)	[F63-OH1.1,OH1.2]
	[F63-OS2.3]
<b>5.9.3.3. Heat Transfer</b>	
(2)	[F63-OH1.1,OH1.2]
	[F63-OS2.3]

Table 5.10.1.1. (Continued)

Functional Statements and Objectives <sup>(1)</sup>	
<b>5.9.3.4. Air Leakage</b>	
(2)	[F55,F63-OH1.1,OH1.2,OH1.3]
	[F55,F63-OS2.3]
	[F55-OS1.4] Applies where required life safety systems are incorporated in environmental separators.
<b>5.9.3.5. Water Penetration</b>	
(2)	[F61-OH1.1,OH1.2,OH1.3]
	[F61-OS2.3]
<b>5.9.4.1. Structural Loads, Heat Transfer, Air Leakage, Vapour Diffusion and Water Penetration</b>	
(1)	(b) [F61,F62-OH1.1,OH1.2,OH1.3]
	(b) [F61,F62-OS2.3]

**Notes to Table 5.10.1.1.:**

(1) See Parts 2 and 3 of Division A.

# Notes to Part 5 Environmental Separation

**A-5 Environmental Separation.** The requirements provided in Part 5 pertain to the separation of environmentally dissimilar spaces. Most obvious is the need to separate indoor conditioned spaces from unconditioned spaces, the outdoors or the ground. There are also cases where separation is needed between interior spaces which are intended to provide different environments. (See also Notes A-5.1.1.1.(1) and A-5.1.2.1.(1).)

**A-5.1.1.1.(1) Scope.** Part 5 provides explicit requirements related to the transfer of heat, air, moisture and sound in various forms. Control of the ingress of radon and other soil gases is addressed by the requirements related to air leakage.

**A-5.1.2.1.(1) Application.** Subsection 1.3.3. of Division A specifies that Part 5 applies to all buildings except those within the scope of Part 9 or the scope of the National Farm Building Code of Canada. Because of their intended use, many buildings need only provide a limited degree of separation from the outdoor environment, the ground, or between interior spaces. The provisions in Part 5 are written to allow exemptions for these buildings.

Part 5 applies to building elements that separate dissimilar environments and to site conditions that may affect environmental loading on the building envelope.

The provisions address

- the design and construction, or selection, of building components, such as windows and doors,
- the design and construction of building assemblies, such as walls, floors and roofs,
- the design and construction of the interfaces between the above-mentioned elements, and
- the design or selection, and installation, of site materials, components and assemblies, such as backfill and drainage, and grading.

Part 5 applies not only to building elements that separate indoor space from outdoor space, but also to those elements that separate indoor space from the ground and that separate adjacent indoor spaces having significantly different environments.

Indoor spaces that require separation include interior conditioned spaces adjacent to indoor unconditioned spaces, and adjacent interior conditioned spaces that are intended to provide different environments. An extreme example of the last would be a wall that separates an indoor ice rink from a swimming pool.

Some building elements are exposed to exterior environmental loads but do not separate dissimilar environments. Solid guards on exterior walkways are one example. Such constructions are subject to the application of Part 5.

**A-5.1.4.1. Application of Structural Design to Other Building Elements.** Part 4, as currently written, applies primarily to buildings as a whole and to structural members. Requirements defining structural loads and design to accommodate or resist those loads, however, apply not only to buildings as a whole and components that are traditionally recognized as structural members, but also apply to other elements of the building that are subject to structural loading. This is addressed to some extent in Part 4 by the requirements that pertain, for example, to wind loads on cladding. A range of structural loads and effects, as defined in Subsection 4.1.2., may be imposed on non-loadbearing elements such as backing walls, roofing, interior partitions and their connections. These must generally be addressed using the same load determination and structural design procedures as used for structural members.

---

These Notes are included for explanatory purposes only and do not form part of the requirements. The number that introduces each Note corresponds to the applicable requirement in this Part.

Responsibility for the structural design of buildings as a whole and their structural members is commonly assigned to the engineer of record. The application of Part 4 reflects this, and as such, “non-structural” elements are not explicitly identified in the Part 4 provisions. Rather the application of Part 4 to these elements is specified in cross-references from other Parts of the Code, e.g. Part 5, which recognizes the fact that the structural design of these elements is often carried out by engineers other than the engineer of record.

Part 4 does not generally apply to the structural design of building services, such as heating, ventilating, air-conditioning, plumbing, electrical, electronic or fire safety systems, though these may be subject to structural loads. It does, however, apply to the design of the connections of building services to address earthquake loads (see Article 4.1.8.18.).

**A-5.1.4.1.(2) Materials, Components and Assemblies with Multiple Functions.** Where materials, components or assemblies are used to fulfill multiple functions, the designer may have to take into account their function with regard to structural loads, heat transfer, air leakage, vapour diffusion, and protection from precipitation, surface and ground water, and sound transmission. Materials should be selected taking into account the environmental loads to which they will be subjected, their physical and chemical characteristics, and their installation. Design and construction details should satisfy all intended functions and ensure continuity within and between assemblies, without adversely impacting adjacent materials, components or assemblies. The designer should also anticipate unintended consequences when materials that may fulfill multiple functions are used. For example, building membranes consisting of modified bitumen compounds, which are commonly used to control both water ingress and air leakage, also typically have low vapour transmission characteristics. Similarly, extruded polystyrene boards, which are used as thermal insulation, may also act as a component of an air barrier assembly, thus requiring wind loads to be considered.

An increasing number of manufactured systems are being used to serve more than one (and sometimes all) of the functions of an environmental separator: examples include pre-engineered building systems, exterior insulation finish systems, insulated metal panel systems, windows, other fenestration assemblies, and insulated precast concrete wall panels. These systems consist of combinations of pre-manufactured and/or site-built components, which are supposed to be assembled in a prescribed manner.

Ensuring compliance with one Section of Part 5 may impact compliance with other Sections of Part 5: for example, air barriers that are integral to some systems may also act as vapour barriers and impact condensation control. By extension, ensuring compliance with the requirements of Part 5 may impact compliance with other Parts of the NBC: for example, increasing the thickness of the insulation to improve an assembly’s thermal performance may impact its compliance with Part 3 with regard to fire resistance.

Compliance with a standard listed in Section 5.9. does not ensure that a system is appropriate for the intended application. The designer should consider all relevant criteria, beyond the standard tests, when selecting an appropriate product for a project.

**A-5.1.4.1.(5) Past Performance as Basis for Compliance with Respect to Structural Loads.** As discussed in Note A-5.1.4.1., a range of structural loads and effects can be imposed on materials, components and assemblies in environmental separators and assemblies exposed to the exterior. In many instances, compliance with Sentence 5.1.4.1.(1) for structural loads must be determined based on the loads and calculation methods described in Part 4 as specified in Sentence 5.1.4.1.(3) and the referenced Subsection 5.2.2., e.g. for cladding. In practice, compliance for some materials, components or assemblies of environmental separators and assemblies exposed to the exterior is determined by relying on provisions governing the use of alternative solutions (such as Clause 1.2.1.1.(1)(b) of Division A).

For some very common building elements and installations, however, there is a very large body of evidence of proven performance over a long period of time. In these cases, imposing the degree of analysis, or documentation of performance, required by Part 4 or Section 2.3. of Division C would be unnecessary and onerous. Clause 5.1.4.1.(5)(b) is intended to address these particular cases. Because the constructions are so widely accepted throughout the industry and the body of evidence is so substantial (though not necessarily documented in an organized fashion), there should be no question that detailed analysis or documentation is unnecessary.

Whether compliance of a particular material, component or assembly may be determined based on past performance depends not only on the type of material, component or assembly, but also on its intended function, the particular loads to which it will be subject and the magnitude of those loads. Because the possible combinations and permutations are infinite, only guidelines can be provided as to when past performance is a reasonable basis for determining compliance.



In determining compliance based on past performance, the period of past performance considered should be a substantial number of years. For example, 30 years is often used to do life-cycle cost analysis of the viability of investments in building improvements. This period is more than long enough for most deficiencies to show up. There should be no question as to the structural adequacy of a material, component or assembly that has been successfully used in a given application for such a period.

The determination of compliance may be based on past performance only where the function of the material, component or assembly is identical to that of the materials, components or assemblies used as a reference, and where the expected loads do not exceed those imposed on the reference materials, components or assemblies. For example, the acceptance of gypsum board, and its fastening, to serve as part of the backing wall supporting cladding cannot be based on the performance of gypsum board that has served only as an interior finish.

The determination of compliance may be based on past performance only where the properties of the material, component or assembly are identical or superior to those of the materials, components or assemblies used as a reference. For example, where a component of a certain gauge of a particular metal has provided acceptable performance, the same component made of the same metal or a stronger one would be acceptable.

Compliance with respect to various loads may be determined individually. A particular material may have to be designed to Part 4 to establish acceptable resistance to wind or earthquake loads, for example, but past performance may be adequate to determine that the material and normal fastening will support the material's dead load and will resist loads imposed by thermal and moisture-related expansion and contraction.

Past performance is a reasonable basis for determining compliance for lighter materials, components or assemblies not subject to wind load; for example, semi-rigid thermal insulation installed in wall assemblies where other materials, components or assemblies are installed to resist air pressure loads.

Past performance is an appropriate basis for determining compliance for some smaller elements that will be subject to wind loads but are continually supported or fastened behind elements that are designed for wind loads, for example, standard flashing over wall penetrations.

It should be noted that this particular approach to demonstrating compliance pertains only to the resistance or accommodation of structural loads described in Part 4. The resistance or accommodation of environmental loads, resistance to deterioration, and material compatibility must still be addressed in accordance with Part 5.

**A-5.1.4.1.(6)(b) and (c) Accommodating Movement.** It is well understood that the deflection of the backing assembly in a wall can have significant effects on the performance of the cladding. For example, CSA S304, "Design of Masonry Structures," specifies the maximum deflection criteria for backing assemblies to masonry veneer. Clauses 5.1.4.1.(6)(b) and (c) are written in very general terms in recognition of the fact that not only can the deflection of cladding affect the performance of the backing assembly, but that the excessive deflection of any element has the potential to adversely affect the performance of any adjacent element. Similarly, inter-storey drift has the potential to adversely affect the performance of components and assemblies of environmental separators. CSA O86, "Engineering Design in Wood," specifies a method for calculating building movement due to changes in moisture content. The effects of movement should be avoided or accommodated.

**A-5.1.4.2. Deterioration.** Environmental loads that must be considered include but are not limited to: sound, light and other types of radiation, temperature, moisture, air pressure, acids and alkalis.

Mechanisms of deterioration include:

- structural (impact, air pressure)
- hygrothermal (freeze-thaw, differential movement due to thermal expansion and contraction, ice lensing)
- electrochemical (oxidation, electrolytic action, galvanic action, solar deterioration)
- biochemical (biological attack, intrusion by insects and rodents).

Information on the effects of deformations in building elements can be found in the Commentary entitled *Effects of Deformations in Building Components* in the "User's Guide – NBC 2015, Structural Commentaries (Part 4 of Division B)."

Resistance to deterioration may be determined based on field performance, accelerated testing or compliance with guidelines provided by evaluation agencies recognized by the authority having jurisdiction. Guidance can be found in CSA S478, "Guideline on Durability in Buildings."

Building components should be designed with some understanding of the length of time over which they will effectively perform their intended function. Actual service life will depend on the materials used and the environment to which they are exposed. The design should take into consideration these factors, the particular

function of the component and the implications of premature failure, the ease of access for maintenance, repair or replacement, and the cost of repair or replacement.

Many buildings are designed such that access for maintenance, repair or replacement is not possible without damaging—or seriously risking damaging—other building elements. This can become a considerable deterrent to proper maintenance thus compromising the performance of the subject materials, components and assemblies, or other elements of the building. In cases where it is known or expected that maintenance, repair or replacement is likely to be required for certain elements before such time as the building undergoes a major retrofit, special consideration should be given to providing easy access to those elements. Anchorage points for maintenance personnel should be considered during the design of multi-storey buildings, including those of wood-frame construction, as adding them post-construction can be difficult.

Where the use of a building or space, or the services for a building or space, are changed significantly, an assessment of the impact of the changes on the environmental separators should be conducted to preclude premature failures that could create hazardous conditions.

**A-5.2.1.1.(3) Soil Temperatures.** In theory, soil temperatures are needed to determine the conformance of a design to the requirements related to heat transfer and vapour diffusion. In practice, standard construction in a particular area may have proven to perform quite adequately and detailed calculations of soil temperature are unnecessary. (See also Sentence 5.2.1.3.(2).)

**A-5.2.1.2.(1) Interior Environmental Loads.** The interior environmental conditions required depend on the intended use of the spaces in the building as defined in the building program. Spaces in different types of buildings and different spaces within a single building may impose different loads on the separators between interior and exterior spaces and between adjacent interior spaces. The separators must be designed to withstand the expected loads.

**A-5.2.2.1.(2)(c) Determination of Structural Loads and Effects.** As regards materials, components and assemblies and their interfaces that are installed in buildings to which Part 5 applies, the effects of earthquake loads on their ability to resist or accommodate environmental loads are generally only taken into account in the design of post-disaster buildings. For all other buildings, damage to building components during seismic events is anticipated and these buildings are not intended to be functional after the event. However, for post-disaster buildings, seismic effects must be taken into account in the design for environmental separation, as these buildings are required to have an adequate degree of functionality after the design event to meet their intended function (see Article 4.1.8.13. for deflections and drift limits for post-disaster buildings).

However, it is important to note that earthquake effects must be taken into account in the seismic design of all building materials, components and assemblies and their interfaces covered by Article 4.1.8.18. to address life safety and the structural protection of buildings.

**A-5.2.2.2. Resistance to Wind and Other Air Pressure Loads.** The wind load provisions apply to roofing and other materials subject to wind-uplift loads.

Note that, although Article 5.2.2.2. is specifically concerned with wind loads and directly references only one Article from Part 4, Sentence 5.2.2.1.(1) references all of Part 4 and would invoke Article 4.1.7.10. for example, which is concerned with air pressure loads on interior walls and partitions.

**A-5.2.2.2.(4) Membrane Roofing Systems.** Wind loads for membrane roofing systems must be calculated in accordance with Part 4. The tested uplift resistance and factored load should satisfy the requirements of the Commentary entitled Limit States Design in the “User’s Guide – NBC 2015, Structural Commentaries (Part 4 of Division B).”

The test method described in CAN/CSA-A123.21, “Dynamic Wind Uplift Resistance of Membrane-Roofing Systems,” applies only to membrane roofing systems whose components’ resistance to wind uplift is achieved by fasteners or adhesives. It does not apply to roofing systems that use ballasts, such as gravel or pavers, to secure the membrane against wind uplift.

In the case of membrane roofing systems in which the waterproof membrane is attached to the structural deck using mechanical fasteners, the wind-induced forces and the roofing system’s response are time- and space-dependent and, thus, dynamic in nature. Further information on the design and evaluation of such systems can be found in “A Guide for the Wind Design of Mechanically Attached Flexible Membrane Roofs,” published by NRC.

The wind uplift resistance obtained from the test method in CAN/CSA-A123.21 is limited to configurations with specific fastener or adhesive patterns. To extrapolate the test data to non-tested configurations, refer to ANSI/SPRI WD-1, "Wind Design Standard Practice for Roofing Assemblies," for a rational calculation procedure. However, in using this extrapolation procedure, wind loads should be calculated in accordance with the NBC. NRC's guide for wind design referenced above provides further guidance and examples of wind load calculations.

**A-5.3. Heat Transfer.** In addressing issues related to health and safety, Section 5.3. calls up levels of thermal resistance needed to minimize condensation on or within environmental separators, and to ensure thermal conditions appropriate for the building use. Energy regulations, where they exist, specify levels of thermal resistance required for energy efficiency or call up energy performance levels, which relate to levels of thermal resistance. Where Part 5 calls for levels of thermal resistance higher than those required by the energy regulations, the requirements of Part 5 take precedence.

**A-5.3.1.1. Required Resistance to Heat Transfer.** The control of heat flow is required wherever there is an intended temperature difference across the building assembly. The use of the term "intended" is important since, whenever interior space is separated from exterior space, temperature differences will occur.

The interior of an unheated warehouse, for example, will often be at a different temperature from the exterior due to solar radiation, radiation from the building to the night sky and the time lag in temperature change due to the thermal mass of the building and its contents. If this temperature difference is not "intended," no special consideration need be given to the control of heat flow.

If the warehouse is heated or cooled, thus making the temperature difference "intended," some consideration would have to be given to the control of heat flow.

It should be noted, however, that in many cases, such as with adjacent interior spaces, there will be an intended temperature difference but the difference will not be great. In these cases, the provisions to control heat flow may be little or no more than would be provided by any standard interior separator. That is, materials typically used in the construction of partitions may provide the separation needed to meet the requirements of Section 5.3. without adding what are generally considered to be "insulating" materials.

**A-5.3.1.2. Material and Component Properties and Condensation.** Total prevention of condensation is generally unnecessary and its achievement is rarely a certainty at design conditions. Part 5, therefore, requires that condensation be minimized. The occurrence of condensation should be sufficiently rare, or the quantities accumulated should be sufficiently small and dry rapidly enough, to avoid material deterioration and the growth of mould and fungi.

The Harmonized North American Fenestration Standard, AAMA/WDMA/CSA 101/I.S.2/A440, "NAFS – North American Fenestration Standard/Specification for Windows, Doors, and Skylights," identifies procedures to determine the condensation resistance and thermal transmittance of windows, doors and skylights though testing for condensation resistance is presented as optional in the standard. As such, a fenestration product that meets the standard's requirements on air leakage, water penetration, uniform load and other performance requirements may not meet the condensation resistance performance level needed for a given application. Only the physical test procedure presented in CSA A440.2, "Fenestration Energy Performance," can be used to establish the temperature index (I) value, which denotes condensation resistance performance evaluation criteria. It is recommended that designers specify I values for a given application to minimize the potential for condensation. Further guidance on the selection of the correct I value is provided in CSA A440.3, "User Guide to CSA A440.2-14, Fenestration Energy Performance."

The scope of AAMA/WDMA/CSA 101/I.S.2/A440, which is referenced in Subsection 5.9.2., includes skylights and tubular daylighting devices (TDD). Where skylights and TDDs pass through unconditioned space, their wells and shafts may become the environmental separator and would therefore have to comply with the requirements of Part 5.

**A-5.3.1.2.(1) Use of Thermal Insulation or Mechanical Systems for Environmental Control.** The level of thermal resistance required to avoid condensation on the warm side of an assembly or within an assembly (at the vapour barrier), and to permit the maintenance of indoor conditions appropriate for the occupancy depends on

- the occupancy
- the exterior design air temperature
- the interior design air temperature and relative humidity
- the capacity of the heating system, and

- the means of delivering heat.

To control condensation on the interior surface of an exterior wall, for example, the interior surface must not fall below the dew point of the interior air. If, for instance, the interior air is 20°C and 35% RH, the dew point will be 4°C. If the interior air is 20°C and 55% RH, the dew point will be 11°C.

Where the exterior design temperature is mild, such as in south coastal British Columbia, the interior RH during the heating season may well be around 55%. With an exterior temperature of -7°C, the materials in the environmental separator would have to provide a mere RSI 0.082 to avoid condensation on the interior surface. Depending on the specific properties of the material, this RSI might be provided by 10-mm plywood. Therefore, materials generally recognized as thermal insulation would not be required only to limit condensation on the warmer side of the building envelope.

For most of the country, however, exterior design temperatures are much lower; for example, -20°C in Toronto and Charlottetown, and -50°C in Dawson. In these cases, maintaining temperatures inboard of the vapour barrier above the dew point will require insulation or increased heat delivery to the environmental separator. Direct delivery of heat over the entire surface of the environmental separator is generally impractical. Indirect heat delivery may not be possible without raising the interior air temperatures above the comfort level. In any case, increased heat delivery would often entail excessive energy costs.

In addition to controlling condensation, interior surface temperatures must be warm enough to avoid occupant discomfort due to excessive heat loss by radiation. Depending on the occupancy of the subject spaces, this may require the installation of insulation even where it is not needed to control condensation.

**A-5.3.1.3.(2) Position of Materials Providing Thermal Resistance.** For a material providing thermal resistance to be effective, it must not be short-circuited by convective airflow through or around the material. The material must therefore be either

- the component of the air barrier system providing principal resistance to air leakage, or
- installed in full and continuous contact with a continuous low air permeance component.

**A-5.4.1.1. Resistance to Air Leakage.** An air barrier system in above-grade building components and assemblies separating conditioned space from the exterior will reduce the likelihood of condensation due to air leakage, discomfort from drafts, the infiltration of dust and other pollutants, and interference in the performance of building services, such as HVAC and plumbing. These problems can all lead to serious health or safety hazards.

Currently, the most obvious and significant problems are due to moisture-related material deterioration, such as rot and corrosion, which can lead to the failure of component connections. The infiltration of dust and other pollutants can lead to a wide range of health problems. Where the separator is subject to high moisture levels, the pollutants may include fungus spores. Interference with the performance of building services can lead to unhealthy conditions and potentially hazardous conditions during the heating season in many regions of the country.

There are few buildings intended for human occupancy where the interior space is conditioned but where an air barrier system is not required. Some industrial buildings, for example, may be exempt. This would depend, however, on the particular levels of interior conditioning provided, ventilation levels, protection provided for the workers, and the tolerance of the building's construction to the accumulation of condensation and potential precipitation ingress.

Some industrial buildings are provided with only limited conditioning, for example radiant heating, and ventilation levels are sufficient to reduce relative humidity to a level at which condensation will not accumulate to a degree that is problematic. Conversely, some industrial buildings, due to the processes they contain, operate at very high temperatures and high ventilation levels. In these cases, the building envelope will be maintained at temperatures that will avoid condensation. In both examples above, either the ventilation rates or protective gear required in the work environment would protect the occupants from unacceptable levels of pollutants.

Where adjacent interior environments are sufficiently different, controlling airflow between those spaces is necessary to maintain conditions. Referring again to the industrial building examples above, assemblies separating office space from the work floor would likely require an air barrier system.

The word "minimize" is used in Clause 5.4.1.1.(1)(c) because not all moisture accumulation in an assembly need be of concern. Incidental condensation is normal but should be sufficiently rare and in sufficiently limited quantities and should dry rapidly enough to avoid material deterioration and the growth of mould or fungi.

An air barrier system is required in components and assemblies in contact with the ground to control the ingress of radon, and may be required to control the ingress of other soil gases such as methane.

In addition to an air barrier system, other measures may be required to reduce the radon concentration to a level below the guideline specified by Health Canada. Further information on protection from radon ingress can be found in:

- “Radon: A Guide for Canadian Homeowners” (CMHC/HC),
- “Guide for Radon Measurements in Public Buildings (Schools, Hospitals, Care Facilities, Detention Centres)” (HC), and
- EPA 625/R-92/016, “Radon Prevention in the Design and Construction of Schools and Other Large Buildings.”

**A-5.4.1.2.(1) and (2) Air Leakage through the Air Barrier System.**

The current requirements specify only a maximum air leakage rate for the material in the air barrier system that provides the principal resistance to air leakage.

Research and in-situ testing of installed air barrier systems have shown that the bulk of air leakage occurs through joints (between air barrier materials) and junctions (between air barrier components).

Ideally, a maximum air leakage rate for the complete air barrier system would be specified. The maximum acceptable rate will ultimately depend on warm and cold side temperatures and humidity conditions, and on the susceptibility of the environmental separator to moisture-related deterioration. Recommended maximum leakage rates for the air barrier system in an exterior envelope in most locations in Canada are shown in Table A-5.4.1.2.(1) and (2). These values are for air barrier systems in opaque, insulated portions of the building envelope. They are not for whole buildings, as windows, doors and other openings are not included. The Table is provided for guidance when testing air barrier systems as portions of an envelope.

**Table A-5.4.1.2.(1) and (2)**  
**Recommended Maximum Air Leakage Rates**  
 Forming Part of Note A-5.4.1.2.(1) and (2)

Warm Side Relative Humidity at 21°C	Recommended Maximum System Air Leakage Rate, L/(s•m²) at 75 Pa
< 27%	0.15
27 to 55%	0.10
> 55%	0.05

Determining the leakage rate of a particular assembly, however, is problematic. There is little information available on the airtightness of the many air barrier systems used in building construction, and testing requires specialized equipment and expertise. Depending on the type of test,

- testing may not represent the performance of the complete installed system,
- the location of deficiencies may be difficult to identify, and
- rectification of deficiencies may not be feasible.

Despite the difficulties, when using a system whose performance is not known, it is recommended that tests be conducted. Testing options include:

- laboratory tests of small sections of the air barrier system, including the joints and intersections of different assemblies
- laboratory tests of large wall sections
- in-situ tests of characteristic envelope areas.

**A-5.5.1.1. Required Resistance to Vapour Diffusion.** Resistance to vapour diffusion is required to reduce the likelihood of condensation within building assemblies, and the consequent potential for material deterioration and fungal growth. Deterioration such as rot and corrosion can lead to the failure of building components and connections, and interfere with the performance of building services. Some fungi can have very serious effects on health.

In Canada, relatively few buildings that are subject to temperature and vapour pressure differences would be constructed or operated in such a manner that the control of vapour diffusion would not need to be addressed in their design. Assemblies enclosing certain industrial spaces, as described in Note A-5.4.1.1. for example, may be exempt.

For residential spaces, and most other spaces that are conditioned for human occupancy, a means of vapour diffusion control is generally agreed to be necessary, even in the milder climates of the country. The questions in those cases pertain to the degree of control needed.

The word “minimize” is used in Sentence 5.5.1.1.(1) because not all moisture accumulation in an assembly need be of concern. Incidental condensation is normal but should be sufficiently rare and in sufficiently limited quantities, and should dry rapidly enough, to avoid material deterioration and the growth of mould or fungi. Here are some references regarding the effects of fungi on health:

- “Fungal Contamination in Public Buildings: Health Effects and Investigation Methods,” Health Canada
- “Guidelines on Assessment and Remediation of Fungi in Indoor Environments,” New York City Department of Health and Mental Hygiene (NYCDH)

**A-5.5.1.2.(1) Vapour Barrier Materials and Installation.** In the summer, many buildings are subject to conditions where the interior temperature is lower than the exterior temperature. Vapour transfer during these periods is from the exterior to the interior. In general, in Canada, the duration of these periods is sufficiently short, the driving forces are sufficiently low, and assemblies are constructed such that any accumulated moisture will dissipate before deterioration will occur.

Buildings such as freezer plants, however, may operate for much of the year at temperatures that are below the ambient exterior temperature. In these cases, the “warm” side of the assembly would be the exterior and a detailed analysis on an annual basis is required.

Steady state heat transfer and vapour diffusion calculations may be used to determine acceptable permeance levels for the vapour barrier and to identify appropriate positions for the vapour barrier within the building assembly.

**A-5.6.1.1. Required Protection from Precipitation.** Windows, cast-in-place concrete walls, and metal and glass curtain wall systems are examples of components and assemblies that, when properly designed and constructed, are expected to prevent the ingress of precipitation into a building. Assemblies such as roofs and veneer walls consist of materials specifically intended to screen precipitation.

Components and assemblies separating interior conditioned space from the exterior are generally required to provide protection from the ingress of precipitation. Components and assemblies separating interior unconditioned space from the exterior may or may not be required to provide protection from the ingress of precipitation. Buildings such as stadia, parking garages and some seasonally occupied buildings, for example, may not require complete protection from the ingress of precipitation. The degree of protection will depend to a large extent on the materials selected for the building elements that will be exposed to precipitation.

The word “minimize” is used in Sentence 5.6.1.1.(1) because not all moisture ingress or accumulation in an assembly need be of concern. The penetration of wind-driven rain past the cladding may not affect the long-term performance of the assembly, provided the moisture dries out or is drained away before it initiates any deterioration of building materials. When the design service life of a material or component is longer than the design service life of the overall assembly, taking into account the expected exposure to moisture, initiating deterioration of the material should not be of concern. That is to say, provided the material or component continues to provide the necessary level of performance for its intended service life and does not adversely affect the service life of the assembly of which it is a part, the deterioration of the material or component is not an issue.

**A-5.6.1.2.(1) Ice Damming.** Water leakage through sloped roofs is often due to the formation of ice dams at the eaves, which can be limited by controlling the transfer of heat to the roof through a combination of insulation and venting to dissipate heat. See Clause 5.3.1.2.(1)(d).

**A-5.6.1.2.(2) Vegetated Roofing Systems.** The integrity of some assemblies installed to provide the required protection from the ingress of precipitation in vegetated roofing systems can be compromised due to an inadequate resistance to the penetration of plant roots and rhizomes. Additional information on vegetated roofing systems and the performance of protective materials can be found in the German Landscape Research, Development and Construction Society’s (FLL) “Guidelines for the Planning, Construction and Maintenance of Green Roofing” and in the National Roofing Contractors Association’s “Vegetative Roof Systems Manual.”

**A-5.6.2.1. Sealing and Drainage.** Providing a surface-sealed, durable, watertight cover on the outside of a building is difficult. Where there is a likelihood of some penetration by precipitation into a component or assembly, drainage is generally required to direct the moisture to the exterior.

The degree of protection against precipitation ingress needed in any particular case and the approach taken to provide that protection will depend on

- the exterior loads imposed on the assembly
- the materials selected for the backing assembly,
- the use of the enclosed space, and
- the level of maintenance that will be acceptable to the owners.

Where exterior loads are greater, it may be prudent to select a precipitation protection system whose small failures will not be as likely to have an immediate impact on the building or its occupants. For example, drained and vented wall and vented roof assemblies are typical for low-rise residential buildings. More robust drained and vented wall assemblies are recommended for mid- and high-rise buildings where the cost of maintenance and repair could be high.

Where materials with a greater resistance to moisture are used in the assembly, a less rugged precipitation protection system or a less rigorous maintenance schedule may be acceptable. This might be the case, for example, where the wall or backing wall is concrete or masonry.

For spaces that are not intended for ongoing human occupancy, some rainwater leakage may not be of particular concern. This may be the case for certain warehouse spaces for example, depending on how the spaces are used and conditioned.

Information on the installation of flashing to drain water to the exterior of roof and wall assemblies may be found in a number of publications including, but not limited to:

- “Architectural Sheet Metal Manual,” Sheet Metal and Air-Conditioning Contractors National Association, Inc.
- “High-Rise Residential Construction Guide,” Tarion Warranty Corporation (formerly Ontario New Home Warranty Program)
- Technical Notes, National Concrete Masonry Association
- Roofing Specifications, Canadian Roofing Contractors’ Association
- “The NRCA Roofing Manual: Membrane Roof Systems” and “The NRCA Waterproofing Manual,” National Roofing Contractors Association
- Technical Notes on Brick Construction, Brick Industry Association

Environmental separators installed in buildings of wood construction that exceed 4 storeys can be subjected to increased loading due to the height of the building. As such, certain design considerations may require different approaches from the common ones used by industry for buildings of 4 storeys or less. These considerations include, but are not limited to, the following:

- air barrier assemblies,
- fenestration selection,
- protection from precipitation,
- differential movement due to wood shrinkage,
- roofing selection and design, and
- risk of deterioration due to longer exposure of materials to the elements during construction.

Information on environmental separators and the loading to which they are subjected when installed in buildings of wood construction, as well as recommendations on dealing with differential movement, can be found in the following publications, among others:

- “Moisture and Wood-Frame Buildings,” Canadian Wood Council
- “Guide for Designing Energy-Efficient Building Enclosures for Wood-Frame Multi-Unit Residential Buildings in Marine to Cold Climate Zones in North America,” FPIInnovations and RDH Building Engineering Ltd.

**A-5.7. Protection from Interior Sources of Water.** Protection similar to that prescribed in Section 5.7. may be required where interior assemblies are in contact with water (such as site-built showers, steam rooms, swimming pool areas) and where adjacent interior spaces need to be protected from the transfer of water through these assemblies.

**A-5.7.1.2.(2) Drainage.** Water should be directed away from the building and, ultimately, to a municipal drainage system, drainage ditch, swale, or other acceptable water management means. This can be accomplished by setting the building grade higher than the surrounding grades, by sloping the grade away from the building, by installing a surface water drainage system, or by a combination of these approaches. The chosen approach should follow generally accepted guidelines, such as the Rational Method of Stormwater Design by David B. Thompson, or other design methods acceptable to the authority having jurisdiction.

**A-5.7.3.3.(1)(a) Imperfections.** Examples of imperfections include shrinkage cracks, air holes, honeycombing, form-tie cone holes, and form joint ridges.

**A-5.7.3.4.(1) Dampproofing.** Dampproofing refers to the application of a material or materials to an environmental separation assembly to protect it and the interior space against the transfer of moisture due to the mechanisms of water vapour transmission, capillary action and pressure differences other than hydrostatic pressure.

A dampproofed assembly should be designed such that it can provide short-term resistance to the ingress of water due to occasional hydrostatic pressure from ground water.

**A-5.8. Required Protection from Noise.** Section 5.8. applies to the separation of dwelling units from other dwelling units and from spaces where noise may be generated with regard to sound transmission irrespective of Clause 5.1.2.1.(1)(b), which deals with the separation of dissimilar environments. It is understood that, at any time, there is the potential for sound levels to be quite different in adjoining dwelling units.

**A-5.8.1.2. Using ASTC in lieu of STC.** A designer may choose to use an ASTC rating of equal or higher numerical value than the required STC to show compliance where STC ratings are required.

An ASTC measurement or calculation will always yield a value equal to or lower than the STC for the same configuration, as the ASTC includes flanking transmission.

**A-5.8.1.4. Methods of Calculating ASTC.** The technical concepts, terminology, and calculation procedures relating to the detailed and simplified ASTC calculation methods are discussed in detail, with numerous worked examples, in the NRC publication entitled "Guide to Calculating Airborne Sound Transmission in Buildings." This Guide includes references to readily-available sources of pertinent data.

For many common constructions, the calculations required by Article 5.8.1.4. can be performed using software tools, such as soundPATHS, which is available on NRC's Web site.

The simplified calculation method may not always identify the prominent flanking paths. Furthermore, it corresponds more closely with the results of the detailed calculation method where the separating assembly and the flanking constructions are both constructed according to the same method, i.e. either both are lightweight construction (steel or wood framing) or both are heavyweight construction (masonry or concrete).

**A-5.9.1.1.(1) Selection of Materials and Components and Compliance with Referenced Standards.** It is important to note that Sentence 5.9.1.1.(1) is stated in such a way that the selection of materials and components is not limited to those traditionally recognized as serving particular functions or those for which a standard is identified in Table 5.9.1.1. This approach permits more flexibility than is provided by similar requirements in Part 9. As long as the selected material meets the performance requirements stated elsewhere in Part 5, the material may be used to serve the required function.

However, where the selected material or component, or its installation, falls within the scope of any of the standards listed in Table 5.9.1.1., the material, component or installation must comply with that standard. For example, if some resistance to heat transfer is required between two interior spaces and standard partition construction will provide the necessary resistance, the installation of one of the "thermal insulation" materials identified in the standard list is not required. If, on the other hand, one decides to install glass fibre insulation, the material must conform to CAN/ULC-S702, "Mineral Fibre Thermal Insulation for Buildings."

**A-Table 5.9.1.1. Selection and Installation of Sealants.** Analysis of many sealant joint failures indicates that the majority of failures can be attributed to improper joint preparation and deficient installation of the sealant and various joint components. The following ASTM guidelines describe several aspects that should be considered when applying sealants in unprotected environments to achieve a durable application:

- ASTM C 1193, "Use of Joint Sealants,"
- ASTM C 1299, "Selection of Liquid-Applied Sealants," and
- ASTM C 1472, "Calculating Movement and Other Effects When Establishing Sealant Joint Width."

The sealant manufacturer's literature should always be consulted for recommended procedures and materials.



**A-5.9.2.1.(3) Airtightness and Watertightness of Wired Glass Windows.** Fixed wired glass assemblies are sometimes permitted as closures in vertical fire separations. The airtightness and watertightness requirements are waived for these windows when used in such an application, in recognition of the fact that the availability of assemblies that meet both the requirements of the window standards and the requirements for fire resistance may be limited. However, control of air and water leakage should not be ignored: measures should be taken to attempt to comply with applicable requirements.

### **A-5.9.2.2. Manufactured Windows, Doors and Skylights.**

#### **Design Values**

CSA A440S1, "Canadian Supplement to AAMA/WDMA/CSA 101/I.S.2/A440, NAFS – North American Fenestration Standard/Specification for Windows, Doors, and Skylights," requires that the individual performance levels achieved by the product for structural resistance, water penetration resistance and air leakage resistance be reported on the product's performance label.

#### **Storm Doors and Windows**

Where storm doors and storm windows are not incorporated in a rated window or door assembly, they should be designed and constructed to comply with the applicable requirements of Part 5 regarding such properties as appropriate air leakage and structural loads.

#### **Forced Entry Test**

Even though the performance label on rated windows, doors and skylights does not explicitly indicate that the product has passed the forced entry resistance test, products are required to pass this test in order to be rated.

### **A-5.9.2.3.(1) Installation and Field Testing of Windows, Doors and Skylights.**

#### **Installation**

The installation details of windows, doors, skylights and their components must be appropriately designed and implemented for the building envelope assembly to perform acceptably overall. The proper design of the installation details provides the information necessary to integrate the structure and air, vapour and moisture barrier functions of windows, doors and skylights into the overall design of the building envelope assembly. Construction should be carried out in accordance with these details to achieve an appropriate level of long-term performance. Further guidance on installation detailing can be found in CAN/CSA-A440.4, "Window, Door, and Skylight Installation."

#### **Field Testing**

It is recommended that the performance of installed windows, doors and skylights be field tested early in the envelope construction phase so that any discontinuities can be readily identified and corrected before construction of the building envelope assembly is completed. Additional field testing during subsequent construction phases to monitor installation consistency is also recommended. Field test procedures should be carried out in accordance with test standards such as ASTM E 783, "Field Measurement of Air Leakage Through Installed Exterior Windows and Doors," and ASTM E 1105, "Field Determination of Water Penetration of Installed Exterior Windows, Skylights, Doors, and Curtain Walls, by Uniform or Cyclic Static Air Pressure Difference." Further guidance can be found in Annex D of CAN/CSA-A440.4, "Window, Door, and Skylight Installation," however, the performance requirements developed in AAMA/WDMA/CSA 101/I.S.2/A440, "NAFS – North American Fenestration Standard/Specification for Windows, Doors, and Skylights," should be used rather than the industry performance data values listed in CAN/CSA-A440.4.

**A-5.9.2.4.(3) Heat Transfer through Fire-Rated Glazed Assemblies.** Thermal bridging through fire-rated glazed assemblies should not be ignored; measures should be taken to minimize condensation consistent with the intent of Sentence 5.9.2.4.(2).

**A-5.9.3. Testing Standards for Other Fenestration Assemblies.** Subsection 5.9.3. references ASTM test methods. The following AAMA standards can also be used to evaluate the performance characteristics of other fenestration assemblies:

- AAMA 501, “Test for Exterior Walls,”
- AAMA 501.1, “Water Penetration of Windows, Curtain Walls and Doors Using Dynamic Pressure,”
- AAMA 501.2, “Quality Assurance and Diagnostic Water Leakage Field Check of Installed Storefronts, Curtain Walls, and Sloped Glazing Systems,”
- AAMA 501.4, “Recommended Static Test Method for Evaluating Curtain Wall and Storefront Systems Subjected to Seismic and Wind Induced Interstory Drifts,”
- AAMA 501.5, “Thermal Cycling of Exterior Walls,” and
- AAMA 501.6, “Recommended Dynamic Test Method For Determining The Seismic Drift Causing Glass Fallout From A Wall System.”

#### **A-5.9.3.1.(1) Terminology for Other Fenestration Assemblies.**

##### **Curtain Wall**

A curtain wall is considered to be a continuous wall cladding assembly (which may include fenestration and opaque portions) that is hung away from the edge of the primary floor structure. Curtain wall assemblies do not generally support vertical loads other than their own weight. Anchorage is typically provided by anchors that connect back to the floor structure. Curtain wall assemblies can be either “stick built,” meaning each main unit is assembled on-site, or a “unitized” system, meaning factory-assembled main units are installed and connected together on-site.

##### **Window Wall**

A window wall is considered to be a wall cladding assembly (which may include fenestration and opaque portions) that spans from the top of a primary floor structure to the underside of the next higher primary floor structure. Window wall assemblies do not generally support vertical loads other than their own weight. Primary provision for anchorage occurs at head and sill connections with the adjoining floor structure. Window wall assemblies may include separate or integral floor edge covers.

##### **Storefront**

A storefront is considered to be a non-residential assembly (which may include fenestration and opaque portions) consisting of one or more elements that could include doors, windows and curtain wall framing. Storefronts do not generally support vertical loads other than their own weight. Storefront profiles are typically narrow, rectilinear framing members that hold a combination of pocket glazing and applied glazing stops to securely retain the infills. Vertical framing members typically span the height of one floor or are retained within a structural punched opening.

Storefront assemblies are designed/selected to take into account the anticipated service and exposure conditions, which may be different than those for other portions of the building.

##### **Glazed Architectural Structures**

Glazed architectural structures are considered glazing assemblies that are supported in a non-traditional manner, such as corner-clamped, point-supported, linear-supported and edge-clamped glazing. Structural support systems can include, but are not limited to, tension cables, tension rods, steel and glass. Glazed architectural structures do not generally support vertical loads other than their own weight. These assemblies are designed/selected to take into account the anticipated service and exposure conditions, which may be different than those for other portions of the building.

Skylights that are not covered by AAMA/WDMA/CSA 101/I.S.2/A440, “NAFS – North American Fenestration Standard/Specification for Windows, Doors, and Skylights,” are considered glazed architectural structures.

**A-5.9.3.2.(1) Structural and Environmental Loads.** The applicable laboratory test method for demonstrating adequate structural performance of other fenestration assemblies is ASTM E 330/E 330M, “Structural Performance of Exterior Windows, Doors, Skylights and Curtain Walls by Uniform Static Air Pressure Difference.”

**A-5.9.3.3.(1) Resistance to Condensation.** Notwithstanding that other fenestration assemblies are not fully covered under the testing scope of CSA A440.2, “Fenestration Energy Performance,” the test method described therein can be used to evaluate their resistance to condensation, with technical modifications to accommodate differences in the size and configuration of the specimen. It is also common practice to use one cold cycle of AAMA 501.5, “Thermal Cycling of Exterior Walls,” to assess the potential for condensation. Both methods can be used for mock-ups in laboratory performance evaluations, however, only the test method in CSA A440.2 should be used if a Temperature Index is required. In most cases, the project specification documents establish the hygrothermal conditions (i.e., exterior temperature, interior temperature, interior relative humidity) for which the potential for condensation should be minimized. Under these conditions, the aforementioned test methods can be used to aid in the selection of the appropriate system performance to minimize the potential for interior surface condensation. In all cases, care should be taken in the construction and configuration of the specimen, as these parameters may have an impact on its thermal performance and resistance to condensation. These parameters may include, without limitation, interior wall construction and finishes, heating systems, ventilation systems, etc., to simulate the actual in-service conditions as closely as practicable.

#### **A-5.9.3.4.(2) Air Leakage.**

##### **Air Leakage Rate and Test Pressure**

A lower air leakage rate and/or higher differential test pressure can be selected for specific applications of other fenestration assemblies where tight control of airflow is required to prevent interstitial condensation (e.g., in concealed spaces), improve thermal comfort (e.g., in hospitals, seniors’ residences), or prevent the migration of airborne contaminants (e.g., in food and drug research, manufacturing applications, biological laboratories). It is typical of other fenestration assemblies to be used as the sole building envelope component; where this is the case, a correspondingly higher degree of airtightness may be required.

In addition, higher test pressure differentials can be used to evaluate assemblies with low air leakage, such as non-operable or fixed fenestration systems whose air leakage rates are not easily measurable at the lower standard pressure differentials.

##### **Standard Test Methods**

The applicable laboratory test method for determining the rate of air leakage is ASTM E 283, “Determining Rate of Air Leakage Through Exterior Windows, Curtain Walls, and Doors Under Specified Pressure Differences Across the Specimen.” If field testing for air leakage is to be conducted, the applicable test method is ASTM E 783, “Field Measurement of Air Leakage Through Installed Exterior Windows and Doors.”

**A-5.9.3.4.(3) Systems Excluded from Air Leakage Requirements.** The systems listed in Sentence 5.9.3.4.(3) perform different functions than other fenestration assemblies and are therefore exempted from complying with the air leakage requirements.

**A-5.9.3.5.(2) Standard Test Methods.** The applicable laboratory test method for determining the water penetration resistance of curtain walls and storefront assemblies is ASTM E 331, “Water Penetration of Exterior Windows, Skylights, Doors, and Curtain Walls by Uniform Static Air Pressure Difference.” The applicable laboratory test method for window wall assemblies is either ASTM E 331 or ASTM E 547, “Water Penetration of Exterior Windows, Skylights, Doors, and Curtain Walls by Cyclic Static Air Pressure Difference.”

If field testing for water penetration is to be conducted, the applicable test method is ASTM E 1105, “Field Determination of Water Penetration of Installed Exterior Windows, Skylights, Doors, and Curtain Walls, by Uniform or Cyclic Static Air Pressure Difference.”

**A-5.9.3.5.(3) Water Penetration.** Notwithstanding that other fenestration assemblies are not covered under the testing scope of CSA A440S1, “Canadian Supplement to AAMA/WDMA/CSA 101/I.S.2/A440, NAFS – North American Fenestration Standard/Specification for Windows, Doors, and Skylights,” they must be tested at the driving rain wind pressure calculated in accordance with the procedure described therein.

**A-5.9.3.5.(4) Systems Excluded from Water Penetration Requirements.** The systems listed in Sentence 5.9.3.5.(4) perform different functions than other fenestration assemblies and are therefore exempted from complying with the water penetration requirements.

**A-5.9.4.1.(1) Exterior Insulation Finish Systems (EIFS).** The reference to CAN/ULC-S716.1, “Exterior Insulation and Finish Systems (EIFS) - Materials and Systems,” in Clause 5.9.4.1.(1)(b) does not preclude the use of other component materials that may also meet the intent of the Code. For example, using mineral-fibre insulation in lieu of other rigid insulation types, mechanical fastening methods for the insulation component in lieu of adhesive, or a type of water-resistive barrier other than a liquid-applied water-resistive barrier could be acceptable.

The following two companion standards facilitate the application of and conformance with CAN/ULC-S716.1:

- CAN/ULC-S716.2, “Exterior Insulation and Finish Systems (EIFS) - Installation of EIFS Components and Water Resistive Barrier,” and
- CAN/ULC-S716.3, “Exterior Insulation and Finish System (EIFS) - Design Application.”

Additional information on EIFS design and installation can be found in the EIFS Council of Canada’s “EIFS Practice Manual” and the manufacturer’s literature.

### **EIFS Selection**

CAN/ULC-S716.1 provides minimum performance criteria for EIFS materials and systems that are tested under specific laboratory test protocols identified in the standard. However, compliance with this standard does not ensure that a system is appropriate for all projects. When selecting an EIFS product, designers should consider all relevant criteria—not only those covered by the tests in CAN/ULC-S716.1—including, but not limited to,

- building exposure
- local climate characteristics (wind, precipitation, temperature variations, solar exposure)
- intended building use
- intended resistance to damage and deterioration
- construction tolerances
- constructability

### **Design and Construction of EIFS Drainage Cavity**

The drainage capacity and thermal performance of the EIFS assembly can be affected by the dimensions and configuration of the EIFS drainage cavity.

EIFS are installed over other building materials such as sheathing and primary structural components, which have various construction installation tolerances. Designers should take into consideration the cumulative effects of construction tolerances and sequencing when specifying the drainage method and the cavity dimensions and configuration in order to ensure adequate drainage.

Designers should also take into account the impact of air movement, which varies depending on cavity size and the extent of venting, on the EIFS’ thermal performance when reviewing the overall thermal performance of the building envelope. ASTM C 1363, “Thermal Performance of Building Materials and Envelope Assemblies by Means of a Hot Box Apparatus,” presents one method for assessing the thermal performance of assemblies.

# **Part 6**

## **Heating, Ventilating and Air-conditioning**

<b>6.1.</b>	<b>General</b>	
6.1.1.	Application .....	6-1
6.1.2.	Definitions .....	6-1
6.1.3.	Plans and Specifications .....	6-1
<b>6.2.</b>	<b>Planning</b>	
6.2.1.	General .....	6-1
6.2.2.	Incinerators .....	6-3
6.2.3.	Solid Fuel Storage .....	6-3
<b>6.3.</b>	<b>Ventilation Systems</b>	
6.3.1.	Ventilation .....	6-3
6.3.2.	Air Duct Systems .....	6-5
6.3.3.	Chimneys and Venting Equipment .....	6-9
6.3.4.	Ventilation for Laboratories .....	6-10
<b>6.4.</b>	<b>Heating Systems</b>	
6.4.1.	Heating Appliances, General .....	6-11
6.4.2.	Unit Heaters .....	6-11
6.4.3.	Radiators and Convectors .....	6-11
<b>6.5.</b>	<b>Thermal Insulation Systems</b>	
6.5.1.	Insulation .....	6-11
<b>6.6.</b>	<b>Refrigeration and Cooling Systems</b>	
6.6.1.	Refrigerating Systems and Equipment for Air-conditioning ....	6-12
<b>6.7.</b>	<b>Piping Systems</b>	
6.7.1.	Piping for Heating and Cooling Systems .....	6-12
6.7.2.	Storage Bins .....	6-13
<b>6.8.</b>	<b>Equipment Access</b>	
6.8.1.	Openings .....	6-13
<b>6.9.</b>	<b>Fire Safety Systems</b>	
6.9.1.	General .....	6-13
6.9.2.	Dampers and Ductwork .....	6-14
6.9.3.	Carbon Monoxide Alarms .....	6-14
6.9.4.	Ash Storage .....	6-15
<b>6.10.</b>	<b>Objectives and Functional Statements</b>	
6.10.1.	Objectives and Functional Statements .....	6-15
	<b>Notes to Part 6 .....</b>	<b>6-19</b>



# **Part 6**

## **Heating, Ventilating and Air-conditioning**

### **Section 6.1. General**

#### **6.1.1. Application**

##### **6.1.1.1. Scope**

- 1) The scope of this Part shall be as described in Subsection 1.3.3. of Division A.

##### **6.1.1.2. Application**

- 1) This Part applies to systems and equipment for heating, ventilating and air-conditioning services.

#### **6.1.2. Definitions**

##### **6.1.2.1. Defined Terms**

- 1) Words that appear in italics are defined in Article 1.4.1.2. of Division A.

#### **6.1.3. Plans and Specifications**

##### **6.1.3.1. Required Plans and Specifications**

- 1) Plans, specifications and other information for heating, ventilating and air-conditioning systems shall conform to Subsection 2.2.6. of Division C.

### **Section 6.2. Planning**

#### **6.2.1. General**

##### **6.2.1.1. Good Engineering Practice**

(See Note A-6.2.1.1.)

- 1) Heating, ventilating and air-conditioning systems, including mechanical refrigeration equipment, shall be designed, constructed and installed in conformance with good engineering practice such as that described in, but not limited to,
  - a) the ASHRAE Handbooks and Standards,
  - b) the HRAI Digest,
  - c) the Hydronics Institute Manuals,
  - d) the NFPA Standards,
  - e) the SMACNA Manuals,
  - f) the Industrial Ventilation Manual published by the ACGIH,
  - g) CSA B214, "Installation Code for Hydronic Heating Systems,"
  - h) CAN/CSA-Z317.2, "Special Requirements for Heating, Ventilation, and Air-Conditioning (HVAC) Systems in Health Care Facilities," and
  - i) EPA 625/R-92/016, "Radon Prevention in the Design and Construction of Schools and Other Large Buildings."

**6.2.1.2. Outdoor Design Conditions**

- 1) The outdoor conditions to be used in designing heating, ventilating and air-conditioning systems shall be determined in conformance with Subsection 1.1.3.
- 2) Except as provided in Sentence 6.3.2.14.(1), the outdoor air quality conditions of the geographic area of the *building* site to be used in designing ventilation systems shall conform to appropriate provincial or territorial requirements or, in the absence of such requirements, shall be equal to or less than the maximum acceptable levels stated in the Canada-wide Standards for Particulate Matter (PM) and Ozone as follows:
  - a) a 24 hour average of 30 µg/m<sup>3</sup> for particulate matter that is 2.5 µm or less in diameter (PM<sub>2.5</sub>), and
  - b) an 8 hour average of 65 ppb for ground-level ozone.
 (See Note A-6.2.1.2.(2).)
- 3) The outdoor air quality conditions of the local area of the *building* site to be used in designing ventilation systems shall conform to appropriate provincial or territorial requirements or, in the absence of such requirements, to the requirements of Sentence 6.3.2.14.(2). (See Note A-6.2.1.2.(3).)

**6.2.1.3. Expansion, Contraction and System Pressure**

- 1) Heating and cooling systems shall be designed to allow for expansion and contraction of the heat transfer fluid and to maintain the system pressure within the rated working pressure limits of all components of the system.

**6.2.1.4. Structural Movement**

(See Note A-6.2.1.4.)

- 1) Mechanical systems and equipment shall be designed and installed to accommodate the maximum relative structural movement provided for in the construction of the *building*.

**6.2.1.5. Installation Standards**

- 1) Except as provided in Articles 6.9.4.2. and 6.3.1.5., the installation of heating and air-conditioning equipment, including mechanical refrigeration equipment, and including provisions for mounting, clearances and air supply, shall conform to appropriate provincial or territorial requirements or, in the absence of such requirements, to the requirements of
  - a) CSA B51, "Boiler, Pressure Vessel, and Pressure Piping Code,"
  - b) CSA B52, "Mechanical Refrigeration Code,"
  - c) CSA B139, "Installation Code for Oil-Burning Equipment,"
  - d) CSA B149.1, "Natural Gas and Propane Installation Code,"
  - e) CSA B365, "Installation Code for Solid-Fuel-Burning Appliances and Equipment," or
  - f) CSA C22.1, "Canadian Electrical Code, Part I."

**6.2.1.6. Installation – General**

- 1) Equipment requiring periodic maintenance and forming part of a heating, ventilating or air-conditioning system shall be installed with provision for access for inspection, maintenance, repair and cleaning. (See Note A-6.2.1.6.(1).)
- 2) Mechanical equipment shall be provided with guards so as to prevent injury.
- 3) Heating, ventilating or air-conditioning systems shall be protected from freezing if they may be adversely affected by freezing temperatures.

**6.2.1.7. Asbestos**

- 1) Asbestos shall not be used in air distribution systems or equipment in a form or in a location where asbestos fibres could enter the air supply or return systems.



**6.2.2. Incinerators****6.2.2.1. Applicable Standard**

1) The design, construction, installation and *alteration* of every indoor incinerator shall conform to NFPA 82, "Incinerators and Waste and Linen Handling Systems and Equipment."

**6.2.3. Solid Fuel Storage****6.2.3.1. Solid Fuel Storage Bins**

1) A storage bin for solid fuel shall not be located above a sewer opening or drain opening.

2) Storage bins for solid fuel shall be designed and constructed so that the air temperature in the bin or the surface temperature of any part of the floor or walls is below 50°C.

**Section 6.3. Ventilation Systems****6.3.1. Ventilation****6.3.1.1. Required Ventilation**

1) Except as provided in Sentence (3), all *buildings* shall be ventilated in accordance with this Part.

2) Except in *storage garages* covered by Article 6.3.1.4., the rates at which outdoor air is supplied in *buildings* by ventilation systems shall be not less than the rates required by ANSI/ASHRAE 62, "Ventilation for Acceptable Indoor Air Quality" (except Addendum n).

3) Self-contained heating-season mechanical ventilation systems serving only one *dwelling unit* shall comply with

- this Part, or
- Subsection 9.32.3.

**6.3.1.2. Crawl Spaces and Attic or Roof Spaces**

1) Unconditioned and unoccupied crawl spaces and unconditioned and unoccupied *attic or roof spaces* shall be ventilated by natural or mechanical means as required by Part 5. (See Note A-6.3.1.2.(1).)

**6.3.1.3. Natural Ventilation**

1) Except as permitted by Sentence (2), the ventilation required by Article 6.3.1.1. shall be provided by mechanical ventilation, except that it can be provided by natural ventilation or a combination of natural and mechanical ventilation in

- buildings* of other than *residential occupancy* having an *occupant load* of not more than one person per 40 m<sup>2</sup> during normal use,
- buildings* of *industrial occupancy* where the nature of the processes contained therein permits or requires the use of large openings in the *building* envelope even during the winter, and
- seasonal *buildings* not intended to be occupied during the winter.

2) Where climatic conditions permit, *buildings* containing *occupancies* other than *residential occupancies* may be ventilated by natural ventilation methods in lieu of mechanical ventilation where engineering data demonstrates that such a method will provide the required ventilation for the type of *occupancy*.

**6.3.1.4. Ventilation of Storage Garages**

- 1)** Except as provided in Sentences (4) and (6), an enclosed *storage garage* for five or more motor vehicles shall have a mechanical ventilation system designed to
- limit the concentration of carbon monoxide to not more than 100 parts per million parts of air,
  - limit the concentration of nitrogen dioxide to not more than 3 parts per million parts of air, where the majority of the vehicles stored are powered by diesel-fuelled engines, or
  - provide, during operating hours, a continuous supply of outdoor air at a rate of not less than 3.9 L/s for each square metre of *floor area* (see Article 3.3.1.20.).

(See also Sentence 3.3.5.4.(4).) (See Note A-6.3.1.4.(1).)

**2)** Mechanical ventilation systems provided in accordance with Clause (1)(a) shall be controlled by carbon monoxide monitoring devices, and systems provided in accordance with Clause (1)(b) shall be controlled by nitrogen dioxide or other acceptable monitoring devices. (See Note A-6.3.1.4.(2).)

**3)** Mechanical ventilation systems provided in accordance with Sentence (1) shall be designed such that the pressure in the *storage garage* is less than the pressure in adjoining *buildings* of other *occupancy*, or in adjacent portions of the same *building* having a different *occupancy*.

**4)** In *storage garages* subject to the requirements of Sentences (1) and (2), where motor vehicles are parked by mechanical means, the ventilation requirements may be reduced by one half.

**5)** Except as provided in Sentence (6), ticket and attendant booths of *storage garages* shall be pressurized with a supply of uncontaminated air.

**6)** The requirements of Sentences (1) to (5) shall not apply to *open-air storeys* in a *storage garage*.

**6.3.1.5. Heat Recovery Ventilators**

**1)** Heat recovery ventilators with rated capacities of not less than 25 L/s and not more than 200 L/s shall be installed in accordance with Subsection 9.32.3.

**6.3.1.6. Indoor Air Contaminants**

(See Note A-6.3.1.6.)

- 1)** Air contaminants of concern that are released within *buildings* shall
- be removed insofar as is possible at their points of origin, and
  - not be permitted to accumulate in concentrations greater than those permitted by applicable provincial or territorial requirements or, in the absence of such requirements, by good engineering practice such as that described in the publications listed in Sentence 6.2.1.1.(1), measured using the methodology described therein.

**2)** Systems serving spaces that contain sources of contamination and systems serving other occupied parts of the *building* but located in or running through spaces that contain sources of contamination shall be designed in such a manner as to prevent the spread of such contamination to other occupied parts of the *building*.

**3)** Heating, ventilating and air-conditioning systems shall be designed to minimize the growth and spread of bio-contaminants.

**6.3.1.7. Commercial Cooking Equipment**

**1)** Except as provided in Article 3.6.3.5., systems for the ventilation of commercial cooking equipment shall be designed, constructed and installed to conform to NFPA 96, "Ventilation Control and Fire Protection of Commercial Cooking Operations."

**6.3.2. Air Duct Systems****6.3.2.1. Application**

1) This Subsection applies to the design, construction and installation of air duct distribution systems serving heating, ventilating and air-conditioning systems other than those in *dwelling units* covered by Part 9.

**6.3.2.2. Drain Pans**

- 1) Dehumidifying cooling coil assemblies and condensate-producing heat exchangers shall be equipped with drain pans beneath them that are
- designed in accordance with Section 5.11, Drain Pans, of ANSI/ASHRAE 62.1, "Ventilation for Acceptable Indoor Air Quality,"
  - provided with an outlet that is piped to the outside of the airstream in a location where condensate can be eliminated, and
  - installed so that water drains freely from the pan.

**6.3.2.3. Materials in Air Duct Systems**

- 1) All ducts, duct connectors, associated fittings and *plenums* used in air duct systems shall be constructed of materials as described in Article 3.6.5.1.
- 2) Ducts that are used in a location where they may be subjected to excessive moisture shall have no appreciable loss of strength when wet and shall be resistant to moisture-induced corrosion.
- 3) All ductwork and fittings shall be constructed and installed as recommended in SMACNA Manuals and ASHRAE Standards.
- 4) All duct materials shall be suitable for exposure to the temperature and humidity of the air being carried and shall be resistant to corrosion caused by contaminants in the air being conveyed in the duct.

**6.3.2.4. Connections in Air Duct Systems**

- 1) Air duct systems shall have tight-fitting connections throughout.

**6.3.2.5. Duct Coverings and Linings**

(See Note A-6.3.2.5.)

- 1) Coverings, linings and associated adhesives and insulation used in air ducts, *plenums* and other parts of air duct systems shall comply with Article 3.6.5.4.
- 2) Duct linings shall be installed so that they will not interfere with the operation of volume or balancing dampers or of *fire dampers*, *fire stop flaps* and other *closures*.

**6.3.2.6. Clearance of Ducts and Plenums**

- 1) The clearance of ducts and *plenums* from *combustible* materials shall comply with Article 3.6.5.6.

**6.3.2.7. Interconnection of Systems**

- 1) In a *care* or *residential occupancy*, air from one *suite* shall not be circulated to any other *suite* or to a *public corridor*.
- 2) Except as permitted by Sentences (3) and 6.3.2.10.(6), air duct systems serving *storage garages* shall not be directly interconnected with other parts of the *building*.
- 3) *Exhaust ducts* referred to in Sentence 6.3.2.10.(10) are permitted to exhaust through an enclosed *storage garage* prior to exhausting to the outdoors, provided
- the *storage garage's* exhaust system runs continuously,
  - the capacity of the *storage garage's* exhaust system is equal to or exceeds the volume of the exhaust entering the garage, and
  - a leakage rate 1 smoke/*fire damper* rated in accordance with CAN/ULC-S112.1, "Leakage Rated Dampers for Use in Smoke Control Systems," is provided near the duct outlet location in the *storage garage*

to prevent air from the *storage garage* from entering the exhaust ductwork system in the event the *building's* exhaust fan is shut down.

### 6.3.2.8. Makeup Air

(See Note A-6.2.1.1.)

**1)** In ventilating systems that exhaust air to the outdoors, provision shall be made for the admission of a supply of makeup air in sufficient quantity so that the operation of the exhaust system and other exhaust equipment or combustion equipment is not adversely affected.

**2)** Makeup air facilities required by Sentence (1) shall be interlocked with the exhaust devices they serve so that both operate together.

**3)** Where makeup air facilities are intended to introduce air directly from the outdoors to occupied parts of the *building* in winter, they shall incorporate means of tempering that air to maintain the indoor design temperature.

### 6.3.2.9. Supply, Return, Intake and Exhaust Air Openings

**1)** Supply, return and exhaust air openings located less than 2 m above the floor in rooms or spaces in *buildings* shall be protected by grilles having openings of a size that will not allow the passage of a 15 mm diam sphere.

**2)** Outdoor air intakes shall be located so that

- a) the quality of the air entering the *building* complies with Sentences 6.2.1.2.(2) and (3), and
- b) they are separated a minimum distance from sources of contaminants in accordance with Table 6.3.2.9.

**Table 6.3.2.9.**  
**Minimum Distances of Air Intakes from Sources of Contaminants**  
Forming Part of Sentence 6.3.2.9.(2)

Source of Contaminants	Minimum Distance of Outdoor Air Intake, m
Garage entry of a garage for 5 or more motor vehicles, automobile loading area and drive-in queue	4.5
Truck loading area or dock, and bus parking	7.6
Driveway, <i>street</i> , and parking space	1.5
Thoroughfare, arterial road, freeway, and highway	7.6
Garbage storage/pick-up area and dumpsters	4.5
Discharge from evaporative cooling tower, evaporative fluid cooler and evaporative condenser	7.6
Sanitary vent	3.5
Kitchen cooking exhaust	3.0
Vent for combustion products	3.0

**3)** Outdoor air intakes shall be installed not less than 0.3 m above roofs, landscape grades or other surfaces, taking into account anticipated snow accumulation levels.

**4)** Exterior openings for outdoor air intakes and exhaust outlets shall be shielded from the entry of snow and rain and shall be fitted with corrosion-resistant screens of mesh having openings not larger than 15 mm, except where experience has shown that climatic conditions require larger openings to prevent the screen openings from icing over.

**5)** Screens required in Sentence (4) shall be accessible for maintenance.

**6)** *Combustible* grilles, diffusers and other devices covering supply, return, intake and exhaust openings shall comply with Article 3.6.5.7.

**6.3.2.10. Exhaust Ducts and Outlets**

**1)** Except as provided in Sentence (2), *exhaust ducts* of non-mechanical ventilating systems serving separate rooms or spaces shall not be combined.

**2)** *Exhaust ducts* of non-mechanical ventilating systems serving similar *occupancies* may be combined immediately below the point of final delivery to the outdoors, such as at the base of a roof ventilator.

**3)** *Exhaust ducts* of ventilating systems shall have provision for the removal of condensation where this may be a problem.

**4)** Exhaust outlets shall be designed to prevent backdraft under wind conditions.

**5)** Except as permitted in Sentence (6), exhaust systems shall discharge directly to the outdoors. (See Note A-6.3.2.10.(5) and (6).)

**6)** Exhaust systems are permitted to exhaust into a *storage garage*, provided

- a) they serve rooms that are accessible only from that *storage garage*,
- b) the exhaust contains no contaminants that would adversely affect the air quality in the *storage garage* (see Note A-6.3.2.10.(6)(b)), and
- c) they are designed in accordance with Sentence 6.3.2.7.(3).

(See Note A-6.3.2.10.(5) and (6).)

**7)** *Exhaust ducts* connected to laundry-drying equipment shall be

- a) independent of other *exhaust ducts*,
- b) accessible for inspection and cleaning, and
- c) constructed of a smooth corrosion-resistant material.

(See Note A-6.3.2.10.(7) and (8).)

**8)** Where collective venting of multiple installations of laundry-drying equipment is used, the ventilation system shall

- a) be connected to a common *exhaust duct* that is vented by one central exhaust fan and incorporates one central lint trap,
- b) include an interlock to activate the central exhaust fan when laundry-drying equipment is in use, and
- c) be provided with make-up air.

(See Note A-6.3.2.10.(7) and (8).)

**9)** *Exhaust ducts* or vents connected to laundry-drying equipment shall discharge directly to the outdoors.

**10)** Except as provided in Sentence (12) and except for self-contained systems serving individual *dwelling units*, *exhaust ducts* serving rooms containing water closets, urinals, basins, showers or slop sinks shall be independent of other *exhaust ducts*.

**11)** Except as provided in Sentence (12) and except for self-contained systems serving individual *dwelling units*, *exhaust ducts* serving rooms containing residential cooking equipment shall be independent of other *exhaust ducts*.

**12)** Two or more exhaust systems described in Sentences (10) and (11) may be interconnected or connected with *exhaust ducts* serving other areas of the *building*, provided

- a) the connections are made at the inlet of an exhaust fan, and all interconnected systems are equipped with suitable back pressure devices to prevent the passage of odours from one system to another when the fan is not in operation, or
- b) the *exhaust ducts* discharge to a shaft that is served by an exhaust fan having a capacity that is equal to or greater than the combined capacity of the exhaust fans discharging to the *plenum* multiplied by the operation diversity factor, provided that the exhaust fan serving the shaft operates continuously (see Note A-6.3.2.10.(12)(b)).

**13)** Where *exhaust ducts* containing air from *conditioned spaces* pass through or are adjacent to unconditioned spaces, the ducts shall be constructed to prevent condensation from forming on the inside or outside of the ducts.

**6.3.2.11. Return-Air System**

- 1) Return-air systems shall comply with Article 3.6.5.8.
- 2) Where a ceiling space is used as a return-air *plenum*, the requirements of Article 3.6.4.3. shall apply.
- 3) A *public corridor* or *exit* shall not be used as a return-air *plenum*.

**6.3.2.12. Underground Ducts**

- 1) Underground ducts shall
  - a) be constructed and installed to provide interior drainage from and access to all low points,
  - b) not be connected directly to a sewer, and
  - c) be installed and constructed of materials recommended by ASHRAE and SMACNA Standards and HRAI Manuals.
- 2) A clean-out or pump-out connection shall be provided in an underground duct system at every low point of the duct system.

**6.3.2.13. Filters**

- 1) Air filters for air duct systems shall conform to the requirements for Class 2 air filter units as described in CAN/ULC-S111, "Fire Tests for Air Filter Units."
- 2) When electrostatic-type filters are used, they shall be installed so as to ensure that the electric circuit is automatically de-energized when filter access doors are opened or, in *dwelling units*, when the *furnace* circulation fan is not operating.

**6.3.2.14. Cleaning Devices**

- 1) Where outdoor air quality conditions do not meet the requirements of Sentence 6.2.1.2.(2), ventilation required by Sentence 6.3.1.1.(1) shall be provided by a ventilation system designed to include devices that reduce particles and gases to the maximum acceptable levels described in Sentence 6.2.1.2.(2) prior to the introduction of outdoor air to indoor occupied spaces.
- 2) Where contaminants of concern are present in the outdoor air of the local area of the *building* site, ventilation required by Sentence 6.3.1.1.(1) shall be provided by a ventilation system designed to include devices that reduce the concentrations of contaminants to those permitted in the ACGIH's "Industrial Ventilation: A Manual of Recommended Practice for Design" prior to the introduction of outdoor air to indoor occupied spaces.

**6.3.2.15. Evaporative Cooling Towers, Evaporative Fluid Coolers and Evaporative Condensers**

- 1) Discharge from evaporative cooling towers to ventilation air intakes shall comply with
  - a) Sentence 6.3.2.9.(2), and
  - b) CAN/CSA-Z317.2, "Special Requirements for Heating, Ventilation, and Air-Conditioning (HVAC) Systems in Health Care Facilities."
- 2) The distance between the air intakes of evaporative cooling towers, evaporative fluid coolers and evaporative condensers in relation to kitchen exhaust outlets, vegetation or other sources of organic matter shall be not less than 4.6 m.
- 3) Make-up water connections shall be equipped with backflow prevention devices that conform to Article 2.6.2.1. of Division B of the NPC.
- 4) Water treatment equipment for biological growth control shall be provided in accordance with Sub-Section 7.6.2. of ASHRAE Guideline 12, "Minimizing the Risk of Legionellosis Associated with Building Water Systems."
- 5) Drains, overflows and blow-downs shall be connected to the *building's* drainage system in accordance with Clause 2.4.2.1.(1)(e) of Division B of the NPC.

6) Evaporative cooling towers, evaporative fluid coolers and evaporative condensers shall be provided with access ports, service platforms, fixed ladders and restraint connections to allow visual inspection, maintenance and testing.

**6.3.2.16. Evaporative Air Coolers, Misters, Atomizers, Air Washers and Humidifiers**

1) The filter and water evaporation medium of every air washer and evaporative air cooler enclosed within a *building* shall be made of *noncombustible* material.

2) Sumps for air washers and evaporative air coolers shall be constructed and installed so that they can be flushed and drained.

3) Evaporative air coolers, misters, atomizers, air washers and humidifiers shall be designed in accordance with Sections 8 and 9 of ASHRAE Guideline 12, "Minimizing the Risk of Legionellosis Associated with Building Water Systems."

**6.3.2.17. Fans and Associated Air-Handling Equipment**

1) Fans for heating, ventilating and air-conditioning systems shall be located and installed so that their operation

- a) does not adversely affect the draft required for proper operation of fuel-fired *appliances*, and
- b) does not allow the air in the duct system to be contaminated by air or gases from the *boiler* room or *furnace* room.

2) Fans and associated air-handling equipment, such as air washers, filters and heating and cooling units, when installed on the roof or elsewhere outside the *building*, shall be of a type designed for outdoor use.

**6.3.2.18. Vibration Isolation Connectors**

1) Vibration isolation connectors in air duct systems shall comply with Article 3.6.5.2.

**6.3.2.19. Tape**

1) Tape used for sealing joints in air ducts, *plenums* and other parts of air duct systems shall comply with Article 3.6.5.3.

**6.3.3. Chimneys and Venting Equipment**

**6.3.3.1. Requirement for Venting**

1) Except as provided in Articles 6.3.3.2. and 6.3.3.3., the products of combustion from oil-, gas- and solid-fuel-burning *appliances* shall be vented in conformance with the requirements in the applicable *appliance* installation standard listed in Article 6.2.1.5.

2) Except as provided in Article 6.2.1.5., vented products of combustion, other than those referred to in Sentence (1), shall be discharged away from the *building*, so as not to re-enter it, to a distance not less than

- a) 2.15 m above sidewalks and driveways,
- b) 3 m from outdoor air intakes,
- c) 3 m horizontally or vertically from doors and operable windows, and
- d) 3 m horizontally or vertically from occupiable outdoor spaces, excluding maintenance spaces.

(See Note A-6.3.3.1.(2).)

**6.3.3.2. Masonry or Concrete Chimneys**

1) Rectangular *masonry or concrete chimneys* not more than 12 m in height shall conform to Part 9 if they serve

- a) *appliances* with a combined total rated heat output of 120 kW or less, or
- b) fireplaces.

**2)** *Masonry or concrete chimneys* other than those described in Sentence (1) shall be designed and installed in conformance with the appropriate requirements in NFPA 211, "Chimneys, Fireplaces, Vents, and Solid Fuel-Burning Appliances."

### 6.3.3.3. Metal Smoke Stacks

**1)** Single wall metal smoke stacks shall be designed and installed in conformance with NFPA 211, "Chimneys, Fireplaces, Vents, and Solid Fuel-Burning Appliances."

### 6.3.3.4. Access Ladders

**1)** Access ladders for *chimneys*, when provided, shall consist of steel or bronze rungs, built into the walls of the *chimneys*.

**2)** Rungs for external ladders shall begin at not less than 2.5 m from ground level.

## 6.3.4. Ventilation for Laboratories

### 6.3.4.1. Application

**1)** This Subsection applies to laboratories where *dangerous goods*, including *flammable liquids* and *combustible liquids*, are used in normal laboratory operations in quantities or in a manner that creates a fire or explosion hazard.

### 6.3.4.2. General Ventilation

**1)** A laboratory shall be provided with continuous mechanical ventilation designed to ensure that *dangerous goods* vapours and particles

- a) do not accumulate in the laboratory,
- b) are prevented from migrating to other parts of the *building*,
- c) do not accumulate in the ventilation system,
- d) are exhausted to the outdoors, and
- e) are not returned to the *building*.

**2)** A ventilation system required by this Subsection shall be provided with monitoring devices to

- a) indicate that the ventilation system is in operation, and
- b) sound an alarm if the ventilation system is malfunctioning.

**3)** A ventilation system required by this Subsection shall be maintained in conformance with Article 5.5.4.1. of Division B of the NFC.

### 6.3.4.3. Enclosure Exhaust Ventilation

**1)** The ventilation system for a power-ventilated enclosure required by Sentence 5.5.4.2.(1) of Division B of the NFC shall

- a) conform to NFPA 91, "Exhaust Systems for Air Conveying of Vapors, Gases, Mists, and Noncombustible Particulate Solids,"
- b) provide continuous exhaust ventilation at an air velocity sufficient to prevent the accumulation of *combustible* or reactive deposits in the power-ventilated enclosure and its *exhaust duct* system,
- c) confine *dangerous goods* vapours and particles to the area where they are generated and exhaust them to the outdoors,
- d) not return the exhausted air to the *building*, and
- e) be provided with well identified control switches that are
  - i) located outside of the power-ventilated enclosure, and
  - ii) readily accessible in case of an emergency.



**6.3.4.4. Enclosure Construction**

- 1)** The power-ventilated enclosure required by Sentence 5.5.4.2.(1) of Division B of the NFC and its *exhaust duct* system shall
  - a) except as provided in Sentences (2) and (3), be constructed of *noncombustible* materials compatible with and chemically resistant to the *dangerous goods* vapours and particles being exhausted, and
  - b) be provided with access doors to permit inspection and maintenance of the fan assembly and *exhaust ducts*.
- 2)** *Combustible* materials are permitted in systems described in Clause (1)(a) if
  - a) such materials are required by the corrosive or reactive properties of the *dangerous goods* being used, and
  - b) their *flame-spread rating* is not more than 25.
- 3)** The *flame-spread rating* required by Sentence (2) is permitted to be greater than 25 if an automatic fire suppression system is provided inside the power-ventilated enclosure and its *exhaust duct* system.

**Section 6.4. Heating Systems****6.4.1. Heating Appliances, General****6.4.1.1. Location of Appliances**

- 1)** Except for *appliances* installed in *dwelling units*, fuel-fired heating *appliances* shall be located, enclosed or separated from the remainder of the *building* in conformance with Section 3.6. (See also Subsection 9.10.10.)

**6.4.1.2. Appliances Installed Outside the Building**

- 1)** Fuel-fired *appliances* installed outside a *building* shall be designed and constructed for outdoor use.

**6.4.2. Unit Heaters****6.4.2.1. Clearances**

- 1)** Every *unit heater* using either steam or hot water as the heating medium shall be installed such that the clearances between the *appliance* and adjacent *combustible* material conform to Table 6.7.1.2.

**6.4.3. Radiators and Convectors****6.4.3.1. Lining or Backing**

- 1)** A *noncombustible* lining or backing shall be provided for every steam or hot water radiator and convector
  - a) located in a recess or concealed space, or
  - b) attached to the face of a wall of *combustible construction*.
- 2)** Every steam or hot water radiator and convector shall be installed so as to conform to the clearance requirements of Table 6.7.1.2.

**Section 6.5. Thermal Insulation Systems****6.5.1. Insulation****6.5.1.1. Insulation and Coverings**

(See Note A-6.3.2.5.)

- 1)** Insulation and coverings on pipes shall comply with Article 3.6.5.5.

2) Insulation and coverings on pipes shall be composed of material that will withstand deterioration from softening, melting, mildew and mould at the operating temperature of the system.

3) Exposed piping or equipment subject to human contact shall be insulated so that the temperature of the exposed surface does not exceed 70°C. (See Note A-6.5.1.1.(3).)

## Section 6.6. Refrigeration and Cooling Systems

### 6.6.1. Refrigerating Systems and Equipment for Air-conditioning

#### 6.6.1.1. Cooling Units

1) Where a cooling unit is combined with a fuel-fired *furnace* in the same duct system, the cooling unit shall be installed

- a) in parallel with the heating *furnace*,
- b) upstream of the *furnace* provided the *furnace* is designed for such application, or
- c) downstream of the *furnace* provided the cooling unit is designed to prevent excessive temperature or pressure in the refrigeration system.

## Section 6.7. Piping Systems

### 6.7.1. Piping for Heating and Cooling Systems

#### 6.7.1.1. Piping Materials and Installation

1) Piping shall be made from materials designed to withstand the effects of temperatures and pressures that may occur in the system. (See Articles 3.1.5.19., 3.1.9.1., 9.10.9.6. and 9.10.9.7. for fire safety requirements.)

2) Every pipe used in a heating or air-conditioning system shall be installed to allow for expansion and contraction due to temperature changes.

3) Supports and anchors for piping in a heating or air-conditioning system shall be designed and installed to ensure that undue stress is not placed on the supporting structure.

#### 6.7.1.2. Clearances

1) Clearances between *combustible* material and bare pipes carrying steam or hot water shall conform to Table 6.7.1.2.

**Table 6.7.1.2.**  
**Clearance Between Steam or Hot Water Pipes and Combustible Material**  
 Forming Part of Articles 6.4.2.1. and 6.7.1.2., and Sentence 6.4.3.1.(2)

Steam or Water Temperature, °C	Minimum Clearance, mm
Up to 95	No clearance
Above 95 to 120	15
Above 120	25

#### 6.7.1.3. Surface Temperature

1) The exposed surface temperature of a steam or hot water radiator shall not exceed 70°C unless precautions are taken to prevent human contact. (See Note A-6.5.1.1.(3).)

**6.7.1.4. Protection**

1) Where a pipe carrying steam or hot water at a temperature above 120°C passes through a *combustible* floor, ceiling or wall, the construction shall be protected by a sleeve of metal or other *noncombustible* material not less than 50 mm larger in diameter than the pipe.

**6.7.1.5. Piping in Shafts**

1) Where piping for heating or air-conditioning systems is enclosed in a shaft, the requirements of Article 3.6.3.1. for shafts shall apply.

**6.7.2. Storage Bins****6.7.2.1. Storage Bins**

1) Service pipes passing through a storage bin for solid fuel shall be protected or so located as to avoid damage to the pipes.

2) Except for fuel-thawing pipes, every pipe designed to operate at a temperature of 50°C or above shall be located where solid fuel cannot be stored in contact with it.

**Section 6.8. Equipment Access****6.8.1. Openings****6.8.1.1. Access Openings**

1) Any covering of an access opening through which a person could enter shall be openable from the inside without the use of keys where there is a possibility of the opening being accidentally closed while the system or equipment is being serviced.

**6.8.1.2. Openings in Air Duct Systems**

1) Air duct systems shall have no openings other than those required for the proper operation and maintenance of the system.

2) Access openings shall be provided in duct systems to allow the removal of material that may accumulate in *plenums* and ducts.

**6.8.1.3. Odour Removal Equipment**

- 1) When odour removal equipment of the adsorption type is used, it shall be
  - a) installed to allow access so that adsorption material can be reactivated or renewed, and
  - b) protected from dust accumulation by air filters installed on the inlet side.

2) Facilities for flushing and drainage shall be provided where filters are designed to be washed in place.

**Section 6.9. Fire Safety Systems****6.9.1. General****6.9.1.1. Fire Safety Requirements**

1) The fire safety characteristics of heating, ventilating and air-conditioning systems shall comply with Subsection 3.6.5.

- 2) Characteristics referred to in Sentence (1) include but are not limited to
  - a) use of *combustible* materials in duct systems,
  - b) *flame-spread ratings* and smoke-developed ratings of duct and pipe materials and coverings,

- c) installation of equipment relative to property lines, and
- d) requirements for *fire dampers* and *fire stop flaps*.

### 6.9.1.2. Hazardous Gases, Dusts or Liquids

**1)** Except as provided in Subsection 6.3.4., systems serving spaces that contain hazardous gases, dusts or liquids shall be designed, constructed and installed to conform to the requirements of the applicable provincial or territorial regulations or municipal bylaws or, in the absence of such regulations or bylaws, to good engineering practice such as that described in the publications of the National Fire Protection Association and in the NFC. (See Note A-6.9.1.2.(1).)

**2)** When indoor piping for Class I *flammable liquids* is installed in a trench, the trench shall be

- a) provided with positive ventilation to the outdoors, or
- b) designed to prevent the accumulation of flammable vapours.

### 6.9.1.3. Commercial Cooking Equipment

**1)** Fire protection systems for commercial cooking equipment referred to in Sentence 6.3.1.7.(1) using vegetable oil or animal fat shall conform to

- a) ANSI/UL 300, "Fire Testing of Fire Extinguishing Systems for Protection of Commercial Cooking Equipment," or
- b) ULC/ORD-C1254.6, "Fire Testing of Restaurant Cooking Area Fire Extinguishing System Units."

## 6.9.2. Dampers and Ductwork

### 6.9.2.1. Fire Dampers

**1)** *Fire dampers* shall conform to Article 3.1.8.10.

### 6.9.2.2. Smoke Detectors

**1)** Air handling systems shall incorporate *smoke detectors* where and as required by Article 3.2.4.12.

### 6.9.2.3. Exhaust Ducts and Outlets

**1)** Where an *exhaust duct* system is used for smoke removal in a high *building*, the requirements of Article 3.2.6.6. shall apply.

**2)** Where *exhaust duct* systems from more than one *fire compartment* are connected to an *exhaust duct* in a *vertical service space*, the requirements of Article 3.6.3.4. shall apply.

### 6.9.2.4. Ducts in Exits

**1)** Where ducts penetrate *fire separations* separating *exits* from the remainder of the *building*, they shall be in accordance with Article 3.4.4.4.

## 6.9.3. Carbon Monoxide Alarms

### 6.9.3.1. Carbon Monoxide Alarms

**1)** This Article applies to every *building* that contains a *residential occupancy*, a *care occupancy* with individual *suites*, or a *care occupancy* containing sleeping rooms not within a *suite*, and that also contains

- a) a fuel-burning *appliance*, or
- b) a *storage garage*.

**2)** Carbon monoxide (CO) alarms required by this Article shall

- a) conform to CAN/CSA-6.19, "Residential Carbon Monoxide Alarming Devices,"
- b) be equipped with an integral alarm that satisfies the audibility requirements of CAN/CSA-6.19, "Residential Carbon Monoxide Alarming Devices,"

- c) have no disconnect switch between the overcurrent device and the CO alarm, where the CO alarm is powered by the electrical system serving the *suite* (see Note A-6.9.3.1.(2)(c)), and
  - d) be mechanically fixed at a height above the floor as recommended by the manufacturer.
- 3)** Where a fuel-burning *appliance* is installed in a *suite of residential occupancy* or in a *suite of care occupancy*, a CO alarm shall be installed
- a) inside each bedroom, or
  - b) outside each bedroom, within 5 m of each bedroom door, measured following corridors and doorways.
- 4)** Where a fuel-burning *appliance* is installed in a *service room* that is not in a *suite of residential occupancy* nor in a *suite of care occupancy*, a CO alarm shall be installed
- a) either inside each bedroom, or if outside, within 5 m of each bedroom door, measured following corridors and doorways, in every *suite of residential occupancy* or *suite of care occupancy* that shares a wall or floor/ceiling assembly with the *service room*, and
  - b) in the *service room*.
- 5)** For each *suite of residential occupancy* or *suite of care occupancy* that shares a wall or floor/ceiling assembly with a *storage garage* or that is adjacent to an attic or crawl space to which the *storage garage* is also adjacent, a CO alarm shall be installed
- a) inside each bedroom, or
  - b) outside each bedroom, within 5 m of each bedroom door, measured following corridors and doorways.

#### 6.9.4. Ash Storage

##### 6.9.4.1. Ash Storage Bins

- 1) Every ash storage bin shall be constructed of *noncombustible* material.
- 2) Every opening in an ash storage bin shall be protected by a tight-fitting metal door with metal frame securely fastened to the bin.

##### 6.9.4.2. Fireplaces

- 1) Fireplaces shall conform to the requirements of Section 9.22.

## Section 6.10. Objectives and Functional Statements

### 6.10.1. Objectives and Functional Statements

#### 6.10.1.1. Attributions to Acceptable Solutions

- 1) For the purpose of compliance with this Code as required in Clause 1.2.1.1.(1)(b) of Division A, the objectives and functional statements attributed to the acceptable solutions in this Part shall be the objectives and functional statements listed in Table 6.10.1.1. (See Note A-1.1.2.1.(1).)

**Table 6.10.1.1.**  
**Objectives and Functional Statements Attributed to the**  
**Acceptable Solutions in Part 6**  
 Forming Part of Sentence 6.10.1.1.(1)

Functional Statements and Objectives <sup>(1)</sup>	
<b>6.2.1.1. Good Engineering Practice</b>	
(1)	(a) to (e) [F31,F51-OP1.1]
	(a) to (c) and (e) to (i) [F40,F50,F51,F52,F54,F63-OH1.1]
	(a),(b),(c),(e),(f),(g),(h) [F50,F51,F52,F54,F63-OH1.2,OH1.3]
	[F31,F50,F51,F52,F54,F63-OS3.2,OS3.4]
	(d) [F01-OS1.1]
<b>6.2.1.2. Outdoor Design Conditions</b>	
(2)	[F40,F44,F50-OH1.1]
	[F44-OS3.4]
(3)	[F40,F44,F50-OH1.1]
	[F44-OS3.4]
<b>6.2.1.3. Expansion, Contraction and System Pressure</b>	
(1)	[F20-OS3.2]
<b>6.2.1.4. Structural Movement</b>	
(1)	[F23-OS3.1]
	[F51,F63,F50-OH1.1,OH1.2,OH1.3]
<b>6.2.1.5. Installation Standards</b>	
(1)	[F43-OS1.1]
	[F43-OS3.4]
	[F43-OP1.1]
<b>6.2.1.6. Installation – General</b>	
(1)	[F82-OS1.1]
	[F82-OS3.4]
	[F82-OP1.1]
(2)	[F31-OS3.1]
(3)	[F81-OS3.2,OS3.3,OS3.4]
	[F81-OS1.1]
<b>6.2.1.7. Asbestos</b>	
(1)	[F43-OH1.1]
<b>6.2.2.1. Applicable Standard</b>	
(1)	[F81-OS1.1]
<b>6.2.3.1. Solid Fuel Storage Bins</b>	
(1)	[F30-OH2.1]
(2)	[F01-OS1.1]
	[F01-OP1.1]
<b>6.3.1.1. Required Ventilation</b>	
(1)	[F50,F31,F63,F51,F54,F52-OS1.1]
	[F50,F31,F63,F51,F54,F52-OP1.1]
(2)	[F50-OH1.1]
<b>6.3.1.2. Crawl Spaces and Attic or Roof Spaces</b>	
(1)	[F61,F63,F41-OH1.1,OH1.3]

**Table 6.10.1.1. (Continued)**

Functional Statements and Objectives <sup>(1)</sup>	
<b>6.3.1.3. Natural Ventilation</b>	
(1)	[F50-OH1.1]
(2)	[F50-OH1.1]
<b>6.3.1.4. Ventilation of Storage Garages</b>	
(1)	[F50,F44-OS3.4]
(2)	[F44-OS3.4]
(3)	[F44-OS3.4]
(4)	[F50,F44-OS3.4]
(5)	[F50,F44-OH1.1]
	[F50,F44-OS3.4]
<b>6.3.1.6. Indoor Air Contaminants</b>	
(1)	[F44-OS3.4]
	[F44-OH1.1]
(2)	[F44-OH1.1]
(3)	[F52-OH1.1]
<b>6.3.1.7. Commercial Cooking Equipment</b>	
(1)	[F01,F44-OS1.1]
	[F01,F44-OP1.1]
<b>6.3.2.2. Drain Pans</b>	
(1)	[F41,F44,F50-OH1.1]
<b>6.3.2.3. Materials in Air Duct Systems</b>	
(2)	[F20,F80-OH1.1,OH1.2]
(3)	[F81,F44-OS3.4]
	[F81-OH1.1]
(4)	[F20,F80-OH1.1,OH1.2]
<b>6.3.2.4. Connections in Air Duct Systems</b>	
(1)	[F81-OH1.1,OH1.2]
	[F81,F44-OS3.4]
<b>6.3.2.5. Duct Coverings and Linings</b>	
(2)	[F81-OH1.1,OH1.2]
	[F81-OS1.1]
	[F81-OP1.1]
<b>6.3.2.7. Interconnection of Systems</b>	
(1)	[F44-OS1.1]
	[F40-OH1.1]
(2)	[F81,F44-OH1.1]
	[F81,F44-OS1.1]
	[F81,F44-OP1.1]
(3)	[F81,F44-OH1.1]
<b>6.3.2.8. Makeup Air</b>	
(1)	[F50,F81-OH1.1]
	[F44,F81-OS3.4]

**Table 6.10.1.1. (Continued)**

Functional Statements and Objectives <sup>(1)</sup>	
(2)	[F81-OH1.1] [F81,F44-OS3.4]
(3)	[F81-OH1.2]
<b>6.3.2.9. Supply, Return, Intake and Exhaust Air Openings</b>	
(1)	[F30-OS3.1] [F81-OH1.2]
(2)	[F44,F81-OH1.1] [F81,F44-OS3.4]
(3)	[F44,F81-OH1.1] [F44,F81-OS3.4]
(4)	[F81-OH1.1]
(5)	[F82,F81-OH1.1] [F82-OS3.4]
<b>6.3.2.10. Exhaust Ducts and Outlets</b>	
(1)	[F44-OH1.1]
(2)	[F44-OH1.1]
(3)	[F81-OH1.1] [F81-OH1.2]
(4)	[F81-OH1.1] [F81-OH1.2]
(5)	[F81-OH1.1]
(6)	[F81-OH1.1]
(7)	[F81-OS1.1]
(8)	[F40,F44,F50,F52-OH1.1] [F01-OS1.1] [F01-OP1.1]
(9)	[F40,F44,F50,F52-OH1.1] [F01-OS1.1] [F01-OP1.1]
(10)	[F81-OH1.1]
(11)	[F81,F44-OH1.1] [F81,F44-OS1.1]
(12)	[F81,F44-OH1.1]
(13)	[F81-OH1.2] [F81,F44-OH1.1]
<b>6.3.2.11. Return-Air System</b>	
(3)	[F10-OS1.5]
<b>6.3.2.12. Underground Ducts</b>	
(1)	(a) [F44,F81-OH1.2,OH1.3] (b) [F44,F81-OH1.1] (c) [F44,F81-OH1.1]
(2)	[F81-OH1.1,OH1.2,OH1.3]

**Table 6.10.1.1. (Continued)**

Functional Statements and Objectives <sup>(1)</sup>	
<b>6.3.2.13. Filters</b>	
(1)	[F80-OS1.1] [F80-OP1.1]
(2)	[F30-OS3.3] [F81,F43-OH1.1]
<b>6.3.2.14. Cleaning Devices</b>	
(1)	[F30-OS3.3] [F81,F43-OH1.1]
(2)	[F40,F43,F44,F50-OH1.1] [F44-OS3.4]
<b>6.3.2.15. Evaporative Cooling Towers, Evaporative Fluid Coolers and Evaporative Condensers</b>	
(1)	[F41,F44-OH1.1]
(2)	[F41,F44-OH1.1]
(3)	[F46,F81-OH2.2]
(4)	[F41,F44-OH1.1] [F46,F81-OH2.2]
(5)	[F81-OH2.1]
(6)	[F82-OH1.1]
<b>6.3.2.16. Evaporative Air Coolers, Misters, Atomizers, Air Washers and Humidifiers</b>	
(1)	[F80,F81-OS1.1] [F80,F81-OP1.1]
(2)	[F82-OH1.1]
(3)	[F44-OH1.1]
<b>6.3.2.17. Fans and Associated Air-Handling Equipment</b>	
(1)	[F81,F44-OH1.1] [F81,F44-OS3.4]
(2)	[F81-OH1.1]
<b>6.3.3.1. Requirement for Venting</b>	
(2)	[F40,F44,F50-OH1.1]
<b>6.3.3.2. Masonry or Concrete Chimneys</b>	
(2)	[F01-OS1.1] [F01-OP1.1]
<b>6.3.3.3. Metal Smoke Stacks</b>	
(1)	[F01-OS1.1] [F01-OP1.1]
<b>6.3.3.4. Access Ladders</b>	
(1)	[F20,F80-OS3.1]
(2)	[F30-OS3.1]
<b>6.3.4.2. General Ventilation</b>	
(1)	(a),(b),(d),(e) [F01-OS1.1] (c) [F02-OP1.2] (c) [F02-OS1.2] [F81,F82-OS1.1]

Copyright © NRC 1941 - 2021 World Rights Reserved © CNRC 1941-2021 Droits réservés pour tous pays

Table 6.10.1.1. (Continued)

Functional Statements and Objectives <sup>(1)</sup>	
(2)	[F11,F81-OS1.1]
<b>6.3.4.3. Enclosure Exhaust Ventilation</b>	
(1)	(a),(c),(d) [F01-OS1.1]
	(b) [F02-OP1.2]
	(e) [F12-OP1.1,OP1.2]
	(a) [F02-OP1.2]
	(b) [F02-OS1.2] [F81-OS1.1]
	(e) [F12-OS1.1,OS1.2]
	(a) [F02-OS1.2]
	(a) [F01-OS1.1]
<b>6.3.4.4. Enclosure Construction</b>	
(1)	(a) [F02-OS1.2] Applies to portion of Code text: "... be constructed of <i>noncombustible</i> materials ..."
	(b) [F02-OP1.2]
	(a) [F02-OP1.2] Applies to portion of Code text: "... be constructed of <i>noncombustible</i> materials ..."
	(a) [F80-OS3.4] Applies to portion of Code text: "... be constructed of ... materials ... chemically resistant to the <i>dangerous goods</i> vapours and particles being exhausted ..."
	(b) [F02-OS1.2] [F82-OS1.1]
	(a) [F80-OS1.1] Applies to portion of Code text: "... be constructed of ... materials ... chemically resistant to the <i>dangerous goods</i> vapours and particles being exhausted ..."
(3)	[F02-OS1.2]
	[F02-OP1.2]
<b>6.4.1.2. Appliances Installed Outside the Building</b>	
(1)	[F81-OP1.1]
	[F81-OH1.1]
	[F81-OS1.1]
<b>6.4.2.1. Clearances</b>	
(1)	[F01-OP1.1]
	[F01-OS1.1]
<b>6.4.3.1. Lining or Backing</b>	
(1)	[F01-OS1.1]
	[F01-OP1.1]
(2)	[F01-OS1.1]
<b>6.5.1.1. Insulation and Coverings</b>	
(2)	[F20,F30-OS3.2,OS3.4]
(3)	[F31-OS3.2]
<b>6.6.1.1. Cooling Units</b>	
(1)	[F43,F81-OS3.4]
<b>6.7.1.1. Piping Materials and Installation</b>	
(1)	[F20-OS3.2,OS3.4]

Table 6.10.1.1. (Continued)

Functional Statements and Objectives <sup>(1)</sup>	
(2)	[F21-OH1.1]
(3)	[F20-OS2.2]
<b>6.7.1.2. Clearances</b>	
(1)	[F01-OS1.1]
	[F01-OP1.1]
<b>6.7.1.3. Surface Temperature</b>	
(1)	[F31-OS3.2]
<b>6.7.1.4. Protection</b>	
(1)	[F01-OS1.1]
	[F01-OP1.1]
<b>6.7.2.1. Storage Bins</b>	
(1)	[F30,F31,F43-OS3.2,OS3.4]
(2)	[F01-OS1.1]
	[F01-OP1.1]
<b>6.8.1.1. Access Openings</b>	
(1)	[F36-OS3.6]
<b>6.8.1.2. Openings in Air Duct Systems</b>	
(1)	[F81-OH1.1,OH1.2]
	[F81,F44-OS3.4]
(2)	[F82-OS1.1]
<b>6.8.1.3. Odour Removal Equipment</b>	
(1)	[F82-OH1.1]
(2)	[F82-OH1.1]
<b>6.9.1.2. Hazardous Gases, Dusts or Liquids</b>	
(1)	[F01-OP1.1]
	[F01-OS1.1]
(2)	[F01-OS1.1]
	[F01-OP1.1]
<b>6.9.1.3. Commercial Cooking Equipment</b>	
(1)	[F02,F81-OS1.2]
	[F02,F81-OP1.2]
<b>6.9.3.1. Carbon Monoxide Alarms</b>	
(2)	(a),(b),(d) [F44-OS3.4] (c) [F81-OS3.4]
(3)	[F44-OS3.4]
(4)	[F44-OS3.4]
(5)	[F44-OS3.4]
<b>6.9.4.1. Ash Storage Bins</b>	
(1)	[F01-OS1.1]
	[F01-OP1.1]
(2)	[F01-OS1.1]
	[F01-OP1.1]

**Notes to Table 6.10.1.1.:**

(1) See Parts 2 and 3 of Division A.



# Notes to Part 6

## Heating, Ventilating and Air-conditioning

### **A-6.2.1.1. Good Engineering Practice.**

#### **Building Pressurization**

New buildings tend to be considerably more airtight than older ones. Consequently, these buildings may have a reduced pressurization requirement compared to the normal requirement in order to limit drafts and provide a reasonable level of comfort.

The humidification and relative pressurization of buildings and individual spaces in buildings can be significant factors in compromising the ongoing performance of the building envelope and other environmental separators.

In new construction, HVAC designers should take this issue into consideration and confer with those responsible for the design of the environmental separators so as to limit unintended effects on the environmental separators. In existing buildings, the ability of the environmental separators to resist or accommodate increases in pressure differential or moisture loading should be considered before changes are made to the HVAC system.

#### **Radon Control**

Measures may be necessary to reduce the radon concentration to a level below the guideline specified by Health Canada.

Further information on reducing the indoor concentration of radon can be found in the following Health Canada publications:

- "Guide for Radon Measurements in Public Buildings (Schools, Hospitals, Care Facilities, Detention Centres)," and
- "Radon: A Guide for Canadian Homeowners."

**A-6.2.1.2.(2) Outdoor Design Conditions.** In the past, the practice of ventilating buildings with outdoor air assumed that the outdoor air was of better quality than the indoor air. It has become evident that the outdoor air in some areas of Canada may not be of an acceptable quality for ventilating buildings unless certain particles and gases are first removed or reduced. For particulate matter, the maximum acceptable level is the 98th percentile of the average 24 hour values; for ozone, the maximum acceptable level is the average of the average 8 hour values. A recent estimate suggests that many Canadians are exposed to contaminated outdoor air via buildings' ventilation systems, which may lead to health problems such as cardiovascular and cerebral vascular diseases, respiratory irritation and illnesses, asthma, allergies, cancer, mucus membrane disorders and possibly death.

In order to manage the air quality of a building's indoor environment, thus reducing the potential for adverse effects on occupants' health, the quality of outdoor air for building ventilation purposes must be addressed. The air pollutants for which standards have been developed are particulate matter and ground-level ozone. Sentence 6.2.1.2.(2) sets limits on the maximum acceptable levels of these particles and gas that a building's ventilation system should introduce directly to the indoor environment. These limits form part of the Canada-wide Standards for Particulate Matter (PM) and Ozone, which were established pursuant to the 1998 Canada-wide Accord on Environmental Harmonization of the Canadian Council of Ministers of the Environment (CCME) and its Canada-wide Environmental Standards Sub-Agreement. Information on related regulations is available from Environment Canada and the provincial/territorial ministries of the environment. A database of particle measurements for certain Canadian locations is available from the National Air Pollution

---

These Notes are included for explanatory purposes only and do not form part of the requirements. The number that introduces each Note corresponds to the applicable requirement in this Part.

Surveillance Network (NAPS), which is run by Environment Canada in conjunction with the provinces and territories. (See Subsection 1.3.2. for contact information for CCME, Environment Canada and NAPS.)

**A-6.2.1.2.(3) Outdoor Design Conditions.** The outdoor air at the local area of the building site, including its immediate surroundings, should be assessed to identify the levels of contaminants that may be of concern if allowed to enter the building. Examples of contaminants of concern include the following:

- irritants from restaurant and dumpster emissions
- visible plumes from cooling towers and incinerators
- combustion exhaust from vehicles on loading docks and highways
- other visible sources of contaminants on site and from adjoining properties (e.g. manufacturing plants)

Factors that can influence the infiltration of contaminants, such as the building's geometry and prevailing winds and seasonal activity in the local area, should also be considered. Features can be incorporated in the design of the building to mitigate the effects of the identified contaminants of concern to the building occupants.

**A-6.2.1.4. Structural Movement.** This Article is intended to remind designers and installers of mechanical systems of one aspect of the "good engineering practice" referred to in Article 6.2.1.1.

In determining how to accommodate structural movement, there are two important principles to bear in mind:

- The prime concern of the NBC is the safety of people in and around the building, as opposed to protection of the mechanical systems and equipment.
- The nature of the accommodation will vary with the type of movement being considered, taking into account particularly how often the movement is likely to be encountered over the life of the building.

For example, a gas line supported on columns that also support a crane must be installed in such a way that the movement of the columns, which occurs many times daily, does not cause the lines to break, thus creating a hazard. Even if the gas line installation could somehow be designed to break in a non-hazardous manner, it would hardly be recognized as good engineering practice if movement that occurs so frequently could disrupt the operation of the mechanical system.

On the other hand, earthquakes occur far less frequently and it would not be surprising to have a non-critical mechanical system fail as a result of an earthquake. However, even in this situation, the failure must occur in a manner that does not create a hazard to building occupants. For example, heavy mechanical equipment should be properly anchored so that it does not topple on building occupants during an earthquake. The design of the anchors should take into account accelerations consistent with the seismic data given in Appendix C for the location of the building. Part 4 provides guidance on the calculation of the loads such equipment would exert on the building structure during an earthquake; these same loads can be used in designing the anchors.

Some mechanical equipment can be an important component of post-disaster life safety systems. In these cases, the measures needed to accommodate the movements caused by an earthquake become even more critical since failure of the equipment would not be acceptable.

Clearly, complying with this requirement will, in most cases, necessitate close coordination between the mechanical designer and the structural designer.

For additional information on the types of structural movement that may be encountered, see Article 4.1.3.5., Sentence 4.1.3.3.(2) and Subsection 4.1.8.

**A-6.2.1.6.(1) Installation – General.** Ducts or pipes without dampers or valves are generally not considered to constitute "equipment" and are therefore not subject to this requirement.

**A-6.3.1.2.(1) Ventilation and Venting of Crawl Spaces and Attic or Roof Spaces.** The cross-reference to Part 5 pertains to unconditioned and unoccupied crawl spaces, and attic or roof spaces, which are effectively within the building envelope. That is, unconditioned and unoccupied attic or roof spaces are located between the roof deck and roofing above, and the insulation, air barrier system and vapour barrier below. Unconditioned and unoccupied crawl spaces are located between the ground cover below and the insulation, air barrier system and vapour barrier above. Venting of these spaces has implications for the performance of the building envelope rather than having direct effects on indoor conditions. The ventilation of conditioned or occupied crawl spaces and attic or roof spaces must comply with Part 6.

The requirements in Part 5 are stated in terms of loads that must be resisted rather than in terms of building elements. Thus, the Code user will not find explicit references in Part 5 to crawl spaces, or attic or roof spaces. Part 5 makes reference to the need for venting environmental separators, i.e., the dissipation of heat or moisture.

Sentence 6.3.1.2.(1) requires that crawl spaces be ventilated either by natural (above-grade only) or mechanical means. High moisture levels within the crawl space can lead to problems such as the formation of mould, lifting of flooring or long-term damage to structural components.

Crawl space ventilation cannot be expected to correct moisture-related problems caused by other factors like inadequate surface drainage from the foundation walls or improper protection against moisture from the ground. These conditions must be properly addressed so that crawl space ventilation can meet its intended objectives.

Several factors favour the use of mechanical ventilation rather than reliance on natural drafts. Local conditions, such as areas with high water tables, may dictate the need for mechanical ventilation to remove excessive moisture.

Crawl spaces should be maintained at a negative pressure relative to the conditioned area above to prevent the migration of moisture into occupied areas. This can be achieved through the use of an exhaust fan and relying on air transfer through floor penetrations, such as pipes.

**A-6.3.1.4.(1) Storage Garages.** Areas where motor vehicles are parked with the engine off for extended periods of time, such as car dealership showrooms, are not considered as storage garages.

**A-6.3.1.4.(2) Ventilation of Storage Garages.** Storage garages are ventilated to protect occupants from exposure to carbon monoxide and other vehicular exhaust fumes. In certain cases, such as small two- or three-bay storage garages that are used for occasional vehicle storage, and where occupants are not present, carbon monoxide or nitrogen dioxide monitoring devices may be omitted if the ventilation system is interlocked with a local light switch or other controls to ensure continuous system operation whenever the area is occupied. In any event, the ventilation system capacity must be designed to limit the concentrations of carbon monoxide or nitrogen dioxide at or below the prescribed values.

### **A-6.3.1.6. Indoor Air Contaminants.**

#### **Contaminants of Concern**

Indoor air can contain complex mixtures of contaminants of concern such as formaldehyde, legionella, mould and emissions from building materials. While some contaminants may be knowingly introduced — as in the case of processing and manufacturing environments — others may be unintentionally released into indoor environments. “Industrial Ventilation: A Manual of Recommended Practice for Design,” published by the ACGIH, and the “Exposure Guidelines for Residential Indoor Air Quality,” published by Health Canada, are useful references on the control of contaminants in industrial workplace environments and residential settings, respectively. These and other guidelines and manuals should be interpreted while keeping in mind the settings and purposes for which they were developed compared to those to which they will be applied. Note that such documents do not necessarily consider the interactions between various contaminants.

#### **Minimizing the Growth and Spread of Bio-contaminants**

Bio-contaminants, such as bacteria, mould, mildew, fungi, viruses, and pollen, can thrive or be spread by sources like drain pans, spray-water air-washers, contaminated filters, poorly maintained cooling coils, water incursion into ductwork, cafeteria dishwasher drainage leaks, high humidity and stagnant water, potentially causing a wide range of adverse health effects including respiratory allergic reactions, asthma, and infectious diseases ranging from influenza to legionnaires’ disease.

Some of the control measures are as follows:

- (a) Air-handling equipment should be accessible for the maintenance of filters, cooling coils and condensate drain pans located below the cooling coils. Access doors should be large and easy to open to facilitate thorough and regular maintenance.
- (b) If moisture is added to building ventilation air to maintain humidity levels in a designated range, humidifiers that inject steam or water vapour into central air-handling units or main supply ducts are normally used. Injection nozzles should not be located in air-handling unit plenums or ductwork that is insulated with internal fibrous lining. If the lining becomes wet, conditions conducive to the growth and spread of bio-contaminants will result.

The above only addresses built-in features of an HVAC system that can help to minimize the growth and spread of bio-contaminants. Even more important than the built-in features is a program of regular maintenance and cleaning of those portions of the system where such growth is likely to occur.

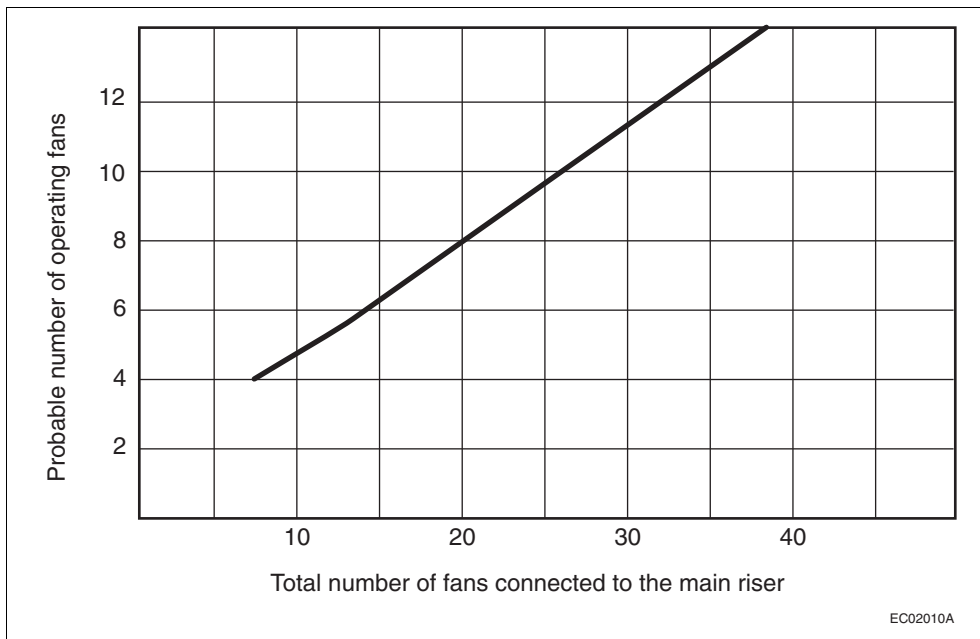
**A-6.3.2.5. Duct Coverings and Linings.** The TIAC “Mechanical Insulation Best Practices Guide” is a comprehensive source of information on the selection, installation and proper use of thermal insulation materials. (Note that Section 4 of this Guide is not included in the scope of this Note as it contains information on proprietary products, which are not within the mandate of the Code.)

**A-6.3.2.10.(5) and (6) Exhausting to Garages.** A frequent practice in the design of ventilation systems serving buildings which have associated parking garages is to discharge exhaust air from the building to the garage in order to reduce the cost of heating the garage or reduce the length of the exhaust ducts. However, this practice entails a certain amount of risk since, when the exhaust system is not running, stack effect may turn the exhaust outlets into intakes and exhaust fumes (including carbon monoxide) can be drawn from the garage into the building. Incorporating a backdraft damper at the exhaust outlet provides some additional protection but backdraft dampers are generally not regarded as being very reliable. Therefore this practice is only permitted in very limited circumstances.

**A-6.3.2.10.(6)(b) Air Contaminants.** For the purpose of Clause 6.3.2.10.(6)(b), washroom exhaust air is not considered to contain contaminants that would adversely affect the air quality in the storage garage.

**A-6.3.2.10.(7) and (8) Exhaust Ducts Connected to Laundry-Drying Equipment.** Clothes dryers are a major cause of fires in buildings often due to a build-up of lint in the system, which then ignites or obstructs the venting or ventilation. Proper cleaning and regular maintenance of lint traps is directly proportional to the ease of access to the lint traps. It is therefore important to ensure that lint traps in multiple installations of laundry-drying equipment are installed in such a way as to allow easy access for inspection, maintenance, repair and cleaning.

**A-6.3.2.10.(12)(b) Operation Diversity Factor.** The operation diversity factor has to be assessed for each specific application. Good engineering practice (see Article 6.2.1.1.) design guidelines can provide information on the subject. Figure A-6.3.2.10.(12)(b), which originates from ASHRAE handbooks, provides an example of factors that can be used for general applications.



**Figure A-6.3.2.10.(12)(b)**  
**Operation diversity factor**

**A-6.3.3.1.(2) Requirement for Venting.** Sentence 6.3.3.1.(2) requires that vented products of combustion from appliances be discharged a minimum distance away from certain outdoor spaces and building components in cases where the vented products could contaminate the air of occupiable spaces. These minimum distances may need to be increased due to local conditions such as prevailing winds, adjacent structures, special processes being carried out, specific contaminants or effluent discharges, all of which would require further analysis.

“Occupiable outdoor spaces” refers to areas that could be occupied for a duration of more than fifteen minutes at any time, but does not include maintenance spaces. Occupiable outdoor spaces are located adjacent to an indoor space and are considered to be an extension of this indoor space: e.g. main entries, balconies, patios, decks, green roofs and other public assembly areas. Although sidewalks and driveways are mentioned in the provision, these areas are not considered as occupiable outdoor spaces since they are used as transport routes to and from the building, and people are not expected to remain there for extended periods of time.

The requirements of Sentence 6.3.3.1.(2) are not meant to override similar requirements found in the installation standards referenced in Article 6.2.1.5. that address identical situations.

**A-6.5.1.1.(3) Temperature of Exposed Piping.** Normally piping carrying steam or high-temperature hot water at pressures above atmospheric (corresponding temperature 100°C or above) will be insulated to reduce heat losses as an economy measure. Above a temperature of approximately 70°C, however, a bare pipe can cause a burn to human flesh coming in contact with the pipe. If pipes above this temperature are normally out of reach of all persons other than maintenance personnel or are properly guarded, it would be expected that no insulation would be needed for public safety.

**A-6.9.1.2.(1) NFPA Publications Pertaining to the Heating, Ventilating and Air-Conditioning of Spaces Containing Hazardous Gases, Dusts or Liquids.**

- NFPA 30, “Flammable and Combustible Liquids Code”
- NFPA 30A, “Motor Fuel Dispensing Facilities and Repair Garages”
- NFPA 32, “Drycleaning Plants”
- NFPA 33, “Spray Application Using Flammable or Combustible Materials”
- NFPA 34, “Dipping, Coating, and Printing Processes Using Flammable or Combustible Liquids”
- NFPA 35, “Manufacture of Organic Coatings”
- NFPA 36, “Solvent Extraction Plants”
- NFPA 40, “Storage and Handling of Cellulose Nitrate Film”
- NFPA 51, “Design and Installation of Oxygen-Fuel Gas Systems for Welding, Cutting, and Allied Processes”
- NFPA 51A, “Acetylene Cylinder Charging Plants”
- NFPA 55, “Compressed Gases and Cryogenic Fluids Code”
- NFPA 61, “Prevention of Fires and Dust Explosions in Agricultural and Food Processing Facilities”
- NFPA 68, “Explosion Protection by Deflagration Venting”
- NFPA 69, “Explosion Prevention Systems”
- NFPA 85, “Boiler and Combustion Systems Hazards Code”
- NFPA 86, “Ovens and Furnaces”
- NFPA 88A, “Parking Structures”
- NFPA 91, “Exhaust Systems for Air Conveying of Vapors, Gases, Mists, and Noncombustible Particulate Solids”
- NFPA 96, “Ventilation Control and Fire Protection of Commercial Cooking Operations”
- NFPA 204, “Smoke and Heat Venting”
- NFPA 303, “Marinas and Boatyards”
- NFPA 307, “Construction and Fire Protection of Marine Terminals, Piers, and Wharves”
- NFPA 409, “Aircraft Hangars”
- NFPA 415, “Airport Terminal Buildings, Fueling Ramp Drainage, and Loading Walkways”
- NFPA 484, “Combustible Metals”
- NFPA 654, “Prevention of Fire and Dust Explosions from the Manufacturing, Processing, and Handling of Combustible Particulate Solids”
- NFPA 655, “Prevention of Sulfur Fires and Explosions”
- NFPA 664, “Prevention of Fires and Explosions in Wood Processing and Woodworking Facilities”
- NFPA “Fire Protection Guide to Hazardous Materials”

**A-6.9.3.1.(2)(c) Carbon Monoxide Alarms.** Battery-powered carbon monoxide alarms are acceptable provided that they are mechanically fastened in place.



# **Part 7**

## **Plumbing Services**

<b>7.1.</b>	<b>General</b>	
7.1.1.	Scope .....	7-1
7.1.2.	Design and Installation .....	7-1
7.1.3.	Required Facilities .....	7-1
7.1.4.	Definitions .....	7-1
<b>7.2.</b>	<b>Objectives and Functional Statements</b>	
7.2.1.	Objectives and Functional Statements .....	7-1





# Part 7 Plumbing Services

## Section 7.1. General

### 7.1.1. Scope

#### 7.1.1.1. Scope

1) The scope of this Part shall be as described in Subsection 1.3.3. of Division A.

#### 7.1.1.2. Application

1) This Part applies to the design, construction, extension, *alteration*, renewal or repair of *plumbing systems*.

### 7.1.2. Design and Installation

#### 7.1.2.1. Conformance with Regulations or National Plumbing Code

1) Every *plumbing system* shall be designed and installed in conformance with appropriate provincial or territorial regulations or municipal bylaws, in the absence of such regulations or bylaws, in conformance with the NPC.

### 7.1.3. Required Facilities

#### 7.1.3.1. All Buildings Except Dwelling Units

1) *Buildings* shall be equipped with plumbing facilities as required in Subsection 3.7.2. and Article 3.8.2.8.

#### 7.1.3.2. Dwelling Units

1) *Dwelling units* shall be equipped with plumbing facilities as required in Section 9.31.

### 7.1.4. Definitions

#### 7.1.4.1. Defined Terms

1) Words that appear in italics are defined in Article 1.4.1.2. of Division A.

## Section 7.2. Objectives and Functional Statements

### 7.2.1. Objectives and Functional Statements

#### 7.2.1.1. Attributions to Acceptable Solutions

1) For the purpose of compliance with this Code as required in Clause 1.2.1.1.(1)(b) of Division A, the objectives and functional statements attributed to the acceptable solutions in this Part shall be the objectives and functional statements listed in Table 7.2.1.1. (See Note A-1.1.2.1.(1).)

**Table 7.2.1.1.**  
**Objectives and Functional Statements Attributed to the**  
**Acceptable Solutions in Part 7**  
 Forming Part of Sentence 7.2.1.1.(1)

Functional Statements and Objectives <sup>(1)</sup>	
<b>7.1.2.1. Conformance with Regulations or National Plumbing Code</b>	
(1)	[F30-OS3.1] [F31-OS3.2] [F43-OS3.4]
	[F70-OH2.2] [F72-OH2.1]

**Notes to Table 7.2.1.1.:**

(1) See Parts 2 and 3 of Division A.

# **Part 8**

## **Safety Measures at Construction and Demolition Sites**

<b>8.1.</b>	<b>General</b>	
8.1.1.	Scope .....	8-1
8.1.2.	Application .....	8-1
<b>8.2.</b>	<b>Protection of the Public</b>	
8.2.1.	Fencing and Barricades .....	8-1
8.2.2.	Excavation .....	8-2
8.2.3.	Use of Streets or Public Property ...	8-2
8.2.4.	Direction of Vehicular Traffic .....	8-3
8.2.5.	Waste Material .....	8-4
<b>8.3.</b>	<b>Objectives and Functional Statements</b>	
8.3.1.	Objectives and Functional Statements .....	8-4
	<b>Notes to Part 8 .....</b>	<b>8-7</b>



# **Part 8**

## **Safety Measures at Construction and Demolition Sites**

### **Section 8.1. General**

#### **8.1.1. Scope**

##### **8.1.1.1. Scope**

1) The scope of this Part shall be as described in Subsection 1.3.3. of Division A.

2) This Part applies to fire safety and the protection of the public during the construction, *alteration* or demolition of every *building*, including any incompleted or abandoned *building*.

3) Fire safety at construction and demolition sites shall conform to Section 5.6. of Division B of the NFC.

##### **8.1.1.2. Definitions**

1) Words that appear in italics are defined in Article 1.4.1.2. of Division A.

##### **8.1.1.3. Demolition Procedures**

1) Measures shall be taken during demolition to protect the public in conformance with Section 5.6. of Division B of the NFC.

#### **8.1.2. Application**

##### **8.1.2.1. Application**

1) Where a *building* is undergoing construction, *alteration* or demolition, measures shall be taken at the *building* site in conformance with this Code. (See Note A-8.1.2.1.(1).)

##### **8.1.2.2. Protection from Risk**

1) Precautions shall be taken to ensure that no person is exposed to undue risk.

### **Section 8.2. Protection of the Public**

#### **8.2.1. Fencing and Barricades**

##### **8.2.1.1. Covered Way Exceptions**

1) Where the construction may constitute a hazard to the public, work shall not commence on the construction, *alteration* or repair of a *building* until a covered way has been provided as described in Article 8.2.1.2. to protect the public, except where

- a) the work is done within a solid enclosure,
- b) the *building* is at a distance of 2 m or more from a *public way* used by pedestrians, or
- c) site conditions warrant a distance greater than provided in Clause (b).

##### **8.2.1.2. Covered Way Construction**

- 1) A covered way shall
  - a) have a clear height of not less than 2.5 m,

- b) have a clear width of not less than 1.5 m or the width of the *public way*, whichever is the lesser,
- c) be designed and constructed to support safely all loads that may be reasonably expected to be applied to it, but in no case less than 2.4 kPa on the roof,
- d) have a weathertight roof sloped towards the site or, if flat, be equipped with a splash board not less than 300 mm high on the *street side*,
- e) be totally enclosed on the site side with a structure having a reasonably smooth surface facing the *public way*,
- f) have a railing 1 070 mm high on the *street side* where the covered way is supported by posts on the *street side*, and
- g) be adequately lighted when the *public way* is lighted.

### 8.2.1.3. Fencing, Boarding or Barricades

**1)** When a construction or demolition activity may constitute a hazard to the public and is located 2 m or more from a *public way*, a strongly constructed fence, boarding or barricade not less than 1.8 m high shall be erected between the site and the *public way* or open sides of a construction site.

**2)** Barricades shall have a reasonably smooth surface facing the *public way* and shall be without openings, except those required for access.

- 3)** Access openings through barricades shall be equipped with gates that shall be
- a) kept closed and locked when the site is unattended, and
  - b) maintained in place until completion of the construction or demolition activity.

### 8.2.1.4. Special Hazards

**1)** Where any special hazard exists from which it is not possible to protect the public by other means, persons shall be employed to prevent the public from entering the danger zone at any time of the day or night.

### 8.2.1.5. Work Shutdown

**1)** When work on a construction site is suspended or ceases so that it will not be occupied during normal working hours, the hazardous part of the construction site shall be protected by

- a) covering all windows, doors and other openings located within 3 m of the ground which may give access to the *building* with a securely fastened barricade, or
- b) a fence or barricade constructed according to the requirements of Article 8.2.1.3.

## 8.2.2. Excavation

### 8.2.2.1. Water Removal

**1)** *Excavations* shall be kept reasonably clear of water.

### 8.2.2.2. Protection of Adjoining Property

**1)** If the stability of adjoining *buildings* may be endangered by the work of excavating, adequate underpinning, shoring and bracing shall be provided to prevent

- a) damage to, or movement of, any part of the adjoining *building*, and
- b) the creation of a hazard to the public.

## 8.2.3. Use of Streets or Public Property

### 8.2.3.1. Safe Passage Past Site

**1)** Except as provided in Article 8.2.3.2., provisions shall be made at all times for the safe passage of pedestrian and vehicular traffic past the site.

**2)** Material or equipment shall not be placed on any *street* or other public property except as authorized.

**3)** Except as provided in Sentence (4), where a sidewalk exists adjacent to the site it shall be kept clear of obstructions at all times.

**4)** Where construction operations necessitate the obstruction of a sidewalk, a temporary sidewalk shall be provided and it shall be kept clear of obstruction at all times.

**8.2.3.2. Overhead Activities**

**1)** Operations such as the hoisting of major components onto a tall *building* or other overhead activities that constitute a hazard to pedestrians below from which the public cannot be protected by barricades, covered ways or similar means shall not be carried out until the *street* or other *public way* is closed.

**8.2.3.3. Barricades**

- 1)** *Excavations* in *streets* or public property shall
  - a) be adequately barricaded, and
  - b) have warning signs or lights installed on each section of the barricades referred to in Clause (a).

**8.2.3.4. Restoration and Repair**

**1)** All sidewalks, *streets* or other public property that have been damaged shall be restored to a safe condition.

**2)** All obstructions on sidewalks, *streets* or other public property shall be removed when the need for such obstructions is ended.

**8.2.3.5. Warning Lights**

**1)** Warning lights shall be placed and shall be in operation during the hours of darkness at all obstructions on *streets* or other *public ways*.

**8.2.4. Direction of Vehicular Traffic**

**8.2.4.1. Hazards to Vehicular Traffic**

**1)** Where a hazard to vehicular traffic on a *public way* is created by work on a construction site, the following shall be provided to direct the traffic:

- a) one or more workers,
- b) warning signs,
- c) barriers,
- d) lane control devices, or
- e) flashing lights or flares located at a suitable distance from the hazard.

**8.2.4.2. Flags Used for Directing Traffic**

- 1)** A flag used to direct traffic shall be
  - a) red,
  - b) not less than 450 mm by 500 mm,
  - c) mounted on a staff not less than 1 m long, with the long side of the flag attached securely to the staff along its entire length, and
  - d) maintained in a clean and unturned condition when being used.

**8.2.4.3. Signs Used for Directing Traffic**

- 1)** A sign used to direct traffic shall be
  - a) diamond-shaped and of material not less rigid than 6 mm thick plywood,
  - b) not less than 450 mm by 450 mm in size and mounted at one corner on a substantial pole not less than 1.2 m long,
  - c) red on one side with black corner areas so that the red area is a regular 8-sided figure, and with the word "STOP" or "ARRÊT" in clearly

- distinguishable white letters not less than 150 mm high located centrally on the sign,
- d) yellow on the other side with the word “SLOW” or “LENTEMENT” in clearly distinguishable black letters not less than 150 mm high located centrally on the sign, or symbols recognized by the International Traffic Code, and
  - e) maintained in a clean condition when being used.

**8.2.4.4. Worker Directing Traffic**

- 1) A worker who is directing traffic shall
  - a) be equipped as required by Article 8.2.4.5.,
  - b) be instructed in the signals to be used in controlling traffic,
  - c) be provided with a copy of written instructions on the correct methods for traffic direction, and
  - d) direct traffic by using either a flag or sign.

**8.2.4.5. Clothing While Directing Traffic**

- 1) A worker while directing traffic shall wear the following clothing which shall be fluorescent and coloured either blaze orange or red:
  - a) a vest, or
  - b) sleeves that extend from above the elbow to the wrist.

**8.2.5. Waste Material****8.2.5.1. Control of Waste Material**

- 1) Waste material or other material shall not be permitted to fall freely from one storey to another.

**8.2.5.2. Removal of Waste Material**

- 1) Waste material shall be removed as quickly as possible by means of
  - a) appropriate containers,
  - b) an enclosed shaft or chute conforming to Sentence 8.2.5.4.(1), or
  - c) a hoisting apparatus if large pieces or objects are involved.

**8.2.5.3. Enclosures for Waste Material**

- 1) Waste material cleared as provided in Sentence 8.2.5.2.(1) shall be deposited in an enclosure
  - a) so arranged as to prevent waste material from being projected beyond the confines of the enclosure, and
  - b) not accessible to the public.

**8.2.5.4. Chutes for Waste Material**

- 1) The chute described in Clause 8.2.5.2.(1)(b) shall be closed if it is inclined more than 45° to the horizontal.

**Section 8.3. Objectives and Functional Statements****8.3.1. Objectives and Functional Statements****8.3.1.1. Attributions to Acceptable Solutions**

- 1) For the purpose of compliance with this Code as required in Clause 1.2.1.1.(1)(b) of Division A, the objectives and functional statements attributed to the acceptable solutions in this Part shall be the objectives and functional statements listed in Table 8.3.1.1. (See Note A-1.1.2.1.(1).)



**Table 8.3.1.1.**  
**Objectives and Functional Statements Attributed to the**  
**Acceptable Solutions in Part 8**  
 Forming Part of Sentence 8.3.1.1.(1)

Functional Statements and Objectives <sup>(1)</sup>	
<b>8.1.1.3. Demolition Procedures</b>	
(1)	[F01-OS1.1] [F30-OS5.1,OS5.3,OS5.8] [F34-OS5.5] [F31,F32,F43,F44-OS5.6]
<b>8.1.2.2. Protection from Risk</b>	
(1)	[F01-OS1.1] [F30-OS5.1,OS5.3,OS5.8] [F34-OS5.5] [F31,F32,F43,F44-OS5.6]
<b>8.2.1.2. Covered Way Construction</b>	
(1)	(a),(b),(d),(e),(f),(g) [F30-OS5.1,OS5.2] [F34-OS5.5] (c) [F20-OS5.7]
<b>8.2.1.3. Fencing, Boarding or Barricades</b>	
(1)	[F30-OS5.1,OS5.3,OS5.6] [F34-OS5.5]
(2)	[F34-OS5.5] [F30-OS5.3]
(3)	[F34-OS5.5]
<b>8.2.1.4. Special Hazards</b>	
(1)	[F34-OS5.5]
<b>8.2.1.5. Work Shutdown</b>	
(1)	[F34-OS5.5]
<b>8.2.2.1. Water Removal</b>	
(1)	[F60-OS5.8] [F60-OS5.4]
<b>8.2.2.2. Protection of Adjoining Property</b>	
(1)	(a) [F21-OP4.1] (b) [F21-OS5.8]
<b>8.2.3.1. Safe Passage Past Site</b>	
(1)	[F30-OS5.1,OS5.3,OS5.2]
(2)	[F30-OS5.3,OS5.2]
(3)	[F30-OS5.3,OS5.2]
(4)	[F30-OS5.3,OS5.2]
<b>8.2.3.2. Overhead Activities</b>	
(1)	[F30-OS5.1]
<b>8.2.3.3. Barricades</b>	
(1)	[F30-OS5.1,OS5.3,OS5.2] [F34-OS5.5]
<b>8.2.3.4. Restoration and Repair</b>	
(1)	[F30-OS5.3]
(2)	[F30-OS5.3,OS5.2]
<b>8.2.3.5. Warning Lights</b>	
(1)	[F30-OS5.3,OS5.2]
<b>8.2.4.1. Hazards to Vehicular Traffic</b>	
(1)	[F30-OS5.2]

**Table 8.3.1.1. (Continued)**

Functional Statements and Objectives <sup>(1)</sup>	
<b>8.2.4.2. Flags Used for Directing Traffic</b>	
(1)	[F30-OS5.2]
<b>8.2.4.3. Signs Used for Directing Traffic</b>	
(1)	[F30-OS5.2]
<b>8.2.4.4. Worker Directing Traffic</b>	
(1)	[F30-OS5.2]
<b>8.2.4.5. Clothing While Directing Traffic</b>	
(1)	[F30-OS5.2]
<b>8.2.5.1. Control of Waste Material</b>	
(1)	[F30-OS5.1]
<b>8.2.5.2. Removal of Waste Material</b>	
(1)	[F30-OS5.1,OS5.3]
<b>8.2.5.3. Enclosures for Waste Material</b>	
(1)	[F30-OS5.1,OS5.3] [F34-OS5.6]
<b>8.2.5.4. Chutes for Waste Material</b>	
(1)	[F30-OS5.1]

**Notes to Table 8.3.1.1.:**

(1) See Parts 2 and 3 of Division A.



# **Notes to Part 8 Safety Measures at Construction and Demolition Sites**

**A-8.1.2.1.(1) Application.** The use of streets or public property and vehicular traffic during construction or demolition is normally controlled by regulations of authorities other than the building department (e.g., police department).

---

These Notes are included for explanatory purposes only and do not form part of the requirements. The number that introduces each Note corresponds to the applicable requirement in this Part.



# Appendix C

## Climatic and Seismic Information for Building Design in Canada

### Introduction

The great diversity of climate in Canada has a considerable effect on the performance of buildings; consequently, building design must reflect this diversity. This Appendix briefly describes how climatic design values are computed and provides recommended design data for a number of cities, towns, and lesser populated locations. Through the use of such data, appropriate allowances can be made for climate variations in different localities of Canada and the National Building Code can be applied nationally.

The climatic design data presented in Table C-2 are based on weather observations collected by the Atmospheric Environment Service, Environment Canada. The data were researched and analyzed for the Canadian Commission on Building and Fire Codes by Environment Canada.

As it is not practical to list values for all municipalities in Canada, recommended climatic design values for locations not listed can be obtained by contacting the Atmospheric Environment Service, Environment Canada, 4905 Dufferin Street, Downsview, Ontario M3H 5T4, (416) 739-4365. It should be noted, however, that these recommended values may differ from the legal requirements set by provincial, territorial or municipal building authorities.

The information on seismic hazard in spectral format given in Table C-3 has been provided by the Geological Survey of Canada of Natural Resources Canada. Information for municipalities not listed can be obtained at [www.earthquakescanada.nrcan.gc.ca](http://www.earthquakescanada.nrcan.gc.ca) or by writing to the Geological Survey of Canada at 7 Observatory Crescent, Ottawa, Ontario K1A 0Y3, or at P.O. Box 6000, Sidney, B.C. V8L 4B2.

### General

The choice of climatic elements tabulated in this Appendix and the form in which they are expressed have been dictated largely by the requirements for specific values in several sections of this Code. These elements include the Ground Snow Loads, Wind Pressures, Design Temperatures, Heating Degree-Days, One-Day and 15-Minute Rainfalls, the Annual Total Precipitation values and Seismic Data. The following notes briefly explain the significance of these particular elements in building design, and indicate which weather observations were used and how they were analyzed to yield the required design values.

Table C-2 lists design weather recommendations and elevations for over 600 locations, which have been chosen based on a variety of reasons. Many incorporated cities and towns with significant populations are included unless located close to larger cities. For sparsely populated areas, many smaller towns and villages are listed. Other locations have been added to the list when the demand for climatic design recommendations at these sites has been significant. The named locations refer to the specific latitude and longitude defined by the Gazetteer of Canada (Natural Resources Canada), available from Publishing and Depository Services Canada, Public Works and Government Services Canada, Ottawa, Ontario K1A 0S5. The elevations are given in metres and refer to heights above sea level.

Almost all of the weather observations used in preparing Table C-2 were, of necessity, observed at inhabited locations. To estimate design values for arbitrary locations, the observed or computed values for the weather stations were mapped and interpolated appropriately. Where possible, adjustments have been applied for the influence of elevation and known topographical effects. Such influences include the tendency of cold air to collect in depressions, for precipitation to increase with elevation, and for generally stronger winds near large bodies of water. Elevations have been added to Table C-2 because of their potential to significantly influence climatic design values.

Since interpolation from the values in Table C-2 to other locations may not be valid due to local and other effects, Environment Canada will provide climatic design element recommendations for locations not listed

---

This information is included for explanatory purposes only and does not form part of the requirements.

in Table C-2. Local effects are particularly significant in mountainous areas, where the values apply only to populated valleys and not to the mountain slopes and high passes, where very different conditions are known to exist.

### Changing and Variable Climates

Climate is not static. At any location, weather and climatic conditions vary from season to season, year to year, and over longer time periods (climate cycles). This has always been the case. In fact, evidence is mounting that the climates of Canada are changing and will continue to change significantly into future. When estimating climatic design loads, this variability can be considered using appropriate statistical analysis, data records spanning sufficient periods, and meteorological judgement. The analysis generally assumes that the past climate will be representative of the future climate.

Past and ongoing modifications to atmospheric chemistry (from greenhouse gas emissions and land use changes) are expected to alter most climatic regimes in the future despite the success of the most ambitious greenhouse gas mitigation plans.<sup>(1)</sup> Some regions could see an increase in the frequency and intensity of many weather extremes, which will accelerate weathering processes. Consequently, many buildings will need to be designed, maintained and operated to adequately withstand ever changing climatic loads.

Similar to global trends, the last decade in Canada was noted as the warmest in instrumented record. Canada has warmed, on average, at almost twice the rate of the global average increase, while the western Arctic is warming at a rate that is unprecedented over the past 400 years.<sup>(1)</sup> Mounting evidence from Arctic communities indicates that rapid changes to climate in the North have resulted in melting permafrost and impacts from other climate changes have affected nearly every type of built structure. Furthermore, analyses of Canadian precipitation data shows that many regions of the country have, on average, also been tending towards wetter conditions.<sup>(1)</sup> In the United States, where the density of climate monitoring stations is greater, a number of studies have found an unambiguous upward trend in the frequency of heavy to extreme precipitation events, with these increases coincident with a general upward trend in the total amount of precipitation. Climate change model results, based on an ensemble of global climate models worldwide, project that future climate warming rates will be greatest in higher latitude countries such as Canada.<sup>(2)</sup>

### January Design Temperatures

A building and its heating system should be designed to maintain the inside temperature at some pre-determined level. To achieve this, it is necessary to know the most severe weather conditions under which the system will be expected to function satisfactorily. Failure to maintain the inside temperature at the pre-determined level will not usually be serious if the temperature drop is not great and if the duration is not long. The outside conditions used for design should, therefore, not be the most severe in many years, but should be the somewhat less severe conditions that are occasionally but not greatly exceeded.

The January design temperatures are based on an analysis of January air temperatures only. Wind and solar radiation also affect the inside temperature of most buildings and may need to be considered for energy-efficient design.

The January design temperature is defined as the lowest temperature at or below which only a certain small percentage of the hourly outside air temperatures in January occur. In the past, a total of 158 stations with records from all or part of the period 1951-66 formed the basis for calculation of the 2.5 and 1% January temperatures. Where necessary, the data were adjusted for consistency. Since most of the temperatures were observed at airports, design values for the core areas of large cities could be 1 or 2°C milder, although the values for the outlying areas are probably about the same as for the airports. No adjustments were made for this urban island heat effect. The design values for the next 20 to 30 years will probably differ from these tabulated values due to year-to-year climate variability and global climate change resulting from the impact of human activities on atmospheric chemistry.

The design temperatures were reviewed and updated using hourly temperature observations from 480 stations for a 25-year period up to 2006 with at least 8 years of complete data. These data are consistent with data shown for Canadian locations in the 2009 Handbook of Fundamentals<sup>(3)</sup> published by the American Society of Heating, Refrigerating, and Air-Conditioning Engineers (ASHRAE). The most recent 25 years of record were used to provide a balance between accounting for trends in the climate and the sampling variation owing to year-to-year variation. The 1% and 2.5% values used for the design conditions represent percentiles of the cumulative frequency distribution of hourly temperatures and correspond to January temperatures that are colder for 8 and 19 hours, respectively, on average over the long term.

The 2.5% January design temperature is the value ordinarily used in the design of heating systems. In special cases, when the control of inside temperature is more critical, the 1% value may be used. Other temperature-dependent climatic design parameters may be considered for future issues of this document.

### July Design Temperatures

A building and its cooling and dehumidifying system should be designed to maintain the inside temperature and humidity at certain pre-determined levels. To achieve this, it is necessary to know the most severe weather conditions under which the system is expected to function satisfactorily. Failure to maintain the inside temperature and humidity at the pre-determined levels will usually not be serious if the increases in temperature and humidity are not great and the duration is not long. The outside conditions used for design should, therefore, not be the most severe in many years, but should be the somewhat less severe conditions that are occasionally but not greatly exceeded.

The summer design temperatures in this Appendix are based on an analysis of July air temperatures and humidities. Wind and solar radiation also affect the inside temperature of most buildings and may, in some cases, be more important than the outside air temperature. More complete summer and winter design information can be obtained from Environment Canada.

The July design dry-bulb and wet-bulb temperatures were reviewed and updated using hourly temperature observations from 480 stations for a 25-year period up to 2006. These data are consistent with data shown for Canadian locations in the 2009 Handbook of Fundamentals<sup>(3)</sup> published by ASHRAE. As with January design temperatures, data from the most recent 25-year period were analyzed to reflect any recent climatic changes or variations. The 2.5% values used for the dry- and wet-bulb design conditions represent percentiles of the cumulative frequency distribution of hourly dry- and wet-bulb temperatures and correspond to July temperatures that are higher for 19 hours on average over the long term.

### Heating Degree-Days

The rate of consumption of fuel or energy required to keep the interior of a small building at 21°C when the outside air temperature is below 18°C is roughly proportional to the difference between 18°C and the outside temperature. Wind speed, solar radiation, the extent to which the building is exposed to these elements and the internal heat sources also affect the heat required and may have to be considered for energy-efficient design. For average conditions of wind, radiation, exposure, and internal sources, however, the proportionality with the temperature difference generally still holds.

Since the fuel required is also proportional to the duration of the cold weather, a convenient method of combining these elements of temperature and time is to add the differences between 18°C and the mean temperature for every day in the year when the mean temperature is below 18°C. It is assumed that no heat is required when the mean outside air temperature for the day is 18°C or higher.

Although more sophisticated computer simulations using other forms of weather data have now almost completely replaced degree-day-based calculation methods for estimating annual heating energy consumption, degree-days remain a useful indicator of relative severity of climate and can form the basis for certain climate-related Code requirements.

The degree-days below 18°C were compiled for 1300 stations for the 25-year period ending in 2006. This analysis period is consistent with the one used to derive the design temperatures described above and with the approach used by ASHRAE.<sup>(3)</sup>

A difference of only one Celsius degree in the mean annual temperature will cause a difference of 250 to 350 in the Celsius degree-days. Since differences of 0.5 of a Celsius degree in the mean annual temperature are quite likely to occur between two stations in the same town, heating degree-days cannot be relied on to an accuracy of less than about 100 degree-days.

Heating degree-day values for the core areas of larger cities can be 200 to 400 degree-days less (warmer) than for the surrounding fringe areas. The observed degree-days, which are based on daily temperature observations, are often most representative of rural settings or the fringe areas of cities.

### Climatic Data for Energy Consumption Calculations

The climatic elements tabulated in this Appendix represent commonly used design values but do not include detailed climatic profiles, such as hourly weather data. Where hourly values of weather data are needed for the purpose of simulating the annual energy consumption of a building, they can be obtained from multiple sources, such as Environment Canada, Natural Resources Canada, the Regional Conservation Authority and

other such public agencies that record this information. Hourly weather data are also available from public and private agencies that format this information for use with annual energy consumption simulation software; in some cases, these data have been incorporated into the software.

### Snow Loads

The roof of a building should be able to support the greatest weight of snow that is likely to accumulate on it in many years. Some observations of snow on roofs have been made in Canada, but not enough to form the basis for estimating roof snow loads throughout the country. Similarly, observations of the weight, or water equivalent, of the snow on the ground have not been available in digital form in the past. The observations of roof loads and water equivalents are very useful, as noted below, but the measured depth of snow on the ground is used to provide the basic information for a consistent set of snow loads.

The estimation of the design snow load on a roof from snow depth observations involves the following steps:

1. The depth of snow on the ground, which has an annual probability of exceedance of 1-in-50, is computed.
2. The appropriate unit weight is selected and used to convert snow depth to loads,  $S_s$ .
3. The load,  $S_r$ , which is due to rain falling on the snow, is computed.
4. Because the accumulation of snow on roofs is often different from that on the ground, adjustments are applied to the ground snow load to provide a design snow load on a roof.

The annual maximum depth of snow on the ground has been assembled for 1618 stations for which data has been recorded by the Atmospheric Environment Service (AES). The period of record used varied from station to station, ranging from 7 to 38 years. These data were analyzed using a Gumbel extreme value distribution fitted using the method of moments<sup>(4)</sup> as reported by Newark et al.<sup>(5)</sup> The resulting values are the snow depths, which have a probability of 1-in-50 of being exceeded in any one year.

The unit weight of old snow generally ranges from 2 to 5 kN/m<sup>3</sup>, and it is usually assumed in Canada that 1 kN/m<sup>3</sup> is the average for new snow. Average unit weights of the seasonal snow pack have been derived for different regions across the country<sup>(6)</sup> and an appropriate value has been assigned to each weather station. Typically, the values average 2.01 kN/m<sup>3</sup> east of the continental divide (except for 2.94 kN/m<sup>3</sup> north of the treeline), and range from 2.55 to 4.21 kN/m<sup>3</sup> west of the divide. The product of the 1-in-50 snow depth and the average unit weight of the seasonal snow pack at a station is converted to the snow load (SL) in units of kilopascals (kPa).

Except for the mountainous areas of western Canada, the values of the ground snow load at AES stations were normalized assuming a linear variation of the load above sea level in order to account for the effects of topography. They were then smoothed using an uncertainty-weighted moving-area average in order to minimize the uncertainty due to snow depth sampling errors and site-specific variations. Interpolation from analyzed maps of the smooth normalized values yielded a value for each location in Table C-2, which could then be converted to the listed code values ( $S_s$ ) by means of an equation in the form:

$$S_s = \text{smooth normalized SL} + bZ$$

where  $b$  is the assumed rate of change of SL with elevation at the location and  $Z$  is the location's elevation above mean sea level (MSL). Although they are listed in Table C-2 to the nearest tenth of a kilopascal, values of  $S_s$  typically have an uncertainty of about 20%. Areas of sparse data in northern Canada were an exception to this procedure. In these regions, an analysis was made of the basic SL values. The effects of topography, variations due to local climates, and smoothing were all subjectively assessed. The values derived in this fashion were used to modify those derived objectively.

For the mountainous areas of British Columbia, Yukon, and the foothills area of Alberta, a more complex procedure was required to account for the variation of loads with terrain and elevation. Since the AES observational network often does not have sufficient coverage to detail this variability in mountainous areas, additional snow course observations were obtained from the provincial and territorial governments of British Columbia, Yukon, and Alberta. The additional data allowed detailed local analysis of ground snow loads on a valley-by-valley basis. Similar to other studies, the data indicated that snow loads above a critical or reference level increased according to either a linear or quadratic relation with elevation. The determination of whether the increase with elevation was linear or quadratic, the rate of the increase and the critical or reference elevation were found to be specific to the valley and mountain ranges considered. At valley levels below the critical elevation, the loads generally varied less significantly with elevation. Calculated valley- and range-specific regression relations were then used to describe the increase of load with elevation and to normalize the AES snow observations to a critical or reference level. These normalized values were smoothed using a weighted moving-average.



Tabulated values cannot be expected to indicate all the local differences in  $S_s$ . For this reason, especially in complex terrain areas, values should not be interpolated from Table C-2 for unlisted locations. The values of  $S_s$  in the Table apply for the elevation and the latitude and longitude of the location, as defined by the Gazetteer of Canada. Values at other locations can be obtained from Environment Canada.

The heaviest loads frequently occur when the snow is wetted by rain, thus the rain load,  $S_r$ , was estimated to the nearest 0.1 kPa and is provided in Table C-2. When values of  $S_r$  are added to  $S_s$ , this provides a 1-in-50-year estimate of the combined ground snow and rain load. The values of  $S_r$  are based on an analysis of about 2100 weather station values of the 1-in-50-year one-day maximum rain amount. This return period is appropriate because the rain amounts correspond approximately to the joint frequency of occurrence of the one-day rain on maximum snow packs. For the purpose of estimating rain on snow, the individual observed one-day rain amounts were constrained to be less than or equal to the snow pack water equivalent, which was estimated by a snow pack accumulation model reported by Bruce and Clark.<sup>(7)</sup>

The results from surveys of snow loads on roofs indicate that average roof loads are generally less than loads on the ground. The conditions under which the design snow load on the roof may be taken as a percentage of the ground snow load are given in Subsection 4.1.6. The Code also permits further decreases in design snow loads for steeply sloping roofs, but requires substantial increases for roofs where snow accumulation may be more rapid due to such factors as drifting. Recommended adjustments are given in the “User’s Guide – NBC 2015, Structural Commentaries (Part 4 of Division B).”

The ground snow load values,  $S_s$ , were updated for the 2015 edition of the Code using a similar approach to the one used for the ground snow load update in the 1990 edition. The Gumbel extreme value distribution was fitted to the annual maxima of daily snow depth observations made at over 1400 weather stations, which were compiled from 1990 onward—to as recently as 2012 for some stations—to calculate the 50-year return period snow depth. The 50-year ground snow load was then calculated for each weather station by combining the 50-year snow pack depth with the assigned snow pack density. The  $S_s$  values for each location in Table C-2 were compared with the updated weather station values and revised accordingly. As a result,  $S_s$  values remain unchanged for about 84% of the locations, have increased for 11% of the locations, and have decreased for 4% of the locations. The greatest proportion of increases was for locations in the Yukon, Northwest Territories, and Nunavut.

### Annual Total Precipitation

Total precipitation is the sum in millimetres of the measured depth of rainwater and the estimated or measured water equivalent of the snow (typically estimated as 0.1 of the measured depth of snow, since the average density of fresh snow is about 0.1 that of water).

The average annual total precipitation amounts in Table C-2 have been interpolated from an analysis of precipitation observations from 1379 stations for the 30-year period from 1961 to 1990.

### Annual Rainfall

The total amount of rain that normally falls in one year is frequently used as a general indication of the wetness of a climate, and is therefore included in this Appendix. See also Moisture Index below.

### Rainfall Intensity

Roof drainage systems are designed to carry off rainwater from the most intense rainfall that is likely to occur. A certain amount of time is required for the rainwater to flow across and down the roof before it enters the gutter or drainage system. This results in the smoothing out of the most rapid changes in rainfall intensity. The drainage system, therefore, need only cope with the flow of rainwater produced by the average rainfall intensity over a period of a few minutes, which can be called the concentration time.

In Canada, it has been customary to use the 15-minute rainfall that will probably be exceeded on an average of once in 10 years. The concentration time for small roofs is much less than 15 minutes and hence the design intensity will be exceeded more frequently than once in 10 years. The safety factors in the NPC will probably reduce the frequency to a reasonable value and, in addition, the occasional failure of a roof drainage system will not be particularly serious in most cases.

The rainfall intensity values were updated for the 2010 edition of the Code using observations of annual maximum 15-minute rainfall amounts from 485 stations with 10 or more years of record, including data up to 2007 for some stations. Ten-year return period values—the 15-minute rainfall having a probability of 1-in-10 of being exceeded in any year— were calculated by fitting the annual maximum values to the Gumbel extreme value distribution<sup>(4)</sup> using the method of moments. The updated values are compiled from

the most recent short-duration rainfall intensity-duration-frequency (IDF) graphs and tables available from Environment Canada.

It is very difficult to estimate the pattern of rainfall intensity in mountainous areas, where precipitation is extremely variable and rainfall intensity can be much greater than in other types of areas. Many of the observations for these areas were taken at locations in valley bottoms or in extensive, fairly level areas.

### **One-Day Rainfall**

If for any reason a roof drainage system becomes ineffective, the accumulation of rainwater may be great enough in some cases to cause a significant increase in the load on the roof. In previous editions of this information, it had been common practice to use the maximum one-day rainfall ever observed for estimating the additional load. Since the length of record for weather stations in Canada is quite variable, the maximum one-day rainfall amounts in previous editions often reflected the variable length of record at nearby stations as much as the climatology. As a result, the maximum values often differed greatly within relatively small areas where little difference should be expected. The current values have been standardized to represent the one-day rainfall amounts that have 1 chance in 50 of being exceeded in any one year or the 1-in-50-year return value one-day rainfalls.

The one-day rainfall values were updated using daily rainfall observations from more than 3500 stations with 10 years or more of record, including data up to 2008 for some stations. The 50-year return period values were calculated by fitting the annual maximum one-day rainfall observations to the Gumbel extreme value distribution using the method of moments.<sup>(4)</sup>

Rainfall frequency observations can vary considerably over time and space. This is especially true for mountainous areas, where elevation effects can be significant. In other areas, small-scale intense storms or local influences can produce significant spatial variability in the data. As a result, the analysis incorporates some spatial smoothing.

### **Moisture Index (MI)**

Moisture index (MI) values were developed through the work of a consortium that included representatives from industry and researchers from NRC.<sup>(1)</sup> The MI is an indicator of the moisture load imposed on a building by the climate and is used in Part 9 to define the minimum levels of protection from precipitation to be provided by cladding assemblies on exterior walls.

It must be noted, in using MI values to determine the appropriate levels of protection from precipitation, that weather conditions can vary markedly within a relatively small geographical area. Although the values provided in the Table give a good indication of the average conditions within a particular region, some caution must be exercised when applying them to a locality that is outside the region where the weather station is located.

MI is calculated from a wetting index (WI) and a drying index (DI).

### **Wetting Index (WI)**

To define, quantitatively, the rainwater load on a wall, wind speed and wind direction have to be taken into consideration in addition to rainfall, along with factors that can affect exposure, such as nearby buildings, vegetation and topography. Quantitative determination of load, including wind speed and wind direction, can be done. However, due to limited weather data, it is not currently possible to provide this information for most of the locations identified in the Table.

This lack of information, however, has been shown to be non-critical for the purpose of classifying locations in terms of severity of rain load. The results of the research indicated that simple annual rainfall is as good an indicator as any for describing rainwater load. That is to say, for Canadian locations, and especially once drying is accounted for, the additional sensitivity provided by hourly directional rainfall values does not have a significant effect on the order in which locations appear when listed from wet to dry.

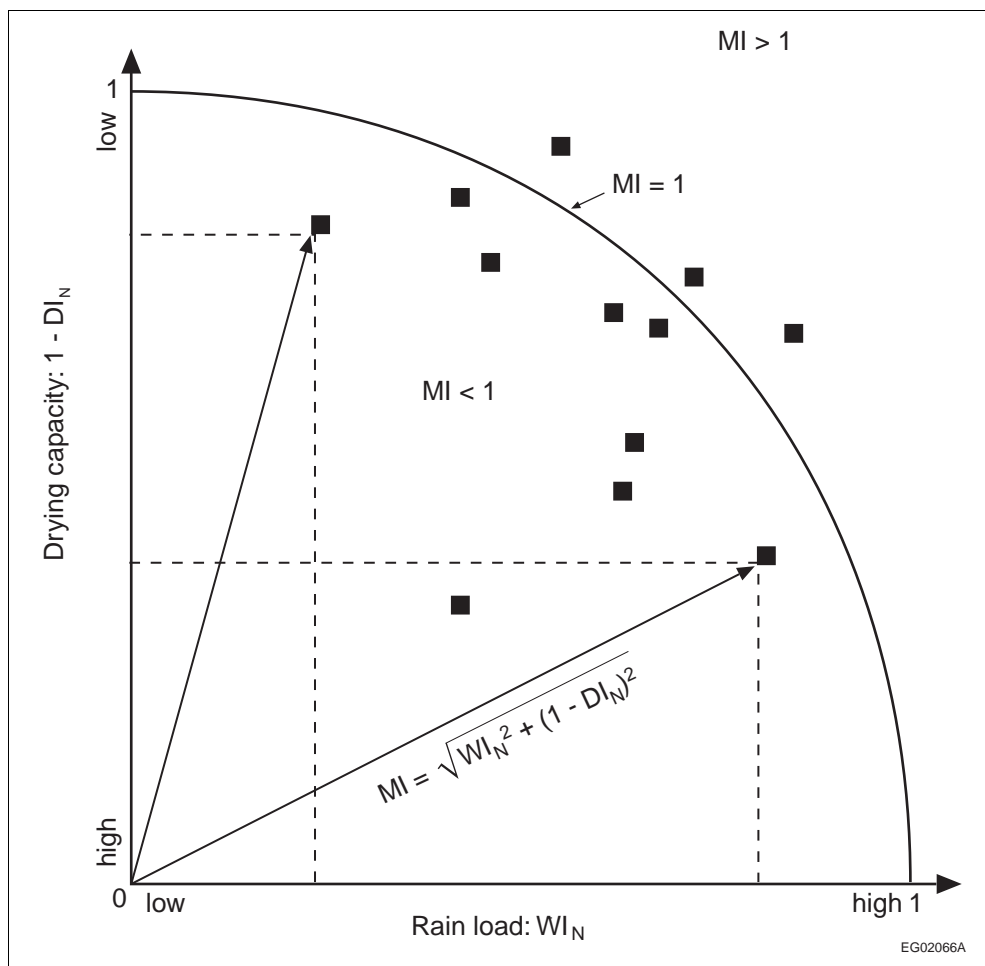
Consequently, the wetting index (WI) is based on annual rainfall and is normalized based on 1000 mm.

### **Drying Index (DI)**

Temperature and relative humidity together define the drying capacity of ambient air. Based on simple psychrometrics, values were derived for the locations listed in the Table using annual average drying capacity normalized based on the drying capacity at Lytton, B.C. The resultant values are referred to as drying indices (DI).

**Determination of Moisture Index (MI)**

The relationship between WI and DI to correctly define moisture loading on a wall is not known. The MI values provided in the Table are based on the root mean square values of WI and 1-DI, with those values equally weighted. This is illustrated in Figure C-1. The resultant MI values are sufficiently consistent with industry's understanding of climate severity with respect to moisture loading as to allow limits to be identified for the purpose of specifying where additional protection from precipitation is required.



**Figure C-1**  
**Derivation of moisture index (MI) based on normalized values for wetting index (WI) and drying index (DI)**

**Note to Figure C-1:**

- (1) MI equals the hypotenuse of the triangle defined by  $WI_N$  and  $1 - DI_N$

**Driving Rain Wind Pressure (DRWP)**

The presence of rainwater on the face of a building, with or without wind, must be addressed in the design and construction of the building envelope so as to minimize the entry of water into the assembly. Wind pressure on the windward faces of a building will promote the flow of water through any open joints or cracks in the facade.

Driving rain wind pressure (DRWP) is the wind load that is coincident with rain, measured or calculated at a height of 10 m. The values provided in the Table represent the loads for which there is 1 chance in 5 of being reached or exceeded in any one year, or a probability of 20% within any one year. Approximate adjustments for height can be made using the values for  $C_e$  given in Sentence 4.1.7.3.(5) as a multiplier.

Because of inaccuracies in developing the DRWP values related to the averaging of extreme wind pressures, the actual heights of recording anemometers, and the use of estimated rather than measured rainfall values, the values are considered to be higher than actual loads.<sup>(8)(9)</sup> Thus the actual probability of reaching or exceeding the DRWP in a particular location is less than 20% per year and these values can be considered to be conservative.

DRWP can be used to determine the height to which wind will drive rainwater up enclosed vertical conduits. This provides a conservative estimate of the height needed for fins in window extrusions and end dams on flashings to control water ingress. This height can be calculated as:

$$\text{height of water, mm} = \text{DRWP}/10, \text{ Pa}$$

Note that the pressure difference across the building envelope may be augmented by internal pressures induced in the building interior by the wind. These additional pressures can be estimated using the information provided in the Commentary entitled *Wind Load and Effects of the “User’s Guide – NBC 2015, Structural Commentaries (Part 4 of Division B).”*

### Wind Effects

All structures need to be designed to ensure that the main structural system and all secondary components, such as cladding and appurtenances, will withstand the pressures and suction caused by the strongest wind likely to blow at that location in many years. Some flexible structures, such as tall buildings, slender towers and bridges, also need to be designed to minimize excessive wind-induced oscillations or vibrations.

At any time, the wind acting upon a structure can be treated as a mean or time-averaged component and as a gust or unsteady component. For a small structure, which is completely enveloped by wind gusts, it is only the peak gust velocity that needs to be considered. For a large structure, the wind gusts are not well correlated over its different parts and the effects of individual gusts become less significant. The “User’s Guide – NBC 2015, Structural Commentaries (Part 4 of Division B)” evaluates the mean pressure acting on a structure, provide appropriate adjustments for building height and exposure and for the influence of the surrounding terrain and topography (including wind speed-up for hills), and then incorporate the effects of wind gusts by means of the gust factor, which varies according to the type of structure and the size of the area over which the pressure acts.

The wind speeds and corresponding velocity pressures used in the Code are regionally representative or reference values. The reference wind speeds are nominal one-hour averages of wind speeds representative of the 10 m height in flat open terrain corresponding to Exposure A or open terrain in the terminology of the “User’s Guide – NBC 2015, Structural Commentaries (Part 4 of Division B).” The reference wind speeds and wind velocity pressures are based on long-term wind records observed at a large number of weather stations across Canada.

Reference wind velocity pressures in previous versions of the Code since 1961 were based mostly on records of hourly averaged wind speeds (i.e. the number of miles of wind passing an anemometer in an hour) from over 100 stations with 10 to 22 years of observations ending in the 1950s. The wind pressure values derived from these measurements represented true hourly wind pressures.

The reference wind velocity pressures were reviewed and updated for the 2010 edition of the Code. The primary data set used for the analysis comprised wind records compiled from about 135 stations with hourly averaged wind speeds and from 465 stations with aviation (one- or two-minute average) speeds or surface weather (ten-minute average) speeds observed once per hour at the top of the hour; the periods of record used ranged from 10 to 54 years. In addition, peak wind gust records from 400 stations with periods of record ranging from 10 to 43 years were used. Peak wind gusts (gust durations of approximately 3 to 7 seconds) were used to supplement the primary once-per-hour observations in the analysis.

Several steps were involved in updating the reference wind values. Where needed, speeds were adjusted to represent the standard anemometer height above ground of 10 m. The data from years when the anemometer at a station was installed on the top of a lighthouse or building were eliminated from the analysis since it is impractical to adjust for the effects of wind flow over the structure. (Most anemometers were moved to 10 m towers by the 1960s.) Wind speeds of the various observation types—hourly averaged, aviation, surface weather and peak wind gust—were adjusted to account for different measure durations to represent a one-hour averaging period and to account for differences in the surface roughness of flat open terrain at observing stations.

The annual maximum wind speed data was fitted to the Gumbel distribution using the method of moments<sup>(4)</sup> to calculate hourly wind speeds having the annual probability of occurrence of 1-in-10 and 1-in-50 (10-year and 50-year return periods). The values were plotted on maps, then analyzed and abstracted for the locations in Table C-2.

The wind velocity pressures,  $q$ , were calculated in Pascals using the following equation:

$$q = \frac{1}{2} \rho V^2$$

where  $\rho$  is an average air density for the windy months of the year and  $V$  is wind speed in metres per second. While air density depends on both air temperature and atmospheric pressure, the density of dry air at 0°C and standard atmospheric pressure of 1.2929 kg/m<sup>3</sup> was used as an average value for the wind pressure calculations. As explained by Boyd<sup>(10)</sup>, this value is within 10% of the monthly average air densities for most of Canada in the windy part of the year.

As a result of the updating procedure, the 1-in-50 reference wind velocity pressures remain unchanged for most of the locations listed in Table C-2; both increases and decreases were noted for the remaining locations. Many of the decreases resulted from the fact that anemometers at most of the stations used in the previous analysis were installed on lighthouses, airport hangers and other structures. Wind speeds on the tops of buildings are often much higher compared to those registered by a standard 10 m tower. Eliminating anemometer data recorded on the tops of buildings from the analysis resulted in lower values at several locations.

Hourly wind speeds that have 1 chance in 10 and 50\* of being exceeded in any one year were analyzed using the Gumbel extreme value distribution fitted using the method of moments with correction for sample size. Values of the 1-in-30-year wind speeds for locations in the Table were estimated from a mapping analysis of wind speeds. The 1-in-10- and 1-in-50-year speeds were then computed from the 1-in-30-year speeds using a map of the dispersion parameter that occurs in the Gumbel analysis.<sup>(4)</sup>

Table C-1 has been arranged to give pressures to the nearest one-hundredth of a kPa and their corresponding wind speeds. The value of “ $q$ ” in kPa is assumed to be equal to 0.00064645  $V^2$ , where  $V$  is given in m/s.

---

\* Wind speeds that have a one-in-“ $n$ ”-year chance of being exceeded in any year can be computed from the one-in-10 and one-in-50 return values in the Table using the following equation:

$$V_{1/n} = \frac{1}{1.4565} \left\{ V_{1/50} + 0.4565 V_{1/10} + \frac{V_{1/50} - V_{1/10}}{1.1339} \times \ln \frac{-0.0339}{\ln(1 - 1/n)} \right\}$$

**Table C-1  
Wind Speeds**

q kPa	V m/s	q kPa	V m/s	q kPa	V m/s	q kPa	V m/s
0.15	15.2	0.53	28.6	0.91	37.5	1.29	44.7
0.16	15.7	0.54	28.9	0.92	37.7	1.30	44.8
0.17	16.2	0.55	29.2	0.93	37.9	1.31	45.0
0.18	16.7	0.56	29.4	0.94	38.1	1.32	45.2
0.19	17.1	0.57	29.7	0.95	38.3	1.33	45.4
0.20	17.6	0.58	30.0	0.96	38.5	1.34	45.5
0.21	18.0	0.59	30.2	0.97	38.7	1.35	45.7
0.22	18.4	0.60	30.5	0.98	38.9	1.36	45.9
0.23	18.9	0.61	30.7	0.99	39.1	1.37	46.0
0.24	19.3	0.62	31.0	1.00	39.3	1.38	46.2
0.25	19.7	0.63	31.2	1.01	39.5	1.39	46.4
0.26	20.1	0.64	31.5	1.02	39.7	1.40	46.5
0.27	20.4	0.65	31.7	1.03	39.9	1.41	46.7
0.28	20.8	0.66	32.0	1.04	40.1	1.42	46.9
0.29	21.2	0.67	32.2	1.05	40.3	1.43	47.0
0.30	21.5	0.68	32.4	1.06	40.5	1.44	47.2
0.31	21.9	0.69	32.7	1.07	40.7	1.45	47.4
0.32	22.2	0.70	32.9	1.08	40.9	1.46	47.5
0.33	22.6	0.71	33.1	1.09	41.1	1.47	47.7
0.34	22.9	0.72	33.4	1.10	41.3	1.48	47.8
0.35	23.3	0.73	33.6	1.11	41.4	1.49	48.0
0.36	23.6	0.74	33.8	1.12	41.6	1.50	48.2
0.37	23.9	0.75	34.1	1.13	41.8	1.51	48.3
0.38	24.2	0.76	34.3	1.14	42.0	1.52	48.5
0.39	24.6	0.77	34.5	1.15	42.2	1.53	48.6
0.40	24.9	0.78	34.7	1.16	42.4	1.54	48.8
0.41	25.2	0.79	35.0	1.17	42.5	1.55	49.0
0.42	25.5	0.80	35.2	1.18	42.7	1.56	49.1
0.43	25.8	0.81	35.4	1.19	42.9	1.57	49.3
0.44	26.1	0.82	35.6	1.20	43.1	1.58	49.4
0.45	26.4	0.83	35.8	1.21	43.3	1.59	49.6
0.46	26.7	0.84	36.0	1.22	43.4	1.60	49.7
0.47	27.0	0.85	36.3	1.23	43.6	1.61	49.9
0.48	27.2	0.86	36.5	1.24	43.8	1.62	50.1
0.49	27.5	0.87	36.7	1.25	44.0	1.63	50.2
0.50	27.8	0.88	36.9	1.26	44.1	1.64	50.4
0.51	28.1	0.89	37.1	1.27	44.3	1.65	50.5
0.52	28.4	0.90	37.3	1.28	44.5	1.66	50.7

Copyright © NRC 1941 - 2021 World Rights Reserved © CNRC 1941-2021 Droits réservés pour tous pays

**Table C-2  
Climatic Design Data for Selected Locations in Canada**

Province and Location	Elev., m	Design Temperature				De- gree- Days Below 18°C	15 Min. Rain, mm	One Day Rain, 1/50, mm	Ann. Rain, mm	Moist. Index	Ann. Tot. Ppn., mm	Driv- ing Rain Wind Pres- sures, Pa, 1/5	Snow Load, kPa, 1/50		Hourly Wind Pressures, kPa	
		January		July 2.5%									S <sub>s</sub>	S <sub>t</sub>	1/10	1/50
		2.5% °C	1% °C	Dry °C	Wet °C											
<b>British Columbia</b>																
100 Mile House	1040	-30	-32	29	17	5030	10	48	300	0.44	425	60	2.6	0.3	0.27	0.35
Abbotsford	70	-8	-10	29	20	2860	12	112	1525	1.59	1600	160	2.0	0.3	0.34	0.44
Agassiz	15	-9	-11	31	21	2750	8	128	1650	1.71	1700	160	2.4	0.7	0.36	0.47
Alberni	12	-5	-8	31	19	3100	10	144	1900	2.00	2000	220	2.6	0.4	0.25	0.32
Ashcroft	305	-24	-27	34	20	3700	10	37	250	0.25	300	80	1.7	0.1	0.29	0.38
Bamfield	20	-2	-4	23	17	3080	13	170	2870	2.96	2890	280	1.0	0.4	0.39	0.50
Beaton River	840	-37	-39	26	18	6300	15	64	330	0.53	450	80	3.3	0.1	0.23	0.30
Bella Bella	25	-5	-7	23	18	3180	13	145	2715	2.82	2800	350	2.6	0.8	0.39	0.50
Bella Coola	40	-14	-18	27	19	3560	10	140	1500	1.85	1700	350	4.5	0.8	0.30	0.39
Burns Lake	755	-31	-34	26	17	5450	12	54	300	0.56	450	100	3.4	0.2	0.30	0.39
Cache Creek	455	-24	-27	34	20	3700	10	37	250	0.25	300	80	1.7	0.2	0.30	0.39
Campbell River	20	-5	-7	26	18	3000	10	116	1500	1.59	1600	260	2.8	0.4	0.40	0.52
Carmi	845	-24	-26	31	19	4750	10	64	325	0.38	550	60	3.6	0.2	0.29	0.38
Castlegar	430	-18	-20	32	20	3580	10	54	560	0.64	700	60	4.2	0.1	0.27	0.34
Chetwynd	605	-35	-38	27	18	5500	15	70	400	0.58	625	60	2.4	0.2	0.31	0.40
Chilliwack	10	-9	-11	30	20	2780	8	139	1625	1.68	1700	160	2.2	0.3	0.36	0.47
Comox	15	-7	-9	27	18	3100	10	106	1175	1.28	1200	260	2.4	0.4	0.40	0.52
Courtenay	10	-7	-9	28	18	3100	10	106	1400	1.49	1450	260	2.4	0.4	0.40	0.52
Cranbrook	910	-26	-28	32	18	4400	12	59	275	0.30	400	100	3.0	0.2	0.25	0.33
Crescent Valley	585	-18	-20	31	20	3650	10	54	675	0.75	850	80	4.2	0.1	0.25	0.33
Crofton	5	-4	-6	28	19	2880	8	86	925	1.06	950	160	1.8	0.2	0.31	0.40
Dawson Creek	665	-38	-40	27	18	5900	18	75	325	0.49	475	100	2.5	0.2	0.31	0.40
Dease Lake	800	-37	-40	24	15	6730	10	45	265	0.55	425	380	2.8	0.1	0.23	0.30
Dog Creek	450	-28	-30	29	17	4800	10	48	275	0.41	375	100	1.8	0.2	0.27	0.35
Duncan	10	-6	-8	28	19	2980	8	103	1000	1.13	1050	180	1.8	0.4	0.30	0.39
Elko	1065	-28	-31	30	19	4600	13	64	440	0.48	650	100	3.6	0.2	0.31	0.40
Fernie	1010	-27	-30	30	19	4750	13	118	860	0.88	1175	100	4.5	0.2	0.31	0.40
Fort Nelson	465	-39	-42	28	18	6710	15	70	325	0.56	450	80	2.4	0.1	0.23	0.30
Fort St. John	685	-35	-37	26	18	5750	15	72	320	0.50	475	100	2.8	0.1	0.30	0.39
Glacier	1145	-27	-30	27	17	5800	10	70	625	0.83	1500	80	9.4	0.2	0.25	0.32
Gold River	120	-8	-11	31	18	3230	13	200	2730	2.80	2850	250	2.8	0.6	0.25	0.32
Golden	790	-27	-30	30	17	4750	10	55	325	0.57	500	100	3.7	0.2	0.27	0.35
Grand Forks	565	-19	-22	34	20	3820	10	48	390	0.47	475	80	2.8	0.1	0.31	0.40
Greenwood	745	-20	-23	34	20	4100	10	64	430	0.51	550	80	3.6	0.1	0.31	0.40
Hope	40	-13	-15	31	20	3000	8	139	1825	1.88	1900	140	2.8	0.7	0.48	0.63
Jordan River	20	-1	-3	22	17	2900	12	170	2300	2.37	2370	250	1.2	0.4	0.43	0.55
Kamloops	355	-23	-25	34	20	3450	13	42	225	0.23	275	80	1.8	0.2	0.31	0.40
Kaslo	545	-17	-20	30	19	3830	10	55	660	0.82	850	80	2.8	0.1	0.24	0.31

Table C-2 (Continued)

Province and Location	Elev., m	Design Temperature				De- gree- Days Below 18°C	15 Min. Rain, mm	One Day Rain, 1/50, mm	Ann. Rain, mm	Moist. Index	Ann. Tot. Ppn., mm	Driv- ing Rain Wind Pres- sures, Pa, 1/5	Snow Load, kPa, 1/50		Hourly Wind Pressures, kPa	
		January		July 2.5%									S <sub>s</sub>	S <sub>r</sub>	1/10	1/50
		2.5% °C	1% °C	Dry °C	Wet °C											
Kelowna	350	-17	-20	33	20	3400	12	43	260	0.29	325	80	1.7	0.1	0.31	0.40
Kimberley	1090	-25	-27	31	18	4650	12	59	350	0.38	500	100	3.0	0.2	0.25	0.33
Kitimat Plant	15	-16	-18	25	16	3750	13	193	2100	2.19	2500	220	5.5	0.8	0.37	0.48
Kitimat Townsite	130	-16	-18	24	16	3900	13	171	1900	2.00	2300	220	6.5	0.8	0.37	0.48
Ladysmith	80	-7	-9	27	19	3000	8	97	1075	1.20	1160	180	2.4	0.4	0.31	0.40
Langford	80	-4	-6	27	19	2750	9	135	1095	1.22	1125	220	1.8	0.3	0.31	0.40
Lillooet	245	-21	-23	34	20	3400	10	70	300	0.31	350	100	2.1	0.1	0.34	0.44
Lytton	325	-17	-20	35	20	3300	10	70	330	0.33	425	80	2.8	0.3	0.33	0.43
Mackenzie	765	-34	-38	27	17	5550	10	50	350	0.54	650	60	5.1	0.2	0.25	0.32
Masset	10	-5	-7	17	15	3700	13	80	1350	1.54	1400	400	1.8	0.4	0.48	0.61
McBride	730	-29	-32	29	18	4980	13	54	475	0.64	650	60	4.3	0.2	0.27	0.35
McLeod Lake	695	-35	-37	27	17	5450	10	50	350	0.54	650	60	4.1	0.2	0.25	0.32
Merritt	570	-24	-27	34	20	3900	8	54	240	0.24	310	80	1.8	0.3	0.34	0.44
Mission City	45	-9	-11	30	20	2850	13	123	1650	1.71	1700	160	2.4	0.3	0.33	0.43
Montrose	615	-16	-18	32	20	3600	10	54	480	0.56	700	60	4.1	0.1	0.27	0.35
Nakusp	445	-20	-22	31	20	3560	10	60	650	0.78	850	60	4.4	0.1	0.25	0.33
Nanaimo	15	-6	-8	27	19	3000	10	91	1000	1.13	1050	200	2.1	0.4	0.39	0.50
Nelson	600	-18	-20	31	20	3500	10	59	460	0.57	700	60	4.2	0.1	0.25	0.33
Ocean Falls	10	-10	-12	23	17	3400	13	260	4150	4.21	4300	350	3.9	0.8	0.46	0.59
Osoyoos	285	-14	-17	35	21	3100	10	48	275	0.28	310	60	1.1	0.1	0.31	0.40
Parksville	40	-6	-8	26	19	3200	10	91	1200	1.31	1250	200	2.0	0.4	0.39	0.50
Penticton	350	-15	-17	33	20	3350	10	48	275	0.28	300	60	1.3	0.1	0.35	0.45
Port Alberni	15	-5	-8	31	19	3100	10	161	1900	2.00	2000	240	2.6	0.4	0.25	0.32
Port Alice	25	-3	-6	26	17	3010	13	200	3300	3.38	3340	220	1.1	0.4	0.25	0.32
Port Hardy	5	-5	-7	20	16	3440	13	150	1775	1.92	1850	220	0.9	0.4	0.40	0.52
Port McNeill	5	-5	-7	22	17	3410	13	128	1750	1.89	1850	260	1.1	0.4	0.40	0.52
Port Renfrew	20	-3	-5	24	17	2900	13	200	3600	3.64	3675	270	1.1	0.4	0.40	0.52
Powell River	10	-7	-9	26	18	3100	10	80	1150	1.27	1200	220	1.7	0.4	0.39	0.51
Prince George	580	-32	-36	28	18	4720	15	54	425	0.58	600	80	3.4	0.2	0.29	0.37
Prince Rupert	20	-13	-15	19	15	3900	13	160	2750	2.84	2900	240	1.9	0.4	0.42	0.54
Princeton	655	-24	-29	33	19	4250	10	43	235	0.35	350	80	2.9	0.6	0.28	0.36
Qualicum Beach	10	-7	-9	27	19	3200	10	96	1200	1.31	1250	200	2.0	0.4	0.41	0.53
Queen Charlotte City	35	-6	-8	21	16	3520	13	110	1300	1.47	1350	360	1.8	0.4	0.48	0.61
Quesnel	475	-31	-33	30	17	4650	10	50	380	0.51	525	80	3.0	0.1	0.24	0.31
Revelstoke	440	-20	-23	31	19	4000	13	55	625	0.80	950	80	7.2	0.1	0.25	0.32
Salmon Arm	425	-19	-24	33	21	3650	13	48	400	0.47	525	80	3.5	0.1	0.30	0.39
Sandspit	5	-4	-6	18	15	3450	13	86	1300	1.47	1350	500	1.8	0.4	0.60	0.78
Sechelt	25	-6	-8	27	20	2680	10	75	1140	1.27	1200	160	1.8	0.4	0.37	0.48
Sidney	10	-4	-6	26	18	2850	8	96	825	0.97	850	160	1.1	0.2	0.33	0.42
Smith River	660	-45	-47	26	17	7100	10	64	300	0.58	500	40	2.8	0.1	0.23	0.30

Copyright © NRC 1941 - 2021 World Rights Reserved © CNRC 1941-2021 Droits réservés pour tous pays



**Table C-2 (Continued)**

Province and Location	Elev., m	Design Temperature				De- gree- Days Below 18°C	15 Min. Rain, mm	One Day Rain, 1/50, mm	Ann. Rain, mm	Moist. Index	Ann. Tot. Ppn., mm	Driv- ing Rain Wind Pres- sures, Pa, 1/5	Snow Load, kPa, 1/50		Hourly Wind Pressures, kPa	
		January		July 2.5%									S <sub>s</sub>	S <sub>r</sub>	1/10	1/50
		2.5% °C	1% °C	Dry °C	Wet °C											
Smithers	500	-29	-31	26	17	5040	13	60	325	0.60	500	120	3.5	0.2	0.31	0.40
Sooke	20	-1	-3	21	16	2900	9	130	1250	1.37	1280	220	1.3	0.3	0.37	0.48
Squamish	5	-9	-11	29	20	2950	10	140	2050	2.12	2200	160	2.8	0.7	0.39	0.50
Stewart	10	-17	-20	25	16	4350	13	135	1300	1.47	1900	180	7.9	0.8	0.28	0.36
Tahsis	25	-4	-6	26	18	3150	13	200	3845	3.91	3900	300	1.1	0.4	0.26	0.34
Taylor	515	-35	-37	26	18	5720	15	72	320	0.49	450	100	2.3	0.1	0.31	0.40
Terrace	60	-19	-21	27	17	4150	13	120	950	1.08	1150	200	5.4	0.6	0.28	0.36
Tofino	10	-2	-4	20	16	3150	13	193	3275	3.36	3300	300	1.1	0.4	0.53	0.68
Trail	440	-14	-17	33	20	3600	10	54	580	0.65	700	60	4.1	0.1	0.27	0.35
Ucluelet	5	-2	-4	18	16	3120	13	180	3175	3.26	3200	280	1.0	0.4	0.53	0.68
Vancouver Region																
Burnaby (Simon Fraser Univ.)	330	-7	-9	25	17	3100	10	150	1850	1.93	1950	160	2.9	0.7	0.36	0.47
Cloverdale	10	-8	-10	29	20	2700	10	112	1350	1.44	1400	160	2.5	0.2	0.34	0.44
Haney	10	-9	-11	30	20	2840	10	134	1800	1.86	1950	160	2.4	0.2	0.34	0.44
Ladner	3	-6	-8	27	19	2600	10	80	1000	1.14	1050	160	1.3	0.2	0.36	0.46
Langley	15	-8	-10	29	20	2700	10	112	1450	1.53	1500	160	2.4	0.2	0.34	0.44
New Westminster	10	-8	-10	29	19	2800	10	134	1500	1.59	1575	160	2.3	0.2	0.34	0.44
North Vancouver	135	-7	-9	26	19	2910	12	150	2000	2.07	2100	160	3.0	0.3	0.35	0.45
Richmond	5	-7	-9	27	19	2800	10	86	1070	1.20	1100	160	1.5	0.2	0.35	0.45
Surrey (88 Ave & 156 St.)	90	-8	-10	29	20	2750	10	128	1500	1.58	1575	160	2.4	0.3	0.34	0.44
Vancouver (City Hall)	40	-7	-9	28	20	2825	10	112	1325	1.44	1400	160	1.8	0.2	0.35	0.45
Vancouver (Granville & 41 Ave)	120	-6	-8	28	20	2925	10	107	1325	1.44	1400	160	1.9	0.3	0.35	0.45
West Vancouver	45	-7	-9	28	19	2950	12	150	1600	1.69	1700	160	2.4	0.2	0.37	0.48
Vernon	405	-20	-23	33	20	3600	13	43	350	0.41	400	80	2.2	0.1	0.31	0.40
Victoria Region																
Victoria (Gonzales Hts)	65	-4	-6	24	17	2700	9	91	600	0.82	625	220	1.5	0.3	0.44	0.57
Victoria (Mt Tolmie)	125	-6	-8	24	16	2700	9	91	775	0.96	800	220	2.1	0.3	0.48	0.63
Victoria	10	-4	-6	24	17	2650	8	91	800	0.98	825	220	1.1	0.2	0.44	0.57
Whistler	665	-17	-20	30	20	4180	10	85	845	0.99	1215	160	9.5	0.9	0.25	0.32
White Rock	30	-5	-7	25	20	2620	10	80	1065	1.17	1100	160	2.0	0.2	0.34	0.44
Williams Lake	615	-30	-33	29	17	4400	10	48	350	0.47	425	80	2.4	0.2	0.27	0.35
Youbou	200	-5	-8	31	19	3050	10	161	2000	2.09	2100	200	3.5	0.7	0.25	0.32
<b>Alberta</b>																
Athabasca	515	-35	-38	27	19	6000	18	86	370	0.58	480	80	1.5	0.1	0.28	0.36
Banff	1400	-31	-33	27	16	5500	18	65	300	0.58	500	120	3.3	0.1	0.25	0.32
Barrhead	645	-33	-36	27	19	5740	20	86	375	0.58	475	100	1.7	0.1	0.34	0.44

Table C-2 (Continued)

Province and Location	Elev., m	Design Temperature				De-gree-Days Below 18°C	15 Min. Rain, mm	One Day Rain, 1/50, mm	Ann. Rain, mm	Moist. Index	Ann. Tot. Ppn., mm	Driving Rain Wind Pressures, Pa, 1/5	Snow Load, kPa, 1/50		Hourly Wind Pressures, kPa	
		January		July 2.5%									S <sub>s</sub>	S <sub>r</sub>	1/10	1/50
		2.5% °C	1% °C	Dry °C	Wet °C											
Beaverlodge	730	-36	-39	28	18	5700	20	86	315	0.49	470	100	2.4	0.1	0.28	0.36
Brooks	760	-32	-34	32	20	4880	18	86	260	0.26	340	220	1.2	0.1	0.40	0.52
Calgary	1045	-30	-32	28	17	5000	23	103	325	0.37	425	220	1.1	0.1	0.37	0.48
Campsie	660	-33	-36	27	19	5750	20	86	375	0.58	475	100	1.7	0.1	0.34	0.44
Camrose	740	-33	-35	29	19	5500	20	86	355	0.54	470	160	2.0	0.1	0.30	0.39
Canmore	1320	-31	-33	28	17	5400	18	86	325	0.57	500	120	3.2	0.1	0.29	0.37
Cardston	1130	-29	-32	30	19	4700	20	108	340	0.38	550	140	1.5	0.1	0.56	0.72
Claresholm	1030	-30	-32	30	18	4680	15	97	310	0.35	440	200	1.3	0.1	0.45	0.58
Cold Lake	540	-35	-38	28	19	5860	18	81	320	0.53	430	140	1.7	0.1	0.29	0.38
Coleman	1320	-31	-34	29	18	5210	15	86	400	0.46	550	120	2.7	0.3	0.48	0.63
Coronation	790	-32	-34	30	19	5640	20	92	300	0.45	400	200	1.9	0.1	0.29	0.37
Cowley	1175	-29	-32	29	18	4810	15	92	310	0.36	525	140	1.6	0.1	0.78	1.01
Drumheller	685	-32	-34	30	18	5050	20	86	300	0.39	375	220	1.2	0.1	0.34	0.44
Edmonton	645	-30	-33	28	19	5120	23	97	360	0.48	460	160	1.7	0.1	0.35	0.45
Edson	920	-34	-37	27	18	5750	18	81	450	0.63	570	100	2.1	0.1	0.36	0.46
Embarras Portage	220	-41	-43	28	19	7100	12	81	250	0.56	390	80	2.2	0.1	0.29	0.37
Fairview	670	-37	-40	27	18	5840	15	86	330	0.51	450	100	2.4	0.1	0.27	0.35
Fort MacLeod	945	-30	-32	31	19	4600	16	97	300	0.35	425	180	1.2	0.1	0.53	0.68
Fort McMurray	255	-38	-40	28	19	6250	13	86	340	0.52	460	60	1.5	0.1	0.27	0.35
Fort Saskatchewan	610	-32	-35	28	19	5420	20	86	350	0.49	425	140	1.6	0.1	0.33	0.43
Fort Vermilion	270	-41	-43	28	18	6700	13	70	250	0.53	380	60	2.1	0.1	0.23	0.30
Grande Prairie	650	-36	-39	27	18	5790	20	86	315	0.49	450	120	2.2	0.1	0.33	0.43
Habay	335	-41	-43	28	18	6750	13	70	275	0.54	425	60	2.4	0.1	0.23	0.30
Hardisty	615	-33	-36	30	19	5640	20	81	325	0.48	425	140	1.7	0.1	0.28	0.36
High River	1040	-31	-32	28	17	4900	18	97	300	0.36	425	200	1.3	0.1	0.50	0.65
Hinton	990	-34	-38	27	17	5500	13	81	375	0.55	500	100	2.6	0.1	0.36	0.46
Jasper	1060	-31	-34	28	17	5300	12	76	300	0.52	400	80	3.0	0.1	0.25	0.32
Keg River	420	-40	-42	28	18	6520	13	70	310	0.54	450	80	2.4	0.1	0.23	0.30
Lac la Biche	560	-35	-38	28	19	6100	15	86	375	0.58	475	80	1.6	0.1	0.28	0.36
Lacombe	855	-33	-36	28	19	5500	23	92	350	0.53	450	180	1.9	0.1	0.31	0.40
Lethbridge	910	-30	-32	31	19	4500	20	97	250	0.26	390	200	1.2	0.1	0.51	0.66
Manning	465	-39	-41	27	18	6300	13	76	280	0.49	390	80	2.3	0.1	0.23	0.30
Medicine Hat	705	-31	-34	32	19	4540	23	92	250	0.25	325	220	1.1	0.1	0.37	0.48
Peace River	330	-37	-40	27	18	6050	15	81	300	0.50	390	100	2.2	0.1	0.25	0.32
Pincher Creek	1130	-29	-32	29	18	4740	16	103	325	0.37	575	140	1.5	0.1	0.75	0.96
Ranfurly	670	-34	-37	29	19	5700	18	92	325	0.50	420	100	1.9	0.1	0.28	0.36
Red Deer	855	-32	-35	28	19	5550	20	97	375	0.54	475	200	1.8	0.1	0.31	0.40
Rocky Mountain House	985	-32	-34	27	18	5640	20	92	425	0.59	550	120	1.9	0.1	0.28	0.36
Slave Lake	590	-35	-38	26	19	5850	15	81	380	0.62	500	80	1.9	0.1	0.29	0.37
Stettler	820	-32	-34	30	19	5300	20	97	370	0.53	450	200	1.9	0.1	0.28	0.36

Copyright © NRC 1941 - 2021 World Rights Reserved © CNRC 1941-2021 Droits réservés pour tous pays

Table C-2 (Continued)

Province and Location	Elev., m	Design Temperature				De-gree-Days Below 18°C	15 Min. Rain, mm	One Day Rain, 1/50, mm	Ann. Rain, mm	Moist. Index	Ann. Tot. Ppn., mm	Driving Rain Wind Pressures, Pa, 1/5	Snow Load, kPa, 1/50		Hourly Wind Pressures, kPa	
		January		July 2.5%									S <sub>s</sub>	S <sub>r</sub>	1/10	1/50
		2.5% °C	1% °C	Dry °C	Wet °C											
Stony Plain	710	-32	-35	28	19	5300	23	97	410	0.52	540	120	1.7	0.1	0.35	0.45
Suffield	755	-31	-34	32	20	4770	20	86	230	0.23	325	220	1.3	0.1	0.38	0.49
Taber	815	-31	-33	31	19	4580	20	92	260	0.26	370	200	1.2	0.1	0.48	0.63
Turner Valley	1215	-31	-32	28	17	5220	20	97	350	0.48	600	180	1.4	0.1	0.50	0.65
Valleyview	700	-37	-40	27	18	5600	18	86	360	0.54	490	80	2.3	0.1	0.33	0.42
Vegreville	635	-34	-37	29	19	5780	18	86	325	0.50	410	100	1.9	0.1	0.28	0.36
Vermilion	580	-35	-38	29	19	5740	18	86	310	0.53	410	100	1.7	0.1	0.28	0.36
Wagner	585	-35	-38	26	19	5850	15	81	380	0.62	500	80	1.9	0.1	0.29	0.37
Wainwright	675	-33	-36	29	19	5700	20	81	310	0.47	425	120	2.0	0.1	0.28	0.36
Wetaskiwin	760	-33	-35	29	19	5500	23	86	400	0.57	500	160	2.0	0.1	0.30	0.39
Whitecourt	690	-33	-36	27	19	5650	20	97	440	0.63	550	80	1.9	0.1	0.29	0.37
Wimborne	975	-31	-34	29	18	5310	23	92	325	0.48	450	200	1.6	0.1	0.31	0.40
<b>Saskatchewan</b>																
Assiniboia	740	-32	-34	31	21	5180	25	81	290	0.33	375	240	1.6	0.1	0.38	0.49
Batrum	700	-32	-34	32	20	5080	23	81	270	0.35	350	260	1.2	0.1	0.42	0.54
Biggar	645	-34	-36	30	20	5720	23	81	270	0.39	350	180	2.1	0.1	0.35	0.45
Broadview	600	-34	-35	30	21	5760	25	103	320	0.49	420	160	1.7	0.1	0.36	0.46
Dafoe	530	-35	-37	29	21	5860	20	92	300	0.46	380	140	1.7	0.1	0.29	0.37
Dundurn	525	-35	-37	30	21	5600	23	86	275	0.40	380	180	1.5	0.1	0.36	0.46
Estevan	565	-32	-34	32	22	5340	28	92	330	0.43	420	200	1.6	0.1	0.40	0.52
Hudson Bay	370	-36	-38	29	21	6280	20	81	340	0.59	450	80	2.0	0.1	0.29	0.37
Humboldt	565	-36	-38	28	21	6000	20	86	320	0.48	375	140	2.1	0.1	0.30	0.39
Island Falls	305	-39	-41	27	20	7100	18	76	370	0.62	510	80	2.1	0.1	0.27	0.35
Kamsack	455	-34	-37	29	22	6040	20	97	360	0.55	450	120	2.1	0.2	0.31	0.40
Kindersley	685	-33	-35	31	20	5550	23	81	260	0.38	325	200	1.4	0.1	0.36	0.46
Lloydminster	645	-34	-37	28	20	5880	18	81	310	0.53	430	120	2.0	0.1	0.31	0.40
Maple Creek	765	-31	-34	31	20	4780	25	81	275	0.28	380	220	1.2	0.1	0.35	0.45
Meadow Lake	480	-38	-40	28	20	6280	18	81	320	0.53	450	120	1.7	0.1	0.31	0.40
Melfort	455	-36	-38	28	21	6050	20	81	310	0.50	410	120	2.1	0.1	0.28	0.36
Melville	550	-34	-36	29	21	5880	23	97	340	0.52	410	160	1.7	0.1	0.31	0.40
Moose Jaw	545	-32	-34	31	21	5270	25	86	270	0.33	360	200	1.4	0.1	0.40	0.52
Nipawin	365	-37	-39	28	21	6300	20	76	340	0.56	450	100	2.0	0.1	0.29	0.38
North Battleford	545	-34	-36	29	20	5900	20	81	280	0.46	370	120	1.7	0.1	0.36	0.46
Prince Albert	435	-37	-40	28	21	6100	20	81	320	0.51	410	140	1.9	0.1	0.29	0.38
Qu'Appelle	645	-34	-36	30	22	5620	25	97	340	0.45	430	160	1.7	0.1	0.33	0.42
Regina	575	-34	-36	31	21	5600	28	103	300	0.39	365	200	1.4	0.1	0.38	0.49
Rosetown	595	-34	-36	31	20	5620	23	81	260	0.37	330	200	1.7	0.1	0.38	0.49
Saskatoon	500	-35	-37	30	21	5700	23	86	265	0.41	350	160	1.7	0.1	0.33	0.43
Scott	645	-34	-36	30	20	5960	20	81	270	0.41	360	140	1.9	0.1	0.35	0.45
Strasbourg	545	-34	-36	30	22	5600	25	92	300	0.41	390	180	1.5	0.1	0.33	0.42

Table C-2 (Continued)

Province and Location	Elev., m	Design Temperature				De-gree-Days Below 18°C	15 Min. Rain, mm	One Day Rain, 1/50, mm	Ann. Rain, mm	Moist. Index	Ann. Tot. Ppn., mm	Driving Rain Wind Pressures, Pa, 1/5	Snow Load, kPa, 1/50		Hourly Wind Pressures, kPa	
		January		July 2.5%									S <sub>s</sub>	S <sub>r</sub>	1/10	1/50
		2.5% °C	1% °C	Dry °C	Wet °C											
Swift Current	750	-31	-34	31	20	5150	25	81	260	0.34	350	240	1.4	0.1	0.42	0.54
Uranium City	265	-42	-44	26	19	7500	12	54	300	0.59	360	100	2.0	0.1	0.28	0.36
Weyburn	575	-33	-35	31	23	5400	28	97	320	0.40	400	200	1.8	0.1	0.37	0.48
Yorkton	510	-34	-37	29	21	6000	23	97	350	0.54	440	140	1.9	0.1	0.31	0.40
<b>Manitoba</b>																
Beausejour	245	-33	-35	29	23	5680	28	103	430	0.61	530	180	2.0	0.2	0.32	0.41
Boissevain	510	-32	-34	30	23	5500	28	119	390	0.54	510	180	2.2	0.2	0.40	0.52
Brandon	395	-33	-35	30	22	5760	28	108	375	0.56	460	180	2.1	0.2	0.38	0.49
Churchill	10	-38	-40	25	18	8950	12	76	265	0.82	410	260	3.0	0.2	0.43	0.55
Dauphin	295	-33	-35	30	22	5900	28	103	400	0.56	490	160	1.9	0.2	0.31	0.40
Flin Flon	300	-38	-40	27	20	6440	18	81	340	0.59	475	80	2.2	0.2	0.27	0.35
Gimli	220	-34	-36	29	23	5800	28	108	410	0.65	530	180	1.9	0.2	0.31	0.40
Island Lake	240	-36	-38	27	20	6900	18	86	380	0.67	550	80	2.6	0.2	0.29	0.37
Lac du Bonnet	260	-34	-36	29	23	5730	28	103	445	0.65	560	180	1.9	0.2	0.29	0.37
Lynn Lake	350	-40	-42	27	19	7770	18	86	310	0.62	490	100	2.4	0.2	0.29	0.37
Morden	300	-31	-33	30	24	5400	28	119	420	0.55	520	180	2.2	0.2	0.40	0.52
Neepawa	365	-32	-34	29	23	5760	28	108	410	0.58	470	180	2.2	0.2	0.34	0.44
Pine Falls	220	-34	-36	28	23	5900	25	97	440	0.66	420	180	1.9	0.2	0.30	0.39
Portage la Prairie	260	-31	-33	30	23	5600	28	108	390	0.51	525	180	2.1	0.2	0.36	0.46
Rivers	465	-34	-36	29	23	5840	28	108	370	0.56	460	180	2.1	0.2	0.36	0.46
Sandilands	365	-32	-34	29	23	5650	28	113	460	0.58	550	180	2.2	0.2	0.31	0.40
Selkirk	225	-33	-35	29	23	5700	28	108	420	0.61	500	180	1.9	0.2	0.32	0.41
Split Lake	175	-38	-40	27	19	7900	18	76	325	0.66	500	120	2.5	0.2	0.30	0.39
Steinbach	270	-33	-35	29	23	5700	28	108	440	0.58	500	180	2.0	0.2	0.31	0.40
Swan River	335	-34	-37	29	22	6100	20	92	370	0.58	500	120	2.0	0.2	0.27	0.35
The Pas	270	-36	-38	28	21	6480	18	81	330	0.59	450	160	2.2	0.2	0.29	0.37
Thompson	205	-40	-43	27	19	7600	18	86	350	0.64	540	100	2.4	0.2	0.28	0.36
Virden	435	-33	-35	30	23	5620	28	108	350	0.53	460	180	2.0	0.2	0.36	0.46
Winnipeg	235	-33	-35	30	23	5670	28	108	415	0.58	500	180	1.9	0.2	0.35	0.45
<b>Ontario</b>																
Ailsa Craig	230	-17	-19	30	23	3840	25	103	800	0.93	950	180	2.2	0.4	0.39	0.50
Ajax	95	-20	-22	30	23	3820	23	92	760	0.90	825	160	1.0	0.4	0.37	0.48
Alexandria	80	-24	-26	30	23	4600	25	103	800	0.91	975	160	2.4	0.4	0.31	0.40
Alliston	220	-23	-25	29	23	4200	28	113	690	0.81	875	120	2.0	0.4	0.28	0.36
Almonte	120	-26	-28	30	23	4620	25	97	730	0.84	800	140	2.5	0.4	0.32	0.41
Armstrong	340	-37	-40	28	21	6500	23	97	525	0.75	725	100	2.7	0.4	0.23	0.30
Arnprior	85	-27	-29	30	23	4680	23	86	630	0.76	775	140	2.5	0.4	0.29	0.37
Atikokan	400	-33	-35	29	22	5750	25	103	570	0.77	760	100	2.4	0.3	0.23	0.30
Attawapiskat	10	-37	-39	28	21	7100	18	81	450	0.79	650	160	2.8	0.3	0.32	0.41
Aurora	270	-21	-23	30	23	4210	28	108	700	0.81	800	140	2.0	0.4	0.34	0.44

Copyright © NRC 1941 - 2021 World Rights Reserved © CNRC 1941-2021 Droits réservés pour tous pays

**Table C-2 (Continued)**

Province and Location	Elev., m	Design Temperature				De-gree-Days Below 18°C	15 Min. Rain, mm	One Day Rain, 1/50, mm	Ann. Rain, mm	Moist. Index	Ann. Tot. Ppn., mm	Driving Rain Wind Pressures, Pa, 1/5	Snow Load, kPa, 1/50		Hourly Wind Pressures, kPa	
		January		July 2.5%									S <sub>s</sub>	S <sub>r</sub>	1/10	1/50
		2.5% °C	1% °C	Dry °C	Wet °C											
Bancroft	365	-28	-31	29	23	4740	25	92	720	0.85	900	100	3.1	0.4	0.25	0.32
Barrie	245	-24	-26	29	23	4380	28	97	700	0.83	900	120	2.5	0.4	0.28	0.36
Barriefield	100	-22	-24	28	23	3990	23	108	780	0.96	950	160	2.1	0.4	0.36	0.47
Beaverton	240	-24	-26	30	23	4300	25	108	720	0.87	950	120	2.2	0.4	0.28	0.36
Belleville	90	-22	-24	29	23	3910	23	97	760	0.89	850	180	1.7	0.4	0.33	0.43
Belmont	260	-17	-19	30	24	3840	25	97	850	0.95	950	180	1.7	0.4	0.36	0.47
Kitchenuhmay- koosib (Big Trout Lake)	215	-38	-40	26	20	7450	18	92	400	0.75	600	150	3.2	0.2	0.33	0.42
CFB Borden	225	-23	-25	29	23	4300	28	103	690	0.82	875	120	2.2	0.4	0.28	0.36
Bracebridge	310	-26	-28	29	23	4800	25	103	830	0.95	1050	120	3.1	0.4	0.27	0.35
Bradford	240	-23	-25	30	23	4280	28	108	680	0.80	800	120	2.1	0.4	0.28	0.36
Brampton	215	-19	-21	30	23	4100	28	119	720	0.81	820	140	1.3	0.4	0.34	0.44
Brantford	205	-18	-20	30	23	3900	23	103	780	0.89	850	160	1.3	0.4	0.33	0.42
Brighton	95	-21	-23	29	23	4000	23	94	760	0.90	850	160	1.6	0.4	0.37	0.48
Brockville	85	-23	-25	29	23	4060	25	103	770	0.89	975	180	2.2	0.4	0.34	0.44
Burk's Falls	305	-26	-28	29	22	5020	25	97	810	0.94	1010	120	2.7	0.4	0.27	0.35
Burlington	80	-17	-19	31	23	3740	23	103	770	0.91	850	160	1.1	0.4	0.36	0.46
Cambridge	295	-18	-20	29	23	4100	25	113	800	0.91	890	160	1.6	0.4	0.28	0.36
Campbellford	150	-23	-26	30	23	4280	25	97	730	0.85	850	160	1.7	0.4	0.32	0.41
Cannington	255	-24	-26	30	23	4310	25	108	740	0.85	950	120	2.2	0.4	0.28	0.36
Carleton Place	135	-25	-27	30	23	4600	25	97	730	0.84	850	160	2.5	0.4	0.32	0.41
Cavan	200	-23	-25	30	23	4400	25	97	740	0.86	850	140	2.0	0.4	0.34	0.44
Centralia	260	-17	-19	30	23	3800	25	103	820	0.95	1000	180	2.3	0.4	0.38	0.49
Chapleau	425	-35	-38	27	21	5900	20	97	530	0.72	850	80	3.6	0.4	0.23	0.30
Chatham	180	-16	-18	31	24	3470	28	103	800	0.86	850	180	1.0	0.4	0.33	0.43
Chesley	275	-19	-21	29	22	4320	28	103	810	0.94	1125	140	2.8	0.4	0.37	0.48
Clinton	280	-17	-19	29	23	4150	25	103	810	0.94	1000	160	2.6	0.4	0.38	0.49
Coboconk	270	-25	-27	30	23	4500	25	108	740	0.87	950	120	2.5	0.4	0.27	0.35
Cobourg	90	-21	-23	29	23	3980	23	94	760	0.90	825	160	1.2	0.4	0.38	0.49
Cochrane	245	-34	-36	29	21	6200	20	92	575	0.77	875	80	2.8	0.3	0.27	0.35
Colborne	105	-21	-23	29	23	3980	23	94	760	0.90	850	160	1.6	0.4	0.38	0.49
Collingwood	190	-21	-23	29	23	4180	28	97	720	0.87	950	160	2.7	0.4	0.30	0.39
Cornwall	35	-23	-25	30	23	4250	25	103	780	0.89	960	180	2.2	0.4	0.32	0.41
Corunna	185	-16	-18	31	24	3600	25	100	760	0.87	800	180	1.0	0.4	0.36	0.47
Deep River	145	-29	-32	30	22	4900	23	92	650	0.82	850	100	2.5	0.4	0.27	0.35
Deseronto	85	-22	-24	29	23	4070	23	92	760	0.89	900	160	1.9	0.4	0.33	0.43
Dorchester	260	-18	-20	30	24	3900	28	103	850	0.96	950	180	1.9	0.4	0.36	0.47
Dorion	200	-33	-35	28	21	5950	20	103	550	0.77	725	160	2.8	0.4	0.30	0.39
Dresden	185	-16	-18	31	24	3750	28	97	760	0.84	820	180	1.0	0.4	0.33	0.43
Dryden	370	-34	-36	28	22	5850	25	97	550	0.70	700	120	2.4	0.3	0.23	0.30

**Table C-2 (Continued)**

Province and Location	Elev., m	Design Temperature				De- gree- Days Below 18°C	15 Min. Rain, mm	One Day Rain, 1/50, mm	Ann. Rain, mm	Moist. Index	Ann. Tot. Ppn., mm	Driv- ing Rain Wind Pres- sures, Pa, 1/5	Snow Load, kPa, 1/50		Hourly Wind Pressures, kPa	
		January		July 2.5%									S <sub>s</sub>	S <sub>r</sub>	1/10	1/50
		2.5% °C	1% °C	Dry °C	Wet °C											
Dundalk	525	-22	-24	29	22	4700	28	108	750	0.89	1080	150	3.2	0.4	0.33	0.42
Dunnville	175	-15	-17	30	24	3660	23	108	830	0.95	950	160	2.0	0.4	0.36	0.46
Durham	340	-20	-22	29	22	4340	28	103	815	0.94	1025	140	2.8	0.4	0.34	0.44
Dutton	225	-16	-18	31	24	3700	28	92	850	0.96	925	180	1.3	0.4	0.36	0.47
Earlton	245	-33	-36	29	22	5730	23	92	560	0.75	820	120	3.1	0.4	0.35	0.45
Edison	365	-34	-36	28	22	5740	25	108	510	0.65	680	120	2.4	0.3	0.24	0.31
Elliot Lake	380	-26	-28	29	21	4950	23	108	630	0.83	950	160	2.9	0.4	0.29	0.38
Elmvale	220	-24	-26	29	23	4200	28	97	720	0.87	950	140	2.6	0.4	0.28	0.36
Embro	310	-19	-21	30	23	3950	28	113	830	0.94	950	160	2.0	0.4	0.37	0.48
Englehart	205	-33	-36	29	22	5800	23	92	600	0.78	880	100	2.8	0.4	0.32	0.41
Espanola	220	-25	-27	29	21	4920	23	108	650	0.83	840	160	2.3	0.4	0.33	0.42
Exeter	265	-17	-19	30	23	3900	25	113	810	0.94	975	180	2.4	0.4	0.38	0.49
Fenelon Falls	260	-25	-27	30	23	4440	25	108	730	0.86	950	120	2.3	0.4	0.28	0.36
Fergus	400	-20	-22	29	23	4300	28	108	760	0.87	925	160	2.2	0.4	0.28	0.36
Forest	215	-16	-18	31	23	3740	25	103	810	0.95	875	160	2.0	0.4	0.37	0.48
Fort Erie	180	-15	-17	30	24	3650	23	108	860	0.98	1020	160	2.3	0.4	0.36	0.46
Fort Erie (Ridgeway)	190	-15	-17	30	24	3600	25	108	860	0.98	1000	160	2.3	0.4	0.36	0.46
Fort Frances	340	-33	-35	29	22	5440	25	108	570	0.71	725	120	2.3	0.3	0.24	0.31
Gananoque	80	-22	-24	28	23	4010	23	103	760	0.91	900	180	2.1	0.4	0.36	0.47
Geraldton	345	-36	-39	28	21	6450	20	86	550	0.77	725	100	2.9	0.4	0.23	0.30
Glencoe	215	-16	-18	31	24	3680	28	103	800	0.91	925	180	1.5	0.4	0.33	0.43
Goderich	185	-16	-18	29	23	4000	25	92	810	0.95	950	180	2.4	0.4	0.43	0.55
Gore Bay	205	-24	-26	28	22	4700	23	92	640	0.84	860	160	2.6	0.4	0.34	0.44
Graham	495	-35	-37	29	22	5940	23	97	570	0.75	750	140	2.6	0.3	0.23	0.30
Gravenhurst (Muskoka Airport)	255	-26	-28	29	23	4760	25	103	790	0.92	1050	120	2.7	0.4	0.28	0.36
Grimsby	85	-16	-18	30	23	3520	23	108	760	0.90	875	160	0.9	0.4	0.36	0.46
Guelph	340	-19	-21	29	23	4270	28	103	770	0.88	875	140	1.9	0.4	0.28	0.36
Guthrie	280	-24	-26	29	23	4300	28	103	700	0.83	950	120	2.5	0.4	0.28	0.36
Haileybury	210	-32	-35	30	22	5600	23	92	590	0.77	820	120	2.4	0.4	0.34	0.44
Haldimand (Caledonia)	190	-18	-20	30	23	3750	23	108	810	0.93	875	160	1.2	0.4	0.34	0.44
Haldimand (Hagersville)	215	-17	-19	30	23	3760	25	97	840	0.95	875	160	1.3	0.4	0.36	0.46
Haliburton	335	-27	-29	29	23	4840	25	92	780	0.90	980	100	2.9	0.4	0.27	0.35
Halton Hills (Georgetown)	255	-19	-21	30	23	4200	28	119	750	0.84	850	140	1.4	0.4	0.29	0.37
Hamilton	90	-17	-19	31	23	3460	23	108	810	0.90	875	160	1.1	0.4	0.36	0.46
Hanover	270	-19	-21	29	22	4300	28	103	790	0.92	1050	140	2.6	0.4	0.37	0.48
Hastings	200	-24	-26	30	23	4280	25	92	730	0.85	840	140	2.0	0.4	0.32	0.41
Hawkesbury	50	-25	-27	30	23	4610	23	103	800	0.91	925	160	2.3	0.4	0.32	0.41
Hearst	245	-35	-37	29	21	6450	20	86	520	0.74	825	80	2.8	0.3	0.23	0.30

Copyright © NRC 1941 - 2021 World Rights Reserved © CNRC 1941-2021 Droits réservés pour tous pays

**Table C-2 (Continued)**

Province and Location	Elev., m	Design Temperature				De- gree- Days Below 18°C	15 Min. Rain, mm	One Day Rain, 1/50, mm	Ann. Rain, mm	Moist. Index	Ann. Tot. Ppn., mm	Driv- ing Rain Wind Pres- sures, Pa, 1/5	Snow Load, kPa, 1/50		Hourly Wind Pressures, kPa	
		January		July 2.5%									S <sub>s</sub>	S <sub>r</sub>	1/10	1/50
		2.5% °C	1% °C	Dry °C	Wet °C											
Honey Harbour	180	-24	-26	29	23	4300	25	97	710	0.87	1050	160	2.7	0.4	0.30	0.39
Hornepayne	360	-37	-40	28	21	6340	20	93	420	0.68	750	80	3.3	0.4	0.23	0.30
Huntsville	335	-26	-29	29	22	4850	25	103	800	0.93	1000	120	2.9	0.4	0.27	0.35
Ingersoll	280	-18	-20	30	23	3920	28	108	840	0.95	950	180	1.7	0.4	0.37	0.48
Iroquois Falls	275	-33	-36	29	21	6100	20	86	575	0.77	825	100	2.9	0.3	0.29	0.37
Jellicoe	330	-36	-39	28	21	6400	20	86	550	0.76	750	100	2.7	0.4	0.23	0.30
Kapuskasing	245	-34	-36	29	21	6250	20	86	550	0.76	825	100	3.0	0.3	0.24	0.31
Kemptville	90	-25	-27	30	23	4540	25	92	750	0.86	925	160	2.3	0.4	0.32	0.41
Kenora	370	-33	-35	28	22	5630	25	113	515	0.64	630	120	2.5	0.3	0.24	0.31
Killaloe	185	-28	-31	30	22	4960	23	86	680	0.83	825	120	2.7	0.4	0.27	0.35
Kincardine	190	-17	-19	28	22	3890	25	92	800	0.95	950	180	2.6	0.4	0.43	0.55
Kingston	80	-22	-24	28	23	4000	23	108	780	0.96	950	180	2.1	0.4	0.36	0.47
Kinmount	295	-26	-28	29	23	4600	25	108	750	0.88	950	120	2.7	0.4	0.27	0.35
Kirkland Lake	325	-33	-36	29	22	6000	23	92	600	0.78	875	100	2.9	0.3	0.30	0.39
Kitchener	335	-19	-21	29	23	4200	28	119	780	0.89	925	140	2.0	0.4	0.29	0.37
Lakefield	240	-24	-26	30	23	4330	25	92	720	0.85	850	140	2.2	0.4	0.29	0.38
Lansdowne House	240	-38	-40	28	21	7150	23	92	500	0.78	680	140	3.0	0.2	0.25	0.32
Leamington	190	-15	-17	31	24	3400	28	113	800	0.91	875	180	0.8	0.4	0.36	0.47
Lindsay	265	-24	-26	30	23	4320	25	103	720	0.84	850	140	2.3	0.4	0.29	0.38
Lion's Head	185	-19	-21	27	22	4300	25	103	700	0.89	950	180	2.7	0.4	0.37	0.48
Listowel	380	-19	-21	29	23	4300	28	119	800	0.93	1000	160	2.6	0.4	0.36	0.47
London	245	-18	-20	30	24	3900	28	103	825	0.94	975	180	1.9	0.4	0.36	0.47
Lucan	300	-17	-19	30	23	3900	25	113	810	0.94	1000	180	2.3	0.4	0.39	0.50
Maitland	85	-23	-25	29	23	4080	25	103	770	0.89	975	180	2.2	0.4	0.34	0.44
Markdale	425	-20	-22	29	22	4500	28	103	820	0.94	1050	160	3.2	0.4	0.32	0.41
Markham	175	-21	-23	31	24	4000	25	86	720	0.81	825	140	1.3	0.4	0.34	0.44
Martin	485	-35	-37	29	22	5900	25	103	560	0.75	750	120	2.6	0.3	0.23	0.30
Matheson	265	-33	-36	29	21	6080	20	86	580	0.77	825	100	2.8	0.3	0.30	0.39
Mattawa	165	-29	-31	30	22	5050	23	86	700	0.86	875	100	2.1	0.4	0.25	0.32
Midland	190	-24	-26	29	23	4200	25	97	740	0.88	1060	160	2.7	0.4	0.30	0.39
Milton	200	-18	-20	30	23	3920	25	125	750	0.85	850	160	1.3	0.4	0.33	0.43
Milverton	370	-19	-21	29	23	4200	28	108	800	0.93	1050	160	2.4	0.4	0.33	0.43
Minden	270	-27	-29	29	23	4640	25	97	780	0.90	1010	100	2.7	0.4	0.27	0.35
Mississauga	160	-18	-20	30	23	3880	25	113	720	0.85	800	160	1.1	0.4	0.34	0.44
Mississauga (Lester B. Pearson Int'l Airport)	170	-20	-22	31	24	3890	26	108	685	0.81	790	160	1.1	0.4	0.34	0.44
Mississauga (Port Credit)	75	-18	-20	29	23	3780	25	108	720	0.87	800	160	0.9	0.4	0.37	0.48
Mitchell	335	-18	-20	29	23	4100	28	113	810	0.94	1050	160	2.4	0.4	0.37	0.48
Moosonee	10	-36	-38	28	22	6800	18	81	500	0.84	700	160	2.7	0.3	0.27	0.35
Morrisburg	75	-23	-25	30	23	4370	25	103	800	0.91	950	180	2.3	0.4	0.32	0.41

**Table C-2 (Continued)**

Province and Location	Elev., m	Design Temperature				De- gree- Days Below 18°C	15 Min. Rain, mm	One Day Rain, 1/50, mm	Ann. Rain, mm	Moist. Index	Ann. Tot. Ppn., mm	Driv- ing Rain Wind Pres- sures, Pa, 1/5	Snow Load, kPa, 1/50		Hourly Wind Pressures, kPa	
		January		July 2.5%									S <sub>s</sub>	S <sub>r</sub>	1/10	1/50
		2.5% °C	1% °C	Dry °C	Wet °C											
Mount Forest	420	-21	-24	28	22	4700	28	103	740	0.87	940	140	2.7	0.4	0.32	0.41
Nakina	325	-36	-38	28	21	6500	20	86	540	0.76	750	100	2.8	0.4	0.23	0.30
Nanticoke (Jarvis)	205	-17	-18	30	23	3700	28	108	840	0.95	900	160	1.4	0.4	0.37	0.48
Nanticoke (Port Dover)	180	-15	-17	30	24	3600	25	108	860	0.98	950	140	1.2	0.4	0.37	0.48
Napanee	90	-22	-24	29	23	4140	23	92	770	0.90	900	160	1.9	0.4	0.33	0.43
New Liskeard	180	-32	-35	30	22	5570	23	92	570	0.75	810	100	2.6	0.4	0.33	0.43
Newcastle	115	-20	-22	30	23	3990	23	86	760	0.90	830	160	1.5	0.4	0.37	0.48
Newcastle (Bowmanville)	95	-20	-22	30	23	4000	23	86	760	0.90	830	160	1.4	0.4	0.37	0.48
Newmarket	185	-22	-24	30	23	4260	28	108	700	0.81	800	140	2.0	0.4	0.29	0.38
Niagara Falls	210	-16	-18	30	23	3600	23	96	810	0.94	950	160	1.8	0.4	0.33	0.43
North Bay	210	-28	-30	28	22	5150	25	95	775	0.93	975	120	2.2	0.4	0.27	0.34
Norwood	225	-24	-26	30	23	4320	25	92	720	0.84	850	120	2.1	0.4	0.32	0.41
Oakville	90	-18	-20	30	23	3760	23	97	750	0.90	850	160	1.1	0.4	0.36	0.47
Orangeville	430	-21	-23	29	23	4450	28	108	730	0.84	875	140	2.3	0.4	0.28	0.36
Orillia	230	-25	-27	29	23	4260	25	103	740	0.88	1000	120	2.4	0.4	0.28	0.36
Oshawa	110	-19	-21	30	23	3860	23	86	760	0.90	875	160	1.4	0.4	0.37	0.48
Ottawa (Metropolitan)																
Ottawa (City Hall)	70	-25	-27	30	23	4440	23	86	750	0.84	900	160	2.4	0.4	0.32	0.41
Ottawa (Barrhaven)	98	-25	-27	30	23	4500	25	92	750	0.84	900	160	2.4	0.4	0.32	0.41
Ottawa (Kanata)	98	-25	-27	30	23	4520	25	92	730	0.84	900	160	2.5	0.4	0.32	0.41
Ottawa (M-C Int'l Airport)	125	-25	-27	30	23	4500	24	89	750	0.84	900	160	2.4	0.4	0.32	0.41
Ottawa (Orleans)	70	-26	-28	30	23	4500	23	91	750	0.84	900	160	2.4	0.4	0.32	0.41
Owen Sound	215	-19	-21	29	22	4030	28	113	760	0.90	1075	160	2.8	0.4	0.37	0.48
Pagwa River	185	-35	-37	28	21	6500	20	86	540	0.76	825	80	2.7	0.4	0.23	0.30
Paris	245	-18	-20	30	23	4000	23	96	790	0.90	925	160	1.4	0.4	0.33	0.42
Parkhill	205	-16	-18	31	23	3800	25	103	800	0.93	925	180	2.1	0.4	0.39	0.50
Parry Sound	215	-24	-26	28	22	4640	23	97	820	0.95	1050	160	2.8	0.4	0.30	0.39
Pelham (Fonthill)	230	-15	-17	30	23	3690	23	96	820	0.94	950	160	2.1	0.4	0.33	0.42
Pembroke	125	-28	-31	30	23	4980	23	105	640	0.80	825	100	2.5	0.4	0.27	0.35
Penetanguishene	220	-24	-26	29	23	4200	25	97	720	0.87	1050	160	2.8	0.4	0.30	0.39
Perth	130	-25	-27	30	23	4540	25	92	730	0.84	900	140	2.3	0.4	0.32	0.41
Petawawa	135	-29	-31	30	23	4980	23	92	640	0.80	825	100	2.6	0.4	0.27	0.35
Peterborough	200	-23	-25	30	23	4400	25	92	710	0.83	840	140	2.0	0.4	0.32	0.41
Petrolia	195	-16	-18	31	24	3640	25	108	810	0.89	920	180	1.3	0.4	0.36	0.47
Pickering (Dunbarton)	85	-19	-21	30	23	3800	23	92	730	0.88	825	140	1.0	0.4	0.37	0.48
Picton	95	-21	-23	29	23	3980	23	92	770	0.91	940	160	2.0	0.4	0.38	0.49
Plattsville	300	-19	-21	29	23	4150	28	103	820	0.93	950	140	1.9	0.4	0.33	0.42
Point Alexander	150	-29	-32	30	22	4960	23	92	650	0.82	850	100	2.5	0.4	0.27	0.35
Port Burwell	195	-15	-17	30	24	3800	25	92	930	1.05	1000	180	1.2	0.4	0.36	0.47

Copyright © NRC 1941 - 2021 World Rights Reserved © CNRC 1941-2021 Droits réservés pour tous pays



**Table C-2 (Continued)**

Province and Location	Elev., m	Design Temperature				De- gree- Days Below 18°C	15 Min. Rain, mm	One Day Rain, 1/50, mm	Ann. Rain, mm	Moist. Index	Ann. Tot. Ppn., mm	Driv- ing Rain Wind Pres- sures, Pa, 1/5	Snow Load, kPa, 1/50		Hourly Wind Pressures, kPa	
		January		July 2.5%									S <sub>s</sub>	S <sub>r</sub>	1/10	1/50
		2.5% °C	1% °C	Dry °C	Wet °C											
Port Colborne	180	-15	-17	30	24	3600	23	108	850	0.97	1000	160	2.1	0.4	0.36	0.46
Port Elgin	205	-17	-19	28	22	4100	25	92	790	0.94	850	180	2.8	0.4	0.43	0.55
Port Hope	100	-21	-23	29	23	3970	23	94	760	0.90	825	180	1.2	0.4	0.37	0.48
Port Perry	270	-22	-24	30	23	4260	25	97	720	0.84	850	140	2.4	0.4	0.34	0.44
Port Stanley	180	-15	-17	31	24	3850	25	92	940	1.05	975	180	1.2	0.4	0.36	0.47
Prescott	90	-23	-25	29	23	4120	25	103	770	0.88	975	180	2.2	0.4	0.34	0.44
Princeton	280	-18	-20	30	23	4000	25	97	810	0.92	925	160	1.5	0.4	0.33	0.42
Raith	475	-34	-37	28	22	5900	23	97	570	0.75	750	120	2.7	0.4	0.23	0.30
Rayside-Balfour (Chelmsford)	270	-28	-30	29	21	5200	25	92	650	0.80	850	180	2.5	0.4	0.35	0.45
Red Lake	360	-35	-37	28	21	6220	20	92	470	0.69	630	120	2.6	0.3	0.23	0.30
Renfrew	115	-27	-30	30	23	4900	23	97	620	0.75	810	140	2.5	0.4	0.27	0.35
Richmond Hill	230	-21	-23	31	24	4000	25	97	740	0.83	850	140	1.5	0.4	0.34	0.44
Rockland	50	-26	-28	30	23	4600	23	92	780	0.89	950	160	2.4	0.4	0.31	0.40
Sarnia	190	-16	-18	31	24	3750	25	100	750	0.87	825	180	1.1	0.4	0.36	0.47
Sault Ste. Marie	190	-25	-28	29	22	4960	23	97	660	0.89	950	200	3.1	0.4	0.34	0.44
Schreiber	310	-34	-36	27	21	5960	20	103	600	0.82	850	160	3.3	0.4	0.30	0.39
Seaforth	310	-17	-19	30	23	4100	25	108	810	0.94	1025	160	2.5	0.4	0.37	0.48
Shelburne	495	-22	-24	29	23	4700	28	108	740	0.88	900	150	3.1	0.4	0.31	0.40
Simcoe	210	-17	-19	30	24	3700	28	113	860	0.97	950	160	1.3	0.4	0.35	0.45
Sioux Lookout	375	-34	-36	28	22	5950	25	97	520	0.69	710	100	2.6	0.3	0.23	0.30
Smiths Falls	130	-25	-27	30	23	4540	25	92	730	0.84	850	140	2.3	0.4	0.32	0.41
Smithville	185	-16	-18	30	23	3650	23	108	800	0.92	900	160	1.5	0.4	0.33	0.42
Smooth Rock Falls	235	-34	-36	29	21	6250	20	92	560	0.77	850	80	2.7	0.3	0.25	0.32
South River	355	-27	-29	29	22	5090	25	103	830	0.96	975	120	2.8	0.4	0.27	0.35
Southampton	180	-17	-19	28	22	4100	25	92	800	0.95	830	180	2.7	0.4	0.41	0.53
St. Catharines	105	-16	-18	30	23	3540	23	92	770	0.90	850	160	1.0	0.4	0.36	0.46
St. Mary's	310	-18	-20	30	23	4000	28	108	820	0.95	1025	160	2.2	0.4	0.36	0.47
St. Thomas	225	-16	-18	31	24	3780	25	103	900	0.99	975	180	1.4	0.4	0.36	0.47
Stirling	120	-23	-25	30	23	4220	25	97	740	0.86	850	120	1.7	0.4	0.31	0.40
Stratford	360	-18	-20	29	23	4050	28	113	820	0.95	1050	160	2.3	0.4	0.35	0.45
Strathroy	225	-17	-19	31	24	3780	25	103	770	0.88	950	180	1.9	0.4	0.36	0.47
Sturgeon Falls	205	-28	-30	29	21	5200	25	95	700	0.86	910	140	2.4	0.4	0.27	0.35
Sudbury	275	-28	-30	29	21	5180	25	97	650	0.79	875	200	2.5	0.4	0.36	0.46
Sundridge	340	-27	-29	29	22	5080	25	97	840	0.97	975	120	2.8	0.4	0.27	0.35
Tavistock	340	-19	-21	29	23	4100	28	113	820	0.95	1010	160	2.1	0.4	0.35	0.45
Temagami	300	-30	-33	30	22	5420	23	92	650	0.82	875	120	2.6	0.4	0.29	0.37
Thamesford	280	-19	-21	30	23	3950	28	108	820	0.93	975	160	1.9	0.4	0.37	0.48
Thedford	205	-16	-18	31	23	3710	25	103	810	0.95	900	180	2.1	0.4	0.39	0.50
Thunder Bay	210	-31	-33	29	21	5650	23	108	560	0.76	710	160	2.9	0.4	0.30	0.39

**Table C-2 (Continued)**

Province and Location	Elev., m	Design Temperature				De- gree- Days Below 18°C	15 Min. Rain, mm	One Day Rain, 1/50, mm	Ann. Rain, mm	Moist. Index	Ann. Tot. Ppn., mm	Driv- ing Rain Wind Pres- sures, Pa, 1/5	Snow Load, kPa, 1/50		Hourly Wind Pressures, kPa	
		January		July 2.5%									S <sub>s</sub>	S <sub>r</sub>	1/10	1/50
		2.5% °C	1% °C	Dry °C	Wet °C											
Tillsonburg	215	-17	-19	30	24	3840	25	103	880	0.98	980	160	1.3	0.4	0.34	0.44
Timmins	300	-34	-36	29	21	5940	20	108	560	0.75	875	100	3.1	0.3	0.27	0.35
Timmins (Porcupine)	295	-34	-36	29	21	6000	20	103	560	0.75	875	100	2.9	0.3	0.29	0.37
Toronto Metropolitan Region																
Etobicoke	160	-20	-22	31	24	3800	26	108	720	0.80	800	160	1.1	0.4	0.34	0.44
North York	175	-20	-22	31	24	3760	25	108	730	0.82	850	150	1.2	0.4	0.34	0.44
Scarborough	180	-20	-22	31	24	3800	25	92	730	0.87	825	160	1.2	0.4	0.36	0.47
Toronto (City Hall)	90	-18	-20	31	23	3520	25	97	720	0.86	820	160	0.9	0.4	0.34	0.44
Trenton	80	-22	-24	29	23	4110	23	97	760	0.89	850	160	1.6	0.4	0.36	0.47
Trout Creek	330	-27	-29	29	22	5100	25	103	780	0.92	975	120	2.7	0.4	0.27	0.35
Uxbridge	275	-22	-24	30	23	4240	25	103	700	0.82	850	140	2.4	0.4	0.33	0.42
Vaughan (Woodbridge)	165	-20	-22	31	24	4100	26	113	700	0.80	800	140	1.1	0.4	0.34	0.44
Vittoria	215	-15	-17	30	24	3680	25	113	880	0.99	950	160	1.3	0.4	0.36	0.47
Walkerton	275	-18	-20	30	22	4300	28	103	790	0.92	1025	160	2.7	0.4	0.39	0.50
Wallaceburg	180	-16	-18	31	24	3600	28	97	760	0.87	825	180	0.9	0.4	0.35	0.45
Waterloo	330	-19	-21	29	23	4200	28	119	780	0.89	925	160	2.0	0.4	0.29	0.37
Watford	240	-17	-19	31	24	3740	25	108	790	0.90	950	160	1.9	0.4	0.36	0.47
Wawa	290	-34	-36	26	21	5840	20	93	725	0.93	950	160	3.4	0.4	0.30	0.39
Welland	180	-15	-17	30	23	3670	23	103	840	0.96	975	160	2.0	0.4	0.33	0.43
West Lorne	215	-16	-18	31	24	3700	28	103	840	0.95	900	180	1.3	0.4	0.36	0.47
Whitby	85	-20	-22	30	23	3820	23	86	760	0.90	850	160	1.2	0.4	0.37	0.48
Whitby (Brooklin)	160	-20	-22	30	23	4010	23	86	770	0.91	850	140	1.9	0.4	0.35	0.45
White River	375	-39	-42	28	21	6150	20	92	575	0.80	825	100	3.6	0.4	0.23	0.30
Warton	185	-19	-21	29	22	4300	25	103	740	0.91	1000	180	2.7	0.4	0.37	0.48
Windsor	185	-16	-18	32	24	3400	28	103	800	0.85	900	180	0.8	0.4	0.36	0.47
Wingham	310	-18	-20	30	23	4220	28	108	780	0.91	1050	160	2.6	0.4	0.39	0.50
Woodstock	300	-19	-21	30	23	3910	28	113	830	0.94	930	160	1.9	0.4	0.34	0.44
Wyoming	215	-16	-18	31	24	3700	25	103	815	0.92	900	180	1.6	0.4	0.36	0.47
<b>Quebec</b>																
Acton-Vale	95	-24	-27	30	23	4620	21	107	860	0.97	1050	180	2.3	0.4	0.27	0.35
Alma	110	-31	-33	28	22	5800	20	91	700	0.86	950	160	3.3	0.4	0.27	0.35
Amos	295	-34	-36	28	21	6160	20	91	670	0.85	920	100	3.2	0.3	0.25	0.32
Asbestos	245	-26	-28	29	22	4800	23	96	870	0.98	1050	160	2.8	0.6	0.27	0.35
Aylmer	90	-25	-28	30	23	4520	23	91	730	0.84	900	160	2.5	0.4	0.32	0.41
Baie-Comeau	60	-27	-29	25	19	6020	16	91	680	0.96	1000	220	4.3	0.4	0.39	0.50
Baie-Saint-Paul	20	-27	-29	28	21	5280	18	102	730	0.89	1000	180	3.4	0.6	0.37	0.48
Beauport	45	-26	-29	28	22	5100	20	107	980	1.09	1200	200	3.4	0.6	0.33	0.42
Bedford	55	-24	-26	29	23	4420	23	91	880	0.99	1260	160	2.1	0.4	0.32	0.41
Beloil	25	-24	-26	30	23	4500	23	91	840	0.95	1025	180	2.4	0.4	0.29	0.37

Copyright © NRC 1941 - 2021 World Rights Reserved © CNRC 1941-2021 Droits réservés pour tous pays

**Table C-2 (Continued)**

Province and Location	Elev., m	Design Temperature				De- gree- Days Below 18°C	15 Min. Rain, mm	One Day Rain, 1/50, mm	Ann. Rain, mm	Moist. Index	Ann. Tot. Ppn., mm	Driv- ing Rain Wind Pres- sures, Pa, 1/5	Snow Load, kPa, 1/50		Hourly Wind Pressures, kPa	
		January		July 2.5%									S <sub>s</sub>	S <sub>r</sub>	1/10	1/50
		2.5% °C	1% °C	Dry °C	Wet °C											
Brome	210	-25	-27	29	23	4730	23	96	990	1.09	1240	160	2.5	0.4	0.29	0.37
Brossard	15	-24	-26	30	23	4420	23	91	800	0.90	1025	180	2.4	0.4	0.33	0.42
Buckingham	130	-26	-28	30	23	4880	23	91	810	0.94	990	160	2.6	0.4	0.31	0.40
Campbell's Bay	115	-28	-30	30	23	4900	23	96	700	0.83	850	140	2.6	0.4	0.25	0.32
Chambly	20	-24	-26	30	23	4450	23	91	850	0.96	1000	160	2.3	0.4	0.31	0.40
Coaticook	295	-25	-27	28	22	4750	23	96	860	1.00	1060	160	2.3	0.6	0.27	0.35
Contrecoeur	10	-25	-27	30	23	4500	20	102	810	0.94	1000	180	2.8	0.4	0.33	0.43
Cowansville	120	-25	-27	29	23	4540	23	91	940	1.04	1150	160	2.3	0.4	0.32	0.41
Deux-Montagnes	25	-25	-27	29	23	4440	23	96	820	0.92	1025	160	2.4	0.4	0.29	0.37
Dolbeau	120	-32	-34	28	22	6250	22	91	670	0.85	900	140	3.5	0.3	0.27	0.35
Drummondville	85	-26	-28	30	23	4700	22	107	870	0.98	1075	180	2.5	0.4	0.27	0.35
Farnham	60	-24	-26	29	23	4500	23	96	910	1.01	1050	180	2.5	0.4	0.29	0.37
Fort-Coulonge	110	-28	-30	30	23	4950	23	96	720	0.86	900	100	2.5	0.4	0.25	0.32
Gagnon	545	-34	-36	24	19	7600	17	80	580	0.89	925	140	4.6	0.4	0.30	0.39
Gaspé	55	-25	-26	26	20	5500	19	118	760	0.96	1100	300	4.3	0.6	0.37	0.48
Gatineau	95	-25	-28	30	23	4600	23	91	790	0.92	950	160	2.5	0.4	0.32	0.41
Gracefield	175	-28	-31	30	23	5080	23	96	700	0.85	950	140	2.6	0.4	0.25	0.32
Granby	120	-25	-27	29	23	4500	23	102	940	1.04	1175	160	2.3	0.4	0.27	0.35
Harrington-Harbour	30	-27	-29	19	16	6150	15	96	900	1.18	1150	300	4.9	0.6	0.56	0.72
Havre-St-Pierre	5	-27	-29	22	18	6100	15	96	780	1.05	1125	300	4.1	0.6	0.48	0.63
Hemmingford	75	-24	-26	30	23	4380	23	91	770	0.89	1025	160	2.4	0.4	0.31	0.40
Hull	65	-25	-28	30	23	4550	23	91	730	0.84	900	160	2.4	0.4	0.32	0.41
Iberville	35	-24	-26	29	23	4450	23	91	880	0.99	1010	160	2.2	0.4	0.32	0.41
Inukjuak	5	-36	-38	21	15	9150	9	54	270	0.88	420	240	4.1	0.2	0.47	0.60
Joliette	45	-26	-28	29	23	4720	21	102	790	0.93	1000	160	3.1	0.4	0.28	0.36
Kuujuaq	25	-37	-39	24	17	8550	9	54	280	0.80	525	260	4.8	0.2	0.47	0.60
Kuujuarapik	20	-36	-38	25	17	7990	12	80	410	0.85	610	180	4.2	0.3	0.43	0.55
La Pocatière	55	-24	-26	28	22	5160	18	102	675	0.85	965	180	3.2	0.6	0.39	0.50
La-Malbaie	25	-26	-28	28	21	5400	18	102	640	0.82	900	180	3.1	0.6	0.37	0.48
La-Tuque	165	-30	-32	29	22	5500	23	96	720	0.87	930	160	3.4	0.4	0.27	0.35
Lac-Mégantic	420	-27	-29	27	22	5180	23	91	790	0.94	1025	160	3.2	0.6	0.27	0.35
Lachute	65	-26	-28	29	23	4640	23	96	910	1.04	1075	160	2.4	0.4	0.31	0.40
Lennoxville	155	-28	-30	29	22	4700	23	96	850	0.98	1100	160	2.1	0.6	0.25	0.32
Léry	30	-24	-26	29	23	4420	23	91	800	0.91	950	180	2.3	0.4	0.33	0.42
Loretteville	100	-26	-29	28	22	5200	20	102	980	1.09	1225	200	3.7	0.6	0.32	0.41
Louiseville	15	-25	-28	29	23	4900	20	102	800	0.93	1025	160	2.9	0.4	0.33	0.43
Magog	215	-26	-28	29	23	4730	23	96	860	0.99	1125	160	2.3	0.4	0.27	0.35
Malartic	325	-33	-36	29	21	6200	20	86	640	0.82	900	100	3.3	0.3	0.25	0.32
Maniwaki	180	-30	-32	29	22	5280	23	96	700	0.86	900	100	2.4	0.4	0.24	0.31
Masson	50	-26	-28	30	23	4610	23	91	790	0.92	975	160	2.4	0.4	0.31	0.40

**Table C-2 (Continued)**

Province and Location	Elev., m	Design Temperature				De- gree- Days Below 18°C	15 Min. Rain, mm	One Day Rain, 1/50, mm	Ann. Rain, mm	Moist. Index	Ann. Tot. Ppn., mm	Driv- ing Rain Wind Pres- sures, Pa, 1/5	Snow Load, kPa, 1/50		Hourly Wind Pressures, kPa	
		January		July 2.5%									S <sub>s</sub>	S <sub>t</sub>	1/10	1/50
		2.5% °C	1% °C	Dry °C	Wet °C											
Matane	5	-24	-26	24	20	5510	18	91	640	0.88	1050	220	3.7	0.4	0.47	0.60
Mont-Joli	90	-24	-26	26	21	5370	18	91	610	0.84	920	220	4.1	0.4	0.40	0.52
Mont-Laurier	225	-29	-32	29	22	5320	24	102	790	0.93	1000	160	2.6	0.4	0.23	0.30
Montmagny	10	-25	-28	28	22	5090	20	102	880	1.01	1090	180	2.9	0.6	0.36	0.47
Montréal Region																
Beaconsfield	25	-24	-26	30	23	4440	23	91	780	0.89	950	180	2.3	0.4	0.33	0.42
Dorval	25	-24	-26	30	23	4400	23	91	760	0.85	940	180	2.4	0.4	0.33	0.42
Laval	35	-24	-26	29	23	4500	23	96	830	0.93	1025	160	2.6	0.4	0.33	0.42
Montréal (City Hall)	20	-23	-26	30	23	4200	23	96	830	0.93	1025	180	2.6	0.4	0.33	0.42
Montréal-Est	25	-23	-26	30	23	4470	23	96	830	0.93	1025	180	2.7	0.4	0.33	0.42
Montréal-Nord	20	-24	-26	30	23	4470	23	96	830	0.93	1025	160	2.6	0.4	0.33	0.42
Outremont	105	-23	-26	30	23	4300	23	96	820	0.91	1025	180	2.8	0.4	0.33	0.42
Pierrefonds	25	-24	-26	30	23	4430	23	96	800	0.90	960	180	2.4	0.4	0.33	0.42
St-Lambert	15	-23	-26	30	23	4400	23	96	810	0.91	1050	160	2.5	0.4	0.33	0.42
St-Laurent	45	-23	-26	30	23	4270	23	96	790	0.89	950	160	2.5	0.4	0.33	0.42
Ste-Anne-de-Bellevue	35	-24	-26	29	23	4460	23	96	780	0.89	960	180	2.3	0.4	0.33	0.42
Verdun	20	-23	-26	30	23	4200	23	91	780	0.88	1025	180	2.5	0.4	0.33	0.42
Nicolet (Gentilly)	15	-25	-28	29	23	4900	20	107	860	0.98	1025	160	2.8	0.4	0.33	0.42
Nitchequon	545	-39	-41	23	19	8100	15	70	500	0.89	825	140	3.5	0.3	0.29	0.37
Noranda	305	-33	-36	29	21	6050	20	91	650	0.82	875	100	3.2	0.3	0.27	0.35
Percé	5	-21	-24	25	19	5400	16	107	1000	1.18	1300	300	3.8	0.6	0.56	0.72
Pincourt	25	-24	-26	29	23	4480	23	96	780	0.88	950	180	2.3	0.4	0.33	0.42
Plessisville	145	-26	-28	29	23	5100	21	107	890	1.00	1150	180	2.8	0.6	0.27	0.35
Port-Cartier	20	-28	-30	25	19	6060	15	106	730	0.99	1125	300	4.1	0.4	0.42	0.54
Puvirnituc	5	-36	-38	23	16	9200	7	54	210	0.87	375	240	4.5	0.2	0.47	0.60
Québec City Region																
Ancienne-Lorette	35	-25	-28	28	23	5130	20	102	940	1.06	1200	200	3.4	0.6	0.32	0.41
Lévis	50	-25	-28	28	22	5050	20	107	920	1.04	1200	160	3.3	0.6	0.32	0.41
Québec	120	-25	-28	28	22	5080	20	107	925	1.04	1210	200	3.6	0.6	0.32	0.41
Sillery	10	-25	-28	28	23	5070	20	107	930	1.05	1200	200	3.1	0.6	0.32	0.41
Ste-Foy	115	-25	-28	28	23	5100	20	107	940	1.06	1200	180	3.7	0.6	0.32	0.41
Richmond	150	-25	-27	29	22	4700	23	96	870	0.98	1060	160	2.4	0.6	0.25	0.32
Rimouski	30	-25	-27	26	20	5300	18	91	640	0.84	890	200	3.8	0.4	0.40	0.52
Rivière-du-Loup	55	-25	-27	26	21	5380	18	91	660	0.84	900	180	3.5	0.6	0.39	0.50
Roberval	100	-31	-33	28	21	5750	22	91	590	0.77	910	140	3.5	0.3	0.27	0.35
Rock-Island	160	-25	-27	29	23	4850	23	91	900	1.03	1125	160	2.0	0.4	0.27	0.35
Rosemère	25	-24	-26	29	23	4550	23	96	840	0.97	1050	160	2.6	0.4	0.31	0.40
Rouyn	300	-33	-36	29	21	6050	20	91	650	0.82	900	100	3.1	0.3	0.27	0.35
Saguenay	10	-30	-32	28	22	5700	18	86	710	0.88	975	140	2.7	0.4	0.28	0.36

Copyright © NRC 1941 - 2021 World Rights Reserved © CNRC 1941-2021 Droits réservés pour tous pays

**Table C-2 (Continued)**

Province and Location	Elev., m	Design Temperature				De- gree- Days Below 18°C	15 Min. Rain, mm	One Day Rain, 1/50, mm	Ann. Rain, mm	Moist. Index	Ann. Tot. Ppn., mm	Driv- ing Rain Wind Pres- sures, Pa, 1/5	Snow Load, kPa, 1/50		Hourly Wind Pressures, kPa	
		January		July 2.5%									S <sub>s</sub>	S <sub>r</sub>	1/10	1/50
		2.5% °C	1% °C	Dry °C	Wet °C											
Saguenay (Bagotville)	5	-31	-33	28	21	5700	18	86	690	0.86	925	160	2.7	0.4	0.29	0.38
Saguenay (Jonquière)	135	-30	-32	28	22	5650	18	86	710	0.87	925	160	3.1	0.4	0.27	0.35
Saguenay (Kenogami)	140	-30	-32	28	22	5650	18	86	690	0.86	925	160	3.1	0.4	0.27	0.35
Saint-Eustache	35	-25	-27	29	23	4500	23	96	820	0.92	1025	160	2.4	0.4	0.29	0.37
Saint-Jean-sur-Richelieu	35	-24	-26	29	23	4450	23	91	880	0.99	1010	180	2.2	0.4	0.32	0.41
Salaberry-de-Valleyfield	50	-23	-25	29	23	4400	23	96	760	0.87	900	180	2.3	0.4	0.33	0.42
Schefferville	550	-37	-39	24	16	8550	13	64	410	0.81	800	180	4.5	0.3	0.33	0.42
Senneterre	310	-34	-36	29	21	6180	22	91	740	0.91	925	100	3.3	0.3	0.25	0.32
Sept-Îles	5	-29	-31	24	18	6200	15	106	760	1.01	1125	300	4.1	0.4	0.42	0.54
Shawinigan	60	-26	-29	29	23	5050	22	102	820	0.96	1050	180	3.1	0.4	0.27	0.35
Shawville	170	-27	-30	30	23	4880	23	96	670	0.79	880	160	2.8	0.4	0.27	0.35
Sherbrooke	185	-28	-30	29	23	4700	23	96	900	1.03	1100	160	2.2	0.6	0.25	0.32
Sorel	10	-25	-27	29	23	4550	20	102	800	0.93	975	180	2.8	0.4	0.33	0.43
St-Félicien	105	-32	-34	28	22	5850	22	91	570	0.76	900	140	3.5	0.3	0.27	0.35
St-Georges-de-Cacouna	35	-25	-27	26	21	5400	18	91	660	0.85	925	180	3.2	0.6	0.39	0.50
St-Hubert	25	-24	-26	30	23	4490	23	91	820	0.92	1020	180	2.5	0.4	0.33	0.42
Saint-Hubert-de-Rivière-du-Loup	310	-26	-28	26	21	5520	22	91	740	0.90	1025	180	4.4	0.6	0.31	0.40
St-Hyacinthe	35	-24	-27	30	23	4500	21	91	840	0.95	1030	160	2.3	0.4	0.27	0.35
St-Jérôme	95	-26	-28	29	23	4820	23	96	830	0.97	1025	160	2.7	0.4	0.29	0.37
St-Jovite	230	-29	-31	28	22	5250	23	96	810	0.99	1025	160	2.8	0.4	0.25	0.33
St-Lazare-Hudson	60	-24	-26	30	23	4520	23	96	750	0.85	950	180	2.3	0.4	0.33	0.42
St-Nicolas	65	-25	-28	28	22	4990	20	102	890	1.01	1200	200	3.5	0.6	0.33	0.42
Ste-Agathe-des-Monts	360	-28	-30	28	22	5390	23	96	820	1.00	1170	140	3.4	0.4	0.27	0.35
Sutton	185	-25	-27	29	23	4600	23	96	990	1.09	1260	160	2.4	0.4	0.32	0.41
Tadoussac	65	-26	-28	27	21	5450	18	96	700	0.88	1000	180	3.7	0.4	0.40	0.52
Témiscaming	240	-30	-32	30	22	5020	23	96	730	0.88	940	100	2.5	0.4	0.25	0.32
Terrebonne	20	-25	-27	29	23	4500	23	96	830	0.93	1025	160	2.6	0.4	0.31	0.40
Thetford Mines	330	-26	-28	28	22	5120	22	107	950	1.06	1230	160	3.5	0.6	0.27	0.35
Thurso	50	-26	-28	30	23	4820	23	91	800	0.93	950	160	2.4	0.4	0.31	0.40
Trois-Rivières	25	-25	-28	29	23	4900	20	107	860	0.98	1050	180	2.8	0.4	0.33	0.43
Val-d'Or	310	-33	-36	29	21	6180	20	86	640	0.83	925	100	3.4	0.3	0.25	0.32
Varenes	15	-24	-26	30	23	4500	23	96	810	0.94	1000	160	2.6	0.4	0.31	0.40
Verchères	15	-24	-26	30	23	4450	23	96	810	0.94	1000	160	2.7	0.4	0.33	0.43
Victoriaville	125	-26	-28	29	23	4900	21	102	850	0.97	1100	180	2.6	0.6	0.27	0.35
Ville-Marie	200	-31	-34	30	22	5550	23	96	630	0.80	825	120	2.3	0.4	0.31	0.40
Wakefield	120	-27	-30	30	23	4820	23	91	780	0.91	1020	160	2.4	0.4	0.27	0.34

Table C-2 (Continued)

Province and Location	Elev., m	Design Temperature				De- gree- Days Below 18°C	15 Min. Rain, mm	One Day Rain, 1/50, mm	Ann. Rain, mm	Moist. Index	Ann. Tot. Ppn., mm	Driv- ing Rain Wind Pres- sures, Pa, 1/5	Snow Load, kPa, 1/50		Hourly Wind Pressures, kPa	
		January		July 2.5%									S <sub>s</sub>	S <sub>r</sub>	1/10	1/50
		2.5% °C	1% °C	Dry °C	Wet °C											
Waterloo	205	-25	-27	29	23	4650	23	96	980	1.08	1250	160	2.5	0.4	0.27	0.35
Windsor	150	-25	-27	29	23	4700	23	96	930	1.04	1075	160	2.3	0.4	0.25	0.32
<b>New Brunswick</b>																
Alma	5	-21	-23	26	20	4500	18	144	1175	1.32	1450	260	2.6	0.6	0.37	0.48
Bathurst	10	-23	-26	30	22	5020	20	106	775	0.94	1020	180	4.1	0.6	0.37	0.48
Campbellton	30	-26	-28	29	22	5500	20	107	725	0.93	1025	180	4.3	0.4	0.35	0.45
Edmundston	160	-27	-29	28	22	5320	23	91	750	0.94	1000	160	3.4	0.6	0.29	0.38
Fredericton	15	-24	-27	29	22	4670	22	112	900	1.02	1100	160	3.1	0.6	0.29	0.38
Gagetown	20	-24	-26	29	22	4460	20	112	900	1.04	1125	180	2.8	0.6	0.31	0.40
Grand Falls	115	-27	-30	28	22	5300	23	107	850	1.00	1100	160	3.6	0.6	0.29	0.38
Miramichi	5	-24	-26	30	22	4950	20	96	825	0.97	1050	200	3.4	0.6	0.32	0.41
Moncton	20	-23	-25	28	21	4680	20	112	850	1.02	1175	220	3.0	0.6	0.39	0.50
Oromocto	20	-24	-26	29	22	4650	22	112	900	1.02	1110	160	3.0	0.6	0.30	0.39
Sackville	15	-22	-24	27	21	4590	18	112	975	1.14	1175	220	2.5	0.6	0.38	0.49
Saint Andrews	35	-22	-24	25	20	4680	19	123	1000	1.15	1200	220	2.8	0.6	0.35	0.45
Saint George	35	-21	-23	25	20	4680	18	123	1000	1.15	1200	220	2.8	0.6	0.35	0.45
Saint John	5	-22	-24	25	20	4570	18	139	1100	1.27	1425	260	2.3	0.6	0.41	0.53
Shippagan	5	-22	-24	28	21	4930	18	96	800	0.98	1050	260	3.4	0.6	0.48	0.63
St. Stephen	20	-24	-26	28	22	4700	20	123	1000	1.15	1160	180	2.9	0.6	0.33	0.42
Woodstock	60	-26	-29	30	22	4910	22	107	875	0.99	1100	160	3.1	0.6	0.29	0.37
<b>Nova Scotia</b>																
Amherst	25	-21	-24	27	21	4500	18	118	950	1.12	1150	220	2.4	0.6	0.37	0.48
Antigonish	10	-17	-20	27	21	4510	15	123	1100	1.25	1250	240	2.3	0.6	0.42	0.54
Bridgewater	10	-15	-17	27	20	4140	16	144	1300	1.45	1475	260	1.9	0.6	0.43	0.55
Canso	5	-13	-15	25	20	4400	15	123	1325	1.48	1400	260	1.7	0.6	0.48	0.61
Debert	45	-21	-24	27	21	4500	18	118	1000	1.16	1200	240	2.1	0.6	0.37	0.48
Digby	35	-15	-17	25	20	4020	15	130	1100	1.27	1275	260	2.2	0.6	0.43	0.55
Greenwood (CFB)	28	-18	-20	29	22	4140	16	118	925	1.05	1100	280	2.7	0.6	0.42	0.54
Halifax Region																
Dartmouth	10	-16	-18	26	20	4100	18	144	1250	1.40	1400	280	1.6	0.6	0.45	0.58
Halifax	55	-16	-18	26	20	4000	17	150	1350	1.49	1500	280	1.9	0.6	0.45	0.58
Kentville	25	-18	-20	28	21	4130	17	118	950	1.09	1200	260	2.6	0.6	0.42	0.54
Liverpool	20	-16	-18	27	20	3990	16	150	1325	1.48	1425	280	1.7	0.6	0.48	0.61
Lockeport	5	-14	-16	25	20	4000	18	139	1250	1.42	1450	280	1.4	0.6	0.47	0.60
Louisburg	5	-15	-17	26	20	4530	15	118	1300	1.46	1500	300	2.1	0.7	0.50	0.65
Lunenburg	25	-15	-17	26	20	4140	16	144	1300	1.45	1450	260	1.9	0.6	0.48	0.61
New Glasgow	30	-19	-21	27	21	4320	15	135	975	1.13	1200	260	2.2	0.6	0.43	0.55
North Sydney	20	-16	-19	27	21	4500	15	123	1200	1.36	1475	300	2.4	0.6	0.46	0.59
Pictou	25	-19	-21	27	21	4310	15	107	950	1.11	1175	260	2.2	0.6	0.43	0.55
Port Hawkesbury	40	-17	-19	27	21	4500	15	128	1325	1.48	1450	260	2.1	0.6	0.57	0.74

Copyright © NRC 1941 - 2021 World Rights Reserved © CNRC 1941-2021 Droits réservés pour tous pays

**Table C-2 (Continued)**

Province and Location	Elev., m	Design Temperature				De- gree- Days Below 18°C	15 Min. Rain, mm	One Day Rain, 1/50, mm	Ann. Rain, mm	Moist. Index	Ann. Tot. Ppn., mm	Driv- ing Rain Wind Pres- sures, Pa, 1/5	Snow Load, kPa, 1/50		Hourly Wind Pressures, kPa	
		January		July 2.5%									S <sub>s</sub>	S <sub>t</sub>	1/10	1/50
		2.5% °C	1% °C	Dry °C	Wet °C											
Springhill	185	-20	-23	27	21	4540	18	118	1075	1.22	1175	220	3.1	0.6	0.37	0.48
Stewiacke	25	-20	-22	27	21	4400	18	128	1050	1.20	1250	240	1.8	0.6	0.39	0.50
Sydney	5	-16	-19	27	21	4530	15	123	1200	1.36	1475	300	2.3	0.6	0.46	0.59
Tatamagouche	25	-20	-23	27	21	4380	18	118	875	1.05	1150	260	2.2	0.6	0.43	0.55
Truro	25	-20	-22	27	21	4500	18	118	1000	1.16	1175	240	2.0	0.6	0.37	0.48
Wolfville	35	-19	-21	28	21	4140	17	118	975	1.13	1175	260	2.6	0.6	0.42	0.54
Yarmouth	10	-14	-16	22	19	3990	19	135	1125	1.32	1260	280	1.8	0.6	0.43	0.56
<b>Prince Edward Island</b>																
Charlottetown	5	-20	-22	26	21	4460	16	107	900	1.09	1150	350	2.7	0.6	0.43	0.56
Souris	5	-19	-21	27	21	4550	15	112	950	1.14	1130	350	2.7	0.6	0.45	0.58
Summerside	10	-20	-22	27	21	4600	16	112	825	1.03	1060	350	3.1	0.6	0.47	0.60
Tignish	10	-20	-22	27	21	4770	16	96	800	1.01	1100	350	3.2	0.6	0.51	0.66
<b>Newfoundland</b>																
Argentia	15	-12	-14	21	18	4600	15	107	1250	1.47	1400	400	2.4	0.7	0.58	0.75
Bonavista	15	-14	-16	24	19	5000	18	96	825	1.11	1010	400	3.1	0.6	0.65	0.84
Buchans	255	-24	-27	27	20	5250	13	107	850	1.04	1125	200	4.7	0.6	0.47	0.60
Cape Harrison	5	-29	-31	26	16	6900	10	106	475	0.94	950	350	6.3	0.4	0.47	0.60
Cape Race	5	-11	-13	19	18	4900	18	130	1425	1.66	1550	400	2.3	0.7	0.81	1.05
Channel-Port aux Basques	5	-13	-15	19	18	5000	13	123	1175	1.43	1520	450	3.6	0.7	0.60	0.78
Corner Brook	35	-16	-18	26	20	4760	13	91	875	1.08	1190	300	3.7	0.6	0.43	0.55
Gander	125	-18	-20	27	20	5110	18	91	775	1.01	1180	280	3.7	0.6	0.47	0.60
Grand Bank	5	-14	-15	20	18	4550	15	123	1350	1.58	1525	400	2.4	0.7	0.57	0.74
Grand Falls	60	-26	-29	27	20	5020	15	86	775	0.97	1030	240	3.4	0.6	0.47	0.60
Happy Valley-Goose Bay	15	-31	-32	27	19	6670	18	80	575	0.83	960	160	5.3	0.4	0.33	0.42
Labrador City	550	-36	-38	24	17	7710	15	70	500	0.82	880	140	4.8	0.3	0.31	0.40
St. Anthony	10	-25	-27	22	18	6440	13	86	800	1.07	1280	450	6.1	0.6	0.67	0.87
St. John's	65	-15	-16	24	20	4800	18	118	1200	1.41	1575	400	2.9	0.7	0.60	0.78
Stephenville	25	-16	-18	24	19	4850	14	102	1000	1.19	1275	350	4.1	0.6	0.45	0.58
Twin Falls	425	-35	-37	24	17	7790	15	70	500	0.85	950	120	4.8	0.4	0.31	0.40
Wabana	75	-15	-17	24	20	4750	18	112	1125	1.34	1500	400	3.0	0.7	0.58	0.75
Wabush	550	-36	-38	24	17	7710	15	70	500	0.82	880	140	4.8	0.3	0.31	0.40
<b>Yukon</b>																
Aishihik	920	-44	-46	23	15	7500	8	43	190	0.57	275	40	1.9	0.1	0.29	0.38
Dawson	330	-50	-51	26	16	8120	10	49	200	0.57	350	40	2.9	0.1	0.24	0.31
Destruction Bay	815	-43	-45	23	14	7800	8	49	190	0.62	300	80	1.9	0.1	0.47	0.60
Faro	670	-46	-47	25	16	7300	10	33	215	0.58	315	40	2.3	0.1	0.27	0.35
Haines Junction	600	-45	-47	24	14	7100	8	51	145	0.56	315	180	2.2	0.1	0.26	0.34
Snag	595	-51	-53	23	16	8300	8	59	290	0.57	350	40	2.2	0.1	0.24	0.31
Teslin	690	-42	-44	24	15	6770	10	38	200	0.51	340	40	3.0	0.1	0.26	0.34

Table C-2 (Continued)

Province and Location	Elev., m	Design Temperature				De- gree- Days Below 18°C	15 Min. Rain, mm	One Day Rain, 1/50, mm	Ann. Rain, mm	Moist. Index	Ann. Tot. Ppn., mm	Driv- ing Rain Wind Pres- sures, Pa, 1/5	Snow Load, kPa, 1/50		Hourly Wind Pressures, kPa	
		January		July 2.5%									S <sub>s</sub>	S <sub>r</sub>	1/10	1/50
		2.5% °C	1% °C	Dry °C	Wet °C											
Watson Lake	685	-46	-48	26	16	7470	10	54	250	0.55	410	60	3.2	0.1	0.27	0.35
Whitehorse	655	-41	-43	25	15	6580	8	43	170	0.49	275	40	2.0	0.1	0.29	0.38
<b>Northwest Territories</b>																
Aklavik	5	-42	-44	26	17	9600	6	49	115	0.67	250	60	2.8	0.1	0.37	0.48
Echo Bay / Port Radium	195	-42	-44	22	16	9300	8	60	160	0.70	250	80	3.0	0.1	0.41	0.53
Fort Good Hope	100	-43	-45	28	18	8700	9	60	140	0.60	280	80	2.9	0.1	0.34	0.44
Fort McPherson	25	-44	-46	26	17	9150	6	50	145	0.67	315	60	3.2	0.1	0.31	0.40
Fort Providence	150	-40	-43	28	18	7620	10	71	210	0.56	350	100	2.4	0.1	0.27	0.35
Fort Resolution	160	-40	-42	26	18	7750	10	60	175	0.61	300	140	2.3	0.1	0.30	0.39
Fort Simpson	120	-42	-44	28	19	7660	12	76	225	0.56	360	80	2.3	0.1	0.30	0.39
Fort Smith	205	-41	-43	28	19	7300	10	65	250	0.56	350	80	2.3	0.2	0.30	0.39
Hay River	45	-38	-41	27	18	7550	10	60	200	0.62	150	140	2.4	0.1	0.27	0.35
Holman/ Ulukhaqtuuq	10	-39	-41	18	12	10700	3	44	80	0.93	250	120	2.1	0.1	0.66	0.86
Inuvik	45	-43	-45	26	17	9600	6	49	115	0.67	425	60	3.1	0.1	0.37	0.48
Mould Bay	5	-44	-46	11	8	12900	3	33	25	0.94	100	140	1.5	0.1	0.45	0.58
Norman Wells	65	-43	-45	28	18	8510	9	60	165	0.57	320	80	3.0	0.1	0.34	0.44
Rae-Edzo	160	-42	-44	25	17	8300	10	60	175	0.59	275	80	2.3	0.1	0.36	0.47
Tungsten	1340	-49	-51	26	16	7700	10	44	315	0.75	640	40	4.3	0.1	0.34	0.44
Wrigley	80	-42	-44	28	18	8050	10	54	220	0.58	350	80	2.8	0.1	0.30	0.39
Yellowknife	160	-41	-44	25	17	8170	10	60	175	0.58	275	100	2.2	0.1	0.36	0.47
<b>Nunavut</b>																
Alert	5	-43	-44	13	8	13030	3	22	20	0.95	150	100	2.6	0.1	0.58	0.75
Arctic Bay	15	-42	-44	14	10	11900	3	38	60	0.90	150	160	2.4	0.1	0.43	0.55
Arviat / Eskimo Point	5	-40	-41	22	16	9850	8	65	225	0.85	300	240	3.0	0.2	0.45	0.58
Baker Lake	5	-42	-44	23	15	10700	5	55	160	0.84	260	180	3.4	0.2	0.42	0.54
Cambridge Bay/Iqaluktuutiaq	15	-41	-44	18	13	11670	4	38	70	0.89	140	100	1.9	0.1	0.42	0.54
Chesterfield Inlet/Igluligaarjuk	10	-40	-41	20	14	10500	5	60	175	0.88	270	240	3.6	0.2	0.43	0.56
Clyde River /Kanngiqugaapik	5	-40	-42	14	10	11300	5	44	55	0.90	225	220	4.2	0.2	0.56	0.72
Coppermine (Kugluktuk)	10	-41	-43	23	16	10300	6	65	140	0.84	150	80	3.4	0.1	0.36	0.46
Coral Harbour /Salliq	15	-41	-42	20	14	10720	5	65	150	0.87	280	200	3.8	0.2	0.54	0.69
Eureka	5	-47	-48	12	8	13500	3	27	25	0.95	70	100	1.6	0.1	0.43	0.55
Iqaluit	45	-40	-41	17	12	9980	5	58	200	0.86	433	200	2.9	0.2	0.45	0.58
Isachsen	10	-46	-48	12	9	13600	3	27	25	0.95	75	140	1.9	0.1	0.47	0.60
Nottingham Island	30	-37	-39	16	13	10000	5	54	175	0.88	325	200	4.7	0.2	0.60	0.78
Rankin Inlet (Kangiqiniq)	10	-41	-42	21	15	10500	5	65	180	0.87	250	240	3.0	0.2	0.47	0.60

Copyright © NRC 1941 - 2021 World Rights Reserved © CNRC 1941-2021 Droits réservés pour tous pays



Table C-2 (Continued)

Province and Location	Elev., m	Design Temperature				De- gree- Days Below 18°C	15 Min. Rain, mm	One Day Rain, 1/50, mm	Ann. Rain, mm	Moist. Index	Ann. Tot. Ppn., mm	Driv- ing Rain Wind Pres- sures, Pa, 1/5	Snow Load, kPa, 1/50		Hourly Wind Pressures, kPa	
		January		July 2.5%									S <sub>s</sub>	S <sub>t</sub>	1/10	1/50
		2.5% °C	1% °C	Dry °C	Wet °C											
Resolute	25	-42	-43	11	9	12360	3	27	50	0.93	140	180	2.0	0.1	0.54	0.69
Resolution Island	5	-32	-34	12	10	9000	5	71	240	0.89	550	200	5.5	0.2	0.95	1.23

Seismic Hazard

The parameters used to represent seismic hazard for specific geographical locations are the 5%-damped horizontal spectral acceleration for 0.2, 0.5, 1.0, 2.0, 5.0 and 10.0 second periods, the horizontal Peak Ground Acceleration (PGA) and the horizontal Peak Ground Velocity (PGV), with all values given for a 2% probability of being exceeded in 50 years. The six spectral parameters are deemed sufficient to define spectra closely matching the shape of the Uniform Hazard Spectra (UHS). Hazard values are mean values based on a statistical analysis of the earthquakes that have been experienced in Canada and adjacent regions.<sup>(11)</sup> The seismic hazard values were updated for the 2015 edition of the Code by updating the earthquake catalogue, revising the seismic source zones, adding fault sources for the Cascadia subduction zone and certain other active faults, revising the Ground Motion Prediction Equations (GMPEs),<sup>(12)</sup> and using a probabilistic model to combine all inputs.

For most locations, the new GMPEs are the most significant reason for changes in the hazard results from the NBC 2010. One exception is for areas of western Canada for which adding the Cascadia subduction source contribution to the model probabilistically causes the most significant change. In general, for locations in eastern Canada, the seismic hazard at long periods has increased while the seismic hazard at short periods has decreased—in some places significantly. For locations in western Canada, the seismic hazard at long periods has increased significantly for areas affected by the Cascadia interface. For other areas, the explicit inclusion of fault sources, such as those in Haida Gwaii and the Yukon, has also affected the estimated hazard.

Further details regarding the representation of seismic hazard can be found in the Commentary on Design for Seismic Effects in the “User’s Guide – NBC 2015, Structural Commentaries (Part 4 of Division B).”

Table C-3  
Seismic Design Data for Selected Locations in Canada

Province and Location	Seismic Data							
	S <sub>a</sub> (0.2)	S <sub>a</sub> (0.5)	S <sub>a</sub> (1.0)	S <sub>a</sub> (2.0)	S <sub>a</sub> (5.0)	S <sub>a</sub> (10.0)	PGA	PGV
<b>British Columbia</b>								
100 Mile House	0.140	0.113	0.083	0.058	0.027	0.0080	0.064	0.109
Abbotsford	0.701	0.597	0.350	0.215	0.071	0.025	0.306	0.445
Agassiz	0.457	0.384	0.244	0.157	0.057	0.020	0.206	0.306
Alberni	0.955	0.915	0.594	0.373	0.124	0.044	0.434	0.683
Ashcroft	0.198	0.160	0.115	0.078	0.034	0.011	0.092	0.149
Bamfield	1.44	1.35	0.871	0.525	0.167	0.059	0.682	0.931
Beaton River	0.132	0.083	0.049	0.026	0.0083	0.0037	0.079	0.056
Bella Bella	0.208	0.232	0.187	0.129	0.049	0.017	0.103	0.286
Bella Coola	0.163	0.172	0.143	0.105	0.043	0.014	0.083	0.225
Burns Lake	0.095	0.080	0.066	0.052	0.024	0.0076	0.043	0.111
Cache Creek	0.195	0.157	0.112	0.077	0.034	0.010	0.090	0.148
Campbell River	0.595	0.582	0.408	0.265	0.094	0.034	0.283	0.487
Carmi	0.141	0.120	0.090	0.062	0.028	0.0086	0.065	0.111
Castlegar	0.129	0.100	0.074	0.048	0.022	0.0069	0.058	0.085
Chetwynd	0.176	0.121	0.068	0.033	0.013	0.0045	0.082	0.071

**Table C-3 (Continued)**

Province and Location	Seismic Data							
	S <sub>a</sub> (0.2)	S <sub>a</sub> (0.5)	S <sub>a</sub> (1.0)	S <sub>a</sub> (2.0)	S <sub>a</sub> (5.0)	S <sub>a</sub> (10.0)	PGA	PGV
Chilliwack	0.539	0.448	0.277	0.174	0.062	0.021	0.242	0.347
Comox	0.685	0.662	0.455	0.292	0.102	0.036	0.317	0.538
Courtenay	0.692	0.670	0.461	0.296	0.104	0.037	0.321	0.545
Cranbrook	0.170	0.138	0.089	0.047	0.018	0.0062	0.075	0.085
Crescent Valley	0.130	0.101	0.073	0.047	0.021	0.0067	0.058	0.082
Crofton	1.13	1.04	0.598	0.358	0.111	0.039	0.491	0.754
Dawson Creek	0.150	0.098	0.055	0.026	0.0080	0.0032	0.080	0.059
Dease Lake	0.103	0.091	0.074	0.049	0.017	0.0067	0.044	0.078
Dog Creek	0.172	0.140	0.102	0.071	0.032	0.0098	0.079	0.140
Duncan	1.17	1.09	0.631	0.378	0.118	0.042	0.513	0.786
Elko	0.217	0.174	0.108	0.053	0.019	0.0066	0.098	0.101
Fernie	0.234	0.175	0.106	0.052	0.019	0.0065	0.106	0.101
Fort Nelson	0.141	0.103	0.068	0.036	0.012	0.0049	0.081	0.071
Fort St. John	0.145	0.094	0.053	0.026	0.0077	0.0032	0.079	0.058
Glacier	0.206	0.142	0.081	0.044	0.018	0.0058	0.093	0.083
Gold River	1.01	0.988	0.664	0.413	0.135	0.048	0.466	0.743
Golden	0.263	0.174	0.094	0.046	0.017	0.0056	0.120	0.095
Grand Forks	0.133	0.108	0.082	0.056	0.026	0.0079	0.061	0.101
Greenwood	0.136	0.113	0.085	0.059	0.027	0.0082	0.063	0.105
Hope	0.363	0.304	0.201	0.131	0.051	0.017	0.167	0.251
Jordan River	1.40	1.31	0.817	0.495	0.157	0.055	0.639	0.923
Kamloops	0.146	0.123	0.091	0.064	0.029	0.0087	0.067	0.117
Kaslo	0.142	0.109	0.073	0.043	0.019	0.0062	0.063	0.076
Kelowna	0.143	0.122	0.091	0.063	0.029	0.0087	0.066	0.115
Kimberley	0.165	0.130	0.084	0.045	0.018	0.0060	0.073	0.080
Kitimat Plant	0.161	0.167	0.137	0.096	0.036	0.012	0.080	0.224
Kitimat Townsite	0.161	0.167	0.137	0.096	0.036	0.012	0.080	0.224
Ladysmith	1.10	1.02	0.587	0.353	0.110	0.039	0.482	0.738
Langford	1.32	1.19	0.697	0.415	0.130	0.045	0.590	0.852
Lillooet	0.285	0.214	0.145	0.096	0.040	0.013	0.132	0.188
Lytton	0.292	0.228	0.155	0.103	0.042	0.013	0.136	0.197
Mackenzie	0.165	0.117	0.066	0.036	0.015	0.0052	0.074	0.078
Masset	0.791	0.744	0.496	0.283	0.083	0.029	0.364	0.632
McBride	0.253	0.165	0.089	0.044	0.018	0.0056	0.117	0.097
McLeod Lake	0.153	0.110	0.064	0.037	0.016	0.0053	0.068	0.078
Merritt	0.211	0.175	0.125	0.085	0.037	0.011	0.098	0.160
Mission City	0.644	0.550	0.327	0.204	0.069	0.024	0.283	0.419
Montrose	0.129	0.102	0.075	0.049	0.022	0.0069	0.058	0.086
Nakusp	0.135	0.102	0.070	0.045	0.020	0.0063	0.060	0.079
Nanaimo	1.02	0.942	0.542	0.328	0.104	0.037	0.446	0.684
Nelson	0.131	0.103	0.073	0.046	0.020	0.0065	0.058	0.080
Ocean Falls	0.180	0.199	0.163	0.117	0.046	0.015	0.091	0.258

Copyright © NRC 1941 - 2021 World Rights Reserved © CNRC 1941-2021 Droits réservés pour tous pays

**Table C-3 (Continued)**

Province and Location	Seismic Data							
	S <sub>a</sub> (0.2)	S <sub>a</sub> (0.5)	S <sub>a</sub> (1.0)	S <sub>a</sub> (2.0)	S <sub>a</sub> (5.0)	S <sub>a</sub> (10.0)	PGA	PGV
Osoyoos	0.175	0.150	0.110	0.075	0.033	0.010	0.081	0.138
Parksville	0.917	0.859	0.519	0.322	0.106	0.038	0.405	0.639
Penticton	0.159	0.138	0.101	0.070	0.031	0.0096	0.074	0.129
Port Alberni	0.987	0.946	0.614	0.383	0.126	0.045	0.450	0.702
Port Alice	1.60	1.27	0.759	0.412	0.128	0.042	0.689	0.868
Port Hardy	0.700	0.659	0.447	0.272	0.091	0.032	0.320	0.543
Port McNeill	0.711	0.678	0.464	0.285	0.096	0.034	0.326	0.557
Port Renfrew	1.44	1.35	0.850	0.511	0.162	0.057	0.668	0.939
Powell River	0.595	0.556	0.373	0.242	0.086	0.031	0.273	0.457
Prince George	0.113	0.089	0.059	0.040	0.019	0.0059	0.049	0.079
Prince Rupert	0.246	0.269	0.209	0.135	0.046	0.016	0.117	0.314
Princeton	0.259	0.209	0.144	0.096	0.040	0.012	0.121	0.182
Qualicum Beach	0.888	0.838	0.517	0.323	0.108	0.038	0.395	0.629
Queen Charlotte City	1.62	1.37	0.842	0.452	0.124	0.041	0.757	0.989
Quesnel	0.105	0.088	0.065	0.047	0.022	0.0069	0.047	0.091
Revelstoke	0.145	0.109	0.070	0.043	0.019	0.0062	0.064	0.078
Salmon Arm	0.131	0.104	0.075	0.052	0.024	0.0073	0.059	0.093
Sandspit	1.31	1.16	0.724	0.396	0.110	0.036	0.603	0.868
Sechelt	0.828	0.745	0.434	0.265	0.086	0.030	0.363	0.555
Sidney	1.23	1.10	0.630	0.371	0.115	0.040	0.545	0.790
Smith River	0.705	0.447	0.234	0.100	0.028	0.0096	0.354	0.255
Smithers	0.100	0.090	0.076	0.058	0.025	0.0082	0.047	0.134
Sooke	1.34	1.24	0.752	0.456	0.144	0.050	0.605	0.885
Squamish	0.600	0.517	0.314	0.200	0.069	0.024	0.266	0.404
Stewart	0.139	0.132	0.111	0.078	0.029	0.010	0.068	0.180
Tahsis	1.35	1.19	0.767	0.456	0.144	0.050	0.622	0.852
Taylor	0.143	0.093	0.052	0.025	0.0076	0.0031	0.079	0.058
Terrace	0.146	0.145	0.120	0.085	0.032	0.011	0.072	0.200
Tofino	1.46	1.36	0.891	0.536	0.170	0.060	0.695	0.945
Trail	0.129	0.101	0.075	0.050	0.022	0.0070	0.058	0.087
Ucluelet	1.48	1.38	0.897	0.539	0.171	0.060	0.708	0.949
Vancouver Region								
Burnaby (Simon Fraser Univ.)	0.768	0.673	0.386	0.236	0.076	0.027	0.333	0.500
Cloverdale	0.800	0.702	0.400	0.243	0.077	0.027	0.347	0.519
Haney	0.691	0.602	0.352	0.217	0.071	0.025	0.301	0.452
Ladner	0.924	0.827	0.461	0.276	0.085	0.030	0.399	0.601
Langley	0.772	0.674	0.387	0.236	0.076	0.027	0.335	0.500
New Westminster	0.800	0.704	0.401	0.244	0.077	0.027	0.347	0.522
North Vancouver	0.794	0.699	0.399	0.243	0.077	0.027	0.345	0.518
Richmond	0.885	0.787	0.443	0.266	0.083	0.029	0.383	0.578
Surrey (88 Ave & 156 St.)	0.786	0.690	0.394	0.240	0.076	0.027	0.341	0.511
Vancouver (City Hall)	0.848	0.751	0.425	0.257	0.080	0.029	0.369	0.553

**Table C-3 (Continued)**

Province and Location	Seismic Data							PGA	PGV
	S <sub>a</sub> (0.2)	S <sub>a</sub> (0.5)	S <sub>a</sub> (1.0)	S <sub>a</sub> (2.0)	S <sub>a</sub> (5.0)	S <sub>a</sub> (10.0)			
Vancouver (Granville & 41 Ave)	0.863	0.765	0.432	0.261	0.081	0.029	0.375	0.563	
West Vancouver	0.818	0.721	0.410	0.250	0.079	0.028	0.356	0.534	
Vernon	0.133	0.108	0.080	0.056	0.025	0.0077	0.061	0.099	
Victoria Region									
Victoria (Gonzales Hts)	1.30	1.15	0.668	0.394	0.123	0.043	0.576	0.829	
Victoria (Mt Tolmie)	1.29	1.14	0.662	0.390	0.121	0.042	0.573	0.824	
Victoria	1.30	1.16	0.676	0.399	0.125	0.044	0.580	0.834	
Whistler	0.438	0.357	0.233	0.152	0.058	0.020	0.203	0.296	
White Rock	0.868	0.765	0.432	0.260	0.081	0.029	0.376	0.562	
Williams Lake	0.136	0.110	0.081	0.057	0.027	0.0080	0.062	0.110	
Youbou	1.20	1.13	0.678	0.414	0.131	0.046	0.536	0.816	
<b>Alberta</b>									
Athabasca	0.068	0.043	0.027	0.014	0.0041	0.0018	0.039	0.031	
Banff	0.279	0.184	0.099	0.046	0.016	0.0053	0.128	0.097	
Barrhead	0.105	0.064	0.038	0.019	0.0055	0.0024	0.065	0.046	
Beaverlodge	0.153	0.102	0.057	0.028	0.0090	0.0035	0.081	0.062	
Brooks	0.116	0.076	0.051	0.028	0.0089	0.0042	0.072	0.056	
Calgary	0.192	0.126	0.072	0.036	0.012	0.0048	0.098	0.075	
Campsie	0.113	0.067	0.040	0.020	0.0058	0.0024	0.070	0.048	
Camrose	0.095	0.058	0.035	0.018	0.0052	0.0022	0.058	0.042	
Canmore	0.278	0.183	0.098	0.046	0.016	0.0053	0.128	0.097	
Cardston	0.273	0.203	0.122	0.058	0.018	0.0066	0.131	0.118	
Claresholm	0.217	0.148	0.090	0.044	0.015	0.0056	0.107	0.089	
Cold Lake	0.055	0.034	0.019	0.0078	0.0016	0.0008	0.032	0.023	
Coleman	0.279	0.195	0.114	0.054	0.019	0.0065	0.128	0.110	
Coronation	0.075	0.048	0.029	0.015	0.0046	0.0020	0.044	0.034	
Cowley	0.282	0.198	0.116	0.055	0.018	0.0065	0.130	0.113	
Drumheller	0.122	0.077	0.048	0.026	0.0080	0.0037	0.075	0.055	
Edmonton	0.103	0.062	0.036	0.018	0.0053	0.0022	0.064	0.044	
Edson	0.165	0.111	0.062	0.030	0.0089	0.0035	0.087	0.066	
Embarras Portage	0.052	0.031	0.016	0.0065	0.0013	0.0007	0.030	0.020	
Fairview	0.121	0.071	0.041	0.020	0.0059	0.0025	0.075	0.051	
Fort MacLeod	0.225	0.160	0.097	0.047	0.015	0.0058	0.111	0.095	
Fort McMurray	0.053	0.034	0.018	0.0078	0.0016	0.0008	0.031	0.023	
Fort Saskatchewan	0.086	0.053	0.032	0.017	0.0050	0.0021	0.052	0.038	
Fort Vermilion	0.056	0.036	0.019	0.0081	0.0018	0.0008	0.032	0.024	
Grande Prairie	0.141	0.093	0.053	0.026	0.0074	0.0031	0.079	0.058	
Habay	0.068	0.045	0.033	0.020	0.0067	0.0031	0.040	0.036	
Hardisty	0.068	0.043	0.027	0.014	0.0041	0.0018	0.040	0.031	
High River	0.203	0.134	0.079	0.039	0.013	0.0052	0.101	0.079	
Hinton	0.280	0.182	0.096	0.043	0.015	0.0048	0.131	0.097	
Jasper	0.287	0.190	0.101	0.046	0.017	0.0052	0.132	0.101	

Copyright © NRC 1941 - 2021 World Rights Reserved © CNRC 1941-2021 Droits réservés pour tous pays

**Table C-3 (Continued)**

Province and Location	Seismic Data							
	S <sub>a</sub> (0.2)	S <sub>a</sub> (0.5)	S <sub>a</sub> (1.0)	S <sub>a</sub> (2.0)	S <sub>a</sub> (5.0)	S <sub>a</sub> (10.0)	PGA	PGV
Keg River	0.067	0.042	0.025	0.012	0.0034	0.0015	0.039	0.030
Lac la Biche	0.059	0.038	0.023	0.011	0.0033	0.0015	0.034	0.027
Lacombe	0.127	0.081	0.047	0.023	0.0065	0.0027	0.077	0.055
Lethbridge	0.164	0.125	0.081	0.042	0.013	0.0053	0.087	0.079
Manning	0.081	0.049	0.029	0.015	0.0046	0.0020	0.048	0.036
Medicine Hat	0.083	0.060	0.045	0.026	0.0083	0.0039	0.050	0.047
Peace River	0.098	0.058	0.034	0.017	0.0052	0.0022	0.061	0.043
Pincher Creek	0.284	0.202	0.119	0.056	0.019	0.0066	0.132	0.115
Ranfurly	0.066	0.042	0.026	0.013	0.0039	0.0018	0.038	0.030
Red Deer	0.131	0.085	0.049	0.024	0.0067	0.0028	0.078	0.056
Rocky Mountain House	0.174	0.116	0.065	0.030	0.0090	0.0035	0.090	0.067
Slave Lake	0.075	0.047	0.029	0.015	0.0046	0.0020	0.044	0.034
Stettler	0.109	0.066	0.039	0.019	0.0056	0.0024	0.067	0.047
Stony Plain	0.115	0.069	0.040	0.020	0.0058	0.0025	0.071	0.050
Suffield	0.099	0.068	0.049	0.028	0.0087	0.0041	0.060	0.052
Taber	0.134	0.101	0.069	0.036	0.012	0.0049	0.079	0.070
Turner Valley	0.253	0.164	0.091	0.043	0.015	0.0053	0.122	0.093
Valleyview	0.126	0.078	0.045	0.022	0.0064	0.0027	0.077	0.054
Vegreville	0.069	0.044	0.027	0.014	0.0041	0.0018	0.040	0.031
Vermilion	0.060	0.038	0.023	0.012	0.0034	0.0015	0.035	0.027
Wagner	0.077	0.048	0.030	0.015	0.0046	0.0020	0.046	0.035
Wainwright	0.062	0.040	0.025	0.012	0.0037	0.0017	0.036	0.028
Wetaskiwin	0.115	0.069	0.040	0.020	0.0058	0.0024	0.071	0.048
Whitecourt	0.125	0.079	0.046	0.023	0.0064	0.0027	0.076	0.054
Wimborne	0.133	0.087	0.052	0.027	0.0081	0.0037	0.078	0.058
<b>Saskatchewan</b>								
Assiniboia	0.136	0.076	0.038	0.016	0.0034	0.0014	0.084	0.054
Battrum	0.065	0.042	0.024	0.012	0.0031	0.0015	0.037	0.030
Biggar	0.057	0.037	0.021	0.0088	0.0019	0.0010	0.033	0.025
Broadview	0.077	0.048	0.025	0.010	0.0022	0.0011	0.045	0.034
Dafoe	0.062	0.040	0.022	0.0089	0.0019	0.0010	0.036	0.027
Dundurn	0.059	0.039	0.022	0.0092	0.0019	0.0010	0.034	0.027
Estevan	0.129	0.072	0.035	0.015	0.0031	0.0013	0.079	0.051
Hudson Bay	0.055	0.034	0.019	0.0079	0.0016	0.0008	0.032	0.023
Humboldt	0.058	0.037	0.020	0.0085	0.0018	0.0010	0.033	0.025
Island Falls	0.054	0.031	0.016	0.0065	0.0013	0.0007	0.031	0.021
Kamsack	0.058	0.037	0.020	0.0085	0.0018	0.0010	0.033	0.025
Kindersley	0.060	0.039	0.024	0.012	0.0033	0.0015	0.035	0.028
Lloydminster	0.057	0.036	0.021	0.010	0.0030	0.0015	0.033	0.025
Maple Creek	0.069	0.048	0.036	0.021	0.0068	0.0032	0.040	0.039
Meadow Lake	0.055	0.034	0.018	0.0075	0.0016	0.0008	0.032	0.023
Melfort	0.055	0.035	0.019	0.0081	0.0018	0.0010	0.032	0.024
Melville	0.069	0.044	0.023	0.0097	0.0021	0.0011	0.040	0.031

**Table C-3 (Continued)**

Province and Location	Seismic Data							
	S <sub>a</sub> (0.2)	S <sub>a</sub> (0.5)	S <sub>a</sub> (1.0)	S <sub>a</sub> (2.0)	S <sub>a</sub> (5.0)	S <sub>a</sub> (10.0)	PGA	PGV
Moose Jaw	0.096	0.058	0.030	0.013	0.0027	0.0013	0.057	0.042
Nipawin	0.054	0.034	0.018	0.0078	0.0016	0.0008	0.032	0.023
North Battleford	0.056	0.036	0.020	0.0085	0.0018	0.0010	0.032	0.024
Prince Albert	0.055	0.034	0.019	0.0078	0.0016	0.0008	0.032	0.023
Qu'Appelle	0.090	0.054	0.028	0.012	0.0025	0.0011	0.054	0.039
Regina	0.101	0.060	0.030	0.013	0.0027	0.0013	0.061	0.043
Rosetown	0.059	0.038	0.022	0.0091	0.0019	0.0010	0.034	0.027
Saskatoon	0.057	0.037	0.021	0.0089	0.0019	0.0010	0.033	0.025
Scott	0.057	0.037	0.020	0.0086	0.0019	0.0010	0.033	0.025
Strasbourg	0.074	0.046	0.025	0.010	0.0022	0.0011	0.043	0.032
Swift Current	0.070	0.045	0.025	0.012	0.0030	0.0014	0.040	0.032
Uranium City	0.053	0.032	0.016	0.0066	0.0013	0.0007	0.031	0.021
Weyburn	0.186	0.097	0.045	0.018	0.0039	0.0014	0.118	0.070
Yorkton	0.063	0.040	0.022	0.0091	0.0019	0.0010	0.036	0.028
<b>Manitoba</b>								
Beausejour	0.056	0.033	0.017	0.0067	0.0015	0.0007	0.032	0.021
Boissevain	0.059	0.037	0.020	0.0082	0.0018	0.0010	0.034	0.025
Brandon	0.054	0.031	0.016	0.0063	0.0013	0.0007	0.031	0.020
Churchill	0.053	0.032	0.017	0.0069	0.0015	0.0008	0.031	0.021
Dauphin	0.055	0.035	0.019	0.0079	0.0018	0.0010	0.032	0.024
Flin Flon	0.054	0.032	0.016	0.0065	0.0013	0.0007	0.031	0.021
Gimli	0.055	0.032	0.017	0.0067	0.0015	0.0007	0.032	0.021
Island Lake	0.054	0.033	0.017	0.0070	0.0015	0.0008	0.031	0.021
Lac du Bonnet	0.056	0.033	0.017	0.0067	0.0015	0.0007	0.033	0.023
Lynn Lake	0.053	0.032	0.016	0.0066	0.0013	0.0007	0.031	0.021
Morden	0.053	0.031	0.015	0.0063	0.0013	0.0007	0.031	0.020
Neepawa	0.054	0.031	0.016	0.0065	0.0013	0.0007	0.031	0.021
Pine Falls	0.056	0.033	0.017	0.0067	0.0015	0.0007	0.032	0.021
Portage la Prairie	0.054	0.032	0.016	0.0065	0.0013	0.0007	0.031	0.021
Rivers	0.058	0.037	0.020	0.0084	0.0018	0.0010	0.034	0.025
Sandilands	0.055	0.032	0.016	0.0065	0.0013	0.0007	0.032	0.021
Selkirk	0.055	0.032	0.016	0.0066	0.0013	0.0007	0.032	0.021
Split Lake	0.053	0.032	0.017	0.0067	0.0015	0.0007	0.031	0.021
Steinbach	0.055	0.032	0.016	0.0065	0.0013	0.0007	0.032	0.021
Swan River	0.055	0.035	0.019	0.0079	0.0018	0.0008	0.032	0.024
The Pas	0.054	0.032	0.016	0.0065	0.0013	0.0007	0.031	0.021
Thompson	0.053	0.032	0.017	0.0067	0.0015	0.0007	0.031	0.021
Virden	0.064	0.041	0.022	0.0089	0.0019	0.0010	0.037	0.028
Winnipeg	0.054	0.032	0.016	0.0066	0.0013	0.0007	0.032	0.021
<b>Ontario</b>								
Ailsa Craig	0.095	0.064	0.039	0.020	0.0049	0.0021	0.056	0.050
Ajax	0.210	0.114	0.060	0.029	0.0071	0.0028	0.134	0.091

Copyright © NRC 1941 - 2021 World Rights Reserved © CNRC 1941-2021 Droits réservés pour tous pays

**Table C-3 (Continued)**

Province and Location	Seismic Data							
	S <sub>a</sub> (0.2)	S <sub>a</sub> (0.5)	S <sub>a</sub> (1.0)	S <sub>a</sub> (2.0)	S <sub>a</sub> (5.0)	S <sub>a</sub> (10.0)	PGA	PGV
Alexandria	0.589	0.309	0.148	0.068	0.018	0.0062	0.376	0.255
Alliston	0.111	0.076	0.046	0.024	0.0059	0.0025	0.066	0.060
Almonte	0.337	0.188	0.098	0.048	0.013	0.0049	0.215	0.157
Armstrong	0.064	0.037	0.019	0.0081	0.0018	0.0008	0.038	0.025
Arnprior	0.371	0.201	0.102	0.049	0.013	0.0049	0.238	0.168
Atikokan	0.069	0.038	0.018	0.0072	0.0015	0.0007	0.041	0.025
Attawapiskat	0.074	0.043	0.022	0.0092	0.0019	0.0010	0.045	0.030
Aurora	0.138	0.087	0.050	0.026	0.0064	0.0027	0.085	0.068
Bancroft	0.151	0.105	0.063	0.032	0.0084	0.0035	0.090	0.085
Barrie	0.108	0.077	0.047	0.025	0.0061	0.0025	0.063	0.060
Barriefield	0.162	0.110	0.066	0.034	0.0089	0.0038	0.098	0.091
Beaverton	0.117	0.082	0.050	0.026	0.0065	0.0028	0.069	0.064
Belleville	0.162	0.105	0.061	0.031	0.0080	0.0034	0.100	0.087
Belmont	0.116	0.073	0.042	0.021	0.0053	0.0021	0.070	0.056
Kitchenuhmay-koosib (Big Trout Lake)	0.054	0.033	0.017	0.0072	0.0015	0.0008	0.032	0.023
CFB Borden	0.107	0.075	0.046	0.024	0.0059	0.0025	0.063	0.059
Bracebridge	0.116	0.084	0.051	0.027	0.0068	0.0028	0.068	0.067
Bradford	0.123	0.081	0.048	0.025	0.0062	0.0027	0.074	0.063
Brampton	0.168	0.096	0.052	0.026	0.0064	0.0025	0.106	0.074
Brantford	0.155	0.089	0.049	0.024	0.0059	0.0024	0.097	0.068
Brighton	0.173	0.106	0.060	0.030	0.0076	0.0032	0.108	0.087
Brockville	0.259	0.157	0.086	0.043	0.011	0.0046	0.164	0.131
Burk's Falls	0.143	0.096	0.057	0.029	0.0074	0.0031	0.086	0.076
Burlington	0.266	0.131	0.062	0.029	0.0068	0.0027	0.172	0.102
Cambridge	0.141	0.084	0.047	0.024	0.0058	0.0024	0.088	0.066
Campbellford	0.144	0.097	0.058	0.030	0.0076	0.0032	0.088	0.078
Cannington	0.122	0.084	0.051	0.027	0.0067	0.0028	0.073	0.067
Carleton Place	0.302	0.175	0.093	0.046	0.012	0.0048	0.192	0.146
Cavan	0.140	0.092	0.055	0.028	0.0071	0.0030	0.086	0.074
Centralia	0.092	0.064	0.039	0.020	0.0050	0.0021	0.054	0.050
Chapleau	0.071	0.050	0.031	0.016	0.0037	0.0017	0.041	0.039
Chatham	0.112	0.070	0.039	0.019	0.0047	0.0020	0.068	0.054
Chesley	0.083	0.062	0.040	0.021	0.0052	0.0022	0.047	0.050
Clinton	0.084	0.061	0.038	0.020	0.0049	0.0021	0.048	0.048
Coboconk	0.120	0.086	0.052	0.027	0.0070	0.0030	0.070	0.068
Cobourg	0.179	0.106	0.059	0.030	0.0074	0.0031	0.113	0.086
Cochrane	0.222	0.107	0.052	0.024	0.0058	0.0022	0.145	0.083
Colborne	0.176	0.106	0.060	0.030	0.0076	0.0031	0.111	0.087
Collingwood	0.096	0.070	0.044	0.023	0.0058	0.0024	0.055	0.056
Cornwall	0.587	0.307	0.147	0.067	0.017	0.0060	0.375	0.254
Corunna	0.087	0.060	0.036	0.018	0.0046	0.0020	0.050	0.047
Deep River	0.389	0.208	0.104	0.049	0.013	0.0048	0.250	0.172

**Table C-3 (Continued)**

Province and Location	Seismic Data							
	S <sub>a</sub> (0.2)	S <sub>a</sub> (0.5)	S <sub>a</sub> (1.0)	S <sub>a</sub> (2.0)	S <sub>a</sub> (5.0)	S <sub>a</sub> (10.0)	PGA	PGV
Deseronto	0.158	0.106	0.062	0.032	0.0081	0.0035	0.096	0.087
Dorchester	0.112	0.072	0.042	0.021	0.0052	0.0021	0.067	0.056
Dorion	0.059	0.035	0.018	0.0076	0.0016	0.0008	0.035	0.024
Dresden	0.104	0.067	0.039	0.019	0.0047	0.0020	0.062	0.051
Dryden	0.072	0.040	0.019	0.0076	0.0016	0.0008	0.043	0.027
Dundalk	0.097	0.069	0.043	0.022	0.0056	0.0024	0.057	0.055
Dunnville	0.232	0.120	0.059	0.028	0.0067	0.0027	0.149	0.093
Durham	0.088	0.065	0.041	0.021	0.0053	0.0022	0.051	0.051
Dutton	0.116	0.072	0.041	0.021	0.0050	0.0021	0.071	0.056
Earlton	0.182	0.108	0.059	0.029	0.0074	0.0030	0.114	0.086
Edison	0.070	0.039	0.019	0.0075	0.0016	0.0008	0.042	0.027
Elliot Lake	0.074	0.054	0.035	0.018	0.0046	0.0020	0.043	0.043
Elmvale	0.101	0.074	0.046	0.024	0.0061	0.0025	0.059	0.059
Embro	0.111	0.072	0.042	0.022	0.0053	0.0022	0.067	0.056
Englehart	0.175	0.104	0.057	0.029	0.0073	0.0030	0.109	0.083
Espanola	0.086	0.063	0.039	0.021	0.0052	0.0021	0.050	0.050
Exeter	0.090	0.063	0.039	0.020	0.0049	0.0021	0.052	0.050
Fenelon Falls	0.121	0.086	0.052	0.027	0.0068	0.0030	0.072	0.068
Fergus	0.115	0.075	0.045	0.023	0.0056	0.0024	0.069	0.059
Forest	0.087	0.061	0.037	0.019	0.0047	0.0020	0.051	0.047
Fort Erie	0.312	0.152	0.070	0.032	0.0074	0.0028	0.202	0.117
Fort Erie (Ridgeway)	0.307	0.149	0.069	0.031	0.0073	0.0028	0.198	0.115
Fort Frances	0.064	0.035	0.017	0.0069	0.0015	0.0007	0.039	0.024
Gananoque	0.180	0.119	0.070	0.036	0.0095	0.0039	0.110	0.099
Geraldton	0.057	0.036	0.019	0.0082	0.0018	0.0010	0.033	0.024
Glencoe	0.107	0.068	0.040	0.020	0.0049	0.0021	0.064	0.054
Goderich	0.079	0.059	0.037	0.019	0.0049	0.0020	0.045	0.047
Gore Bay	0.071	0.055	0.035	0.018	0.0047	0.0020	0.040	0.044
Graham	0.071	0.039	0.020	0.0079	0.0016	0.0008	0.043	0.027
Gravenhurst (Muskoka Airport)	0.112	0.082	0.050	0.026	0.0067	0.0028	0.065	0.064
Grimsby	0.301	0.146	0.068	0.030	0.0073	0.0028	0.195	0.113
Guelph	0.133	0.082	0.047	0.024	0.0058	0.0024	0.082	0.063
Guthrie	0.109	0.078	0.048	0.025	0.0062	0.0027	0.064	0.062
Haileybury	0.219	0.127	0.067	0.033	0.0083	0.0034	0.138	0.101
Haldimand (Caledonia)	0.215	0.112	0.056	0.027	0.0064	0.0025	0.138	0.087
Haldimand (Hagersville)	0.172	0.096	0.051	0.025	0.0061	0.0024	0.108	0.074
Haliburton	0.133	0.095	0.057	0.030	0.0077	0.0032	0.079	0.076
Halton Hills (Georgetown)	0.155	0.090	0.050	0.025	0.0062	0.0025	0.097	0.070
Hamilton	0.260	0.128	0.061	0.028	0.0068	0.0027	0.168	0.101
Hanover	0.085	0.063	0.040	0.021	0.0052	0.0022	0.049	0.050
Hastings	0.141	0.096	0.057	0.029	0.0074	0.0031	0.085	0.076
Hawkesbury	0.506	0.268	0.131	0.062	0.016	0.0058	0.326	0.224

Copyright © NRC 1941 - 2021 World Rights Reserved © CNRC 1941-2021 Droits réservés pour tous pays



**Table C-3 (Continued)**

Province and Location	Seismic Data							
	S <sub>a</sub> (0.2)	S <sub>a</sub> (0.5)	S <sub>a</sub> (1.0)	S <sub>a</sub> (2.0)	S <sub>a</sub> (5.0)	S <sub>a</sub> (10.0)	PGA	PGV
Hearst	0.073	0.048	0.028	0.013	0.0031	0.0014	0.043	0.035
Honey Harbour	0.103	0.076	0.047	0.025	0.0062	0.0027	0.060	0.060
Hornepayne	0.063	0.043	0.025	0.012	0.0028	0.0014	0.037	0.031
Huntsville	0.129	0.091	0.054	0.028	0.0071	0.0031	0.077	0.072
Ingersoll	0.116	0.073	0.043	0.022	0.0053	0.0022	0.070	0.058
Iroquois Falls	0.196	0.101	0.052	0.025	0.0061	0.0024	0.127	0.079
Jellicoe	0.057	0.035	0.019	0.0081	0.0018	0.0010	0.033	0.024
Kapuskasing	0.112	0.064	0.035	0.017	0.0040	0.0017	0.070	0.048
Kemptville	0.429	0.229	0.114	0.054	0.014	0.0052	0.275	0.189
Kenora	0.064	0.036	0.018	0.0072	0.0015	0.0007	0.038	0.024
Killaloe	0.264	0.154	0.083	0.041	0.011	0.0044	0.168	0.127
Kincardine	0.076	0.058	0.037	0.019	0.0049	0.0021	0.043	0.046
Kingston	0.161	0.110	0.065	0.034	0.0089	0.0038	0.098	0.091
Kinmount	0.123	0.089	0.054	0.028	0.0071	0.0031	0.072	0.071
Kirkland Lake	0.159	0.095	0.053	0.027	0.0067	0.0028	0.099	0.076
Kitchener	0.122	0.077	0.045	0.023	0.0056	0.0024	0.074	0.060
Lakefield	0.130	0.091	0.055	0.028	0.0073	0.0031	0.078	0.072
Lansdowne House	0.056	0.035	0.019	0.0078	0.0016	0.0008	0.033	0.024
Leamington	0.114	0.070	0.038	0.018	0.0044	0.0018	0.069	0.052
Lindsay	0.126	0.087	0.052	0.027	0.0068	0.0030	0.076	0.068
Lion's Head	0.080	0.062	0.040	0.021	0.0052	0.0022	0.045	0.050
Listowel	0.093	0.066	0.041	0.021	0.0052	0.0022	0.054	0.052
London	0.108	0.070	0.041	0.021	0.0052	0.0021	0.064	0.055
Lucan	0.097	0.065	0.039	0.020	0.0050	0.0021	0.057	0.051
Maitland	0.282	0.167	0.090	0.045	0.012	0.0046	0.179	0.140
Markdale	0.089	0.066	0.042	0.022	0.0055	0.0022	0.052	0.052
Markham	0.182	0.103	0.056	0.028	0.0068	0.0028	0.115	0.080
Martin	0.072	0.039	0.019	0.0075	0.0015	0.0008	0.043	0.027
Matheson	0.160	0.091	0.050	0.025	0.0062	0.0025	0.101	0.072
Mattawa	0.446	0.237	0.114	0.052	0.013	0.0046	0.285	0.191
Midland	0.101	0.075	0.046	0.024	0.0061	0.0025	0.058	0.059
Milton	0.191	0.103	0.054	0.026	0.0064	0.0025	0.122	0.080
Milverton	0.098	0.067	0.041	0.021	0.0053	0.0022	0.058	0.052
Minden	0.124	0.089	0.054	0.028	0.0071	0.0031	0.073	0.071
Mississauga	0.219	0.115	0.058	0.028	0.0068	0.0027	0.141	0.090
Mississauga (Lester B. Pearson Int'l Airport)	0.193	0.105	0.056	0.027	0.0067	0.0027	0.123	0.082
Mississauga (Port Credit)	0.247	0.125	0.062	0.029	0.0070	0.0027	0.159	0.098
Mitchell	0.093	0.065	0.040	0.021	0.0052	0.0021	0.054	0.051
Moosonee	0.081	0.051	0.029	0.014	0.0033	0.0015	0.049	0.038
Morrisburg	0.558	0.287	0.135	0.062	0.016	0.0056	0.358	0.236
Mount Forest	0.093	0.067	0.041	0.022	0.0053	0.0022	0.054	0.052
Nakina	0.057	0.036	0.019	0.0082	0.0018	0.0010	0.033	0.024
Nanticoke (Jarvis)	0.156	0.090	0.049	0.024	0.0059	0.0024	0.098	0.068

**Table C-3 (Continued)**

Province and Location	Seismic Data							
	S <sub>a</sub> (0.2)	S <sub>a</sub> (0.5)	S <sub>a</sub> (1.0)	S <sub>a</sub> (2.0)	S <sub>a</sub> (5.0)	S <sub>a</sub> (10.0)	PGA	PGV
Nanticoke (Port Dover)	0.144	0.085	0.047	0.023	0.0058	0.0024	0.089	0.066
Napanee	0.156	0.106	0.063	0.033	0.0084	0.0037	0.095	0.087
New Liskeard	0.209	0.122	0.065	0.032	0.0081	0.0032	0.132	0.097
Newcastle	0.186	0.107	0.058	0.029	0.0071	0.0030	0.118	0.086
Newcastle (Bowmanville)	0.188	0.107	0.058	0.029	0.0071	0.0030	0.119	0.086
Newmarket	0.132	0.085	0.050	0.026	0.0064	0.0027	0.081	0.067
Niagara Falls	0.321	0.157	0.072	0.032	0.0076	0.0030	0.207	0.121
North Bay	0.247	0.145	0.076	0.037	0.0095	0.0037	0.155	0.114
Norwood	0.136	0.094	0.057	0.029	0.0074	0.0031	0.082	0.075
Oakville	0.260	0.129	0.062	0.029	0.0070	0.0027	0.167	0.101
Orangeville	0.115	0.076	0.046	0.023	0.0058	0.0024	0.069	0.059
Orillia	0.109	0.079	0.049	0.026	0.0064	0.0027	0.064	0.063
Oshawa	0.192	0.108	0.058	0.029	0.0071	0.0030	0.122	0.086
Ottawa (Metropolitan)								
Ottawa (City Hall)	0.439	0.237	0.118	0.056	0.015	0.0055	0.281	0.196
Ottawa (Barrhaven)	0.427	0.230	0.115	0.055	0.015	0.0053	0.273	0.191
Ottawa (Kanata)	0.401	0.218	0.110	0.053	0.014	0.0052	0.257	0.181
Ottawa (M-C Int'l Airport)	0.446	0.240	0.119	0.056	0.015	0.0055	0.285	0.199
Ottawa (Orleans)	0.474	0.252	0.124	0.058	0.015	0.0056	0.304	0.208
Owen Sound	0.083	0.064	0.041	0.021	0.0053	0.0022	0.048	0.051
Pagwa River	0.060	0.040	0.023	0.011	0.0024	0.0013	0.035	0.028
Paris	0.141	0.084	0.047	0.023	0.0058	0.0024	0.088	0.066
Parkhill	0.092	0.063	0.038	0.020	0.0049	0.0020	0.054	0.050
Parry Sound	0.110	0.079	0.048	0.025	0.0064	0.0027	0.064	0.063
Pelham (Fonthill)	0.311	0.152	0.070	0.031	0.0074	0.0028	0.201	0.117
Pembroke	0.379	0.203	0.101	0.049	0.013	0.0048	0.243	0.168
Penetanguishene	0.101	0.074	0.046	0.024	0.0061	0.0025	0.058	0.059
Perth	0.225	0.142	0.080	0.041	0.011	0.0045	0.140	0.119
Petawawa	0.379	0.202	0.101	0.048	0.013	0.0048	0.243	0.166
Peterborough	0.135	0.092	0.055	0.028	0.0071	0.0031	0.082	0.072
Petrolia	0.092	0.062	0.037	0.019	0.0047	0.0020	0.054	0.048
Pickering (Dunbarton)	0.219	0.117	0.060	0.029	0.0071	0.0028	0.140	0.094
Picton	0.159	0.104	0.061	0.031	0.0078	0.0032	0.098	0.086
Plattsville	0.119	0.075	0.044	0.022	0.0055	0.0022	0.072	0.059
Point Alexander	0.391	0.209	0.104	0.049	0.013	0.0048	0.251	0.172
Port Burwell	0.132	0.079	0.044	0.022	0.0055	0.0022	0.081	0.062
Port Colborne	0.298	0.146	0.068	0.031	0.0073	0.0028	0.192	0.113
Port Elgin	0.077	0.060	0.038	0.020	0.0050	0.0021	0.044	0.048
Port Hope	0.181	0.106	0.059	0.029	0.0073	0.0030	0.114	0.086
Port Perry	0.144	0.091	0.053	0.027	0.0067	0.0028	0.089	0.071
Port Stanley	0.123	0.075	0.043	0.021	0.0052	0.0021	0.075	0.058
Prescott	0.350	0.195	0.101	0.049	0.013	0.0049	0.224	0.162

Copyright © NRC 1941 - 2021 World Rights Reserved © CNRC 1941-2021 Droits réservés pour tous pays

**Table C-3 (Continued)**

Province and Location	Seismic Data							
	S <sub>a</sub> (0.2)	S <sub>a</sub> (0.5)	S <sub>a</sub> (1.0)	S <sub>a</sub> (2.0)	S <sub>a</sub> (5.0)	S <sub>a</sub> (10.0)	PGA	PGV
Princeton	0.129	0.079	0.045	0.023	0.0056	0.0022	0.079	0.062
Raith	0.067	0.038	0.019	0.0078	0.0016	0.0008	0.040	0.025
Rayside-Balfour (Chelmsford)	0.104	0.072	0.044	0.023	0.0058	0.0024	0.061	0.056
Red Lake	0.068	0.038	0.019	0.0076	0.0016	0.0008	0.041	0.025
Renfrew	0.352	0.191	0.097	0.047	0.013	0.0048	0.226	0.160
Richmond Hill	0.163	0.095	0.053	0.027	0.0065	0.0027	0.102	0.074
Rockland	0.510	0.266	0.129	0.060	0.016	0.0056	0.328	0.221
Sarnia	0.085	0.059	0.036	0.018	0.0046	0.0020	0.049	0.046
Sault Ste. Marie	0.062	0.044	0.028	0.014	0.0033	0.0015	0.036	0.034
Schreiber	0.057	0.035	0.019	0.0079	0.0018	0.0010	0.033	0.024
Seaforth	0.087	0.062	0.039	0.020	0.0050	0.0021	0.050	0.048
Shelburne	0.104	0.072	0.044	0.023	0.0058	0.0024	0.062	0.056
Simcoe	0.141	0.084	0.047	0.023	0.0058	0.0024	0.087	0.064
Sioux Lookout	0.073	0.040	0.020	0.0078	0.0016	0.0008	0.044	0.028
Smiths Falls	0.256	0.156	0.086	0.044	0.012	0.0046	0.161	0.131
Smithville	0.296	0.144	0.067	0.030	0.0071	0.0027	0.191	0.111
Smooth Rock Falls	0.200	0.098	0.047	0.021	0.0050	0.0020	0.130	0.074
South River	0.164	0.106	0.061	0.031	0.0080	0.0034	0.100	0.085
Southampton	0.077	0.060	0.038	0.020	0.0050	0.0021	0.044	0.048
St. Catharines	0.319	0.155	0.071	0.032	0.0076	0.0028	0.206	0.121
St. Mary's	0.101	0.068	0.041	0.021	0.0052	0.0021	0.060	0.052
St. Thomas	0.117	0.073	0.042	0.021	0.0052	0.0021	0.071	0.056
Stirling	0.149	0.100	0.060	0.031	0.0078	0.0034	0.091	0.082
Stratford	0.103	0.069	0.041	0.021	0.0053	0.0022	0.061	0.054
Strathroy	0.100	0.066	0.039	0.020	0.0049	0.0021	0.059	0.051
Sturgeon Falls	0.183	0.113	0.062	0.031	0.0080	0.0032	0.113	0.089
Sudbury	0.110	0.076	0.046	0.024	0.0059	0.0025	0.065	0.059
Sundridge	0.157	0.103	0.059	0.030	0.0078	0.0032	0.095	0.082
Tavistock	0.108	0.071	0.042	0.022	0.0053	0.0022	0.065	0.055
Temagami	0.239	0.138	0.072	0.035	0.0089	0.0035	0.151	0.109
Thamesford	0.111	0.071	0.042	0.021	0.0053	0.0022	0.066	0.056
Theford	0.089	0.062	0.038	0.019	0.0047	0.0020	0.052	0.048
Thunder Bay	0.061	0.035	0.018	0.0075	0.0016	0.0008	0.036	0.024
Tillsonburg	0.126	0.077	0.044	0.022	0.0055	0.0022	0.076	0.060
Timmins	0.125	0.075	0.043	0.021	0.0053	0.0022	0.078	0.058
Timmins (Porcupine)	0.140	0.081	0.045	0.022	0.0055	0.0022	0.088	0.063
Toronto Metropolitan Region								
Etobicoke	0.193	0.106	0.056	0.027	0.0067	0.0027	0.124	0.082
North York	0.195	0.107	0.056	0.028	0.0067	0.0027	0.125	0.083
Scarborough	0.219	0.116	0.060	0.029	0.0070	0.0028	0.140	0.093
Toronto (City Hall)	0.249	0.126	0.063	0.029	0.0071	0.0028	0.160	0.099
Trenton	0.167	0.105	0.060	0.030	0.0077	0.0032	0.104	0.086

**Table C-3 (Continued)**

Province and Location	Seismic Data							PGA	PGV
	S <sub>a</sub> (0.2)	S <sub>a</sub> (0.5)	S <sub>a</sub> (1.0)	S <sub>a</sub> (2.0)	S <sub>a</sub> (5.0)	S <sub>a</sub> (10.0)			
Trout Creek	0.186	0.116	0.065	0.033	0.0084	0.0035	0.115	0.093	
Uxbridge	0.139	0.089	0.052	0.027	0.0067	0.0028	0.086	0.070	
Vaughan (Woodbridge)	0.167	0.096	0.053	0.026	0.0065	0.0027	0.105	0.074	
Vittoria	0.139	0.083	0.046	0.023	0.0056	0.0024	0.086	0.064	
Walkerton	0.083	0.062	0.039	0.021	0.0052	0.0021	0.048	0.050	
Wallaceburg	0.098	0.064	0.037	0.018	0.0044	0.0018	0.058	0.048	
Waterloo	0.118	0.075	0.044	0.023	0.0056	0.0022	0.072	0.059	
Watford	0.095	0.064	0.038	0.019	0.0049	0.0020	0.056	0.050	
Wawa	0.062	0.043	0.026	0.013	0.0030	0.0014	0.036	0.031	
Welland	0.308	0.150	0.069	0.031	0.0074	0.0028	0.199	0.115	
West Lorne	0.118	0.072	0.041	0.021	0.0050	0.0021	0.072	0.056	
Whitby	0.203	0.112	0.059	0.029	0.0071	0.0028	0.130	0.089	
Whitby (Brooklin)	0.176	0.102	0.056	0.028	0.0070	0.0028	0.111	0.080	
White River	0.060	0.041	0.024	0.011	0.0025	0.0013	0.035	0.030	
Warton	0.080	0.062	0.040	0.021	0.0052	0.0022	0.046	0.050	
Windsor	0.096	0.063	0.035	0.017	0.0041	0.0017	0.057	0.048	
Wingham	0.083	0.061	0.039	0.020	0.0050	0.0021	0.048	0.048	
Woodstock	0.118	0.075	0.043	0.022	0.0055	0.0022	0.071	0.058	
Wyoming	0.090	0.061	0.037	0.019	0.0047	0.0020	0.053	0.048	
<b>Quebec</b>									
Acton-Vale	0.254	0.160	0.091	0.047	0.013	0.0051	0.159	0.138	
Alma	0.785	0.416	0.196	0.089	0.022	0.0075	0.486	0.339	
Amos	0.109	0.078	0.049	0.026	0.0067	0.0028	0.064	0.063	
Asbestos	0.200	0.137	0.082	0.043	0.012	0.0049	0.123	0.118	
Aylmer	0.415	0.225	0.113	0.054	0.014	0.0053	0.265	0.186	
Baie-Comeau	0.425	0.219	0.107	0.051	0.013	0.0051	0.275	0.182	
Baie-Saint-Paul	1.62	0.872	0.406	0.179	0.043	0.012	0.986	0.735	
Beauport	0.509	0.275	0.138	0.067	0.018	0.0065	0.327	0.233	
Bedford	0.358	0.204	0.107	0.053	0.014	0.0053	0.228	0.170	
Beloil	0.522	0.272	0.131	0.062	0.016	0.0059	0.333	0.225	
Brome	0.236	0.152	0.087	0.045	0.012	0.0049	0.147	0.130	
Brossard	0.587	0.306	0.145	0.067	0.017	0.0062	0.374	0.251	
Buckingham	0.491	0.257	0.125	0.058	0.015	0.0056	0.316	0.213	
Campbell's Bay	0.387	0.208	0.105	0.050	0.013	0.0051	0.248	0.173	
Chambly	0.550	0.286	0.137	0.064	0.017	0.0059	0.352	0.236	
Coaticook	0.193	0.129	0.077	0.040	0.011	0.0045	0.119	0.110	
Contrecoeur	0.473	0.251	0.124	0.059	0.016	0.0058	0.303	0.207	
Cowansville	0.273	0.168	0.094	0.048	0.013	0.0051	0.172	0.142	
Deux-Montagnes	0.596	0.313	0.149	0.069	0.018	0.0062	0.380	0.258	
Dolbeau	0.484	0.255	0.125	0.058	0.015	0.0055	0.308	0.211	
Drummondville	0.273	0.167	0.094	0.048	0.013	0.0052	0.172	0.144	
Farnham	0.369	0.208	0.109	0.054	0.015	0.0055	0.235	0.174	

Copyright © NRC 1941 - 2021 World Rights Reserved © CNRC 1941-2021 Droits réservés pour tous pays

**Table C-3 (Continued)**

Province and Location	Seismic Data							
	S <sub>a</sub> (0.2)	S <sub>a</sub> (0.5)	S <sub>a</sub> (1.0)	S <sub>a</sub> (2.0)	S <sub>a</sub> (5.0)	S <sub>a</sub> (10.0)	PGA	PGV
Fort-Coulonge	0.391	0.210	0.105	0.050	0.013	0.0051	0.251	0.174
Gagnon	0.078	0.060	0.040	0.021	0.0055	0.0022	0.045	0.048
Gaspé	0.128	0.090	0.056	0.029	0.0077	0.0032	0.076	0.074
Gatineau	0.442	0.238	0.119	0.056	0.015	0.0055	0.283	0.197
Gracefield	0.426	0.222	0.109	0.051	0.013	0.0051	0.278	0.185
Granby	0.275	0.169	0.094	0.048	0.013	0.0052	0.173	0.144
Harrington-Harbour	0.072	0.056	0.037	0.020	0.0052	0.0022	0.041	0.046
Havre-St-Pierre	0.231	0.122	0.062	0.030	0.0077	0.0031	0.148	0.097
Hemmingford	0.546	0.290	0.141	0.066	0.017	0.0060	0.347	0.239
Hull	0.432	0.234	0.117	0.056	0.015	0.0055	0.276	0.195
Iberville	0.520	0.273	0.132	0.062	0.016	0.0059	0.332	0.225
Inukjuak	0.065	0.040	0.022	0.0094	0.0021	0.0010	0.038	0.028
Joliette	0.457	0.241	0.119	0.057	0.015	0.0056	0.293	0.201
Kuujuuaq	0.074	0.054	0.036	0.019	0.0049	0.0021	0.043	0.043
Kuujuarapik	0.056	0.035	0.019	0.0078	0.0016	0.0008	0.032	0.024
La Pocatière	1.51	0.817	0.384	0.170	0.041	0.012	0.927	0.690
La-Malbaie	1.73	0.954	0.454	0.203	0.049	0.014	1.04	0.809
La-Tuque	0.196	0.137	0.082	0.043	0.012	0.0049	0.120	0.119
Lac-Mégantic	0.193	0.130	0.077	0.040	0.011	0.0045	0.119	0.111
Lachute	0.518	0.274	0.133	0.063	0.016	0.0059	0.333	0.228
Lennoxville	0.187	0.129	0.077	0.041	0.011	0.0046	0.114	0.110
Léry	0.603	0.318	0.152	0.070	0.018	0.0063	0.384	0.262
Loretteville	0.502	0.268	0.134	0.065	0.017	0.0063	0.323	0.227
Louiseville	0.366	0.201	0.105	0.052	0.014	0.0055	0.234	0.170
Magog	0.196	0.133	0.079	0.042	0.011	0.0046	0.120	0.114
Malartic	0.135	0.092	0.055	0.029	0.0074	0.0031	0.081	0.074
Maniwaki	0.430	0.220	0.107	0.050	0.013	0.0049	0.282	0.184
Masson	0.498	0.261	0.127	0.059	0.016	0.0056	0.320	0.216
Matane	0.455	0.230	0.110	0.052	0.013	0.0051	0.295	0.191
Mont-Joli	0.427	0.226	0.113	0.055	0.015	0.0055	0.275	0.191
Mont-Laurier	0.419	0.212	0.103	0.049	0.013	0.0048	0.276	0.177
Montmagny	0.601	0.341	0.172	0.082	0.022	0.0075	0.382	0.286
Montréal Region								
Beaconsfield	0.602	0.317	0.152	0.070	0.018	0.0063	0.383	0.260
Dorval	0.600	0.316	0.151	0.069	0.018	0.0062	0.382	0.259
Laval	0.595	0.311	0.148	0.068	0.018	0.0062	0.379	0.256
Montréal (City Hall)	0.595	0.311	0.148	0.068	0.018	0.0062	0.379	0.255
Montréal-Est	0.586	0.305	0.145	0.067	0.017	0.0062	0.374	0.250
Montréal-Nord	0.593	0.309	0.147	0.068	0.017	0.0062	0.378	0.254
Outremont	0.597	0.313	0.149	0.068	0.018	0.0062	0.380	0.256
Pierrefonds	0.599	0.315	0.151	0.069	0.018	0.0062	0.382	0.259
St-Lambert	0.590	0.307	0.146	0.067	0.017	0.0062	0.376	0.252

**Table C-3 (Continued)**

Province and Location	Seismic Data							PGA	PGV
	S <sub>a</sub> (0.2)	S <sub>a</sub> (0.5)	S <sub>a</sub> (1.0)	S <sub>a</sub> (2.0)	S <sub>a</sub> (5.0)	S <sub>a</sub> (10.0)			
St-Laurent	0.598	0.314	0.149	0.069	0.018	0.0062	0.381	0.258	
Ste-Anne-de-Bellevue	0.602	0.317	0.152	0.070	0.018	0.0063	0.383	0.262	
Verdun	0.596	0.312	0.149	0.068	0.018	0.0062	0.380	0.256	
Nicolet (Gentilly)	0.364	0.201	0.106	0.052	0.015	0.0055	0.233	0.170	
Nitchequon	0.062	0.047	0.031	0.017	0.0041	0.0018	0.035	0.038	
Noranda	0.132	0.088	0.052	0.027	0.0068	0.0028	0.080	0.070	
Percé	0.114	0.084	0.053	0.029	0.0074	0.0032	0.067	0.068	
Pin court	0.602	0.318	0.152	0.070	0.018	0.0063	0.384	0.262	
Plessisville	0.250	0.160	0.092	0.048	0.013	0.0052	0.157	0.140	
Port-Cartier	0.323	0.169	0.084	0.040	0.010	0.0039	0.210	0.137	
Puvirnituk	0.108	0.058	0.029	0.012	0.0025	0.0011	0.068	0.043	
Québec City Region									
Ancienne-Lorette	0.487	0.258	0.130	0.062	0.017	0.0062	0.314	0.220	
Lévis	0.493	0.265	0.134	0.065	0.017	0.0063	0.317	0.225	
Québec	0.493	0.265	0.133	0.064	0.017	0.0063	0.318	0.225	
Sillery	0.486	0.260	0.131	0.063	0.017	0.0062	0.313	0.221	
Ste-Foy	0.488	0.261	0.131	0.063	0.017	0.0062	0.315	0.221	
Richmond	0.208	0.140	0.083	0.044	0.012	0.0049	0.128	0.121	
Rimouski	0.408	0.224	0.116	0.056	0.015	0.0056	0.262	0.192	
Rivière-du-Loup	1.16	0.616	0.288	0.129	0.032	0.0097	0.724	0.517	
Roberval	0.688	0.353	0.164	0.074	0.019	0.0065	0.430	0.287	
Rock-Island	0.199	0.133	0.078	0.041	0.011	0.0046	0.123	0.113	
Rosemère	0.591	0.309	0.147	0.068	0.017	0.0062	0.377	0.255	
Rouyn	0.134	0.089	0.052	0.027	0.0068	0.0028	0.081	0.070	
Saguenay	0.791	0.425	0.204	0.095	0.024	0.0080	0.491	0.353	
Saguenay (Bagotville)	0.801	0.434	0.210	0.098	0.025	0.0083	0.498	0.362	
Saguenay (Jonquière)	0.798	0.428	0.206	0.095	0.024	0.0080	0.495	0.354	
Saguenay (Kenogami)	0.799	0.428	0.206	0.095	0.024	0.0080	0.496	0.354	
Saint-Eustache	0.593	0.311	0.149	0.068	0.018	0.0062	0.378	0.256	
Saint-Jean-sur-Richelieu	0.522	0.274	0.133	0.062	0.016	0.0059	0.333	0.227	
Salaberry-de-Valleyfield	0.602	0.318	0.152	0.070	0.018	0.0063	0.384	0.262	
Schefferville	0.059	0.042	0.027	0.014	0.0033	0.0015	0.034	0.031	
Senneterre	0.114	0.083	0.052	0.028	0.0071	0.0031	0.067	0.067	
Sept-Îles	0.295	0.156	0.078	0.037	0.0095	0.0038	0.191	0.126	
Shawinigan	0.306	0.179	0.098	0.049	0.014	0.0053	0.195	0.154	
Shawville	0.386	0.208	0.105	0.050	0.013	0.0051	0.248	0.173	
Sherbrooke	0.187	0.129	0.078	0.041	0.011	0.0046	0.115	0.111	
Sorel	0.406	0.220	0.113	0.055	0.015	0.0056	0.259	0.184	
St-Félicien	0.488	0.259	0.127	0.059	0.016	0.0056	0.309	0.212	
St-Georges-de-Cacouna	0.857	0.478	0.234	0.109	0.028	0.0090	0.533	0.396	
St-Hubert	0.581	0.302	0.144	0.066	0.017	0.0060	0.371	0.248	
Saint-Hubert-de-Rivière-du-Loup	0.468	0.279	0.147	0.073	0.020	0.0069	0.298	0.237	

Copyright © NRC 1941 - 2021 World Rights Reserved © CNRC 1941-2021 Droits réservés pour tous pays

**Table C-3 (Continued)**

Province and Location	Seismic Data							
	S <sub>a</sub> (0.2)	S <sub>a</sub> (0.5)	S <sub>a</sub> (1.0)	S <sub>a</sub> (2.0)	S <sub>a</sub> (5.0)	S <sub>a</sub> (10.0)	PGA	PGV
St-Hyacinthe	0.369	0.208	0.109	0.054	0.015	0.0055	0.235	0.174
St-Jérôme	0.539	0.282	0.135	0.063	0.017	0.0059	0.346	0.233
St-Jovite	0.428	0.222	0.110	0.052	0.014	0.0052	0.281	0.186
St-Lazare-Hudson	0.597	0.315	0.151	0.070	0.018	0.0062	0.380	0.259
St-Nicolas	0.466	0.248	0.125	0.060	0.016	0.0060	0.301	0.211
Ste-Agathe-des-Monts	0.431	0.226	0.112	0.054	0.014	0.0053	0.282	0.191
Sutton	0.243	0.154	0.088	0.045	0.012	0.0049	0.152	0.131
Tadoussac	0.694	0.399	0.202	0.097	0.026	0.0084	0.434	0.335
Témiscaming	0.820	0.411	0.181	0.075	0.017	0.0053	0.516	0.329
Terrebonne	0.584	0.304	0.144	0.067	0.017	0.0060	0.373	0.250
Thetford Mines	0.207	0.142	0.084	0.044	0.012	0.0049	0.127	0.123
Thurso	0.492	0.258	0.126	0.059	0.016	0.0056	0.318	0.215
Trois-Rivières	0.366	0.200	0.105	0.052	0.014	0.0055	0.234	0.170
Val-d'Or	0.135	0.093	0.056	0.029	0.0076	0.0032	0.081	0.074
Varenes	0.571	0.296	0.141	0.065	0.017	0.0060	0.365	0.243
Verchères	0.537	0.278	0.134	0.062	0.016	0.0059	0.343	0.229
Victoriaville	0.233	0.152	0.089	0.046	0.013	0.0051	0.145	0.133
Ville-Marie	0.262	0.148	0.076	0.037	0.0093	0.0037	0.166	0.117
Wakefield	0.409	0.222	0.111	0.054	0.014	0.0053	0.262	0.185
Waterloo	0.232	0.150	0.087	0.045	0.012	0.0049	0.144	0.129
Windsor	0.194	0.134	0.080	0.042	0.012	0.0048	0.119	0.115
<b>New Brunswick</b>								
Alma	0.144	0.096	0.058	0.030	0.0078	0.0034	0.088	0.079
Bathurst	0.217	0.127	0.071	0.036	0.0090	0.0038	0.138	0.105
Campbellton	0.210	0.133	0.076	0.039	0.010	0.0042	0.132	0.113
Edmundston	0.231	0.153	0.089	0.046	0.012	0.0049	0.145	0.134
Fredericton	0.210	0.127	0.071	0.037	0.0093	0.0039	0.133	0.105
Gagetown	0.195	0.119	0.068	0.035	0.0089	0.0038	0.122	0.098
Grand Falls	0.254	0.153	0.085	0.043	0.011	0.0046	0.162	0.131
Miramichi	0.214	0.125	0.069	0.035	0.0087	0.0037	0.136	0.102
Moncton	0.158	0.100	0.059	0.031	0.0078	0.0034	0.098	0.083
Oromocto	0.209	0.126	0.071	0.036	0.0092	0.0039	0.132	0.103
Sackville	0.140	0.093	0.057	0.030	0.0078	0.0034	0.085	0.079
Saint Andrews	0.874	0.436	0.189	0.077	0.017	0.0053	0.544	0.345
Saint George	0.578	0.298	0.135	0.058	0.014	0.0048	0.367	0.232
Saint John	0.199	0.121	0.068	0.035	0.0089	0.0037	0.125	0.097
Shippagan	0.143	0.096	0.058	0.030	0.0078	0.0034	0.087	0.079
St. Stephen	0.781	0.380	0.163	0.067	0.015	0.0051	0.491	0.302
Woodstock	0.206	0.129	0.074	0.038	0.0099	0.0042	0.130	0.109
<b>Nova Scotia</b>								
Amherst	0.130	0.089	0.055	0.030	0.0078	0.0034	0.078	0.074
Antigonish	0.098	0.076	0.050	0.028	0.0073	0.0031	0.057	0.064

**Table C-3 (Continued)**

Province and Location	Seismic Data							PGA	PGV
	S <sub>a</sub> (0.2)	S <sub>a</sub> (0.5)	S <sub>a</sub> (1.0)	S <sub>a</sub> (2.0)	S <sub>a</sub> (5.0)	S <sub>a</sub> (10.0)			
Bridgewater	0.117	0.086	0.054	0.029	0.0078	0.0034	0.068	0.071	
Canso	0.114	0.085	0.054	0.029	0.0078	0.0034	0.066	0.071	
Debert	0.107	0.080	0.052	0.029	0.0076	0.0032	0.062	0.068	
Digby	0.164	0.105	0.061	0.032	0.0083	0.0035	0.101	0.085	
Greenwood (CFB)	0.128	0.090	0.055	0.029	0.0077	0.0032	0.076	0.074	
Halifax Region									
Dartmouth	0.110	0.082	0.053	0.029	0.0076	0.0032	0.064	0.068	
Halifax	0.110	0.082	0.053	0.029	0.0076	0.0032	0.064	0.068	
Kentville	0.120	0.087	0.055	0.030	0.0078	0.0034	0.071	0.072	
Liverpool	0.120	0.086	0.054	0.029	0.0076	0.0032	0.070	0.070	
Lockeport	0.123	0.087	0.054	0.028	0.0074	0.0031	0.073	0.071	
Louisburg	0.119	0.089	0.056	0.030	0.0080	0.0035	0.069	0.074	
Lunenburg	0.115	0.085	0.054	0.029	0.0078	0.0034	0.067	0.070	
New Glasgow	0.099	0.077	0.051	0.028	0.0074	0.0032	0.057	0.064	
North Sydney	0.105	0.081	0.053	0.029	0.0076	0.0032	0.061	0.068	
Pictou	0.098	0.076	0.050	0.028	0.0074	0.0031	0.057	0.064	
Port Hawkesbury	0.102	0.079	0.052	0.028	0.0076	0.0032	0.059	0.066	
Springhill	0.118	0.085	0.054	0.029	0.0077	0.0034	0.070	0.071	
Stewiacke	0.107	0.081	0.053	0.029	0.0077	0.0032	0.062	0.068	
Sydney	0.108	0.083	0.054	0.029	0.0077	0.0034	0.063	0.070	
Tatamagouche	0.103	0.079	0.052	0.028	0.0076	0.0032	0.061	0.066	
Truro	0.105	0.080	0.052	0.029	0.0076	0.0032	0.061	0.067	
Wolfville	0.118	0.086	0.055	0.030	0.0078	0.0034	0.069	0.071	
Yarmouth	0.137	0.094	0.057	0.030	0.0078	0.0034	0.082	0.075	
<b>Prince Edward Island</b>									
Charlottetown	0.103	0.077	0.051	0.028	0.0074	0.0032	0.060	0.066	
Souris	0.091	0.073	0.049	0.027	0.0071	0.0031	0.052	0.062	
Summerside	0.133	0.089	0.055	0.029	0.0076	0.0032	0.082	0.075	
Tignish	0.135	0.090	0.056	0.030	0.0076	0.0032	0.083	0.076	
<b>Newfoundland</b>									
Argentia	0.098	0.079	0.052	0.029	0.0076	0.0032	0.056	0.066	
Bonavista	0.083	0.067	0.045	0.025	0.0065	0.0028	0.047	0.056	
Buchans	0.077	0.064	0.044	0.024	0.0064	0.0028	0.043	0.054	
Cape Harrison	0.125	0.087	0.052	0.028	0.0071	0.0031	0.074	0.068	
Cape Race	0.108	0.085	0.055	0.030	0.0080	0.0034	0.062	0.071	
Channel-Port aux Basques	0.088	0.071	0.048	0.026	0.0068	0.0030	0.050	0.059	
Corner Brook	0.074	0.062	0.043	0.024	0.0062	0.0027	0.042	0.052	
Gander	0.077	0.064	0.044	0.024	0.0064	0.0027	0.044	0.054	
Grand Bank	0.115	0.090	0.057	0.031	0.0081	0.0035	0.067	0.074	
Grand Falls	0.076	0.064	0.044	0.024	0.0064	0.0027	0.043	0.054	
Happy Valley-Goose Bay	0.067	0.050	0.032	0.017	0.0044	0.0018	0.039	0.040	
Labrador City	0.067	0.052	0.035	0.019	0.0047	0.0020	0.038	0.042	

Copyright © NRC 1941 - 2021 World Rights Reserved © CNRC 1941-2021 Droits réservés pour tous pays



**Table C-3 (Continued)**

Province and Location	Seismic Data							
	S <sub>a</sub> (0.2)	S <sub>a</sub> (0.5)	S <sub>a</sub> (1.0)	S <sub>a</sub> (2.0)	S <sub>a</sub> (5.0)	S <sub>a</sub> (10.0)	PGA	PGV
St. Anthony	0.073	0.057	0.038	0.021	0.0053	0.0022	0.041	0.047
St. John's	0.090	0.073	0.049	0.027	0.0071	0.0031	0.052	0.062
Stephenville	0.077	0.064	0.044	0.025	0.0064	0.0028	0.044	0.054
Twin Falls	0.064	0.047	0.030	0.016	0.0040	0.0017	0.037	0.036
Wabana	0.089	0.072	0.048	0.027	0.0071	0.0031	0.051	0.060
Wabush	0.067	0.052	0.035	0.019	0.0047	0.0020	0.039	0.042
<b>Yukon</b>								
Aishihik	0.446	0.364	0.233	0.122	0.043	0.016	0.218	0.255
Dawson	0.396	0.277	0.168	0.087	0.030	0.012	0.185	0.174
Destruction Bay <sup>(1)</sup>	1.54	1.15	0.666	0.330	0.119	0.038	0.693	0.816
Faro	0.271	0.189	0.122	0.067	0.023	0.0091	0.126	0.125
Haines Junction	0.973	0.691	0.398	0.193	0.066	0.022	0.467	0.452
Snag	0.502	0.394	0.254	0.138	0.052	0.019	0.242	0.294
Teslin	0.284	0.202	0.129	0.073	0.025	0.0096	0.133	0.138
Watson Lake	0.304	0.214	0.125	0.061	0.020	0.0077	0.142	0.123
Whitehorse	0.334	0.258	0.170	0.094	0.033	0.012	0.154	0.184
<b>Northwest Territories</b>								
Aklavik	0.475	0.321	0.183	0.089	0.029	0.011	0.225	0.199
Echo Bay / Port Radium	0.052	0.038	0.031	0.020	0.0068	0.0031	0.030	0.032
Fort Good Hope	0.257	0.197	0.128	0.068	0.024	0.0091	0.119	0.127
Fort McPherson	0.476	0.354	0.211	0.103	0.035	0.013	0.225	0.223
Fort Providence	0.055	0.044	0.037	0.023	0.0077	0.0035	0.031	0.038
Fort Resolution	0.052	0.032	0.017	0.0072	0.0015	0.0008	0.030	0.021
Fort Simpson	0.154	0.134	0.090	0.047	0.016	0.0062	0.072	0.083
Fort Smith	0.052	0.031	0.016	0.0065	0.0013	0.0007	0.030	0.021
Hay River	0.053	0.034	0.025	0.016	0.0056	0.0025	0.031	0.028
Holman/Ulukhaquuq	0.057	0.040	0.025	0.012	0.0031	0.0014	0.033	0.030
Inuvik	0.308	0.223	0.139	0.072	0.025	0.0094	0.145	0.149
Mould Bay	0.21	0.120	0.070	0.037	0.010	0.0041	0.136	0.104
Norman Wells	0.688	0.445	0.238	0.105	0.031	0.011	0.340	0.256
Rae-Edzo	0.052	0.036	0.029	0.019	0.0065	0.0030	0.030	0.031
Tungsten	0.325	0.238	0.143	0.070	0.023	0.0089	0.153	0.145
Wrigley	0.653	0.421	0.224	0.099	0.029	0.010	0.319	0.241
Yellowknife	0.052	0.032	0.017	0.0070	0.0015	0.0008	0.030	0.021
<b>Nunavut</b>								
Alert	0.145	0.083	0.044	0.021	0.0049	0.0020	0.091	0.062
Arctic Bay	0.111	0.080	0.052	0.028	0.0071	0.0031	0.066	0.066
Arviat / Eskimo Point	0.054	0.037	0.022	0.0097	0.0021	0.0011	0.031	0.025
Baker Lake	0.068	0.048	0.029	0.014	0.0031	0.0014	0.039	0.035
Cambridge Bay/Iqaluktuuttiaq	0.059	0.041	0.025	0.012	0.0025	0.0013	0.034	0.030
Chesterfield Inlet/Igluligaarjuk	0.081	0.054	0.031	0.015	0.0034	0.0015	0.047	0.042
Clyde River /Kanngiqugaapik	0.306	0.186	0.104	0.053	0.015	0.0056	0.195	0.162

Table C-3 (Continued)

Province and Location	Seismic Data							
	S <sub>a</sub> (0.2)	S <sub>a</sub> (0.5)	S <sub>a</sub> (1.0)	S <sub>a</sub> (2.0)	S <sub>a</sub> (5.0)	S <sub>a</sub> (10.0)	PGA	PGV
Coppermine (Kugluktuk)	0.053	0.031	0.016	0.0066	0.0013	0.0007	0.031	0.021
Coral Harbour /Salliq	0.103	0.064	0.035	0.016	0.0037	0.0015	0.062	0.048
Eureka	0.173	0.106	0.065	0.035	0.010	0.0040	0.110	0.093
Iqaluit	0.087	0.065	0.043	0.023	0.0058	0.0025	0.051	0.052
Isachsen	0.256	0.171	0.102	0.055	0.016	0.0061	0.162	0.158
Nottingham Island	0.109	0.060	0.031	0.014	0.0030	0.0014	0.068	0.044
Rankin Inlet (Kangiqiniq)	0.064	0.045	0.027	0.013	0.0028	0.0014	0.036	0.034
Resolute	0.194	0.105	0.057	0.028	0.0069	0.0030	0.124	0.084
Resolution Island	0.203	0.123	0.069	0.035	0.0092	0.0038	0.128	0.102

**Notes to Table C-3:**

- (1) See the paragraph dealing with Sentence 4.1.8.4.(1) in the Commentary entitled Design for Seismic Effects in the "User's Guide – NBC 2015, Structural Commentaries (Part 4 of Division B)" for guidance regarding sites in the Yukon and the British Columbia panhandle that are close to active faults.

**References**

- (1) Environment Canada, Climate Trends and Variation Bulletin: Annual 2007, 2008.
- (2) Intergovernmental Panel on Climate Change (IPCC), Climate Change 2007: The Physical Science Basis. Contribution of Working Group I to the Fourth Assessment Report of the Intergovernmental Panel on Climate Change. S. Solomon, D. Qin, M. Manning, Z. Chen, M. Marquis, K.B. Averyt, M. Tignor and H.L. Miller (Eds.). Cambridge University Press, Cambridge, United Kingdom and New York, NY, USA, 996 pp., 2007.
- (3) American Society of Heating, Refrigerating, and Air-conditioning Engineers, Handbook of Fundamentals, Chapter 14 – Climatic Design Information, Atlanta, GA, 2009.
- (4) Lowery, M.D. and Nash, J.E., A comparison of methods of fitting the double exponential distribution. J. of Hydrology, 10 (3), pp. 259–275, 1970.
- (5) Newark, M.J., Welsh, L.E., Morris, R.J. and Dnes, W.V. Revised Ground Snow Loads for the 1990 NBC of Canada. Can. J. Civ. Eng., Vol. 16, No. 3, June 1989.
- (6) Newark, M.J. A New Look at Ground Snow Loads in Canada. Proceedings, 41st Eastern Snow Conference, Washington, D.C., Vol. 29, pp. 59-63, 1984.
- (7) Bruce, J.P. and Clark, R.H. Introduction to Hydrometeorology. Pergammon Press, London, 1966.
- (8) Skerlj, P.F. and Surry, D. A Critical Assessment of the DRWPs Used in CAN/CSA-A440-M90. Tenth International Conference on Wind Engineering, Wind Engineering into the 21st Century, Larsen, Larose & Livesay (eds), 1999 Balkema, Rotterdam, ISBN 90 5809 059 0.
- (9) Cornick, S., Chown, G.A., et al. Committee Paper on Defining Climate Regions as a Basis for Specifying Requirements for Precipitation Protection for Walls. Institute for Research in Construction, National Research Council, Ottawa, April 2001.
- (10) Boyd, D.W. Variations in Air Density over Canada. National Research Council of Canada, Division of Building Research, Technical Note No. 486, June 1967.
- (11) Adams, J., Halchuk, S., Allen, T.I., and Rogers, G.C. Fifth Generation seismic hazard model and values for the 2015 National Building Code of Canada. Geological Survey of Canada Open File, 2014.
- (12) Atkinson, G. M. and Adams J. Ground motion prediction equations for application to the 2015 Canadian national seismic hazard maps, Can. J. Civ. Eng. 40, 988–998, 2013.

# Appendix D

## Fire-Performance Ratings

### Section D-1 General

The content of this Appendix was prepared on the recommendations of the Standing Committee on Fire Protection, which was established by the Canadian Commission on Building and Fire Codes (CCBFC) for this purpose.

#### D-1.1. Introduction

##### D-1.1.1. Scope

- 1)** This fire-performance information is presented in a form closely linked to the performance requirements and the minimum materials specifications of this Code.
- 2)** The ratings have been assigned only after careful consideration of all available literature on assemblies of common building materials, where they are adequately identified by description. The assigned values based on this information will, in most instances, be conservative when compared to the ratings determined on the basis of actual tests on individual assemblies.
- 3)** The fire-performance information set out in this Appendix applies to materials and assemblies of materials that comply in all essential details with the minimum structural design standards described in Part 4. Additional requirements, where appropriate, are described in other Sections of this Appendix.
- 4)** Section D-2 assigns fire-resistance ratings for walls, floors, roofs, columns and beams related to CAN/ULC-S101, "Fire Endurance Tests of Building Construction and Materials," and describes methods for determining these ratings.
- 5)** Section D-3 assigns flame-spread ratings and smoke developed classifications for surface materials related to CAN/ULC-S102, "Test for Surface Burning Characteristics of Building Materials and Assemblies," and CAN/ULC-S102.2, "Test for Surface Burning Characteristics of Flooring, Floor Coverings, and Miscellaneous Materials and Assemblies."
- 6)** Section D-4 describes noncombustibility in building materials when tested in accordance with CAN/ULC-S114, "Test for Determination of Non-Combustibility in Building Materials."
- 7)** Section D-5 contains requirements for the installation of fire doors and fire dampers in fire-rated stud wall assemblies.
- 8)** Section D-6 contains background information regarding fire test reports, obsolete materials and assemblies, assessment of archaic assemblies and the development of the component additive method.

##### D-1.1.2. Referenced Documents

- 1)** Where documents are referenced in this Appendix, they shall be the editions designated in Table D-1.1.2.

---

This information is included for explanatory purposes only and does not form part of the requirements. The bold face reference numbers that introduce each item do not relate to specific requirements in this Division.

**Table D-1.1.2.**  
**Documents Referenced in Appendix D, Fire-Performance Ratings**

Issuing Agency	Document Number <sup>(1)</sup>	Title of Document <sup>(2)</sup>	Code Reference
ANSI	A208.1-2009	Particleboard	D-3.1.1.
ASTM	C 330/C 330M-13	Lightweight Aggregates for Structural Concrete	D-1.4.3.
ASTM	C 840-13	Application and Finishing of Gypsum Board	D-2.3.9.
ASTM	C 1396/C 1396M-14	Gypsum Board	D-1.5.1. D-3.1.1.
CCBFC	NRCC 30629	Supplement to the National Building Code of Canada 1990	D-6.2. D-6.3. D-6.4.
CGSB	4-GP-36M-1978	Carpet Underlay, Fiber Type	D-3.1.1.
CGSB	CAN/CGSB-4.129-97	Carpets for Commercial Use	D-3.1.1.
CGSB	CAN/CGSB-11.3-M87	Hardboard	D-3.1.1.
CGSB	CAN/CGSB-92.2-M90	Trowel or Spray Applied Acoustical Material	D-2.3.4.
CSA	A23.1-14/A23.2-14	Concrete Materials and Methods of Concrete Construction/Test Methods and Standard Practices for Concrete	D-1.4.3.
CSA	A23.3-14	Design of Concrete Structures	D-2.1.5. D-2.6.6. D-2.8.2.
CSA	CAN/CSA-A82-14	Fired Masonry Brick Made from Clay or Shale	D-2.6.1.
CSA	A82.22-M1977	Gypsum Plasters	D-3.1.1.
CSA	CAN/CSA-A82.27-M91	Gypsum Board	D-1.5.1. D-3.1.1.
CSA	A82.30-M1980	Interior Furring, Lathing and Gypsum Plastering	D-1.7.2. D-2.3.9. D-2.5.1.
CSA	A165.1-14	Concrete Block Masonry Units	D-2.1.1.
CSA	O86-14	Engineering Design in Wood	D-2.11.2.
CSA	O112.10-08	Evaluation of Adhesives for Structural Wood Products (Limited Moisture Exposure)	D-2.3.6.
CSA	O121-08	Douglas Fir Plywood	D-3.1.1.
CSA	O141-05	Softwood Lumber	D-2.3.6. D-2.4.1.
CSA	O151-09	Canadian Softwood Plywood	D-3.1.1.
CSA	O153-13	Poplar Plywood	D-3.1.1.
CSA	O325-07	Construction Sheathing	D-3.1.1.
CSA	O437.0-93	OSB and Waferboard	D-3.1.1.
CSA	S16-14	Design of Steel Structures	D-2.6.6.
NFPA	80-2013	Fire Doors and Other Opening Protectives	D-5.2.1.
ULC	CAN/ULC-S101-14	Fire Endurance Tests of Building Construction and Materials	D-1.1.1. D-1.12.1. D-2.3.2.
ULC	CAN/ULC-S102-10	Test for Surface Burning Characteristics of Building Materials and Assemblies	D-1.1.1.
ULC	CAN/ULC-S102.2-10	Test for Surface Burning Characteristics of Flooring, Floor Coverings, and Miscellaneous Materials and Assemblies	D-1.1.1. D-3.1.1.
ULC	CAN/ULC-S112.2-07	Fire Test of Ceiling Firestop Flap Assemblies	D-2.3.10. D-2.3.11.

**Table D-1.1.2. (Continued)**

Issuing Agency	Document Number <sup>(1)</sup>	Title of Document <sup>(2)</sup>	Code Reference
ULC	CAN/ULC-S114-05	Test for Determination of Non-Combustibility in Building Materials	D-1.1.1. D-4.1.1. D-4.2.1.
ULC	CAN/ULC-S702-09	Mineral Fibre Thermal Insulation for Buildings	D-2.3.4. D-2.3.5. D-2.6.1.
ULC	CAN/ULC-S703-09	Cellulose Fibre Insulation for Buildings	D-2.3.4.
ULC	CAN/ULC-S706-09	Wood Fibre Insulating Boards for Buildings	D-3.1.1.

**Notes to Table D-1.1.2.:**

- (1) Some documents may have been reaffirmed or reapproved. Check with the applicable issuing agency for up-to-date information.
- (2) Some titles have been abridged to omit superfluous wording.

**D-1.1.3. Applicability of Ratings**

The ratings shown in this document apply if more specific test values are not available. The construction of an assembly that is the subject of an individual test report must be followed in all essential details if the fire-resistance rating reported is to be applied for use with this Code.

**D-1.1.4. Higher Ratings**

The authority having jurisdiction may allow higher fire-resistance ratings than those derived from this Appendix, where supporting evidence justifies a higher rating. Additional information is provided in summaries of published test information and the reports of fire tests carried out by NRC, which are included in Section D-6, Background Information.

**D-1.1.5. Additional Information on Fire Rated Assemblies**

Assemblies containing materials for which there is no nationally recognized standard are not included in this Appendix. Many such assemblies have been rated by Underwriters Laboratories (UL), Underwriters' Laboratories of Canada (ULC), or Intertek Testing Services NA Ltd. (ITS).

**D-1.2. Interpretation of Test Results**

**D-1.2.1. Limitations**

- 1)** The fire-performance ratings set out in this Appendix are based on those that would be obtained from the standard methods of test described in the Code. The test methods are essentially a means of comparing the performance of one building component or assembly with another in relation to its performance in fire.
- 2)** Since it is not practicable to measure the fire resistance of constructions in situ, they must be evaluated under some agreed test conditions. A specified fire-resistance rating is not necessarily the actual time that the assembly would endure in situ in a building fire, but is that which the particular construction must meet under the specified methods of test.
- 3)** Considerations arising from departures in use from the conditions established in the standard test methods may, in some circumstances, have to be taken into account by the designer and the authority having jurisdiction. Some of these conditions are covered at present by the provisions of the Code.
- 4)** For walls and partitions, the stud spacings previously specified as 16 or 24 inch have been converted to 400 and 600 mm, respectively, for consistency with other metric values; however, the use of equivalent imperial dimensions for stud spacing is permitted.

**D-1.3. Concrete****D-1.3.1. Aggregates in Concrete**

Low density aggregate concretes generally exhibit better fire performance than natural stone aggregate concretes. A series of tests on concrete masonry walls, combined with mathematical analysis of the test results, has allowed further distinctions between certain low density aggregates to be made.

**D-1.4. Types of Concrete****D-1.4.1. Description**

- 1) For purposes of this Appendix, concretes are described as Types S, N, L, L<sub>1</sub>, L<sub>2</sub>, L40S, L<sub>1</sub>20S or L<sub>2</sub>20S as described in Sentences (2) to (8).
- 2) Type S concrete is the type in which the coarse aggregate is granite, quartzite, siliceous gravel or other dense materials containing at least 30% quartz, chert or flint.
- 3) Type N concrete is the type in which the coarse aggregate is cinders, broken brick, blast furnace slag, limestone, calcareous gravel, trap rock, sandstone or similar dense material containing not more than 30% of quartz, chert or flint.
- 4) Type L concrete is the type in which all the aggregate is expanded slag, expanded clay, expanded shale or pumice.
- 5) Type L<sub>1</sub> concrete is the type in which all the aggregate is expanded shale.
- 6) Type L<sub>2</sub> concrete is the type in which all the aggregate is expanded slag, expanded clay or pumice.
- 7) Type L40S concrete is the type in which the fine portion of the aggregate is sand and low density aggregate in which the sand does not exceed 40% of the total volume of all aggregates in the concrete.
- 8) Type L<sub>1</sub>20S and Type L<sub>2</sub>20S concretes are the types in which the fine portion of the aggregate is sand and low density aggregate in which the sand does not exceed 20% of the total volume of all aggregates in the concrete.

**D-1.4.2. Determination of Ratings**

Where concretes are described as being of Type S, N, L, L<sub>1</sub> or L<sub>2</sub>, the rating applies to the concrete containing the aggregate in the group that provides the least fire resistance. If the nature of an aggregate cannot be determined accurately enough to place it in one of the groups, the aggregate shall be considered as being in the group that requires a greater thickness of concrete for the required fire resistance.

**D-1.4.3. Description of Aggregates**

- 1) The descriptions of the aggregates in Type S and Type N concretes apply to the coarse aggregates only. Coarse aggregate for this purpose means that retained on a 5 mm sieve using the method of grading aggregates described in CSA A23.1/A23.2, "Concrete Materials and Methods of Concrete Construction/Test Methods and Standard Practices for Concrete."
- 2) Increasing the proportion of sand as fine aggregate in low density concretes requires increased thicknesses of material to produce equivalent fire-resistance ratings. Low density aggregates for Type L and Types L-S concretes used in loadbearing components shall conform to ASTM C 330/C 330M, "Lightweight Aggregates for Structural Concrete."
- 3) Non-loadbearing low density components of vermiculite and perlite concrete, in the absence of other test evidence, shall be rated on the basis of the values shown for Type L concrete.

**D-1.5. Gypsum Board****D-1.5.1. Types of Gypsum Board**

- 1) Where the term "gypsum board" is used in this Appendix, it is intended to include—in addition to gypsum board—gypsum backing board and gypsum base for veneer plaster as described in
  - a) CAN/CSA-A82.27-M, "Gypsum Board," or
  - b) ASTM C 1396/C 1396M, "Gypsum Board."

- 2) Where the term “Type X gypsum board” is used in this Appendix, it applies to special fire-resistant board as described in
- CAN/CSA-A82.27-M, “Gypsum Board,” or
  - ASTM C 1396/C 1396M, “Gypsum Board.”

**D-1.6. Equivalent Thickness**

**D-1.6.1. Method of Calculating**

1) The thickness of solid-unit masonry and concrete described in this Appendix shall be the thickness of solid material in the unit or component thickness. For units that contain cores or voids, the Tables refer to the equivalent thickness determined in conformance with Sentences (2) to (10).

2) Where a plaster finish is used, the equivalent thickness of a wall, floor, column or beam protection shall be equal to the sum of the equivalent thicknesses of the concrete or masonry units and the plaster finish measured at the point that will give the least value of equivalent thickness.

3) Except as provided in Sentence (5), the equivalent thickness of a hollow masonry unit shall be calculated as equal to the actual overall thickness of a unit in millimetres multiplied by a factor equal to the net volume of the unit and divided by its gross volume.

4) Net volume shall be determined using a volume displacement method that is not influenced by the porous nature of the units.

5) Gross volume of a masonry unit shall be equal to the actual length of the unit multiplied by the actual height of the unit multiplied by the actual thickness of the unit.

6) Where all the core spaces in a wall of hollow concrete masonry or hollow-core precast concrete units are filled with grout, mortar, or loose fill materials such as expanded slag, burned clay or shale (rotary kiln process), vermiculite or perlite, the equivalent thickness rating of the wall shall be considered to be the same as that of a wall of solid units, or a solid wall of the same concrete type and the same overall thickness.

7) The equivalent thickness of hollow-core concrete slabs and panels having a uniform thickness and cores of constant cross section throughout their length shall be obtained by dividing the net cross-sectional area of the slab or panel by its width.

8) The equivalent thickness of concrete panels with tapered cross sections shall be the cross section determined at a distance of 2 t or 150 mm, whichever is less, from the point of minimum thickness, where t is the minimum thickness.

9) Except as permitted in Sentence (10), the equivalent thickness of concrete panels with ribbed or undulating surfaces shall be

- $t_a$  for s less than or equal to 2 t,
- $t + (4 t/s - 1)(t_a - t)$  for s less than 4 t and greater than 2 t, and
- t for s greater than or equal to 4 t

where

- t = minimum thickness of panel,
- $t_a$  = average thickness of panel (unit cross-sectional area divided by unit width), and
- s = centre to centre spacing of ribs or undulations.

10) Where the total thickness of a panel described in Sentence (9), exceeds 2 t, only that portion of the panel which is less than 2 t from the non-ribbed surface shall be considered for the purpose of the calculations in Sentence (9).

**D-1.7. Contribution of Plaster or Gypsum Board Finish to Fire Resistance of Masonry or Concrete**

**D-1.7.1. Determination of Contribution**

1) Except as provided in Sentences (2), (3), (4) and (5), the contribution of a plaster or gypsum board finish to the fire resistance of a masonry or concrete wall, floor or roof assembly shall be determined by multiplying the actual thickness of the finish by the factor shown in Table D-1.7.1., depending on the type of masonry or concrete to which it is applied. This corrected thickness shall then be included in the equivalent thickness as described in Subsection D-1.6.

**Table D-1.7.1.**  
**Multiplying Factors for Masonry or Concrete Construction**

Type of Surface Protection	Type of Masonry or Concrete			
	Solid Clay Brick, Unit Masonry and Monolithic Concrete, Type N or S	Cored Clay Brick, Clay Tile, Monolithic Concrete, Type L40S and Unit Masonry, Type L <sub>1</sub> 20S	Concrete Unit Masonry, Type L <sub>1</sub> or L <sub>2</sub> 20S and Monolithic Concrete, Type L	Concrete Unit Masonry, Type L <sub>2</sub>
Portland cement-sand plaster or lime sand plaster	1	0.75	0.75	0.50
Gypsum-sand plaster, wood fibred gypsum plaster or gypsum board	1.25	1	1	1
Vermiculite or perlite aggregate plaster	1.75	1.5	1.25	1.25

**2)** Where a plaster or gypsum board finish is applied to a concrete or masonry wall, the calculated fire-resistance rating of the assembly shall not exceed twice the fire-resistance rating provided by the masonry or concrete because structural collapse may occur before the limiting temperature is reached on the surface of the non-fire-exposed side of the assembly.

**3)** Where a plaster or gypsum board finish is applied only on the non-fire-exposed side of a hollow clay tile wall, no increase in fire resistance is permitted because structural collapse may occur before the limiting temperature is reached on the surface of the non-fire-exposed side of the assembly.

**4)** The contribution to fire resistance of a plaster or gypsum board finish applied to the non-fire-exposed side of a monolithic concrete or unit masonry wall shall be determined in conformance with Sentence (1), but shall not exceed 0.5 times the contribution of the concrete or masonry wall.

**5)** When applied to the fire-exposed side, the contribution of a gypsum lath and plaster or gypsum board finish to the fire resistance of masonry or concrete wall, floor or roof assemblies shall be determined from Table D-2.3.4.-A or D-2.3.4.-D.

### D-1.7.2. Plaster

**1)** Gypsum plastering shall conform to CSA A82.30-M, "Interior Furring, Lathing and Gypsum Plastering."

**2)** Portland cement-sand plaster shall be applied in 2 coats: the first coat containing 1 part Portland cement to 2 parts sand by volume, and the second coat containing 1 part Portland cement to 3 parts sand by volume.

**3)** Plaster finish shall be securely bonded to the wall or ceiling.

**4)** The thickness of plaster finish applied directly to monolithic concrete without metal lath shall not exceed 10 mm on ceilings and 16 mm on walls.

**5)** Where the thickness of plaster finish on masonry or concrete exceeds 38 mm, wire mesh with 1.57 mm diam wire and openings not exceeding 50 mm by 50 mm shall be embedded midway in the plaster.

### D-1.7.3. Attachment of Gypsum Board and Lath

Gypsum board and gypsum lath finishes applied to masonry or concrete walls shall be secured to wood or steel furring members in conformance with Article D-2.3.9.

### D-1.7.4. Sample Calculations

The following examples are included as a guide to the method of calculating the fire resistance of concrete or hollow masonry walls with plaster or gypsum board protection:

#### Example (1)

A 3 h fire-resistance rating is required for a monolithic concrete wall of Type S aggregate with a 20 mm gypsum-sand plaster finish on metal lath on each face.



- (a) The minimum equivalent thickness of Type S monolithic concrete needed to give a 3 h fire-resistance rating = 158 mm (Table D-2.1.1.).
- (b) Since the gypsum-sand plaster finish is applied on metal lath, Sentence D-1.7.1.(5) does not apply. Therefore, the contribution to the equivalent thickness of the wall of 20 mm gypsum-sand plaster on each face of the concrete is  $20 \times 1.25 = 25$  mm (see Sentences D-1.7.1.(1) to (4)).
- (c) The total contribution of the plaster finishes is  $2 \times 25 = 50$  mm.
- (d) The minimum equivalent thickness of concrete required is  $158 \text{ mm} - 50 \text{ mm} = 108 \text{ mm}$ .
- (e) From Table D-2.1.1., the 108 mm equivalent thickness of monolithic concrete gives a contribution of less than 1.5 h. This is less than half the rating of the assembly so that the conditions in Sentence D-1.7.1.(2) are not met. Thus the equivalent thickness of monolithic concrete must be increased to 112 mm to give 1.5 h contribution.
- (f) The total equivalent thickness of the plaster finishes can then be reduced to  $158 \text{ mm} - 112 \text{ mm} = 46 \text{ mm}$ .
- (g) The total actual thickness of the plaster finishes required is therefore  $46 \text{ mm} \div 1.25 = 37 \text{ mm}$  (Sentences D-1.7.1.(1) to (4)) or 18.5 mm on each face.
- (h) Since the thickness of the plaster finish on each face exceeds 16 mm, metal lath is still required (Sentence D-1.7.2.(4)).
- (i) Since this wall is symmetrical with plaster on both faces, the contribution to fire resistance of the plaster finish on either face is limited to one-quarter of the wall rating by virtue of Sentence D-1.7.1.(2). Under these circumstances, the conditions in Sentence D-1.7.1.(4) are automatically met.

### Example (2)

A 2 h fire-resistance rating is required for a hollow masonry wall of Type N concrete with a 12.7 mm Type X gypsum board finish on each face.

- (a) Since gypsum board is used, Sentence D-1.7.1.(5) applies. The 12.7 mm gypsum board finish on the fire-exposed side is, therefore, assigned 25 min by using Table D-2.3.4.-A.
- (b) The fire resistance required of the balance of the assembly is  $120 \text{ min} - 25 \text{ min} = 95 \text{ min}$ .
- (c) Interpolating between 1.5 h and 2 h in Table D-2.1.1. for 95 min fire resistance, the equivalent thickness for hollow masonry units required is  $95 \text{ mm} + (18 \text{ mm} \times 5/30) = 95 \text{ mm} + 3 \text{ mm} = 98 \text{ mm}$ .
- (d) The contribution to the equivalent thickness of the wall of the 12.7 mm gypsum board finish on the non-fire-exposed side using Table D-1.7.1. =  $12.7 \times 1.25 = 16 \text{ mm}$ .
- (e) Equivalent thickness required of concrete masonry unit =  $98 - 16 = 82 \text{ mm}$ .
- (f) The fire-resistance rating of a concrete masonry wall having an equivalent thickness of 82 mm = 1 h for  $73 \text{ mm} + (9 \text{ mm} \times 30/22) = 1 \text{ h } 12 \text{ min}$ .

As this is more than 1 h, the conditions of Sentence D-1.7.1.(2) are met and the rating of 2 h is justified.

### Example (3)

A 2 h fire-resistance rating is required for a hollow masonry exterior wall of Type L<sub>2</sub>20S concrete with a 15.9 mm Type X gypsum board finish on the non-fire-exposed side only.

- (a) According to Table D-2.1.1., the minimum equivalent thickness for Type L<sub>2</sub>20S concrete masonry units needed to achieve a 2 h rating is 94 mm.
- (b) Since gypsum board is not used on the fire-exposed side, Sentence D-1.7.1.(5) does not apply. The contribution to the equivalent thickness of the wall by the 15.9 mm Type X gypsum board finish applied on the non-fire-exposed side is  $15.9 \times 1 \approx 16 \text{ mm}$  (see Sentence D-1.7.1.(1) and Table D-1.7.1.).
- (c) Therefore, the equivalent thickness required of the concrete masonry unit is  $94 - 16 = 78 \text{ mm}$ .
- (d) The contribution to fire resistance of a 78 mm L<sub>2</sub>20S concrete hollow masonry unit is 85 min. The contribution of the Type X gypsum board finish is  $120 - 85 = 35 \text{ min}$ , which does not exceed half the 85 min contribution of the masonry unit or 42.5 min, so that the conditions in Sentence D-1.7.1.(4) are met.
- (e) The rating of the wall (120 min) is less than twice the contribution of the masonry unit (170 min) so that the conditions in Sentence D-1.7.1.(2) are also met.

## D-1.8. Tests on Floors and Roofs

### D-1.8.1. Exposure to Fire

All tests relate to the performance of a floor assembly or floor-ceiling or roof-ceiling assembly above a fire. It has been assumed on the basis of experience that fire on top will take a longer time to penetrate the floor than one below, and that the fire resistance in such a situation will be at least equal to that obtained from below in the standard test.

**D-1.9. Moisture Content****D-1.9.1. Effect of Moisture**

1) The moisture content of building materials at the time of fire test may have a significant influence on the measured fire resistance. In general, an increase in the moisture content should result in an increase in the fire resistance, though in some materials the presence of moisture may produce disruptive effects and early collapse of the assembly.

2) Moisture content is now controlled in standard fire test methods and is generally recorded in the test reports. In earlier tests, moisture content was not always properly determined.

**D-1.10. Permanence and Durability****D-1.10.1. Test Conditions**

The ratings in this Appendix relate to tested assemblies and do not take into account possible changes or deterioration in use of the materials. The standard fire test measures the fire resistance of a sample building assembly erected for the test. No judgment as to the permanence or durability of the assembly is made in the test.

**D-1.11. Steel Structural Members****D-1.11.1. Thermal Protection**

Since the ability of a steel structural member to sustain the loading for which it was designed may be impaired because of elevated temperatures, measures shall be taken to provide thermal protection. The fire-resistance ratings, as established by the provisions of this Appendix, indicate the time periods during which the effects of heat on protected steel structural members are considered to be within acceptable limits.

**D-1.12. Restraint Effects****D-1.12.1. Effect on Fire-Resistance Ratings**

In fire tests of floors, roofs and beams, it is necessary to state whether the rating applies to a thermally restrained or thermally unrestrained assembly. Edge restraint of a floor or roof, structural continuity, or end restraint of a beam can significantly extend the time before collapse in a standard test. A restrained condition is one in which expansion or rotation at the supports of a load-carrying element resulting from the effects of fire is resisted by forces or moments external to the element. An unrestrained condition is one in which the load-carrying element is free to thermally expand and rotate at its supports.

Whether an assembly or structural member can be considered thermally restrained or thermally unrestrained depends on the type of construction and location in a building. Guidance on this subject can be found in Appendix A of CAN/ULC-S101, "Fire Endurance Tests of Building Construction and Materials." Different acceptance criteria also apply to thermally unrestrained and thermally restrained assemblies. These are described in CAN/ULC-S101.

The ratings for floors, roofs, and beams in this Appendix meet the conditions of CAN/ULC-S101, "Fire Endurance Tests of Building Construction and Materials," for thermally unrestrained specimens. In a thermally restrained condition, the structural element or assembly would probably have greater fire resistance, but the extent of this increase can be determined only by reference to behavior in a standard test.

**Section D-2 Fire-Resistance Ratings****D-2.1. Masonry and Concrete Walls****D-2.1.1. Minimum Equivalent Thickness for Fire-Resistance Rating**

The minimum thicknesses of unit masonry and monolithic concrete walls are shown in Table D-2.1.1. Hollow masonry units and hollow-core concrete panels shall be rated on the basis of equivalent thickness as described in Subsection D-1.6.

**Table D-2.1.1.**  
**Minimum Equivalent Thicknesses<sup>(1)</sup> of Unit Masonry and Monolithic Concrete Walls Loadbearing and Non-Loadbearing, mm**

Type of Wall	Fire-Resistance Rating						
	30 min	45 min	1 h	1.5 h	2 h	3 h	4 h
Solid brick units (80% solid and over), actual overall thickness	63	76	90	108	128	152	178
Cored brick units and hollow tile units (less than 80% solid), equivalent thickness	50	60	72	86	102	122	142
Solid and hollow concrete masonry units, equivalent thickness							
Type S or N concrete <sup>(2)</sup>	44	59	73	95	113	142	167
Type L <sub>1</sub> 20S concrete	42	54	66	87	102	129	152
Type L <sub>1</sub> concrete	42	54	64	82	97	122	143
Type L <sub>2</sub> 20S concrete	42	54	64	81	94	116	134
Type L <sub>2</sub> concrete	42	54	63	79	91	111	127
Monolithic concrete and concrete panels, equivalent thickness							
Type S concrete	60	77	90	112	130	158	180
Type N concrete	59	74	87	108	124	150	171
Type L40S or Type L concrete	49	62	72	89	103	124	140

**Notes to Table D-2.1.1.:**

(1) See definition of equivalent thickness in Subsection D-1.6.

(2) Hollow concrete masonry units made with Type S or N concrete shall have a minimum compressive strength of 15 MPa based on net area, as defined in CSA A165.1, "Concrete Block Masonry Units."

**D-2.1.2. Applicability of Ratings**

**1)** Ratings obtained as described in Article D-2.1.1. apply to either loadbearing or non-loadbearing walls, except for walls described in Sentences (2) to (6).

**2)** Ratings for walls with a thickness less than the minimum thickness prescribed for loadbearing walls in this Code apply to non-loadbearing walls only.

**3)** Masonry cavity walls (consisting of 2 wythes of masonry with an air space between) that are loaded to a maximum allowable compressive stress of 380 kPa have a fire resistance at least as great as that of a solid wall of a thickness equal to the sum of the equivalent thicknesses of the 2 wythes.

**4)** Masonry cavity walls that are loaded to a compressive stress exceeding 380 kPa are not considered to be within the scope of this Appendix.

**5)** A masonry wall consisting of 2 types of masonry units, either bonded together or in the form of a cavity wall, shall be considered to have a fire-resistance rating equal to that which would apply if the whole of the wall were of the material that gives the lesser rating.

**6)** A non-loadbearing cavity wall made up of 2 precast concrete panels with an air space or insulation in the cavity between them shall be considered to have a fire-resistance rating as great as that of a solid wall of a thickness equal to the sum of the thicknesses of the 2 panels.

**D-2.1.3. Framed Beams and Joists**

Beams and joists that are framed into a masonry or concrete fire separation shall not reduce the thickness of the fire separation to less than the equivalent thickness required for the fire separation.

**D-2.1.4. Credit for Plaster Thickness**

On monolithic walls and walls of unit masonry, the full plaster finish on one or both faces multiplied by the factor shown in Table D-1.7.1. shall be included in the wall thickness shown in Table D-2.1.1., under the conditions and using the methods described in Subsection D-1.7.

**D-2.1.5. Walls Exposed to Fire on Both Sides**

**1)** Except as permitted in Sentence (2), portions of loadbearing reinforced concrete walls, which do not form a complete fire separation and thus may be exposed to fire on both sides simultaneously, shall have minimum dimensions and minimum cover to steel reinforcement in conformance with Articles D-2.8.2. to D-2.8.5.

**2)** A concrete wall exposed to fire from both sides as described in Sentence (1) has a fire-resistance rating of 2 h if the following conditions are met:

- a) its equivalent thickness is not less than 200 mm,
- b) its aspect ratio (width/thickness) is not less than 4.0,
- c) the minimum thickness of concrete cover over the steel reinforcement specified in Clause (d) is not less than 50 mm,
- d) each face of the wall is reinforced with both vertical and horizontal steel reinforcement in conformance with either Clause 10 or Clause 14 of CSA A23.3, "Design of Concrete Structures,"
- e) the structural design of the wall is governed by the minimum eccentricity  $(15 + 0.03h)$  specified in Clause 10.15.3.1 of CSA A23.3, "Design of Concrete Structures," and
- f) the effective length of the wall,  $kl_u$ , is not more than 3.7 m

where

- $k$  = effective length factor obtained from CSA A23.3, "Design of Concrete Structures,"
- $l_u$  = unsupported length of the wall in metres.

**D-2.2. Reinforced and Prestressed Concrete Floor and Roof Slabs**

**D-2.2.1. Assignment of Rating**

**1)** Floors and roofs in a fire test are assigned a fire-resistance rating which relates to the time that an average temperature rise of 140°C or a maximum temperature rise of 180 °C at any location is recorded on the unexposed side, or the time required for collapse to occur, whichever is the lesser. The thickness of concrete shown in Table D-2.2.1.-A shall be required to resist the transfer of heat during the fire resistance period shown.

**Table D-2.2.1.-A  
Minimum Thickness of Reinforced and Prestressed Concrete Floor or Roof Slabs, mm**

Type of Concrete	Fire-Resistance Rating						
	30 min	45 min	1 h	1.5 h	2 h	3 h	4 h
Type S concrete	60	77	90	112	130	158	180
Type N concrete	59	74	87	108	124	150	171
Type L40S or Type L concrete	49	62	72	89	103	124	140

**2)** The concrete cover over the reinforcement and steel tendons shown in Table D-2.2.1.-B shall be required to maintain the integrity of the structure and prevent collapse during the same period.

**Table D-2.2.1.-B  
Minimum Concrete Cover over Reinforcement in Concrete Slabs, mm**

Type of Concrete	Fire-Resistance Rating						
	30 min	45 min	1 h	1.5 h	2 h	3 h	4 h
Type S, N, L40S or L concrete	20	20	20	20	25	32	39
Prestressed concrete slabs Type S, N, L40S or L concrete	20	25	25	32	39	50	64

**D-2.2.2. Floors with Hollow Units**

The fire resistance of floors containing hollow units may be determined on the basis of equivalent thickness as described in Subsection D-1.6.

**D-2.2.3. Composite Slabs**

**1)** For composite concrete floor and roof slabs consisting of one layer of Type S or N concrete and another layer of Type L40S or L concrete in which the minimum thickness of both the top and bottom layers is not less than 25 mm, the combined fire-resistance rating may be determined using the following expressions:

a) when the base layer consists of Type S or N concrete,

$$R = 0.00018t^2 - 0.00009dt + \frac{8.7}{t}$$

b) when the base layer consists of Type L40S or L concrete,

$$R = 0.0001t^2 + 0.0002dt - 0.0001d^2 + \frac{6.4}{t}$$

where

- R = fire resistance of slab, h,
- t = total thickness of slab, mm, and
- d = thickness of base layer, mm.

**2)** If the base course described in Sentence (1) is covered by a top layer of material other than Type S, N, L40S or L concrete, the top course thickness may be converted to an equivalent concrete thickness by multiplying the actual thickness by the appropriate factor listed in Table D-2.2.3.-A This equivalent concrete thickness may be added to the thickness of the base course and the fire-resistance rating calculated using Table D-2.2.1.-A.

**3)** The minimum concrete cover under the main reinforcement for composite concrete floor and roof slabs with base slabs less than 100 mm thick shall conform to Table D-2.2.3.-B For base slabs 100 mm or more thick, the minimum cover thickness requirements of Table D-2.2.1.-B shall apply.

**4)** Where the top layer of a 2-layer slab is less than 25 mm thick, the fire-resistance rating for the slab shall be calculated as though the entire slab were made up of the type of concrete with the lesser fire resistance.

**Table D-2.2.3.-A  
Multiplying Factors for Equivalent Thickness**

Top Course Material	Base Slab Normal Density Concrete (Type S or N)	Base Slab Low Density Concrete (Type L40S or L)
Gypsum board	3	2.25
Cellular concrete (mass density 400 – 560 kg/m <sup>3</sup> )	2	1.50
Vermiculite and perlite concrete (mass density 560 kg/m <sup>3</sup> or less)	1.75	1.50
Portland cement with sand aggregate	1	0.75
Terrazzo	1	0.75

**Table D-2.2.3.-B  
Minimum Concrete Cover under Bottom Reinforcement in Composite Concrete Slabs, mm**

Base Slab Concrete Type	Fire-Resistance Rating						
	30 min	45 min	1 h	1.5 h	2 h	3 h	4 h
Reinforced concrete							
Type S, N, L40S or L	15	15	20	25	30	40	55
Prestressed concrete							
Type S	20	25	30	40	50	65	75
Type N	20	20	25	35	45	60	70
Type L40S or L	20	20	25	30	40	50	60

**D-2.2.4. Contribution of Plaster Finish**

- 1) The contribution of plaster finish securely fastened to the underside of concrete may be taken into account in floor or roof slabs under the conditions and using the methods described in Subsection D-1.7.
- 2) Plaster finish on the underside of concrete floors or roofs may be used in lieu of concrete cover referred to in Sentence D-2.2.1.(2) under the conditions and using the methods described in Subsection D-1.7.

**D-2.2.5. Concrete Cover**

- 1) In prestressed concrete slab construction, the concrete cover over an individual tendon shall be the minimum thickness of concrete between the surface of the tendon and the fire-exposed surface of the slab, except that for ungrouted ducts the assumed cover thickness shall be the minimum thickness of concrete between the surface of the duct and the bottom of the slab. For slabs in which several tendons are used, the cover is assumed to be the average of those of individual tendons, except that the cover for any individual tendon shall be not less than half of the value given in Table D-2.2.1.-B nor less than 20 mm.
- 2) Except as provided in Sentence (3), in post-tensioned prestressed concrete slabs, the concrete cover to the tendon at the anchor shall be not less than 15 mm greater than the minimum cover required by Sentence (1). The minimum concrete cover to the anchorage bearing plate and to the end of the tendon, if it projects beyond the bearing plate, shall be 20 mm.
- 3) The requirements of Sentence (2) do not apply to those portions of slabs not likely to be exposed to fire, such as the ends and tops.

**D-2.2.6. Minimum Dimensions for Cover**

Minimum dimensions and cover to steel tendons of prestressed concrete beams shall conform to Subsection D-2.10.

**D-2.3. Wood and Steel Framed Walls, Floors and Roofs****D-2.3.1. Maximum Fire-Resistance Rating**

The fire-resistance rating of walls constructed of wood studs or cold-formed-steel studs, of floors constructed of wood joists, wood I-joists, pre-manufactured wood trusses, cold-formed steel joists or open web steel joists, and of roofs constructed of wood joists, pre-manufactured metal-plate-connected wood trusses or open web steel joists can be determined for ratings of not more than 90 min from the information in this Subsection.

**D-2.3.2. Loadbearing Conditions**

- 1) The fire-resistance ratings derived from the information in this Subsection apply to loadbearing and non-loadbearing wood-framed and cold-formed-steel-framed walls, and to loadbearing floors and roofs, as specifically described in this Subsection.
- 2) Loadbearing conditions shall be as defined in CAN/ULC-S101, "Fire Endurance Tests of Building Construction and Materials."

**D-2.3.3. Limitations of Component Additive Method**

(See Section D-6, Background Information.)

- 1) The fire-resistance rating of a framed assembly depends primarily on the time during which the membrane on the fire-exposed side remains in place.
- 2) The assigned times in Sentences D-2.3.4.(2), (3) and (4) are not intended to be construed as the fire-resistance ratings of the individual components of an assembly, nor are they intended to be construed as times that are applicable or acceptable for use beyond the method and systems described in this Subsection. These assigned times are the individual contributions of each component to the overall fire-resistance rating of an assembly, which is permitted to be derived using the component additive method described in this Subsection.
- 3) The fire-resistance rating calculated by the component additive method cannot be increased by installing membranes in multiple layers, other than as specified in Tables D-2.3.4.-A, D-2.3.4.-B, and D-2.3.4.-C.

**D-2.3.4. Method of Calculation**

**1)** In the component additive method, the fire-resistance rating of a framed assembly is calculated by adding the time assigned in Sentence (2) for the membrane on the fire-exposed side to the time assigned in Sentence (3) for the framing members and then adding any time assigned in Sentence (4) for additional protective measures, such as the inclusion of insulation or of reinforcement for a membrane. For loadbearing walls where resilient metal channels are installed with a single layer of gypsum board membrane in accordance with Table D-2.3.4.-A, the fire-resistance rating determined using this method of calculation must be reduced by 10 min.

**2)** The times to be used in the component additive method that have been assigned to membranes on the fire-exposed side of the assembly, which are partly based on their ability to remain in place during fire tests, are listed in Tables D-2.3.4.-A, D-2.3.4.-B, D-2.3.4.-C and D-2.3.4.-D. (This is not to be confused with the fire-resistance rating of the membrane, which also takes into account the rise in temperature on the unexposed side of the membrane. [See Sentence D-2.3.3.(2).])

**Table D-2.3.4.-A  
Time Assigned to Protective Membranes on Fire-Exposed Side of Wood-Framed and Cold-Formed-Steel-Framed Walls**

Description of Finish	Time, min	
	Loadbearing Walls	Non-Loadbearing Walls
11.0 mm Douglas Fir plywood phenolic bonded	—	10 <sup>(1)</sup>
14.0 mm Douglas Fir plywood phenolic bonded	—	15 <sup>(1)</sup>
12.7 mm Type X gypsum board	25 <sup>(2)</sup>	25
15.9 mm Type X gypsum board	40 <sup>(2)</sup>	40 <sup>(3)</sup>
Double 12.7 mm Type X gypsum board <sup>(4)</sup>	50	80

**Notes to Table D-2.3.4.-A:**

- (1) Applies to stud cavities filled with mineral wool conforming to CAN/ULC-S702, "Mineral Fibre Thermal Insulation for Buildings," and having a mass per unit area of not less than 2 kg/m<sup>2</sup>, with no additional credit for insulation according to Table D-2.3.4.-G.
- (2) Applies only to wood-framed walls.
- (3) Applies only to steel-framed walls.
- (4) Resilient metal channels are permitted to be installed at a spacing of 400 mm o.c. with no effect on the rating of the wall assembly.

**Table D-2.3.4.-B  
Time Assigned to Gypsum Board Membranes on Fire-Exposed Side of Floors**

Description of Finish	Resilient Metal Channels <sup>(1)</sup>	Time, min	
		Floors with Wood or Steel Joists	Floors with Open-Web Steel Joists
12.7 mm Type X gypsum board	Spaced ≤ 400 mm o.c. <sup>(2)</sup>	25 <sup>(3)</sup>	—
15.9 mm Type X gypsum board		40	—
12.7 mm Type X gypsum board	—	25 <sup>(4)</sup>	25
15.9 mm Type X gypsum board		40 <sup>(4)</sup>	40
Double 12.7 mm Type X gypsum board	Spaced ≤ 400 mm o.c. <sup>(5)</sup>	50 <sup>(3)</sup>	—
Double 12.7 mm Type X gypsum board	Spaced at 600 mm o.c. <sup>(6)</sup>	45 <sup>(3)</sup>	—
Double 15.9 mm Type X gypsum board	Spaced ≤ 600 mm o.c. <sup>(6)</sup>	60 <sup>(3)</sup>	—

**Notes to Table D-2.3.4.-B:**

- (1) See Figures A-9.10.3.1.-A, A-9.10.3.1.-B and A-9.10.3.1.-D in Note A-9.10.3.1. for the attachment of single and double layers of gypsum board to resilient metal channels.
- (2) Resilient metal channels must be installed to achieve the stated rating.
- (3) Applies to wood joists, wood trusses, wood I-joists and cold-formed steel joists (C-shaped joists).
- (4) Applies to wood joists and pre-fabricated metal-plate-connected wood trusses.
- (5) Resilient metal channels must be installed or gypsum board must be applied directly to the structural members, which must be spaced not more than 400 mm o.c.
- (6) Resilient metal channels are permitted to be installed with no effect on the rating of the floor assembly. Gypsum board is also permitted to be directly applied to the structural members.

**Table D-2.3.4.-C**  
**Time Assigned to Gypsum Board Membranes on Fire-Exposed Side of Roofs**

Description of Finish	Time, min <sup>(1)</sup>
12.7 mm Type X gypsum board	25
15.9 mm Type X gypsum board	40

**Notes to Table D-2.3.4.-C:**

(1) Applies to wood joists, pre-fabricated metal-plate-connected wood trusses, and open-web steel joists with ceiling supports spaced ≤ 400 mm o.c.

**Table D-2.3.4.-D**  
**Time Assigned for Contribution of Lath and Plaster Protection on Fire-Exposed Side**

Type of Lath	Plaster Thickness, mm	Type of Plaster Finish		
		Portland Cement and Sand <sup>(1)</sup> or Lime and Sand	Gypsum and Sand or Gypsum Wood Fibre	Gypsum and Perlite or Gypsum and Vermiculite
		Time, min <sup>(2)</sup>		
9.5 mm gypsum	13	—	35	55
	16	—	40	65
	19	—	50	80 <sup>(3)</sup>
Metal	19	20	50	80 <sup>(3)</sup>
	23	25	65	80 <sup>(3)</sup>
	26	30	80	80 <sup>(3)</sup>

**Notes to Table D-2.3.4.-D:**

- (1) For mixture of Portland cement-sand plaster, see Sentence D-1.7.2.(2).
- (2) Applies to loadbearing and non-loadbearing wood studs or non-loadbearing cold-formed-steel studs, to floors constructed of wood joists or open-web steel joists, and to roofs constructed of wood joists, pre-manufactured metal-plate-connected wood trusses, or open-web steel joists.
- (3) Values shown for these membranes have been limited to 80 min because the fire-resistance ratings of framed assemblies derived from these Tables must not exceed 1.5 h.

**3)** The times to be used in the component additive method that have been assigned to wall framing members and to floor and roof framing members are listed in Tables D-2.3.4.-E and D-2.3.4.-F respectively.

**Table D-2.3.4.-E**  
**Time Assigned for Contribution of Wood-Framed or Cold-Formed-Steel-Framed Walls**

Description of Frame	Time, min	
	Loadbearing Walls	Non-Loadbearing Walls
Wood studs spaced ≤ 400 mm o.c.	20	
Wood studs spaced ≤ 600 mm o.c.	15	
Cold-formed-steel studs spaced ≤ 400 mm o.c.	10	
Cold-formed-steel studs spaced ≤ 600 mm o.c.	10	—

**Table D-2.3.4.-F**  
**Time Assigned for Contribution of Wood or Steel Frame of Floors and Roofs**

Description of Frame		Time, min
Type of Assembly	Structural Members	
Floor <sup>(1)</sup>	Wood joists, wood I-joists, wood trusses and cold-formed-steel joists spaced ≤ 600 mm o.c.	10 <sup>(2)</sup>
	Open-web steel joists with ceiling supports spaced ≤ 400 mm o.c.	
Roof	Wood joists spaced ≤ 400 mm o.c.	10
	Open-web steel joists with ceiling supports spaced ≤ 400 mm o.c.	10
	Wood truss assemblies [metal-plate-connected] spaced ≤ 600 mm o.c.	5



**Table D-2.3.4-F (Continued)**

**Notes to Table D-2.3.4-F:**

- (1) Resilient metal channels are permitted to be installed with no effect on the rating of the floor assembly.
- (2) Applies only to floor structural members that are protected by a membrane.

**4)** Preformed insulation of glass, rock or slag fibre and cellulose fibre insulation provide additional protection to wood studs by shielding the studs from exposure to the fire and thus delaying the time of collapse. The use of preformed glass fibre, preformed rock or slag fibre and dry-blown cellulose insulation material does not decrease the rating of wall assemblies with the membranes identified in Table D-2.3.4.-A. Similarly, the use of preformed glass fibre, preformed rock or slag fibre and cellulose insulation material does not decrease the rating of floor assemblies constructed with wood joists, wood trusses, wood I-joists and cold-formed-steel floor joists (C-shaped joists), provided the insulation is not in direct contact with the membranes identified in Table D-2.3.4.-B. The use of reinforcement in the membrane exposed to fire also adds to the fire resistance by extending the time to failure. Table D-2.3.4.-G shows the time increments that may be added to the fire resistance if these features are incorporated in the assembly.

**Table D-2.3.4-G  
Time Assigned for Additional Protection**

Description of Additional Protection	Time, min
Add to the fire-resistance rating of wood stud walls, sheathed with gypsum board or lath and plaster, if the spaces between the studs are filled with preformed insulation of rock or slag fibres conforming to CAN/ULC-S702, "Mineral Fibre Thermal Insulation for Buildings," and with a mass per unit area of not less than 1.22 kg/m <sup>2</sup> of wall surface	15 <sup>(1)</sup>
Add to the fire-resistance rating of non-loadbearing wood stud walls, sheathed with gypsum board or lath and plaster, if the spaces between the studs are filled with preformed insulation of glass fibres conforming to CAN/ULC-S702, "Mineral Fibre Thermal Insulation for Buildings," and having a mass per unit area of not less than 0.6 kg/m <sup>2</sup> of wall surface	5 <sup>(2)</sup>
Add to the fire-resistance rating of loadbearing wood stud walls sheathed with gypsum board if the spaces between the studs are filled with insulation of cellulose fibres conforming to CAN/ULC-S703, "Cellulose Fibre Insulation for Buildings," and having a density of not less than 50 kg/m <sup>3</sup>	10
Add to the fire-resistance rating of plaster on gypsum lath ceilings if 0.76 mm diam wire mesh with 25 mm by 25 mm openings or 1.57 mm diam diagonal wire reinforcing at 250 mm o.c. is placed between lath and plaster	30
Add to the fire-resistance rating of plaster on gypsum lath ceilings if 76 mm wide metal lath strips are placed over joints between lath and plaster	10
Add to the fire-resistance rating of plaster on 9.5 mm thick gypsum lath ceilings (Table D-2.3.4.-D) if supports for lath are 300 mm o.c.	10
Add to the fire-resistance rating of floor assemblies if the spaces between the structural members are filled with preformed insulation of rock or slag fibres conforming to CAN/ULC-S702, "Mineral Fibre Thermal Insulation for Buildings," and having a mass per unit area of not less than 1.22 kg/m <sup>2</sup> of floor surface	5 <sup>(2)</sup>
Add to the fire-resistance rating of floor assemblies if the spaces between the structural members are filled with wet-blown cellulose fibres conforming to CAN/ULC-S703, "Cellulose Fibre Insulation for Buildings," and having a density of not less than 50 kg/m <sup>3</sup>	5 <sup>(2)(3)</sup>
Add to the fire-resistance rating of floor assemblies where the floor topping on the unexposed side of the floor assemblies consists of concrete not less than 38 mm thick	5 <sup>(2)</sup>

**Notes to Table D-2.3.4-G:**

- (1) Applies to wood-framed walls only.
- (2) Applies to wood joists, wood trusses, wood I-joists and cold-formed-steel joists (C-shaped joists).
- (3) Applies to cellulose fibre:
  - (i) for wood joists, wood I-joist and wood trusses—that is spray-applied with a minimum density of 50 kg/m<sup>3</sup>, a minimum depth of 90 mm on the underside of the subfloor, and of 90 mm on the sides of the structural members;
  - (ii) for cold-formed-steel joists—that is spray-applied with a minimum density of 50 kg/m<sup>3</sup> and a minimum thickness of 90 mm on the underside of the subfloor, of 90 mm on the sides of the structural members, and of 13 mm on the underside of the bottom flange other than at resilient metal channel locations.

**5)** Cellulose fibre insulation conforming to CAN/ULC-S703, "Cellulose Fibre Insulation for Buildings," applied in conformance with CAN/CGSB-92.2-M, "Trowel or Spray Applied Acoustical Material," does not affect the fire-resistance rating of a non-loadbearing cold-formed-steel stud wall assembly, provided that it is sprayed to either face of the wall cavity.

**D-2.3.5. Considerations for Various Types of Assemblies**

**1)** Interior vertical fire separations are to be rated for exposure to fire on each side (see Sentence 3.1.7.3.(2)). The method described in this Subsection applies when a membrane is provided on both sides of the assembly. However, in the calculation of the fire-resistance rating of such an assembly using this method, no additional contribution to fire resistance is to be assigned for a membrane on the non-fire-exposed side, since its contribution is already accounted for in the values assigned to the other components of the assembly.

**2)** Exterior wall assemblies required to have a fire-resistance rating are required to be rated for exposure to fire from the interior side only (see Sentence 3.1.7.3.(3)). When deriving a fire-resistance rating for such wall assemblies using the method described in this Subsection, only wood studs with a single layer of gypsum board or non-loadbearing cold-formed-steel studs conforming to Table D-2.3.4.-E may be used. Such walls must have a membrane on the exterior side of the stud consisting of plywood, oriented strandboard or gypsum sheathing and exterior cladding. Additional materials are also permitted between the required sheathing and cladding. The spaces between the studs are to be filled with insulation conforming to CAN/ULC-S702, "Mineral Fibre Thermal Insulation for Buildings," and having a mass per unit area of not less than 1.22 kg/m<sup>2</sup> of wall surface. However, in the calculation of the fire-resistance rating of such an assembly, no additional contribution to fire resistance is to be assigned for a membrane on the non-fire-exposed side, since its contribution is already accounted for in the values assigned to the other components of the assembly.

**3)** In the case of a floor or roof assembly, the Code only requires testing for fire exposure from below. Floors or roofs must have an upper flooring or roofing membrane in accordance with Table D-2.3.5.

**Table D-2.3.5.  
Flooring or Roofing Membranes**

Type of Assembly	Structural Members	Subfloor or Roof Deck	Finished Flooring or Roofing
Floor	Wood or open-web steel joists <sup>(1)</sup> and metal-plate-connected wood trusses <sup>(1)</sup>	12.5 mm plywood or 15.5 mm oriented strandboard or 17 mm T & G softwood or 14 mm phenolic-bonded Douglas Fir plywood (no finished flooring required)	Hardwood or softwood flooring on building paper Resilient flooring, parquet floor, felted synthetic fibre floor coverings, carpeting, or ceramic tile on 8 mm thick panel-type underlay Ceramic tile on 30 mm mortar bed
	Open-web steel joists <sup>(1)</sup>	50 mm reinforced concrete or 50 mm concrete on metal lath or formed steel sheet or 40 mm reinforced gypsum-fibre concrete on 12.7 mm gypsum board	Finish flooring
	Wood joists, wood I-joists, wood trusses and cold-formed-steel joists	minimum 15.5 mm T & G plywood or minimum 15.5 mm oriented strandboard	No requirement
Roof	Wood or open-web steel joists <sup>(1)</sup> and wood trusses <sup>(1)</sup>	12.5 mm plywood or 15.5 mm oriented strandboard or 17 mm T & G softwood or 14 mm phenolic-bonded Douglas Fir plywood (no finished flooring required)	Finish roofing material with or without insulation
	Open-web steel joists <sup>(1)</sup>	50 mm reinforced concrete or 50 mm concrete on metal lath or formed steel sheet or 40 mm reinforced gypsum-fibre concrete on 12.7 mm gypsum board	Finish roofing material with or without insulation

**Notes to Table D-2.3.5.:**

<sup>(1)</sup> Applies to single layer of gypsum board membrane, and lath and plaster.

**4)** Insulation used in the cavities of a wood joist or metal-plate-connected wood truss floor assembly with a single layer of gypsum board will not reduce the assigned fire-resistance rating of the assembly, provided:

- a) the insulation is preformed of rock, slag or glass fibre conforming to CAN/ULC-S702, "Mineral Fibre Thermal Insulation for Buildings," and having a mass per unit area of not more than 1.1 kg/m<sup>2</sup> and is installed adjacent to the bottom edge of the framing member, directly above steel furring channels,
- b) the gypsum board ceiling membrane is attached to
  - i) wood trusses in conformance with Sentence D-2.3.9.(2) by way of steel furring channels spaced not more than 400 mm o.c., and the channels are secured to each bottom truss member with a double strand of 1.2 mm galvanized steel wire, or
  - ii) wood joists by way of resilient metal or steel furring channels spaced not more than 400 mm o.c. in conformance with Sentences D-2.3.9.(2) and (3), and
- c) a steel furring channel is installed midway between each furring channel mentioned in Clause (b) to provide additional support for the insulation.

**5)** Except as required in Sentence D-2.3.5.(4), resilient metal or steel furring channels may be used to attach a gypsum board ceiling membrane to a floor assembly using wood joists, metal-plate-connected wood trusses and open-web steel joists, or to a roof assembly. The channels must be made of galvanized steel not less than 0.5 mm thick spaced not more than 600 mm o.c. perpendicular to the framing members, with an overlap of not less than 100 mm at splices and a minimum end clearance between the channels and walls of 15 mm.

### D-2.3.6. Framing Members

**1)** The values shown in Tables D-2.3.4.-A, D-2.3.4.-B, D-2.3.4.-D and D-2.3.12. apply to membranes supported on framing members installed in their conventional orientation and spaced in conformance with Tables D-2.3.4.-E and D-2.3.4.-F.

**2)** Wood studs and wood roof framing members are to be not less than 38 mm by 89 mm. Wood floor joists are to be not less than 38 mm by 184 mm, except where they are used in an assembly from Table D-2.3.4.-D or from Table D-2.3.5. that uses a single layer of gypsum board as the lower (ceiling) membrane, in which case, wood floor joists are to be not less than 38 mm by 89 mm.

**3)** Wood roof trusses are to consist of wood chord and web framing members not less than 38 mm by 89 mm and metal connector plates fabricated from galvanized steel not less than 1 mm in nominal thickness with projecting teeth not less than 8 mm long.

**4)** Wood floor trusses are to consist of:

- a) metal-plate-connected wood trusses that are not less than 305 mm deep with wood chord and web framing members not less than 38 mm by 64 mm and metal connector plates fabricated from galvanized steel not less than 1 mm in nominal thickness with projecting teeth not less than 8 mm long;
- b) metal-web wood trusses that are not less than 286 mm deep with wood chords not less than 38 mm by 64 mm and V-shaped webs made from galvanized steel not less than 1 mm in nominal thickness with plate areas having teeth not less than 8 mm long; or
- c) fingerjoined wood trusses that are not less than 330 mm deep with fingerjoined connections, chord members not less than 38 mm by 64 mm, and web members not less than 38 mm by 38 mm glued together with a R-14 phenol-resorcinol resin conforming to CSA O112.10, "Evaluation of Adhesives for Structural Wood Products (Limited Moisture Exposure)."

**5)** Wood I-joists are to be not less than 241 mm deep with flanges that are not less than 38 mm by 38 mm and an oriented strandboard or plywood web that is not less than 9.5 mm thick.

**6)** The dimensions for dressed lumber given in CSA O141, "Softwood Lumber," are to be used for wood studs, joists, I-joists and trusses.

**7)** Cold-formed-steel studs for non-loadbearing walls are to consist of galvanized steel that is not less than 0.5 mm thick and not less than 63 mm wide, and have a flange that is not less than 31 mm wide.

**8)** Cold-formed-steel studs in non-loadbearing wall assemblies are to be installed with not less than a 12 mm clearance between the top of the stud and the top of the runner to allow for expansion in the event of a fire. Where the studs are required to be attached for alignment purposes during erection, they must be attached to the bottom runners only.

**9)** Cold-formed-steel studs for loadbearing walls are to consist of galvanized steel that is not less than 0.912 mm thick but not greater than 1.52 mm thick, with a C-shaped cross-section not less than 92 mm deep by 41 mm wide and 12.7 mm stiffening lips.

**10)** Cold-formed-steel studs in loadbearing wall assemblies are to be installed with diagonal cross-bracing.

**11)** Cold-formed-steel floor joists (C-shaped joists) are to be not less than 41 mm wide x 203 mm deep x 1.22 mm material thickness.

**12)** The allowable spans for wood joists listed in the Span Tables in Part 9 are provided for floors supporting specific occupancies.

**D-2.3.7. Plaster Finish**

The thickness of plaster finish shall be measured from the face of gypsum or metal lath.

**D-2.3.8. Edge Support for Gypsum Board in Wall Assembly**

Gypsum board installed over framing or furring in a wall assembly shall be installed so that all edges are supported, except that 15.9 mm Type X gypsum board may be installed horizontally with the horizontal joints unsupported when framing members are at 400 mm o.c. maximum.

**D-2.3.9. Membrane Fastening**

**1)** Except as provided in Sentences (2) to (5), Table D-2.3.4.-B and Sentence D-2.3.5.(5), the application of lath and plaster finish shall conform to CSA A82.30-M, "Interior Furring, Lathing and Gypsum Plastering," and of gypsum board finish shall conform to ASTM C 840, "Application and Finishing of Gypsum Board."

**2)** Where a membrane referred to in Table D-2.3.4.-A, D-2.3.4.-B, D-2.3.4.-C, D-2.3.4.-D or D-2.3.12. is applied to steel framing or furring, fasteners shall penetrate not less than 10 mm through the metal.

**3)** Except as provided in Sentence (4), where a membrane referred to in Table D-2.3.4.-A, D-2.3.4.-B, D-2.3.4.-C, D-2.3.4.-D or D-2.3.12. is applied to wood framing or furring, minimum fastener penetrations into wood members shall conform to Table D-2.3.9. for the time assigned to the membrane.

**Table D-2.3.9.  
Membrane Fastening**

Type of Membrane	Minimum Penetration of Fasteners for Membrane Protection on Wood Framing, mm					
	5 – 25	30 – 35	40	50	55 – 70	80
	Time, <sup>(1)</sup> min					
Single layer	20	29	32	—	—	—
Double layer	20	20	20	29	35	44
Gypsum lath	20	20	23	23	29	29

**Notes to Table D-2.3.9.:**

<sup>(1)</sup> Assigned contributions of membranes to fire resistance are listed in Tables D-2.3.4.-A, D-2.3.4.-B, D-2.3.4.-C, D-2.3.4.-D and D-2.3.12.

**4)** Where a membrane is applied in 2 layers, the fastener penetrations described in Table D-2.3.9. shall apply to the base layer. Fasteners for the face layer shall penetrate not less than 20 mm into wood supports.

**5)** In a double layer application of gypsum board on wood supports, fastener spacing shall conform to ASTM C 840, "Application and Finishing of Gypsum Board."

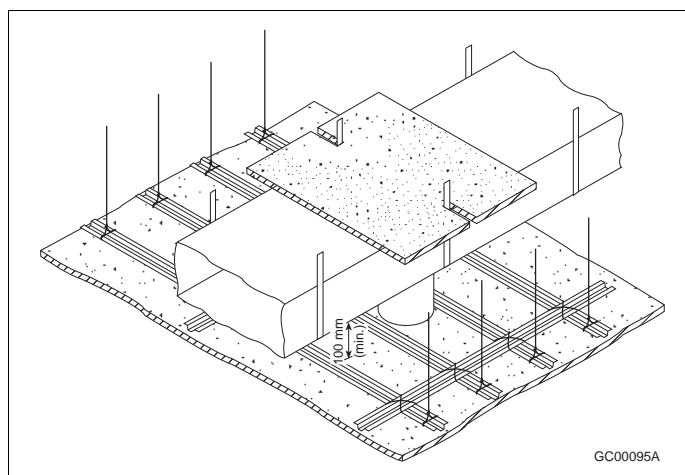
**D-2.3.10. Ceiling Membrane Openings – Combustible Construction**

**1)** Except as permitted in Article D-2.3.12., where a floor or roof assembly of combustible construction is assigned a fire-resistance rating on the basis of this Subsection and incorporates a ceiling membrane described in Table D-2.3.4.-B, D-2.3.4.-C or D-2.3.4.-D, the ceiling membrane may be penetrated by openings leading to ducts within concealed spaces above the membrane provided:

- a) the assembly is not required to have a fire-resistance rating in excess of 1 h,
- b) the area of any openings does not exceed 930 cm<sup>2</sup> (see Sentence (2)),
- c) the aggregate area of openings does not exceed 1% of the ceiling area of the fire compartment,
- d) the depth of the concealed space above the ceiling is not less than 230 mm,
- e) no dimension of any opening exceeds 310 mm,
- f) supports are provided for openings with any dimension exceeding 150 mm where framing members are spaced greater than 400 mm o.c.,

- g) individual openings are spaced not less than 2 m apart,
- h) the ducts above the membrane are sheet steel and are supported by steel strapping firmly attached to the framing members, and
- i) the clearance between the top surface of the membrane and the bottom surface of the ducts is not less than 100 mm.

- by **2)** Where an individual opening permitted in Sentence (1) exceeds 130 cm<sup>2</sup> in area, it shall be protected
- a) a fire stop flap conforming to CAN/ULC-S112.2, "Fire Test of Ceiling Firestop Flap Assemblies," that activates at a temperature approximately 30°C above the normal maximum temperature that occurs in the ducts, whether the air duct system is operating or shut down, or
  - b) thermal protection above the duct consisting of the same materials as used for the ceiling membrane, mechanically fastened to the ductwork and extending 200 mm beyond the opening on all sides (see Article D-2.3.10.).



**Figure D-2.3.10.**  
Thermal protection above a duct

**D-2.3.11. Ceiling Membrane Openings - Noncombustible Construction**

**1)** Except as permitted in Article D-2.3.12., where a floor or roof assembly of noncombustible construction is assigned a fire-resistance rating on the basis of this Subsection and incorporates a ceiling membrane described in Table D-2.3.4.-B, D-2.3.4.-C or D-2.3.4.-D, the ceiling membrane may be penetrated by openings leading to ducts located within concealed spaces provided:

- a) the area of any opening does not exceed 930 cm<sup>2</sup> (see Sentence (2)),
- b) the aggregate area of openings does not exceed 2% of the ceiling area of the fire compartment,
- c) no dimension of any opening exceeds 400 mm,
- d) individual openings are spaced not less than 2 m apart,
- e) openings are located not less than 200 mm from major structural members such as beams, columns or joists,
- f) the ducts above the membrane are sheet steel and are supported by steel strapping firmly attached to the framing members, and
- g) the clearance between the top surface of the membrane and the bottom surface of the duct is not less than 100 mm.

- by **2)** Where an individual opening permitted in Sentence (1) exceeds 130 cm<sup>2</sup> in area, it shall be protected
- a) a fire stop flap conforming to CAN/ULC-S112.2, "Fire Test of Ceiling Firestop Flap Assemblies," that activates at a temperature approximately 30°C above the normal maximum temperature that occurs in the ducts, whether the air duct system is operating or shut down, or
  - b) thermal protection above the duct consisting of the same materials as used for the ceiling membrane, mechanically fastened to the ductwork and extending 200 mm beyond the opening on all sides (see Article D-2.3.10.).

**D-2.3.12. Ceiling Membrane Rating**

Where the fire-resistance rating of a ceiling assembly is to be determined on the basis of the membrane only and not of the complete assembly, the ratings may be determined from Table D-2.3.12., provided no openings described in Articles D-2.3.10. and D-2.3.11. are located within the ceiling membrane.

**Table D-2.3.12.  
Fire-Resistance Rating for Ceiling Membranes**

Description of Membrane	Fire-Resistance Rating, min
15.9 mm Type X gypsum board with $\geq$ 75 mm mineral wool batt insulation above board	30
19 mm gypsum-sand plaster on metal lath	30
Double 14.0 mm Douglas Fir plywood phenolic bonded	30
Double 12.7 mm Type X gypsum board	45
25 mm gypsum-sand plaster on metal lath	45
Double 15.9 mm Type X gypsum board	60
32 mm gypsum-sand plaster on metal lath	60

**D-2.3.13. Membrane Penetrations in Combustible and Noncombustible Construction**

**1)** Where a wall, floor or roof assembly is assigned a fire-resistance rating on the basis of this Subsection and includes a membrane or membranes described in Table D-2.3.4.-A, D-2.3.4.-B, D-2.3.4.-C, D-2.3.4.-D or D-2.3.12., penetrations of the membrane or membranes must be fire stopped in conformance with the applicable requirements in Article 3.1.9.1. or Sentence 9.10.9.6.(1).

**D-2.3.14. Beams**

**1)** Where a steel beam is included with an open-web steel joist and is protected by the same continuous ceiling, the beam is assumed to have a fire-resistance rating equal to that assigned to the rest of the assembly.

**2)** The ratings in this Subsection assume that the construction to which the beam is related is a normal one and does not carry unusual loads from the floor or slab above.

**D-2.3.15. Wired Glass Assembly Support**

**1)** Openings in a vertical fire separation having a fire-resistance rating of not more than 1 h are allowed to be protected by wired glass assemblies, provided the wired glass is

- a) not less than 6 mm thick;
- b) reinforced by a steel wire mesh in the form of diamonds, squares or hexagons having dimensions of
  - i) approximately 25 mm across the flats, using wire of not less than 0.45 mm diameter, or
  - ii) approximately 13 mm across the flats, using wire of not less than 0.40 mm diameter, the wire to be centrally embedded during manufacture and welded or intertwined at each intersection;
- c) set in fixed steel frames with metal not less than 1.35 mm thick and providing a glazing stop of not less than 20 mm on each side of the glass; and
- d) limited in area so that
  - i) individual panes are not more than 0.84 m<sup>2</sup>, with neither height nor width more than 1.4 m, and
  - ii) the area not structurally supported by mullions is not more than 7.5 m<sup>2</sup>.

**2)** It is intended that the structural mullions referred to in Subclause (1)(d)(ii) will not distort or be displaced to the extent that there would be a failure of the wired glass closure during the period for which a closure in the fire separation would be expected to function. Hollow structural steel tubing not less than 100 mm square filled with a Portland cement-based grout will satisfy the intent of the Subclause.

**D-2.4. Solid Wood Walls, Floors and Roofs**

**D-2.4.1. Minimum Thickness**

The minimum thickness of solid wood walls, floors and roofs for fire-resistance ratings from 30 min to 1.5 h is shown in Table D-2.4.1.

**Table D-2.4.1.**  
**Minimum Thickness of Solid Wood Walls, Roofs and Floors, mm<sup>(1)(2)</sup>**

Type of Construction	Fire-Resistance Rating			
	30 min	45 min	1 h	1.5 h
Solid wood floor with building paper and finish flooring on top <sup>(3)</sup>	89	114	165	235
Solid wood, splined or tongued and grooved floor with building paper and finish flooring on top <sup>(4)</sup>	64	76	—	—
Solid wood walls of loadbearing vertical plank <sup>(3)</sup>	89	114	140	184
Solid wood walls of non-loadbearing horizontal plank <sup>(3)</sup>	89	89	89	140

**Notes to Table D-2.4.1.:**

- (1) See CSA O141, "Softwood Lumber," for sizes.
- (2) The fire-resistance ratings and minimum dimensions for floors also apply to solid wood roof decks of comparable thickness with finish roofing material.
- (3) The assembly shall consist of 38 mm thick members on edge fastened together with 101 mm common wire nails spaced not more than 400 mm o.c. and staggered in the direction of the grain.
- (4) The floor shall consist of 64 mm by 184 mm wide planks either tongued and grooved or with 19 mm by 38 mm splines set in grooves and fastened together with 88 mm common nails spaced not more than 400 mm o.c.

**D-2.4.2. Increased Fire-Resistance Rating**

- 1)** The fire-resistance rating of the assemblies described in Table D-2.4.1. may be increased by 15 min if one of the following finishes is applied on the fire-exposed side:
  - a) 12.7 mm thick gypsum board,
  - b) 20 mm thick gypsum-sand plaster on metal lath, or
  - c) 13 mm thick gypsum-sand plaster on 9.5 mm gypsum lath.
- 2)** Fastening of the plaster to the wood structure shall conform to Subsection D-2.3.

**D-2.4.3. Supplementary Ratings**

Supplementary ratings based on tests are included in Table D-2.4.3. The ratings given shall apply to constructions that conform in all details with the descriptions given.

**Table D-2.4.3.**  
**Fire-Resistance Rating of Non-Loadbearing Built-up Solid Wood Partitions<sup>(1)</sup>**

Construction Details	Actual Overall Thickness, mm	Fire-Resistance Rating
Solid panels of wood boards 64 mm to 140 mm wide grooved and joined with wood splines, nailed together, boards placed vertically with staggered joints, 3 boards thick	58	30 min
Solid panels with 4 mm plywood facings <sup>(2)</sup> glued to 46 mm solid wood core of glued, tongued and grooved construction for both sides and ends of core pieces with tongued and grooved rails in the core about 760 mm apart	54	1 h

**Notes to Table D-2.4.3.:**

- (1) The ratings and notes are taken from "Fire Resistance Classifications of Building Constructions," Building Materials and Structures Report BMS 92, National Bureau of Standards, Washington, 1942.
- (2) Ratings for plywood faced panel are based on phenolic resin glue being used for gluing facings to wood frames. If other types of glue are used for this purpose, the ratings apply if the facings are nailed to the frames in addition to being glued.

**D-2.5. Solid Plaster Partitions****D-2.5.1. Minimum Thickness**

The minimum thickness of solid plaster partitions for fire-resistance ratings from 30 min to 4 h is shown in Table D-2.5.1.

**Table D-2.5.1.**  
**Minimum Thickness of Non-Loadbearing Solid Plaster Partitions, mm**

Type of Plaster on Metal Lath <sup>(1)</sup>	Fire-Resistance Rating						
	30 min	45 min	1 h	1.5 h	2 h	3 h	4 h
Portland cement-sand <sup>(2)</sup> or Portland cement-lime-sand	50 <sup>(3)</sup>	—	—	—	—	—	—
Gypsum-sand	50 <sup>(3)</sup>	50 <sup>(3)</sup>	64	—	—	—	—
Gypsum-vermiculite, gypsum-perlite, Portland cement-vermiculite or Portland cement-perlite	50 <sup>(3)</sup>	50 <sup>(3)</sup>	50 <sup>(3)</sup>	58	64	83	102

**Notes to Table D-2.5.1.:**

- (1) Metal lath shall be expanded metal lath or welded woven wire fabric supported on 19 mm vertical light steel studs spaced not more than 600 mm o.c. Plaster shall be applied to both sides of the lath.  
 (2) For mixture of Portland cement-sand plaster, see Sentence D-1.7.2.(2).  
 (3) CSA A82.30-M, "Interior Furring, Lathing and Gypsum Plastering," does not permit solid plaster partitions less than 50 mm thick.

**D-2.6. Protected Steel Columns****D-2.6.1. Minimum Thickness of Protective Covering**

The minimum thickness of protective covering to steel columns is shown in Tables D-2.6.1.-A to D-2.6.1.-F for fire-resistance ratings from 30 min to 4 h.

**Table D-2.6.1.-A**  
**Minimum Thickness of Concrete or Masonry Protection to Steel Columns, mm**

Description of Cover	Fire-Resistance Rating						
	30 min	45 min	1 h	1.5 h	2 h	3 h	4 h
Monolithic concrete							
Type S concrete <sup>(1)</sup> (column spaces filled) <sup>(2)</sup>	25	25	25	25	39	64	89
Type N or L concrete <sup>(1)</sup> (column spaces filled) <sup>(2)</sup>	25	25	25	25	32	50	77
Concrete masonry units <sup>(3)</sup> or precast reinforced concrete units							
Type S concrete (column spaces not filled)	50	50	50	50	64	89	115
Type N or L concrete (column spaces not filled)	50	50	50	50	50	77	102
Clay or shale brick <sup>(4)</sup> (column spaces filled) <sup>(2)</sup>	50	50	50	50	50	64	77
Clay or shale brick <sup>(4)</sup> (column spaces not filled)	50	50	50	50	50	77	102
Hollow clay tile <sup>(5)</sup> (column spaces filled) <sup>(2)</sup>	50 <sup>(6)</sup>	50 <sup>(6)</sup>	50 <sup>(6)</sup>	50 <sup>(6)</sup>	<sup>(7)</sup>	<sup>(7)</sup>	<sup>(7)</sup>
Hollow clay tile <sup>(5)</sup> (column spaces not filled)	50 <sup>(6)</sup>	50 <sup>(6)</sup>	50 <sup>(6)</sup>	—	—	—	—

**Notes to Table D-2.6.1.-A:**

- (1) Applies to cast-in-place concrete reinforced with 5.21 mm diam wire wrapped around column spirally 200 mm o.c., or 1.57 mm diam wire mesh with 100 mm by 100 mm openings.  
 (2) The space between the protective covering and the web or flange of the column shall be filled with concrete, cement mortar or a mixture of cement mortar and broken bricks.  
 (3) Concrete masonry shall be reinforced with 5.21 mm diam wire or wire mesh with 1.19 mm diam wire and 10 mm by 10 mm openings, laid in every second course.  
 (4) Brick cover 77 mm thick or less shall be reinforced with 2.34 mm diam wire or 1.19 mm diam wire mesh with 10 mm by 10 mm openings, laid in every second course.



**Table D-2.6.1.-A (Continued)**

- (5) Hollow clay tiles and masonry mortar shall be reinforced with 1.19 mm diam wire mesh with 10 mm by 10 mm openings, laid in every horizontal joint and lapped at corners.
- (6) Hollow clay tiles shall conform to CAN/CSA-A82, "Fired Masonry Brick Made from Clay or Shale."
- (7) 50 mm nominal hollow clay tile, reinforced with 1.19 mm diam wire mesh with 10 mm by 10 mm openings laid in every horizontal joint and covered with 19 mm gypsum-sand plaster and with limestone concrete fill in column spaces, has a 4 h fire-resistance rating.

**Table D-2.6.1.-B  
Minimum Thickness of Plaster Protection to Steel Columns, mm**

Description	Fire-Resistance Rating <sup>(1)(2)</sup>						
	30 min	45 min	1 h	1.5 h	2 h	3 h	4 h
Gypsum-sand plaster on 9.5 mm gypsum lath <sup>(3)</sup>	13	13	13	20	—	—	—
Gypsum-perlite or vermiculite plaster on 9.5 mm gypsum lath <sup>(3)</sup>	13	13	13	20	25	—	—
Gypsum perlite or vermiculite plaster on 12.7 mm gypsum lath <sup>(3)</sup>	13	13	13	20	25	32	50
Gypsum perlite or vermiculite plaster on double 12.7 mm gypsum lath <sup>(3)</sup>	13	13	13	20	25	25	32
Portland cement-sand plaster on metal lath <sup>(4)(5)</sup>	25	25	25	—	—	—	—

**Notes to Table D-2.6.1.-B:**

- (1) Fire-resistance ratings of 30 min and 45 min apply to columns whose M/D ratio is 30 or greater. Fire-resistance ratings greater than 45 min apply to columns whose M/D ratio is greater than 60. Where the M/D ratio is between 30 and 60 and the required fire-resistance rating is greater than 45 min, the total thickness of protection specified in the Table shall be increased by 50%. (To determine M/D, refer to Article D-2.6.4.)
- (2) Where the thickness of plaster over gypsum lath is 25 mm or more, wire mesh with 1.57 mm diam wire and openings not exceeding 50 mm by 50 mm shall be placed midway in the plaster.
- (3) Lath held in place by 1.19 mm diam wire wrapped around lath 450 mm o.c.
- (4) Expanded metal lath 1.36 kg/m<sup>2</sup> fastened to 9.5 mm by 19 mm steel channels held in vertical position around column by 1.19 mm diam wire ties.
- (5) For mixture of Portland cement-sand plaster, see Sentence D-1.7.2.(2).

**Table D-2.6.1.-C  
Minimum Thickness of Gypsum-Sand Plaster on Metal Lath Protection to Steel Columns, mm**

M/D <sup>(1)</sup>	Fire-Resistance Rating					
	30 min	45 min	1 h	1.5 h	2 h	3 h
30 to 60	16	16	32	—	—	—
over 60 to 90	16	16	16	32	—	—
over 90 to 120	16	16	16	25	39	—
over 120 to 180	16	16	16	16	25	—
over 180	16	16	16	16	25	39

**Notes to Table D-2.6.1.-C:**

- (1) To determine the M/D ratio, refer to Article D-2.6.4.

**Table D-2.6.1.-D  
Minimum Thickness of Gypsum-Perlite or Gypsum-Vermiculite Plaster on Metal Lath Protection to Steel Columns, mm**

M/D <sup>(1)</sup>	Fire-Resistance Rating						
	30 min	45 min	1 h	1.5 h	2 h	3 h	4 h
30 to 60	16	16	20	32	35	—	—
over 60 to 90	16	16	16	20	26	35	45
over 90 to 120	16	16	16	16	26	35	45
over 120 to 180	16	16	16	16	20	32	35
over 180	16	16	16	16	16	26	35

**Table D-2.6.1.-D (Continued)**

**Notes to Table D-2.6.1.-D:**

(1) To determine the M/D ratio, refer to Article D-2.6.4.

**Table D-2.6.1.-E  
Steel Columns with Sheet-Steel Membrane and Insulation as Shown in Figures D-2.6.1.-A. and D-2.6.1.-B.**

Type of Protection	Steel Thickness, <sup>(1)</sup> mm	Fastening <sup>(2)</sup>	Insulation	Fire-Resistance Rating
See Figure D-2.6.1.-A	0.51	No. 8 sheet-metal screws 9.5 mm long, 200 mm o.c.	50 mm mineral wool batts <sup>(3)</sup>	45 min
See Figure D-2.6.1.-B	0.64	Self-threading screws or No. 8 sheet-metal screws, 600 mm o.c.	2 layers 12.7 mm gypsum board	1.5 h
See Figure D-2.6.1.-A	0.64	No. 8 sheet-metal screws, 9.5 mm long 200 mm o.c.	75 mm mineral wool batts, <sup>(3)</sup> 12.7 mm gypsum board	2 h
See Figure D-2.6.1.-B	0.76	Crimped joint or No. 8 sheet-metal screws, 300 mm o.c.	2 layers 15.9 mm gypsum board	2 h

**Notes to Table D-2.6.1.-E:**

- (1) Minimum thickness, galvanized or wiped-zinc-coated sheet-steel.
- (2) Sheet-steel shall be securely fastened to the floor and superstructure, or where sheet-steel cover does not extend floor to floor, fire stopping shall be provided at the level where sheet-steel protection ends. In the latter case, an alternate type of fire protection shall be applied between the fire stopping and the superstructure.
- (3) Conforming to CAN/ULC-S702, "Mineral Fibre Thermal Insulation for Buildings," Type 1A, minimum density 30 kg/m<sup>3</sup>: column section and batts wrapped with 25 mm mesh chicken wire.

**Table D-2.6.1.-F  
Minimum M/D Ratio for Steel Columns Covered with Type X Gypsum Board Protection<sup>(1)</sup>**

Minimum Thickness of Type X Gypsum Board Protection, <sup>(2)</sup> mm	Fire-Resistance Rating			
	1 h	1.5 h	2 h	3 h
12.7	75	—	—	—
15.9	55	—	—	—
25.4	35	60	—	—
28.6	35	50	—	—
31.8	35	40	75	—
38.1	35	35	55	—
41.3	35	35	45	—
44.5	35	35	35	—
47.6	35	35	35	—
50.8	35	35	35	75
63.5	35	35	35	45

**Notes to Table D-2.6.1.-F:**

- (1) To determine the M/D ratio, refer to Article D-2.6.4.
- (2) See Article D-2.6.5.

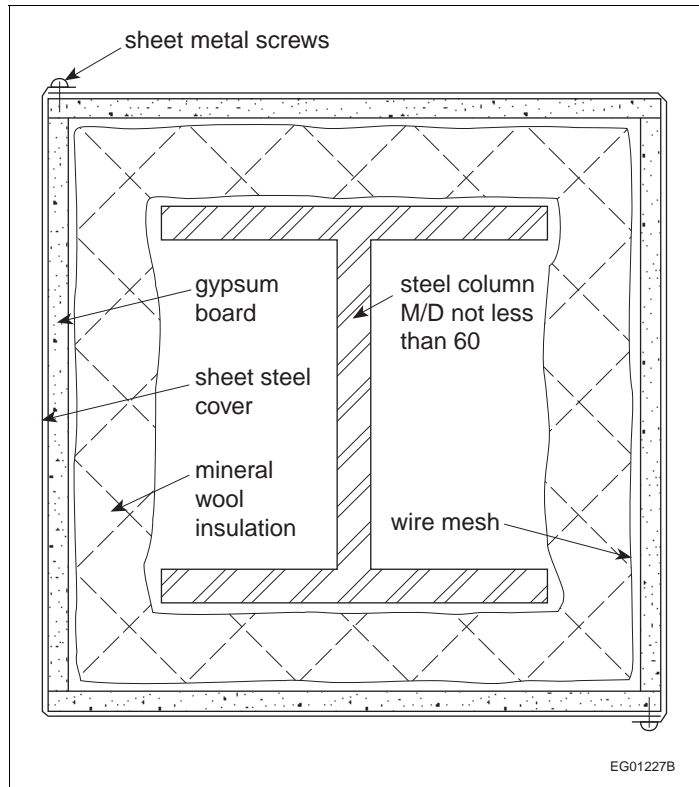


Figure D-2.6.1.-A  
Column protected by sheet-steel membrane and mineral-wool insulation

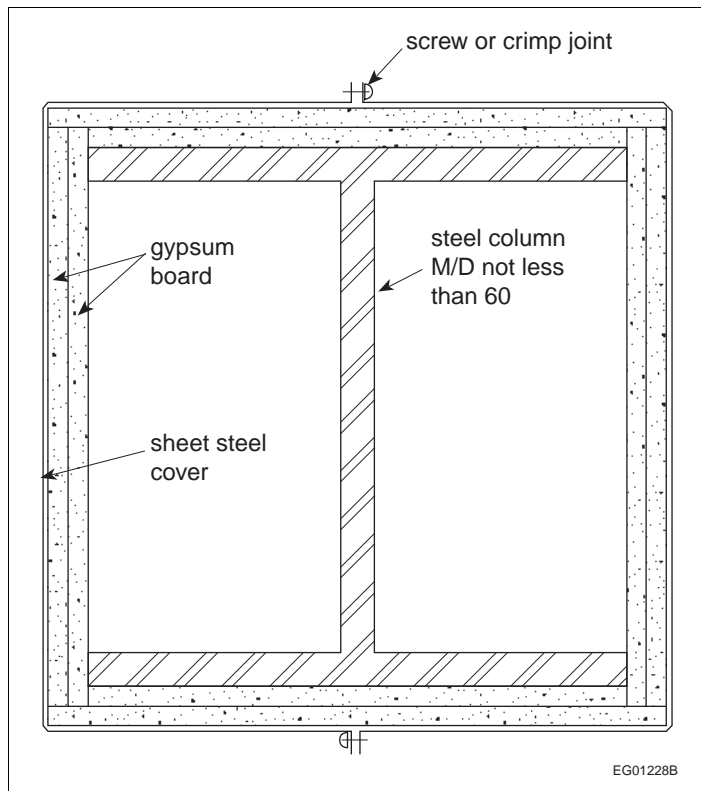


Figure D-2.6.1.-B  
Column protected by sheet-steel membrane and gypsum board

**D-2.6.2. Hollow Unit Masonry Columns**

For hollow-unit masonry column protection, the thickness shown in Tables D-2.6.1.-A to D-2.6.1.-D is the equivalent thickness as described in Subsection D-1.6.

**D-2.6.3. Effect of Plaster**

The effect on fire-resistance ratings of the addition of plaster to masonry and monolithic concrete column protection is described in Subsection D-1.7.

**D-2.6.4. Determination of M/D Ratio**

**1)** The ratio  $M/D$  to which reference is made in Tables D-2.6.1.-B, D-2.6.1.-C, D-2.6.1.-D and D-2.6.1.-F shall be found by dividing "M," the mass of the column in kilograms per metre by "D," the heated perimeter of the steel column section in metres.

**2)** The heated perimeter "D" of steel columns, shown as the dashed line in Figure D-2.6.4.-A, shall be equal to  $2(B+H)$  in Examples (1) and (2), and  $3.14B$  in Example (3). In Figure D-2.6.4.-B, the heated perimeter "D" shall be equal to  $2(B+H)$ .

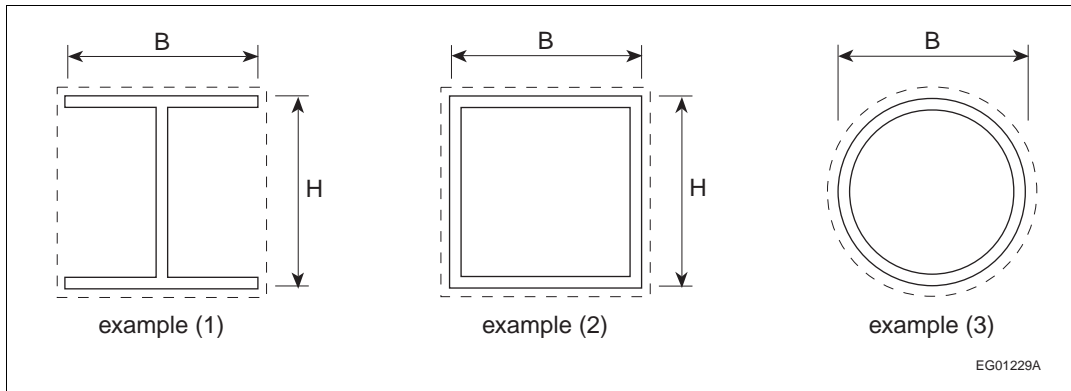
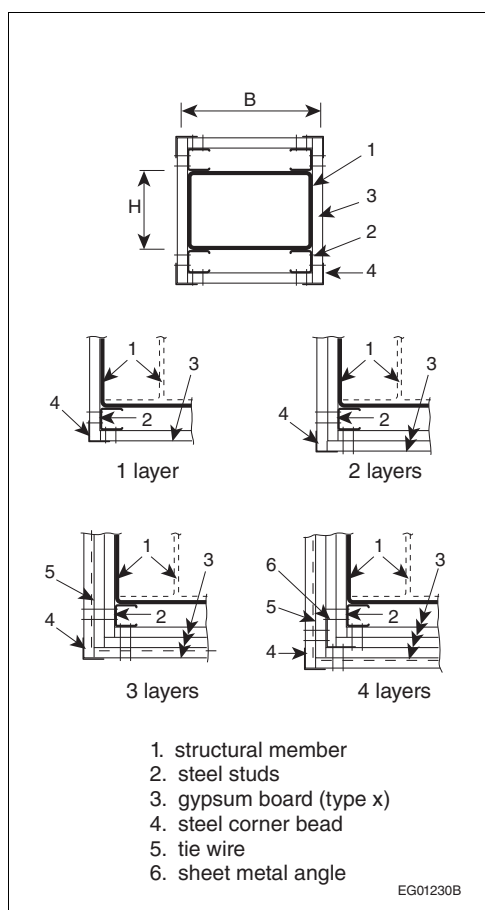


Figure D-2.6.4.-A

Example (1), standard or wide-flange beam; Example (2), hollow structural section (rectangular or square); Example (3), hollow structural section (round)



**Figure D-2.6.4.-B**  
**Columns protected by Type X gypsum board without sheet-steel membrane**

**D-2.6.5. Attachment of Gypsum Board**

**1)** Where Type X gypsum board is used to protect a steel column without an outside sheet-steel membrane, the method of gypsum board attachment to the column shall be as shown in Figure D-2.6.4.-B and shall meet the construction details described in Sentences (2) to (7).

**2)** The Type X gypsum board shall be applied vertically without horizontal joints.

**3)** The first layer of gypsum board shall be attached to steel studs with screws spaced not more than 600 mm o.c. and other layers of gypsum board shall be attached to steel studs and steel corner beads with screws spaced at a maximum of 300 mm o.c. Where a single layer of gypsum board is used, attachment screws shall be spaced not more than 300 mm o.c.

**4)** Steel tie wires spaced at a maximum of 600 mm o.c. shall be used to secure the second last layer of gypsum board in 3- and 4-layer systems.

**5)** Studs shall be fabricated of galvanized steel not less than 0.53 mm thick and not less than 41.3 mm wide, with legs not less than 33.3 mm long and shall be 12.7 mm less than the assembly height.

- 6)** Corner beads shall
- a) be fabricated of galvanized steel that is not less than 0.41 mm thick,
  - b) have legs not less than 31 mm long,
  - c) be attached to the gypsum board or stud with 25.4 mm screws spaced not more than 300 mm o.c., and
  - d) have the attaching fasteners penetrate either another corner bead in multiple layer assemblies or the steel stud member.

**7)** In a 4-layer system, metal angles shall be fabricated of galvanized steel and shall be not less than 0.46 mm thick with legs not less than 51 mm long.

**D-2.6.6. Concrete Filled Hollow Steel Columns**

**1)** A fire-resistance rating, R, is permitted to be assigned to concentrically loaded hollow steel columns that are filled with plain concrete, steel-fibre reinforced concrete or bar-reinforced concrete, that are fabricated and erected within the tolerances stipulated in CSA S16, "Design of Steel Structures," and that comply with Sentences (2) and (3), provided:

$$C \leq C_{\max}$$

where

C = axial compressive force due to dead and live loads without load factors, kN,

$$C_{\max} = \left( \frac{a(f'_c + 20)D^{2.5}}{R(KL - 1000)} \right)^2$$

but shall not exceed

- a) 1.0  $C'_r$  for plain concrete filling (PC),
- b) 1.1  $C'_r$  for steel-fibre reinforced concrete filling (FC), and
- c) 1.7  $C'_r$  for bar-reinforced concrete filling (RC),

where

$$C'_r = 0.85\phi_c f'_c A_c \lambda_c^{-2} \left[ \sqrt{1 + 0.25\lambda_c^{-4}} - 0.5\lambda_c^{-2} \right]$$

where

- a = constant obtained from Table D-2.6.6.-A,
- $f'_c$  = specified compressive strength of concrete in accordance with CSA A23.3, "Design of Concrete Structures," MPa,
- $r_c$  = radius of gyration of the concrete area,
- $A_c$  = area of concrete, mm<sup>2</sup>,
- D = outside diameter of a round column or outside width of a square column, mm,
- $E_c$  = initial elastic modulus for concrete, considering the effects of long-term loading for normal-weight concrete =  $(1 + \frac{S}{T}) 2500\sqrt{f'_c}$ , where  $f'_c$  is expressed in MPa, S is the short-term load, and T is the total load on the column,
- R = specified fire-resistance rating, min,
- KL = effective length of column as defined in CSA S16, "Design of Steel Structures," mm,
- $\lambda_c = \frac{KL}{r_c} \sqrt{\frac{f'_c}{\pi^2 E_c}}$ , and
- $\phi_c = 0.60$

subject to the validity limits stated in Table D-2.6.6.-B.

**Table D-2.6.6.-A  
Values of Constant "a"**

Filling Type	Concrete Type <sup>(1)</sup>	Steel Reinforcement	Circular Columns	Square Columns
PC	S	n/a	0.070	0.060
FC	S	≈ 2%	0.075	0.065
RC	S	1.5%-3%	0.080	0.070
RC	S	3%-5%	0.085	0.075
PC	N	n/a	0.080	0.070
FC	N	≈ 2%	0.085	0.075
RC	N	1.5%-3%	0.090	0.080
RC	N	3%-5%	0.095	0.085

**Notes to Table D-2.6.6.-A:**

<sup>(1)</sup> See Subsection D-1.4.

**2)** A pair of steam vent holes shall be provided at each end of the hollow steel column and at each intermediate floor level, and the holes shall be

- a) not less than 13 mm in diameter,
- b) located on opposite faces, 150 mm above or below a base plate, cap plate or concrete slab,
- c) orientated so that adjacent pairs are perpendicular, and

d) not obstructed by other building elements.

**3)** Load application and reaction shall be through end bearing in accordance with CSA S16, "Design of Steel Structures."

**Table D-2.6.6-B**  
**Validity Limits**

Parameter	Type of Concrete Filling		
	PC	FC	RC
$f'_c$ (MPa)	20 to 40	20 to 55	20 to 55
D (round) (mm)	140 to 410	140 to 410	165 to 410
D (square) (mm)	140 to 305	102 to 305	175 to 305
Reinforcement (%)	n/a	≈ 2% of the concrete mix by mass	1.5% to 5% of cross-sectional area <sup>(1)</sup>
Concrete Cover (mm)	n/a	n/a	≥ 25
R (min)	≤ 120	≤ 180	≤ 180
KL (mm)	2 000 to 4 000	2 000 to 4 500	2 000 to 4 500
Class <sup>(2)</sup>	1, 2 or 3	1, 2 or 3	1, 2 or 3

**Notes to Table D-2.6.6-B:**

(1) Limits on size, number and spacing of bars and ties in accordance with CSA A23.3, "Design of Concrete Structures."

(2) Classification of sections in accordance with CSA S16, "Design of Steel Structures."

**D-2.7. Individually Protected Steel Beams**

**D-2.7.1. Minimum Thickness of Protective Covering**

The minimum thickness of protective covering on steel beams exposed to fire on 3 sides for fire-resistance ratings from 30 min to 4 h is shown in Table D-2.7.1.

**Table D-2.7.1.**  
**Minimum Thickness of Cover to Individual Protected Steel Beams, mm<sup>(1)</sup>**

Description of Cover	Fire-Resistance Rating						
	30 min	45 min	1 h	1.5 h	2 h	3 h	4 h
Type S concrete <sup>(2)</sup> (beam spaces filled solid)	25	25	25	25	32	50	64
Type N or L concrete <sup>(2)</sup> (beam spaces filled solid)	25	25	25	25	25	39	50
Gypsum-sand plaster on 9.5 mm gypsum lath <sup>(3)</sup>	13	13	13	20	—	—	—
Gypsum-perlite or vermiculite plaster on 9.5 mm gypsum lath <sup>(3)</sup>	13	13	13	13	25	—	—
Gypsum-perlite or gypsum-vermiculite on 12.7 mm gypsum lath <sup>(3)</sup>	13	13	13	20	25	39	50
Gypsum-perlite or vermiculite plaster on double 12.7 mm gypsum lath <sup>(3)</sup>	13	13	13	20	25	25	39
Portland cement-sand on metal lath <sup>(4)</sup>	23	23	23	—	—	—	—
Gypsum-sand on metal lath <sup>(4)</sup> (plaster in contact with lower flange)	16	20	25	39	—	—	—
Gypsum-sand on metal lath with air gap between plaster and lower flange <sup>(4)</sup>	16	16	16	25	25	—	—
Gypsum-perlite or gypsum-vermiculite on metal lath <sup>(4)</sup>	16	16	16	23	23	35	48 <sup>(5)</sup>

**Notes to Table D-2.7.1.:**

(1) Where the thickness of plaster finish applied over gypsum lath is 26 mm or more, the plaster shall be reinforced with wire mesh with 1.57 mm diam wire and 50 mm by 50 mm openings placed midway in the plaster.

Table D-2.7.1. (Continued)

- (2) Applies to cast-in-place concrete reinforced by 5.21 mm diam wire spaced 200 mm o.c. or 1.57 mm diam wire mesh with 100 mm by 100 mm openings.
- (3) Lath held in place by 1.18 mm diam wire wrapped around the gypsum lath 450 mm o.c.
- (4) Expanded metal lath 1.63 kg/m<sup>2</sup> fastened to 9.5 mm by 19 mm steel channels held in position by 1.19 mm diam wire.
- (5) Plaster finish shall be reinforced with wire mesh with 1.57 mm diam wire and 50 mm by 50 mm openings placed midway in the plaster.

### D-2.7.2. Types of Concrete

Concrete is referred to as Type S, N or L, depending on the nature of the aggregate used. This is described in Article D-1.4.1.

### D-2.7.3. Effect of Plaster

The effect on fire-resistance ratings of the addition of plaster finish to concrete or masonry beam protection is described in Article D-1.7.1.

### D-2.7.4. Exceptions

The fire resistance of protected steel beams depends on the means used to hold the protection in place. Because of the importance of this factor, no rating has been assigned in Table D-2.7.1. to masonry units used as protective cover to steel beams. These ratings, however, may be determined on the basis of comparison with column protection at the discretion of the authority having jurisdiction, if satisfactory means of fastening are provided.

### D-2.7.5. Beam Protected by a Membrane

A steel beam or steel joist assembly that is entirely above a horizontal ceiling membrane will be protected from fire below the membrane and will resist structural collapse for a period equal to the fire-resistance rating determined in conformance with Subsection D-2.3. The support for this membrane shall be equivalent to that described in Subsection D-2.3. The rating on this basis shall not exceed 1.5 h.

## D-2.8. Reinforced Concrete Columns

### D-2.8.1. Minimum Dimensions

Minimum dimensions for reinforced concrete columns and minimum concrete cover for vertical steel reinforcement are obtained from Articles D-2.8.2. to D-2.8.5., taking into account the type of concrete, the effective length of the column and the area of the vertical reinforcement.

### D-2.8.2. Method

- 1) The minimum dimension,  $t$ , in millimetres, of a rectangular reinforced concrete column shall be equal to
- a)  $75 f (R + 1)$  for all Types L and L40S concrete,
  - b)  $80 f (R + 1)$  for Type S concrete when the design condition of the concrete column is defined in the second and fourth columns of Table D-2.8.2.,
  - c)  $80 f (R + 0.75)$  for Type N concrete when the design condition of the concrete column is defined in the second and fourth columns of Table D-2.8.2., and
  - d)  $100 f (R + 1)$  for Types S and N concrete when the design condition of the concrete column is defined in the third column of Table D-2.8.2.

where

- $f$  = the value shown in Table D-2.8.2.,
- $R$  = the required fire-resistance rating in hours,
- $k$  = the effective length factor obtained from CSA A23.3, "Design of Concrete Structures,"
- $h$  = the unsupported length of the column in metres, and
- $p$  = the area of vertical reinforcement in the column as a percentage of the column area.

- 2) The diameter of a round column shall be not less than 1.2 times the value  $t$  determined in Sentence (1) for a rectangular column.



**Table D-2.8.2.**  
**Values of Factor  $f^{(1)}$**

Overdesign Factor <sup>(2)</sup>	Values of Factor $f$ to be Used in Applying Article D-2.8.2.		
	Where $kh$ is not more than 3.7 m	Where $kh$ is more than 3.7 m but not more than 7.3 m	
		$t$ is not more than 300 mm, $p$ is not more than 3% <sup>(3)</sup>	All other cases <sup>(4)</sup>
1.00	1.0	1.2	1.0
1.25	0.9	1.1	0.9
1.50	0.83	1.0	0.83

**Notes to Table D-2.8.2.:**

- (1) For conditions that do not fall within the limits described in Table D-2.8.2., further information may be obtained from Reference (7) in Subsection D-6.1.
- (2) Overdesign factor is the ratio of the calculated load carrying capacity of the column to the column strength required to carry the specified loads determined in conformance with CSA A23.3, "Design of Concrete Structures."
- (3) Where the factor  $f$  results in a  $t$  greater than 300 mm, the appropriate factor  $f$  for "All other cases" shall be applicable.
- (4) Where  $p$  is equal to or less than 3% and the factor  $f$  results in a  $t$  less than 300 mm, the minimum thickness shall be 300 mm.

**D-2.8.3. Minimum Thickness of Concrete Cover**

**1)** Where the required fire-resistance rating of a concrete column is 3 h or less, the minimum thickness in millimetres of concrete cover over vertical steel reinforcement shall be equal to 25 times the number of hours of fire resistance required or 50 mm, whichever is less.

**2)** Where the required fire-resistance rating of a concrete column is greater than 3 h, the minimum thickness in millimetres of concrete cover over vertical steel reinforcement shall be equal to 50 plus 12.5 times the required number of hours of fire resistance in excess of 3 h.

**3)** Where the concrete cover over vertical steel required in Sentence (2) exceeds 62.5 mm, wire mesh reinforcement with 1.57 mm diameter wire and 100 mm openings shall be incorporated midway in the concrete cover to retain the concrete in position.

**D-2.8.4. Minimum Requirements**

The structural design standards may require minimum column dimensions or concrete cover over vertical steel reinforcement differing from those obtained in Sentences D-2.8.2.(1) and D-2.8.2.(2). Where a difference occurs, the greater dimension shall govern.

**D-2.8.5. Addition of Plaster**

The addition of plaster finish to the concrete column may be taken into account in determining the cover over vertical steel reinforcement by applying the multiplying factors described in Subsection D-1.7. The addition of plaster shall not, however, justify any decrease in the minimum column sizes shown.

**D-2.8.6. Built-in Columns**

The fire-resistance rating of a reinforced concrete column that is built into a masonry or concrete wall so that not more than one face may be exposed to the possibility of fire at one time may be determined on the basis of cover to vertical reinforcing steel alone. In order to meet this condition, the wall shall conform to Subsection D-2.1. for the fire-resistance rating required.

**D-2.9. Reinforced Concrete Beams**

**D-2.9.1. Minimum Cover Thickness**

The minimum thickness of cover over principal steel reinforcement in reinforced concrete beams is shown in Table D-2.9.1. for fire-resistance ratings from 30 min to 4 h where the width of the beam or joist is at least 100 mm.

**Table D-2.9.1.**  
**Minimum Cover to Principal Steel Reinforcement in Reinforced Concrete Beams, mm**

Type of Concrete	Fire-Resistance Rating						
	30 min	45 min	1 h	1.5 h	2 h	3 h	4 h
Type S, N or L	20	20	20	25	25	39	50

### D-2.9.2. Maximum Rating

No rating over 2 h may be assigned on the basis of Table D-2.9.1. to a beam or joist where the average width of the part that projects below the slab is less than 140 mm, and no rating over 3 h may be assigned where the average width of the part that projects below the slab is less than 165 mm.

### D-2.9.3. Beam Integrated in Floor or Roof Slab

For the purposes of these ratings, a beam may be either independent of or integral with a floor or roof slab assembly.

### D-2.9.4. Minimum Thickness

Where the upper extension or top flange of a joist or T-beam in a floor assembly contributes wholly or partly to the thickness of the slab above, the total thickness at any point shall be not less than the minimum thickness described in Table D-2.2.1.-A for the fire-resistance rating required.

### D-2.9.5. Effect of Plaster

The addition of plaster finish to a reinforced concrete beam may be taken into account in determining the cover over principal reinforcing steel by applying the multiplying factors described in Subsection D-1.7.

## D-2.10. Prestressed Concrete Beams

### D-2.10.1. Minimum Cross-Sectional Area and Thickness of Cover

The minimum cross-sectional area and thickness of concrete cover over steel tendons in prestressed concrete beams for fire-resistance ratings from 30 min to 4 h are shown in Table D-2.10.1.

**Table D-2.10.1.**  
**Minimum Thickness of Concrete Cover over Steel Tendons in Prestressed Concrete Beams, mm<sup>(1)</sup>**

Type of Concrete	Area of Beam, cm <sup>2</sup>	Fire-Resistance Rating						
		30 min	45 min	1 h	1.5 h	2 h	3 h	4 h
Type S or N	260 to 970	25	39	50	64	—	—	—
	Over 970 to 1 940	25	26	39	45	64	—	—
	Over 1 940	25	26	39	39	50	77	102
Type L	Over 970	25	25	25	39	50	77	102

#### Notes to Table D-2.10.1.:

<sup>(1)</sup> Where the thickness of concrete cover over the tendons exceeds 64 mm, a wire mesh reinforcement with 1.57 mm diam wire and 100 mm by 100 mm openings shall be incorporated in the beams to retain the concrete in position around the tendons. The mesh reinforcement shall be located midway in the cover.

### D-2.10.2. Minimum Cover Thickness

The cover for an individual tendon shall be the minimum thickness of concrete between the surface of the tendon and the fire-exposed surface of the beam, except that for ungrouted ducts the assumed cover thickness shall be the minimum thickness of concrete between the surface of the duct and the surface of the beam. For beams in which several tendons are used, the cover is assumed to be the average of the minimum cover

of the individual tendons. The cover for any individual tendon shall be not less than half the value given in Table D-2.10.1. nor less than 25 mm.

**D-2.10.3. Applicability of Ratings**

The ratings in Table D-2.10.1. apply to a beam that is either independent of or integral with a floor or roof slab assembly. Minimum thickness of slab and minimum cover to steel tendons in prestressed concrete slabs are contained in Subsection D-2.2.

**D-2.10.4. Effect of Plaster**

The addition of plaster finish to a prestressed concrete beam may be taken into account in determining the cover over steel tendons by applying the multiplying factors described in Subsection D-1.7.

**D-2.10.5. Minimum Cover**

**1)** Except as provided in Sentence (2), in unbonded post-tensioned prestressed concrete beams, the concrete cover to the tendon at the anchor shall be not less than 15 mm greater than the minimum required away from the anchor. The concrete cover to the anchorage bearing plate and to the end of the tendon, if it projects beyond the bearing plate, shall be not less than 25 mm.

**2)** The requirements in Sentence (1) do not apply to those portions of beams not likely to be exposed to fire (such as the ends and the tops of flanges of beams immediately below slabs).

**D-2.11. Glued-Laminated Timber Beams and Columns****D-2.11.1. Applicability of Information**

The information in Subsection D-2.11. applies to glued-laminated timber beams and columns required to have fire-resistance ratings greater than those afforded under the provisions of Article 3.1.4.6.

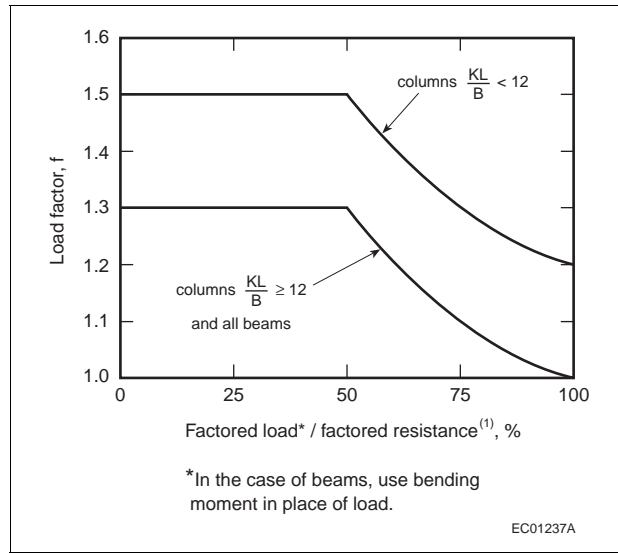
**D-2.11.2. Method of Calculation**

- 1)** The fire-resistance rating of glued-laminated timber beams and columns in minutes shall be equal to
- 0.1 fB [4 - 2(B/D)] for beams that may be exposed to fire on 4 sides,
  - 0.1 fB [4 - (B/D)] for beams that may be exposed to fire on 3 sides,
  - 0.1 fB [3 - (B/D)] for columns that may be exposed to fire on 4 sides, and
  - 0.1 fB [3 - (B/2D)] for columns that may be exposed to fire on 3 sides,

where

- f = the load factor shown in Figure D-2.11.2.-A,  
B = the full dimension of the smaller side of a beam or column in millimetres before exposure to fire [see Figure D-2.11.2.-B],  
D = the full dimension of the larger side of a beam or column in millimetres before exposure to fire [see Figure D-2.11.2.-B],  
k = the effective length factor obtained from CSA O86, "Engineering Design in Wood,"  
L = the unsupported length of a column in millimetres.

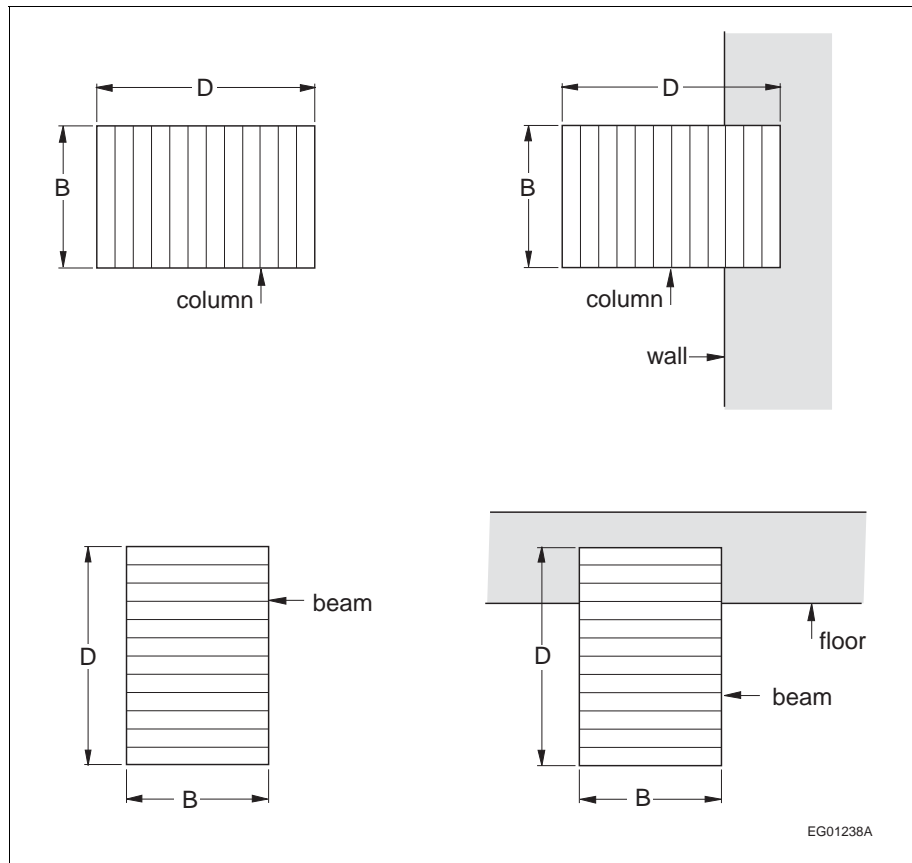
**2)** The factored resistance of a beam or column shall be determined by using the specified strengths in CSA O86, "Engineering Design in Wood."



**Figure D-2.11.2-A**  
Factors to compensate for partially loaded columns and beams

Note to Figure D-2.11.2-A:

(1) See Sentence (2).



**Figure D-2.11.2-B**  
Full dimensions of glued-laminated beams and columns

# Section D-3 Flame-Spread Ratings and Smoke Developed Classifications

## D-3.1. Interior Finish Materials

### D-3.1.1. Scope of Information

Tables D-3.1.1.-A and D-3.1.1.-B show flame-spread ratings and smoke developed classifications for combinations of some common interior finish materials. The values are based on all the evidence available at present. Many materials have not been included because of lack of test evidence or because of inability to classify or describe the material in generic terms for the purpose of assigning ratings.

**Table D-3.1.1.-A**  
**Assigned Flame-Spread Ratings and Smoke Developed Classifications for Combinations of Wall and Ceiling Finish Materials and Surface Coatings<sup>(1)</sup>**

Materials	Applicable Material Standard	Minimum Thickness, mm	Surface Coating	
			Unfinished	Paint or Varnish not more than 1.3 mm Thick, Cellulosic Wallpaper not more than One Layer <sup>(2)(3)</sup>
Brick, concrete, tile	None	None		
Steel, copper, aluminum	None	0.33	0/0	25/50
Gypsum plaster	CSA A82.22-M	None		
Gypsum board	CAN/CSA-A82.27-M ASTM C 1396/C 1396M	9.5	25/50	25/50
Lumber	None	16	150/300	150/300
Douglas Fir plywood <sup>(4)</sup>	CSA O121			
Poplar plywood <sup>(4)</sup>	CSA O153	11	150/100	150/300
Plywood with Spruce face veneer <sup>(4)</sup>	CSA O151			
Douglas Fir plywood <sup>(4)</sup>	CSA O121	6	150/100	150/100
Fibreboard low density	CAN/ULC-S706	11	X/100	150/100
Hardboard				
Type 1	CAN/CGSB-11.3-M	9	150/X	<sup>(5)</sup>
Standard		6	150/300	150/300
Particleboard	ANSI A208.1	12.7	150/300	<sup>(5)</sup>
Waferboard, OSB	CSA O437.0	—	<sup>(5)</sup>	<sup>(5)</sup>
	CSA O325	—	<sup>(5)</sup>	<sup>(5)</sup>

**Notes to Table D-3.1.1.-A:**

- (1) See Sentence D-1.1.1.(5) for standards used to assign flame-spread ratings and smoke developed classifications.
- (2) Flame-spread ratings and smoke developed classifications for paints and varnish are not applicable to shellac and lacquer.
- (3) Flame-spread ratings and smoke developed classifications for paints apply only to alkyd and latex paints.
- (4) The flame-spread ratings and smoke developed classifications shown are for those plywoods without a cellulose resin overlay.
- (5) Insufficient test information available.

**Table D-3.1.1.-B**  
**Flame-Spread Ratings and Smoke-Developed Classifications for Combinations of Common Floor Finish Materials and Surface Coatings<sup>(1)</sup>**

Materials	Applicable Standard	FSR/SDC <sup>(2)</sup>
Hardwood or softwood flooring either unfinished or finished with a spar or urethane varnish coating	None	300/300
Wool carpet (woven), pile weight not less than 1120 g/m <sup>2</sup> , applied with or without felt underlay <sup>(3)</sup>	CAN/CGSB-4.129	300/300
Nylon carpet, pile weight not less than 610 g/m <sup>2</sup> and not more than 800 g/m <sup>2</sup> , applied with or without felt underlay <sup>(3)</sup>	CAN/CGSB-4.129	300/500
Nylon carpet, pile weight not less than 610 g/m <sup>2</sup> and not more than 1355 g/m <sup>2</sup> , glued down to concrete	CAN/CGSB-4.129	300/500
Wool/nylon blend carpet (woven) with not more than 20% nylon and pile weight not less than 1120 g/m <sup>2</sup>	CAN/CGSB-4.129	300/500
Nylon/wool blend carpet (woven) with not more than 50% wool, pile weight not less than 610 g/m <sup>2</sup> and not more than 800 g/m <sup>2</sup>	CAN/CGSB-4.129	300/500
Polypropylene carpet, pile weight not less than 500 g/m <sup>2</sup> and not more than 1200 g/m <sup>2</sup> , glued down to concrete	CAN/CGSB-4.129	300/500

**Notes to Table D-3.1.1.-B:**

- (1) Tested on the floor of the tunnel in conformance with provisions of CAN/ULC-S102.2, "Test for Surface Burning Characteristics of Flooring, Floor Coverings, and Miscellaneous Materials and Assemblies."  
(2) Flame-Spread Rating/Smoke Developed Classification.  
(3) Type 1 or 2 underlay as described in CGSB 4-GP-36M, "Carpet Underlay, Fiber Type."

**D-3.1.2. Ratings**

The ratings shown in Tables D-3.1.1.-A and D-3.1.1.-B are arranged in groups corresponding to the provisions of this Code. The ratings apply to materials falling within the general categories indicated.

**D-3.1.3. Table Entries**

In Tables D-3.1.1.-A and D-3.1.1.-B, the first number of each entry relates to flame spread and the second number to smoke developed limit. For example:

25/50 represents a flame-spread rating of 0 to 25 and a smoke developed classification of 0 to 50,

150/300 represents a flame-spread rating of 75 to 150 and a smoke developed classification of 100 to 300, and

X/X applied to walls and ceilings means a flame-spread rating over 150 and a smoke developed classification over 300.

**D-3.1.4. Effect of Surface Coatings**

Thin surface coatings can modify flame-spread characteristics either upward or downward. Table D-3.1.1.-A includes a number of thin coatings that increase the flame-spread rating of the base material, so that these may be considered where more precise control over flame-spread hazard is desired.

**D-3.1.5. Proprietary Materials**

**1)** Information on flame-spread rating of proprietary materials and fire-retardant treatments that cannot be described in sufficient detail to ensure reproducibility is available through the listing and labeling services of Underwriters' Laboratories of Canada, Intertek Testing Services NA Ltd., or other recognized testing laboratory.

**2)** A summary of flame-spread test results published prior to 1965 has been prepared by NRC (see Item (1) in Subsection D-6.1.).

**D-3.1.6. Limitations and Conditions**

1) The propagation of flame along a surface in the standard test involves some finite depth of the material or materials behind the surface, and this involvement extends to the depth to which temperature variations are to be found during the course of the test; for many commonly used lining materials, such as wood, the depth involved is about 25 mm.

2) For all the combustible materials described in Table D-3.1.1.-A, a minimum dimension is shown, and this represents the thickness of the test samples on which the rating has been based; when used in greater thicknesses than that shown, these materials may have a slightly lower flame-spread rating, and thinner specimens may have higher flame-spread ratings.

3) No rating has been included for foamed plastic materials because it is not possible at this time to identify these products with sufficient accuracy on a generic basis. Materials of this type that melt when exposed to the test flame generally show an increase in flame-spread rating as the thickness of the test specimen increases.

**D-3.1.7. Referenced Standards**

In Tables D-3.1.1.-A and D-3.1.1.-B, the standards applicable to the materials described are noted because the ratings depend on conformance with these specifications.

## **Section D-4 Noncombustibility**

**D-4.1. Test Method****D-4.1.1. Determination of Noncombustibility**

1) Noncombustibility is required of certain components of buildings by the provisions of this Code, which specifies noncombustibility by reference to CAN/ULC-S114, "Test for Determination of Non-Combustibility in Building Materials."

2) The test to which reference is made in Sentence (1) is severe, and it may be assumed that any building material containing even a small proportion of combustibles will itself be classified as combustible. The specimen, 38 mm by 51 mm, is exposed to a temperature of 750°C in a small furnace. The essential criteria for noncombustibility are that the specimen does not flame or contribute to temperature rise.

**D-4.2. Materials Classified as Combustible****D-4.2.1. Combustible Materials**

Most materials from animal or vegetable sources will be classed as combustible by CAN/ULC-S114, "Test for Determination of Non-Combustibility in Building Materials," and wood, wood fibreboard, paper, felt made from animal or vegetable fibres, cork, plastics, asphalt and pitch would therefore be classed as combustible.

**D-4.2.2. Composite Materials**

Materials that consist of combustible and noncombustible elements in combination will in many cases also be classed as combustible, unless the proportion of combustibles is very small. Some mineral wool insulations with combustible binder, cinder concrete, cement and wood chips and wood-fibred gypsum plaster would also be classed as combustible.

**D-4.2.3. Effect of Chemical Additives**

The addition of a fire-retardant chemical is not sufficient to change a combustible product to a noncombustible product.

**D-4.3. Materials Classified as Noncombustible****D-4.3.1. Typical Examples**

Noncombustible materials include brick, ceramic tile, concrete made from Portland cement with noncombustible aggregate, asbestos cement, plaster made from gypsum with noncombustible aggregate, metals commonly used in buildings, glass, granite, sandstone, slate, limestone and marble.

**Section D-5 Protection of Openings in Fire-Rated Assemblies****D-5.1. Scope****D-5.1.1. Installation Information**

1) The information in this Section specifies requirements for the installation of fire doors and fire dampers in gypsum-board-protected stud wall assemblies.

**D-5.2. Installation of Fire Doors and Fire Dampers****D-5.2.1. References**

1) Fire doors and fire dampers in gypsum-board-protected steel stud non-loadbearing walls required to have a fire-resistance rating shall be installed in conformance with Section 9.24. of this Code and the applicable requirements of NFPA 80, "Fire Doors and Other Opening Protectives."

2) Fire doors and fire dampers in gypsum-board-protected wood stud walls required to have a fire-resistance rating shall be installed in conformance with Section 9.23. of this Code and the applicable requirements of NFPA 80, "Fire Doors and Other Opening Protectives."

**Section D-6 Background Information****D-6.1. Fire Test Reports**

Summaries of available fire test information have been published by NRC as follows:

- (1) M. Galbreath, Flame Spread Performance of Common Building Materials. Technical Paper No. 170, Division of Building Research, National Research Council Canada, Ottawa, April 1964. NRCC 7820.
- (2) M. Galbreath and W.W. Stanzak, Fire Endurance of Protected Steel Columns and Beams. Technical Paper No. 194, Division of Building Research, National Research Council Canada, Ottawa, April 1965. NRCC 8379.
- (3) T.Z. Harmathy and W.W. Stanzak, Elevated-Temperature Tensile and Creep Properties of Some Structural and Prestressing Steels. American Society for Testing and Materials, Special Technical Publication 464, 1970, p. 186 (DBR Research Paper No. 424) NRCC 11163.
- (4) T.Z. Harmathy, Thermal Performance of Concrete Masonry Walls in Fire. American Society for Testing and Materials, Special Technical Publication 464, 1970, p. 209 (DBR Research Paper No. 423) NRCC 11161.
- (5) L.W. Allen, Fire Endurance of Selected Non-Loadbearing Concrete Masonry Walls. DBR Fire Study No. 25, Division of Building Research, National Research Council Canada, Ottawa, March 1970. NRCC 11275.
- (6) A. Rose, Comparison of Flame Spread Ratings by Radiant Panel, Tunnel Furnace, and Pittsburgh-Corning Apparatus. DBR Fire Study No. 22, Division of Building Research, National Research Council Canada, Ottawa, June 1969. NRCC 10788.
- (7) T.T. Lie and D.E. Allen, Calculation of the Fire Resistance of Reinforced Concrete Columns. DBR Technical Paper No. 378, Division of Building Research, National Research Council Canada, Ottawa, August 1972. NRCC 12797.
- (8) W.W. Stanzak, Column Covers: A Practical Application of Sheet Steel as a Protective Membrane. DBR Fire Study No. 27, Division of Building Research, National Research Council Canada, Ottawa, February 1972. NRCC 12483.
- (9) W.W. Stanzak, Sheet Steel as a Protective Membrane for Steel Beams and Columns. DBR Fire Study No. 23, Division of Building Research, National Research Council Canada, Ottawa, November 1969. NRCC 10865.



- (10) W.W. Stanzak and T.T. Lie, Fire Tests on Protected Steel Columns with Different Cross-Sections. DBR Fire Study No. 30, Division of Building Research, National Research Council Canada, Ottawa, February 1973. NRCC 13072.
- (11) G. Williams-Leir and L.W. Allen, Prediction of Fire Endurance of Concrete Masonry Walls. DBR Technical Paper No. 399, Division of Building Research, National Research Council Canada, Ottawa, November 1973. NRCC 13560.
- (12) G. Williams-Leir, Prediction of Fire Endurance of Concrete Slabs. DBR Technical Paper No. 398, Division of Building Research, National Research Council Canada, Ottawa, November 1973. NRCC 13559.
- (13) A. Rose, Flammability of Fibreboard Interior Finish Materials. Building Research Note No. 68, Division of Building Research, National Research Council Canada, Ottawa, October 1969.
- (14) L.W. Allen, Effect of Sand Replacement on the Fire Endurance of Lightweight Aggregate Masonry Units. DBR Fire Study No. 26, Division of Building Research, National Research Council Canada, Ottawa, September 1971. NRCC 12112.
- (15) L.W. Allen, W.W. Stanzak and M. Galbreath, Fire Endurance Tests on Unit Masonry Walls with Gypsum Wallboard. DBR Fire Study No. 32, Division of Building Research, National Research Council Canada, Ottawa, February 1974, NRCC 13901.
- (16) W.W. Stanzak and T.T. Lie, Fire Resistance of Unprotected Steel Columns. Journal of Structural Division, Proc., Am. Soc. Civ. Eng., Vol. 99, No. ST5 Proc. Paper 9719, May 1973 (DBR Research Paper No. 577) NRCC 13589.
- (17) T.T. Lie and T.Z. Harmathy, Fire Endurance of Concrete-Protected Steel Columns. A.C.I. Journal, January 1974, Title No. 71-4 (DBR Technical Paper No. 597) NRCC 13876.
- (18) T.T. Lie, A Method for Assessing the Fire Resistance of Laminated Timber Beams and Columns. Can. J. Civ. Eng., Vol. 4, No. 2, June 1977 (DBR Technical Paper No. 718) NRCC 15946.
- (19) T.T. Lie, Calculation of the Fire Resistance of Composite Concrete Floor and Roof Slabs. Fire Technology, Vol. 14, No. 1, February 1978 (DBR Technical Paper No. 772) NRCC 16658.
- (20) M.A. Sultan, Y.P. Séguin and P. Leroux. Results of Fire Resistance Tests on Full-Scale Floor Assemblies, Institute for Research in Construction, National Research Council Canada, Ottawa, May 1998, IRC-IR-764.
- (21) M.A. Sultan, J.C. Latour, P. Leroux, R.C. Monette, Y.P. Séguin and J.P. Henrie, Results of Fire Resistance Tests on Full-Scale Floor Assemblies - Phase II, Institute for Research in Construction, National Research Council Canada, Ottawa, March 2005, RR-184.
- (22) M.A. Sultan and G.D. Lougheed, Results of Fire Resistance Tests on Full-Scale Gypsum Board Wall Assemblies, Institute for Research in Construction, National Research Council Canada, Ottawa, August 2002, IRC-IR-833.
- (23) V.K.R. Kodur, M.A. Sultan, J.C. Latour, P. Leroux, R.C. Monette, Experimental Studies on the Fire Resistance of Load-Bearing Steel Stud Walls, Research Report, National Research Council Canada, Ottawa, August 2013, RR-343.

### D-6.2. Obsolete Materials and Assemblies

Building materials, components and structural members and assemblies in buildings constructed before 1995 may have been assigned ratings based on earlier editions of the Supplement to the National Building Code of Canada or older reports of fire tests. To assist users in determining the ratings of these obsolete assemblies and structural members, the following list of reference documents has been prepared. Although some of these publications are out of print, reference copies are available through NRC.

- (1) M. Galbreath, Fire Endurance of Unit Masonry Walls. Technical Paper No. 207, Division of Building Research, National Research Council Canada, Ottawa, October 1965. NRCC 8740.
- (2) M. Galbreath, Fire Endurance of Light Framed and Miscellaneous Assemblies. Technical Paper No. 222, Division of Building Research, National Research Council Canada, Ottawa, June 1966. NRCC 9085.
- (3) M. Galbreath, Fire Endurance of Concrete Assemblies. Technical Paper No. 235, Division of Building Research, National Research Council Canada, Ottawa, November 1966. NRCC 9279.
- (4) Guideline on Fire Ratings of Archaic Materials and Assemblies. Rehabilitation Guideline #8, U.S. Department of Housing and Urban Development, Germantown, Maryland 20767, October 1980.
- (5) T.Z. Harmathy, Fire Test of a Plank Wall Construction. Fire Study No. 2, Division of Building Research, National Research Council Canada, Ottawa, July 1960. NRCC 5760.
- (6) T.Z. Harmathy, Fire Test of a Wood Partition. Fire Study No. 3, Division of Building Research, National Research Council Canada, Ottawa, October 1960. NRCC 5769.

### D-6.3. Assessment of Archaic Assemblies

Information in this document applies to new construction. Please refer to early editions of the Supplement to the National Building Code of Canada for the assessment or evaluation of assemblies that do not conform to

the information in this edition of the National Building Code. As with other documents, this Code is revised according to the information presented to the standing committee responsible for its content, and with each update new material may be added and material that is not relevant may be deleted.

### **D-6.4. Development of the Component Additive Method**

The component additive method was developed based upon the following observations and conclusions drawn from published as well as unpublished test information.

Study of the test data showed that structural failure preceded failure by other criteria (transmission of heat or hot gases) in most of the tests of loadbearing wood-framed assemblies. The major contributor to fire resistance was the membrane on the fire-exposed side.

Fire tests of wood joist floors without protective ceilings resulted in structural failure between 8 and 10 min. Calculation of the time for wood joists to approach breaking stress, based upon the charring rate of natural woods, suggested a time of 10 min for structural failure. This time was subtracted from the fire-resistance test results of wood joist floors and the remainder considered to be the contribution of the membrane.

The figures obtained for the contribution of membranes were then applied to the test results for open web steel joist floors and wood and steel stud walls and values of 20 min for the contribution of wood stud framing and 10 min for steel framing were derived.

The fire-resistance rating has been limited to 1.5 h as this method of developing ratings for framed assemblies was new and untried. Although this is the subject of current review, no decision has been made to extend the ratings beyond 1.5 h.

- (1) M. Galbreath, G. C. Gosselin, and R. B. Chauhan, Historical Guide to Chapter 2 of the Supplement to the National Building Code of Canada, Committee Paper FPR 1-3, Prepared for the Standing Committee on Fire Performance Ratings, May 1987.

Example showing fire-resistance rating of a typical membrane assembly, calculated using the component additive method.

#### **1 hour Gypsum Board/Wood Stud Interior Partition**

A 1 h fire-resistance rating is required for an interior wood framed partition, using 12.7 mm Type X gypsum board.

- (a) Since gypsum board is used (Sentence D-2.3.4.(2) and Table D-2.3.4.-A) time assigned to 12.7 mm Type X gypsum board membrane on the fire-exposed side of the partition = 25 min
  - (b) Time assigned to wood framing members at 400 mm o.c. (Sentence D-2.3.4.(3) and Table D-2.3.4.-E) = 20 min
  - (c) Time assigned to insulation, if the spaces between the studs are filled with preformed insulation of rock or slag fibres conforming to CAN/ULC-S702, "Mineral Fibre Thermal Insulation for Buildings," (Sentence D-2.3.4.(4) and Table D-2.3.4.-G) = 15 min
  - (d) Time assigned to the membrane on the non-fire-exposed side (Sentence D-2.3.5.(1)) = 0 min
- Fire-resistance rating = 25 + 20 + 15 = 60 min



# **Division C**

## **Administrative Provisions**



# **Part 1**

## **General**

<b>1.1.</b>	<b>Application</b>	
1.1.1.	Application .....	1-1
<b>1.2.</b>	<b>Terms and Abbreviations</b>	
1.2.1.	Definitions of Words and Phrases ..	1-1
1.2.2.	Symbols and Other Abbreviations ..	1-1



# **Part 1 General**

## **Section 1.1. Application**

### **1.1.1. Application**

#### **1.1.1.1. Application**

**1)** This Part applies to all *buildings* covered in this Code. (See Article 1.1.1.1. of Division A.)

## **Section 1.2. Terms and Abbreviations**

### **1.2.1. Definitions of Words and Phrases**

#### **1.2.1.1. Non-defined Terms**

**1)** Words and phrases used in Division C that are not included in the list of definitions in Article 1.4.1.2. of Division A shall have the meanings that are commonly assigned to them in the context in which they are used, taking into account the specialized use of terms by the various trades and professions to which the terminology applies.

**2)** Where objectives and functional statements are referred to in Division C, they shall be the objectives and functional statements described in Parts 2 and 3 of .

**3)** Where acceptable solutions are referred to in Division C, they shall be the provisions stated in Parts 3 to 9 of Division B.

**4)** Where alternative solutions are referred to in Division C, they shall be the alternative solutions mentioned in Clause 1.2.1.1.(1)(b) of Division A.

#### **1.2.1.2. Defined Terms**

**1)** The words and terms in italics in Division C shall have the meanings assigned to them in Article 1.4.1.2. of Division A.

### **1.2.2. Symbols and Other Abbreviations**

#### **1.2.2.1. Symbols and Other Abbreviations**

**1)** The symbols and other abbreviations in Division C shall have the meanings assigned to them in Article 1.4.2.1. of Division A.





# **Part 2**

## **Administrative Provisions**

<b>2.1.</b>	<b>Application</b>	
2.1.1.	Application .....	2-1
<b>2.2.</b>	<b>Administration</b>	
2.2.1.	Administration .....	2-1
2.2.2.	Information Required for Proposed Work .....	2-1
2.2.3.	Fire Protection Components .....	2-2
2.2.4.	Structural and Foundation Drawings and Calculations .....	2-2
2.2.5.	Drawings and Specifications for Environmental Separators and Other Assemblies Exposed to the Exterior .....	2-3
2.2.6.	Heating, Ventilating and Air-conditioning Drawings and Specifications .....	2-3
2.2.7.	Review of Work .....	2-3
2.2.8.	Drawings, Specifications and Calculations for Energy Performance Compliance .....	2-4
<b>2.3.</b>	<b>Alternative Solutions</b>	
2.3.1.	Documentation of Alternative Solutions .....	2-5
	<b>Notes to Part 2 .....</b>	<b>2-7</b>



# Part 2

## Administrative Provisions

### Section 2.1. Application

#### 2.1.1. Application

##### 2.1.1.1. Application

1) This Part applies to all *buildings* covered in this Code. (See Article 1.1.1.1. of Division A.)

### Section 2.2. Administration

#### 2.2.1. Administration

##### 2.2.1.1. Conformance with Administrative Requirements

1) This Code shall be administered in conformance with the appropriate provincial or territorial regulations, municipal bylaws or, in the absence of such regulations or bylaws, in conformance with the Administrative Requirements for Use with the National Building Code of Canada 1985.

##### 2.2.1.2. Structural Design

1) For design carried out in accordance with Part 4 of Division B, the *designer* shall be a professional engineer or architect skilled in the work concerned. (See Note A-2.2.1.2.(1).)

#### 2.2.2. Information Required for Proposed Work

##### 2.2.2.1. General Information Required

1) Sufficient information shall be provided to show that the proposed work will conform to this Code and whether or not it may affect adjacent property.

2) Plans shall be drawn to scale and shall indicate the nature and extent of the work or proposed *occupancy* in sufficient detail to establish that, when completed, the work and the proposed *occupancy* will conform to this Code.

3) When proposed work is changed during construction, information on the changes shall comply with the requirements of this Section for proposed work.

##### 2.2.2.2. Site Plans

1) Site plans shall be referenced to an up-to-date survey and, when required to prove compliance with this Code, a copy of the survey shall be provided.

2) Site plans shall show

- a) by dimensions from property lines, the location of the proposed *building*,
- b) the similarly dimensioned location of every adjacent existing *building* on the property,
- c) existing and finished ground levels to an established datum at or adjacent to the site, and
- d) the access routes for firefighting.

**2.2.3.1.****2.2.3. Fire Protection Components****2.2.3.1. Information Required for Fire Protection Components**

- 1) Information shall be submitted to show the major components of fire protection including
- the division of the *building* by *firewalls*,
  - the *building area*,
  - the degree of *fire separation* of *storeys*, shafts and special rooms or areas, including the location and rating of *closures* in *fire separations*,
  - the source of information for *fire-resistance ratings* of elements of construction (to be indicated on large-scale sections),
  - the location of *exits*, and
  - fire detection, suppression and alarm systems.

**2.2.3.2. Plans of Sprinkler Systems**

- 1) Before a sprinkler system is installed or altered, plans showing full details of the proposed sprinkler system and essential details of the *building* in which it is to be installed shall be drawn to an indicated scale.

**2.2.4. Structural and Foundation Drawings and Calculations****2.2.4.1. Application**

- 1) This Subsection applies only to *buildings* covered in Part 4 of Division B. (See Article 1.3.3.2. of Division A.)

**2.2.4.2. Professional Seal and Signature of Designer**

- 1) Structural drawings and related documents submitted with the application to build shall be dated and shall bear the authorized professional seal and signature of the *designer* as defined in Sentence 2.2.1.2.(1).

**2.2.4.3. Information Required on Structural Drawings**

- 1) Structural drawings and related documents submitted with the application to build shall indicate, in addition to those items specified in Article 2.2.4.6. and in Part 4 of Division B applicable to the specific material,
- the name and address of the person responsible for the structural design,
  - the date of issue of the Code and standards to which the design conforms,
  - the dimensions, location and size of all structural members in sufficient detail to enable the design to be checked,
  - sufficient detail to enable the *dead loads* to be determined, and
  - all effects and loads, other than *dead loads*, used for the design of the structural members and exterior cladding.

**2.2.4.4. Drawings of Parts or Components**

- 1) Structural drawings of parts or components including *guards* designed by a person other than the *designer* of the *building* shall be dated and shall bear the authorized professional seal and signature of the *designer* of such parts or components.

**2.2.4.5. Design Calculations and Analysis**

- 1) The calculations and analysis made in the design of the structural members, including parts and components, of a *building* shall be available for inspection upon request.

**2.2.4.6. Information Required on Foundation Drawings**

- 1) *Foundation* drawings submitted with the application to build or excavate shall be provided to indicate
- the type and condition of the *soil* or *rock*, as well as the *groundwater* conditions, as determined by the *subsurface investigation*,

- b) the factored bearing pressures on the *soil* or *rock*, the factored loads when applicable and the design loads applied to *foundation units*, and
- c) the earth pressures and other loads applied to the supporting structures of supported *excavations*.

2) When required, evidence that justifies the information on the drawings shall be submitted with the application to excavate or build.

#### 2.2.4.7. Altered Conditions

1) Where conditions as described under Sentences 4.2.2.4.(1) and (2) of Division B are encountered, or where *foundation units* or their locations are altered, this information shall be recorded on appropriate drawings or new “as constructed” drawings.

### 2.2.5. Drawings and Specifications for Environmental Separators and Other Assemblies Exposed to the Exterior

#### 2.2.5.1. Application

1) This Subsection applies to *building* materials, components and assemblies to which Part 5 of Division B applies. (See Article 1.3.3.2. of Division A.)

#### 2.2.5.2. Information Required on Drawings and Specifications

1) Information shown on drawings and in specifications shall be clear and legible, and shall contain sufficient details to demonstrate conformance with this Code. (See Note A-2.2.6.2.(1).)

### 2.2.6. Heating, Ventilating and Air-conditioning Drawings and Specifications

#### 2.2.6.1. Application

1) This Subsection applies only to *buildings* covered in Part 6 of Division B. (See Article 1.3.3.2. of Division A.)

#### 2.2.6.2. Information Required on Drawings

1) The information shown on architectural drawings and on drawings for heating, ventilating and air-conditioning systems shall be clear and legible and shall contain all necessary details to demonstrate conformance with this Code. (See Note A-2.2.6.2.(1).)

### 2.2.7. Review of Work

#### 2.2.7.1. Application

1) This Subsection applies only to *buildings* covered in Part 4 of Division B (see Article 1.3.3.2. of Division A), except that Article 2.2.7.5. applies to all *buildings* covered in this Code. (See Article 1.1.1.1. of Division A.)

#### 2.2.7.2. Review of Construction

1) The *designer* or another suitably qualified person shall review the construction of any *building* or part thereof to determine conformance with the design.

#### 2.2.7.3. Review of Shop Drawings

1) The *designer* or another suitably qualified person shall review all shop drawings and other related documents relevant to the design to determine conformance with the design.

#### 2.2.7.4. Review of Workmanship and Materials

1) Workmanship, materials and all reports of material tests shall be reviewed by the *designer* or another suitably qualified person during the process of construction.

**2.2.7.5. Off-Site Review**

1) Where a *building* or component of a *building* is assembled off the *building* site in such a manner that it cannot be reviewed on site, off-site reviews shall be provided to determine compliance with this Code.

**2.2.8. Drawings, Specifications and Calculations for Energy Performance Compliance****2.2.8.1. Application**

1) This Subsection applies only to houses with or without a *secondary suite* and to *buildings* containing only *dwelling units* and common spaces whose total *floor area* does not exceed 20% of the total *floor area* of the *building* that are modeled in accordance with Subsection 9.36.5. of Division B to demonstrate compliance with the energy efficiency objectives of Subsections 9.36.2. to 9.36.4. of Division B. (See Note A-2.2.8.1.(1).) (See also Sentence 9.36.1.2.(1) of Division B and Note A-9.36.1.3.(3) of Division B.)

**2.2.8.2. Information Required on Drawings and Specifications**

1) Except as provided in Sentences (2), (3) and (4), the drawings and specifications for the proposed house shall include

- a) the effective thermal resistance values and respective areas of all opaque *building* envelope assemblies, including all above-ground and below-ground roof/ceiling, wall, and floor assemblies,
- b) the overall thermal transmittance (U-value), solar heat gain coefficient and respective areas of all fenestration and door components,
- c) the ratio of total vertical fenestration and door area to gross wall area,
- d) the performance rating, energy source, and types of all equipment required for space-heating and -cooling and service water heating,
- e) the design basis for the ventilation rates,
- f) where a test is used to determine the airtightness of a house, the measured airtightness of the *building* envelope in air changes per hour, and
- g) any additional features used in the energy model calculations that account for a significant difference in house energy performance.

2) The effective thermal resistance values and respective areas of opaque *building* envelope assemblies that cover less than 2% of the total area of their respective assembly type need not be provided in the drawings and specifications required in Sentence (1).

3) Where part-load characteristics are used in the modeling of the HVAC equipment, they need not be provided in the drawings and specifications required in Sentence (1).

4) The features of the proposed house that differ from those of the reference house shall be detailed in the specifications required in Sentence (1).

**2.2.8.3. House Performance Compliance Calculation Report**

1) A house performance compliance calculation report shall be provided in accordance with Sentence (2) for each proposed house design.

2) In addition to the drawings and specifications required in Article 2.2.8.2., the house performance compliance calculation report shall include

- a) a project information section containing
  - i) the name or identifier of the project,
  - ii) a description of the project,
  - iii) the address of the project,
  - iv) the name and version of the calculation tool,
  - v) the geographic region in which the proposed house is to be built, and
  - vi) the identifier for the climatic data set used for analysis,
- b) a summary of the characteristics of the *building* envelope, HVAC system and service water heating system reflecting the information provided in Article 2.2.8.2.,

- c) an energy performance data summary containing
  - i) the annual energy consumption of all energy sources calculated for the proposed house (see Note A-2.2.8.3.(2)(c)(i)), and
  - ii) the house energy target of all energy sources calculated for the reference house,
- d) where a software program is used to determine compliance,
  - i) the name of the software program(s), and
  - ii) a list of any adaptations made by the user to the software relating to input or output values, and
- e) a statement that the calculation was performed in compliance with Subsection 9.36.5. of Division B.

## Section 2.3. Alternative Solutions

### 2.3.1. Documentation of Alternative Solutions

(See Note A-2.3.1.)

#### 2.3.1.1. Documentation

**1)** Documentation conforming to this Subsection shall be provided by the person requesting the use of an alternative solution to demonstrate that the proposed alternative solution complies with this Code.

**2)** The documentation referred to in Sentence (1) shall include

- a) a Code analysis outlining the analytical methods and rationales used to determine that a proposed alternative solution will achieve at least the level of performance required by Clause 1.2.1.1.(1)(b) of Division A, and
- b) information concerning any special maintenance or operational requirements, including any *building* component commissioning requirements, that are necessary for the alternative solution to achieve compliance with the Code after the *building* is constructed.

**3)** The Code analysis referred to in Clause (2)(a) shall identify the applicable objectives, functional statements and acceptable solutions, and any assumptions, limiting or restricting factors, testing procedures, engineering studies or *building* performance parameters that will support a Code compliance assessment.

**4)** The Code analysis referred to in Clause (2)(a) shall include information about the qualifications, experience and background of the person or persons taking responsibility for the design.

**5)** The information provided under Sentence (3) shall be in sufficient detail to convey the design intent and to support the validity, accuracy, relevance and precision of the Code analysis.

**6)** Where the design of a *building* includes proposed alternative solutions that involve more than one person taking responsibility for different aspects of the design, the applicant for the permit shall identify a single person to co-ordinate the preparation of the design, Code analysis and documentation referred to in this Subsection.





# Notes to Part 2

## Administrative Provisions

**A-2.2.1.2.(1) Structural Design.** Part 4 of Division B is written on the assumption that structural design will be carried out by a professional who is qualified to perform such design. Sentence 2.2.1.2.(1) is not intended to imply that a professional may not also be required in the application of requirements in other Parts of the NBC.

**A-2.2.6.2.(1) Information Required on Drawings and Specifications.** Examples of information that should be shown on architectural drawings and drawings for heating, ventilating and air-conditioning systems are:

- (a) the name, type and location of the building,
- (b) the name of the owner,
- (c) the name of the architect,
- (d) the name of the engineer or designer,
- (e) the north point,
- (f) the dimensions and height of all rooms,
- (g) the intended use of all rooms,
- (h) the details or description of the wall, roof, ceiling and floor construction, including insulation,
- (i) the details or description of the windows and outside doors, including the size, weatherstripping, storm sashes, sills and storm doors,
- (j) the size and continuity of all pipes, ducts, shafts, flues and fire dampers,
- (k) the location, size, capacity and type of all principal units of equipment,
- (l) the size, shape and height of all chimneys and gas vents,
- (m) the size and location of all combustion air and ventilation openings, and
- (n) the location and fire-resistance rating of required fire separations.

**A-2.2.8.1.(1) Use of Terms “Building” and “House”.** Although the word “house” is used in the terms “proposed house,” “reference house” and “house performance compliance calculation report” in Subsection 2.2.8., it is intended to include other types of residential buildings also addressed by Subsection 9.36.5. of Division B. The terms “proposed building,” “reference building” and “building performance compliance calculation report” used in the NECB apply to other types of buildings.

**A-2.2.8.3.(2)(c)(i) Annual Energy Consumption.** The performance compliance calculation method detailed in Subsection 9.36.5. of Division B uses a number of assumptions regarding environmental values and operating conditions in order to standardize the calculations and neutralize the impact of occupant behaviour or to exclude issues that are not addressed in the requirements. Note that the result of the energy model calculations is not a prediction of the actual energy consumption of the proposed house.

**A-2.3.1. Documentation of Alternative Solutions.** Beyond the purposes of demonstrating compliance and acquiring a building permit, there are other important reasons for requiring that the proponent of an alternative solution submit project documentation (i.e. a compliance report) to the authority having jurisdiction and for the authority having jurisdiction to retain that documentation for a substantial period following the construction of a building:

- Most jurisdictions require that a building be maintained in compliance with the codes under which it was built. Alternative solutions made possible by objective-based codes may have special maintenance requirements, which would be described in the documentation.

---

These Notes are included for explanatory purposes only and do not form part of the requirements. The number that introduces each Note corresponds to the applicable requirement in this Part.

- Documentation helps consultants perform code compliance assessments of existing buildings before they are sold and informs current owners or prospective buyers of existing buildings of any limitations pertaining to their future use or development.
- Documentation provides design professionals with the basic information necessary to design changes to an existing building.
- An alternative solution could be invalidated by a proposed alteration to a building. Designers and regulators must therefore know the details of the particular alternative solutions that were integral to the original design. Complete documentation should provide insight as to why one alternative solution was chosen over another.
- Documentation is the “paper trail” of the alternative solution negotiated between the designer and the regulator and should demonstrate that a rational process led to the acceptance of the alternative solution as an equivalency.
- It is possible that over time a particular alternative solution may be shown to be inadequate. It would be advantageous for a jurisdiction to know which buildings included that alternative solution as part of their design: documentation will facilitate this type of analysis.
- Project documentation provides important information to a forensic team that is called to investigate an accident or why a design failed to provide the level of performance expected.

This subject is discussed in further detail in “Recommended Documentation Requirements for Projects Using Alternative Solutions in the Context of Objective-Based Codes,” which was prepared for the CCBFC Task Group on Implementation of Objective-Based Codes and is available on NRC’s Web site.

# Index

## A

### Abbreviations

- acronyms, 1.3.2.1.
- symbols and, 1.2.2.1.
- terms and, 1.4.1.2.[A]

### Acceptable solutions, 1.1.2.1., 1.2.1.1.[A]

### Access

- attics or roof spaces, 3.6.4.4., 9.19.2.1.
- chimneys, 6.3.3.4.
- crawl spaces, 3.6.4.6., 9.18.2.1., 9.18.4.1.
- fire dampers, 3.1.8.10.
- hatchways to roof, 9.19.2.1.
- horizontal service spaces, 3.6.4.5., 9.18.2.1., 9.18.4.1., 9.19.2.1.
- HVAC equipment, 6.2.1.6., 9.33.4.4.
- smoke dampers, 3.1.8.11.

### Access to exits

- capacity, 3.3.1.17., 9.9.3.
- corridors in assembly occupancy, 3.3.2.6.
- corridor width, 3.3.1.9.
- dead-end corridors, 9.9.7.3.
- definition, 1.4.1.2.[A]
- dimensions, 9.9.3.
- doors, 3.3.1.13., 3.3.2.7., 9.9.6., 9.9.7.4.
- doors, sliding, 3.3.1.12.
- doors, transparent, 3.3.1.19.
- dwelling units, 9.9.9.
- flame-spread rating, 9.10.21.6.
- within floor areas, 3.3.1.3.
- headroom clearance, 3.3.1.8., 9.9.3.4.
- independent access to, 9.9.7.5.
- lighting, 9.9.12.2.
- podiums, terraces, platforms and contained open spaces, 9.9.7.1.
- residential occupancy, 3.3.4.4.
- roofs, 3.3.1.3., 9.9.7.1.
- service rooms, 9.9.7.5.
- suites, 9.9.7.2.
- transparent panels, 3.3.1.19.
- travel distance, 9.9.7.6.
- when exits are means of egress, 9.9.7.
- width, 9.9.3.2., 9.9.3.3.

### Access for firefighting

- access routes, 3.2.5.4., 3.2.5.5., 3.2.5.6.
- basements, 3.2.5.2., 9.10.20.2.
- and building size determination, 1.3.3.4.[A]

- provisions, 9.10.20.
- roof area, 3.2.5.3.
- storeys below ground, 3.2.2.15.
- storeys above grade, 3.2.5.1.
- street frontages, 3.2.2.10.

### Accessibility (see Barrier-free)

### Access openings

- construction barricades, 8.2.1.3.
- HVAC systems, 6.8.1.1.

### Access panels, 3.2.5.1., 9.10.20.1.

### Access routes

- design, 3.2.5.6.
- location, 3.2.5.5., 9.10.20.3.
- need for, 3.2.5.4.
- self-service storage buildings, 3.9.2.3.
- as streets, 3.2.2.10.

### Adfreezing, 1.4.1.2.[A], 4.2.4.4.

### Adhesives

- ceramic wall tiles, 9.29.10.3.
- ducts, 3.6.5.4., 9.33.6.4.

### Administration of the Code, 2.2.[C]

### Admixtures

- concrete, 9.3.1.8.
- mortar and grout, 9.20.3.2.

### Aggregate

- for built-up-roofing, 9.26.11.1., 9.26.11.4.
- for concrete, 9.3.1.1., 9.3.1.4., 9.3.1.7.
- for mortar, 5.9.1.1., 9.20.3.1., 9.20.3.2., 9.29.10.2.
- for stucco, 9.28.2.2., 9.28.5.1.

### Air

- circulation, 6.3.2.7., 9.33.6.7.
- distribution, 9.33.6.11.
- flow through and around insulation, 5.3.1.3., 9.19.1.3., 9.25.2.3., 9.25.2.4.
- leakage, 3.1.8.4., 5.1.1.1., 5.4.1.1., 5.9.3.4., 5.9.4.1., 9.25.5.1.
- leakage resistance, 5.4.1.1., 5.4.1.2., 9.13.4., 9.18.6.2., 9.25.5.1.
- makeup, 6.3.2.8., 9.32.3.8.
- permeance, 5.4.1.2., 9.25.5.1.
- tempering, 9.32.3.4., 9.32.3.8.
- transfer, 5.1.1.1., 5.2.1.3.

### Air barrier systems

- airtightness, 5.4.1.1., 9.36.2.9., 9.36.2.10.
- assemblies in contact with the ground, 9.13.4., 9.25.3.6.
- continuity, 5.4.1.2., 9.25.3.3., 9.36.2.9.
- crawl space floors, 9.18.6.2.

[A] – Reference occurs in Division A. [C] – Reference occurs in Division C. All other references occur in Division B.

- definition, 1.4.1.2.[A]
- deflections, 5.2.2.1.
- energy efficiency, 9.36.2.9.
- environmental loads, 5.1.4.1.
- environmental separation, 5.1.1.1.
- floors-on-ground, 9.18.6.2., 9.25.3.6.
- housing and small buildings, 9.25.3.
- installation, 9.23.2.2., 9.25.3.3.
- material standards, 5.9.1.1., 9.18.6.2., 9.25.3.2., 9.25.3.6.
- properties, 9.25.3.1., 9.25.5.1.
- properties of, 5.4.1.2., 9.25.3.2.
- repair garages, 9.10.9.17.
- requirement for, 9.25.3.1.
- storage garages, 9.10.9.16.
- Airborne sound rating, 3.3.4.6., 5.8.1.2., 9.11.
- Air cleaning devices, 6.3.2.14.
- Air-conditioning systems and equipment
  - access, 6.2.1.6., 6.8.1.1., 9.33.4.4.
  - cleaning, 6.2.1.6., 9.33.4.4.
  - continuity of insulation, 9.36.3.5.
  - cooling units, 6.6.1.1.
  - design, 6.2.1., 9.33.1.1., 9.33.3.2., 9.33.4.1., 9.33.5.3.
  - energy efficiency, 9.36.
  - fire safety characteristics, 6.9.1.1., 9.33.6.
  - installation, 6.2.1., 6.6.1.1., 9.32.3.2., 9.33.1.1., 9.33.4., 9.33.5.2., 9.33.9.1.
  - installation standards, 6.2.1.5., 9.33.5.2., 9.33.5.3., 9.33.6.7.
  - performance requirements, 9.36.3.10.
  - protection from freezing, 6.2.1.6., 9.33.4.5.
  - structural movement, 4.1.8.18., 6.2.1.4., 9.33.4.7.
  - system pressure, 6.2.1.3., 9.33.4.6.
  - temperature controls, 9.36.3.6.
- Air duct systems
  - application of Code, 6.3.2.1.
  - clearance of ducts and plenums, 6.3.2.6.
  - connections, 6.3.2.4.
  - drain pans, 6.3.2.2.
  - duct coverings and linings, 6.3.2.5.
  - interconnection, 6.3.2.7.
  - makeup air, 6.3.2.8.
  - materials, 6.3.2.3.
  - supply, return, intake and exhaust air openings, 6.3.2.9.
- Air filters, 6.8.1.3., 9.33.6.14.
- Air intakes
  - area, 9.32.3.13.
  - connection, 9.33.6.6.
  - grilles, 6.3.2.9., 9.33.6.10.
  - labeling, 9.32.3.13.
  - location, 6.3.2.9., 9.32.3.13., 9.33.6.10., 9.33.6.12.
  - protection, 6.3.2.9., 9.32.3.13., 9.33.6.10.
- Air outlets
  - area, 9.32.3.13.
  - capacity, 9.33.6.11.
  - diffusers, 9.33.6.10., 9.33.6.11.
  - grilles, 6.3.2.9., 9.32.3.13., 9.33.6.10.
  - labeling, 9.32.3.13.
  - location, 6.3.2.9., 9.32.3.13., 9.33.6.10., 9.33.6.11.
  - protection, 6.3.2.9., 9.32.3.13., 9.33.6.10.
  - warm air heating, 9.33.6.10., 9.33.6.11.
- Air quality, emergency power supply, 3.2.7.9.
- Air-supported structures
  - clearance to flammable material, 3.1.6.4.
  - clearance to other structures, 3.1.6.3.
  - definition, 1.4.1.2.[A]
  - electrical systems, 3.1.6.7.
  - emergency air supply, 3.1.6.6.
  - fire protection, 9.10.1.3.
  - fire safety restrictions, 3.1.6.2.
  - flame resistance, 3.1.6.5.
  - means of egress, 3.1.6.1.
  - roof coverings, 3.1.15.2.
  - structural design basis, 4.4.1.1.
- Airtightness
  - building envelope, 9.36.2.9., 9.36.2.10.
  - material standards, 5.9.1.1.
  - requirement for, 5.4.1.1.
  - windows, doors and skylights, 5.9.2.3., 9.7.4.
- Air washers, 6.3.2.16.
- Aisles
  - with fixed seats, 3.3.2.5.
  - within floor areas, 3.3.1.10.
  - leading to exits, 3.4.2.5.
  - minimum clear width, 3.3.2.1.
  - outdoor places of assembly, 3.3.2.11.
  - with steps, handrails for, 3.3.2.10.
  - width, 3.4.3.2.
- Alarm signal
  - audibility, 3.2.4.17., 3.2.4.18.
  - definition, 1.4.1.2.[A]
  - design, 3.2.4.4.
  - high buildings, 3.2.6.7.
  - silencing, 3.2.4.6.
  - system monitoring, 3.2.4.15.
- Alert signal
  - audibility, 3.2.4.17., 3.2.4.18.
  - definition, 1.4.1.2.[A]
  - design, 3.2.4.4.
  - high buildings, 3.2.6.7.
  - system monitoring, 3.2.4.15.
- Alterations to buildings, 1.1.1.1.[A], 1.4.1.2.[A]
- Alternative materials, 1.2.2.1.[A]
- Alternative solutions, 1.2.1.1.[A], 2.3.1.[C]
- Aluminum
  - flashing, 9.20.13.1., 9.26.4.2., 9.27.3.7., 9.28.1.5.
  - nails, 9.26.2.3.
  - roofing, 9.26.13.1.
  - siding, 9.27.11.1.
  - structural design basis, 4.3.5.
- Ammonium nitrate, 3.3.6.6.
- Anchorage
  - anchor bolts, 9.20.11.6., 9.20.17.6.
  - columns, 9.23.6.2., 9.35.4.3.
  - concrete stairs, 9.8.10.2.
  - cornices, 9.20.11.5.
  - floors, 9.20.11.
  - foundations, 9.23.6., 9.35.4.3.
  - framing, 9.23.6.
  - horizontal force factor, 4.1.8.18.

- lateral loads, 9.23.6.1.
- masonry, 9.20.9., 9.20.11.
- masonry walls to wood-frame construction, 9.20.11.3., 9.20.11.4.
- roofs, 9.20.11., 9.20.17.6.
- sills, 9.20.11.5.
- small buildings, 9.23.6.3.
- walls, 9.20.11., 9.23.3.4.
- Anhydrous ammonia, storage, 3.3.6.3.
- Annual energy consumption
  - building envelope, 9.36.5.6.
  - climatic data calculations, 9.36.5.5.
  - definition, 9.36.5.2.
  - HVAC systems, 9.36.5.7.
  - modeling, proposed house, 9.36.5.9. - 9.36.5.12.
  - modeling, reference house, 9.36.5.13. - 9.36.5.16.
  - performance compliance, 9.36.5.3.
  - performance compliance calculations, 9.36.5.4.
  - service water heating systems, 9.36.5.8.
- Annunciators, fire alarm, 3.2.4.8., 3.2.4.9., 3.2.4.15., 3.2.5.14., 3.2.7.10.
- Antennas and antenna-supporting structures
  - earthquake loads and effects, 4.1.8.1.
  - wind loads, 4.1.7.11.
- Apparent sound transmission class (ASTC)
  - calculation of, 5.8.1.4., 5.8.1.5.
  - definition, 1.4.1.2.[A]
- Appliances
  - (see also Heating appliances; Heating systems and equipment; Heating, ventilating and air-conditioning (HVAC) systems and equipment)
  - in access to exit, 3.3.1.2.
  - air-conditioning, 6.2.1., 9.33.4.1., 9.33.5.2.
  - characteristics, 1.2.2.1.[A]
  - cooling, 6.2.1., 6.6.1.1., 9.33.4.1., 9.33.5.2., 9.33.9.1.
  - definition, 1.4.1.2.[A]
  - in exit, 3.4.4.4.
  - exterior, 3.6.1.5.
  - fuel-fired, 3.6.2.1., 9.10.10.4.
  - heating, 6.2.1.1., 9.33.4.1., 9.33.5.2.
  - location, 3.6.1.5., 6.3.2.17., 6.4.1.1., 9.10.10.4.
  - in means of egress, 9.9.5.7.
  - outdoor location, 6.2.1.6., 6.3.2.17., 6.4.1.2.
  - protection from freezing, 6.2.1.6., 9.33.4.5.
  - roof-top, 3.6.1.5., 3.6.2.1., 6.4.1.2., 9.10.1.3.
  - solid-fuel-burning, 3.6.2.1., 6.2.1.5., 9.33.5.3.
  - storage, 1.2.2.2.[A]
  - used, 1.2.2.3.[A]
  - ventilating, 6.2.1., 9.32.3.2.
- Application of National Building Code
  - divisions A, B, C, 1.3.[A]
  - factory-constructed buildings, 1.1.1.1.[A]
  - farm buildings, 1.1.1.1.[A]
  - new buildings, 1.1.1.1.[A]
  - objectives, 2.1.1.[A], 3.2.[A]
  - seasonally and intermittently occupied buildings, 9.1.1.1.
- Arches
  - fire-resistance ratings, 9.10.8.3.
  - in storeys below ground, 3.2.2.15.
  - supporting floor above basement, 3.2.1.4.
  - supporting masonry over openings, 9.20.5.2.
  - supporting service room/space, 3.1.7.5.
- Arch roofs, snow and rain loads, 4.1.6.10.
- Areas of refuge, 3.3.3.6.
- Areas and spaces
  - design, 9.5.
  - dimensions, 9.5.1.1.
- Arena-type buildings
  - building classification, 3.1.2.3.
  - building height exceptions, 3.2.1.1.
  - roof assemblies, 3.2.2.17.
  - seating, 3.3.2.2.
- Artesian groundwater, 1.4.1.2.[A], 4.2.5.5.
- Asbestos in air distribution systems and equipment, 6.2.1.7., 9.33.4.8.
- Asbestos cement pipe, 9.14.3.
- Assembly areas
  - loads on floor or roof, 4.1.5.3.
  - loads on tributary areas, 4.1.5.8.
  - sway forces and load, 4.1.5.10.
- Assembly occupancy (Group A)
  - air-supported structure as, 3.1.6.6.
  - assistive listening devices, 3.8.2.9., 3.8.3.18.
  - building classification, 3.1.2.1.
  - corridors, 3.3.2.6.
  - definition, 1.4.1.2.[A]
  - doors, 3.3.2.7.
  - fire protection, 3.2.2.17., 3.2.2.20. - 3.2.2.35., 9.10.1.3.
  - fire safety within floor areas, 3.3.1., 3.3.2.1.
  - location of smoke/fire dampers, 3.1.8.7.
  - occupant load, 3.1.17.1.
  - signals to fire department, 3.2.4.7.
  - visual alarm signals, 3.2.4.19.
  - washrooms, 3.7.2.
  - wheelchair spaces, 3.8.2.3.
- Assistive listening devices, 3.8.2.9., 3.8.3.18.
- Atomizers, 6.3.2.16.
- Attendant booths, 6.3.1.4.
- Attics or roof spaces
  - access, 3.6.4.4., 9.19.2.
  - clearances, 9.19.1.3.
  - definition, 1.4.1.2.[A]
  - exterior wall enclosing, 3.2.3.3.
  - fire blocks, 3.1.11.1., 3.1.11.5., 9.10.16.1.
  - fire protection, 9.10.12.4.
  - foamed plastics in, 3.1.4.2., 9.10.17.10.
  - housing and small buildings, 9.19.
  - insulation, 9.25.2.4.
  - loads, 4.1.5.3., 9.4.2.4.
  - in noncombustible construction, 3.1.5.3.
  - service spaces, 3.6.1.1.
  - soffits protection, 3.2.3.16.
  - venting, 5.3.1.2., 6.3.1.2., 9.19.1.
- Audible signal devices, 3.2.4.17., 3.2.4.18.
- Auditoriums, 3.2.2.21., 3.2.2.22.
- Authority having jurisdiction, 1.4.1.2.[A]
- Automatic locking devices, 3.3.4.5.
- Automatic sprinkler systems (see Sprinkler systems)

## B

Backdraft prevention, 6.3.2.10., 9.32.3.13.

### Backfill

(see also Fill)

excavations, 9.12.3.

material, 4.2.5.8., 9.12.3.3.

### Backfilling

(see also Fill)

beneath concrete stairs, 9.8.10.3.

beneath floors on grade, 4.2.5.8.

beneath footings, 4.2.5.8.

beneath foundations, 4.2.5.8.

grading, 9.12.3.2.

placement, 4.2.5.8., 9.12.3.1.

review, 4.2.2.3.

Bacteria, minimizing growth of, 6.3.1.6., 6.3.2.15.

Balance stops, 9.33.6.9.

### Balconies

as access to exit, 9.9.9.3.

concealed spaces in, 3.1.11.5.

doors and door hardware, 3.3.1.13.

earthquake load and effects, 4.1.8.1.

exception to travel limit, 9.9.9.1.

exterior, 3.2.2.11.

guards around, 3.3.1.18., 9.8.8.

horizontal exits, 3.4.6.10.

limiting distance, 3.2.3.6.

loads on floor or roof, 4.1.5.3., 4.1.5.4., 9.4.2.3.

occupant load, 3.1.17.1.

snow loads, 9.4.2.3.

sprinkler systems, 3.2.5.12.

wind loads, 4.1.7.5.

Banks, 3.4.6.17.

Barricades, construction and demolition sites, 8.2.1.3., 8.2.3.3.

### Barrier-free

balconies, 3.3.1.7.

bathrooms, 3.8.2.8., 3.8.3.17.

controls, 3.8.2.6., 3.8.3.8.

counters, 3.8.2.11., 3.8.3.19.

definition, 1.4.1.2.[A]

design standards, 3.8., 3.8.3.1., 9.5.2.

doors and doorways, 3.8.3.6.

drinking fountains, 3.8.2.8., 3.8.3.10.

elevators, 3.3.1.7., 3.5.2.1., 3.8.2.3., 3.8.3.7.

entrances, 3.8.2.2.

exterior walks, 3.8.3.3.

floor areas, 3.8.2.3.

floor surfaces, 3.8.3.2.

lavatories, 3.8.2.8., 3.8.3.15.

parking areas, 3.8.2.5.

path of travel (see Path of travel, barrier-free)

ramps, 3.8.3.5.

showers, 3.8.2.8., 3.8.3.16.

signs, 3.8.2.10., 3.8.3.9.

soap and towel dispensers, 3.8.3.15., 3.8.3.16.

spaces in seating areas, 3.8.2.3., 3.8.3.21.

telephone shelves, 3.8.2.11., 3.8.3.20.

universal washrooms, 3.8.2.8., 3.8.3.12.

urinals, 3.8.2.8., 3.8.3.14.

vestibules, 3.8.3.6.

washrooms, 3.8.2.8., 3.8.3.9., 3.8.3.11., 3.8.3.15.

water closets, 3.8.3.11., 3.8.3.13.

### Barriers

across transparent panels, 3.3.1.19.

preventing exit obstruction, 3.4.6.11., 9.9.11.2.

### Basements

access, 3.2.5.2., 9.10.20.2.

ceiling height, 9.5.3.1.

crawl spaces considered as, 3.2.2.9., 9.10.8.9.

definition, 1.4.1.2.[A]

exit signs, 3.4.5.2.

fire containment, 3.2.1.5.

fire protection, 3.2.2.15., 9.10.1.3.

fire-resistance of floor assemblies over, 3.2.1.4.

fire separations, 9.10.9.4., 9.10.9.14.

heating requirements, 9.33.3.1.

industrial occupancy (Group F), 3.3.5.3.

insulation, 9.25.2.2.

large or multi-storey, 9.10.1.3.

lighting, 9.34.2.3., 9.34.2.4.

residential occupancy (Group C), 3.2.2.47.

storage garages, 3.1.10.3., 3.2.1.2., 9.10.4.3.

supply outlets, 9.33.6.11.

Bathroom accessories, 3.7.2.3., 3.7.2.9., 3.8.3.8., 3.8.3.11., 3.8.3.15., 3.8.3.17.

### Bathrooms

(see also Washrooms)

ceiling height, 9.5.3.1.

doorways, 9.4.4.3.

flame-spread rating, 3.1.13.3.

Bathtubs, 3.7.2.9., 3.8.3.17., 9.6.1.4.

### Beams

bearing, 9.23.8.1.

built-up, 9.23.4.2., 9.23.4.4., 9.23.8.3.

dimensions, 9.23.4.1.

glued-laminated, 9.23.4.1., 9.23.4.2., 9.23.4.4.

in heavy timber construction, 3.1.4.7.

lumber grade, 9.3.2.1.

preservative treatment, 9.23.2.2., 9.23.2.3.

ridge, 9.23.14.8.

spans, 9.23.4.1., 9.23.4.2., 9.23.4.4.

spans, maximum, 9.23.4.

steel, 9.23.4.3., 9.23.8.2.

supported on masonry or concrete, 9.10.9.9., 9.15.5., 9.20.8.3., 9.20.8.4., 9.21.5.3., 9.23.2.2., 9.23.2.3.

to support floors, 9.23.8.

wood, 9.23.4.2., 9.23.4.4.

Bearing surface, 1.4.1.2.[A]

### Bedrooms

means of egress, 9.9.10.1.

mechanical ventilation, 9.32.2.3.

natural ventilation, 9.32.2.2.

windows, 9.9.10.1.

### Bleachers

aisles, 3.3.2.5.

guards, 3.3.2.9.

inspection, 4.1.5.12.

load analysis, 4.1.5.12.

locking, 4.1.5.12.

- seats, 3.3.2.5.
- steps, 3.3.2.5., 3.3.2.12.
- Blocking
  - cladding, 9.27.5.2.
  - cladding and interior finishing materials, 9.23.10.5.
  - doors, 9.7.5.2.
  - with handrails, 9.8.7.7.
  - joists, 9.23.9.3., 9.23.9.4., 9.23.14.9.
  - nailing, 9.23.3.4.
  - in noncombustible construction, 3.1.5.2.
  - rafters and joints, 9.23.14.7.
  - roof edges, 9.23.16.6., 9.23.16.7.
  - subflooring, 9.23.15.3.
  - walls, 9.23.9.8., 9.23.10.2.
- Boarding and lodging houses, 9.10.9.14.
- Boiler rooms, 3.6.2.2., 9.10.10.4.
- Boilers
  - definition, 1.4.1.2.[A]
  - installation standard, 6.2.1.5.
  - performance requirements, 9.36.3.10.
- Bonding
  - intersecting masonry walls, 9.20.11.2.
  - masonry, 9.20.9.
- Book shelves, 3.3.2.13.
- Braced wall bands, 1.4.1.2.[A], 9.23.13.4., 9.23.13.5.
- Braced wall panels
  - anchorage, 9.23.6.1., 9.23.13.5.
  - definition, 1.4.1.2.[A]
  - fastening, 9.23.3.4., 9.23.3.5.
  - gypsum board, 9.29.5.9.
  - lateral loads, 9.23.13.5., 9.23.13.6.
  - plywood, 9.29.6.3.
  - and wall supports, 9.23.9.8.
- Bracing, wood-frame walls, 9.23.13., 9.23.13.4., 9.23.13.5.
- Breeching, 1.4.1.2.[A]
- Bridging floor joists, 9.23.9.4.
- Builder (see Constructor)
- Building area
  - assembly occupancy (Group A, Division 1), 3.2.2.20.
  - assembly occupancy (Group A, Division 2), 3.2.2.23.
  - assembly occupancy (Group A, Division 3), 3.2.2.29.
  - business and personal services occupancy (Group D), 3.2.2.55.
  - care, treatment or detention occupancy (Group B Division 1), 3.2.2.36., 3.2.2.37.
  - care, treatment or detention occupancy (Group B Division 2), 3.2.2.38. - 3.2.2.41.
  - care, treatment or detention occupancy (Group B Division 3), 3.2.2.42. - 3.2.2.46.
  - definition, 1.4.1.2.[A]
  - determination, 1.3.3.4.[A]
  - determination of fire safety requirements, 3.2.2.5.
  - high-hazard industrial occupancy (Group F, Division 1), 3.2.2.70.
  - low-hazard industrial occupancy (Group F, Division 3), 3.2.2.80.
  - medium-hazard industrial occupancy (Group F, Division 2), 3.2.2.74.
  - mercantile occupancy (Group E), 3.2.2.64.
  - residential occupancy (Group C), 3.2.2.47., 3.2.2.50., 3.2.2.51.
  - self-service storage buildings, 3.9.2.1.
- Building assemblies
  - effective thermal resistance, 9.36.2.6.
  - fire-resistance rating, 3.1.7.5.
  - off-site review, 2.2.7.5.[C]
  - replacement options, 9.36.2.11.
  - thermal resistance calculation, 9.36.2.4.
- Building classification
  - by major occupancy, 3.1.2.1., 9.10.2.
  - for wind load calculations, 4.1.7.2.
- Building, definition, 1.4.1.2.[A]
- Building envelope
  - energy efficiency, 9.36.2.
  - energy performance calculations, 9.36.5.6.
  - energy performance modeling, 9.36.5.10., 9.36.5.14.
  - replacement options, 9.36.2.11.
  - thermal resistance calculation, 9.36.2.4.
- Building height
  - access route design, 3.2.5.6.
  - assembly occupancy (Group A, Division 1), 3.2.2.20.
  - assembly occupancy (Group A, Division 2), 3.2.2.23.
  - assembly occupancy (Group A, Division 3), 3.2.2.29.
  - business and personal services occupancy (Group D), 3.2.2.55., 3.2.2.57., 3.2.2.58.
  - care, treatment or detention occupancy (Group B Division 1), 3.2.2.36., 3.2.2.37.
  - care, treatment or detention occupancy (Group B Division 2), 3.2.2.38. - 3.2.2.41.
  - care, treatment or detention occupancy (Group B Division 3), 3.2.2.42. - 3.2.2.46.
  - definition, 1.4.1.2.[A]
  - determination, 1.3.3.4.[A], 9.10.4.
  - determination of fire safety requirements, 3.2.2.5.
  - exceptions, 3.2.1.1.
  - garages as separate buildings, 9.10.4.3.
  - high-hazard industrial occupancy (Group F, Division 1), 3.2.2.70.
  - low-hazard industrial occupancy (Group F, Division 3), 3.2.2.80.
  - medium-hazard industrial occupancy (Group F, Division 2), 3.2.2.74.
  - mercantile occupancy (Group E), 3.2.2.64.
  - mezzanines excluded, 9.10.4.1.
  - mezzanines included, 9.10.4.2.
  - residential occupancy (Group C), 3.2.2.47., 3.2.2.50., 3.2.2.51.
  - roof-top enclosures excluded, 9.10.4.4.
- Building services
  - barrier-free controls, 3.8.3.8.
  - emergency power supply, 3.2.7.9.
  - and fire alarm systems, 3.2.4.2.
  - and firewalls, 3.1.10.1.
  - penetrating fire separations and fire-rated assemblies, 3.1.9.2., 9.10.9.6.

Building size determination  
application of Code, 1.3.3.4.[A]  
inclusions, 9.10.4.1.  
relative to occupancy, 9.10.8.

Built-up roofing, 9.26.11.

Business and personal services occupancy (Group D)  
classification, 3.1.2.1., 9.10.2.  
definition, 1.4.1.2.[A]  
emergency power for fire alarm systems, 3.2.7.8.  
emergency power for lighting, 3.2.7.4.  
exit stairs, 9.9.4.7.  
exposing building face, 9.10.14.5.  
fire access route design, 3.2.5.6.  
fire alarm systems, 3.2.4.1., 9.10.18.  
fire protection, 3.2.2.55. - 3.2.2.63.  
fire-resistance rating, 9.10.8.  
fire safety within floor areas, 3.3.1.  
flame-spread rating, 9.10.17.  
occupant load, 3.1.17.1.  
sprinkler systems, 3.2.5.12.  
washrooms, 3.7.2.

## C

Cabinetry, around cooktops, 9.10.22.3.

Cables  
in air barrier systems, 9.36.2.10.  
in combustible construction, 3.1.4.3.  
elevator, 3.1.5.22.  
in noncombustible construction, 3.1.5.21.  
penetrating fire separations, 3.1.9.3.  
in plenums, 3.6.4.3.

Caissons (see Pile foundations)

Calculations and analyses  
heat, air and moisture transfer, 5.2.1.2., 5.2.1.3.  
HVAC equipment and systems, 6.2.1.1., 9.33.4.1.  
limit states design, 4.1.3.  
snow, rain and ice load, 4.1.6.  
structural, 2.2.4.5.[C], 4  
wind load, 4.1.7., 5.2.1.3., 5.2.2.2.

Canopies  
fabrics, 3.1.16.1.  
for vertically separated openings, 3.2.3.17.

Capacity of exit, 3.4.3.2.

Carbon monoxide  
alarms, 9.32.3.8., 9.32.3.9.  
concentration, 6.3.1.4.  
detectors, 6.3.1.4., 6.9.3.1., 9.32.3.8., 9.32.3.9.

Care, definition, 1.4.1.2.[A]

Care, treatment or detention occupancy (Group B)  
building classification, 3.1.2.1.  
definition, 1.4.1.2.[A]  
door hold-open devices, 3.1.8.14.  
doorway width, 3.3.3.4.  
electromagnetic locks, 3.4.6.17.  
emergency lighting, 3.2.7.3.  
emergency power supply, 3.2.7.6.  
evaporative cooling towers, 6.3.2.15.  
fire alarm systems, 3.2.4.1., 3.2.4.18.  
fire protection, 3.2.2.36. - 3.2.2.46.

fire safety within floor areas, 3.3.1., 3.3.3., 3.3.3.1.  
location of smoke/fire dampers, 3.1.8.7.  
occupant load, 3.1.17.1.  
ramp slope maximum, 3.4.6.7.  
as residential occupancy, 3.1.2.5.  
self-closing door hardware, 3.1.8.13.  
sleeping room exits, 3.4.1.6.  
smoke alarms, 3.2.4.20.  
smoke detectors, 3.2.4.11.  
sprinkler systems, 3.2.2.19., 3.2.5.12.  
visual alarm signals, 3.2.4.19.

Carpets, 3.1.13.1.

Carports  
(see also Garages)  
columns, 9.35.4.2., 9.35.4.3.  
concrete for floors, 9.3.1.6.  
for dwelling units, 9.35.  
spatial separation from other buildings, 9.10.14.4.  
walls, 9.35.4.1., 9.35.4.3.

Catch basins, 9.14.6.4.

Caulking  
(see also Sealants)  
for ceramic wall tile, 9.29.10.5.  
door frames, 9.20.13.11.  
material standards, 9.29.10.5.  
in noncombustible construction, 3.1.5.2.  
requirements, 9.27.4., 9.27.4.1.  
sill plates, 9.23.7.2.  
stucco, 9.28.1.5.  
windows and frames, 9.7.6.2., 9.20.13.11.

Cavity walls  
corbelling, 9.20.12.2.  
definition, 1.4.1.2.[A]  
flashing, 9.20.13.5., 9.20.13.6.  
framing supported by, 9.20.8.2.  
height and thickness, 9.20.6.2.  
lateral support, 9.20.10.1.  
mortar droppings, 9.20.13.10.  
precipitation protection, 9.27.2.2.  
tying, 9.20.9.4.

Ceiling membranes  
fire-resistance rating, 3.6.4.3., 9.10.3.4.  
fire stop flaps, 9.10.13.14.  
openings in, 3.1.9.6., 9.10.5., 9.10.9.6., 9.10.9.7.  
suspended, 9.10.3.4.

Ceiling panels, factory-assembled, 3.1.5.7.

Ceilings  
air barrier systems, 9.25.3.  
area, calculating, 9.36.2.3.  
assembly used as plenum, 3.1.9.7.  
in corridors, 3.1.13.6.  
effective thermal resistance, 9.36.2.6.  
fastened to floor joists, 9.23.9.4.  
finish, 3.1.5.12., 9.29.  
foamed plastics in, 9.10.17.10.  
framing, 9.23.14.  
framing around openings, 9.23.14.2.  
height, 9.5.3.  
joists, 9.23.14.1., 9.23.14.7.  
thermal insulation, 9.25.1.1.

Cement, standards for, 9.3.1.2.



- Central alarm and control facility, 3.2.4.22., 3.2.6.4., 3.2.6.7.
- Ceramic tile  
 as flooring, 9.30.6.  
 installation, 9.29.10.1.  
 as interior finish, 9.29.10.  
 subfloor, 9.23.15.5.  
 underlay, 9.23.15.5., 9.30.2.1., 9.30.2.2.
- Chases, 9.20.7.
- Children's custodial homes, 3.1.2.5., 3.2.4.3., 9.10.2.2.
- Chimneys  
 access ladders, 6.3.3.4.  
 airtightness, 9.36.2.10.  
 bracing, 9.21.4.5.  
 caps, 9.21.4.6.  
 cleanouts, 9.21.4.7.  
 clearances, 6.3.3.1., 9.21.5., 9.25.3.3.  
 concrete, 1.4.1.2.[A], 6.3.3.2., 9.21., 9.21.4.2., 9.33.10.3.  
 construction, 9.21.4.  
 definition, 1.4.1.2.[A]  
 design of, 6.3.3.2., 9.20.2.3., 9.21., 9.33.10.3.  
 earthquake loads and effects, 4.1.8.1.  
 factory-built, 1.4.1.2.[A], 9.33.10.2.  
 fireplace, 9.21.2.4., 9.21.2.5.  
 flashing, 9.21.4.6., 9.21.4.10., 9.26.4.4., 9.26.4.6., 9.26.4.8.  
 flues, 9.21.2., 9.21.4.4.  
 footings, 9.21.4.3.  
 fuel-fired appliances, 6.3.3.1., 9.33.10.1.  
 incinerators, 9.10.10.5., 9.21.2.1.  
 lateral stability, 9.21.4.5.  
 liners (see Liners, chimney)  
 masonry, 1.4.1.2.[A], 6.3.3.2., 9.21., 9.21.4.1., 9.33.10.3.  
 metal, 6.3.3.3., 9.33.10.2.  
 saddles, 9.26.4.8.  
 sealing, 9.21.5.2.  
 venting equipment, 6.3.1.  
 walls, 9.21.1.2.  
 wall thickness, 9.21.4.8.
- Chutes  
 linen, 3.6.3.3., 9.10.1.3.  
 refuse, 3.6.3.3., 9.10.1.3.  
 sprinklers, 3.6.3.3.  
 venting, 3.6.3.3.
- Cladding  
 attachment, 9.27.5.  
 for braced wall panels, 9.23.13.6.  
 combustible, 9.10.14.5., 9.10.15.5.  
 in combustible construction, 3.1.4.8.  
 exposing building face, 3.2.3.7.  
 fastening to steel studs, 9.24.1.4.  
 housing and small buildings, 9.27.  
 installation, 5.6.1.2., 5.9.1.1., 9.27.2.4., 9.27.3.6., 9.27.5.  
 interior, 3.1.13.1.  
 noncombustible, 3.1.4.8., 3.2.3.7., 3.2.3.9.  
 in noncombustible construction, 3.1.5.5.  
 protection against precipitation, 5.6.  
 requirement for, 5.6.1.1., 9.27.2.1.  
 sealing, 5.6.2.1., 9.27.3.6., 9.27.4.  
 on steel studs, 9.24.1.5.  
 support of, 9.20.5., 9.23.10.5., 9.24.3.4.  
 waterproofing, 9.27.4.  
 wind loads, 4.1.7.5., 4.1.7.6., 4.1.7.12.
- Cladding, clay tile, 9.23.4.5.
- Cladding, concrete  
 design, 9.20.6.6.  
 water absorption, 9.20.2.6.  
 weight, 9.20.2.6.
- Cladding, decorative, 3.1.5.24.
- Cladding, hardboard  
 clearances, 9.27.2.4., 9.27.9.5.  
 dimensions, 9.27.9.2.  
 housing and small buildings, 9.27.9.  
 installation, 9.27.2.4., 9.27.3.6., 9.27.5., 9.27.9.3.  
 material standards, 5.9.1.1., 9.27.9.1.
- Cladding, lumber  
 dimensions, 9.27.6.2.  
 housing and small buildings, 9.27.6.  
 installation, 5.9.1.1., 9.27.2.4., 9.27.3.6., 9.27.5.  
 material standards, 5.9.1.1.
- Cladding, masonry  
 bonding and tying, 9.20.9.  
 flashing, 9.20.13.  
 housing and small buildings, 9.20., 9.27.2.2.  
 installation, 5.6.1.2.  
 material standards, 5.9.1.1.  
 mortar joints, 9.20.4.  
 support of, 9.20.5.
- Cladding, metal  
 housing and small buildings, 9.27.11.  
 installation, 5.9.1.1., 9.27.3.6., 9.27.5.  
 material standards, 5.9.1.1., 9.27.11.1.
- Cladding, OSB and waferboard  
 clearances, 9.27.2.4., 9.27.10.4.  
 dimensions, 9.27.10.2.  
 housing and small buildings, 9.27.10.  
 installation, 9.27.2.4., 9.27.3.6., 9.27.5., 9.27.10.3., 9.27.10.4.  
 material standards, 5.9.1.1., 9.27.10.1.
- Cladding, plywood  
 dimensions, 9.27.8.2.  
 housing and small buildings, 9.27.8.  
 installation, 9.27.2.4., 9.27.3.6., 9.27.5., 9.27.8.3.  
 material standards, 5.9.1.1., 9.27.8.1.  
 sealing, 5.6.2.1., 9.27.8.3., 9.27.8.4.
- Cladding, stone, 9.20.6.6.
- Cladding, vinyl  
 housing and small buildings, 9.27.12.  
 installation, 9.27.5., 9.27.12.2.  
 material standards, 5.9.1.1., 9.27.12.1.
- Cladding, waferboard (see Cladding, OSB and waferboard)
- Cladding, wood shingles and shakes  
 grades, 9.27.7.1.  
 housing and small buildings, 9.27.7.  
 material standards, 5.9.1.1., 9.27.7.1.
- Classification of buildings/building parts  
 by major occupancy, 3.1.2.1., 9.10.2.  
 for wind load calculations, 4.1.7.2.

## Clearances

- (see also Headroom clearance)
- attic or roof spaces, 9.19.1.3.
- chimneys, 6.3.3.1., 9.21.5., 9.25.3.3.
- cladding above ground, 9.27.2.4.
- cladding to roof, 9.27.2.4.
- combustible framing, 9.22.9.3.
- combustible material, 6.3.2.6., 9.22.9., 9.33.6.8.
- cooktops, 9.10.22.1.
- cooling towers, 6.3.2.15.
- crawl spaces, 9.18.4.1.
- door frames, 9.27.9.5., 9.27.10.4.
- ducts, 6.3.2.6., 9.22.9.4., 9.33.6.8.
- electric ranges, 9.10.22.1.
- furnace plenums, 6.3.2.6., 9.33.6.8.
- furnaces, 6.2.1.5., 9.33.5.2.
- gas-fired ranges, 9.10.22.1.
- gas vents, 9.25.3.3.
- above ground, 9.15.4.6., 9.27.2.4.
- handrails, 9.8.7.5.
- hardboard siding, 9.27.9.5., 9.27.10.4.
- heating and air-conditioning equipment, 6.2.1.5., 9.33.5.2.
- ovens, 9.10.22.1.
- pipes, 6.7.1.2., 9.33.8.3.
- propane ranges, 9.10.22.1.
- siding above ground, 9.27.2.4.
- siding to roof, 9.27.2.4.
- smoke chambers, 9.22.9.3.
- solid-fuel-burning appliances, 9.33.5.3.
- solid-fuel fired appliances, 6.2.1.5.
- stucco from ground, 9.28.1.4.
- supply ducts, 6.3.2.6., 9.33.6.8.
- unit heaters, 6.4.2.1.
- vented products of combustion, 6.3.3.1.
- window frames, 9.27.9.5., 9.27.10.4.
- wood-frame construction, 9.23.2.2.
- wood above ground, 9.3.2.9., 9.23.2.3.

Climatic data, 1.1.3., 9.36.5.5.

## Closures

- (see also Doors; Windows)
- chutes, 3.6.3.3.
- definition, 1.4.1.2.[A]
- door latches, 3.1.8.15., 3.4.6.16., 9.10.13.9.
- elevator shaft openings, 3.2.6.5.
- exterior wall openings, 3.2.3.5.
- fire dampers, 9.10.13.13.
- fire-protection rating, 3.1.8.4., 3.1.8.5., 9.10.13.1.
- in fire separations, 3.2.8.2., 3.3.3.5., 9.10.9.3., 9.10.13., 9.10.13.8.
- glass blocks, 3.1.8.16., 3.2.3.5., 9.10.13.7.
- hold-open devices, 3.1.8.14., 9.10.13.11.
- installation, 3.1.8.5., 9.10.13.1.
- protection of exit facilities, 3.2.3.13.
- self-closing devices, 3.1.8.13., 3.4.6.13., 9.9.6.7., 9.10.13.10., 9.10.13.15.
- temperature limits, 3.1.8.17.
- twenty-minute, 3.1.8.12.
- unprotected openings, 3.2.3.1.
- wired glass, 3.1.8.16., 3.2.3.5.

## Cold weather requirements

- concrete, 9.3.1.9.
- excavations, 9.12.1.3.
- gypsum board, 9.29.5.10.
- HVAC systems and equipment, 6.2.1.6., 9.33.4.5.
- masonry, 9.20.14.
- stucco, 9.28.6.1.

Collar ties, 9.23.14.7.

## Columns

- anchorage, 9.23.6.2., 9.35.4.3.
- carports, 9.35.3.4., 9.35.4.2., 9.35.4.3.
- concrete, 9.17.6.
- fire-resistance rating, 9.10.8.3.
- garages, 9.35.4.2., 9.35.4.3.
- heavy timber construction, 3.1.4.7.
- housing and small buildings, 9.17.
- lateral support, 9.17.2.2.
- masonry, 9.17.5.
- steel, 9.10.14.5., 9.10.15.5., 9.17.3.
- supported on masonry or concrete, 9.20.8.4.
- wood, 9.10.14.5., 9.10.15.5., 9.17.4.

Combustible cladding, 3.2.3.7., 9.10.14.5., 9.10.15.2.

## Combustible construction

- definition, 1.4.1.2.[A]
- exterior cladding, 3.1.4.8.
- fire-retardant-treated wood in, 3.1.4.5., 3.1.4.8.
- foamed plastics in, 3.1.4.2., 9.10.17.10.
- heavy timber in, 3.1.4.6., 3.1.4.7.
- materials permitted, 3.1.4.1.
- projections, 9.10.12.4., 9.10.14.5., 9.10.15.5.
- raceways in, 3.1.4.4.
- supports, 3.1.8.2., 9.10.9.8.
- wires and cables in, 3.1.4.3.

Combustible content, 3.2.8.8.

## Combustible dusts

- definition, 1.4.1.2.[A]
- and fire hose nozzles, 3.2.5.11.

## Combustible fibres

- definition, 1.4.1.2.[A]
- storage building classification, 3.1.2.6.

## Combustible gases

- compressed, indoor storage, 3.3.6.3.
- storage, 3.3.6.2.

## Combustible liquids

- definition, 1.4.1.2.[A]
- storage, 3.3.2.16., 3.3.4.3.
- storage and dispensing rooms, 3.3.6.4.

## Combustible materials

- clearances to ducts, 3.6.5.6., 6.3.2.6., 9.33.6.8.
- in combustible construction, 3.1.4.1.
- in noncombustible construction, 3.1.5.2., 3.1.5.6., 9.10.6.
- storage, 3.3.6.2.

## Combustible piping

- drain, waste and vent, 3.1.9.5., 9.10.9.7.
- in noncombustible construction, 3.1.5.19.
- in sprinkler systems, 3.1.9.5., 3.2.5.13., 9.10.9.6.
- in vacuum cleaning systems, 3.1.9.5.
- for water distribution, 3.1.9.5., 9.10.9.6.

## Combustible projections

- exposing building face, 3.2.3.6., 9.10.14.5., 9.10.15.5.

- at firewalls, 3.1.10.7.
- limiting distance, 3.2.3.6.
- soffit protection, 3.2.3.16., 9.10.12.4.
- Combustible refuse storage, 3.6.2.5.
- Combustion venting, 6.3.3.1., 9.32.3.8.
- Commercial cooking equipment, 3.3.1.2., 6.3.1.7., 9.10.1.4., 9.10.13.13.
- Communication, voice (see Voice communication systems)
- Compatibility
  - fasteners for cladding, 9.27.5.5.
  - resistance to deterioration, 5.1.4.2.
- Compliance
  - definition, 1.2.1.1.[A]
  - energy performance, 2.2.8.3.[C]
- Concealed spaces
  - fire blocks in, 3.1.11.1., 3.1.11.3., 3.1.11.4., 3.1.11.5., 3.1.11.7., 9.10.16., 9.10.16.1.
  - above fire separations, 3.1.8.3.
  - fire separations in, 3.6.4.2., 3.6.4.3., 9.10.9.10.
  - insulation, 3.1.11.2.
- Concrete
  - admixtures, 9.3.1.8.
  - aggregate for, 9.3.1.1., 9.3.1.4., 9.3.1.7.
  - cantilevered precast steps, 9.8.10.
  - cellular, 9.20.2.4.
  - chimneys, 1.4.1.2.[A], 6.3.3.2., 9.21., 9.33.10.3.
  - cold weather requirements, 9.3.1.9.
  - columns, 9.17.6.
  - dampproofing, 9.13.2.3., 9.13.2.4., 9.13.2.5.
  - design, 4.2.3.5., 4.2.3.6., 9.3.1., 9.4.1.1.
  - flues, 9.21.
  - foundations, 4.2.3.5., 4.2.3.6., 9.15.
  - joints, 9.15.4.9.
  - mixes, 9.3.1.7.
  - plain, reinforced and prestressed, 4.3.3., 9.3.1.
  - roof tiles, 9.26.2.1., 9.26.17.
  - slabs, for floors-on-ground, 9.16.4., 9.25.2.3., 9.33.6.7.
  - stairs, 9.8.9.2., 9.8.10.
  - standards for, 9.3.1.1., 9.3.1.3.
  - strength, compressive, 9.3.1.6.
  - structural design basis, 4.3.3.1.
  - sulphate-resistant, 9.3.1.3.
  - surface finish, 9.16.4.1.
  - as thermal barrier, 3.1.5.14., 3.1.5.15.
  - topping, 9.16.4.2., 9.23.4.4.
  - water used in, 9.3.1.5.
- Concrete block, 9.15.2.2., 9.17.5.1., 9.20.2.6.
- Condensation control
  - air barrier systems, 9.25.3.1.
  - in exhaust ducts, 6.3.2.10.
  - and heat transfer, 5.3.1.2.
  - properties, 9.25.5.1.
  - scope of Code, 5.1.1.1.
  - thermal insulation, 9.25.2.1.
  - vapour barrier properties, 5.5.1.2.
  - vapour barriers, 9.25.4.3.
- Conditioned space, 1.4.1.2.[A]
- Conflicting requirements, 1.5.1.2.[A]
- Connected buildings, 3.2.6.3.
- Construction
  - relative to occupancy, 9.10.8.
  - review of work, 2.2.7.2.[C]
  - types, 9.10.6.
- Construction camps, 9.10.21.
- Construction sites
  - excavations, 8.2.2.
  - guard persons, 8.2.1.4.
  - repair of damaged public property, 8.2.3.4.
  - safety measures, 8.1.
  - unoccupied, 8.2.1.5.
  - use of streets or public property, 8.2.3.
  - vehicular traffic control, 8.2.4.
  - warning lights, 8.2.3.5.
  - waste material, 8.2.5.
- Constructor, definition, 1.4.1.2.[A]
- Contained use areas
  - definition, 1.4.1.2.[A]
  - doors and door hardware, 3.3.1.13., 3.4.6.11., 3.4.6.16.
  - fire alarm systems, 3.2.4.1.
  - fire annunciators, 3.2.4.8.
  - fire separations, 3.3.3.7.
  - smoke detectors, 3.2.4.11.
  - sprinkler system requirements, 3.2.2.19.
- Contaminated air
  - minimum distances of air intakes from, 6.3.2.9.
  - movement, 3.2.6.2., 3.2.6.3.
  - removal, 6.3.1.6., 6.3.2.14.
- Continental seating, 3.3.2.4.
- Controls
  - barrier-free, 3.8.2.6., 3.8.3.8., 3.8.3.10., 3.8.3.16., 3.8.3.17.
  - location, 3.8.3.8.
  - operation, 3.8.3.8.
  - temperature, 9.33.4.3.
- Convalescent homes
  - fire alarm systems, 3.2.4.3.
  - as residential occupancies, 3.1.2.5., 9.10.2.2.
- Convectors, 9.33.7.1.
- Cooking equipment, commercial, 3.3.1.2., 6.3.1.7., 9.10.1.4., 9.10.13.13.
- Cooktops
  - (see also Stoves)
  - clearances, 9.10.22.1., 9.10.22.2.
  - definition, 1.4.1.2.[A]
  - fans, 9.32.3.11.
  - hoods, 9.32.3.11.
  - installation, 9.10.22.1., 9.33.5.3.
  - protection around, 9.10.22.3.
- Coolers, walk-in, 3.1.4.2., 3.1.5.7., 9.10.17.10.
- Cooling systems and equipment
  - installation, 6.6.1.1., 9.33.9.1.
  - structural movement, 4.1.8.18., 6.2.1.4., 9.33.4.7.
  - system pressure, 6.2.1.3., 9.33.4.6.
- Cooling towers and sections, 6.3.2.15.
- Corbelling, 9.15.4.8., 9.20.12.
- Cornices, 3.1.11.5.
- Corridors
  - (see also Public areas; Public corridors)
  - access to exit, 3.3.2.6., 9.9.7.

- assembly occupancy, 3.3.2.6.
  - care, treatment or detention occupancy, 3.3.3.3., 3.3.3.5.
  - dead-end, 3.1.8.17., 3.3.1.9., 3.3.3.3., 3.3.4.4., 9.9.7.3.
  - dimensions, 3.3.1.9., 9.9.5.2.
  - doors opening into, 3.3.1.11., 9.9.6.1.
  - emergency lighting, 3.2.7.3.
  - fire separations, 9.10.9.15.
  - flame-spread rating, 3.1.13.6., 9.10.21.6.
  - illumination, 3.2.7.1., 3.2.7.3.
  - loads on floor or roof, 4.1.5.3., 4.1.5.4.
  - obstructions, 3.3.1.9., 9.9.5.2., 9.9.5.3., 9.9.6.1.
  - paired doors in, 3.3.3.3.
  - serving patients' sleeping rooms, 3.3.3.5.
  - sliding glass partitions, 9.6.1.4.
  - smoke detectors, 3.2.4.11.
  - temperature rise and area limits exception, 3.1.8.19.
  - transparent doors in, 3.3.1.19.
  - transparent panels in, 3.3.1.19.
  - width, 3.3.1.9., 9.9.3.3., 9.9.5.2.
  - width, in dwelling units, 9.5.4.1.
  - windows in, 3.3.1.19.
  - Corrosion protection
    - (see also Corrosion resistance)
    - pipes, 9.31.2.2.
    - service water heaters, 9.31.6.3.
    - steel beams, 9.23.8.2.
    - steel lintels, 9.20.5.2.
  - Corrosion resistance
    - (see also Corrosion protection)
    - ducts, 6.3.2.3., 9.33.6.2., 9.33.6.7.
    - elements in environmental separators, 5.1.4.2.
    - fasteners for cladding, 9.27.5.5.
    - masonry connectors, 9.20.16.1.
    - plumbing, 9.31.2.2.
    - screens and grilles, 6.3.2.9., 9.32.3.13.
    - service water heaters, 9.31.6.3.
  - Counters
    - for service to the public, 3.8.3.1., 3.8.3.19.
    - for telephones, 3.8.3.20.
  - Covered ways, 8.2.1.1., 8.2.1.2.
  - Coverings
    - ducts, 3.6.5.4., 6.3.2.5., 9.33.6.4.
    - pipes, 6.3.2.5.
  - Crack control joints, 9.15.4.9.
  - Cranes, loads due to, 4.1.3.2., 4.1.5.11.
  - Crawl spaces
    - access, 3.6.4.6., 9.18.2.1., 9.18.4.1.
    - air barrier systems in, 9.18.1.3.
    - application of Code, 3.6.1.1.
    - clearance, 9.18.4.1.
    - drainage, 9.18.5.
    - fire blocks in, 3.1.11.1., 3.1.11.6.
    - fire resistance of floors over, 9.10.8.1., 9.10.9.4.
    - fire separations, 3.3.1.4.
    - flame-spread rating, 9.18.7.1.
    - ground cover, 9.18.6.
    - heated, 9.13.4.2., 9.18.1.3., 9.33.3.1.
    - housing and small buildings, 9.18.
    - insulation, 9.18.1.3., 9.25.2.2., 9.25.2.3.
    - regulated as basements, 3.2.2.9., 9.10.8.9.
    - return-air inlets, 9.33.6.12.
    - supply outlets, 9.33.6.11.
    - unheated, 9.18.1.3.
    - vapour barrier in, 9.18.1.3.
    - ventilation, 6.3.1.2., 9.18.3.
      - as warm-air plenums, 9.18.7.1.
  - Curbs, repair and storage garages, 3.3.5.4., 9.8.8.4.
  - Curtain walls (see Fenestration)
  - Curved roofs, snow and rain loads, 4.1.6.10.
  - Cutting operations room, 3.3.1.25.
- ## D
- Dampers
    - (see also Fire dampers)
    - access, 6.2.1.6., 9.33.4.4.
    - adjustable, 9.33.6.9.
    - fireplaces, 9.22.6.1.
  - Dampproofing
    - crawl spaces, 9.18.6.
    - floors, 9.23.2.3.
    - floors-on-ground, 9.13.2.1., 9.13.2.6.
    - foundations, 9.13.2.
    - installation, 9.13.2.4.
    - material standards, 5.9.1.1., 9.13.2.2.
    - preparation of surface, 9.13.2.3.
    - protection from groundwater, 5.7.3.4.
    - protection of interior finishes, 9.13.2.5., 9.20.13.9., 9.23.2.3.
    - requirement for, 9.13.2.1.
    - walls, 9.13.2.1., 9.13.2.3., 9.13.2.4., 9.20.13.9., 9.23.2.3.
  - Dance halls
    - access to exit, 3.3.1.17.
    - principal entrances, 3.4.2.6.
  - Dangerous goods
    - access openings, 3.2.5.1.
    - definition, 1.4.1.2.[A]
    - hazardous areas design, 3.3.6.
    - process plants, 3.3.6.8., 3.3.6.9.
    - storage, 3.3.6.2., 3.3.6.3.
  - Dead-end corridors, 3.1.8.17., 3.3.1.9., 3.3.3.3., 3.3.4.4., 9.9.7.3.
  - Dead loads, 1.4.1.2.[A], 4.1.3.2., 4.1.4., 9.4.3.1.
  - Decay, protection against, 9.3.2.9., 9.23.2.2., 9.23.2.3.
    - (see also Deterioration)
  - Decking for wood shingled roofs, 9.26.9.1.
  - Decks
    - foundations, 9.12.2.2.
    - snow loads, 9.4.2.3.
    - sprinkler systems, 3.2.5.12.
  - Deep foundations
    - damaged, 4.2.7.6.
    - definition, 1.4.1.2.[A]
    - design, 4.2.7.2.
    - installation, 4.2.7.5.
    - load testing, 4.2.7.2.
    - location and alignment, 4.2.7.3., 4.2.7.4.
  - Definitions of words and phrases, 1.4.1.2.[A], 4.1.3.1.

- Deflections  
 air barrier systems, 5.2.2.1., 5.4.1.1.  
 structure, 4.1.3.5., 4.1.8.13., 9.4.3.
- Deformation resistance, 5.2.2.1., 9.12.2.2., 9.15.1.3.
- Demolition sites, safety measures, 8.1.1.3.
- Depressurization, protection against, 9.32.3.8.
- Design  
 environmental separation, 5  
 HVAC systems, 6.2.1.1., 9.33.1.1., 9.33.4.1.  
 structural, 4, 9.4.
- Design calculations and analyses, 2.2.4.5.[C]
- Designer  
 definition, 1.4.1.2.[A]  
 of parts and components, 2.2.4.4.[C]  
 as reviewer of work, 2.2.7.2.[C], 2.2.7.3.[C],  
 2.2.7.4.[C]  
 signature requirements, 2.2.4.2.[C], 2.2.4.4.[C]  
 structural, requirements for, 2.2.1.2.[C]  
 subsurface inspection, 4.2.2.3., 4.2.2.4., 4.2.4.1.
- Design temperatures  
 indoor, 5.2.1.2., 5.3.1.2., 5.5.1.2., 9.33.3.1.  
 outdoor, 1.1.3.1., 5.2.1.1., 5.3.1.2., 5.5.1.2., 6.2.1.2.,  
 9.33.3.2., 9.33.5.1.
- Detectors  
 carbon monoxide, 6.3.1.4., 6.9.3.1., 9.32.3.8.,  
 9.32.3.9.  
 fire, 1.4.1.2.[A], 3.2.4.4., 3.2.4.10.  
 heat, 1.4.1.2.[A], 9.10.18.3., 9.10.18.4.  
 smoke, 1.4.1.2.[A], 3.1.8.14., 3.2.4.8., 3.2.4.11.,  
 3.2.4.12., 3.2.4.14., 3.2.4.20., 3.2.4.21., 3.6.2.7.,  
 6.9.2.2., 9.10.18., 9.10.18.3., 9.10.18.4., 9.10.18.5.,  
 9.10.21.7.  
 sprinklers installed in lieu of, 9.10.18.4.
- Detention occupancy (see Care, treatment or  
 detention occupancy)
- Deterioration  
 (see also Decay, protection against)  
 due to moisture, 5.5.1.2.  
 resistance to, 5.1.4.2., 9.20.16.1.
- Diaphragms, earthquake design, 4.1.8.15.
- Differential movement  
 columns, 9.17.2.2.  
 decks and other accessible platforms, 9.12.2.2.,  
 9.23.6.2.  
 elements in environmental separation, 5.1.4.1.,  
 5.2.2.1.  
 metal and vinyl cladding, 9.27.5.6.
- Diffusers, 3.6.5.7., 9.33.6.10., 9.33.6.11.  
 (see also Air outlets)
- Dining areas, loads, 4.1.5.6.
- Direct-vented, 1.4.1.2.[A]
- Dispensing rooms, flammable and combustible  
 liquids, 3.3.6.4.
- Distilled beverage alcohol, 1.4.1.2.[A]
- Distilleries, 1.4.1.2.[A], 3.2.5.11.
- Distribution panel, emergency lighting, 3.2.7.10.
- Domes, snow and rain loads, 4.1.6.10.
- Door assemblies  
 as fire-protection closures, 3.1.8.5.  
 leakage rates, 3.1.8.4.
- Door frames  
 caulking, 9.20.13.11.  
 sealant, 9.27.4.1.  
 steel, 9.10.13.6.  
 thermal breaks, 9.7.3.3.  
 wood, 9.10.13.3.
- Doors  
 (see also Closures; Doorways)  
 action of, 9.9.6.4.  
 airtightness, 9.36.2.9., 9.36.2.10.  
 area, calculating, 9.36.2.3.  
 barrier-free path of travel, 3.8.3.6.  
 in bedrooms, 9.9.10.1.  
 containing foamed plastics, 3.1.4.2.  
 in corridors, 3.3.1.13., 3.3.3.3., 9.9.6.1., 9.10.13.  
 dimensions, 3.3.3.4., 9.5.5., 9.9.6.3.  
 direction of swing, 3.3.1.11., 3.3.3.3., 3.4.6.10.,  
 3.4.6.12., 3.6.2.6., 9.9.6.5., 9.10.13.12.  
 between dwelling unit and garage, 9.10.13.15.  
 in dwelling units, 3.1.13.2.  
 emergency crossover access to floor areas, 3.4.6.18.  
 for exits, 3.1.8.14., 3.4.5.1., 3.4.6.11., 3.4.6.12.,  
 3.4.6.16., 9.9.6.  
 exterior, 5.3.1.2., 5.4.1.2., 9.7.4.3., 9.7.5.2.  
 in fire separations, 3.1.8.12. - 3.1.8.15., 3.1.8.17.,  
 3.3.3.5., 9.10.13.  
 flame-spread rating, 3.1.13.2., 3.1.13.7., 9.10.17.1.  
 force required to open, 9.9.6.8.  
 glass or transparent, 3.3.1.19., 3.4.1.8., 9.6., 9.6.1.3.,  
 9.9.4.3.  
 hardware (see Hardware for doors)  
 housing and small buildings, 9.7.  
 incinerator rooms, 3.6.2.6.  
 installation, 9.7.6.  
 at landings, 9.8.6.2.  
 manufactured and pre-assembled, 9.7.4.  
 in means of egress, 3.3.1.13., 3.4.6.10., 3.4.6.11.,  
 9.9.6., 9.9.7., 9.10.13.  
 in means of egress from dwelling units, 9.9.9.  
 in means of egress from suites, 9.9.6., 9.9.7.4.,  
 9.9.7.6., 9.9.8.  
 near steps or stairs, 3.4.6.11., 9.8.6.2., 9.9.6.6.  
 opening onto landings, 9.8.6.3.  
 performance expectations, 9.7.3.  
 power operators, 3.8.2.7., 3.8.3.6.  
 protection, 9.8.8.1.  
 resistance to forced entry, 9.7.5.2.  
 revolving, 3.4.6.15., 9.9.6.4.  
 service rooms, 3.6.2.6., 9.10.13.12.  
 site-built, 9.7.5.  
 sliding (see Sliding doors)  
 in smoke-tight barriers, 9.10.9.3.  
 of solid core wood, 9.10.13.  
 standards for, 5.3.1.2., 5.4.1.2., 9.7.4., 9.10.13.2.  
 storage garages, 9.9.6.4.  
 storage suites, 9.9.6.4.  
 storm, 5.9.2.4., 9.6.1.4., 9.7.3.1., 9.7.3.3.  
 temperature limits, 3.1.8.17.  
 thermal breaks, 5.9.2.4., 9.7.3.3.  
 thermal characteristics, 9.36.2.7.

thresholds, 3.3.1.13., 3.4.6.1., 3.8.3.6., 3.8.3.16.  
water-closet stalls, 3.8.3.11.

Door stops, 9.10.13.16.

Doorways  
(see also Doors)  
barrier-free path of travel, 3.8.3.6.  
bathrooms, 9.5.5.3.  
dimensions, 3.3.3.4., 3.4.3.2., 9.5.5., 9.7.2.2., 9.9.6.2.,  
9.9.6.3.  
between dwelling unit and garage, 9.10.13.15.  
dwelling units, 9.5.5.1.  
headroom clearance, 3.4.3.4.  
at landings, 9.8.6.2., 9.8.6.3.  
means of egress, 3.3.1.5.  
means of egress from dwelling units, 9.9.9.  
means of egress from suites, 3.3.1.3., 3.3.1.5.,  
9.9.7.2., 9.9.7.4., 9.9.7.6., 9.9.8.  
near stairs, 9.8.6.2.  
obstructions, 9.9.6.1., 9.9.6.3.  
at ramp landings, 9.8.6.3.  
secondary suites, 9.5.5.1.  
service rooms, 9.9.5.9.  
water closet rooms, 9.5.5.2.  
width, 3.3.3.4., 3.4.3.2.

Downspouts, 5.6.2.2., 9.14.6.5., 9.26.18.1.

Draft stops, 3.2.8.6.

Drainage  
above-ground masonry walls, 9.20.13.9.  
building envelopes, 5.6.2.2.  
crawl spaces, 9.18.5.  
disposal, 5.6.2.2., 9.14.5.  
evacuation site, 9.14.4.3.  
floors, 9.16.3.3.  
floors-on-ground, 9.16.3.  
footings, 9.14.  
foundations, 9.14.2., 9.35.3.3.  
granular layer installation, 9.14.4.2., 9.14.4.4.  
granular layers, 9.14.2.1., 9.14.4.  
granular material, 9.14.4.1.  
housing and small buildings, 9.14.  
pipes, 9.14.3.  
pipes and tiles installation, 9.14.3.3.  
roofs, 5.6.2.2., 9.26.18.  
second plane of protection, 9.27.3.  
surface water, 5.7., 9.12.3.2., 9.14., 9.14.6.  
tiles, 9.14.3.  
underground ducts, 6.3.2.12., 9.33.6.7.

Drainage systems, sanitary, 1.4.1.2.[A], 9.31., 9.31.2.1.,  
9.31.5.  
(see also Plumbing)

Drain pans, 6.3.2.2.

Drains  
floors, 9.31.4.3.  
from noncombustible water closets, 9.10.9.7.  
roofs, 5.6.2.2., 9.26.18.2.

Drain, waste and vent piping, 3.1.9.5., 9.10.9.7.  
(see also Plumbing)

Draperies, in exits, 9.9.5.6.

Drift limits, earthquake design, 4.1.8.13.

Drilling of framing members, 9.23.5.1.

Drinking fountains, 3.8.2.8., 3.8.3.10.

Dry standpipes, 3.2.5.9.

Dry wells, 9.14.5.3.

Ducts  
access, 3.6.4.5., 6.2.1.6., 9.33.4.4.  
access openings, 6.3.2.4.  
adhesives, 3.6.5.4., 9.33.6.4.  
air filters in, 6.8.1.3.  
aluminum, 9.33.6.5.  
in ceiling spaces, 3.1.9.6., 9.10.5.1.  
cleaning, 6.2.1.6., 9.33.4.4.  
clearances, 3.6.5.6., 6.3.2.6., 9.22.9.4., 9.33.6.8.  
combustible, 3.6.5.1., 9.33.6.2.  
in or beneath concrete slabs, 9.33.6.7.  
connections, 6.3.2.4., 9.33.6.6., 9.33.6.7.  
connectors, 3.6.5.1., 6.3.2.3., 6.3.2.18., 9.33.6.2.  
construction, 9.33.6.6.  
for cooking equipment, 3.1.8.8., 3.1.8.9., 3.6.3.5.  
coverings, 3.6.5.4., 6.3.2.5., 9.10.17.12., 9.33.6.4.  
design, 6.2.3., 9.33.6.1., 9.33.6.5.  
dimensions, 9.32.3.11.  
drainage, 6.3.2.12., 9.33.6.7.  
drain pans, 6.3.2.2.  
exhaust (see Exhaust ducts)  
in exits, 6.9.2.4.  
in fire-rated assemblies, 3.1.9.6., 9.10.5.1., 9.10.9.6.  
fire stops, 9.33.6.6.  
fittings, 6.3.2.3., 9.32.3.11., 9.33.6.2., 9.33.6.5.  
galvanized, 9.33.6.5.  
installation, 6.2.3., 9.33.6.1., 9.33.6.7.  
insulation, 3.6.5.4., 6.3.2.5., 9.32.3.11., 9.33.6.4.  
interconnection, 6.3.2.7., 9.33.6.7.  
joints, 6.3.2.4., 9.32.3.11., 9.33.6.3., 9.33.6.6., 9.33.6.7.  
leakage, 6.3.2.7.  
linings, 3.6.5.4., 6.3.2.5., 9.10.17.12., 9.33.6.4.  
materials, 6.3.2.3., 9.32.3.11., 9.33.6.2.  
metal, 9.33.6.5.  
noncombustible, 3.1.8.8., 3.1.8.9., 3.6.5.1.  
in noncombustible construction, 3.1.5.18.  
penetrating fire blocks, 9.10.16.4.  
penetrating fire separations, 3.1.8.7., 3.1.8.8.,  
3.1.8.9., 3.1.9.2., 9.10.9.6., 9.10.13.13.  
penetrating fire stops, 3.1.11.7.  
return air systems, 1.4.1.2.[A], 3.6.5.8., 6.3.2.11.,  
9.33.6.7., 9.33.6.13.  
sealing, 3.6.5.3., 6.3.2.19., 9.32.3.11., 9.33.6.3.,  
9.33.6.7.  
smoke detectors in, 6.9.2.2.  
supply, 9.32.3.11., 9.33.6.7.  
systems, 6.2.3., 9.33.6.  
trunk, 9.33.6.7.  
underground, 6.3.2.12., 9.33.6.7.  
ventilation, 6.2.3., 9.32.3.11., 9.33.6.2.

Duct-type smoke detectors, 3.2.4.12.

Dumbwaiters, 3.5.1.1., 3.5.2.1., 3.5.3.2.

Dusts, hazardous, 6.9.1.2.

Dwelling units  
(see also Housing and small buildings)  
alarm audibility, 3.2.4.18.  
combustible projections, 3.2.3.6., 9.10.14.5.  
definition, 1.4.1.2.[A]  
doors in means of egress, 9.9.6.

door swing, 3.4.6.12., 9.9.6.5.  
 doorways, 9.5.5., 9.9.6.2., 9.9.6.3.  
 egress, 3.3.4.4., 9.9.9.  
 electrical outlets, 9.34.2.2.  
 exception for combustible projections, 9.10.15.5.  
 fire alarms, 9.10.18.2.  
 fire alarm systems, 3.2.4.1.  
 fire detectors, 3.2.4.10.  
 fire protection, 3.2.2.47. - 3.2.2.54., 9.10.  
 fire-protection closures, 3.1.8.5.  
 fire-resistance rating, 9.10.8.10.  
 fire separations, 3.3.4.2., 9.9.4., 9.10.9.4., 9.10.9.11.,  
 9.10.9.12., 9.10.9.14.  
 firewalls, 9.10.11.2.  
 floors-on-ground, 9.16.1.3.  
 guards, 3.3.4.7., 9.8., 9.8.8.  
 hallways, 9.5.4.1.  
 handrails, 3.3.4.7., 9.8., 9.8.7.  
 height of rooms and spaces, 3.7.1.1., 9.5.3.  
 landings, 9.8.6., 9.8.6.3.  
 manual fire alarm stations, 3.2.4.16.  
 ramps, 9.8., 9.8.5.2.  
 secondary suites, 9.1.2.1.  
 in self-service storage buildings, 3.9.3.1.  
 shared egress facilities, 9.9.9.3.  
 smoke alarms, 3.2.4.20., 9.10.19.  
 sound control, 3.3.4.6., 5.8.1.1., 9.11.  
 spatial separation between houses, 9.10.15.  
 sprinkler systems, 3.2.5.12.  
 stairs, 3.3.4.7., 9.8.  
 travel limit to exits, 9.9.9.1.  
 uniformity of runs in flights with mixed treads,  
 9.8.4.5.  
 water closets, 9.31.4.1.  
**Dynamic procedure**  
 earthquake load and effects calculations, 4.1.8.12.  
 wind load calculations, 4.1.7.8.

## E

**Earthquake design**  
 accidental torsional effects, 4.1.8.12.  
 analysis, 4.1.8.1., 4.1.8.7.  
 anchorage of building frames, 9.23.6.1.  
 bracing to resist lateral loads, 9.23.13.  
 building strength and stability, 4.1.3.2.  
 deflections, 4.1.8.13.  
 direction of loading, 4.1.8.8.  
 dynamic analysis, 4.1.8.12.  
 equivalent static force analysis, 4.1.8.11.  
 fasteners for sheathing or subflooring, 9.23.3.5.  
 foundations, 4.1.8.16., 4.1.8.17.  
 joints in top plates of loadbearing walls, 9.23.11.4.  
 masonry walls, 9.20.1.2., 9.20.15.  
 notation, 4.1.8.2.  
 requirements, 4.1.8.3.  
 roof sheathing, 9.23.16.1.  
 seismic force reduction factors and system  
 overstrength factors, 4.1.8.9.  
 seismic isolation, 4.1.8.19., 4.1.8.20.

site properties, 4.1.8.4.  
 special provisions, 4.1.8.10., 4.1.8.15.  
 structural irregularities, 4.1.8.6.  
 structural separation, 4.1.8.14.  
 supplemental energy dissipation, 4.1.8.21., 4.1.8.22.  
**Eave projections**, 9.10.14.5., 9.10.15.5., 9.26.5.  
**Eave protection**, 9.26.2.1., 9.26.5.1., 9.26.5.2.  
**Effective thermal resistance (RSI value)**, definition,  
 9.36.1.2.  
**Egress (see Doors; Doorways; Means of egress)**  
**Egress doorways**, 3.3.1.5., 3.3.1.6.  
**Electrical conductors**  
 protection of, 3.2.7.10.  
 tests, 3.2.7.10.  
**Electrical equipment**, 3.6.1.2., 9.33.5.2., 9.34.  
**Electrical equipment vaults**, 3.6.2.7.  
**Electrical supervision, fire alarm systems**, 3.2.4.9.  
**Electrical wiring**  
 exit signs, 3.4.5.2.  
 housing and small buildings, 9.34.  
 service facilities, 3.6.1.2.  
**Electric cables, storage**, 3.3.6.2.  
**Electromagnetic locking device**, 3.3.1.13., 3.4.6.16.,  
 3.4.6.18., 9.9.6.7.  
**Elevating devices**, 3.8.2.3., 3.8.3.7.  
**Elevator cables**, 3.1.5.22.  
**Elevator cars, flame-spread rating**, 3.1.13.11.  
**Elevators**  
 application of Code, 3.5.1.1.  
 barrier-free path of travel, 3.3.1.7., 3.8.2.3., 3.8.3.2.,  
 3.8.3.7.  
 dimensions, 3.5.4.1.  
 earthquake design, 4.1.8.18.  
 emergency operation, 3.2.6.4., 3.2.7.9.  
 emergency recall, 3.2.4.14., 3.2.6.4.  
 for firefighters, 3.2.6.5., 3.2.7.9.  
 fire protection, 9.10.1.3.  
 flame-spread rating, 3.1.13.7.  
 high buildings, 3.2.7.9.  
 hoistway noise, 5.8.1.1.  
 hoistways, 3.2.6.4., 3.2.6.6., 3.2.8.4., 3.5.3.1., 3.5.3.3.,  
 3.5.4.2., 9.10.18.4.  
 machine rooms, 3.2.1.1., 3.2.2.14., 3.2.5.12., 3.5.3.3.  
 not a means of egress, 9.9.2.3.  
 smoke detectors, 3.2.4.11., 3.2.4.14.  
 standards, 3.5.2.1., 3.8.3.7.  
**Emergency cables and conductors**, 3.2.7.10.  
**Emergency elevators**, 3.2.6.4., 3.2.6.5., 3.2.7.9.  
**Emergency lighting**, 3.2.7.3., 3.2.7.4., 3.2.7.10., 9.9.12.,  
 9.9.12.3.  
**Emergency power supply**  
 exit signs, 9.9.11.3.  
 installation, 3.2.7.5., 3.6.2.8.  
 lighting, 3.2.7.4., 9.9.12.3.  
 smoke alarms, 9.10.19.4.  
**Emergency return, elevators**, 3.2.4.14., 3.2.6.4.  
**Energy efficiency**  
 building envelope, 9.36.2.  
 definition, 9.36.1.2.  
 energy performance compliance, 9.36.5.  
 housing and small buildings, 9.36.

- HVAC systems and equipment, 9.36.3.
- service water heating systems, 9.36.4.
- Energy performance
  - compliance, 9.36.5.
  - definitions, 9.36.5.2.
  - drawings and specifications, 2.2.8.[C]
- Entrances, barrier-free, 3.8.2.2.
- Environmental loads, 5.1.4.1., 5.2.1., 5.2.1.3., 5.9.3.2.
- Environmental separation
  - air leakage, 9.25., 9.25.3.
  - application of Code, 5
  - compliance with standards, 5.9.1.1.
  - condensation control, 9.25.
  - crawl spaces, 9.18.
  - dampproofing, 9.13., 9.13.2.
  - drawings and specifications, 2.2.5.2.[C]
  - fire (see Fire separations)
  - heat transfer, 9.25., 9.25.2.
  - roof spaces, 9.19.
  - soil gas control, 9.13., 9.13.4.
  - sound control, 5.8.1., 9.11.
  - waterproofing, 9.13., 9.13.3.
- Equipment
  - air-conditioning, 9.33.5.
  - characteristics, 1.2.2.1.[A]
  - cooking, 3.3.1.2., 6.3.1.7., 9.10.1.4., 9.10.13.13.
  - electrical installations, 9.33.5.2., 9.34.1.1.
  - HVAC, 6.1.1.2., 9.33.1.1., 9.33.5.
  - loads on floors and roofs, 4.1.5.3.
  - odour removal, 9.33.6.14.
  - space cooling, 9.33.5.2., 9.33.9.
  - space heating, 9.33.5.2.
  - storage, 1.2.2.2.[A]
  - used, 1.2.2.3.[A]
- Escalators, 3.2.8.2., 3.5.1.1., 3.5.2.1., 3.8.2.4., 9.10.1.3.
  - earthquake design, 4.1.8.18.
- Evaporative air coolers, 6.3.2.16.
- Evaporative condensers, 6.3.2.15.
- Evaporative cooling towers, 6.3.2.15.
- Evaporative fluid coolers, 6.3.2.15.
- Excavations
  - backfill, 9.12.3.
  - definition, 1.4.1.2.[A]
  - depth, 9.12.2.
  - design of, 4.2.5.1.
  - erosion, 4.2.5.6.
  - grading, 9.14.4.3.
  - housing and small buildings, 9.12.
  - native soil, 9.12.1.1.
  - organic material, 9.12.1.1.
  - protection from freezing, 4.2.5.7., 9.12.1.3.
  - safety measures, 8.2.2.
  - structural design, 4.2.5.
  - support of, 4.2.5.3.
  - water control, 4.2.5.5.
  - water in, 8.2.2.1., 9.12.1.2.
- Exhaust
  - capacity, 9.32.3.3., 9.32.3.4., 9.32.3.7.
  - discharge, 6.3.2.10.
  - fans, 9.32.3.7.
  - to garages, 6.3.2.10.
  - intakes, 9.32.3.3., 9.32.3.5., 9.32.3.7.
  - outlets, 3.6.5.7., 6.3.2.10.
  - systems, 3.2.6.6., 3.2.8.7., 3.3.1.20., 9.10.9.18.
- Exhaust air openings, 6.3.2.9.
- Exhaust ducts
  - combining, 6.3.2.10.
  - condensation, 6.3.2.10.
  - definition, 1.4.1.2.[A]
  - fire dampers in, 9.10.13.13.
  - fire dampers waived, 3.1.8.8.
  - insulation, 6.3.2.5., 9.32.3.11., 9.33.6.4.
  - interconnection, 6.3.2.7., 6.3.2.10.
  - laboratory enclosures, 6.3.4.3.
  - serving cooking equipment, 6.3.2.10.
  - serving laundry equipment, 6.3.2.10., 9.32.1.3.
  - serving more than one fire compartment, 9.10.9.18.
  - smoke dampers waived, 3.1.8.9.
  - vertical service spaces, 3.6.3.4.
- Exhibitions, 3.1.2.3.
- Existing buildings, application of Code, 1.1.1.1.[A]
- Exits
  - (see also Means of egress)
  - access to, 3.4.6.17., 9.9.7., 9.9.7.1.
  - aggregate width, 3.4.3.1., 3.4.3.2., 9.9.3.
  - appliances in, 9.9.5.7.
  - balconies, 3.4.4.1.
  - capacity, 3.4.3.2.
  - combustible glazing restrictions, 3.4.1.10.
  - convergence, 3.4.1.2.
  - cumulative width, 3.4.3.2.
  - definition, 1.4.1.2.[A]
  - distance between, 3.4.2.3.
  - door hardware, 3.4.6.16., 3.4.6.17.
  - doors, 3.2.3.13., 3.4.3.3., 3.4.6.11., 3.4.6.13., 3.4.6.16., 9.7.2.2.
  - door swing, 3.4.6.12.
  - ducts in, 6.9.2.4.
  - dwelling units, 3.3.4.4., 9.9.9.
  - emergency access, 3.4.6.18.
  - emergency lighting, 3.2.7.3., 9.9.12.
  - exterior passageways, 3.1.13.10., 3.4.1.5.
  - finish, interior, 9.10.17.
  - fire alarm systems, 3.2.4.1.
  - fire hose connections, 3.2.5.10.
  - fire separations, 3.4.4.1., 9.9.4.
  - from floor areas, 9.9.8.
  - general requirements, 9.9.2.
  - glass block in, 3.2.3.13., 9.9.4.3. - 9.9.4.7.
  - glass doors, 9.6., 9.9.4.3.
  - glass and transparent panels and doors, 3.4.1.8.
  - guards, 3.4.6.6.
  - headroom clearance, 3.4.3.4., 9.8.2.2., 9.9.3.4., 9.9.6.2.
  - horizontal, 3.4.1.4., 3.4.1.6., 9.9.2.1.
  - housing and small buildings, 9.9.
  - integrity, 3.4.4.4., 9.9.4.2.
  - interconnected floor space, 3.2.8.4., 3.4.3.2.
  - landings, 9.8.1.3.
  - level, lowest, and smoke contamination, 3.2.6.2.
  - levels, 1.4.1.2.[A], 3.2.6.2.
  - lighting, 3.2.7.1., 9.9.12.



loads on floor or roof, 4.1.5.3.  
 through lobbies, 3.4.4.2., 9.9.8.5.  
 location, 3.4.2.5., 9.9.8.4.  
 manual fire alarm stations, 3.2.4.16.  
 from mezzanine, 3.4.2.2., 9.9.8.6.  
 minimum number, 3.4.2.1.  
 mirror restrictions, 3.4.1.9., 9.9.5.6.  
 number, 9.9.7.1., 9.9.7.2., 9.9.8.2., 9.9.9.  
 obstructions, 3.4.6.11., 9.9.5., 9.9.5.5., 9.9.6.1.,  
 9.9.6.2., 9.9.11.2.  
 obstructions permitted, 3.4.3.3.  
 protected floor space, 3.2.8.5., 3.4.3.2.  
 purpose, 9.9.2.2.  
 ramps, 3.4.5.2.  
 revolving doors, 3.4.6.15., 9.9.6.4.  
 rooms opening into, 3.4.4.4., 9.9.5.9., 9.9.8.5.  
 secondary suites, 9.9.9.  
 separation, 3.4.1.2.  
 service rooms under, 3.6.2.2., 9.9.5.8.  
 signs, 3.4.5.1., 3.4.5.2., 9.9.11., 9.9.11.3.  
 smoke detectors, 3.2.4.11.  
 stairs, 3.4.5.2., 3.4.6.8., 3.4.6.9., 9.8.1.3., 9.8.2.1.,  
 9.8.3.1.  
 storage garages, 9.9.6.4.  
 storeys, 1.4.1.2.[A], 3.2.6.2.  
 travel distance, 3.4.2.1., 3.4.2.3., 3.4.2.4., 9.9.8.2.  
 types, 3.4.1.4., 9.9.2.1.  
 visibility, 9.9.11.2.  
 wall openings near, 9.9.4.4.  
 weather protection, 3.4.6.11.  
 width, 3.4.3.3., 9.9.3.2., 9.9.3.3., 9.9.8.3.  
 windows, 3.2.3.13., 9.7.2.2., 9.9.4.  
 wired glass in, 3.2.3.13., 9.9.4.3. - 9.9.4.6.

**Expansion and contraction**  
 elements in environmental separation, 5.1.4.1.,  
 5.2.2.1.  
 heating and cooling systems, 6.2.1.3., 9.33.4.6.,  
 9.33.8.1.  
 metal and vinyl siding, 9.27.5.6.  
 piping, 6.7.1.1., 9.33.8.1.  
 structural, 4.1.2.1.

**Explosion venting, 3.3.1.20.**

**Exposing building face**  
 area, 3.2.3.2.  
 area and aspect ratio, 9.10.14.5.  
 area and location, 9.10.14.2., 9.10.15.2.  
 construction, 3.2.3.7., 9.10.14.5., 9.10.15.5.  
 definition, 1.4.1.2.[A]  
 exits, 3.2.3.13.  
 fire resistance waived, 9.10.14.5., 9.10.15.5.  
 first storey facing a street, 9.10.14.4.  
 garage serving a dwelling unit, 9.10.14.5.  
 glazed openings, 9.10.15.2.  
 limiting distance, 3.2.3.5., 3.2.3.6., 3.2.3.7., 9.10.14.5.,  
 9.10.15.5.  
 low-hazard industrial occupancy (Group F,  
 Division 3), 3.2.3.11.  
 in noncombustible construction, 3.1.5.5.  
 protection of, 3.2.3.8.  
 restrictions on combustible projections, 3.2.3.6.,  
 9.10.14.5., 9.10.15.5.

spatial separation between buildings, 9.10.14.,  
 9.10.15.  
 structural members, 3.2.3.9.  
 unlimited openings, 3.2.3.10., 9.10.14.4., 9.10.15.4.  
 unprotected openings, 3.2.3.1., 3.2.3.2., 3.2.3.12.,  
 9.10.14.4., 9.10.15.4.

**Exterior areas, loads on, 4.1.5.5.**

**Exterior insulation finish systems, 5.9.4., 9.27.12.**

**Exterior ornamentations**  
 earthquake loads, 4.1.8.1.  
 wind loads, 4.1.7.11.

## F

**Fabrics, for canopies and marquees, 3.1.16.1.**

**Factories**  
 loads on floor or roof, 4.1.5.3.  
 storage areas, 4.1.5.3.

**Factory-built chimneys, 1.4.1.2.[A], 9.33.10.2.**

**Factory-constructed buildings, 1.1.1.1.[A]**

**Falsework, 4.1.1.3.**

**Fans**  
 access, 6.2.1.6., 9.33.4.4.  
 auxiliary, 9.32.3.4.  
 bathrooms, 9.32.3.3.  
 capacity, 9.32.3.3., 9.32.3.10.  
 controls, 9.32.3.3.  
 cooktops, 9.32.3.7., 9.32.3.11.  
 dehumidistat, 9.32.3.3., 9.32.3.7.  
 emergency power supply, 3.2.7.9.  
 emergency stoppage, 3.2.6.2.  
 exhaust, 9.32.3.3., 9.32.3.5.  
 housing and small buildings, 9.32.3.  
 installation, 6.3.2.17., 9.32.3.3. - 9.32.3.6., 9.32.3.10.  
 kitchens, 9.32.3.3., 9.32.3.7.  
 location, 6.3.2.17., 9.32.3.2.  
 noise, 9.32.3.2.  
 sound ratings, 9.32.3.10.  
 standards for, 9.32.3.10.  
 supplementary exhaust, 9.32.3.7.  
 supply, 9.32.3.4., 9.32.3.5.  
 vibration, 9.32.3.2.

**Farm buildings**  
 application of Code, 1.1.1.1.[A]  
 definition, 1.4.1.2.[A]

**Fasteners**  
 cladding, 9.27.5.4.  
 dimensions, 9.27.5.4.  
 gypsum board, 9.29.5.5.  
 roofing, 9.26.2.3., 9.26.2.4.  
 siding, 9.27.5.4.  
 standard for, 9.23.3.1.  
 stucco, 9.28.3.1., 9.28.3.2.

**Fastening**  
 cladding, 9.27.5.4.  
 furring, 9.29.3.2.  
 gypsum board, 9.29.5.8., 9.29.5.9.  
 hardboard finish, 9.29.7.3.  
 plywood finish, 9.29.6.3.  
 sheathing, 9.23.3.5.

- shingles, 9.26.7.4., 9.26.8.4., 9.26.8.5.
- siding, 9.27.5.4.
- steel framing, 9.24.3.6.
- steel studs, 9.24.1.4.
- stucco lath, 9.28.4.6.
- subflooring, 9.23.3.5.
- underlay, 9.30.2.3.
- wood-frame construction, 9.23.3.
- wood shingles and shakes, 9.26.9.5., 9.26.10.3.
- Faucets and other bathroom accessories, 3.7.2.3., 3.7.2.9., 3.8.3.8., 3.8.3.11., 3.8.3.15., 3.8.3.17.
- Fences, at construction and demolition sites, 8.2.1.3.
- Fenestration
  - (see also Windows)
  - airtightness, 5.9.3.4., 9.36.2.9.
  - area, calculating, 9.36.2.3.
  - definition, 9.36.1.2.
  - heat transfer, 5.9.3.3.
  - resistance to water penetration, 5.9.3.5.
  - structural and environmental loads, 5.9.3.2.
  - thermal characteristics, 9.36.2.2., 9.36.2.7.
  - thermal resistance calculation, 9.36.2.11.
  - types, 5.9.3.1.
  - water penetration, 5.9.3.5.
- Fibreboard
  - fastening, 9.29.8.3.
  - installation, 9.29.8.3., 9.29.8.4.
  - as insulating finish, 9.29.8.
  - material standard, 9.29.8.1.
  - nailing, 9.29.8.3.
  - as roof sheathing, 9.23.16.7.
  - thickness, 9.29.8.2.
  - as wall sheathing, 9.23.17.2., 9.23.17.3.
- Fill
  - (see also Backfill; Backfilling)
  - definition, 1.4.1.2.[A]
  - beneath floors-on-ground, 9.16.2.1., 9.16.2.2.
  - beneath footings, 9.15.3.2.
  - beneath foundations, 4.2.4.13.
- Filters, air, 6.8.1.3., 9.33.6.14.
- Finishes
  - interior (see Interior finishes)
  - slip-resistant, 3.4.6.1.
- Fire alarm and detection systems
  - annunciators, 3.2.4.8.
  - audibility, 3.2.4.18., 3.2.4.21.
  - audible alert and alarm signals, 3.2.4.17.
  - central alarm and control facility, 3.2.6.7.
  - central vacuum shutdown, 3.2.4.13.
  - continuity, 3.2.4.2.
  - design, 9.10.18.3.
  - and door hold-open devices, 3.1.8.14.
  - electrical supervision, 3.2.4.9.
  - emergency power supply, 3.2.7.8.
  - fire detectors, 3.2.4.4., 3.2.4.10.
  - fire separations for, 3.6.2.8.
  - installation, 3.2.4.1., 3.2.4.5., 9.10.18.3.
  - manual stations, 3.2.4.16.
  - requirements, 9.10.18.
  - residential fire warning systems, 3.2.4.21., 9.10.19.8.
  - signal devices, 3.2.4.18.
  - signals to fire department, 3.2.4.7.
  - silencing, 3.2.4.6.
  - single stage systems, 3.2.4.3., 3.2.4.4., 3.2.4.7.
  - smoke alarms, 3.2.4.20.
  - smoke detectors, 3.2.4.11., 3.2.4.12., 9.10.18., 9.10.18.5.
  - sprinkler systems, 3.2.4.8.
  - testing, 3.2.4.5.
  - two-stage systems, 3.2.4.3., 3.2.4.4., 3.2.4.7.
  - types, 3.2.4.3.
  - vacuum cleaning systems, 9.10.18.7.
  - visual signal devices, 3.2.4.19.
  - voice communication systems, 3.2.4.22.
  - waterflow trigger, 3.2.5.14.
- Fire blocks
  - (see also Fire stops)
  - in concealed spaces, 3.1.11., 9.10.16.
  - definition, 1.4.1.2.[A]
  - in eave overhangs, 3.2.3.16.
  - in floor assemblies, 3.1.11.5.
  - in mansard and gambrel roofs, 3.1.11.5., 9.10.16.1.
  - materials, 3.1.11.7., 9.10.16.3.
  - in noncombustible construction, 3.1.5.2., 3.1.11.3.
  - pipes and ducts in, 9.10.16.4.
  - in roof assemblies, 3.1.11.5., 3.1.11.7.
  - in walls/wall assemblies, 3.1.11.2., 9.10.16.2.
- Fire chambers, 9.22.4.
- Fire compartments
  - annunciators, 3.2.4.8.
  - basements, 3.2.1.5.
  - combustible sprinkler piping, 3.2.5.13.
  - definition, 1.4.1.2.[A]
  - exits, 3.2.3.13.
  - exposing building face area, 3.2.3.2.
  - unprotected openings, 3.2.3.1.
  - wall exposed to another wall, 3.2.3.14.
- Fire curtains, 3.3.2.14.
- Fire dampers
  - (see also Dampers)
  - access, 3.1.8.10.
  - as closures, 3.1.8.5.
  - definition, 1.4.1.2.[A]
  - in ducts, 9.10.13.13.
  - in fire separations, 3.1.8.7.
  - in HVAC systems, 6.9.2.1.
  - installation, 3.1.8.10.
  - leakage rates, 3.1.8.4.
  - in non-loadbearing walls, 9.24.3.7.
  - penetrating fire separations, 9.10.9.6.
  - waived, 3.1.8.8.
- Fire department
  - access routes, 3.2.5.4., 3.2.5.6.
  - limiting distance, 9.10.15.3.
  - signals to, 3.2.4.7., 3.2.4.9., 3.2.6.7.
- Fire department connections on buildings, 3.2.5.5., 3.2.5.9., 3.2.5.15.
- Fire detectors, 1.4.1.2.[A], 3.2.4.4., 3.2.4.10.
- Fire escapes
  - access, 3.4.7.3.
  - balconies, 3.4.7.3.
  - closures, 3.4.7.4.

- construction, 3.4.7.2.
- dwelling units, 3.4.7.3.
- existing buildings, 3.4.7.1.
- guards, 3.4.7.6.
- handrails, 3.4.7.6.
- headroom, 3.4.7.5.
- landings, 3.4.7.7.
- loads on, 4.1.5.3.
- as means of egress, 3.4.1.4., 9.9.2.3.
- protection of, 3.4.7.4.
- scope of Code, 3.4.7.1.
- stairs, 3.4.6.8., 3.4.7.5.
- Fire extinguishers, 3.2.5.16., 9.10.20.4., 9.10.21.8.
- Fire extinguishing systems, industrial occupancies, 3.3.5.2.
- Firefighters, 3.2.6.2., 3.2.6.5., 3.2.8.7.
- Firefighting (see Access for firefighting)
- Firefighting services (see Fire department)
- Fire hose cabinets, 3.2.5.11.
- Fire hose nozzles, 3.2.5.11.
- Fire hose stations, 3.2.5.11., 9.10.21.9.
- Fire load, 1.4.1.2.[A], 3.2.2.89., 3.2.3.11.
- Fireplaces
  - airtightness, 9.36.2.9.
  - chimneys, 9.21.2.5., 9.21.2.6.
  - clearances, 9.22.9.
  - combustion air, 9.22.1.4.
  - concrete materials, 9.22.1.2.
  - continuity of insulation, 9.36.2.5.
  - dampers, 9.22.6.1.
  - design and installation, 6.9.4.2.
  - factory-built, 9.22.8.
  - fire chamber, 9.22.4.
  - footings, 9.22.1.3.
  - hearth, 9.22.5.
  - housing and small buildings, 9.22., 9.33.5.4.
  - inserts, 9.22.10.
  - liners (see Liners, fireplace)
  - masonry materials, 9.22.1.2.
  - protection against depressurization, 9.32.3.8.
  - smoke chambers, 9.22.7.
  - walls, 9.22.3.
- Fire protection
  - air-supported structures, 3.1.6.
  - building classification, 3.1.2.
  - combustible construction, 3.1.4.
  - commissioning of life safety and fire protection systems, 9.10.1.2.
  - components, 2.2.3.[C], 3.1.1.4.
  - construction camps, 9.10.21.
  - cooktops, 9.10.22.
  - crawl spaces, 9.18.7.
  - dwelling units, 9.10.
  - electric ranges, 9.10.22.
  - electrical conductors, 3.2.7.10.
  - exceptions, 3.2.2.3.
  - exits, 9.9.4.
  - fire-resistance ratings, 3.1.7.
  - fire safety plan, 1.1.4.
  - gas ranges, 9.10.22.
  - limiting distance and spatial separation between buildings, 3.2.3.1.
  - multiple occupancy requirements, 3.1.3.
  - noncombustible construction, 3.1.5.
  - ovens, 9.10.22.
  - penetrations in fire separations and fire-rated assemblies, 3.1.9.1.
  - propane ranges, 9.10.22.
  - structural, 3.2.2.3.
  - structural members, 3.2.3.9.
  - tents, 3.1.6.
  - testing of integrated fire protection and life safety systems, 9.10.1.2.
  - tests, 3.2.9.1.
- Fire-protection rating
  - of closures, 3.1.8.4., 3.1.8.5.
  - definition, 1.4.1.2.[A]
  - of doors, 3.1.8.12.
  - exceptions, 9.10.13.2., 9.10.13.5., 9.10.13.7.
  - of fire dampers, 3.1.8.7.
  - tests, 3.1.8.4., 9.10.3.1.
- Fire protection systems, 3.2.5.17., 9.10.18., 9.10.20.5.
- Fire pumps, 3.2.4.9., 3.2.5.9., 3.2.5.18., 9.10.1.3.
- Fire-resistance ratings
  - about, 9.10.3.
  - arena-type building roof assemblies, 3.2.2.17.
  - ceilings, 9.10.3.3.
  - definition, 1.4.1.2.[A]
  - determination of, 3.1.7.1., 9.10.3.1.
  - doors, 5.3.1.2.
  - exemptions, 9.10.8., 9.10.8.11., 9.10.14.
  - exits, 9.9.4.2.
  - exposing building face, 3.2.3.7.
  - fire separations, 3.1.7.3.
  - firewalls, 3.1.7.3., 3.1.10.2., 9.10.3.3.
  - floors and floor assemblies, 3.1.7.3., 3.2.1.4., 9.10.3.1., 9.10.3.3., 9.10.8.
  - grease duct enclosures, 3.6.3.5.
  - membrane ceilings, 9.10.3.4.
  - minimum, 3.1.7.4.
  - relation to occupancy and height, 9.10.8.
  - roofs, 9.10.8.
  - separation of suites, 3.3.1.1., 9.10.9.13., 9.10.9.14.
  - steel framing, 9.24.2.4., 9.24.3.2.
  - supporting construction, 3.1.7.5., 9.10.8.3.
  - test methods, 9.10.3.1.
  - vertical fire separations, 9.10.3.3.
  - walls, 9.10.3.3.
  - walls, exterior, 3.1.7.2., 3.1.7.3., 3.2.3.7., 3.2.3.11., 9.10.3.1., 9.10.3.3., 9.10.14.5., 9.10.15.5.
  - walls, interior, 9.10.3.1., 9.10.3.3.
  - walls, loadbearing, 3.1.7.5., 9.10.8.3.
  - windows, 5.3.1.2.
- Fire-retardant-treated wood
  - in assembly occupancy (Group A, Division 2), 3.2.2.25.
  - in assembly occupancy (Group A, Division 3), 3.2.2.32.
  - in business and personal services occupancy (Group D), 3.2.2.60.
  - in combustible construction, 3.1.4.5., 3.1.4.8.

- for decorative cladding, 3.1.5.24.
- definition, 1.4.1.2.[A]
- in low-hazard industrial occupancy (Group F, Division 3), 3.2.2.83.
- in medium-hazard industrial occupancy (Group F, Division 2), 3.2.2.76.
- in mercantile occupancy (Group E), 3.2.2.66.
- in noncombustible construction, 3.1.5.5., 3.1.5.12., 3.1.13.8.
- in roof systems, 3.1.14.1.
- Fire safety
  - and building size, 3.2.1.1., 9.10.8.
  - construction sites, 8.1.1.1.
  - demolition sites, 8.1.1.1.
  - in HVAC systems and equipment, 6.9.1.1., 9.33.6.
  - and occupancy, 9.10.8.
  - self-service storage buildings, 3.9.2.
  - tests, 3.2.9.1.
- Fire separations
  - airtightness of windows and doors in, 5.4.1.2.
  - barrier-free floor areas, 3.3.1.7.
  - boarding and lodging houses, 9.10.9.14.
  - on building face, 3.2.3.2.
  - business and personal services occupancy, 3.3.1.1.
  - care, treatment or detention occupancy, 3.3.3.1.
  - closures in, 3.1.8.1., 3.1.8.4., 3.1.8.5., 9.10.13.
  - in combustible construction, 3.1.8.2.
  - construction camps, 9.10.21.2.
  - containment in basements, 3.2.1.5.
  - continuity, 3.1.8.1., 3.1.8.3., 9.10.9.2., 9.10.11.2.
  - crawl spaces, 3.2.2.9., 9.10.9.4.
  - definition, 1.4.1.2.[A]
  - and door hold-open devices, 3.1.8.14.
  - and door self-closing devices, 3.1.8.13.
  - dumbwaiters, 3.5.3.2.
  - dwelling units, 3.3.4.2., 9.10.9.11., 9.10.9.12., 9.10.9.13.
  - elevator machine rooms, 3.5.3.3.
  - elevators, 3.2.6.5., 3.5.3.1.
  - exits, 3.4.4.1., 9.9.4.
  - fire dampers in, 3.1.8.7.
  - fire-resistance rating, 3.1.7.3.
  - firewalls, 3.1.10.1.
  - floor assemblies, 3.3.4.2.
  - floors over basements, 3.2.1.4.
  - garages, 9.10.4.3., 9.10.9.16., 9.10.9.17.
  - grease duct enclosures, 3.6.3.5.
  - horizontal, 3.1.8.8.
  - in horizontal service spaces, 3.1.8.3.
  - horizontal service spaces, 3.6.4.2., 9.10.9.10.
  - industrial occupancy (group F), 3.3.5.1., 9.10.9.11., 9.10.9.12., 9.10.9.16., 9.10.9.17.
  - integrity, 9.10.9.3.
  - interconnected floor spaces, 9.10.9.5.
  - interior walls, 9.10.12.3.
  - laboratory ventilation enclosures, 3.3.1.20.
  - libraries, 3.3.2.13.
  - and major occupancy, 9.10.9.11., 9.10.9.16., 9.10.9.17.
  - meeting of two exterior walls, 9.10.12.3.
  - mercantile occupancy (group E), 3.3.1.1.
  - mezzanines, 3.2.8.1.
  - and multiple occupancies, 3.1.3.1., 9.10.9.11., 9.10.10.
  - between openings, 3.2.3.17.
  - openings in, 3.1.8.1., 3.1.8.6., 3.1.8.17., 3.2.8.2., 9.10.13., 9.24.3.7.
  - openings protected by glass blocks or wired glass, 3.1.8.16.
  - operating, recovery and delivery rooms, 3.3.3.6.
  - protected floor spaces, 3.2.8.5.
  - public corridors, 3.3.1.4., 9.10.9.15.
  - rating, 9.10.3.
  - repair garages, 3.3.5.5.
  - residential occupancy (Group C), 3.2.2.47., 3.3.4.2., 9.10.9.11., 9.10.9.12., 9.10.9.14.
  - roof-top enclosures, 3.2.2.14.
  - between rooms and spaces within buildings, 9.10.9.
  - secondary suites, 9.10.9.4., 9.10.9.14., 9.10.9.15., 9.10.10.4., 9.10.11.2., 9.10.12.3.
  - self-service storage buildings, 3.9.3.1.
  - self-storage warehouses, 3.3.5.9.
  - service penetrations, 3.1.9.2. - 3.1.9.6., 9.10.9.6.
  - service rooms, 3.6.2.1., 9.10.8.5., 9.10.10.
  - soffit protection, 9.10.12.4.
  - steel framing, 9.24.2.4., 9.24.3.7.
  - storage of dangerous goods, 3.3.6.2.
  - storage garages, 3.2.1.2., 3.3.4.2., 3.3.5.6., 3.3.5.7.
  - storage rooms, 3.3.4.3., 9.10.10.6.
  - storeys below ground, 3.2.2.15.
  - suites, 3.3.1.1., 3.3.4.2., 9.10.9.13., 9.10.9.14.
  - temperature rise and area limits, 3.1.8.19.
  - theatre stages, 3.3.2.14.
  - thermal breaks in windows and doors in, 5.3.1.2.
  - twenty-minute closures, 3.1.8.12.
  - vehicular passageways, 3.2.3.18.
  - vertical, 3.1.8.8., 3.1.8.9.
  - vertical service spaces, 3.6.3.1.
  - in vertical shafts, 3.1.8.3.
  - vestibules, 3.2.8.4.
  - walkways, 3.2.3.19., 3.2.3.20.
  - wall exposed to another wall, 3.2.3.14.
  - watertightness of windows and doors in, 5.9.2.3.
  - between zones in hospitals or nursing homes, 3.3.3.5.
- Fire stop flaps, 1.4.1.2.[A], 3.6.4.3., 9.10.13.14.
- Fire stops
  - (see also Fire blocks)
  - definition, 1.4.1.2.[A]
  - in noncombustible construction, 3.1.5.2.
  - pipes and ducts in, 3.1.9.5., 9.10.9.6., 9.33.6.6.
  - and service penetrations, 3.1.9.1., 9.10.9.7.
- Firewalls
  - combustible projections, 3.1.10.7.
  - construction, 9.10.11.
  - continuity, 3.1.10.3.
  - continuity of insulation, 9.36.2.5.
  - definition, 1.4.1.2.[A]
  - exemptions, 9.10.11.2.
  - exterior walls meeting at, 3.1.10.6.
  - and fire alarm systems, 3.2.4.2.

- fire-resistance rating, 3.1.7.3., 3.1.10.2., 9.10.3.3., 9.10.11.3.
- maximum openings in, 3.1.10.5.
- mezzanines, 3.2.8.1.
- parapets, 3.1.10.4.
- party walls as, 9.10.11.1.
- penetrations in, 3.1.9.1.
- separating buildings, 1.3.3.4.[A]
- structural stability, 3.1.10.1., 4.1.5.17.
- support of, 3.1.10.1., 4.1.5.17.
- First storey, 1.4.1.2.[A], 3.2.2.15., 3.2.5.1., 3.2.8.2.
- Fixed seats, 3.3.2.4.
- Fixed seats, bench type without arms, 3.3.2.8.
- Flags, for directing traffic, 8.2.4.2.
- Flame-spread rating
  - bathrooms, 3.1.13.3., 9.10.17.11.
  - business and personal services occupancy, 9.10.17.
  - combustible insulation, 9.10.17.10., 9.10.17.12.
  - combustible piping, 3.1.5.19.
  - combustible skylights, 9.10.17.9.
  - corridors, 9.10.17.2., 9.10.17.5.
  - crawl spaces, 9.18.7.1.
  - definition, 1.4.1.2.[A]
  - diffusers and grilles, 9.33.6.10.
  - doors, 3.1.13.2., 9.7.2.2., 9.10.17.1.
  - ducts, linings and coverings, 9.10.17.12., 9.33.6.4.
  - elevator cars, 3.1.13.7., 3.1.13.11.
  - exits, 3.1.13.2., 3.1.13.7., 3.1.13.8., 9.10.17.2.
  - exterior exit passageways, 3.1.13.10., 9.10.17.4.
  - fire-retardant-treated wood, 3.1.4.5.
  - firewalls, 9.10.11.3.
  - foamed plastic insulation, 3.1.5.15., 9.10.17.10.
  - glazing, 3.1.5.4., 3.1.13.2., 9.10.17., 9.10.17.1., 9.10.17.6., 9.10.17.9.
  - gypsum board, 9.29.5.2.
  - high buildings, 3.1.13.7.
  - industrial occupancy, 9.10.17.
  - insulation, 5.9.1.1., 9.25.2.2.
  - insulation in concealed spaces, 9.10.17.
  - insulation in noncombustible construction, 3.1.5.14., 3.1.5.15.
  - interior finishes, 3.1.5.12., 9.10.17.
  - light diffusers and lenses, 3.1.13.4., 9.10.17.6., 9.10.17.8.
  - lobbies, 3.1.13.2., 9.10.17.3.
  - mercantile occupancy, 9.10.17.
  - public corridors, 3.1.13.6., 9.10.17.
  - residential occupancy, 3.1.13.3., 9.10.17.
  - service rooms, 3.1.13.7., 9.10.17.
  - skylights, 3.1.5.4., 3.1.13.2., 9.7.2.2., 9.10.17., 9.10.17.1., 9.10.17.6., 9.10.17.9.
  - tests, 3.1.12.1., 9.10.3.2.
  - vehicular passageways, 3.1.13.2.
  - ventilated laboratory enclosures, 6.3.4.4.
  - vestibules, 3.1.13.7.
  - windows, 9.7.2.2.
- Flammable gases (see Combustible gases)
- Flammable liquids
  - definition, 1.4.1.2.[A]
  - door thresholds, 3.3.1.13., 3.4.6.1.
  - piping for, in trench, 6.9.1.2.
  - storage, 3.3.2.16., 3.3.4.3., 3.3.6.2.
  - storage and dispensing rooms, 3.3.6.4.
- Flashing, chimney
  - caps, 9.21.4.6.
  - junctions with other materials, 9.21.4.10.
- Flashing, doors, 9.7.6.2.
- Flashing, roof
  - built-up-roofing at cant strips, 9.26.11.10.
  - built-up-roofing to masonry, 9.26.4.6.
  - built-up-roofing to other than masonry, 9.26.4.7.
  - at intersections, 9.26.4.
  - materials, 9.26.2.1., 9.26.4.2., 9.26.4.3.
  - purpose, 9.26.1.2.
  - sealing and drainage, 5.6.2.1.
  - shingles to masonry, 9.26.4.4.
  - shingles to other than masonry, 9.26.4.5.
  - valley, 9.26.4.3.
- Flashing, skylights, 9.7.6.2.
- Flashing, wall
  - cavity walls, 9.20.13.5., 9.20.13.6.
  - fastening, 9.20.13.2.
  - installation, 9.20.13.3., 9.27.3.8.
  - masonry veneer, 9.20.13.6.
  - masonry walls, 9.20.13.
  - materials, 9.20.13.1., 9.27.3.7.
  - sealing and drainage, 5.6.2.1.
  - stucco, 9.28.1.5.
- Flashing, windows, 9.7.6.2., 9.20.13.3., 9.20.13.4.
- Flash point, 1.4.1.2.[A]
- Flat roofs, wind loads, 4.1.7.6.
- Flight, 1.4.1.2.[A]
  - (see also Stairs)
- Floor areas
  - barrier-free design, 9.5.2.
  - barrier-free path of travel, 3.3.1.7.
  - care, treatment or detention occupancy, 3.3.3.1.
  - combination rooms, 9.5.1.2.
  - definition, 1.4.1.2.[A]
  - emergency access, 3.4.6.18.
  - general requirements, 3.3.1.
  - secondary suites, 9.1.2.1.
  - self-service storage buildings, 3.9.3.
  - separation of suites, 3.3.1.1.
  - termination, 9.10.12.1.
- Flooring
  - ceramic tile, 9.23.15.5., 9.30.6.
  - finish, 9.30.1.4.
  - in hazardous materials storage area, 3.3.6.7.
  - housing and small buildings, 9.30.
  - parquet, 9.30.4.
  - supports, 9.30.1.3.
  - underlay, 9.30.2.
  - water-resistant membranes, 9.30.1.2.
  - wood strip, 9.23.15.5., 9.30.3.
- Floor joists, support of, 9.15.5.1.
- Floor numbers
  - Arabic numerals, 3.4.6.19., 9.9.11.5.
  - elevator hoistways, 3.5.4.2.
  - exits, 3.4.6.19., 9.9.11.5.
- Floors
  - acting as diaphragms, 4.1.8.15., 4.1.8.18.

- air barrier systems, 9.25.3.
- anchorage, 9.20.11.1.
- cantilevered, 9.23.9.9.
- combustible elements in noncombustible construction, 3.1.5.10.
- concrete topping, 9.23.4.4.
- construction camps, 9.10.21.3.
- dampproofing, 9.13.2.1.
- drains, 9.31.4.3.
- fire-resistance ratings, 3.1.7.3., 9.10.3.1., 9.10.8.1., 9.10.8.8.
- as fire separations, 9.10.9.4.
- framing, 9.23.4.
- garages, 9.35.2.2.
- in heavy timber construction, 3.1.4.7.
- joists, 9.23.4.1., 9.23.4.2., 9.23.4.4., 9.23.9.
- loads due to use of, 4.1.5.
- loads on, 9.23.1.1., 9.23.4.1., 9.23.4.2., 9.23.4.4.
- subfloors, 9.23.15.
- supports, 3.2.1.4., 9.30.1.3.
- thermal insulation, 9.25.1.1.
- vibrations, 4.1.3.6.
- Floors on ground, thermal resistance, 9.36.2.8.
- Floors-on-ground
  - concrete, 9.16.4.
  - dampproofing, 9.13.2.1., 9.13.2.6.
  - drainage, 9.16.3.
  - hydrostatic uplift, 9.16.3.2.
  - in dwelling units, 9.16.1.3.
  - in housing and small buildings, 9.16.
  - material beneath, 9.16.2.
  - soil gas control, 9.13.4., 9.25.3.6.
- Flue collars, 1.4.1.2.[A]
- Flue pipes, 1.4.1.2.[A], 9.21.1.2.
- Flues, chimney
  - connections, 9.21.2.2.
  - definition, 1.4.1.2.[A]
  - dimensions, 9.21.2.4., 9.21.2.5., 9.21.4.4.
  - fireplace, 9.21.2.5.
  - inclination, 9.21.2.3.
  - masonry and concrete, 9.21.
  - oval, 9.21.2.6.
  - rectangular, 9.21.2.5.
  - round, 9.21.2.5.
  - slope, 9.21.2.3.
  - standard for, 9.21.2.
- Foamed plastic
  - dampproofing, 9.13.2.5.
  - insulation, 3.1.5.14., 3.1.5.15., 3.6.3.2., 5.3.1.3., 9.10.17.10., 9.25.2.2., 9.33.6.4.
  - in noncombustible construction, 3.1.5.2., 3.1.5.7., 3.1.5.14., 3.1.5.15.
  - protection of, 3.1.4.2., 9.10.17.10.
  - vapour barrier, 9.25.4.2.
- Footbridges, 4.1.5.3.
- Footings
  - area for column spacing, 9.15.3.3., 9.15.3.4., 9.15.3.7.
  - chimneys, 9.15.3.1., 9.21.4.3.
  - design, 9.4.4.1.
  - dimensions, 9.15.3.
  - drainage, 9.14.
  - fireplaces, 9.15.3.1., 9.22.1.3.
  - granular drainage layer, 9.14.4.
  - housing and small buildings, 9.15.
  - non-loadbearing masonry walls, 9.15.3.6.
  - projections, 9.15.3.8.
  - stepped, 9.15.3.9.
  - thickness, 9.15.3.8.
  - trenches, 9.12.4.1.
  - width, 9.15.3.3., 9.15.3.4., 9.15.3.5., 9.15.3.6., 9.15.3.8.
- Forced-air furnace, 1.4.1.2.[A]
- Forced-air heating systems
  - (see also Ducts; Heating systems and equipment)
  - coupled with heat recovery ventilators, 9.32.3.12.
  - ventilation systems coupled with, 9.32.3.4.
  - ventilation systems not coupled with, 9.32.3.5.
- Formwork, 4.1.1.3.
- Foundations
  - adfreezing, 4.2.4.4.
  - backfilling, 4.2.5.8., 9.12.3.
  - capacity in weaker soil or rock, 9.4.4.2.
  - of concrete, 4.2.3.5., 9.3.1.6., 9.3.1.7., 9.15.1.1., 9.15.2., 9.15.4.
  - of concrete block, 9.15.4.2.
  - dampproofing, 9.13.2.
  - deep, 1.4.1.2.[A], 4.2.7.
  - definition, 1.4.1.2.[A]
  - for deformation-resistant buildings, 9.12.2.2., 9.15.1.3.
  - depth, 4.2.4.4., 9.12.2.
  - design, 4.2.4., 9.4.4., 9.15.1.1.
  - drainage, 9.14.2., 9.35.3.3.
  - drawings and specifications, 2.2.4.6.[C], 2.2.4.7.[C], 4.2.2.2.
  - dynamic loading, 4.2.4.7.
  - earthquake design, 4.1.8.16., 4.1.8.17.
  - eccentric loading, 4.2.4.6.
  - equivalent approaches to design, 4.1.1.5.
  - excavations, 4.2.5., 9.12.
  - extension above ground, 9.15.4.6.
  - on filled ground, 4.2.4.13.
  - of flat insulating concrete forms, 9.15.1.1., 9.15.3.3., 9.15.4., 9.15.4.5.
  - footing size, 9.15.3.
  - frost action, 4.2.4.4., 9.12.2.2.
  - on frozen ground, 9.12.1.3.
  - for garages and carports, 9.35.3.
  - granular drainage layer, 9.14.4.
  - and groundwater level, 4.2.4.9., 9.4.4.3.
  - for housing and small buildings, 9.15.
  - hydrostatic pressure, 4.2.4.8., 9.16.3.2.
  - insulation, 9.25.2.2., 9.25.2.3.
  - lateral support, 9.15.4.2., 9.15.4.3., 9.15.4.4., 9.15.4.5.
  - limit states design, 4.2.4.1.
  - loads, 4.2.4.1.
  - of masonry, 4.2.3.3., 4.2.3.4., 9.15.1.1., 9.15.2., 9.15.4., 9.15.4.10.
  - materials, 4.2.3., 9.15.2.
  - movement, 4.2.4.1., 9.12.2.2.
  - on organic soils, 9.12.1.1.
  - on permafrost, 4.2.4.10., 9.15.1.2.
  - of permanent form material, 9.15.4.1.

pier type, 9.15.2.3.  
 protection from surface water, 5.7.1.1.  
 review, 4.2.2.3.  
 on rock, 9.15.3.1., 9.15.3.2.  
 shallow, 1.4.1.2.[A], 4.2.6.  
 site stability, 4.1.8.17.  
 on sloping ground, 4.2.4.5.  
 special, 4.2.8.  
 stairs with, 9.12.2.2.  
 of steel, 4.2.3.7.  
 structural design, 4.2.4.14.  
 subsurface investigation, 4.2.2.1., 4.2.4.2.  
 supporting floor joists, 9.15.5.1.  
 on swelling and shrinking soils, 4.2.4.11., 9.4.4.4.  
 thermal resistance, 9.36.2.8.  
 thickness, 9.15.4.2., 9.15.4.7.  
 trenches beneath, 9.12.4.  
 vertical reinforcement, 9.15.4.6.  
 walls, 9.4.4.6., 9.15.4., 9.36.2.8.  
 of wood, 4.2.3.1., 4.2.3.2., 9.15.1.1., 9.15.2.4.  
 for wood-frame construction, 9.15.1.1., 9.15.2.4.

**Foundation units**  
 definition, 1.4.1.2.[A]  
 drawing alterations, 2.2.4.7.[C]

**Framing**  
 anchorage, 9.23.6.  
 ceiling, 9.23.14.  
 drilling, 9.23.5.1.  
 maximum spans, 9.23.4.  
 notching, 9.23.5.2.  
 over openings, 9.23.12.  
 roof, 9.23.14.  
 sheet steel stud, 9.24.  
 supported on masonry or concrete, 9.20.8.  
 trusses, 9.23.14.11.  
 wood-frame construction, 9.23.

**Freezers, walk-in, 3.1.4.2., 3.1.5.7., 9.10.17.10.**

**Freezing, protection from (see Protection from freezing)**

**Frost action**  
 (see also Frost penetration, depth; Protection from freezing)  
 definition, 1.4.1.2.[A]  
 floors-on-ground, 9.16.2.2.  
 soil under foundations, 9.4.4.4.

**Frost penetration, depth, 1.1.3.2., 9.12.2.2.**

**Fuel dispensing facilities, 3.3.5.8., 9.10.1.3.**

**Fuel supply, shut-off valves, 3.2.7.7.**

**Functional statements**  
 application, 3.1.[A]  
 list of, 3.2.1.[A]

**Furnaces**  
 capacity, 9.33.3.1., 9.33.5.1.  
 clearances, 6.2.1.5., 9.33.5.2., 9.33.6.8.  
 definition, 1.4.1.2.[A]  
 forced-air, 1.4.1.2.[A]  
 installation, 6.2.1.6., 9.33.5.2.  
 performance requirements, 9.36.3.10.  
 plenums, 9.33.6.6., 9.33.6.7., 9.33.6.8.

**Furring**  
 cladding, 9.27.5.3.

dimensions, 9.29.3.1.  
 fastening, 9.29.3.2.  
 interior finish, 9.29.3.  
 metal thickness, 9.24.1.3.  
 nailing, 9.29.3.2.  
 stucco lath, 9.28.4.4.

## G

**Gable roofs**  
 snow and rain loads, 4.1.6.9.  
 wind loads, 4.1.7.6.

**Galvanized sheet metal, 9.3.3.2.**

**Gambrel roof**  
 fire blocks, 9.10.16.1.  
 venting, 9.19.1.4.

**Garages**  
 (see also Carports)  
 clear height, 3.3.5.4.  
 columns, 9.35.4.2., 9.35.4.3.  
 detached, 9.10.14.4., 9.10.14.5., 9.10.15.4., 9.10.15.5., 9.35.3.3.  
 doors, 9.10.13.15., 9.36.2.9.  
 for dwelling units, 9.7.5.2., 9.10.9.16., 9.35.  
 exhaust discharge into, 6.3.2.10.  
 floors, 9.3.1.6., 9.35.2.2.  
 foundations, 9.35.3.  
 guards and guardrails, 9.8.8.4.  
 interconnection of ducting, 6.3.2.7., 9.33.6.7.  
 lighting, 9.34.2.6.  
 loads on floor or roof, 4.1.5.3.  
 open-air, 9.10.14.4.  
 pressure, 6.3.1.4.  
 repair (see Repair garages)  
 resistance to forced entry, 9.7.5.2.  
 storage (see Storage garages)  
 ventilation, 3.3.5.4., 6.3.1.4., 9.32.1.1.  
 walls, 9.35.4.1., 9.35.4.3.

**Gas-burning equipment, installation standard, 6.2.1.5., 9.33.5.2.**

**Gases, hazardous, 6.9.1.2.**

**Gas mains, under buildings, 3.2.3.21.**

**Gas vents**  
 definition, 1.4.1.2.[A]  
 materials and installation, 9.33.10.1.  
 sealing around, 9.25.3.3.

**Girders, in heavy timber construction, 3.1.4.7.**

**Glass**  
 (see also Transparent panels)  
 area limits, maximum, 9.6.1.3.  
 design, 9.6.1.3.  
 doors, 3.3.1.19., 9.6.1.4., 9.7.5.2.  
 earthquake design, 4.1.8.18.  
 in exits, 3.4.1.8.  
 in fire separations, 3.2.3.13., 5.3.1.2., 9.10.13.5.  
 in guards, 9.8.8.7.  
 panels, 3.3.1.19.  
 public areas, 9.6.1.4., 9.7.5.  
 safety (see Safety glass)

- sidelights, 9.6.1.4.
- standards for, 5.9.1.1., 9.6.1.2., 9.6.1.3., 9.6.1.4., 9.7.5.2., 9.8.8.7.
- structural design basis, 4.3.6.
- structural strength, 9.6.1.3.
- thermal breaks, 5.9.2.4., 9.7.3.3.
- thickness, 9.6.1.3.
- types of, 9.6.1.4.
- wired (see Wired glass)
- Glass block assemblies, thermal characteristics, 9.36.2.7.
- Glass blocks
  - area limits, 3.1.8.18.
  - as closures, 3.1.8.5., 9.10.13.7.
  - excluding, and temperature limits, 3.1.8.19.
  - in exits, 9.9.4.3. - 9.9.4.6.
  - in fire separations, 3.1.8.16.
  - not to be used as closures, 3.2.3.5.
  - not in fireplaces or chimneys, 9.20.2.3.
  - protection of exit facilities, 3.2.3.13.
  - reinforcing, 9.20.9.6.
  - in unprotected openings, 3.2.3.12., 9.10.14.4.
- Glass-reinforced polyester roofing, 9.26.14.1.
- Glazed architectural structures (see Fenestration)
- Glazed openings, 9.10.15., 9.10.15.2., 9.10.15.4.
- Glazing
  - in doors, 9.7.1.1.
  - exit restrictions, 3.4.1.10.
  - in fire separations, 3.1.8.16.
  - in noncombustible construction, 3.1.5.4.
  - in public areas, 9.8.8.1.
  - in unprotected openings, 3.2.3.12.
  - wired glass, 3.1.8.16., 3.1.8.18., 3.1.8.19., 3.2.3.5.
- Glued-laminated timber
  - beams, 9.23.4.1., 9.23.4.2., 9.23.4.4.
  - flooring, 3.1.4.7.
  - lintels, 9.23.12.3.
- Grab bars
  - bathtubs, 3.7.2.9., 3.8.3.17.
  - loads on, 9.31.2.3.
  - showers, 3.8.3.16.
  - universal washrooms, 3.8.3.12.
  - washrooms, 3.7.2.8., 3.8.3.11.
- Grade, 1.4.1.2.[A], 3.2.3.18., 3.2.5.1.
- Grading, site
  - backfill, 9.8.10.3., 9.12.3.2.
  - environmental separation, 5.1.2.1.
  - excavations, 9.14.4.3.
  - surface drainage, 9.14.6.
  - water control, 5.7.1.1., 9.16.3., 9.18.5.
- Granular material
  - beneath floors-on-ground, 9.16.1.1., 9.16.2.1.
  - beneath footings and foundations, 9.14.2.1., 9.14.4.
- Grease duct enclosures, 3.6.3.5.
- Ground cover
  - crawl spaces, heated, 9.18.6.2.
  - crawl spaces, unheated, 9.18.6.1.
  - warm-air plenums, 9.18.7.1.
- Groundwater
  - around excavations, 4.2.5.5.
  - definition, 1.4.1.2.[A]
  - and foundations, 2.2.4.6.[C], 4.2.2.1., 4.2.2.4., 4.2.4.3., 4.2.4.9.
  - level, 1.4.1.2.[A], 4.2.4.9., 9.4.4.3., 9.14.5.3., 9.15.3.4., 9.16.3.1.
  - protection from, 5.7.3.
- Group A occupancy (see Assembly occupancy)
- Group B occupancy (see Care, treatment or detention occupancy)
- Group C occupancy (see Residential occupancy)
- Group D occupancy (see Business and personal services occupancy)
- Group E occupancy (see Mercantile occupancy)
- Group F occupancy (see Industrial occupancy)
- Grout, 9.20.3.2.
- Guards (devices)
  - balconies and decks, 4.1.7.5., 9.8.8.1., 9.8.8.3.
  - cane-detectable, on doors, 3.8.3.6.
  - definition, 1.4.1.2.[A]
  - doorways, 9.8.8.1.
  - dwelling units, 3.3.4.7., 9.8.1.
  - exits, 3.4.6.6.
  - fire escapes, 3.4.7.6.
  - fixed seats, 3.3.2.9.
  - garages, 3.3.5.4., 9.8.8.4.
  - glass, 9.8.8.7.
  - height, 3.3.1.18., 3.3.5.4., 3.4.6.6., 9.8.8.3.
  - housing and small buildings, 9.8.8.
  - industrial occupancies, 3.3.5.10.
  - landings, 3.4.6.6., 9.8.8.3.
  - loads, 3.3.5.4., 4.1.5.14., 9.8.8.2., 9.8.8.4.
  - means of egress, 9.9.1.1.
  - to not facilitate climbing, 9.8.8.6.
  - openable windows, 3.3.4.8.
  - openings through, 3.3.1.18., 3.4.6.6., 3.4.7.6., 9.8.8.5.
  - porches, 9.8.8.3.
  - as protection for vehicles, 4.1.5.15.
  - ramps, 3.4.6.6., 3.8.3.5., 9.8.8.1., 9.8.8.4.
  - secondary suites, 9.8.1.
  - stairs, 3.4.6.6.
  - where required, 9.8.8.1.
  - windows in public areas, 3.3.1.19.
  - windows in residential occupancy, 9.8.8.1.
- Guards (human), for danger zones, 8.2.1.4.
- Gypsum board
  - application standard, 9.29.5.1.
  - on exposing building face, 3.2.3.7.
  - fasteners for, 9.29.5.5.
  - fastening, 9.29.5.8., 9.29.5.9.
  - as fire separation in exit, 9.9.4.2.
  - as fire stop, 3.1.11.7.
  - installation, 9.29.5.3., 9.29.5.8., 9.29.5.9.
  - as interior finish, 9.29.5.
  - material standard, 9.29.5.2.
  - in noncombustible construction, 3.1.5.13.
  - standards, 9.10.9.2.
  - as thermal barrier, 3.1.5.14., 3.1.5.15.
  - as wall sheathing, 9.23.17.2., 9.23.17.3.
- Gypsum lath, 9.29.4.1.



## H

Hallways (see Corridors)

Handrails

- in aisles with steps, 3.3.2.10.
- attachment, 9.8.7.7.
- continuity, 3.4.6.5., 9.8.7.2.
- design, 9.8.7.7.
- in dwelling units, 3.3.4.7., 9.8.1., 9.8.7.1.
- ergonomic design, 9.8.7.5.
- graspability, 3.4.6.5., 9.8.7.5.
- height, 3.4.6.5., 9.8.7.4.
- in housing and small buildings, 9.8.7.
- loads, 3.4.6.5., 4.1.5.14., 9.8.7.7.
- in means of egress, 9.9.1.1.
- projecting into means of egress, 3.4.3.3.
- projecting into stair or ramp, 9.8.7.6.
- for ramps, 3.4.6.5., 3.8.3.5., 9.8.7.
- in secondary suites, 9.8.1., 9.8.7.
- for stairs, 3.4.6.5., 3.4.6.9., 9.8.7.
- termination, 9.8.7.3.

Hardboard

- as cladding, 9.27.2.4., 9.27.3.6., 9.27.5.
- fastening, 9.29.7.3.
- as insulating finish, 9.25.5.1.
- as interior finish, 9.29.7.
- material standards, 5.9.1.1., 9.27.9.1., 9.29.7.1.
- nailing, 9.29.7.3.
- as siding, 9.27.2.4., 9.27.3.6., 9.27.9.
- thickness, 9.3.2.7., 9.29.7.2.
- as underlay, 9.30.2.2.
- as wall sheathing, 9.25.5.1.

Hardware for doors

- access to exit, 3.3.1.13.
- automatic locking devices, 3.3.4.5.
- bolts, 9.7.5.2.
- closers in barrier-free path of travel, 3.8.3.6.
- closures, 3.1.8.5.
- door release devices, 3.3.1.13., 3.3.2.7., 3.4.6.16., 9.9.6.7.
- height, 3.4.6.16.
- hinges, 9.7.5.2.
- hold-open devices, 3.1.8.14., 9.10.13.11.
- locks and latches, 3.3.1.13., 3.4.6.16., 3.4.6.17., 3.4.6.18., 9.7.5.2., 9.9.6.7., 9.9.6.8., 9.10.13.9.
- power operators, 3.8.3.6.
- self-closing devices, 3.1.8.13., 3.4.6.13., 9.9.6.7., 9.10.13.10., 9.10.13.15.
- strikeplates, 9.7.5.2.
- on transparent doors and panels, 3.3.1.19.
- universal washrooms, 3.8.3.12.

Hatchways, 9.19.2.1., 9.25.3.3.

Hazardous substances

- explosion venting, 3.3.1.20.
- fire detectors, 3.2.4.10.
- fire protection, 9.10.1.3.
- heat and smoke detection, 9.10.18.4.
- prohibited in basements, 3.3.5.3.
- safety within floor areas, 3.3.1.2.
- storage, 9.10.1.3.

Headroom clearance

- access to exits, 9.9.3.4.
- doorways, 3.4.3.4., 9.5.5.1.
- exits, 3.4.3.4., 9.9.3.4.
- stairways, 3.4.3.4., 9.8.2.2.

Hearths, fireplace

- extensions, 9.22.5.1.
- standard for, 9.22.5.
- support, 9.22.5.2.

Heat detectors, 1.4.1.2.[A], 9.10.18.3., 9.10.18.4.

Heating appliances

- capacity, 9.33.3.1., 9.33.5.1.
- design, 6.4.1.2., 9.33.5.3.
- installation, 6.2.1.6.
- installation standards, 6.2.1.5., 9.33.5.2., 9.33.5.3.
- location, 6.4.1.1.

Heating coils, service water heaters, 9.31.6.5.

Heating systems and equipment

- access, 6.2.1.6., 6.8.1.1., 9.33.4.4.
- asbestos in, 6.2.1.7., 9.33.4.8.
- capacity, 9.33.3.1., 9.33.5.1.
- cleaning, 6.2.1.6., 9.33.4.4.
- continuity of insulation, 9.36.3.5.
- design, 6.2.1.1., 6.4.1.2., 9.33.1.1., 9.33.4.1., 9.33.5.3.
- drawings and specifications, 2.2.6.2.[C]
- energy efficiency, 9.36.
- fire safety characteristics, 6.9.1.1., 9.33.6.2. - 9.33.6.4.
- installation, 6.2.1., 9.33.1.1., 9.33.4.1.
- installation standards, 6.2.1.1., 6.2.1.5., 9.33.5.2., 9.33.5.3.
- location, 6.4.1.1.
- performance requirements, 9.36.3.10.
- protection from freezing, 6.2.1.6., 9.33.4.5.
- in residential buildings, 9.33.2.1.
- solid-fuel-burning, 6.2.1.5., 9.33.5.3.
- structural movement, 4.1.8.18., 6.2.1.4., 9.33.4.7.
- system pressure, 6.2.1.3., 9.33.4.6.
- temperature controls, 9.33.4.3., 9.36.3.6.

Heating, ventilating and air-conditioning (HVAC)

- systems and equipment
- access, 6.2.1.1., 6.2.1.6., 6.8.1.1., 9.33.4.4.
- air intakes and outlet dampers, 9.36.3.3.
- airtightness, 9.36.2.10.
- application of Code, 6
- asbestos in, 6.2.1.7., 9.33.4.8.
- cleaning, 6.2.1.6., 9.33.4.4.
- contaminant transfer prevention, 9.33.4.8.
- continuity of insulation, 9.36.3.5.
- design, 6.2., 6.2.1.1., 6.4.1.2., 9.32.3.2., 9.33.1.1., 9.33.4.1., 9.33.5.3.
- drawings and specifications, 2.2.6.2.[C]
- energy efficiency, 9.36., 9.36.3.
- energy performance calculations, 9.36.5.7.
- energy performance modeling, 9.36.5.11., 9.36.5.15.
- equipment and ducts, 9.36.3.2.
- fire safety characteristics, 6.9.1.1., 9.33.6.2. - 9.33.6.4.
- heat recovery, 9.36.3.8., 9.36.3.9.
- humidification, 6.3.2.16., 9.36.3.7.
- installation, 6.2., 9.32.3.2., 9.33.1.1., 9.33.4.1.
- installation standards, 6.2.1.1., 6.2.1.5., 9.33.5.2., 9.33.5.3.

- outdoor design conditions, 6.2.1.2.
- performance requirements, 9.36.3.10.
- pipng, 9.36.3.4.
- protection from freezing, 6.2.1.6., 9.33.4.5.
- structural movement, 4.1.8.18., 6.2.1.4., 9.33.4.7.
- system pressure, 6.2.1.3., 9.33.4.6.
- temperature controls, 9.36.3.6.
- Heat pumps, 9.36.3.6., 9.36.3.10.
- Heat recovery
  - indoor pools and hot tubs, 9.36.3.8.
  - ventilation systems, 9.36.3.9.
- Heat recovery ventilators
  - balancing, 9.32.3.12.
  - capacity, 6.3.1.5., 9.32.3.10.
  - condensate, 9.32.3.12.
  - installation, 6.3.1.5., 9.32.3.12.
  - standards for, 9.32.3.10.
- Heat transfer
  - application of Code, 5.1.1.1.
  - calculations and analyses, 5.2.1.3.
  - exterior insulation finish systems, 5.9.4.1.
  - performance in doors, windows and skylights, 5.9.2.4., 9.7.3.2.
  - performance in other fenestration assemblies, 5.9.3.3.
  - and required thermal insulation, 9.25.2.1.
  - thermal resistance of assemblies, 5.3.1., 5.3.1.2.
- Heavy timber construction
  - assembly occupancy (Group A, Division 1), 3.2.2.21.
  - assembly occupancy (Group A, Division 3), 3.2.2.30., 3.2.2.31.
  - assembly occupancy (Group A, Division 4), 3.2.2.35.
  - construction of exposing building faces, 9.10.15.5.
  - definition, 1.4.1.2.[A]
  - dimensions, 3.1.4.7.
  - exposing building faces, 9.10.14.5.
  - fire resistance, 9.10.6.2.
  - fire safety requirements, 3.1.4.7.
  - flame-spread rating, 3.1.13.8.
  - high-hazard industrial occupancy (Group F, Division 1), 3.2.2.71.
  - low-hazard industrial occupancy (Group F, Division 3), 3.2.2.87., 3.2.2.88.
  - roofs, 3.2.2.16.
  - structural members, 3.2.3.9.
  - walkways, 3.2.3.19.
  - when permissible, 3.1.4.6., 3.2.2.16.
- Height
  - access to exit, 3.3.1.8., 9.9.3.4.
  - between landings, 9.8.3.3., 9.8.4.4., 9.8.5.5.
  - ceilings, 9.5.3.
  - doorways, 9.5.5., 9.9.6.2.
  - exits, 9.9.3.4., 9.9.6.2.
  - guards, 9.8.8.3.
  - handrails, 9.8.7.4.
  - mezzanines, 9.5.3.2.
  - over landings, 9.8.6.4.
  - over ramps, 9.8.5.3.
  - over stairs, 9.8.2.2.
  - rooms and spaces, 9.5.3.1.
  - storage garages, 9.5.3.3., 9.9.3.4.
- Helicopter landing areas, 3.2.4.7., 3.2.4.16., 4.1.5.13., 9.23.16.7.
- High buildings
  - additional requirements, 3.2.6.1.
  - anchorage, 9.23.6.1.
  - central alarm and control facility, 3.2.6.7.
  - construction site protection of public, 8.2.3.2.
  - interior finishes, 3.1.13.7.
  - smoke control system testing, 3.2.6.9.
  - smoke movement limits, 3.2.6.2.
  - vertical transportation in, 3.5.1.1.
  - voice communication systems, 3.2.6.8.
  - wind loads, 4.1.7.3.
- High-hazard industrial occupancy (Group F, Division 1)
  - building classification, 3.1.2.1.
  - definition, 1.4.1.2.[A]
  - egress doorways, 3.3.1.5.
  - fire alarm systems, 3.2.4.1., 3.2.4.3.
  - fire protection, 3.2.2.70. - 3.2.2.73.
  - occupant load, 3.1.17.1.
  - safety within floor areas, 3.3.1.2.
- Hipped roofs, wind loads, 4.1.7.6.
- Hold-open devices, 3.1.8.14., 9.10.13.11.
- Horizontal exits
  - balconies, 3.4.6.10.
  - bridges, 3.4.6.10.
  - definition, 1.4.1.2.[A]
  - hose station beside, 3.2.5.11.
  - and other types of exits, 3.4.1.4.
  - restricted use, 3.4.1.6.
  - vestibules, 3.4.6.10.
  - width, 3.4.6.10.
- Horizontal service spaces
  - access, 3.6.4.5.
  - application of Code, 3.6.1.1., 3.6.4.1.
  - definition, 1.4.1.2.[A]
  - fire blocks in, 3.1.11.5.
  - above fire separations, 3.1.8.3., 9.10.9.10.
  - fire separations for, 3.6.4.2.
  - sprinkler systems, 3.2.5.14.
- Hose connections, 3.2.5.9., 3.2.5.10.
- Hospitals, 3.1.8.13., 3.3.3.5., 3.4.1.6.
- Hot tubs, heat recovery, 9.36.3.8.
- Hot water supply, 9.31.4.2.
- Housing and small buildings
  - (see also Dwelling units)
  - air leakage, 9.25.
  - cladding, 9.27.
  - columns, 9.17.
  - concrete materials, 9.3.1.
  - condensation control, 9.25.
  - crawl spaces, 9.18.
  - dampproofing, 9.13.
  - design of areas and spaces, 9.5.
  - drainage, 9.14.
  - electrical facilities, 9.34.
  - energy efficiency, 9.36.
  - excavations, 9.12.

fire protection, 9.10.  
 fireplaces, 9.22.  
 flooring, 9.30.  
 floors-on-ground, 9.16.  
 footings and foundations, 9.15.  
 glass, 9.6.  
 heat transfer, 9.25.  
 heating and air-conditioning, 9.33.  
 interior wall and ceiling finishes, 9.29.  
 lumber and wood products for, 9.3.2.  
 masonry and concrete chimneys, 9.21.  
 masonry and insulating concrete walls, 9.20.  
 materials, systems and equipment, 9.3.  
 means of egress, 9.9.  
 plumbing facilities, 9.31.  
 roof spaces, 9.19.  
 roofing, 9.26.  
 sheet steel stud wall framing, 9.24.  
 soil gas control, 9.13.  
 sound control, 9.11.  
 stairs, ramps, handrails and guards, 9.8.  
 structural requirements, 9.4.  
 stucco, 9.28.  
 ventilation, 9.32.  
 waterproofing, 9.13.  
 windows, doors and skylights, 9.7.  
 wood-frame construction, 9.23.  
 Humidification, 6.3.2.16., 9.36.3.7.  
 HVAC (see Heating, ventilating and air-conditioning (HVAC) systems and equipment)  
 Hydrants, 3.2.5.5., 3.2.5.15.  
 Hydronic heating  
   design, 9.33.4.1.  
   installation, 9.33.4.2.  
   secondary suites, 9.33.1.1.  
 Hydrostatic pressure, 4.2.4.8., 5.7.2., 9.13.3.1., 9.16.3.2.

Ice, accumulation, 4.1.6.2., 4.1.6.15., 4.1.7.11., 5.3.1.2., 5.6.2.2.

Impeded egress zones  
   definition, 1.4.1.2.[A]  
   door release hardware, 3.4.6.16.  
   doors and door hardware, 3.3.1.13.  
   fire alarm systems, 3.2.4.1.  
   fire annunciators, 3.2.4.8.  
   sliding doors, 3.4.6.14.  
   sprinkler system requirements, 3.2.2.19.

Importance categories for buildings, 4.1.2.1.

Importance factors  
   earthquake loads, 4.1.8.5.  
   snow loads, 4.1.6.2.  
   wind loads, 4.1.7.3.

Incinerator rooms, 3.6.2.4., 9.10.10.5.

Indirect service water heaters (see Service water heaters)

Indoor design temperature, 5.2.1.2., 5.3.1.2., 5.5.1.2., 9.33.3.1.

Indoor pools

heat recovery, 9.36.3.8.  
 temperature controls, 9.36.4.6.  
 water heaters, 9.36.4.2.

Industrial occupancy (Group F)

(see also High-hazard industrial occupancy;  
   Low-hazard industrial occupancy;  
   Medium-hazard industrial occupancy)

classification, 9.10.2.

definition, 1.4.1.2.[A]

door thresholds, rooms with flammable liquids,  
   3.3.1.13., 3.4.6.1.

exposing building face, 9.10.14.5.

fire alarm systems, 9.10.18.

fire-resistance rating, 9.10.8.

fire separations, 9.10.9.11., 9.10.9.12.

flame-spread rating, 9.10.17.

guards, 3.3.5.10., 9.8.8.5.

ramps and stairways, 3.3.1.14., 3.4.6.7., 3.4.6.8.

self-service storage buildings, 3.9.1.3.

washrooms, 3.7.2.

Information required for proposed work, 2.2.2.1.[C]

Institutional occupancy (see Care, treatment or  
   detention occupancy)

Insulation

attic or roof spaces, 9.25.2.4.

basements, 9.25.2.2.

combustible, in noncombustible construction,  
   3.1.5.14., 3.1.5.15.

concealed spaces, 3.1.11.2.

continuity of, 9.36.2.5.

crawl spaces, 9.25.2.2., 9.25.2.3.

ducts, 3.1.5.18., 6.3.2.5., 9.32.3.11., 9.33.6.4.

environmental separation, 5.1.1.1.

exposure to exterior space on ground, 5.1.2.1.

foamed plastic, 3.1.5.14., 3.1.5.15., 5.3.1.3.,  
   9.10.17.10., 9.25.2.2., 9.33.6.4.

foundations, 9.12.2.2., 9.25.2.2., 9.25.2.3.

installation, 5.3.1.3., 9.25.2.3., 9.27.3.4.

loose-fill, 9.25.2.4.

materials, 9.25.2.2.

material standards, 5.9.1.1., 9.25.2.2.

pipes, 3.1.5.18., 6.5.1.1., 9.33.8.2., 9.33.8.4.

plenums, 9.33.6.4.

properties, 9.25.5.1.

protection of, 9.10.17.10., 9.25.2.3.

requirement for, 5.3.1.1., 9.25.2.1.

roofs, 9.25.2.2.

slabs-on-ground, 9.25.2.3.

spray-applied, 5.3.1.3., 9.25.2.5.

supported by gypsum board, 9.29.5.4.

thermal, 9.25.2.

thermal resistance, 5.3.1.

walls, 9.25.2.4.

wall sheathing, 9.23.17.2., 9.23.17.3., 9.27.3.4.

wires and cables, 3.1.5.21.

Interconnected floor spaces, 1.4.1.2.[A], 3.2.3.2.,  
   3.2.8.2., 3.2.8.8., 9.10.9.5.

Interconnection of duct systems, 6.3.2.7., 6.3.2.10.,  
   9.33.6.7.

## Interior finishes

- for braced wall panels, 9.23.13.6.
- ceilings, 9.23.9.4., 9.29.
- dampproofing, 9.13.2.5.
- fastening to steel studs, 9.24.1.4.
- flame-spread limits, 9.10.17.
- flame-spread rating, 3.1.13.2.
- floors, 9.30.
- gypsum board, 9.29.5.
- hardboard, 9.29.7.
- in noncombustible construction, 3.1.5.12.
- insulating fibreboard, 9.29.8.
- masonry walls, 9.20.13.9.
- materials, 3.1.13.1.
- OSB, 9.29.9.
- particle board, 9.29.9.
- plastering, 9.29.4.
- plywood, 9.29.6.
- public corridor ceilings, 3.1.13.6.
- on steel studs, 9.24.1.5.
- support, 9.23.10.5., 9.24.3.4.
- tiles, 9.29.10.
- underground walkways, 3.1.13.9.
- waferboard, 9.29.9.
- walls, 9.29.
- waterproof, 9.29.2.

## J

- Janitors' rooms, 3.2.4.10., 3.3.1.21., 9.10.18.4.
- Joints and connections for ducts, 9.33.6.2., 9.33.6.3., 9.33.6.6., 9.33.6.7.
- Joists
  - bearing, 9.23.9.1.
  - cantilevered, 9.23.9.9.
  - ceilings, 9.23.14.1., 9.23.14.7.
  - continuity, 9.23.14.1.
  - dimensions, 9.23.4.1., 9.23.14.7., 9.23.14.10.
  - end bearing length, 9.23.14.3.
  - floors, 9.23.4.1., 9.23.4.2., 9.23.4.4., 9.23.9.
  - framing around openings, 9.23.14.2.
  - header, 9.23.9.5., 9.23.9.7.
  - lumber grade, 9.3.2.1.
  - nailing, 9.23.3.4., 9.23.9.3., 9.23.14.9.
  - preservative treatment, 9.23.2.2., 9.23.2.3.
  - roofs, 9.23.4.2., 9.23.4.5., 9.23.14.1., 9.23.14.7., 9.23.14.9.
  - spans, 9.23.4.1., 9.23.4.2., 9.23.4.4., 9.23.4.5., 9.23.14.7., 9.23.14.10.
  - strapping, bridging and furring, 9.23.9.4.
  - support, 9.23.14.7.
  - supported on beams, 9.23.9.2.
  - supported on masonry or concrete, 9.20.8.2., 9.20.8.3., 9.21.5.3., 9.23.2.2., 9.23.2.3.
  - supporting walls, 9.23.9.8.
  - tail, 9.23.9.7.
  - trimmer, 9.23.9.6.
  - wood, 9.23.4.1., 9.23.4.2., 9.23.4.4., 9.23.4.5.
- Junction boxes, electrical, 3.1.5.2., 9.10.9.6.

## K

### Kitchens

- commercial cooking equipment, 3.3.1.2., 6.3.1.7., 9.10.1.4., 9.10.13.13.
- emergency lighting, 3.2.7.3.
- exhaust ducts, 3.1.8.8., 3.1.8.9., 6.3.2.10., 9.32.3.11.
- exhaust fans, 9.32.3.3., 9.32.3.7.
- exhaust outlets, 6.3.2.10.
- grease duct enclosures, 3.6.3.5.
- loads on floor or roof, 4.1.5.3.

## L

### Laboratories

- enclosure exhaust ventilation, 3.3.1.20., 6.3.4.3.
- live loads on floor or roof, 4.1.5.3.
- ventilated enclosure construction, 6.3.4.4.

### Landings

- barrier-free, 3.8.3.5.
- configurations, 9.8.6.3.
- dimensions, 3.4.3.4., 3.4.6.4., 9.8.6.3.
- at doorways, 3.4.3.3., 3.4.6.3., 9.8.6.2., 9.8.6.3., 9.9.6.1.
- fire escapes, 3.4.7.7.
- guards, 3.4.6.6., 9.8.8.
- height between, 3.4.6.3., 9.8.3.3., 9.8.4.4., 9.8.5.5.
- height over, 9.8.6.4.
- in housing and small buildings, 9.8.6.
- omitted, 3.4.6.3.
- openings in, 3.4.6.4.
- as part of exit, 9.8.1.3.
- on ramps, 9.8.6.
- slip-resistance, 3.4.6.1., 9.8.9.6.
- on stairs, 9.8.6.

### Lateral loads

- anchorage, 9.23.6.1.
- braced wall bands, 9.23.13.4., 9.23.13.5.
- braced wall panels, 9.23.13.5., 9.23.13.6.
- bracing considerations, 9.23.13.7.
- bracing requirements, 9.23.13., 9.23.13.1.
- fasteners for framing, 9.23.3.4.
- fasteners for sheathing and subfloors, 9.23.3.5.
- floor joists supporting walls, 9.23.9.8.
- lumber roof sheathing, 9.23.16.5.
- materials, 9.23.13.6.
- particleboard, OSB or waferboard finishes, 9.29.9.3.
- plywood finish, 9.29.6.3.
- roof sheathing, required, 9.23.16.1.
- spacing of nails in gypsum board, 9.29.5.8.
- spacing of screws in gypsum board, 9.29.5.9.

### Lath, plaster

- gypsum, 9.29.4.1.
- metal, 9.29.4.1.

### Lath, stucco

- attachment to sheathing, 9.27.5.1.
- dimensions, 9.28.4.3.
- fastening, 9.27.5.7., 9.27.7.5., 9.28.4.6.
- installation, 9.28.4.2., 9.28.4.5., 9.28.4.6.
- materials, 9.28.4.1., 9.28.4.3.

- nailing, 9.27.5., 9.28.4.6.
- self-furring, 9.28.4.4.
- standard for, 9.28.4.
- stapling, 9.27.5., 9.28.4.6.
- uses, 9.28.1.2.
- Lattice structures, ice loading, 4.1.6.15.
- Laundry-drying equipment, 9.32.1.3.
- Laundry rooms, 3.2.4.10., 3.3.1.22., 9.10.18.4.
- Lavatories, 3.7.2.3., 3.8.2.8., 3.8.3.15.
- Libraries, 3.3.2.13., 4.1.5.3.
- Licensed beverage establishments
  - access to exit, 3.3.1.17.
  - principal entrances, 3.4.2.6.
- Life safety systems, 3.2.9.1., 9.10.1.2.
- Light diffusers and lenses, 3.1.13.4., 9.10.17.6., 9.10.17.8.
- Lighting
  - basements, 9.34.2.3., 9.34.2.4.
  - elements, 3.1.13.1., 9.10.17.6., 9.10.17.8.
  - emergency, 3.2.7.3., 3.2.7.4., 9.9.12.3., 9.34.2.7., 9.34.3.
  - entrances, 9.34.2.1.
  - exits, 3.2.7.1.
  - fixtures, recessed, 3.2.7.2., 9.34.1.4.
  - garages and carports, 9.34.2.6.
  - levels, 9.9.12.2., 9.9.12.3.
  - levels, minimum, 3.2.7.1.
  - means of egress, 9.9.12.
  - outlets for, 3.2.7.1., 9.34.2.
  - public corridors, 3.2.7.1., 9.9.12.2., 9.9.12.3.
  - public and service areas, 9.34.2.7.
  - stairways, 9.34.2.3.
- Lightning protection systems, 3.6.1.3.
- Limiting distance
  - between construction camp buildings, 9.10.21.5.
  - definition, 1.4.1.2.[A]
  - exposing building face, 3.2.3.5., 3.2.3.6., 3.2.3.7., 9.10.14.5., 9.10.15.5.
  - exterior walls, 9.10.3.3.
  - fire department response time, 3.2.3.1.
  - and firefighting services, 9.10.15.3.
  - fire-resistance rating exception, 3.1.7.2.
  - less than 1.2 m, 3.2.3.5.
  - low-hazard industrial occupancy (Group F, Division 3), 3.2.3.11.
  - maximum concentrated area, 3.2.3.1.
  - spatial separation between buildings, 3.2.3.1., 9.10.14.3., 9.10.15.
  - unprotected openings, 3.2.3.1., 3.2.3.10.
  - wall exposed to another wall, 3.2.3.14.
- Limit states design
  - application, 4.1.3.
  - dead load, 4.1.3.2.
  - definition of terms, 4.1.3.1.
  - effect of factored loads, 4.1.3.2.
  - fatigue check, 4.1.3.3.
  - importance factors, 4.1.6.2., 4.1.8.5.
  - load factors, 4.1.3.2.
  - resistance, 4.1.3.2.
  - serviceability check, 4.1.3.4.
  - strength and stability check, 4.1.3.2.
- Linen chutes, 3.6.3.3., 9.10.1.3.
- Liners, chimney
  - clay, 9.21.3.3.
  - clearances, 9.21.3.8.
  - concrete, 9.21.3.5.
  - definition, 1.4.1.2.[A]
  - extensions, 9.21.3.10.
  - firebrick, 9.21.3.4.
  - installation, 9.21.3.7.
  - joints, 9.21.3.2.
  - materials, 9.21.3.1.
  - metal, 9.21.3.6.
  - mortar, 9.21.3.9.
  - separation, 9.21.4.9.
  - standard for, 9.21.3.
- Liners, fireplace
  - firebrick, 9.22.2.2.
  - standard for, 9.22.2.
  - steel, 9.22.2.3.
  - wall thickness, 9.22.3.
- Linings
  - for ducts and plenums, 3.1.5.18., 6.3.2.5., 9.33.6.4.
  - for radiators and convectors, 6.4.3.1., 9.33.7.1.
- Lintels
  - dimensions, 9.23.12.3.
  - fireplaces, 9.22.1.2.
  - nailing, 9.23.12.3.
  - spans, 9.23.12.3.
  - steel, 3.2.2.3., 9.10.7.1., 9.20.5.2., 9.22.1.2.
  - supporting masonry over openings, 9.20.5.2.
  - wood, 9.23.12.
- Liquids, combustible (see Combustible liquids)
- Liquids, flammable (see Flammable liquids)
- Liquids, hazardous, 6.9.1.2.
- Live loads (see Loads)
- Loadbearing, definition, 1.4.1.2.[A]
- Loads
  - in attics, 9.4.2.4.
  - bearing pressure for soil or rock, 9.4.4.1.
  - climatic, 1.1.3., 5.2.1.1.
  - combinations, 4.1.3.2.
  - concentrated, 4.1.5.9.
  - dead, 1.4.1.2.[A], 4.1.3.2., 4.1.4., 9.4.3.1.
  - deflections under, 4.1.3.5., 9.4.3.
  - design requirement, 4.1.1.3.
  - in dining areas, 4.1.5.3., 4.1.5.6.
  - due to crane, 4.1.3.2., 4.1.5.11.
  - due to earthquakes, 4.1.3.2., 4.1.8.
  - due to ice, 4.1.6.15.
  - due to partitions, 4.1.4.1.
  - due to resonance, 4.1.3.6.
  - due to snow and rain, 4.1.6., 4.1.6.4., 9.4.2.2., 9.4.2.3.
  - due to sway forces, 4.1.5.10.
  - due to use and occupancy, 4.1.5.
  - during construction, 4.1.1.3.
  - eccentric, on foundations, 4.2.4.6.
  - environmental, 5.1.4.1., 5.2.1., 5.2.1.3.
  - on exterior areas, 4.1.5.5.
  - on firewalls, 4.1.5.17.
  - on floors, 4.1.5.3., 9.23.1.1., 9.23.4.1., 9.23.4.2., 9.23.4.4.

## M

- on foundations, 4.2.4.1., 9.4.4.6.
  - full and partial, 4.1.5.3.
  - on grab bars, 3.7.2.8., 9.31.2.3.
  - on guards, 3.3.5.4., 4.1.5.14., 9.8.8.2., 9.8.8.4.
  - on handrails, 3.4.6.5., 4.1.5.14., 9.8.7.7.
  - and helipads, 4.1.5.13.
  - hydrostatic, 4.2.4.8., 9.13.3.1., 9.16.3.2.
  - impact of machinery and equipment, 4.1.5.11.
  - lateral (see Lateral loads)
  - limit states, 4.1.3.
  - live, 1.4.1.2.[A], 4.1.5.
  - with more than one occupancy, 4.1.5.7.
  - not specified, 4.1.2.2.
  - permanent, 4.1.3.2.
  - on ramps, 9.8.9.1.
  - on residential balconies, 4.1.5.3., 9.4.2.3.
  - on retaining walls, 9.4.4.5., 9.4.4.6.
  - specified, 4.1.2., 9.4.2.
  - on stairs, 9.8.9.1.
  - structural, 4.1., 9.4.
  - structural, on environmental separators, 5.1.4.1., 5.2.2.
  - and structural strength, 5.2.2.
  - variation with tributary area, 4.1.5.8.
  - on vehicle guardrails, 4.1.5.15.
  - vibration, 4.1.3.6.
  - on walls acting as guards, 4.1.5.16.
  - wind (see Wind load)
- Lobbies, 3.4.4.2., 9.9.8.5., 9.10.17.3.  
(see also Vestibules)
- Locking devices
- automatic, 3.3.4.5.
  - contained use area, 3.3.1.13.
  - electromagnetic, 3.3.1.13., 3.4.6.16., 3.4.6.18., 9.9.6.7.
  - impeded egress zone, 3.3.1.13.
  - principal entrances, 9.9.6.7.
- Locks, deadbolt, 9.7.5.2.
- Low buildings, wind loads, 4.1.7.5., 4.1.7.6.
- Lowest exit level, 3.2.6.2., 3.4.3.2., 3.4.5.2., 9.9.11.4.
- Low fire load, 3.2.2.89., 3.2.3.11.
- Low-hazard industrial occupancy (Group F, Division 3)
- building classification, 3.1.2.1.
  - definition, 1.4.1.2.[A]
  - fire alarm systems, 3.2.4.1., 9.10.18.
  - fire protection, 3.2.2.80. - 3.2.2.90., 3.2.3.11.
  - fire safety within floor areas, 3.3.1., 3.3.5.
  - occupant load, 3.1.17.1.
- Lumber
- dimensions, 9.3.2.6.
  - fire stops, 3.1.11.7.
  - grades, 9.3.2.1., 9.3.2.2., 9.3.2.3.
  - for housing and small buildings, 9.3.2.
  - moisture content, 9.3.2.5.
  - protection from termites and decay, 9.3.2.9.
  - sheathing, 9.23.16.5.
  - structural uses, 9.3.2.9.
  - undersized, 9.3.2.8.
- Main entrances (see Principal entrances)
- Major occupancy
- and building classification, 3.1.2.1., 9.10.2.
  - definition, 1.4.1.2.[A]
  - occupancy combination prohibitions, 3.1.3.2.
- Major occupancy and fire safety requirements
- building area determination, 3.2.2.5.
  - exceptions, 3.2.2.8.
  - fire separations, 3.1.3.1.
  - multiple occupancies, 3.1.3., 3.2.2.4., 3.2.2.6., 9.10.2., 9.10.9.11., 9.10.9.16., 9.10.9.17.
  - superimposed occupancies, 3.2.2.7.
- Makeup air
- and depressurization protection, 9.32.3.8.
  - fans, 9.32.3.10.
  - requirements, 6.3.2.8.
  - for subfloor depressurization, 9.13.4.3.
- Mansard roofs
- fire stopping, 3.1.11.5.
  - sheathing, 9.23.17.6.
  - venting, 9.19.1.4.
- Manual stations, fire alarm systems, 3.2.4.4., 3.2.4.16.
- Manufactured buildings, foundations, 9.12.2.2., 9.15.1.3.
- Marquees, 3.1.5.24., 3.1.16.1., 3.2.2.3.
- Masonry
- bonding, 9.20.9., 9.20.11.2.
  - chases and recesses, 9.20.7.
  - chimneys, 1.4.1.2.[A], 6.3.3.2., 9.21., 9.33.10.3.
  - cold weather requirements, 9.20.14.
  - columns, 9.17.5.
  - corbelling, 9.20.12.
  - dampproofing, 9.13.2.3.
  - earthquake reinforcement, 9.20.1.2., 9.20.15.
  - exposure to weather, 9.20.2.6.
  - flashing, 9.20.13., 9.26.4.4., 9.26.4.6.
  - flues, 9.21.
  - foundations, 4.2.3.3., 4.2.3.4., 9.15.1.1., 9.15.2., 9.15.4., 9.15.4.10.
  - grout, 9.20.3.2.
  - installation, 5.6.1.2., 9.15.2.2., 9.15.2.3., 9.20.
  - joints, 9.20.4., 9.20.9.1.
  - lateral support, 9.20.10.
  - material standards, 5.6.1.2., 5.9.1.1., 9.15.2.2., 9.17.5.1.
  - mortar, 9.20.3.1., 9.20.3.2.
  - parapet walls, 9.20.6.5.
  - for pilasters, 9.15.5.3.
  - solid, 1.4.1.2.[A]
  - structural design basis, 4.3.2.1.
  - stucco on, 9.28.1.3.
  - supporting beams, 9.15.5.2.
  - supporting floor joists, 9.15.5.1.
  - support of loads, 9.20.5., 9.20.8.
  - as thermal barrier, 3.1.5.14., 3.1.5.15.
  - ties, 9.20.9.5.
  - tying, 9.20.9., 9.20.11.2.
  - units, 1.4.1.2.[A], 9.20.2., 9.20.2.1.
  - used brick, 9.20.2.2.

- veneer, 9.20.6.4., 9.20.8.5., 9.20.9.5., 9.20.12.3.
- walls, 9.20.
- weep holes, 5.6.2.1., 9.20.13.5., 9.20.13.6., 9.20.13.8.
- Mastics, 3.1.5.2.
- Materials
  - braced wall panels, 9.23.13.6.
  - characteristics, 1.2.2.1.[A]
  - cladding, hardboard, factory-finished, 9.27.9.1.
  - cladding, lumber, 9.27.6.1.
  - cladding, OSB and waferboard, 9.27.10.1.
  - cladding, plywood, 9.27.8.1.
  - cladding, strip steel, 9.27.11.1.
  - cladding, vinyl, 9.27.12.1.
  - columns, unit masonry, 9.17.5.1.
  - columns, wood, 9.17.4.2.
  - combustible, in noncombustible construction, 9.10.6.
  - concrete, 9.3.1.
  - dampproofing, 9.13.2.2.
  - design requirements, 4.3.
  - drainage tile and pipe, 9.14.3.1.
  - ducts, 6.3.2.3., 9.32.3.11., 9.33.6.2.
  - eave protection, 9.26.5.2.
  - exterior insulation finish systems, 9.27.13.
  - fibreglass, insulating, 9.29.8.1.
  - fire blocks, 9.10.16.3.
  - fire stops, 3.1.9.1., 3.1.11.7.
  - flashing, 9.20.13.1., 9.26.4.2., 9.27.3.7.
  - foundations, 4.2.3.
  - glass, 9.6.1.2.
  - granular, beneath floors, 9.16.2.
  - gypsum products, 9.29.5.2.
  - hardboard, 9.29.7.1.
  - for housing and small buildings, 9.30.
  - lumber and wood products, 9.3.2.
  - metal, 9.3.3.
  - particleboard finish, 9.29.9.1.
  - pipes for heating and cooling systems, 6.7.1.1., 9.33.8.1.
  - review of, 2.2.7.4.[C]
  - roofing, 9.26.2.1.
  - roof sheathing, 9.23.16.2.
  - sealants, 9.27.4.2.
  - shingles and shakes, 9.27.7.1.
  - standards, 1.5.[A], 5.9.1.1.
  - steel studs and runners, 9.24.1.2.
  - storage, 1.2.2.2.[A], 9.10.1.3.
  - subflooring, 9.23.15.2.
  - testing, 4.1.1.5.
  - thermal characteristics, 9.36.2.2.
  - underlay, panel-type, 9.30.2.2.
  - used, 1.2.2.3.[A]
  - waterproofing, 9.13.3.2., 9.29.2.2.
- Materials, appliances, systems and equipment
  - characteristics, 1.2.2.1.[A]
  - storage, 1.2.2.2.[A]
  - used, 1.2.2.3.[A]
- Means of egress
  - (see also Exits)
  - from air-supported structures, 3.1.6.1.
  - from care, treatment or detention occupancy, 3.3.3.3.
  - definition, 1.4.1.2.[A]
  - dimensions, 9.9.3.
  - through doors and windows in dwelling units, 9.7.2.2.
  - from dwelling units, 3.3.4.4., 9.9.9.
  - exterior passageways as, 3.2.2.12.
  - and fire hose cabinets, 3.2.5.11.
  - within floor areas, 3.3.1.3.
  - from housing and small buildings, 9.9.
  - lighting of, 9.9.12.2.
  - obstructions in, 3.3.1.23., 3.4.3.3., 9.9.5., 9.9.5.5., 9.9.11.2.
  - from outdoor places of assembly, 3.3.2.11.
  - from secondary suites, 9.9.9.
  - sliding doors in, 3.3.1.12.
  - from tents, 3.1.6.1.
  - transparent panels or doors in, 3.3.1.19., 9.6.1.4.
  - with two separate exits, 9.9.9.2.
- Measurement, rooms and spaces, 9.5.1.1.
- Mechanical systems and equipment (see Heating, ventilating and air-conditioning (HVAC) systems and equipment)
- Mechanical ventilation (see Ventilation)
- Medical gas piping, 3.7.3.1., 9.31.1.1.
- Medium-hazard industrial occupancy (Group F, Division 2)
  - ammonium nitrate storage, 3.3.6.6.
  - building classification, 3.1.2.1.
  - definition, 1.4.1.2.[A]
  - fire alarm systems, 3.2.4.1., 9.10.18.
  - fire protection, 3.2.2.74. - 3.2.2.79.
  - fire safety within floor areas, 3.3.1., 3.3.5.
  - occupant load, 3.1.17.1.
- Mercantile occupancy (Group E)
  - classification, 3.1.2.1., 9.10.2.
  - definition, 1.4.1.2.[A]
  - exit stairs, 9.9.4.7.
  - exposing building face, 9.10.14.5.
  - fire alarm systems, 3.2.4.1., 9.10.18.
  - fire protection, 3.2.2.64. - 3.2.2.69.
  - fire-resistance rating, 9.10.8.
  - fire safety within floor areas, 3.3.1.
  - flame-spread rating, 9.10.17.
  - occupant load, 3.1.17.1.
  - security, 3.4.6.17.
- Metal
  - cladding, 5.6.1., 5.9.1.1., 9.27.3.6., 9.27.5.6., 9.27.11.
  - for housing and small buildings, 9.3.3.
  - galvanized sheet, 9.3.3.2.
  - roof deck assembly, 3.1.14.2.
  - sheet thickness, 9.3.3.1.
  - siding, 5.6.1., 5.9.1.1., 9.27.3.6., 9.27.5.6., 9.27.11.
- Mezzanines
  - application of requirements to exterior passageways, 3.2.2.12.
  - assembly occupancy (Group A, Division 1), 3.2.2.20.
  - assembly occupancy (Group A, Division 2), 3.2.2.23.

assembly occupancy (Group A, Division 3), 3.2.2.29.  
 and building height, 3.2.1.1., 9.10.4.1., 9.10.4.2.  
 business and personal services occupancy (Group D), 3.2.2.55.  
 care, treatment or detention occupancy (Group B, Division 1), 3.2.2.36., 3.2.2.37.  
 care, treatment or detention occupancy (Group B, Division 2), 3.2.2.38. - 3.2.2.41.  
 care, treatment or detention occupancy (Group B, Division 3), 3.2.2.42. - 3.2.2.46.  
 ceiling height, 9.5.3.2.  
 definition, 1.4.1.2.[A]  
 fire-resistance rating, 9.10.8.6., 9.10.9.4.  
 fire separations, 3.2.1.6., 3.2.8.1., 9.10.12.1.  
 guards, 3.3.1.18., 9.8.8.1.  
 high-hazard industrial occupancy (Group F, Division 1), 3.2.2.70.  
 loads on floor or roof, 4.1.5.3., 4.1.5.4.  
 low-hazard industrial occupancy (Group F, Division 3), 3.2.2.80.  
 means of egress, 3.4.2.2., 9.9.8.6.  
 medium-hazard industrial occupancy (Group F, Division 2), 3.2.2.74.  
 mercantile occupancy (Group E), 3.2.2.64.  
 occupant load, 3.1.17.1.  
 openings in floor assemblies, 3.2.8.2.  
 residential occupancy (Group C), 3.2.2.47.  
 termination, 9.10.12.1.  
 Micro-organisms, minimizing growth of, 6.3.1.6., 6.3.2.15.  
 Mild climate indicator, 9.25.4.2., 9.25.5.1.  
 Millwork, combustible, 3.1.5.9.  
 Mirrors  
   in exits, 9.9.5.6.  
   in washrooms, 3.8.3.15.  
 Misters, 6.3.2.16.  
 Mobile home parks, sanitary facilities, 3.7.2.4.  
 Moisture  
   diffusion, 5.1.1.1., 5.5.1.2.  
   flooring resistant to, 9.30.1.2.  
   protection against, application of Code, 9.13.1.1.  
   resistant backing for wall tile, 9.29.10.4.  
   transfer, 5.1.1.1., 5.2.1.3., 5.5.1.2.  
 Moisture index, 9.27.2.2.  
 Mortar  
   aggregate for, 5.9.1.1., 9.20.3.1., 9.20.3.2., 9.29.10.2.  
   as base for ceramic wall tile, 9.29.10.2.  
   cold weather requirements, 9.20.14.  
   joints, 9.20.4.  
   material standards, 9.20.3.1.  
   mixes, 9.20.3.2.  
   standard for, 9.20.3.  
   uses, 9.20.3.2.  
 Movement, differential  
   columns, 9.17.2.2.  
   decks and other accessible platforms, 9.12.2.2., 9.23.6.2.  
   elements in environmental separation, 5.1.4.1., 5.2.2.1.  
   metal and vinyl cladding, 9.27.5.6.

Moving walks, 3.2.8.2., 3.8.2.3., 3.8.2.4., 9.8.1.4.  
 Multiple occupancies  
   and building classification, 9.10.2.  
   building size and construction requirements, 3.2.2.4.  
   fire separations, 3.1.3.  
   requirements decided by most restricted occupancy, 3.2.2.6.  
   separation of repair garages, 9.10.9.17.  
   separation of residential occupancies, 9.10.9.11.  
   separation of storage garages, 9.10.9.16.

## N

Nailing  
   bracing, 9.23.10.2.  
   built-up beams, 9.23.8.3.  
   cladding, 9.27.5., 9.27.7.3.  
   columns, 9.17.4.2.  
   fibreboard finish, 9.29.8.3.  
   framing, 9.23.3.4.  
   furring, 9.29.3.2.  
   gypsum board, 9.29.5.5., 9.29.5.8.  
   hardboard finish, 9.29.7.3.  
   joists, 9.23.9.2., 9.23.9.3., 9.23.14.9.  
   lintels, 9.23.12., 9.23.12.3.  
   OSB finish, 9.29.9.3.  
   particleboard finish, 9.29.9.3.  
   plywood finish, 9.29.6.3.  
   prevention of splitting, 9.23.3.3.  
   rafters, 9.23.14.4.  
   roofing, 9.26.2.3.  
   runners, 9.24.3.1.  
   shakes, 9.27.7.3.  
   sheathing, 9.23.3.5.  
   shingles, 9.26.7.4., 9.26.7.6., 9.26.8.5., 9.27.7.3.  
   siding, 9.27.5., 9.27.7.3.  
   stucco, 9.28.3.2.  
   subflooring, 9.23.3.5., 9.23.15.6.  
   underlay, 9.30.2.3.  
   waferboard finish, 9.29.9.3.  
   wall plates, 9.23.11.3.  
   wood-frame construction, 9.23.3.  
   wood shingles and shakes, 9.26.9.5., 9.26.10.4.  
   wood strip flooring, 9.30.3.3.  
 Nailing and supporting elements  
   fire blocks required, 3.1.11.3.  
   in noncombustible construction, 3.1.5.8.  
 Nails  
   for cladding, 9.27.5., 9.27.5.4., 9.27.7.3.  
   diameters, 9.23.3.1.  
   dimensions, 9.23.3.5., 9.26.2.3., 9.27.5.4.  
   for fibreboard finish, 9.29.8.3.  
   for gypsum board, 9.29.5.6.  
   length, 9.23.3.2.  
   for OSB finish, 9.29.9.3.  
   for particleboard finish, 9.29.9.3.  
   for roofing, 9.23.3.5., 9.26.2.3.  
   for shingles, 9.26.7.4.



- standard for, 9.23.3.1., 9.26.2.3., 9.29.5.6.
  - for underlay, 9.30.2.3.
  - for waferboard finish, 9.29.9.3.
  - National Building Code
    - acceptable solutions, 1.2.1.1.[A]
    - administration, 2.2.[C]
    - alternative solutions, 1.2.1.1.[A]
    - application, 1.1.1.[A], 1.1.1.[C], 1.3.[A], 2.1.1.[A], 3.1.[A]
    - compliance, 2.2.[A]
    - conflicting requirements, 1.5.1.2.[A]
    - objectives, 2.2.1.1.[A]
    - referenced documents, 1.3.1., 1.5.1.[A]
    - scope, 1.1.1.[C], 1.3.1.[B]
  - Noise, protection from, 5.8., 9.32.3.10.
  - Noncombustible cladding, 3.2.3.7., 3.2.3.9.
  - Noncombustible construction
    - assembly occupancy (Group A, Division 1), 3.2.2.20., 3.2.2.21.
    - assembly occupancy (Group A, Division 2), 3.2.2.23., 3.2.2.24.
    - assembly occupancy (Group A, Division 3), 3.2.2.29.
    - assembly occupancy (Group A, Division 4), 3.2.2.35.
    - business and personal services occupancy (Group D), 3.2.2.55.
    - care, treatment or detention occupancy (Group B, Division 1), 3.2.2.36., 3.2.2.37.
    - care, treatment or detention occupancy (Group B, Division 2), 3.2.2.38. - 3.2.2.41.
    - care, treatment or detention occupancy (Group B, Division 3), 3.2.2.42. - 3.2.2.46.
    - combustible elements, 3.1.5.6., 9.10.6.1.
    - combustible finishes in, 3.1.5.12.
    - combustible flooring in, 3.1.5.10.
    - combustible insulation in, 3.1.5.14.
    - combustible stairs in, 3.1.5.11.
    - decorative wood cladding, 3.1.5.24.
    - definition, 1.4.1.2.[A]
    - ducts (combustible) in, 3.1.5.18.
    - exposing building face, 3.2.3.7.
    - exterior walls, 3.1.5.5., 3.1.5.6.
    - factory-assembled panels, 3.1.5.7.
    - fire stops, 3.1.11.3.
    - firewalls, 3.1.10.1., 3.1.10.2.
    - flame-spread rating, 3.1.13.8.
    - glazing and skylights, 3.1.5.4.
    - high-hazard industrial occupancy (Group F, Division 1), 3.2.2.70., 3.2.2.71.
    - low-hazard industrial occupancy (Group F, Division 3), 3.2.2.80., 3.2.2.87.
    - materials permitted in, 3.1.5.1.
    - medium-hazard industrial occupancy (Group F, Division 2), 3.2.2.74., 3.2.2.75.
    - mercantile occupancy (Group E), 3.2.2.64.
    - metal roof decks, 3.1.14.2.
    - minor combustible components, 3.1.5.2.
    - nailing elements, 3.1.5.8.
    - non-metallic raceways in, 3.1.5.23.
    - partitions in, 3.1.5.16.
    - plumbing fixtures, 3.1.5.20.
    - residential occupancy (Group C), 3.2.2.47.
    - roofing materials, 3.1.5.3.
    - support of, 9.10.8.4.
    - vehicular passageways, 3.2.3.18.
    - walkways, 3.2.3.19., 3.2.3.20.
    - wires and cables, 3.1.5.21., 3.1.5.22.
  - Noncombustible materials
    - permitted in noncombustible construction, 3.1.5.1.
    - return air ducts, 3.6.5.8.
  - Notching of framing members, 9.23.5.2.
  - Nursing homes, 3.1.8.13., 3.3.3.5., 3.4.1.6.
- O**
- Objectives of the Code
    - application, 2.1.1.2.[A], 3.2.[A]
    - definition, 2.2.1.1.[A]
  - Obstructions
    - in corridors, 3.3.1.9., 9.9.5.2., 9.9.5.3., 9.9.6.1.
    - in doorways, 9.9.6.1., 9.9.6.3.
    - in exits, 3.4.3.3., 9.9.5., 9.9.5.5., 9.9.6.1., 9.9.6.2.
    - in means of egress, 3.3.1.23., 9.9.5., 9.9.5.5.
  - Occupancy
    - and building classification, 3.1.2.1., 9.10.2.
    - and building size determination, 1.3.3.4.[A]
    - combination prohibitions, 3.1.3.2., 9.10.9.12.
    - definition, 1.4.1.2.[A]
    - and live loads, 4.1.5.3.
    - multiple (see Multiple occupancies)
  - Occupant load
    - and access to exits, 9.9.7.1.
    - definition, 1.4.1.2.[A]
    - and exit stairway, 3.4.3.1.
    - and fire alarm systems, 3.2.4.1.
    - fire alarm systems, 3.2.4.22.
    - fire safety requirements, 3.1.17.1.
    - and means of egress, 9.9.1.3.
    - and seating, 3.3.2.2.
  - Odour removal equipment, 6.8.1.3., 9.33.6.14.
  - Office areas, 4.1.5.3.
  - Oil-burning equipment, 6.2.1.5., 9.33.5.2.
  - Open-air storage garages, 9.10.18.8.
  - Open-air storey
    - access route, 3.2.5.4.
    - definition, 1.4.1.2.[A]
    - exposing building face, 9.10.14.4.
    - fire containment exception, 3.2.1.5., 3.2.2.80.
    - low-hazard industrial occupancy (Group F, Division 3), 3.2.2.90.
    - storage garages, 6.3.1.4.
    - unprotected openings, 3.2.3.10.
  - Openings
    - (see also Unprotected openings)
    - through barricades, 8.2.1.3.
    - in barrier-free path of travel, 3.8.3.2.
    - care, treatment or detention occupancy, 3.3.3.2.
    - for ducts, 6.3.2.9., 9.10.5.1., 9.33.6.10.
    - for escalators, 3.2.8.2.

in exposing building face, 9.10.14., 9.10.15.  
 in exterior walls, 3.2.3.13., 3.2.3.17., 9.10.12.3.  
 for fire dampers, 9.24.3.7.  
 fire protection, 9.10.1.3.  
 in fire separations, 3.1.8.1., 3.1.8.6., 3.2.3.13., 3.3.3.2.,  
 3.4.4.4., 9.10.5., 9.10.9.3., 9.10.13., 9.10.13.8.  
 through floor assemblies, interconnected floor  
 spaces, 3.2.8.  
 in garage floors, 3.3.5.4.  
 in guards, 9.8.8.5.  
 guards for, 3.3.1.18., 3.4.6.6.  
 in membrane ceilings, 3.1.9.6., 9.10.5.  
 for moving walks, 3.2.8.2.  
 for natural ventilation, 9.32.2.2.  
 near exterior exits, 9.9.4.4. - 9.9.4.6.  
 onto landings, 3.4.6.4.  
 in repair garages, 3.3.3.2.  
 for stairways, 3.2.8.2.  
 support of masonry above, 9.20.5.2.  
 in walls above adjoining roof, 9.10.12.2.  
 in walls exposed to adjoining roof, 3.2.3.15.  
 Operating rooms, 3.3.3.6., 4.1.5.3.  
 Oriented strand board (see OSB)  
 Orphanages, 3.2.4.3.  
 OSB  
 as cladding, 5.9.1.1., 9.27.2.4., 9.27.3.6., 9.27.5.,  
 9.27.10.  
 fire blocks, 9.10.16.3.  
 fire protection of soffits, 9.10.12.4.  
 fire stopping, 3.1.11.7.  
 as interior finish, 9.29.9.  
 material, 9.3.2.4.  
 material standard, 5.9.1.1., 9.23.15.2., 9.23.16.2.,  
 9.23.17.2., 9.27.10.1., 9.29.9.1., 9.30.2.2.  
 as roof sheathing, 9.3.2.4., 9.23.3.5., 9.23.16.2.  
 as siding, 9.27.2.4., 9.27.3.6., 9.27.5., 9.27.10.  
 as subflooring, 9.3.2.4., 9.23.15.2., 9.23.15.5.  
 thickness, 9.3.2.7.  
 as underlay, 9.30.2.  
 as wall sheathing, 9.3.2.4., 9.23.3.5., 9.23.10.2.,  
 9.23.13., 9.23.17.2., 9.23.17.5.  
 Outdoor places of assembly, 3.3.2.11.  
 Outdoor process equipment, 3.2.3.21.  
 Outdoors  
 air quality, 6.2.1.2., 6.3.2.14.  
 air supply rates, 6.3.1.1., 6.3.1.4.  
 design temperatures, 1.1.3.1., 5.2.1.1., 5.3.1.2.,  
 5.5.1.2., 6.2.1.2., 9.33.3.2., 9.33.5.1.  
 Outlet boxes, electrical  
 combustible, in noncombustible construction,  
 3.1.5.2.  
 penetrating fire separations, 3.1.9.2., 3.1.9.3.,  
 3.1.9.4., 9.10.5.1., 9.10.9.6.  
 Ovens, fire protection, 9.10.22.  
 Owner, definition, 1.4.1.2.[A]  
 Oxidizing gases (see Combustible gases)

## P

Paint  
 in noncombustible construction, 3.1.5.2.  
 on steel columns, 9.17.3.3., 9.23.8.2.  
 Parapets  
 design, 4.1.8.18., 5.6.2.2., 9.20.6.5.  
 firewalls as, 3.1.10.4.  
 in noncombustible construction, 3.1.5.3.  
 Parging  
 of above-grade masonry, 9.20.13.9.  
 for dampproofing, 9.13.2.3., 9.13.2.4.  
 of foundation walls, 9.15.6.  
 for protection of insulation, 9.25.2.3.  
 for waterproofing, 9.13.3.3.  
 Parking areas  
 access, 3.8.2.5.  
 barrier-free path of travel, 3.8.2.5.  
 ventilation, 6.3.1.4.  
 Parking decks on roofs, 4.1.5.5.  
 Parking garages (see Storage garages)  
 Parking structures, structural design basis, 4.4.2.1.  
 Particleboard  
 as interior finish, 9.29.9.  
 material standard, 9.23.15.2., 9.29.9.1., 9.30.2.2.  
 subflooring, 9.23.15.2.  
 thickness, 9.3.2.7.  
 underlay, 9.30.2.2.  
 Partitions  
 dead loads, 4.1.4.1.  
 definition, 1.4.1.2.[A]  
 exceptions for mezzanines, 3.2.8.2.  
 in lieu of sliding doors, 3.3.1.12.  
 in noncombustible construction, 3.1.5.16.  
 sliding glass, 3.3.1.19.  
 Party walls  
 airtightness, 9.36.2.10.  
 continuity of insulation, 9.36.2.5.  
 definition, 1.4.1.2.[A]  
 fire separations, 9.10.9.  
 as firewalls, 3.2.3.4., 9.10.11.1.  
 not as firewalls, 9.10.11.2.  
 Passageways  
 as exits, 3.4.1.4.  
 as means of egress, 9.9.2.1.  
 vehicular, 3.2.3.18.  
 Passageways, exterior  
 as access to exit, 9.9.9.3.  
 exemptions, 3.4.4.3.  
 as exits, 3.3.1.15., 3.4.1.5.  
 fire-resistance rating, 9.10.8.8.  
 fire separations, 9.9.4.2.  
 flame-spread rating, 9.10.17.4.  
 interior finishes, 3.1.13.10.  
 as means of egress, 3.2.2.12.  
 Passenger pickup areas, barrier-free, 3.8.3.1.  
 Path of travel, barrier-free  
 access to storeys served by escalators and moving  
 walks, 3.8.2.3.  
 apartment buildings, 9.5.2.3.  
 application of Code, 3.8.2.1.

- doors and doorways, 3.8.3.6.
- drinking fountains, 3.8.3.10.
- elevators, 3.3.1.7., 3.8.2.3., 3.8.3.2., 3.8.3.7.
- floor areas, 3.3.1.7., 9.5.2.2.
- parking areas, 3.8.2.5.
- signs, 3.8.2.4.
- universal washrooms, 3.8.3.12.
- walkways, 3.8.3.3.
- wheelchair spaces, 3.8.2.3., 3.8.3.21.
- width, 3.8.3.2.
- Patients' bedrooms, 3.3.3.5., 3.4.1.6., 4.1.5.3.
- Pedestrian traffic, construction sites, 8.2.3.1., 8.2.3.2.
- Penetrations in fire assemblies, 3.1.9.1.
- Penthouses, 3.6.1.1., 4.1.8.1.
- Perched groundwater, 1.4.1.2.[A], 4.2.5.5.
- Permafrost, 4.2.4.10., 9.15.1.2.
- Piers
  - anchoring to, 9.20.11.6.
  - dimensions, 9.35.3.4.
- Pier-type foundations, 9.15.2.3.
- Pilasters, 9.15.5.3., 9.20.8.4.
- Pile foundations, 1.4.1.2.[A], 4.1.8.16., 4.2.3.8.
- Pipes
  - clearances, 6.7.1.2., 9.33.8.3.
  - combustible (see Combustible piping)
  - corrosion protection, 9.31.2.2.
  - coverings, 3.6.5.5.
  - drainage, 9.14.3.
  - expansion and contraction, 6.7.1.1., 9.33.8.1.
  - for heating and cooling systems, 9.33.8.
  - insulation, 3.6.5.5., 6.5.1.1., 9.33.8.2., 9.33.8.4.
  - materials, 6.7.1.1., 9.14.3.1.
  - for medical gas, 3.7.3.1.
  - metal, 9.14.3., 9.31.2.2.
  - in noncombustible construction, 3.1.5.18., 3.1.5.19.
  - penetrating fire separations, 3.1.9.2., 3.1.9.5., 9.10.9.6., 9.10.9.7.
  - plumbing, 9.31.2.2.
  - polypropylene, 3.1.5.19.
  - for service water heating systems, 9.36.4.4.
  - in shafts, 6.7.1.5.
  - sleeves for, 6.7.1.4., 9.33.8.4.
  - standards for drainage, 9.14.3.1.
  - support, 6.7.1.1., 9.33.8.1.
- Plans, specifications and calculations
  - administration, 2.2.[C]
  - energy performance compliance, 2.2.8.[C]
  - environmental separation, 2.2.5.2.[C]
  - fire protection components, 2.2.3.[C]
  - foundations, 2.2.4.[C], 2.2.4.6.[C], 2.2.4.7.[C]
  - general information, 2.2.2.1.[C]
  - HVAC systems, 2.2.6.2.[C], 6.1.3.1.
  - site, 2.2.2.2.[C]
  - sprinkler systems, 2.2.3.2.[C]
  - structural, 2.2.4.[C], 4.1.1.4.
- Plastering, 9.29.4.
- Plaster, material standard, 9.29.4.1.
- Plates
  - fastening of, 9.23.3.4.
  - sill, 9.23.7.
  - wall, 9.23.11.
- Platforms, serving as roofs, 9.26.1.1.
- Plenums
  - in air duct systems, 3.6.5.1.
  - ceiling assemblies used as, 3.1.9.7.
  - ceilings used as, 3.6.4.3.
  - clearances, 3.6.5.6., 6.3.2.6., 9.33.6.8.
  - combustible, 9.33.6.2.
  - in combustible construction, 3.1.4.3.
  - connectors, 9.33.6.2.
  - construction, 6.3.2.3., 9.33.6.6.
  - coverings, 3.6.5.4., 9.33.6.4.
  - crawl spaces used as, 9.18.7.1.
  - definition, 1.4.1.2.[A]
  - fittings, 6.3.2.3., 9.33.6.2.
  - furnace, 9.33.6.6., 9.33.6.7., 9.33.6.8.
  - insulation, 9.33.6.4.
  - linings, 3.6.5.4., 6.3.2.5., 9.33.6.4.
  - materials, 6.3.2.3., 9.33.6.2., 9.33.6.3.
  - in noncombustible construction, 3.1.5.18.
  - return air, 3.6.4.3., 9.32.3.4.
- Plumbing
  - barrier-free design, 3.8.2.8.
  - combustible piping, 9.10.9.7.
  - in dwelling units, 3.7.2., 9.31.
  - facilities required, 3.7.2., 3.8.2.8., 9.31.4.
  - fixtures, 3.1.5.20., 3.7.2., 9.31.4.
- Plumbing services, 7
- Plumbing systems
  - definition, 1.4.1.2.[A]
  - design and installation, 7.1.2.1.
  - in dwelling units, 7.1.3.2.
  - facilities required, 7.1.3.
- Plywood
  - as cladding, 5.9.1.1., 9.27.2.4., 9.27.3.6., 9.27.5., 9.27.8.
  - fastening, 9.29.6.3.
  - fire blocks, 9.10.16.3.
  - fire protection of soffits, 9.10.12.4.
  - fire stops, 3.1.11.7.
  - grooved, 9.29.6.2.
  - as interior finish, 9.29.6.
  - lapped strips, 9.27.8.5.
  - material, 9.3.2.4.
  - material standards, 5.9.1.1., 9.23.15.2., 9.23.16.2., 9.23.17.2., 9.27.8.1., 9.30.2.2.
  - as roof sheathing, 9.3.2.4., 9.23.3.5., 9.23.16.2., 9.23.16.6., 9.23.16.7.
  - as siding, 5.9.1.1., 9.27.8.
  - as subflooring, 9.23.3.5., 9.23.15.
  - thickness, 9.3.2.7., 9.29.6.1.
  - as underlay, 9.30.2.
  - as wall sheathing, 9.23.3.5., 9.23.10.2., 9.23.13., 9.23.17.2., 9.23.17.5.
- Police stations, 3.1.2.4.
- Pool heaters, 9.36.4.2.
- Portable fire extinguishers, 3.2.5.16., 9.10.20.4., 9.10.21.8.
- Post-disaster buildings
  - definition, 1.4.1.2.[A]
  - earthquake load and effects, 4.1.8.1., 4.1.8.5., 4.1.8.10., 4.1.8.13., 4.1.8.14.

- loads and effects, 4.1.2.1.
  - snow loads, 4.1.6.2.
  - structural loads, 5.2.2.1.
  - wind loads, 4.1.7.3.
  - Potable water systems, 9.31.3.
  - Power-operated doors, 3.8.2.7., 3.8.3.6.
  - Precipitation
    - ingress, 5.6.1.1., 5.6.2.1., 9.27.2.
    - protection from, 5.6.1.1., 5.6.2.1., 9.20.13., 9.26.
  - Pressure piping, 6.2.1.5., 9.33.5.2.
  - Pressure vessels, 6.2.1.5., 9.33.5.2.
  - Principal entrances
    - access routes, 3.2.5.4., 3.2.5.5.
    - door requirements, 9.7.2.1.
    - as exits, 3.3.1.17., 3.4.2.6.
    - latching, locking and opening mechanisms, 9.9.6.7.
    - manual fire alarm stations, 3.2.4.16.
    - as means of egress, 9.9.2.4.
  - Private sewage disposal systems (see Sewage disposal systems, private)
  - Process plants
    - basements and pits, 3.3.6.9.
    - definition, 1.4.1.2.[A]
    - volatile liquids, 3.3.6.9.
  - Protected floor space, 1.4.1.2.[A], 3.2.8.5., 3.4.3.2.
  - Protection from freezing (see also Frost action)
    - concrete, 9.3.1.9.
    - concrete stairs, 9.8.10.3.
    - excavations, 9.12.1.3.
    - fire hose stations, 9.10.21.9.
    - fire protection systems, 3.2.5.17., 9.10.20.5.
    - foundations, 9.12.1.3.
    - gypsum board, 9.29.5.10.
    - HVAC systems and equipment, 6.2.1.6., 9.33.4., 9.33.4.5.
    - masonry, 9.20.14.1.
    - stucco, 9.28.6.1.
  - Protection from high temperature piping, 6.7.1.4., 9.33.8.4.
  - Public areas (see also Corridors)
    - glass doors in, 3.3.1.19.
    - glass used in, 3.3.1.14., 9.6.1.4.
    - transparent panels used in, 3.3.1.19., 9.6.1.4., 9.7.5.
    - windows in, 3.3.1.19., 9.7.5.
  - Public corridors (see also Corridors)
    - access to exit, 9.9.9.1., 9.9.9.3.
    - containing occupancy, 9.10.17.7.
    - definition, 1.4.1.2.[A]
    - doors and door hardware, 3.3.1.13.
    - doors opening onto, 9.10.13.12.
    - emergency lighting, 3.2.7.3., 9.9.12.3.
    - exit signs, 3.4.5.2.
    - fire separations, 3.3.1.4.
    - flame-spread rating, 3.1.13.6., 9.10.17.2., 9.10.17.5.
    - lighting, 3.2.7.1., 9.9.12.2.
    - serving sprinklered buildings, 3.3.1.1.
    - smoke control measures, 3.2.6.2.
    - travel distance to exit, 3.4.2.5.
    - width, 3.3.1.9.
  - Public thoroughfares, 3.2.3.9., 3.2.5.6., 9.10.20.3.
  - Public ways
    - combustible projections near, 3.2.3.6.
    - at construction sites, 8.2.1.1., 8.2.3.2., 8.2.3.5., 8.2.4.1.
    - definition, 1.4.1.2.[A]
  - Pyritic soil and rock
    - drainage, 9.14.2.1., 9.14.4.1.
    - beneath floors-on-ground, 9.16.2.2.
    - and footings, 9.15.3.2.
    - foundations on, 9.4.4.4.
    - not in backfill, 9.12.3.3.
- ## R
- Raceways
    - collapse of, in firewalls, 3.1.10.1.
    - in combustible construction, 3.1.4.4.
    - in exit areas, 3.4.4.4.
    - and fire alarm systems, 3.2.4.2.
    - in noncombustible construction, 3.1.5.21., 3.1.5.23.
    - penetrating fire separations, 3.1.9.2., 9.10.9.6.
    - in plenums, 3.6.4.3.
  - Radiation from interior fires, control, 3.2.3.1., 9.10.14., 9.10.15.
  - Radiators, 6.7.1.3., 9.33.7.1.
  - Radon gas infiltration (see also Soil gas control)
    - air barriers, 9.25.3.
    - depressurization system, 9.32.3.8.
    - and HVAC design, 6.2.1.1.
    - required resistance to, 5.4.1.1.
    - rough-in for subfloor depressurization system, 9.13.4.3.
  - Rafters
    - anchoring to masonry, 9.20.11.4.
    - continuity, 9.23.14.1.
    - deflection, 9.4.3.1.
    - dimensions, 9.23.4.2., 9.23.14.6., 9.23.14.7.
    - fastening, 9.23.3.4., 9.23.14.4.
    - framing around openings, 9.23.14.2.
    - hip and valley, 9.23.14.6.
    - installation, 9.23.14.4.
    - lumber grade, 9.3.2.1.
    - nailing, 9.23.3.4., 9.23.14.4.
    - ridge support, 9.23.14.8.
    - shaping, 9.23.14.5.
    - spans, 9.23.4.2., 9.23.4.5., 9.23.14.7.
    - support, 9.23.14.3., 9.23.14.7.
    - in wood-frame construction, 9.23.14.
  - Rain loads, 4.1.6.4., 4.1.6.12., 9.4.2.2. (see also Moisture index)
  - Rain penetration control, 5.6., 9.20.13., 9.26., 9.27.4.
  - Ramps
    - barrier-free, 3.8.2.2., 3.8.3.2., 3.8.3.5., 9.8.5.1.
    - barrier-free floor areas, 3.3.1.7.
    - basement, 3.4.5.2.

- at doors, 9.8.6.2., 9.9.4.4.
- for dwelling units, 9.8.1.
- as exits, 3.4.1.4., 9.8.1.3., 9.9.2.1.
- exit signs, 9.9.11.4.
- finishes, 9.8.9.6.
- in garages, 9.8.8.4.
- guards, 3.4.6.6., 3.8.3.5., 9.8.8.
- handrails, 3.4.6.5., 3.8.3.5., 9.8.7., 9.8.7.1.
- height, 9.8.5.5.
- height over, 9.8.5.3.
- for housing and small buildings, 9.8.5.
- landings on, 3.4.6.3., 9.8.6.
- loads, 9.8.9.1.
- rise, 9.8.5.5.
- safety requirements, 3.3.1.14.
- for secondary suites, 9.8.1.
- slip-resistance, 3.4.6.1., 9.8.9.6.
- slope, 3.4.6.7., 3.8.3.5., 9.8.5.4.
- width, 3.4.3.2., 9.8.5.2.
- Ranges (see Stoves)
- Receptacles, electrical, 9.34.1.1., 9.34.2.2.
- Recessed lighting fixtures, 3.2.7.2., 9.34.1.4.
- Recesses, 9.20.7.
- Referenced documents, 1.3.1., 1.5.1.[A]
- Reference house
  - definition, 9.36.5.2.
  - modeling of energy performance, 9.36.5.13. - 9.36.5.16.
- Refrigerating systems and equipment
  - in housing and small buildings, 9.33.9.
  - installation, 6.2.1.5., 6.6.1.1., 9.33.5.2., 9.33.9.1.
- Refuse
  - bins, 3.6.3.3.
  - chutes, 3.6.3.3., 5.8.1.1., 9.10.1.3.
  - combustible, 9.10.10.6.
  - rooms, 3.6.2.5., 3.6.3.3.
- Registers and outlets
  - (see also Air outlets; Diffusers)
  - exhaust, 6.3.2.10., 9.32.3.13.
  - heating, 9.33.6.10., 9.33.6.11.
  - over pipeless furnaces, 9.33.6.8.
  - ventilation, 9.32.3.5., 9.32.3.6.
- Reinforced concrete, 4.3.3.1., 9.3.1.1.
- Reinforcing
  - concrete block foundations, 9.20.15.2.
  - earthquakes, 9.20.1.2., 9.20.15.
  - glass block, 9.20.9.6.
  - insulating concrete form walls, 9.3.1.1., 9.15.4.5., 9.20.17.
  - masonry, 9.20.15.
  - stucco, 9.28.1.2., 9.28.4.5.
- Repair garages
  - definition, 1.4.1.2.[A]
  - fire separation requirements, 9.10.9.17.
  - in industrial occupancies, 3.3.5.4.
  - separation from care, treatment or detention occupancies, 3.3.3.2.
  - solid-fuel burning appliances prohibited in, 3.6.2.1.
- Residential fire warning systems, 3.2.4.21., 9.10.19.8.
- Residential occupancy (Group C)
  - (see also Dwelling units; Secondary suites)
  - below ground level, 3.2.2.15.
  - classification, 3.1.2.1., 9.10.2.
  - convalescent and children's homes as, 3.1.2.5.
  - definition, 1.4.1.2.[A]
  - door hold-open devices, 3.1.8.14.
  - emergency power for fire alarm systems, 3.2.7.8.
  - emergency power for lighting, 3.2.7.4.
  - fire access route design, 3.2.5.6.
  - fire alarm systems, 3.2.4.1., 3.2.4.11., 3.2.4.18., 9.10.18.
  - fire protection, 3.2.2.47. - 3.2.2.54.
  - fire-resistance rating, 9.10.8.
  - fire safety within floor areas, 3.3.1., 3.3.4.1.
  - fire separations, 9.10.9.11., 9.10.9.12., 9.10.9.14.
  - firewalls, 9.10.11.2.
  - flame-spread rating, 3.1.13.3., 9.10.17.
  - lighting requirements, 3.2.7.1.
  - location of smoke/fire dampers, 3.1.8.7.
  - occupant load, 3.1.17.1.
  - ramp slope maximum, 3.4.6.7.
  - smoke alarms, 3.2.4.20., 9.10.19.
  - smoke control measures, 3.2.6.2.
  - sprinkler piping, 3.2.5.13.
  - sprinkler systems, 3.2.5.12.
  - storage lockers, 3.1.5.17.
- Resilient flooring, 9.30.2.1., 9.30.5.
- Resistance to deterioration, 5.1.4.2., 9.20.16.1.
  - (see also Corrosion protection; Corrosion resistance; Decay, protection against)
- Resistance to forced entry
  - doors, 9.7.5.2.
  - windows, 9.7.5.3.
- Resistant design, earthquake load, 4.1.3.2.
- Restaurants, 3.2.4.1., 3.3.2.15., 6.3.1.7.
- Return air inlets, 9.33.6.12.
- Return air systems, 3.6.5.8., 6.3.2.11., 9.33.6.13.
  - (see also Air intakes; Ducts)
- Return ducts, 1.4.1.2.[A], 6.3.2.11., 9.33.6.13.
- Review of work, 2.2.7.[C]
- Revolving doors, 3.4.6.15., 9.9.6.4.
- Rim joists
  - airtightness, 9.36.2.10.
  - definition, 1.4.1.2.[A]
  - effective thermal resistance, 9.36.2.6.
  - and exterior wall framing, 9.23.3.4.
- Risers
  - aisle steps, 3.3.2.5.
  - bleacher steps, 3.3.2.12.
  - curved flights, 3.3.1.16.
  - dimensions, 3.4.6.8., 9.8.4.1.
  - minimum number, 3.4.6.2., 9.8.3.2.
  - restaurant stairs, 3.3.2.15.
  - uniformity and tolerances, 3.4.6.8., 9.8.4.4.
- Rock
  - bearing pressure, 9.4.4.1., 9.4.4.2.
  - definition, 1.4.1.2.[A]
  - foundations on, 9.12.2.2.
- Rock, pyritic
  - drainage, 9.14.2.1., 9.14.4.1.
  - beneath floors-on-ground, 9.16.2.2.
  - and footings, 9.15.3.2.

- foundations on, 9.4.4.4.
- not in backfill, 9.12.3.3.
- Roof aggregate, 9.26.11.1., 9.26.11.4.
- Roof arches (see Roof and ceiling framing)
- Roof assemblies
  - effective thermal resistance, 9.36.2.6.
  - fire-resistance rating, 3.1.7.5., 3.2.2.17., 3.2.2.25., 3.2.2.35., 3.2.2.49., 3.2.2.52., 3.2.2.56., 3.2.2.60., 3.2.2.66., 3.2.2.76., 3.2.2.81., 3.2.2.83.
  - non-contiguous, 3.1.15.2., 3.2.2.50., 3.2.2.58.
- Roof and ceiling framing
  - bearing on cavity walls, 9.20.8.2.
  - fire-resistance rating, 3.1.7.3.
  - in heavy timber construction, 3.1.4.7.
  - loads on, 9.4.2.2., 9.4.2.4.
  - in noncombustible construction, 3.1.5.3.
  - sheathing, 9.3.2.4., 9.23.16.
  - trusses, 9.4.2.2., 9.23.5.5., 9.23.14.11.
  - in wood-frame construction, 9.23.14.
- Roof coverings, 3.1.15.1., 3.1.15.2., 9.26. (see also Roofing)
- Roofing
  - (see also Roof covering)
  - asphalt shingles, 5.6.1.2., 5.9.1.1., 9.26.1.3., 9.26.2.1., 9.26.7., 9.26.8.
  - bituminous, 9.26.2.1.
  - built-up, 5.9.1.1., 9.26.11.
  - built-up materials, 9.26.2.1.
  - cedar shingles and shakes, 9.26.2.1., 9.26.3.1., 9.26.10.
  - clay tile, 9.23.4.5.
  - concrete tile, 5.9.1.1., 9.23.4.5., 9.26.2.1., 9.26.17.
  - definition, 9.26.1.1.
  - elastomeric sheets, 5.9.1.1., 9.26.2.1.
  - fasteners, 9.26.2.3., 9.26.2.4.
  - flashing, 9.26.4.
  - glass-reinforced polyester, 9.26.14.
  - installation alternatives, 9.26.1.3.
  - installation of materials, 9.26.2.2.
  - installation standards, 5.6.1.2.
  - material standards, 9.26.2.1.
  - metal, 9.26.13.
  - nails, 9.26.2.3.
  - over wood-based sheathing, 9.26.11.8.
  - polyvinyl chloride sheets, 5.6.1.2., 5.9.1.1., 9.26.2.1., 9.26.16.
  - prefabricated bituminous membranes, 9.26.2.1.
  - prefabricated modified bituminous membranes, 5.9.1.1.
  - requirement for, 5.6.1.1., 9.26.1.2.
  - rubberized asphalt, 5.6.1.2., 9.26.2.1., 9.26.15.
  - selvage, 9.26.12.
  - slope of, 9.26.3.
  - standards for, 5.9.1.1.
  - staples, 9.26.2.4.
  - vegetative, 5.6.1.2.
  - wood shakes, 9.26.10.
  - wood shingles, 9.26.9.
- Roofs
  - access, 3.2.5.3.
  - acting as diaphragms, 4.1.8.15., 4.1.8.18.
  - anchorage of, 9.20.11.1., 9.20.11.4., 9.20.17.6.
  - appliances mounted on, 3.6.1.5., 6.4.1.2., 9.10.1.3.
  - arched or curved, snow loads, 4.1.6.10.
  - beams, 9.23.4.2., 9.23.4.5.
  - considered as walls, 3.2.1.3., 9.10.1.1.
  - definition, 9.26.1.1.
  - deflection, 9.4.3.1.
  - drains, 5.6.2.2., 9.26.18.2.
  - egress from, 3.3.1.3., 9.9.7.1.
  - fire blocks, 9.10.16.1.
  - fire rating, 9.10.3.3.
  - fire-resistance rating, 9.10.8.1., 9.10.8.2., 9.10.8.7.
  - fire-retardant-treated wood, 3.1.14.1.
  - fire separations, 3.2.2.13.
  - firewall termination, 3.1.10.3.
  - framing, 9.23.4., 9.23.14.
  - framing around openings, 9.23.14.2.
  - gable, snow loads, 4.1.6.9.
  - guards, 3.3.1.18.
  - heavy timber construction, 3.1.4.7., 3.2.2.16.
  - helipad loads, 4.1.5.13.
  - insulation, 9.25.2.2.
  - joists, 9.23.4.2., 9.23.4.5., 9.23.14.1., 9.23.14.7., 9.23.14.9.
  - loads due to use, 4.1.5., 9.4.2.4.
  - metal decking, 3.1.14.2.
  - multi-level, 4.1.6.5.
  - in noncombustible construction, 3.1.5.3.
  - parapets, 3.1.5.3., 3.1.10.4., 4.1.8.18., 5.6.2.2., 9.20.6.5.
  - rain loads, 4.1.6.4., 5.6.2.2., 9.4.2.2.
  - ridge support, 9.23.14.8.
  - sheathing installation, 9.23.16.3., 9.23.16.4., 9.23.16.6.
  - sheathing materials, 9.3.2.1., 9.3.2.4., 9.23.16.2., 9.23.16.5., 9.23.16.7.
  - sloped, 4.1.6.12., 9.10.1.1.
  - snow loads, 4.1.6.2., 4.1.6.3., 4.1.6.5., 4.1.6.7., 4.1.6.8., 4.1.6.11., 4.1.6.12., 9.4.2.2.
  - sprinklers in lieu of structural fire resistance, 9.10.8.2.
  - supporting an occupancy, 3.2.2.13., 9.10.8.7.
  - trusses, 9.4.2.2., 9.23.5.5., 9.23.14.11.
  - of underground structures, 9.13.1.1., 9.13.3., 9.25.3.5.
  - venting, 9.19.1.
  - wind loads, 4.1.7.6., 5.2.2.2.
- Roof spaces (see Attics or roof spaces)
- Roof-top
  - air-handling equipment, 6.3.2.17.
  - appliances, 3.6.1.5., 3.6.2.1., 6.4.1.2., 9.10.1.3.
  - enclosures, 3.2.1.1., 3.2.2.14., 9.10.4.4.
- Rooms, height, 3.7.1.1., 9.5.3.
- Runners, sheet steel framing
  - fastening, 9.24.3.1.
  - in fire-rated walls, 9.24.3.2.
  - installation, 9.24.3.1.
  - metal thickness, 9.24.1.3., 9.24.2.3., 9.24.2.4.
  - at openings, 9.24.2.4.
- Runs, stairs
  - aisle steps, 3.3.2.5.

bleacher steps, 3.3.2.12.  
curved flights, 3.3.1.16.  
definition, 1.4.1.2.[A]  
landing dimensions, 3.4.6.4.  
minimum, 3.4.6.8.  
rectangular treads, 9.8.4.2.  
tapered treads, 3.3.1.16., 3.4.6.9., 9.8.4.3.  
uniformity and tolerances, 9.8.4.4., 9.8.4.5.

## S

Safety glass  
in guards, 9.8.8.7.  
on revolving doors, 3.4.6.15.  
standards for, 9.6.1.2.  
transparent panels and doors, 3.3.1.19., 3.4.1.8.  
uses, 9.6.1.4.  
washrooms, 3.7.2.5.

Safety of public, construction and demolition sites, 8.2.

Sanitary drainage systems, 1.4.1.2.[A], 9.31., 9.31.2.1., 9.31.5.

Sawtooth roofs, wind loads, 4.1.7.6.

Scaffolding, 4.1.1.3.

Screens  
in exhaust outlets, 6.3.2.9., 9.32.3.13.  
in intake openings, 6.3.2.9., 9.32.3.13.  
in natural ventilation openings, 9.32.2.2.

Screw installation  
gypsum board, 9.29.5.9.  
sheet steel framing, 9.24.1.5., 9.24.3.1.

Screws  
dimensions, 9.23.3.5.  
fastening to steel studs, 9.24.1.4.  
for gypsum board, 9.29.5.5., 9.29.5.7.  
sheathing, 9.23.3.5.  
standard for, 9.23.3.1., 9.24.1.4., 9.29.5.7.  
subflooring, 9.23.3.5.  
wood-frame construction, 9.23.3.5.

Sealants  
cladding, 9.27.4., 9.27.8.4., 9.27.9.3., 9.27.9.4., 9.27.10.3.  
material properties, 9.27.4.2.  
material standards, 9.27.4.2.  
in noncombustible construction, 3.1.5.2.  
siding, 9.27.4., 9.27.8.4., 9.27.9.3., 9.27.9.4., 9.27.10.3.  
windows, doors and skylights, 9.7.6.2.

Sealing  
(see also Air barrier systems; Soil gas control; Waterproofing)  
against precipitation, 5.6.2., 9.27.4.  
against soil gas, 9.25.3.6.  
air barrier systems, 5.4.1.2., 9.10.9.16., 9.10.9.17., 9.25.3.3.  
at chimneys, 9.21.5.2., 9.25.3.3.  
ducts, 3.6.5.3., 6.3.2.19., 9.32.3.11., 9.33.6.3., 9.33.6.7.  
floors-on-ground, 9.25.3.6.  
at gas vents, 9.25.3.3.  
ground cover, 9.18.6.2.

sill plates, 9.23.7.2.  
windows, doors and skylights, 9.7.6., 9.20.13.11., 9.27.4.

Seasonally and intermittently occupied buildings  
application of Part 9, 9.1.1.1.  
ventilation, 6.3.1.3.

Seating  
aisle width, 3.3.2.1.  
not fixed, 3.3.2.2.  
occupant load, 3.3.2.2., 4.1.5.10.  
in showers, 3.8.3.16.  
wheelchair space, 3.8.2.3., 3.8.3.21.

Secondary suites  
ceiling height, 9.5.3.1.  
definition, 1.4.1.2.[A]  
doors, direction of swing, 9.9.6.5.  
doors in means of egress, 9.9.6.  
doorways, 9.5.5., 9.9.6.2., 9.9.6.3.  
egress, 9.9.9.  
electrical outlets, 9.34.2.3.  
fire protection, 9.10.8.  
fire-resistance rating, 9.10.8.8.  
fire separations, 9.9.4., 9.10.9.4., 9.10.9.14., 9.10.9.15., 9.10.10.4., 9.10.12.3.  
firewalls, 9.10.11.2.  
floor area limits, 9.1.2.1.  
guards, 9.8., 9.8.8.  
handrails, 9.8., 9.8.7.  
heating and air-conditioning, 9.33.1.1., 9.33.3.1., 9.33.3.2.  
height of rooms and spaces, 9.5.3.  
landings, 9.8.6., 9.8.6.3.  
ramps, 9.8., 9.8.5.2.  
smoke alarms, 9.10.19.  
soffit protection, 9.10.12.4.  
sound control, 9.11.  
spatial separation, 9.10.15.  
sprinkler systems, 3.2.5.12.  
stairs, 9.8.  
ventilation, 9.32.1.2., 9.32.3.8., 9.32.3.9.

Seismic data, 1.1.3.

Seismic isolation  
definitions and analysis, 4.1.8.19.  
design provisions, 4.1.8.20.

Seismic loads (see Earthquake design)

Self-closing devices, 3.1.8.13., 3.4.6.13., 9.9.6.7., 9.10.13.10., 9.10.13.15.

Self-contained emergency lighting, 3.2.7.4., 9.9.12.3.

Self-service storage buildings, 3.9.

Self-storage warehouses, 3.3.5.9., 9.9.6.4.

Septic disposal beds, 9.14.6.2.

Service lines under buildings, 3.2.3.21.

Service rooms  
access to exit, 9.9.7.5.  
application of Code, 3.6.1.1.  
and building height, 9.10.4.4.  
carbon monoxide alarms, 9.32.3.9.  
construction supporting, 9.10.8.5.  
definition, 1.4.1.2.[A]  
doors, 9.10.13.12.  
doors and door hardware, 3.3.1.13., 3.4.6.11.

- emergency lighting, 3.2.7.3.
- exits, 3.4.4.4., 3.6.2.2.
- fire alarm systems, 3.2.4.2.
- fire detectors, 3.2.4.10.
- fire resistance of supporting construction, 3.1.7.5.
- fire separations, 3.6.2.1., 9.10.10.3.
- heat and smoke detectors, 9.10.18.4.
- for housing and small buildings, 9.10.10.
- loads on floor or roof, 4.1.5.3.
- opening into exit, 9.9.5.9.
- ramps and stairways, 3.3.1.14.
- roof-top, 3.2.1.1., 3.2.2.14., 9.10.4.4.
- service equipment in, 3.6.2.3.
- under exits, 9.9.5.8.
- Service spaces**
  - and building height, 3.2.1.1.
  - definition, 1.4.1.2.[A]
  - egress, 3.3.1.24.
  - emergency lighting, 3.2.7.3.
  - exits, 3.4.4.4.
  - fire alarm systems, 3.2.4.18.
  - horizontal (see Horizontal service spaces)
  - lightning protection systems, 3.6.1.3.
  - means of egress, 3.3.1.3.
  - protection of electrical conductors, 3.2.7.10.
  - ramps and stairways, 3.3.1.14.
  - signage, 3.3.1.24.
  - sprinkler systems, 3.2.5.14.
  - storage use prohibition, 3.6.1.4.
  - travel distance to exit, 3.4.2.4.
  - vertical (see Vertical service spaces)
- Service water heaters**
  - definition, 1.4.1.2.[A]
  - in housing and small buildings, 9.31.6.
  - indirect, 1.4.1.2.[A]
  - protection from corrosion, 9.31.6.3.
  - steel, 9.31.6.3.
  - storage type, 1.4.1.2.[A], 9.31.6.2., 9.31.6.3.
- Service water heating systems**
  - energy efficiency, 9.36., 9.36.4.
  - energy performance calculations, 9.36.5.8.
  - energy performance modeling, 9.36.5.12., 9.36.5.16.
  - equipment efficiency, 9.36.4.2.
  - temperature controls, 9.36.4.5.
- Sewage disposal, 9.14.5., 9.31.2.1., 9.31.5.
- Sewage disposal systems, private, 1.4.1.2.[A], 9.31.2.1., 9.31.5.2.
- Shafts**
  - installation, 6.7.1.5.
  - opening into an interconnected floor space, 3.2.8.4.
  - piping in, 6.7.1.5.
  - service, 9.10.1.3.
- Shakes, wood**
  - cladding, 9.27.7.
  - dimensions, 9.27.7.2., 9.27.7.6.
  - eave protection, 9.26.5.1., 9.26.10.7.
  - flashing, 9.26.10.6.
  - grades, 9.26.10.8., 9.27.7.1.
  - installation, 9.27.5., 9.27.7.3.
  - material standards, 5.9.1.1., 9.26.2.1., 9.27.7.1.
  - roofing, 9.26.10.
  - spacing and joints, 9.26.10.3.
  - underlay, 9.26.10.2.
- Shallow foundations**
  - damaged, 4.2.6.4.
  - definition, 1.4.1.2.[A]
  - design, 4.2.6.1.
  - footing design, 9.4.4.1.
  - incorrect placement, 4.2.6.3.
  - support, 4.2.6.2.
- Sheathing**
  - (see also Subflooring)
  - for braced wall panels, 9.23.13.6.
  - for bracing and lateral support, 9.23.10.2.
  - in exposing building face, 9.10.14.5., 9.10.15.2.
  - fastening, 9.23.3.5.
  - fibreboard as, 9.23.16.7.
  - installation, 9.23.3.5., 9.23.16.3., 9.23.16.4., 9.23.17.4., 9.23.17.5.
  - insulating, 9.20.13.6., 9.27.3.4.
  - low permeance, 9.25.5.1.
  - lumber as, 9.3.2.1., 9.23.16.5., 9.23.17.2., 9.23.17.4.
  - material standards, 9.23.16.2., 9.23.17.2., 9.26.2.1.
  - in noncombustible construction, 3.1.5.3.
  - OSB as, 9.3.2.4., 9.23.16.2., 9.23.17.2.
  - plywood as, 9.3.2.4., 9.23.16.2., 9.23.17.2.
  - roofs, 9.3.2.1., 9.3.2.4., 9.23.16., 9.26.2.1.
  - on steel studs, 9.24.1.5.
  - beneath stucco, 9.28.1.1., 9.28.4.2.
  - support, 9.23.10.5., 9.24.3.4.
  - thickness, 9.23.16.7., 9.23.17.2.
  - waferboard as, 9.3.2.4., 9.23.16.2., 9.23.17.2.
  - walls, 9.3.2.1., 9.3.2.4., 9.23.17.
- Sheathing membranes**
  - installation, 9.27.3.3. - 9.27.3.6.
  - insulation, 9.27.3.5.
  - interior of masonry walls, 9.20.13.9.
  - mansard roofs, 9.23.17.6.
  - material standard, 9.27.3.2.
  - for precipitation protection, 9.27.3.1. - 9.27.3.6.
- Sheathing paper (see Sheathing membranes)**
- Shingles, asphalt**
  - eave protection, 9.26.5.1., 9.26.7.7.
  - flashing, 9.26.4.
  - installation, 9.26.1.3., 9.26.7., 9.26.8.
  - material standards, 5.9.1.1., 9.26.2.1.
  - nails, 9.26.2.3.
  - slope, 9.26.3.1.
  - staples, 9.26.2.4.
  - underlay, 9.26.6.
- Shingles, wood**
  - cladding, 9.27.7.
  - dimensions, 9.26.9.3., 9.27.7.2., 9.27.7.6.
  - eave protection, 9.26.9.8.
  - exposure, 9.26.9.6.
  - flashing, 9.26.9.7.
  - grade, 9.26.9.2., 9.27.7.1.
  - installation, 9.26.9.4., 9.27.2.4., 9.27.5., 9.27.7.3.
  - materials, 9.27.7.1.
  - material standards, 5.9.1.1., 9.26.2.1., 9.27.7.1.
  - roofing, 9.26.9.
- Shop drawings, review of work, 2.2.7.3.[C]



- Showers, 3.8.3.16.  
 Sidelights, 3.3.1.19., 9.6.1.4., 9.7.1.1., 9.7.2.1., 9.9.4.3.  
 Sidewalks, 4.1.5.3., 8.2.1.2., 8.2.3.1.  
 Siding (see Cladding)  
 Signs  
   barrier-free accessibility, 3.8.2.4., 3.8.2.10., 3.8.3.9.  
   construction sites, 8.2.3.3., 8.2.3.5., 8.2.4.1.  
   directing traffic, 8.2.4.3.  
   egress points, 3.3.1.24.  
   emergency crossover access to floor areas, 3.4.6.18.  
   exit obstruction prevention, 3.4.6.11., 9.9.11.2.  
   exits, 3.4.5.1., 9.9.11., 9.9.11.3.  
   floor numbers, 3.4.6.19., 3.5.4.2., 9.9.11.5.  
   graphical symbols, 3.4.5.2.  
   occupant load, 3.1.17.1.  
   stairs and ramps, 9.9.11.4.  
 Silencing devices, 3.2.4.18., 3.2.4.20., 3.2.4.22., 3.2.6.7.  
 Sill plates  
   dimensions, 9.23.7.1.  
   leveling, 9.23.7.2.  
   sealing, 9.23.7.2.  
   standard for, 9.23.7.  
 Site plans, 2.2.2.2.[C]  
 Site stability, earthquake design, 4.1.8.17.  
 Skylights  
   airtightness, 9.36.2.9., 9.36.2.10.  
   area, 9.10.17.9.  
   in area calculations, 9.10.17.6.  
   combustible, in corridors, 3.1.13.5.  
   flame-spread rating, 3.1.13.2., 9.10.17.1.  
   glass standards, 9.6.1.3.  
   in housing and small buildings, 9.7.  
   installation, 9.7.6.  
   manufactured and pre-assembled, 9.7.4.  
   in noncombustible construction, 3.1.5.4.  
   performance expectations, 9.7.3.  
   requirements, 9.7.2.2.  
   on roof adjacent to wall with windows, 3.2.3.15.  
   site-built, 9.7.5.  
   standards for, 5.4.1.2., 5.9.2.1., 5.9.2.2., 9.7.4.  
   thermal characteristics, 9.7.3.3., 9.36.2.7.  
   in unsprinklered compartments, 9.10.12.2.  
 Slabs-on-ground  
   (see also Floors-on-ground)  
   bond break, 9.16.4.4.  
   concrete, 9.16.4.  
   ducts in or beneath, 9.33.6.7.  
   finishing, 9.16.4.1., 9.16.4.2.  
   insulation, 9.25.2.3.  
   thickness, 9.16.4.3.  
 Sleepers, 9.30.1.3.  
 Slide escapes, 3.4.1.6.  
 Sliding doors  
   barrier-free, 3.8.3.6.  
   exits, 3.4.6.14.  
   glass used in, 9.6.1.4.  
   as means of egress, 3.3.1.12., 9.9.6.4.  
   performance expectations, 9.7.3.1., 9.7.3.2.  
   standards for, 5.3.1.2., 5.4.1.2., 9.7.4.2.  
 Slip-resistance  
   barrier-free path of travel, 3.8.3.2.  
   bathtubs, 3.8.3.17.  
   exterior walks, 3.8.3.3.  
   ramps and stairways, 3.3.1.14., 3.4.6.1.  
   showers, 3.8.3.16.  
   treads and landings, 9.8.9.6.  
 Smoke  
   circulation prevention, 3.2.4.12., 9.10.18.5.  
   contamination, 3.2.6.2., 3.2.8.4.  
   control of, 3.1.8.14., 3.2.6.1., 3.2.6.9., 3.3.1.7., 3.3.3.5., 3.3.3.7.  
 Smoke alarms  
   definition, 1.4.1.2.[A]  
   in housing and small buildings, 9.10.19.  
   interconnection, 9.10.19.5.  
   location, 9.10.19.3.  
   maintenance and care instructions, 9.10.19.7.  
   power supply, 9.10.19.4.  
   requirements, 3.2.4.20., 9.10.19.1.  
   silencing, 9.10.19.6.  
   smoke detectors in lieu of, 3.2.4.20., 3.2.4.21.  
   sound patterns, 9.10.19.2.  
 Smoke barrier doors, 3.2.3.20.  
 Smoke barriers, 9.10.9.2., 9.10.9.15.  
 Smoke chambers  
   clearances, 9.22.9.3.  
   slope, 9.22.7.1.  
   standard for, 9.22.7.  
   wall thickness, 9.22.7.2.  
 Smoke dampers  
   access, 3.1.8.11.  
   as closures, 3.1.8.5.  
   in fire separations, 3.1.8.7.  
   installation, 3.1.8.11.  
   leakage rates, 3.1.8.4.  
   waived, 3.1.8.9.  
 Smoke detectors  
   in air-handling systems, 6.9.2.2., 9.10.18.5.  
   annunciators, 3.2.4.8.  
   for construction camps, 9.10.21.7.  
   definition, 1.4.1.2.[A]  
   design and installation, 9.10.18.3.  
   duct-type, 3.2.4.12.  
   in electrical equipment rooms, 3.6.2.7.  
   in elevators, 3.2.4.11., 3.2.4.14.  
   in fire alarm systems, 9.10.18.  
   in lieu of smoke alarms, 3.2.4.20., 3.2.4.21., 9.10.19.8.  
   and release of hold-open devices, 3.1.8.14.  
   requirements, 3.2.4.11., 9.10.18.4.  
 Smoke developed classification  
   duct requirements, 3.6.5.1.  
   high buildings, 3.1.13.7.  
   plenum requirements, 3.6.4.3.  
   tests, 3.1.12.1.  
 Smoke shafts (venting to aid firefighting), 3.2.6.6.  
 Smoke stacks (venting for chimneys), 6.3.3.3.  
 Snow accumulation, 4.1.6.2., 4.1.6.3., 4.1.6.7., 4.1.6.10., 5.6.2.2.  
 Snow loads  
   arch roofs, 4.1.6.10.  
   areas adjacent to roof projections, 4.1.6.7.  
   basic load factors, 4.1.6.2.

- curved roofs, 4.1.6.10.
- domes, 4.1.6.10.
- due to sliding, 4.1.6.11.
- exterior platforms, 9.4.2.3.
- full and partial, 4.1.6.3.
- gable roofs, 4.1.6.9.
- and gap between roof and higher roof, 4.1.6.6.
- multi-level roofs, 4.1.6.5.
- snow drift at roof corners, 4.1.6.8., 4.1.6.13.
- specified, 4.1.6.2., 9.4.2.2.
- and structural design, 4.1.6.
- valleys in curved or sloped roofs, 4.1.6.12.
- weight calculations for drifts, 4.1.6.13.
- Snow removal, 4.1.6.14.
- Soffits
  - projections, 3.2.3.6., 9.10.14., 9.10.14.5., 9.10.15., 9.10.15.4., 9.10.15.5.
  - protection of, 3.2.3.16., 9.10.12.4.
  - venting, 9.19.1.2., 9.19.1.3., 9.25.2.4.
- Soil gas control
  - application of Code, 9.13.1.1.
  - crawl spaces, 9.13.4.2.
  - floors-on-ground, 9.16.2.1., 9.25.3.6.
  - requirements, 5.4.1.1., 9.13.4., 9.13.4.2.
  - walls in contact with the ground, 9.25.3.4.
- Soil, pyritic
  - drainage, 9.14.2.1., 9.14.4.1.
  - beneath floors-on-ground, 9.16.2.2.
  - and footings, 9.15.3.2.
  - foundations on, 9.4.4.4.
  - not in backfill, 9.12.3.3.
- Soils
  - bearing pressure, 9.4.4.1., 9.4.4.2.
  - definition, 1.4.1.2.[A]
  - erosion control, 5.6.2.2.
  - excavations, 4.2.5., 9.12.
  - beneath footings and foundations, 9.12.4.1., 9.15.1.1., 9.15.3.2.
  - identification and classification, 4.2.4.3., 9.4.4.
  - subsurface investigation, 4.2.2.1., 4.2.4.1., 4.2.4.2.
  - swelling and shrinking, 4.2.4.11., 9.4.4.4., 9.12.3.3., 9.14.2.1., 9.14.4.1., 9.15.3.2., 9.16.2.2.
  - temperature, 5.2.1.1., 5.2.1.3., 9.12.2.2., 9.16.2.2.
- Solar domestic hot water systems, 9.36.4.3.
- Solar thermal systems, 9.36.3.11.
- Solid-fuel-burning appliances
  - carbon monoxide alarms, 6.9.3.1., 9.32.3.9.
  - design, 9.33.5.3.
  - fireplace inserts and hearth-mounted stoves, 9.22.10.
  - and fire separations, 3.6.2.1.
  - installation standard, 6.2.1.5., 9.22.10.2., 9.33.5.3.
- Solid masonry, 1.4.1.2.[A]
- Solid masonry units, 1.4.1.2.[A], 9.15.5.1.
- Sound
  - protection from, 3.3.4.6., 5.1.1.1., 5.8.1., 9.11.
  - rating for fans, 9.32.3.10.
  - smoke alarms, 9.10.19.3.
- Sound transmission class (STC)
  - calculation of, 5.8.1.2.
  - compliance, 5.8.1.3.
  - definition, 1.4.1.2.[A]
- Space heaters
  - (see also Heating appliances)
  - definition, 1.4.1.2.[A]
  - design and standards, 9.33.5.3.
  - performance requirements, 9.36.3.10.
- Space heating appliances
  - definition, 1.4.1.2.[A]
  - installation standards, 9.33.5.2.
- Spans
  - maximums, 9.23.4.
  - steel, 9.23.4.3.
  - wood, 9.23.4.1., 9.23.4.2., 9.23.4.4., 9.23.4.5.
- Spatial separation between buildings, 3.2.3., 9.10.14., 9.10.21.5.
- Spatial separation between houses, 3.2.3.
- Special structures, 3.2.2.2.
- Sprinklered buildings or spaces
  - egress from bedrooms, 9.9.10.1.
  - fire-resistance rating, 9.10.8.2., 9.10.9.15., 9.10.10.6.
  - fire separations, 3.3.1.4., 3.6.2.5., 9.10.9.6., 9.10.9.13., 9.10.9.15., 9.10.10.6.
  - heat and smoke detection, 9.10.18.4.
  - limiting distance, 9.10.14.3.
  - lobbies, 3.4.4.2., 9.9.8.5.
  - openings in exposing building faces, 3.2.3.1., 9.10.14.4., 9.10.15.4.
  - openings in fire separations, 9.10.13.8.
  - and safety within floor areas, 3.3.
  - service spaces, 3.6.
  - soffit protection, 9.10.12.4.
  - and travel distance, 3.4.2.4., 3.4.2.5., 9.9.8.1., 9.9.8.2., 9.9.8.6.
- Sprinklered, definition, 1.4.1.2.[A]
- Sprinkler systems
  - for arena-type buildings, 3.1.2.3.
  - for assembly occupancy (Group A, Division 1), 3.2.2.20.
  - for assembly occupancy (Group A, Division 2), 3.2.2.23., 3.2.2.24., 3.2.2.26., 3.2.2.27.
  - for assembly occupancy (Group A, Division 3), 3.2.2.29., 3.2.2.31., 3.2.2.33.
  - for assembly occupancy (Group A, Division 4), 3.2.2.35.
  - for barrier-free floor areas, 3.3.1.7.
  - for basements, 3.2.1.5.
  - for business and personal services occupancy (Group D), 3.2.2.55., 3.2.2.57., 3.2.2.58., 3.2.2.59., 3.2.2.61., 3.2.2.63.
  - for care, treatment or detention occupancy (Group B, Division 1), 3.2.2.36., 3.2.2.37.
  - for care, treatment or detention occupancy (Group B, Division 2), 3.2.2.38. - 3.2.2.41.
  - for care, treatment or detention occupancy (Group B, Division 3), 3.2.2.42. - 3.2.2.46.
  - combustible pipes in, 3.1.9.5., 3.2.5.13., 9.10.9.6.
  - construction of, 3.2.5.12.
  - for contained use areas, 3.3.3.7.
  - and controlled egress, 3.4.6.17.
  - for corridors, 3.1.13.6., 3.3.2.6.

design, 3.2.5.12.  
 and door hold-open devices, 3.1.8.14.  
 and egress doorways, 3.3.1.5.  
 electrical supervision, 3.2.4.9.  
 exceptions for mezzanines, 3.2.8.2.  
 for exposing building face, 3.2.3.2.  
 and fire alarm systems, 3.2.4.1., 3.2.4.7., 3.2.4.8.,  
 9.10.18.4.  
 fire department connection, 3.2.5.15.  
 and firefighting access, 3.2.5.1.  
 fire hose connections, 3.2.5.10.  
 fire hose stations, 3.2.5.11.  
 fire separations in residential occupancy, 3.3.4.2.  
 flame-spread rating, 3.1.13.8.  
 for garages, 3.2.1.2., 3.3.5.4., 3.3.5.7.  
 in heavy timber construction, 3.1.4.7., 3.2.2.16.  
 for high buildings, 3.1.13.7.  
 for high-hazard industrial occupancy (Group F,  
 Division 1), 3.2.2.70.  
 for impeded egress areas, 3.2.2.19.  
 installation, 3.2.5.12., 9.10.1.3.  
 for interconnected floor space, 3.2.8.3.  
 for libraries, 3.3.2.13.  
 in lieu of fire detectors, 3.2.4.10.  
 limiting distance, 3.2.3.1.  
 for low-hazard industrial occupancy (Group F,  
 Division 3), 3.2.2.80., 3.2.2.82., 3.2.2.84., 3.2.2.86.,  
 3.2.2.88.  
 for medium-hazard industrial occupancy (Group F  
 Division 2), 3.2.2.74., 3.2.2.75., 3.2.2.77., 3.2.2.79.  
 for mercantile occupancy (Group E), 3.2.2.64.,  
 3.2.2.65., 3.2.2.67., 3.2.2.69.  
 and metal roof deck, 3.1.14.2.  
 in noncombustible construction, 3.1.5.19.  
 plans, 2.2.3.2.[C]  
 for repair garages, 3.3.5.4.  
 required, 3.2.2.18.  
 for residential occupancy (Group C), 3.2.2.47.,  
 3.2.2.48., 3.2.2.50., 3.2.2.51., 3.2.2.54.  
 self-storage warehouses, 3.3.5.9.  
 and separation of public corridors, 3.3.1.4.  
 and separation of suites, 3.3.1.1.  
 and service penetrations, 3.1.9.5.  
 for service spaces, 3.2.5.14.  
 and soffit protection, 3.2.3.16.  
 stages, 3.3.2.14.  
 and standpipes, 3.2.5.8., 3.2.5.9.  
 for storage garages, 3.2.1.2., 3.3.5.4., 3.3.5.7.  
 for storage rooms, 3.3.4.3.  
 for storeys below ground, 3.2.2.15.  
 system monitoring, 3.2.4.15.  
 testing, 3.2.5.12.  
 for theatres, 3.3.2.14.  
 for underground walkways, 3.2.3.20.  
 and unprotected openings, 3.2.3.1., 3.2.3.12.,  
 3.2.3.14., 3.2.3.15., 3.2.3.17.  
 Stability, structural, 4.1.3.2.  
 Stages, theatrical, 1.4.1.2.[A], 3.3.1.18., 3.3.2.14.  
 Stairs  
   cantilevered, 9.8.9.2., 9.8.10.  
   clear height over, 9.8.2.2.  
   concrete, 9.8.9.2., 9.8.10.  
   construction, 9.8.9.  
   curved, 3.3.1.16., 3.4.6.5., 3.4.6.9., 9.8.3.1.  
   dimensions, 3.3.2.15., 9.8.2.  
   doors onto, 3.4.6.3., 3.4.6.11., 9.8.6.2., 9.9.4.4.,  
   9.9.6.6.  
   in dwelling units, 3.3.4.7., 9.8.  
   for exits, 9.8.1.3., 9.8.2.1., 9.8.3.1., 9.9.9.3.  
   exit signs with, 9.9.11.4.  
   exterior, 9.3.1.6., 9.8.9.2., 9.8.9.3.  
   finishes, 3.4.6.1., 9.8.9.6.  
   fire blocks required, 3.1.11.4., 9.10.16.1.  
   on fire escapes, 3.4.7.5.  
   with foundations, 9.12.2.2.  
   guards for, 9.8.8.  
   handrails, 3.4.6.5., 9.8.7., 9.8.7.1.  
   height of, 9.8.3.3.  
   horizontal exit prohibition, 3.4.6.10.  
   landings (see Landings)  
   loads on, 9.8.9.1.  
   in noncombustible construction, 3.1.5.11.  
   nosings, 9.8.4.8.  
   permitted configurations, 9.8.3.1.  
   in restaurants, 3.3.2.15.  
   rise, 3.4.6.8., 9.8.3.3., 9.8.4.1., 9.8.4.4.  
   risers (see Risers)  
   runs (see Runs, stairs)  
   in secondary suites, 9.8.  
   slip-resistance, 3.4.6.1., 9.8.9.6.  
   spiral, 9.8.3.1., 9.8.4.7.  
   tolerances, 9.8.4.4.  
   treads (see Treads)  
   vertical rise, 3.4.6.3.  
   width, 9.8.2.1.  
   winders, 9.8.3.1., 9.8.4.6.  
   wood, 9.8.9.3., 9.8.9.4.  
 Stairways  
   as exits, 3.2.3.13., 3.4.1.4., 3.4.2.3., 3.4.3.3., 3.4.6.6.,  
   9.9.4.7.  
   headroom clearance, 3.4.3.4., 9.8.2.2., 9.8.6.4.  
   landings, 3.4.3.3.  
   lighting, 3.2.7.1., 9.9.12.2., 9.34.2.3.  
   in means of egress, 9.9.1.1.  
   mezzanine egress, 9.9.8.6.  
   projections into, 9.8.7.6.  
   requirements, 3.3.1.14.  
   roof-top enclosures, 3.2.2.14.  
   weather protection, 3.3.5.4., 3.4.6.11.  
   width, 3.4.3.2., 3.4.3.3., 9.8.2.1.  
 Standards, materials, 1.5.[A], 5.9.1.1.  
 Standpipe systems  
   in construction camps, 9.10.21.9.  
   design, 3.2.5.9.  
   fire department connection, 3.2.5.15.  
   fire hose connections, 3.2.5.10.  
   fire protection, 9.10.1.3.  
   installation, 3.2.5.9.  
   requirements, 3.2.5.8.  
   testing, 3.2.5.9.  
   trouble switch, 3.2.4.9.

**Staples**

- for cladding, 9.27.5.4.
- dimensions, 9.23.3.5., 9.26.2.4., 9.27.5.4.
- for roofing, 9.26.2.4.
- for sheathing, 9.23.3.5.
- for stucco lath, 9.28.3.2.
- for subflooring, 9.23.3.5.
- for underlay, 9.30.2.3.
- for wood strip flooring, 9.30.3.4.

**Stapling**

- asphalt shingles, 9.26.7.4., 9.26.7.6., 9.26.8.5.
- cladding, 9.27.5.4., 9.27.7.3.
- plywood finish, 9.29.6.3.
- roofing, 9.26.7.4., 9.26.7.6., 9.26.8.5., 9.26.9.5.
- sheathing, 9.23.3.5.
- sheathing membrane, 9.27.3.5.
- siding, 9.27.5.4., 9.27.7.3.
- subflooring, 9.23.3.5.
- underlay, 9.30.2.3.
- wood-frame construction, 9.23.3.
- wood shingles and shakes, 9.26.9.5., 9.27.7.3.
- wood strip flooring, 9.30.3.4.

**Static procedure, wind load calculations, 4.1.7.3.****Steel**

- beams, 9.23.4.3., 9.23.8.2.
- cold-formed, structural design basis, 4.3.4.2.
- columns, 9.10.14.5., 9.10.15.5., 9.17.3.
- design, 9.4.1.1.
- door frames, 9.10.13.6.
- fire protection, 3.2.2.3., 9.10.7.
- flashing, 9.20.13.1., 9.27.3.7.
- in foundations, 4.2.3.7.
- in foundations, high-strength tendons in, 4.2.3.9.
- framing, 9.24.
- lintels, 9.20.5.2., 9.22.1.2.
- protection from corrosion, 4.2.3.10., 5.1.4.2., 9.3.3.2., 9.17.3.3., 9.20.5.2., 9.20.16., 9.23.8.2.
- roofing, 5.9.1.1., 9.26.13.
- runners, 9.24.1.2., 9.24.1.3., 9.24.2.3., 9.24.2.4., 9.24.3.1., 9.24.3.2., 9.24.3.6.
- siding, 5.9.1.1., 9.27.11.1.
- structural design basis, 4.3.4.
- studs, 9.24.1.1., 9.24.2.1., 9.24.2.2., 9.24.2.4., 9.24.2.5., 9.24.3.2.

**Stone**

- facings, 9.20.6.6.
- masonry units, 9.20.2.5.
- veneer, 9.20.8.5.

**Storage**

- of ammonium nitrate, 3.3.6.6.
- of anhydrous ammonia, 3.3.6.3.
- on the building site, 1.2.2.2.[A]
- of dangerous goods, 3.3.6.2.
- of flammable and combustible liquids, 3.3.6.4.
- of flammable, toxic and oxidizing gases, 3.3.6.3.
- of materials, 1.2.2.2.[A], 9.10.1.3.
- outdoors, 3.2.3.21.
- of tires, 3.3.6.5.

**Storage areas, theatres, 3.3.2.14.****Storage bins****Storage bins**

- for ash, 6.9.4.1.
- for solid fuel, 6.7.2.1.

**Storage buildings, self-service**

- application of Code, 3.9.1.2.
- definition, 3.9.1.1.
- fire safety, 3.9.2.
- floor areas, 3.9.3.
- occupancy classification, 3.9.1.3.
- sanitary facilities, 3.9.3.2.

**Storage garages**

- (see also Garages)
- access through vestibule, 3.3.5.7.
- in basements, 9.10.4.3.
- in buildings with superimposed major occupancies, 3.2.2.7.
- carbon monoxide alarms, 6.9.3.1.
- cladding, 9.10.14.5.
- construction, 9.10.14.5., 9.35.
- definition, 1.4.1.2.[A]
- doors, 9.9.6.4., 9.10.17.10.
- exhaust to, 6.3.2.10.
- exposing building face, 9.10.14.4., 9.10.14.5.
- fire alarms, 3.2.4.1., 9.10.18.8.
- fire separations, 3.3.5.6., 9.10.9.16.
- headroom clearance, 3.3.1.8.
- height, 3.3.5.4., 9.5.3.3., 9.9.3.4.
- interconnection of ducting, 6.3.2.7., 9.33.6.7.
- limiting distance, 9.10.14.4.
- in low-hazard industrial occupancies (Group F, Division 3), 3.2.2.90.
- open-air, 9.10.14.4., 9.10.18.8.
- openings for vehicular ramps, 3.2.8.2.
- pressure less than in adjoining occupancies, 6.3.1.4.
- as separate buildings, 3.2.1.2.
- standpipes requirement, 3.2.5.9.
- unprotected openings in, 3.2.3.10., 9.10.14.4.
- ventilation, 3.3.5.4., 6.3.1.4., 9.32.1.1.

**Storage lockers, 3.1.5.17.****Storage racks, earthquake design, 4.1.8.18.****Storage rooms**

- in assembly occupancy, 3.3.2.16.
- for combustible garbage, 9.10.10.6.
- electrical outlets in, 9.34.2.5.
- fire alarm and detection systems, 9.10.18.6.
- fire detectors in, 3.2.4.10., 9.10.18.4.
- fire separations, 3.3.4.3., 3.6.2.5., 9.10.10.6.
- for flammable and combustible liquids, 3.3.6.4.
- flooring in areas of dangerous goods, 3.3.6.7.

**Storage tanks, 3.1.1.3.****Storage-type service water heaters, 1.4.1.2.[A], 9.31.6.2., 9.31.6.3.****Storefronts (see Fenestration)****Storeys**

- below ground, 3.2.2.15.
- definition, 1.4.1.2.[A]
- open-air, 1.4.1.2.[A], 3.2.1.5., 3.2.2.80., 3.2.2.90., 3.2.3.10., 3.2.5.4., 6.3.1.4., 9.10.14.4.
- sprinkler system requirements, 3.2.2.18.

**Stoves**

- (see also Cooktops)

- clearances, 9.10.22.2.
- definition, 1.4.1.2.[A]
- design and installation standard, 9.33.5.2., 9.33.5.3.
- hearth-mounted, 9.22.10.
- installation, 9.10.22.1.
- Strandboard (see OSB)
- Strapping, floor joists, 9.23.3.4., 9.23.9.3., 9.23.9.4.
- Streets
  - definition, 1.4.1.2.[A]
  - exposing building face on, 9.10.14.4.
  - fire access routes, 3.2.2.10.
  - repairs following construction, 8.2.3.4.
  - safe passage past construction sites, 8.2.3.1., 8.2.3.2.
  - unprotected openings facing, 3.2.3.10.
- Stress reversal, 4.1.3.2.
- Structural design
  - Code requirements, 4
  - housing and small buildings, 9.4.
  - limit states design, 4.1.3.
  - and structural loads, 5.2.2.
- Structural drawings, 2.2.4.3.[C]
- Structural fire protection, 3.2.2.3., 3.2.3.9., 9.10.8.
- Structural loads and design procedures, 4.1., 5.2.2., 5.9.3.2., 9.4.
  - exterior insulation finish systems, 5.9.4.1.
- Structural movement
  - mechanical systems and equipment, 4.1.8.18., 6.2.1.4., 9.33.4.7.
  - service water heaters, 9.31.6.2.
- Structures, special, 3.2.2.2.
- Stucco
  - aggregate for, 9.28.2.2., 9.28.5.1.
  - application, 9.28.6.
  - fasteners, 9.28.3.1., 9.28.3.2.
  - flashing for, 9.28.1.5.
  - ground clearance, 9.28.1.4.
  - for housing and small buildings, 9.28.
  - installation, 9.28.1.2., 9.28.1.3., 9.28.3.1., 9.28.3.2., 9.28.6.
  - lath (see Lath, stucco)
  - materials, 9.28.2., 9.28.5.
  - mixes, 9.28.5.1.
  - mixing, 9.28.5.3.
  - nails for, 9.28.3.
  - pigments, 9.28.5.2.
  - sheathing beneath, 9.28.1.1., 9.28.4.2.
  - staples for, 9.28.3.
  - thickness, 9.28.6.
- Studs, steel
  - bracing and lateral support, 9.24.1.5.
  - dimensions, 9.24.2.1., 9.24.2.5.
  - fastening, 9.24.1.4., 9.24.3.6.
  - in fire-rated walls, 9.24.2.4., 9.24.3.2.
  - in housing and small buildings, 9.24.
  - metal thickness, 9.24.1.3., 9.24.2.2., 9.24.2.4., 9.24.2.5.
  - notching and drilling, 9.23.5.3.
  - at openings, 9.24.2.4., 9.24.3.5., 9.24.3.7.
  - orientation, 9.24.3.3.
  - spacing, 9.24.2.1., 9.24.2.5.
  - standard for, 9.24.1.2.
- Studs, wood
  - bracing, 9.23.10.2.
  - continuity, 9.23.10.4.
  - at corners and intersections, 9.23.10.5.
  - dimensions, 9.23.10.1.
  - lateral support, 9.23.10.2.
  - lumber grade, 9.3.2.1.
  - notching and drilling, 9.23.5.3.
  - at openings, 9.23.10.6.
  - orientation, 9.23.10.3.
  - spacing, 9.23.10.1.
  - standard for, 9.24.1.2.
- Subflooring
  - depressurization, 9.13.4., 9.13.4.3.
  - direction of installation, 9.23.15.4.
  - edge support, 9.23.15.3.
  - lumber, 9.23.15.7.
  - materials, 9.23.15.2., 9.23.15.7.
  - nailing, 9.23.15.6.
  - thickness, 9.23.15.5.
  - wood-frame construction, 9.23.15.
- Subsurface investigation, 1.4.1.2.[A], 2.2.4.6.[C], 4.2.2., 4.2.4.2.
- Suites
  - definition, 1.4.1.2.[A]
  - doors and door hardware, 3.3.1.13.
  - fire separations, 9.10.9.13., 9.10.9.14.
  - separation of, 3.3.1.1.
  - smoke control measures, 3.2.6.2.
- Sump pits, 9.14.5.2.
- Sumps, evaporative air coolers and air washers, 6.3.2.16.
- Supervisory signal and switch for alarms, 3.2.4.9., 3.2.6.7.
- Supplemental energy dissipation
  - definitions and analysis, 4.1.8.21.
  - design considerations, 4.1.8.22.
- Supply air
  - capacity, 9.32.2.3., 9.32.3.6., 9.32.3.7., 9.33.3.1., 9.33.5.1., 9.33.6.11.
  - diffusers, 9.33.6.10., 9.33.6.11.
  - duct clearances, 3.6.5.6.
  - ducts, 1.4.1.2.[A], 6.3.2.7., 9.32.3.4., 9.32.3.11., 9.33.6.5., 9.33.6.11.
  - fans, 9.32.3.4., 9.32.3.5., 9.32.3.6.
  - outlets, 9.32.3.5., 9.32.3.6., 9.33.6.10., 9.33.6.11.
  - systems, 9.32.3.4., 9.32.3.6., 9.33.5.
  - tempering, 6.3.2.8., 9.32.3.4., 9.32.3.5., 9.32.3.8., 9.32.3.11.
- Supporting construction, fire-resistance rating, 3.1.7.5.
- Supports
  - beams, 9.23.8.
  - cladding, 9.20.5., 9.23.10.5., 9.24.3.4.
  - combustible construction, 3.1.8.2., 9.10.9.8.
  - excavations, 4.2.5.3.
  - firewalls, 3.1.10.1., 4.1.5.17.
  - floors, 3.2.1.4., 9.23.4.1., 9.23.4.2., 9.23.4.4., 9.23.8.3., 9.30.1.3.
  - hearths, 9.22.5.2.
  - interior finishes, 9.23.10.5., 9.24.3.4.

joists, 9.23.14.7.  
 noncombustible construction, 9.10.8.4.  
 pipes, 6.7.1.1., 9.33.8.1.  
 walls, 9.23.9.8.

Surface temperature  
 of pipes, 6.7.1.4., 9.33.8.2.  
 of radiators, 6.7.1.3., 9.33.7.2.

Swinging doors, 3.8.3.6.

Symbols, 1.2.2.1., 1.4.2.1.[A]

Systems  
 characteristics, 1.2.2.1.[A]  
 storage, 1.2.2.2.[A]  
 used, 1.2.2.3.[A]

**T**

Tablet arms, 3.3.2.4.

Tape, sealing, 3.1.5.2., 3.6.5.3., 6.3.2.19., 9.33.6.3.

Telephones, 3.2.4.22., 3.2.6.7., 3.4.6.17., 3.8.3.20.

Temperature  
 indoor design, 5.2.1.2., 5.3.1.2., 5.5.1.2., 9.33.3.1.  
 outdoor design, 1.1.3.1., 5.2.1.1., 5.3.1.2., 5.5.1.2.,  
 6.2.1.2., 9.33.3.2., 9.33.5.1.  
 of pipes, 6.7.1.4., 9.33.8.2.  
 of radiators, 6.7.1.3., 9.33.7.2.  
 soils, 5.2.1.1., 5.2.1.3., 9.12.2.2., 9.16.2.2.  
 supply air, 9.33.6.11.  
 transfer calculations, 5.2.1.3.

Temperature controls  
 HVAC systems, 9.36.3.6.  
 indoor pools, 9.36.4.6.  
 service water heating systems, 9.36.4.5.

Tempering of make-up air, 6.3.2.8., 9.32.3.4., 9.32.3.5.,  
 9.32.3.8.

Tents  
 clearance to flammable material, 3.1.6.4.  
 clearance to other structures, 3.1.6.3.  
 electrical systems, 3.1.6.7.  
 fire protection, 9.10.1.3.  
 fire safety restrictions, 3.1.6.2.  
 flame resistance, 3.1.6.5.  
 means of egress, 3.1.6.1.  
 roof coverings, 3.1.15.2.

Termites, protection against, 4.3.1.3., 9.3.2.9., 9.12.1.1.,  
 9.15.5.1.

Tests  
 building fire safety, 3.2.9.1.  
 fire-protection rating, 3.1.8.4., 9.10.3.1.  
 fire-resistance rating, 3.1.7.1., 9.10.3.1.  
 flame-spread rating, 3.1.12.1., 3.1.13.4., 6.9.1.1.,  
 9.10.3.2., 9.33.6.3., 9.33.6.4.  
 load, 4.1.1.5., 4.2.4.1., 9.23.14.11.  
 roof coverings, 3.1.15.1.  
 smoke developed classification, 3.1.12.1.  
 smoke movement in high buildings, 3.2.6.9.  
 sound transmission, 5.8.1.2., 9.11.1.2.  
 vapour permeance, 9.25.4.2.

Theatres, 1.4.1.2.[A], 3.3.2.14.

Thermal barriers  
 for foamed plastic, 9.10.17.10.  
 in noncombustible construction, 3.1.5.14., 3.1.5.15.

Thermal breaks, 5.9.2.4., 9.7.3.3.

Thermal bridging, 5.3.1.3., 9.25.1., 9.25.5.1.

Thermal insulation systems, 6.5.

Thermal resistance  
 building assemblies, 9.36.2.4., 9.36.2.6.  
 building assemblies below grade or in contact with  
 ground, 9.36.2.8.  
 location and installation of materials, 5.3.1.3.  
 materials in the building envelope, 9.25.5.1.  
 replacement options, 9.36.2.11.  
 requirements, 5.3.1., 9.25.1.  
 windows, doors and skylights, 9.36.2.7.

Thermal systems, solar, 9.36.3.11.

Ticket booths, 6.3.1.4.

Tile  
 clay, 9.23.4.5.  
 concrete, 9.23.4.5.

Tile, drainage, 9.14.3.

Tile, floor, 9.30.2.1., 9.30.2.2., 9.30.6.

Tile, roof  
 concrete, 5.9.1.1., 9.26.2.1.  
 eave protection, 9.26.5.1.  
 installation, 9.26.17.

Tile, wall  
 installation, 9.29.10.1.  
 moisture-resistant backing, 9.29.10.4.

Tires, storage, 3.3.6.5.

Top plates, walls, 9.23.5.4., 9.23.11.4.

Towers  
 earthquake loads and effects, 4.1.8.1.  
 wind loads, 4.1.7.11.

Toxic gases, storage, 3.3.6.3.

Trade shows, 3.1.2.3.

Traffic control, construction sites, 8.2.4.

Transformer vaults, 3.6.2.7., 9.10.1.3.

Transparent panels, 3.3.1.19., 3.4.1.8., 9.6.1.4., 9.7.2.1.

Transponder, for fire alarm, 3.2.7.10.

Travel distance  
 banks and mercantile facilities, 3.4.6.17.  
 to egress doorways, 3.3.1.5., 3.3.1.6.  
 to exit, 3.4.2.1., 3.4.2.3., 3.4.2.4., 9.9.8.2.  
 in fire compartments, 3.3.3.5.  
 measurement of, 9.9.8.1.  
 mezzanines, 9.9.8.6.  
 and number of required exits, 9.9.8.2.  
 rooms and suites, 9.9.7.4., 9.9.7.6.  
 to unlocked doors, 3.4.6.18.

Treads  
 dimensions, 3.3.1.16., 3.4.6.8., 9.8.4., 9.8.4.3.  
 finishes, 9.8.9.6.  
 mixed, 9.8.4.5.  
 nosings, 9.8.4.8.  
 rectangular, 9.8.3.1., 9.8.4.1., 9.8.4.2.  
 slip-resistance, 3.4.6.1., 9.8.9.6.  
 tapered, 3.3.1.16., 3.4.6.9., 9.8.3.1., 9.8.4.1., 9.8.4.3.,  
 9.8.4.4.  
 thickness, 9.8.9.5.

uniformity and tolerances, 9.8.4.4.  
in winders, 9.8.4.6.  
Treatment occupancy (see Care, treatment or  
detention occupancy)  
Trench, for piping of flammable liquids, 6.9.1.2.  
Trim, for windows, doors and skylights, 9.7.6.2.  
Trouble signals, 3.2.4.8., 3.2.4.9., 3.2.6.7.  
Trusses  
  design, 9.4.1.1., 9.4.2.2., 9.23.14.11.  
  lumber grade, 9.3.2.1.  
  maximum deflections, 9.23.14.11.  
  snow loads, 9.4.2.2.  
Tubing for pneumatic controls, 3.1.5.2., 3.6.4.3.  
Turnstiles, 3.4.3.3., 9.9.5.4., 9.9.5.5.  
Tying (see Anchorage)

## U

Underground ducts, 6.3.2.12., 9.33.6.7.  
Underground walkways, 3.1.13.9., 3.2.3.20., 3.2.7.3.,  
9.9.12.3.  
Underlay  
  fastening, 9.30.2.3.  
  for flooring, 9.30.2.  
  hardboard, 9.30.2.2.  
  installation, 9.26.6.2., 9.26.10.2., 9.30.2.3.  
  materials, 9.26.6.1., 9.30.2.2., 9.30.2.5.  
  material standards, 9.30.2.2.  
  nailing, 9.30.2.3.  
  OSB, 9.30.2.2.  
  particleboard, 9.30.2.2.  
  plywood, 9.30.2.2.  
  roofing, 9.26.6., 9.26.10.2.  
  beneath shakes, 9.26.10.2.  
  beneath shingles, 9.26.6.  
  stapling, 9.30.2.3.  
  thickness, 9.30.2.2.  
Unit heaters, 1.4.1.2.[A]  
Universal washrooms, 3.8.3.12.  
Unprotected openings  
  (see also Openings)  
  area increase, 3.2.3.12.  
  definition, 1.4.1.2.[A]  
  in exposing building face, 3.2.3.7.  
  in exterior walls, 3.2.3.1.  
  in floors, 9.10.1.3.  
  maximum area, 9.10.14.4.  
  and spatial separation between buildings, 9.10.14.,  
9.10.15.  
  unlimited, 3.2.3.10.  
  in wall exposed to another wall, 3.2.3.14.  
Unsafe conditions, 1.4.1.2.[A]  
Unstable liquids, 1.4.1.2.[A]  
Unusual structures, 3.2.2.2.  
Urinals, barrier-free design, 3.8.2.8., 3.8.3.14.

## V

Vacuum cleaning systems  
  emergency shutdown, 3.2.4.13.  
  fire safety shutdown, 9.10.18.7.  
  penetrating fire separations, 3.1.9.5., 9.10.9.6.  
  suites served, 9.10.9.19.  
Vapour  
  diffusion, 5.1.1.1., 5.2.1.2., 5.2.1.3., 5.5., 5.9.4.1.,  
9.25.4.1., 9.25.5.1.  
  permeance, 5.5.1.2., 9.25.4.2., 9.25.5.1.  
  transfer, 5.1.1.1., 5.2.1.2., 5.2.1.3.  
Vapour barriers  
  and dampproofing, 9.13.2.5.  
  definition, 1.4.1.2.[A]  
  in housing and small buildings, 9.25.4.  
  installation, 5.5.1.2., 9.23.2.2., 9.25.4.3.  
  in noncombustible construction, 3.1.5.2.  
  permeance, 5.5.1.2., 9.25.4.2.  
  products used, 9.25.4.3.  
  required resistance to vapour diffusion, 5.5.1.1.  
  requirements, 9.25.4.1.  
  standards for, 5.9.1.1., 9.25.4.2.  
Vapour pressure, 5.5.1.1.  
  (see also Flammable liquids)  
Vehicle guardrails, 4.1.5.15., 9.8.8.4.  
Vehicular passageways, 3.1.13.2., 3.2.3.18.  
Vehicular ramps, 3.2.8.2., 3.3.1.18., 9.8.8.4.  
Vehicular traffic, construction sites, 8.2.3.1., 8.2.4.1.  
Veneer  
  flashing, 5.6.2.1., 9.20.13.3.  
  masonry, 5.6.1.2., 9.20.6.4., 9.20.8.5., 9.20.9.5.,  
9.20.12.3.  
Vent connectors, 1.4.1.2.[A]  
Ventilating systems (see Heating, ventilating  
and air-conditioning (HVAC) systems and  
equipment)  
Ventilation  
  of air contaminants, 6.3.1.6.  
  attic or roof spaces, 6.3.1.2., 9.19.1.  
  capacity, 9.32.2.3., 9.32.3.3.  
  crawl spaces, 6.3.1.2., 9.18.3., 9.18.3.1., 9.18.3.2.  
  definition, 1.4.1.2.[A]  
  direct-vent, 9.32.3.8.  
  dwelling units, 6.3.1.1., 9.32.  
  electrical equipment vaults, 3.6.2.7.  
  exhaust, 3.3.1.20., 9.10.9.18., 9.32.3.6., 9.32.3.13.  
  exhaust ducts and outlets, 6.3.2.10.  
  garages, 3.3.5.4.  
  housing and small buildings, 9.32.  
  mechanical, 6.3.1.1., 6.3.1.4. - 6.9.1.2., 9.32.2.3.,  
9.32.3., 9.32.3.3. - 9.32.3.6.  
  natural, 6.3.1.3., 9.32.2.2.  
  outlets, 9.32.3.5., 9.32.3.6.  
  requirements, 6.2.2., 6.3.1.1., 9.32.1.2., 9.32.2.1.,  
9.32.3.1.  
  residential, 6.3.1.1.  
  restaurants, 6.3.1.7.  
  secondary suites, 9.32.1.2., 9.32.3.8., 9.32.3.9.  
  storage garages, 3.3.5.7., 6.3.1.4., 9.32.1.1.  
  windows for, 9.32.2.2.

## Venting

- air space in building envelopes, 9.25.5.1., 9.27.2.2.
- attic or roof spaces, 5.3.1.2., 6.3.1.2., 9.19.1.
- chimneys, 9.21., 9.33.10.1.
- combustion products, 6.3.3.1., 9.32.3.8., 9.33.10.1.
- crawl spaces, 6.3.1.2., 9.18.3., 9.18.3.1., 9.18.3.2.
- explosion relief devices, 3.3.1.20.
- firefighting, 3.2.8.7.
- firefighting in high buildings, 3.2.6.6., 3.2.6.9.
- heating appliances, 9.21., 9.33.5.2., 9.33.5.3., 9.33.10.1.
- laundry-drying equipment, 9.32.1.3.
- mansard or gambrel roofs, 9.19.1.4.
- soffits, 9.19.1.2., 9.19.1.3., 9.25.2.4.

## Vents

- area, 9.19.1.2.
- gas, 9.33.10.1.
- installation, 9.19.1.2.
- in stair shafts, 3.2.6.2.
- standard for, 9.19.1.2.

## Vertical service spaces

- application of Code, 3.6.1.1., 3.6.3.1.
- combustible piping in, 3.1.9.5.
- definition, 1.4.1.2.[A]
- for dumbwaiters, 3.5.3.2.
- elevator machinery, 3.5.3.3.
- exhaust ducts, 3.6.3.4., 9.10.9.18.
- fire dampers, 9.10.13.13.
- fire protection, 9.10.1.3.
- fire separations, 3.6.3.1.
- flame-spread rating, 3.1.13.2.
- penetrating floor assemblies, 3.2.8.1.

## Vestibules

- (see also Lobbies)
- access to storage garages, 3.3.5.7.
- barrier-free doors, 3.8.3.6.
- and closure devices, 3.1.8.19.
- elevators for use by firefighters, 3.2.6.5.
- garages, 3.3.5.4.
- high buildings, 3.1.13.7.
- horizontal exits, 3.4.6.10.
- interconnected floor space, 3.2.8.4.

## Vibrations

- combustible isolation connector, 3.6.5.2., 6.3.2.18.
- floors, 9.23.4.1., 9.23.4.2.
- limit states design, 4.1.3.6.

## Visual disability, 3.3.1.9.

## Visual signal devices, 3.2.4.19.

## Voice communication systems

- central alarm and control facility, 3.2.6.7.
- emergency power supply, 3.2.7.8.
- high buildings, 3.2.6.8.
- requirements, 3.2.4.22.
- speakers, 3.2.4.22.
- use of alarm circuitry, 3.2.4.18.

# W

## Waferboard

- as cladding, 5.9.1.1., 9.27.2.4., 9.27.3.6., 9.27.5., 9.27.10.
- fire blocks, 9.10.16.3.
- fire protection of soffits, 9.10.12.4.
- fire stops, 3.1.11.7.
- as interior finish, 9.29.9.
- material, 9.3.2.4.
- material standard, 5.9.1.1., 9.23.15.2., 9.23.16.2., 9.23.17.2., 9.27.10.1., 9.29.9.1., 9.30.2.2.
- as roof sheathing, 9.3.2.4., 9.23.3.5., 9.23.16.
- as siding, 9.27.3.6., 9.27.5., 9.27.10.
- as subflooring, 9.3.2.4., 9.23.3.5., 9.23.15.2., 9.23.15.5.
- thickness, 9.3.2.7.
- as underlay, 9.30.2.
- as wall sheathing, 9.3.2.4., 9.23.3.5., 9.23.10.2., 9.23.17.2., 9.23.17.5.

## Walk-in coolers/freezers, 3.1.4.2., 3.1.5.7., 9.10.17.10.

## Walks, moving, 3.2.8.2., 3.8.2.3., 3.8.2.4., 9.8.1.4.

## Walkways

- barrier-free path of travel, 3.8.3.3.
- between buildings, 3.2.3.19.
- construction camps, 9.10.21.4.
- construction sites, 8.2.1.1.
- definition, 1.4.1.2.[A]
- exterior, 3.8.3.3., 9.9.4.2., 9.9.9.3., 9.10.8.8., 9.10.17.4.
- fire protection, 9.10.1.3.
- smoke detectors, 3.2.4.11.
- underground, 3.1.13.9., 3.2.3.20., 3.2.7.3., 9.9.12.3.

## Wall membranes, 9.10.5.

## Wall panels

- braced (see Braced wall panels)
- factory-assembled, 3.1.5.7.

## Wall plates, 9.23.3.4., 9.23.11.

## Walls

- (see also Walls, exterior)
- air barrier systems, 9.25.3.
- anchorage, 9.20.11., 9.23.3.4., 9.35.4.3.
- area, calculating, 9.36.2.3.
- bracing, 9.23.10.2., 9.23.13.
- in carports, 9.35.4.1., 9.35.4.3.
- cladding, 9.27.
- continuity of insulation, 9.36.2.5.
- exposed to adjoining roof, 3.2.3.15., 9.10.12.2.
- fire blocks in, 9.10.16.2.
- fire-resistance rating, 3.2.3.7., 3.2.3.11., 9.10.8.3., 9.10.14.5., 9.10.15.5.
- firewalls (see Firewalls)
- foamed plastics in, 9.10.17.10.
- foundations, 4.2., 9.15.4.
- framing, 9.23.10., 9.24.
- garages, 9.35.4.1.
- as guards, 4.1.5.16.
- in health facilities, 3.3.3.5.
- height, 9.20.6.
- intersecting, anchorage, 9.20.11.
- lateral support, 9.20.10., 9.23.10.2.



- loadbearing, 3.2.1.4., 9.10.8.3., 9.23.9.8., 9.23.10.1., 9.23.10.2., 9.23.10.6., 9.23.12.2., 9.23.12.3., 9.24.1.1.
- masonry, 5.6.1.2., 9.20., 9.25.3.4.
- masonry veneer, 5.6.1.2., 9.20.6.4.
- non-loadbearing, 9.23.9.8., 9.23.10.1., 9.23.10.6., 9.23.12.1., 9.24.
- openings in loadbearing, 9.23.10.6., 9.23.12.2., 9.23.12.3.
- openings in non-loadbearing, 9.23.10.6., 9.23.12.1., 9.24.2.4., 9.24.3.5., 9.24.3.7.
- in public corridors, 9.10.17.5.
- recesses, 9.20.7.
- retaining, 9.3.2.9., 9.4.4.5., 9.4.4.6.
- sheathing, 9.23.13., 9.23.17., 9.27.3.4., 9.27.3.5.
- steel stud, 9.24.
- support on framed floors, 9.23.9.8.
- supports, 9.23.9.8.
- thermal insulation, 9.25.1.1.
- thickness, 9.20.6.
- wind loads, 4.1.7.5., 4.1.7.6.
- Walls, exterior**
  - in combustible construction, 3.1.4.8.
  - continuity of insulation, 9.36.2.5.
  - enclosing attic or roof space, 3.2.3.3.
  - exposed to another wall, 3.2.3.14., 9.10.12.3.
  - fire-resistance rating, 3.1.7.2., 3.1.7.3., 3.2.3.7., 3.2.3.11., 9.10.3.1., 9.10.3.3., 9.10.14.5., 9.10.15.5.
  - at firewall, 3.1.10.6.
  - in noncombustible construction, 3.1.5.5., 3.1.5.6.
  - restrictions on combustible projections, 3.2.3.6., 9.10.14.5., 9.10.15.5.
  - thickness, 9.20.6.1.
- Walls, interior**
  - airtightness, 9.36.2.10.
  - finish, 9.29.
  - not fire separations, 9.10.12.3.
  - thickness, 9.20.6.3.
- Wall studs (see Studs, steel; Studs, wood)**
- Warehouses**
  - door swing, 3.3.1.11.
  - loads on floor or roof, 4.1.5.3.
  - self-storage, 3.3.5.9., 9.9.6.4.
- Warm air outlets, 9.33.6.10., 9.33.6.11.**
- Warning lights, construction sites, 8.2.3.5.**
- Wash fountains, circular, 3.7.2.3.**
- Washrooms**
  - (see also Bathrooms)
  - barrier-free, 3.8.2.8., 3.8.3.9., 3.8.3.11., 3.8.3.15.
  - emergency lighting, 3.2.7.3.
  - floor drains, 3.7.2.7.
  - requirements, 3.7.2.2.
  - self-service storage buildings, 3.9.3.2.
  - signage, 3.8.3.9.
  - surface protection, 3.7.2.6.
  - universal, 3.8.3.12.
- Waste material**
  - chutes, 8.2.5.4.
  - enclosures, 8.2.5.3.
  - removal, 8.2.5.2.
- Water**
  - (see also Groundwater)
  - accumulation, 5.6.2.2., 5.7.1.1.
  - drainage, 5.6.2.2., 9.14.
  - drainage disposal, 9.14.5.
  - in excavations, 9.12.1.2.
  - flooring resistant to, 9.30.1.2.
  - ingress, 5.7.1.1.
  - protection against, application of Code, 9.13.1.1.
  - protection against, in exterior insulation finish systems, 5.9.4.1.
  - protection against, in fenestration, 5.9.3.5.
  - protection against hydrostatic pressure, 5.7.2.
  - protection from groundwater, 5.7.3.
  - required protection against, 5.7.1.2.
  - surface, 5.7., 5.7.1.1.
- Water closets**
  - bathtubs, 3.7.2.9.
  - doorways, 9.5.5.2.
  - in dwelling units, 9.31.4.1.
  - floor drains, 3.7.2.7.
  - grab bars, 3.7.2.8.
  - for persons with disabilities, 3.8.3.13.
  - requirements, 3.7.2.2.
  - stalls, 3.8.3.11.
  - surface protection, 3.7.2.6.
- Waterflow detecting devices, 3.2.4.4., 3.2.4.7., 3.2.4.15., 3.2.5.14., 3.2.6.7.**
- Water heaters, solar, 9.36.4.3.**
- Waterproof flooring, 9.30.1.2.**
- Waterproofing**
  - floors-on-ground, 9.13.3.1., 9.13.3.5.
  - installation, 5.6.1.2., 9.13.3.4.
  - installation standards, 9.26.15.1.
  - material standards, 5.9.1.1., 9.13.3.2., 9.26.2.1.
  - preparation of surface, 9.13.3.3.
  - protection from groundwater, 5.7.3.3.
  - requirement for, 9.13.3.1.
  - roofs, 5.6.1.2., 9.13.3.1., 9.26.2.1.
  - walls, 9.13.3.1., 9.13.3.3., 9.13.3.4.
- Waterproof interior wall finish, 9.29.2.**
- Water supply**
  - for firefighting, 3.2.5.7., 3.2.5.9., 3.2.7.9.
  - hot water, 9.31.4.2.
  - potable water, 9.31.3.
- Water supply valves, 3.2.4.9.**
- Water systems**
  - dwelling units, 9.31.3.
  - potable water, 9.31.3.1.
- Water treatment, evaporative cooling systems, 6.3.2.15.**
- Weep holes, 9.20.13.5., 9.20.13.6., 9.20.13.8.**
- Welding operations room, 3.3.1.25.**
- Wells**
  - dry, 9.14.5.3.
  - water supply, 9.14.6.2.
- Wheelchair spaces, and path of travel, 3.8.2.3., 3.8.3.21.**
- Wheelchair turning space, universal washrooms, 3.8.3.12.**
- Winders, 9.8.3.1., 9.8.4.1., 9.8.4.4., 9.8.4.6.**

## Wind load

- and air barrier systems, 9.25.3.2.
- anchorage of building frames, 9.23.6.1.
- bracing to resist, 9.23.13.
- calculation of, 4.1.7., 5.2.1.3., 5.2.2.2.
- dynamic effects, 4.1.7.2.
- dynamic procedure, 4.1.7.8.
- environmental separation, 5.1.4.1.
- exterior ornamentations, equipment and appendages, 4.1.7.11.
- external pressure coefficients, 4.1.7.5.
- external pressure coefficients, low buildings, 4.1.7.6.
- fasteners for sheathing or subflooring, 9.23.3.5.
- full and partial, 4.1.7.9.
- interior walls and partitions, 4.1.7.10.
- internal pressure coefficient, 4.1.7.7.
- pressure differences due to, 4.1.7.10., 5.4.1.2.
- roof sheathing, 9.23.16.1.
- specified, 4.1.7.1.
- static procedure, 4.1.7.3.
- and structural design, 4.1.7.
- structural strength, 9.4.1.1., 9.6.1.3.
- topographic factor, 4.1.7.4., 9.6.1.3.
- wind tunnel procedure, 4.1.7.12.

## Windows

- (see also Closures; Fenestration; Glass; Skylights)
- access for firefighting, 9.10.20.1.
- airtightness, 5.9.1.1., 5.9.2.3., 9.7.4., 9.36.2.9., 9.36.2.10.
- barriers or railings with, 3.3.1.19.
- in bedrooms, 9.9.10.1.
- caulking and sealing, 9.7.4., 9.20.13.11., 9.27.4.
- as closures, 3.1.8.5.
- dimensions, 9.32.2.2.
- in exits, 9.9.4.5.
- in exposing building faces, 9.10.14.4., 9.10.15.4.
- flashing, 9.20.13.3., 9.20.13.4., 9.20.13.12., 9.27.3.8.
- glass thickness, 9.6.1.3.
- for housing and small buildings, 9.7.
- installation, 9.7.6.
- manufactured and pre-assembled, 9.7.4.
- as means of egress, 9.7.2.2.
- for natural ventilation, 9.32.2.2.
- in noncombustible construction, 3.1.5.4.
- not a means of egress, 9.9.2.3.
- opening into window wells, 9.9.10.1.
- openings, 9.8.8.1., 9.9.10.1.
- performance expectations, 9.7.3.
- protection of, 3.3.4.8.
- protection in public areas, 9.8.8.1.
- protection in residential occupancy, 9.8.8.1.
- requirements, 9.7.2.2.
- resistance to forced entry, 9.7.5.3.
- sills, 9.20.13.12., 9.27.3.8.
- site-built, 9.7.5.
- standard for, 5.9.1.1., 5.9.2.2., 9.7.4.
- thermal breaks, 5.9.2.4., 9.7.3.3.
- thermal resistance calculation, 9.36.2.11.
- thermal transmittance (U-value), 9.7.3.3.
- unobstructed opening area, 9.9.10.1., 9.32.2.2.

watertightness, 5.9.1.1., 5.9.2.3., 9.7.4.

wind load resistance, 5.2.2.2., 9.7.4.

## Window walls (see Fenestration)

Window wells, 9.9.10.1., 9.14.6.3.

Wind tunnel procedure, 4.1.7.12.

## Wired glass

- area limits, 3.1.8.18.
- area limits waived, 3.1.8.19.
- as closure, 9.10.13.5.
- in exits, 3.2.3.13., 9.9.4.3.
- in fire separations, 3.1.8.16.
- in guards, 9.8.8.7.
- not to be used as closures, 3.2.3.5.
- temperature rise limits waived, 3.1.8.19.
- in transparent panels and doors, 3.3.1.19.
- in unprotected openings, 3.2.3.12., 9.10.14.4.
- uses, 9.6.1.4.
- in windows, doors and skylights, 5.9.1.1., 5.9.2.1.

## Wires and cables

- in combustible construction, 3.1.4.3.
- electrical, 3.2.6.5., 9.34., 9.34.1.5.
- in fire separations, 9.10.9.6.
- in noncombustible construction, 3.1.5.21.
- penetrating fire separations, 3.1.9.3.
- in plenums, 3.6.4.3.
- protection of electrical conductors, 3.2.7.10.
- storage, 3.3.6.2.

## Wood

- bracing, 9.23.13.
- cant strips, 9.26.4.6., 9.26.4.7., 9.26.11.10.
- columns, 9.10.14.5., 9.10.15.5., 9.17.4., 9.35.4.2.
- design and construction, 9.23.
- door frames, 9.10.13.3.
- doors, 9.7.5.2.
- fire-resistance rating, 9.10.6.2.
- fire-retardant-treated (see Fire-retardant-treated wood)
- floor beams, 9.23.8.1.
- floor joists, 9.23.9.
- flooring, 9.30.3., 9.30.4.
- floors-on-ground, 9.16.5.
- floor supports, 9.23.4.1., 9.23.4.2., 9.23.4.4., 9.23.8.3., 9.30.1.3.
- foundations, 4.2.3.1., 4.2.3.2., 9.15.1.1., 9.15.2.4.
- in heavy timber construction, 3.1.4.7.
- in noncombustible construction, 3.1.5.2., 3.1.5.3., 3.1.5.5., 3.1.5.8., 3.1.5.10.
- preservative treatment, 4.2.3.2., 9.8.9.3., 9.23.2.2., 9.23.2.3.
- roofs, 3.1.14.1., 9.23.4.1., 9.23.4.2., 9.23.4.5., 9.23.16.
- shingles and shakes, 9.26.2.1., 9.26.2.3., 9.26.3.1., 9.26.9., 9.26.10., 9.27.7.
- siding, 9.27.6., 9.27.7., 9.27.8., 9.27.9., 9.27.10.
- stairs, 9.8.9.3., 9.8.9.4.
- structural design basis, 4.3.1.

## Wood blocking

- cladding, 9.23.10.5., 9.27.5.2.
- doors, 9.7.5.2.
- with handrails, 9.8.7.7.
- interior finishing materials, 9.23.10.5.
- joists, 9.23.9.3., 9.23.9.4., 9.23.14.9.

nailing, 9.23.3.4.  
in noncombustible construction, 3.1.5.2.  
rafters and joists, 9.23.14.7.  
roof edges, 9.23.16.6., 9.23.16.7.  
subflooring, 9.23.15.3.  
walls, 9.23.9.8., 9.23.10.2.

Wood-burning appliances  
chimney liners, 9.21.3.9., 9.22.2.3.  
chimneys and flues, 6.3.3.2., 6.3.3.3., 9.21.1.1.,  
9.21.2.1., 9.21.2.2., 9.33.10.2.  
ducts serving, 3.6.5.8., 9.33.6.13.  
factory-built fireplaces, 9.22.1.4., 9.22.8.1.  
hearth-mounted stoves, 9.22.10.  
inserts, 9.22.10.  
installation, 3.6.2.1.  
installation standard, 6.2.1.5., 9.22.10.2., 9.31.6.2.  
masonry fireplaces, 9.22.  
product standards, 9.22.2.3., 9.22.8.1., 9.22.10.1.,  
9.33.5.3.  
protection against depressurization, 9.32.3.8.  
venting, 6.3.3.1., 9.33.10.1.

Wood-frame construction  
alternative structural components, 9.23.1.1.  
beams to support floors, 9.23.8.  
bracing for earthquake and wind loads, 9.23.13.  
fasteners, 9.23.3.  
floor joists, 9.23.9.  
framing over openings, 9.23.12.  
housing and small buildings, 9.23.  
maximum spans, 9.23.4.  
notching and drilling, 9.23.5.  
roof and ceiling framing, 9.23.14.  
roof sheathing, 9.23.16.  
sill plates, 9.23.7.  
subflooring, 9.23.15.  
wall plates, 9.23.11.  
wall sheathing, 9.23.17.  
wall studs, 9.23.10.

Wood products  
dimensions, 9.3.2.6., 9.3.2.7.  
for housing and small buildings, 9.3.2.  
preservative treatment, 9.3.2.9.  
protection against moisture, 9.3.2.9.  
undersized, 9.3.2.8.

Workmanship review, 2.2.7.4.[C]

## Y

Yard, as access for firefighters, 9.10.20.3.

### Conversion Factors

To Convert	To	Multiply by
°C	°F	1.8 and add 32
kg	lb.	2.205
kPa	lbf/in. <sup>2</sup> (psi)	0.1450
kPa	lbf/ft. <sup>2</sup>	20.88
kW	Btu/h	3412
L	gal. (imp.)	0.2200
L/s	gal./min (gpm)	13.20
lx	ft.-candle	0.09290
m	ft.	3.281
m <sup>2</sup>	ft. <sup>2</sup>	10.76
m <sup>3</sup>	ft. <sup>3</sup>	35.31
mm	in.	0.03937
m <sup>3</sup> /h	ft. <sup>3</sup> /min (cfm)	0.5886
m/s	ft./min	196.8
MJ	Btu	947.8
N	lbf	0.2248
ng/(Pa·s·m <sup>2</sup> )	Btu/h	3.412

---

# **National Building Code of Canada 2015**

**Volume 2**

**Issued by the  
Canadian Commission on Building and Fire Codes  
National Research Council of Canada**

First Edition 1941  
Second Edition 1953  
Third Edition 1960  
Fourth Edition 1965  
Fifth Edition 1970  
Sixth Edition 1975  
Seventh Edition 1977  
Eighth Edition 1980  
Ninth Edition 1985  
Tenth Edition 1990  
Eleventh Edition 1995  
Twelfth Edition 2005  
Thirteenth Edition 2010  
Fourteenth Edition 2015

ISBN 0-660-03633-5

NR24-28/2015E

NRCC 56190

© National Research Council of Canada 2015  
Ottawa  
World Rights Reserved

Printed in Canada

First Printing

2 4 6 8 10 9 7 5 3 1

Aussi disponible en français :  
Code national du bâtiment – Canada 2015  
CNRC 56190F  
ISBN 0-660-03635-9

---

# Table of Contents

## Volume 1

Preface

Relationship of the NBC to Standards Development and Conformity Assessment

Canadian Commission on Building and Fire Codes and Standing Committees

### **Division A Compliance, Objectives and Functional Statements**

- Part 1 Compliance
- Part 2 Objectives
- Part 3 Functional Statements

### **Division B Acceptable Solutions**

- Part 1 General
- Part 2 Reserved
- Part 3 Fire Protection, Occupant Safety and Accessibility
- Part 4 Structural Design
- Part 5 Environmental Separation
- Part 6 Heating, Ventilating and Air-conditioning
- Part 7 Plumbing Services
- Part 8 Safety Measures at Construction and Demolition Sites
- Appendix C Climatic and Seismic Information
- Appendix D Fire-Performance Ratings

### **Division C Administrative Provisions**

- Part 1 General
- Part 2 Administrative Provisions

**Index**

## Volume 2

### **Division B Acceptable Solutions**

- Part 9 Housing and Small Buildings

**Index**







# **Division B**

## **Acceptable Solutions**



# Part 9

## Housing and Small Buildings

<b>9.1.</b>	<b>General</b>	
9.1.1.	Application .....	9-1
9.1.2.	Limits on Floor Area .....	9-1
<b>9.2.</b>	<b>Definitions</b>	
9.2.1.	General .....	9-1
<b>9.3.</b>	<b>Materials, Systems and Equipment</b>	
9.3.1.	Concrete .....	9-1
9.3.2.	Lumber and Wood Products .....	9-3
9.3.3.	Metal .....	9-6
<b>9.4.</b>	<b>Structural Requirements</b>	
9.4.1.	Structural Design Requirements and Application Limitations .....	9-6
9.4.2.	Specified Loads .....	9-7
9.4.3.	Deflections .....	9-8
9.4.4.	Foundation Conditions .....	9-8
<b>9.5.</b>	<b>Design of Areas and Spaces</b>	
9.5.1.	General .....	9-10
9.5.2.	Barrier-Free Design .....	9-10
9.5.3.	Ceiling Heights .....	9-10
9.5.4.	Hallways .....	9-11
9.5.5.	Doorway Sizes .....	9-11
<b>9.6.</b>	<b>Glass</b>	
9.6.1.	General .....	9-12
<b>9.7.</b>	<b>Windows, Doors and Skylights</b>	
9.7.1.	General .....	9-16
9.7.2.	Required Windows, Doors and Skylights .....	9-16
9.7.3.	Performance of Windows, Doors and Skylights .....	9-17
9.7.4.	Manufactured Windows, Doors and Skylights .....	9-18
9.7.5.	Site-built Windows, Doors and Skylights .....	9-19
9.7.6.	Installation .....	9-20
<b>9.8.</b>	<b>Stairs, Ramps, Handrails and Guards</b>	
9.8.1.	Application .....	9-20
9.8.2.	Stair Dimensions .....	9-21
9.8.3.	Stair Configurations .....	9-21
9.8.4.	Step Dimensions .....	9-22
9.8.5.	Ramps .....	9-24
9.8.6.	Landings .....	9-25

9.8.7.	Handrails .....	9-26
9.8.8.	Guards .....	9-28
9.8.9.	Construction .....	9-31
9.8.10.	Cantilevered Precast Concrete Steps .....	9-32
<b>9.9.</b>	<b>Means of Egress</b>	
9.9.1.	General .....	9-32
9.9.2.	Types and Purpose of Exits .....	9-33
9.9.3.	Dimensions of Means of Egress ...	9-33
9.9.4.	Fire Protection of Exits .....	9-34
9.9.5.	Obstructions and Hazards in Means of Egress .....	9-36
9.9.6.	Doors in a Means of Egress .....	9-37
9.9.7.	Access to Exits .....	9-39
9.9.8.	Exits from Floor Areas .....	9-40
9.9.9.	Egress from Dwelling Units .....	9-41
9.9.10.	Egress from Bedrooms .....	9-42
9.9.11.	Signs .....	9-43
9.9.12.	Lighting .....	9-44
<b>9.10.</b>	<b>Fire Protection</b>	
9.10.1.	Definitions and Application .....	9-45
9.10.2.	Occupancy Classification .....	9-46
9.10.3.	Ratings .....	9-46
9.10.4.	Building Size Determination .....	9-47
9.10.5.	Permitted Openings in Wall and Ceiling Membranes .....	9-48
9.10.6.	Construction Types .....	9-48
9.10.7.	Steel Members .....	9-48
9.10.8.	Fire Resistance and Combustibility in Relation to Occupancy, Height and Supported Elements .....	9-48
9.10.9.	Fire Separations and Smoke-tight Barriers between Rooms and Spaces within Buildings .....	9-50
9.10.10.	Service Rooms .....	9-55
9.10.11.	Firewalls .....	9-56
9.10.12.	Prevention of Fire Spread at Exterior Walls and between Storeys .....	9-57
9.10.13.	Doors, Dampers and Other Closures in Fire Separations .....	9-58
9.10.14.	Spatial Separation Between Buildings .....	9-61
9.10.15.	Spatial Separation Between Houses .....	9-66
9.10.16.	Fire Blocks .....	9-70
9.10.17.	Flame-Spread Limits .....	9-72
9.10.18.	Alarm and Detection Systems .....	9-74
9.10.19.	Smoke Alarms .....	9-75
9.10.20.	Firefighting .....	9-77
9.10.21.	Fire Protection for Construction Camps .....	9-78
9.10.22.	Fire Protection for Gas, Propane and Electric Cooktops and Ovens .....	9-79
<b>9.11.</b>	<b>Sound Transmission</b>	
9.11.1.	Protection from Airborne Noise ....	9-79

## Division B

<b>9.12.</b>	<b>Excavation</b>	
9.12.1.	General .....	9-81
9.12.2.	Depth .....	9-82
9.12.3.	Backfill .....	9-83
9.12.4.	Trenches beneath Footings .....	9-83
<b>9.13.</b>	<b>Dampproofing, Waterproofing and Soil Gas Control</b>	
9.13.1.	General .....	9-84
9.13.2.	Dampproofing .....	9-84
9.13.3.	Waterproofing .....	9-86
9.13.4.	Soil Gas Control .....	9-87
<b>9.14.</b>	<b>Drainage</b>	
9.14.1.	Scope .....	9-88
9.14.2.	Foundation Drainage .....	9-89
9.14.3.	Drainage Tile and Pipe .....	9-89
9.14.4.	Granular Drainage Layer .....	9-90
9.14.5.	Drainage Disposal .....	9-90
9.14.6.	Surface Drainage .....	9-90
<b>9.15.</b>	<b>Footings and Foundations</b>	
9.15.1.	Application .....	9-91
9.15.2.	General .....	9-92
9.15.3.	Footings .....	9-92
9.15.4.	Foundation Walls .....	9-94
9.15.5.	Support of Joists and Beams on Masonry Foundation Walls .....	9-99
9.15.6.	Parging and Finishing of Masonry Foundation Walls .....	9-99
<b>9.16.</b>	<b>Floors-on-Ground</b>	
9.16.1.	Scope .....	9-99
9.16.2.	Material beneath Floors .....	9-100
9.16.3.	Drainage .....	9-100
9.16.4.	Concrete .....	9-101
9.16.5.	Wood .....	9-101
<b>9.17.</b>	<b>Columns</b>	
9.17.1.	Scope .....	9-101
9.17.2.	General .....	9-102
9.17.3.	Steel Columns .....	9-102
9.17.4.	Wood Columns .....	9-102
9.17.5.	Unit Masonry Columns .....	9-103
9.17.6.	Solid Concrete Columns .....	9-103
<b>9.18.</b>	<b>Crawl Spaces</b>	
9.18.1.	General .....	9-103
9.18.2.	Access .....	9-104
9.18.3.	Ventilation .....	9-104
9.18.4.	Clearance .....	9-104
9.18.5.	Drainage .....	9-104
9.18.6.	Ground Cover .....	9-105
9.18.7.	Fire Protection .....	9-105
<b>9.19.</b>	<b>Roof Spaces</b>	
9.19.1.	Venting .....	9-105
9.19.2.	Access .....	9-106

<b>9.20.</b>	<b>Masonry and Insulating Concrete Form Walls Not In Contact with the Ground</b>	
9.20.1.	Application .....	9-107
9.20.2.	Masonry Units .....	9-107
9.20.3.	Mortar .....	9-108
9.20.4.	Mortar Joints .....	9-109
9.20.5.	Masonry Support .....	9-110
9.20.6.	Thickness and Height .....	9-110
9.20.7.	Chases and Recesses .....	9-111
9.20.8.	Support of Loads .....	9-112
9.20.9.	Bonding and Tying .....	9-113
9.20.10.	Lateral Support .....	9-114
9.20.11.	Anchorage of Roofs, Floors and Intersecting Walls .....	9-115
9.20.12.	Corbelling .....	9-116
9.20.13.	Control of Rainwater Penetration .....	9-116
9.20.14.	Protection during Work .....	9-118
9.20.15.	Reinforcement for Earthquake Resistance .....	9-119
9.20.16.	Corrosion Resistance .....	9-119
9.20.17.	Above-Ground Flat Insulating Concrete Form Walls .....	9-119
<b>9.21.</b>	<b>Masonry and Concrete Chimneys and Flues</b>	
9.21.1.	General .....	9-121
9.21.2.	Chimney Flues .....	9-121
9.21.3.	Chimney Lining .....	9-123
9.21.4.	Masonry and Concrete Chimney Construction .....	9-124
9.21.5.	Clearance from Combustible Construction .....	9-125
<b>9.22.</b>	<b>Fireplaces</b>	
9.22.1.	General .....	9-126
9.22.2.	Fireplace Liners .....	9-126
9.22.3.	Fireplace Walls .....	9-126
9.22.4.	Fire Chamber .....	9-127
9.22.5.	Hearth .....	9-127
9.22.6.	Damper .....	9-127
9.22.7.	Smoke Chamber .....	9-127
9.22.8.	Factory-Built Fireplaces .....	9-127
9.22.9.	Clearance of Combustible Material .....	9-127
9.22.10.	Fireplace Inserts and Hearth-Mounted Stoves .....	9-128
<b>9.23.</b>	<b>Wood-Frame Construction</b>	
9.23.1.	Application .....	9-128
9.23.2.	General .....	9-129
9.23.3.	Fasteners .....	9-129
9.23.4.	Maximum Spans .....	9-133
9.23.5.	Notching and Drilling .....	9-135
9.23.6.	Anchorage .....	9-135
9.23.7.	Sill Plates .....	9-137
9.23.8.	Beams to Support Floors .....	9-137
9.23.9.	Floor Joists .....	9-138
9.23.10.	Wall Studs .....	9-140

## Division B

9.23.11.	Wall Plates .....	9-142
9.23.12.	Framing over Openings .....	9-143
9.23.13.	Bracing to Resist Lateral Loads Due to Wind and Earthquake .....	9-144
9.23.14.	Roof and Ceiling Framing .....	9-149
9.23.15.	Subflooring .....	9-152
9.23.16.	Roof Sheathing .....	9-153
9.23.17.	Wall Sheathing .....	9-155
<b>9.24.</b>	<b>Sheet Steel Stud Wall Framing</b>	
9.24.1.	General .....	9-156
9.24.2.	Size of Framing .....	9-157
9.24.3.	Installation .....	9-158
<b>9.25.</b>	<b>Heat Transfer, Air Leakage and Condensation Control</b>	
9.25.1.	General .....	9-159
9.25.2.	Thermal Insulation .....	9-160
9.25.3.	Air Barrier Systems .....	9-161
9.25.4.	Vapour Barriers .....	9-163
9.25.5.	Properties and Position of Materials in the Building Envelope .....	9-164
<b>9.26.</b>	<b>Roofing</b>	
9.26.1.	General .....	9-165
9.26.2.	Roofing Materials .....	9-165
9.26.3.	Slope of Roofed Surfaces .....	9-167
9.26.4.	Flashing at Intersections .....	9-168
9.26.5.	Eave Protection for Shingles and Shakes .....	9-170
9.26.6.	Underlay beneath Shingles .....	9-170
9.26.7.	Asphalt Shingles on Slopes of 1 in 3 or Greater .....	9-171
9.26.8.	Asphalt Shingles on Slopes of less than 1 in 3 .....	9-172
9.26.9.	Wood Roof Shingles .....	9-172
9.26.10.	Cedar Roof Shakes .....	9-173
9.26.11.	Built-Up Roofs .....	9-174
9.26.12.	Selvage Roofing .....	9-175
9.26.13.	Sheet Metal Roofing .....	9-175
9.26.14.	Glass Reinforced Polyester Roofing .....	9-176
9.26.15.	Hot Applied Rubberized Asphalt Roofing .....	9-176
9.26.16.	Polyvinyl Chloride Sheet Roofing .....	9-176
9.26.17.	Concrete Roof Tiles .....	9-176
9.26.18.	Roof Drains and Downspouts .....	9-176
<b>9.27.</b>	<b>Cladding</b>	
9.27.1.	Application .....	9-176
9.27.2.	Required Protection from Precipitation .....	9-177
9.27.3.	Second Plane of Protection .....	9-179
9.27.4.	Sealants .....	9-181
9.27.5.	Attachment of Cladding .....	9-182
9.27.6.	Lumber Siding .....	9-183
9.27.7.	Wood Shingles and Shakes .....	9-184
9.27.8.	Plywood .....	9-185

9.27.9.	Hardboard .....	9-186
9.27.10.	OSB and Waferboard .....	9-186
9.27.11.	Metal .....	9-187
9.27.12.	Vinyl Siding .....	9-187
9.27.13.	Exterior Insulation Finish Systems .....	9-188
<b>9.28.</b>	<b>Stucco</b>	
9.28.1.	General .....	9-188
9.28.2.	Stucco Materials .....	9-189
9.28.3.	Fasteners .....	9-189
9.28.4.	Stucco Lath .....	9-190
9.28.5.	Stucco Mixes .....	9-191
9.28.6.	Stucco Application .....	9-191
<b>9.29.</b>	<b>Interior Wall and Ceiling Finishes</b>	
9.29.1.	General .....	9-192
9.29.2.	Waterproof Wall Finish .....	9-192
9.29.3.	Wood Furring .....	9-192
9.29.4.	Plastering .....	9-193
9.29.5.	Gypsum Board Finish (Taped Joints) .....	9-193
9.29.6.	Plywood Finish .....	9-195
9.29.7.	Hardboard Finish .....	9-196
9.29.8.	Insulating Fibreboard Finish .....	9-196
9.29.9.	Particleboard, OSB or Waferboard Finish .....	9-197
9.29.10.	Wall Tile Finish .....	9-197
<b>9.30.</b>	<b>Flooring</b>	
9.30.1.	General .....	9-198
9.30.2.	Panel-Type Underlay .....	9-198
9.30.3.	Wood Strip Flooring .....	9-199
9.30.4.	Parquet Flooring .....	9-200
9.30.5.	Resilient Flooring .....	9-200
9.30.6.	Ceramic Tile .....	9-201
<b>9.31.</b>	<b>Plumbing Facilities</b>	
9.31.1.	Scope .....	9-201
9.31.2.	General .....	9-201
9.31.3.	Water Supply and Distribution ....	9-201
9.31.4.	Required Facilities .....	9-201
9.31.5.	Sewage Disposal .....	9-202
9.31.6.	Service Water Heating Facilities .....	9-202
<b>9.32.</b>	<b>Ventilation</b>	
9.32.1.	General .....	9-203
9.32.2.	Non-Heating-Season Ventilation .....	9-204
9.32.3.	Heating-Season Mechanical Ventilation .....	9-205
<b>9.33.</b>	<b>Heating and Air-conditioning</b>	
9.33.1.	General .....	9-216
9.33.2.	Required Heating Systems .....	9-217
9.33.3.	Design Temperatures .....	9-217
9.33.4.	General Requirements for Heating and Air-conditioning Systems .....	9-217



---

## **Division B**

9.33.5.	Heating and Air-conditioning Appliances and Equipment .....	9-218
9.33.6.	Air Duct Systems .....	9-219
9.33.7.	Radiators and Convectors .....	9-224
9.33.8.	Piping for Heating and Cooling Systems .....	9-224
9.33.9.	Refrigerating Systems and Equipment for Air-conditioning ..	9-225
9.33.10.	Chimneys and Venting Equipment .....	9-225
<b>9.34.</b>	<b>Electrical Facilities</b>	
9.34.1.	General .....	9-226
9.34.2.	Lighting Outlets .....	9-226
9.34.3.	Emergency Lighting .....	9-228
<b>9.35.</b>	<b>Garages and Carports</b>	
9.35.1.	Scope .....	9-228
9.35.2.	General .....	9-228
9.35.3.	Foundations .....	9-228
9.35.4.	Walls and Columns .....	9-229
<b>9.36.</b>	<b>Energy Efficiency</b>	
9.36.1.	General .....	9-230
9.36.2.	Building Envelope .....	9-231
9.36.3.	HVAC Requirements .....	9-242
9.36.4.	Service Water Heating Systems ..	9-247
9.36.5.	Energy Performance Compliance .....	9-249
<b>9.37.</b>	<b>Objectives and Functional Statements</b>	
9.37.1.	Objectives and Functional Statements .....	9-261
	<b>Fire and Sound Resistance Tables .....</b>	<b>9-369</b>
	<b>Span Tables .....</b>	<b>9-445</b>
	<b>Notes to Part 9 .....</b>	<b>9-479</b>



# Part 9

## Housing and Small Buildings

### Section 9.1. General

#### 9.1.1. Application

##### 9.1.1.1. Application

1) The application of this Part shall be as described in Subsection 1.3.3. of Division A. (See Note A-9.1.1.1.(1) regarding application to seasonally and intermittently occupied *buildings*.)

#### 9.1.2. Limits on Floor Area

##### 9.1.2.1. Floor Area Limits for Secondary Suites

- 1) The total *floor area* of all *storeys* of a *secondary suite* shall be not more than the lesser of
- 80% of the total *floor area* of all *storeys* of the other *dwelling unit*, excluding the garage *floor area* and common spaces serving both *dwelling units*, and
  - 80 m<sup>2</sup>.

### Section 9.2. Definitions

#### 9.2.1. General

##### 9.2.1.1. Defined Words

- 1) Words in italics are defined in Article 1.4.1.2. of Division A.

### Section 9.3. Materials, Systems and Equipment

#### 9.3.1. Concrete

##### 9.3.1.1. General

1) Except as provided in Sentence (2) and Articles 9.3.1.6. and 9.3.1.7., unreinforced and nominally reinforced concrete shall be designed, mixed, placed, cured and tested in accordance with the requirements for "R" class concrete stated in Section 9 of CSA A23.1, "Concrete Materials and Methods of Concrete Construction."

2) Unreinforced and nominally reinforced site-batched concrete shall be designed, mixed, placed and cured in accordance with Articles 9.3.1.2. to 9.3.1.9.

3) Except as provided in Sentence (4), reinforced concrete shall be designed to conform to the requirements of Part 4.

4) For flat insulating concrete form walls not exceeding 2 *storeys* in *building height* and having a maximum floor to floor height of 3 m, in *buildings* of light-frame

construction containing only a single *dwelling unit*, the concrete and reinforcing shall comply with Part 4 or

- a) the concrete shall conform to CSA A23.1, "Concrete Materials and Methods of Concrete Construction," with a maximum aggregate size of 19 mm, and
- b) the reinforcing shall
  - i) conform to CSA G30.18, "Carbon Steel Bars for Concrete Reinforcement,"
  - ii) have a minimum specified yield strength of 400 MPa, and
  - iii) be lapped a minimum of 450 mm for 10M bars and 650 mm for 15M bars (see also Articles 9.15.4.5. and 9.20.17.2. to 9.20.17.4.).

#### 9.3.1.2. Cement

1) Cement shall meet the requirements of CSA A3001, "Cementitious Materials for Use in Concrete."

#### 9.3.1.3. Concrete in Contact with Sulphate Soil

1) Concrete in contact with sulphate *soil*, which is deleterious to normal cement, shall conform to the requirements in Clause 4.1.1.6 of CSA A23.1, "Concrete Materials and Methods of Concrete Construction."

#### 9.3.1.4. Aggregates

- 1) Aggregates shall
  - a) consist of sand, gravel, crushed *rock*, crushed air-cooled blast *furnace* slag, expanded shale or expanded clay conforming to CSA A23.1, "Concrete Materials and Methods of Concrete Construction," and
  - b) be clean, well-graded and free of injurious amounts of organic and other deleterious material.

#### 9.3.1.5. Water

1) Water shall be clean and free of injurious amounts of oil, organic matter, sediment or any other deleterious material.

#### 9.3.1.6. Compressive Strength

(See also Article 9.12.4.1., Sentence 9.15.4.2.(1) and Article 9.18.6.1.)

- 1) Except as provided elsewhere in this Part, the compressive strength of unreinforced concrete after 28 days shall be not less than
  - a) 15 MPa for walls, columns, fireplaces and *chimneys*, footings, *foundation* walls, grade beams and piers,
  - b) 20 MPa for floors other than those in garages and carports, and
  - c) for garage and carport floors, and the exterior steps,
    - i) 32 MPa, or
    - ii) 30 MPa where indigenous aggregates do not achieve 32 MPa with a 0.45 water to cementing material ratio.

2) Site-batched concrete used for garage and carport floors and exterior steps shall have air entrainment of 5 to 8%.

#### 9.3.1.7. Concrete Mixes

(See Note A-9.3.1.7.)

- 1) For pre-mixed concrete and for the site-batched concrete mixes described in Table 9.3.1.7., the maximum ratio of water to cementing materials measured by weight shall not exceed
  - a) 0.70 for walls, columns, fireplaces and *chimneys*, footings, *foundation* walls, grade beams and piers,
  - b) 0.65 for floors other than those in garages and carports, and
  - c) 0.45 for garage and carport floors, and exterior steps.

**Table 9.3.1.7.**  
**Site-Batched Concrete Mixes**  
 Forming Part of Sentence 9.3.1.7.(1)

Maximum Size of Coarse Aggregate, mm	Materials, volume					
	Cementing Material		Fine Aggregate (damp average coarse sand)		Coarse Aggregate (gravel or crushed stone)	
	Parts <sup>(1)</sup>	L	Parts	L	Parts	L
14	1	28	1.75	49	2	56
20	1	28	1.75	49	2.5	70
28	1	28	2	56	3	84
40	1	28	2	56	3.5	98

**Notes to Table 9.3.1.7.:**

(1) 1 part cementing material = 1 x 40 kg bag

- 2)** The size of aggregate in unreinforced site-batched concrete mixes referred to in Sentence (1) shall not exceed
  - a) 1/5 the distance between the sides of vertical forms, or
  - b) 1/3 the thickness of flatwork.

**9.3.1.8. Admixtures**

**1)** Admixtures shall conform to ASTM C 260, "Air-Entraining Admixtures for Concrete," or ASTM C 494/C 494M, "Chemical Admixtures for Concrete," as applicable.

**9.3.1.9. Cold Weather Requirements**

- 1)** When the air temperature is below 5°C, concrete shall be
  - a) kept at a temperature of not less than 10°C or more than 25°C while being mixed and placed, and
  - b) maintained at a temperature of not less than 10°C for 72 h after placing.
- 2)** No frozen material or ice shall be used in concrete described in Sentence (1).

**9.3.2. Lumber and Wood Products**

**9.3.2.1. Grade Marking**

**1)** Lumber for joists, rafters, trusses and beams and for the uses listed in Table 9.3.2.1. shall be identified by a grade stamp to indicate its grade as determined by NLGA 2014, "Standard Grading Rules for Canadian Lumber." (See Note A-9.3.2.1.(1).)

**Table 9.3.2.1.**  
**Minimum Lumber Grades for Specific End Uses**  
 Forming Part of Sentence 9.3.2.1.(1)

Use	Boards <sup>(1)</sup>			Framing
	Paragraph in the NLGA Grading Rules under which boards are graded			All Species
	All Species		Eastern White Pine & Red Pine	
	Para 113	Para 114	Para 118	
Stud wall framing ( <i>loadbearing</i> members)	—	—	—	Stud, Standard, No. 2
Stud wall framing ( <i>non-loadbearing</i> members)	—	—	—	Stud, Utility, No. 3
Plank frame construction ( <i>loadbearing</i> members)	No. 3 Common	—	No. 3 Common	No. 2
Plank frame construction ( <i>non-loadbearing</i> members)	No. 5 Common	—	No. 5 Common	Economy, No. 3
Posts and beams less than 114 mm in thickness	—	—	—	Standard, No. 2
Posts and beams not less than 114 mm in thickness	—	—	—	Standard
Roof sheathing	No. 3 Common	Standard	No. 4 Common	—
Subflooring	No. 3 Common	Standard	No. 3 Common	—
Wall sheathing when required as a nailing base	No. 4 Common	Utility	No. 4 Common	—
Wall sheathing not required as a nailing base	No. 5 Common	Economy	No. 5 Common	—

**Notes to Table 9.3.2.1.:**

(1) See Note A-Table 9.3.2.1.

**9.3.2.2. Lumber Grades**

1) Except for joists, rafters, trusses and beams, visually graded lumber shall conform to the grades in Table 9.3.2.1. (See Article 9.23.4.2. for joists, rafters and beams and Article 9.23.14.11. for trusses.)

**9.3.2.3. Machine Stress Rated Lumber**

1) Machine stress rated lumber shall conform to the requirements of Subsection 4.3.1.

**9.3.2.4. OSB, Waferboard and Plywood Marking**

1) OSB, waferboard and plywood used for roof sheathing, wall sheathing and subflooring shall be legibly identified on the face of the material indicating

- the manufacturer of the material,
- the standard to which it is produced, and
- that the material is of an exterior type.

**9.3.2.5. Moisture Content**

1) Moisture content of lumber shall be not more than 19% at the time of installation.

**9.3.2.6. Lumber Dimensions**

1) Lumber dimensions referred to in this Part are actual dimensions determined in conformance with CSA O141, "Softwood Lumber."

**9.3.2.7. Panel Thickness Tolerances**

1) The thicknesses specified in this Part for plywood, hardboard, particleboard, OSB and waferboard shall be subject to the tolerances permitted in the standards referenced for these products unless specifically indicated herein.

**9.3.2.8. Undersized Lumber**

**1)** Joist, rafter, lintel and beam members up to 5% less than the actual Canadian standard sizes are permitted to be used provided the allowable spans for the grade and species of lumber under consideration are reduced 5% from those shown in the Span Tables for full size members. (See Note A-9.3.2.8.(1).)

**9.3.2.9. Termite and Decay Protection**

- 1)** In localities where termites are known to occur,
- a) clearance between structural wood elements and the finished ground level directly below them shall be not less than 450 mm and, except as provided in Sentence (2), all sides of the supporting elements shall be visible to permit inspection, or
  - b) structural wood elements, supported by elements in contact with the ground or exposed over bare soil, shall be pressure-treated with a chemical that is toxic to termites.

(See Note A-9.3.2.9.(1).)

**2)** In localities where termites are known to occur and *foundations* are insulated or otherwise finished in a manner that could conceal a termite infestation,

- a) a metal or plastic barrier shall be installed through the insulation and any other separation or finish materials above finished ground level to control the passage of termites behind or through the insulation, separation or finish materials, and
- b) all sides of the finished supporting assembly shall be visible to permit inspection.

**3)** Structural wood elements shall be pressure-treated with a preservative to resist decay,

- a) where the vertical clearance between structural wood elements and the finished ground level is less than 150 mm (see also Articles 9.23.2.2. and 9.23.2.3.), or
- b) where
  - i) the wood elements are not protected from exposure to precipitation,
  - ii) the configuration is conducive to moisture accumulation, and
  - iii) the moisture index is greater than 1.00.

(See Note A-9.3.2.9.(3).)

**4)** Structural wood elements used in retaining walls and cribbing shall be pressure-treated with a preservative to resist decay, where

- a) the retaining wall or cribbing supports ground that is critical to the stability of *building foundations*, or
- b) the retaining wall or cribbing is greater than 1.2 m in height.

(See Note A-9.3.2.9.(4).)

**5)** Where wood is required by this Article to be treated to resist termites or decay, such treatment shall be in accordance with Table 2, Use Categories for Specific Products, Uses, and Exposures, of CAN/CSA-O80.1, "Specification of Treated Wood," as follows:

- a) Use Category 1 (UC1), where the wood member is used in
  - i) interior construction,
  - ii) above-ground applications, and
  - iii) applications where the wood member remains dry,
- b) Use Category 2 (UC2), where the wood member is used in
  - i) interior construction,
  - ii) above-ground applications, and
  - iii) applications where the wood member may be subjected to occasional sources of moisture,
- c) Use Category 3.2 (UC3.2), where the wood member is used in
  - i) exterior construction,

- ii) above-ground applications, and
  - iii) applications where the wood member is uncoated or is used in a configuration conducive to moisture accumulation,
  - d) Use Category 4.1 (UC4.1), where
    - i) the wood member is in contact with the ground,
    - ii) the wood member is in contact with fresh water, or
    - iii) the vertical clearance between the wood element and the finished ground level is less than 150 mm and the wood elements are not separated from permeable supporting materials by a moisture barrier, or
  - e) Use Category 4.2 (UC4.2), where the wood member is used in critical structural components, including permanent wood *foundations*.
- 6)** Where wood is protected in accordance with UC1 or UC2 using an inorganic boron preservative, the wood shall be
- a) protected from direct exposure to water during and after the completion of construction, and
  - b) separated from permeable supporting materials by a moisture barrier that is resistant to all expected mechanisms of deterioration in the service environment if the vertical clearance to the ground is less than 150 mm.
- 7)** Wood that is required by this Article to be treated to resist termites or decay shall be identified by a mark to indicate the type of preservative used and conformance to the relevant required Use Category.

### 9.3.3. Metal

#### 9.3.3.1. Sheet Metal Thickness

- 1)** Minimum thicknesses for sheet metal material that are stated in this Part refer to the actual minimum base metal thicknesses measured at any point of the material and, in the case of galvanized steel described in Sentence 9.3.3.2.(1), include the thickness of the galvanizing coating unless otherwise indicated.

#### 9.3.3.2. Galvanized Sheet Steel

- 1)** Where sheet steel is required to be galvanized, it shall be metallic-coated with zinc or an alloy of 55% aluminum-zinc meeting the requirements of
- a) ASTM A 653/A 653M, "Steel Sheet, Zinc-Coated (Galvanized) or Zinc-Iron Alloy-Coated (Galvannealed) by the Hot-Dip Process," or
  - b) ASTM A 792/A 792M, "Steel Sheet, 55% Aluminum-Zinc Alloy-Coated by the Hot-Dip Process."
- 2)** Where galvanized sheet steel is intended for use in locations exposed to the weather or as a flashing material, it shall have a zinc coating not less than the G90 [Z275] coating designation or an aluminum-zinc alloy coating not less than the AZM150 coating designation, as referred to in Sentence (1).

## Section 9.4. Structural Requirements

### 9.4.1. Structural Design Requirements and Application Limitations

#### 9.4.1.1. General

(See Note A-9.4.1.1.)

- 1)** Subject to the application limitations defined elsewhere in this Part, structural members and their connections shall
- a) conform to requirements provided elsewhere in this Part,



- b) be designed according to good engineering practice such as that provided in CWC 2014, "Engineering Guide for Wood Frame Construction," or
- c) be designed according to Part 4 using the loads and deflection and vibration limits specified in
  - i) Part 9, or
  - ii) Part 4.

**2)** Where floor framing is designed in accordance with Clause (1)(b) or (c), and where supporting wall framing and fastenings, or footings, are designed according to Clause (1)(a), the maximum specified *live load* on the floor according to Table 4.1.5.3. shall not exceed 2.4 kPa.

**3)** Location-specific information for structural design, including snow and wind loads and seismic spectral response accelerations, shall be determined according to Subsection 1.1.3.

**9.4.2. Specified Loads**

**9.4.2.1. Application**

**1)** This Subsection applies to light-frame constructions whose wall, floor and roof planes are generally comprised of frames of small repetitive structural members, and where

- a) the roof and wall planes are clad, sheathed or braced on at least one side,
- b) the small repetitive structural members are spaced not more than 600 mm o.c.,
- c) the clear span of any structural member does not exceed 12.2 m,
- d) the maximum deflection of the structural roof members conforms to Article 9.4.3.1.,
- e) the maximum total roof area, notwithstanding any separation of adjoining *buildings* by *firewalls*, is 4 550 m<sup>2</sup>, and
- f) for flat roofs, there are no significant obstructions on the roof, such as parapet walls, spaced closer than the distance calculated by

$$D_o = 10 (H_o - 0.8S_s/\gamma)$$

where

- D<sub>o</sub> = minimum distance between obstructions, m,
- H<sub>o</sub> = height of the obstruction above the roof, m,
- S<sub>s</sub> = ground snow load, kPa, and
- γ = specific weight of snow, kN/m<sup>3</sup>.

(See Note A-9.4.2.1.(1).)

**9.4.2.2. Specified Snow Loads**

(See Note A-9.4.2.2.)

**1)** Except as provided in Sentences (2) and (3), specified snow loads shall be not less than those calculated using the following formula:

$$S = C_b S_s + S_r$$

where

- S = specified snow load,
- C<sub>b</sub> = basic snow load roof factor, which is 0.45 where the entire width of the roof does not exceed 4.3 m and 0.55 for all other roofs,
- S<sub>s</sub> = 1-in-50-year ground snow load in kPa, determined according to Subsection 1.1.3., and
- S<sub>r</sub> = associated 1-in-50-year rain load in kPa, determined according to Subsection 1.1.3.

2) In no case shall the specified snow load be less than 1 kPa.

3) Bow string, arch or semi-circular roof trusses having an unsupported span greater than 6 m shall be designed in conformance with the snow load requirements in Subsection 4.1.6.

### 9.4.2.3. Platforms Subject to Snow and Occupancy Loads

1) Balconies, decks and other accessible exterior platforms intended for an *occupancy* and subject to snow loads shall be designed to carry the specified roof snow load or 1.9 kPa, whichever is greater, where the platform, or each segregated area of the platform, serves a single *dwelling unit*. (See Note A-9.4.2.3.(1).)

### 9.4.2.4. Attics and Roof Spaces

1) The ceiling joists or truss bottom chords in residential *attic or roof spaces* having limited accessibility that precludes the storage of equipment or material shall be designed for a total specified load of not less than 0.35 kPa, where the total specified load is the sum of the specified *dead load* plus the specified *live load* of the ceiling. (See Note A-9.4.2.4.(1).)

## 9.4.3. Deflections

### 9.4.3.1. Deflections

1) The maximum deflection of structural members shall conform to Table 9.4.3.1.

2) *Dead loads* need not be considered in computing deflections referred to in Sentence (1).

**Table 9.4.3.1.**  
**Maximum Deflections**  
Forming Part of Sentence 9.4.3.1.(1)

Structural Members	Type of Ceiling Supported	Max. Allowable Deflection as an Expressed Ratio of the Clear Span
Roof rafters, roof joists and roof beams	No ceiling	1/180
	Other than plaster or gypsum board	1/240
	Plaster or gypsum board	1/360
Ceiling joists	Other than plaster or gypsum board	1/240
	Plaster or gypsum board	1/360
Floor beams, floor joists and floor decking	All cases	1/360
Beams, joists and decking for balconies, decks and other accessible exterior platforms	Serving a single <i>dwelling unit</i>	1/240
	Other	1/360

## 9.4.4. Foundation Conditions

### 9.4.4.1. Allowable Bearing Pressures

- 1) Footing sizes for *shallow foundations* shall be
  - a) determined in accordance with Section 9.15., or
  - b) designed in accordance with Section 4.2. using
    - i) the maximum allowable bearing pressures in Table 9.4.4.1., or
    - ii) allowable bearing pressures determined from *subsurface investigation*.

**Table 9.4.4.1.**  
**Allowable Bearing Pressure for Soil or Rock**  
 Forming Part of Sentence 9.4.4.1.(1)

Type and Condition of <i>Soil</i> or <i>Rock</i>	Maximum Allowable Bearing Pressure, kPa
Dense or compact sand or gravel <sup>(1)</sup>	150
Loose sand or gravel <sup>(1)</sup>	50
Dense or compact silt <sup>(1)</sup>	100
Stiff clay <sup>(1)</sup>	150
Firm clay <sup>(1)</sup>	75
Soft clay <sup>(1)</sup>	40
Till	200
Clay shale	300
Sound <i>rock</i>	500

**Notes to Table 9.4.4.1.:**

(1) See Note A-Table 9.4.4.1.

**9.4.4.2. Foundation Capacity in Weaker Soil and Rock**

**1)** Where a *soil* or *rock* within a distance equal to twice the footing width below the *bearing surface* has a lower allowable bearing pressure than that at the *bearing surface* as shown in Article 9.4.4.1., the design capacity of the *foundation* shall not be greater than would cause the weakest *soil* or *rock* to be stressed beyond its allowable bearing pressure.

**2)** In calculating subsurface pressures referred to in Sentence (1), the loads from the footings shall be assumed to be distributed uniformly over a horizontal plane within a frustum extending downward from the footing at an angle of 60° to the horizontal.

**9.4.4.3. High Water Table**

**1)** Where a *foundation* bears on gravel, sand or silt, and the water table is within a distance below the *bearing surface* equal to the width of the *foundation*, the allowable bearing pressure shall be 50% of that determined in Article 9.4.4.1.

**9.4.4.4. Soil Movement**

**1)** Where a *foundation* is located in an area where *soil* movement caused by changes in *soil* moisture content, freezing, or chemical-microbiological oxidation is known to occur to the extent that it will damage a *building*, measures shall be taken to preclude such movement or to reduce its effects on the *building* so that the *building's* stability and the performance of assemblies will not be adversely affected. (See Note A-9.4.4.4.(1).)

**9.4.4.5. Retaining Walls**

**1)** Walls shall be designed to resist the lateral pressure of the retained material.

**9.4.4.6. Walls Supporting Drained Earth**

(See Note A-9.4.4.6. and 9.15.1.1.)

**1)** Except where constructed in accordance with Section 9.15., walls supporting drained earth shall be designed

- a) for a pressure equivalent to that exerted by a fluid that has a density of not less than 480 kg/m<sup>3</sup> and a depth equal to that of the retained earth, or
- b) in accordance with Section 4.2. so as to be able to resist the loads and effects described in Article 4.1.2.1.

- 2) Walls supporting other than drained earth shall be designed
  - a) for the pressure described in Clause (1)(a) plus the fluid pressure of the surcharge, or
  - b) in accordance with Section 4.2. so as to be able to resist the loads and effects described in Article 4.1.2.1.

## Section 9.5. Design of Areas and Spaces

### 9.5.1. General

#### 9.5.1.1. Method of Measurement

1) Unless otherwise indicated herein, dimensions of rooms or spaces shall be measured between finished wall surfaces and between finished floor and ceiling surfaces.

#### 9.5.1.2. Combination Rooms

(See Note A-9.5.1.2.)

1) Two or more areas may be considered as a combination room if the opening between the areas occupies the larger of 3 m<sup>2</sup> or 40% or more of the area of the wall measured on the side of the dependent area.

2) Where the dependent area is a bedroom, direct passage shall be provided between the two areas.

### 9.5.2. Barrier-Free Design

#### 9.5.2.1. General

1) Except as provided in Articles 9.5.2.3. and 3.8.2.1., every *building* shall be designed in conformance with Section 3.8.

#### 9.5.2.2. Protection on Floor Areas with a Barrier-Free Path of Travel

1) Where a *barrier-free* path of travel required in Article 9.5.2.1. is provided to any *storey* above the *first storey*, the requirements in Article 3.3.1.7. shall apply.

#### 9.5.2.3. Exception for Apartment Buildings

1) Except as provided in Sentence (2), if the *building* is not equipped with an elevator, the *barrier-free* path of travel described in Section 3.8. need only be provided on the entrance level of an apartment *building*.

2) The *barrier-free* path of travel on the entrance level described in Sentence (1) need not be provided where the difference in floor elevation between the entrance level and every *dwelling unit* exceeds 600 mm.

### 9.5.3. Ceiling Heights

#### 9.5.3.1. Ceiling Heights of Rooms or Spaces

1) Except as provided in Sentences (2) and (3), the ceiling heights and clear heights in rooms or spaces in *residential occupancies* shall conform to Table 9.5.3.1.

2) Ceiling heights in *secondary suites* shall be not less than 1.95 m.

3) Clear heights under beams and ducting in *secondary suites* shall be not less than 1.85 m.

4) Areas in rooms or spaces over which ceiling height and clear height are not less than the minimum specified in Table 9.5.3.1. or Sentence (2) or (3) shall be contiguous with the entry or entries to those rooms or spaces.

**Table 9.5.3.1.**  
**Room Ceiling Heights**  
 Forming Part of Sentences 9.5.3.1.(1) and (4)

Room or Space	Minimum Ceiling Height, m	Minimum Clear Height, m	Minimum Area Over Which Minimum Ceiling Height Shall Be Provided <sup>(1)</sup>
Living room or space	2.1	2.0	Lesser of area of the space or 10.0 m <sup>2</sup>
Dining room or space	2.1		Lesser of area of the space or 5.2 m <sup>2</sup>
Kitchen or kitchen space	2.1		Lesser of area of the space or 3.2 m <sup>2</sup>
Master bedroom or bedroom space	2.1		Lesser of area of the space or 4.9 m <sup>2</sup>
Other bedroom or sleeping space	2.1		Lesser of area of the space or 3.5 m <sup>2</sup>
Unfinished <i>basement</i> including laundry area therein			Clear height under beams and in any location that would normally be used for passage
Bathroom, water-closet room or laundry area above <i>grade</i>	2.1		Lesser of area of the space or 2.2 m <sup>2</sup>
Passage, hall or main entrance vestibule	2.1		Area of the space
Habitable rooms and spaces not specifically mentioned above	2.1		Lesser of area of the space or 2.2 m <sup>2</sup>

**Notes to Table 9.5.3.1.:**

(1) Area of the space shall be measured at floor level.

**9.5.3.2. Mezzanines**

1) The ceiling height above and below a *mezzanine* floor assembly in *occupancies* other than *residential occupancies* shall be not less than 2.1 m.

**9.5.3.3. Storage Garages**

1) The clear height in a *storage garage* shall be not less than 2 m.

**9.5.4. Hallways**

**9.5.4.1. Hallway Width**

- 1) The unobstructed width of a hallway within a *dwelling unit* shall be not less than 860 mm, except that the hallway width is permitted to be 710 mm where
- a) there are only bedrooms and bathrooms at the end of the hallway furthest from the living area, and
  - b) a second *exit* is provided
    - i) in the hallway near the end farthest from the living area, or
    - ii) in each bedroom served by the hallway.

**9.5.5. Doorway Sizes**

**9.5.5.1. Doorway Opening Sizes**

1) Except as provided in Sentence (2) and Articles 9.5.5.3., 9.9.6.2. and 9.9.6.3., doorway openings within *dwelling units* and within houses with a *secondary suite* including their common spaces shall be designed to accommodate at least the door sizes given in Table 9.5.5.1. for swing-type and folding doors.

2) Doorway openings within *secondary suites* shall be designed to accommodate swing-type and folding doors not less than 1 890 mm high where the ceiling height complies with Sentence 9.5.3.1.(2).

**Table 9.5.5.1.**  
**Size of Doors**  
 Forming Part of Sentence 9.5.5.1.(1)

At Entrance to:	Minimum Width, mm	Minimum Height, mm
<i>Dwelling unit</i> or house with a <i>secondary suite</i> including common spaces (required entrance) Vestibule or entrance hall	810	1 980
Stairs to a floor level that contains a finished space All doors in at least one line of passage from the exterior to the <i>basement</i> Utility rooms	810	1 980
Walk-in closet	610	1 980
Bathroom, water-closet room, shower room <sup>(1)</sup>	610	1 980
Rooms located off hallways that are permitted to be 710 mm wide	610	1 980
Rooms not mentioned above, exterior balconies	760	1 980

**Notes to Table 9.5.5.1.:**

(1) See Article 9.5.5.3.

**9.5.5.2. Doorways to Public Water-Closet Rooms**

**1)** Doorways to public water-closet rooms shall be not less than 810 mm wide and 2 030 mm high.

**9.5.5.3. Doorways to Rooms with a Bathtub, Shower or Water Closet**

(See Note A-9.5.5.3.)

**1)** This Article applies where a hallway of not less than 860 mm wide serves one or more rooms containing a bathtub, shower or water closet.

- 2)** At least one doorway in a hallway described in Sentence (1) shall be constructed
- so that access is provided to not less than 1 of each type of fixture described in Sentence (1), and
  - to accommodate a door not less than 760 mm wide.

## Section 9.6. Glass

### 9.6.1. General

#### 9.6.1.1. Application

- 1)** This Section applies to
- glass in
    - interior doors and interior windows and their sidelights,
    - clothes closets,
    - site-built exterior windows, doors and skylights,
    - shower or bathtub enclosures,
    - glazed panels and partitions, and
  - the protection of glass.

#### 9.6.1.2. Material Standards for Glass

- 1)** Glass shall conform to
- CAN/CGSB-12.1-M, "Tempered or Laminated Safety Glass,"
  - CAN/CGSB-12.2-M, "Flat, Clear Sheet Glass,"
  - CAN/CGSB-12.3-M, "Flat, Clear Float Glass,"
  - CAN/CGSB-12.4-M, "Heat Absorbing Glass,"
  - CAN/CGSB-12.8, "Insulating Glass Units,"
  - CAN/CGSB-12.10-M, "Glass, Light and Heat Reflecting,"

- g) CAN/CGSB-12.11-M, "Wired Safety Glass," or
- h) ASTM E 2190, "Insulating Glass Unit Performance and Evaluation."

**2)** Mirrored glass doors are only permitted to be used at the entrance to clothes closets and shall conform to the requirements of CAN/CGSB-82.6-M, "Doors, Mirrored Glass, Sliding or Folding, Wardrobe." (See Note A-9.6.1.2.(2).)

**9.6.1.3. Structural Sufficiency of Glass**

- 1)** Except as provided in Sentence (2), glass shall be designed in conformance with
  - a) CAN/CGSB-12.20-M, "Structural Design of Glass for Buildings," or
  - b) ASTM E 1300, "Determining Load Resistance of Glass in Buildings." (See also Article 4.3.6.1.).
- 2)** Where the *building* has an essentially uniform distribution of paths for air leakage, including operable openings, but no large openings that would permit wind gusts to rapidly enter the *building* and the *building* is not in an exceptionally exposed location such as a hilltop, the maximum area of individual panes of glass for windows shall conform to
  - a) Tables 9.6.1.3.-A to 9.6.1.3.-C, where the *building* has a height from *grade* to the uppermost roof of 12 m or less, and is located in a built-up area, no less than 120 m away from the boundary between this area and open terrain, or
  - b) Tables 9.6.1.3.-D to 9.6.1.3.-F.
 (See Note A-9.6.1.3.(2).)

**Table 9.6.1.3.-A**  
**Maximum Glass Area for Windows in Areas for which the 1-in-50 Hourly Wind Pressure (HWP) is less than 0.55 kPa<sup>(1)</sup>**  
 Forming Part of Clause 9.6.1.3.(2)(a)

Type of Glass	Maximum Glass Area, m <sup>2</sup>							
	Glass Thickness, mm							
	2.5	3	4	5	6	8	10	12
Annealed	0.58	0.96	1.47	2.04	2.84	4.74	6.65	9.74
Factory-sealed insulated glass (IG) units <sup>(2)</sup>	1.02	1.71	2.68	3.74	5.24	7.93	9.92	13.92
Heat-strengthened or tempered	1.24	1.93	2.60	3.18	3.99	5.55	6.99	9.74
Wired	0.27	0.45	0.68	0.93	1.31	2.15	3.07	5.03

**Notes to Table 9.6.1.3.-A:**

- (1) The maximum hourly wind pressure with one chance in fifty of being exceeded in any one year, as provided in Appendix C.
- (2) Maximum glass area values apply to IG units of two identical lites (annealed, heat-strengthened or tempered) spaced at 12.7 mm.

**Table 9.6.1.3.-B**  
**Maximum Glass Area for Windows in Areas for which the 1-in-50 Hourly Wind Pressure (HWP) is less than 0.75 kPa<sup>(1)</sup>**  
 Forming Part of Clause 9.6.1.3.(2)(a)

Type of Glass	Maximum Glass Area, m <sup>2</sup>							
	Glass Thickness, mm							
	2.5	3	4	5	6	8	10	12
Annealed	0.42	0.68	1.02	1.42	2.04	3.34	4.70	7.65
Factory-sealed insulated glass (IG) units <sup>(2)</sup>	0.72	1.19	1.85	2.56	3.64	6.01	8.35	11.83
Heat-strengthened	0.88	1.46	2.21	2.71	3.39	4.73	5.92	8.29
Tempered	1.18	1.64	2.21	2.71	3.39	4.73	5.92	8.29
Wired	0.20	0.32	0.50	0.68	0.94	1.55	2.19	3.60

**Notes to Table 9.6.1.3.-B:**

- (1) The maximum hourly wind pressure with one chance in fifty of being exceeded in any one year, as provided in Appendix C.
- (2) Maximum glass area values apply to IG units of two identical lites (annealed, heat-strengthened or tempered) spaced at 12.7 mm.

**Table 9.6.1.3.-C**  
**Maximum Glass Area for Windows in Areas for which the 1-in-50 Hourly Wind Pressure (HWP) is less than 1.00 kPa<sup>(1)</sup>**  
 Forming Part of Clause 9.6.1.3.(2)(a)

Type of Glass	Maximum Glass Area, m <sup>2</sup>							
	Glass Thickness, mm							
	2.5	3	4	5	6	8	10	12
Annealed	0.30	0.50	0.77	1.05	1.45	2.40	3.40	5.62
Factory-sealed insulated glass (IG) units <sup>(2)</sup>	0.52	0.86	1.31	1.86	2.57	4.30	6.10	9.89
Heat-strengthened	0.65	1.04	1.63	2.26	2.92	4.07	5.10	7.14
Tempered	1.01	1.42	1.90	2.33	2.92	4.07	5.10	7.14
Wired	0.16	0.26	0.38	0.52	0.71	1.15	1.63	2.69

**Notes to Table 9.6.1.3.-C:**

- (1) The maximum hourly wind pressure with one chance in fifty of being exceeded in any one year, as provided in Appendix C.  
 (2) Maximum glass area values apply to IG units of two identical lites (annealed, heat-strengthened or tempered) spaced at 12.7 mm.

**Table 9.6.1.3.-D**  
**Maximum Glass Area for Windows in Areas for which the 1-in-50 Hourly Wind Pressure (HWP) is less than 0.55 kPa – OPEN TERRAIN<sup>(1)</sup>**  
 Forming Part of Clause 9.6.1.3.(2)(b)

Type of Glass	Maximum Glass Area, m <sup>2</sup>							
	Glass Thickness, mm							
	2.5	3	4	5	6	8	10	12
Annealed	0.46	0.75	1.16	1.60	2.25	3.76	5.32	8.70
Factory-sealed insulated glass (IG) units <sup>(2)</sup>	0.80	1.34	2.11	2.93	4.10	6.90	9.66	12.53
Heat-strengthened	0.98	1.74	2.33	2.86	3.59	5.00	6.26	8.78
Tempered	1.25	1.74	2.33	2.86	3.59	5.00	6.26	8.78
Wired	0.22	0.36	0.55	0.76	1.05	1.75	2.47	4.09

**Notes to Table 9.6.1.3.-D:**

- (1) The maximum hourly wind pressure with one chance in fifty of being exceeded in any one year, as provided in Appendix C.  
 (2) Maximum glass area values apply to IG units of two identical lites (annealed, heat-strengthened or tempered) spaced at 12.7 mm.

**Table 9.6.1.3.-E**  
**Maximum Glass Area for Windows in Areas for which the 1-in-50 Hourly Wind Pressure (HWP) is less than 0.75 kPa – OPEN TERRAIN<sup>(1)</sup>**  
 Forming Part of Clause 9.6.1.3.(2)(b)

Type of Glass	Maximum Glass Area, m <sup>2</sup>							
	Glass Thickness, mm							
	2.5	3	4	5	6	8	10	12
Annealed	0.33	0.54	0.83	1.14	1.61	2.67	3.75	6.14
Factory-sealed insulated glass (IG) units <sup>(2)</sup>	0.57	0.94	1.47	2.04	2.85	4.75	6.72	10.97
Heat-strengthened	0.70	1.15	1.79	2.44	3.06	4.36	5.34	7.47
Tempered	1.06	1.48	1.99	2.44	3.06	4.36	5.34	7.47
Wired	0.16	0.26	0.40	0.55	0.76	1.24	1.77	2.93

**Notes to Table 9.6.1.3.-E:**

- (1) The maximum hourly wind pressure with one chance in fifty of being exceeded in any one year, as provided in Appendix C.  
 (2) Maximum glass area values apply to IG units of two identical lites (annealed, heat-strengthened or tempered) spaced at 12.7 mm.



**Table 9.6.1.3.-F**  
**Maximum Glass Area for Windows in Areas for which the 1-in-50 Hourly Wind Pressure (HWP) is less than 1.00 kPa – OPEN TERRAIN<sup>(1)</sup>**  
 Forming Part of Clause 9.6.1.3.(2)(b)

Type of Glass	Maximum Glass Area, m <sup>2</sup>							
	Glass Thickness, mm							
	2.5	3	4	5	6	8	10	12
Annealed	0.25	0.40	0.62	0.84	1.17	1.94	2.75	4.50
Factory-sealed insulated glass (IG) units <sup>(2)</sup>	0.42	0.68	1.04	1.46	2.05	3.41	4.87	7.92
Heat-strengthened	0.51	0.84	1.30	1.79	2.52	3.69	4.60	6.44
Tempered	0.92	1.28	1.72	2.10	2.63	3.69	4.60	6.44
Wired	0.12	0.20	0.30	0.41	0.57	0.94	1.31	2.18

**Notes to Table 9.6.1.3.-F:**

- (1) The maximum hourly wind pressure with one chance in fifty of being exceeded in any one year, as provided in Appendix C.
- (2) Maximum glass area values apply to IG units of two identical lites (annealed, heat-strengthened or tempered) spaced at 12.7 mm.

**3)** The maximum area of individual panes of glass for doors shall conform to Table 9.6.1.3.-G.

**Table 9.6.1.3.-G**  
**Glass Area for Doors**  
 Forming Part of Sentence 9.6.1.3.(3)

Glass Thickness, mm	Maximum Glass Area, m <sup>2(1)</sup>						
	Type of Glass						
	Annealed	Annealed, Multiple-Glazed, Factory-Sealed Units	Laminated	Wired	Heat-Strengthened	Fully Tempered	Fully Tempered, Multiple-Glazed, Factory-Sealed
3	0.50	0.70	(2)	(2)	1.00	1.00	2.00
4	1.00	1.50	(2)	(2)	1.50	4.00	4.00
5	1.50	1.50	(2)	(2)	1.50	No limit	No limit
6	1.50	1.50	1.20	1.00	1.50	No limit	No limit

**Notes to Table 9.6.1.3.-G:**

- (1) See Note A-Table 9.6.1.3.
- (2) Not generally available.

**9.6.1.4. Types of Glass and Protection of Glass**

**1)** Glass sidelights greater than 500 mm wide that could be mistaken for doors, glass in storm doors and glass in sliding doors within or at every entrance to a *dwelling unit* and in public areas shall be

- a) safety glass of the tempered or laminated type conforming to CAN/CGSB-12.1-M, "Tempered or Laminated Safety Glass," or
- b) wired glass conforming to CAN/CGSB-12.11-M, "Wired Safety Glass."

**2)** Except as provided in Sentence (4), glass in entrance doors to *dwelling units* and in public areas, other than the entrance doors described in Sentence (1), shall be safety glass or wired glass of the type described in Sentence (1) where the glass area exceeds 0.5 m<sup>2</sup> and extends to less than 900 mm from the bottom of the door.

**3)** Except as provided in Sentence (4), transparent panels that could be mistaken as a *means of egress* shall be protected by barriers or railings.

4) Sliding glass *partitions* that separate a *public corridor* from an adjacent *occupancy* and that are open during normal working hours need not conform to Sentences (2), (3) and (5), except that such *partitions* shall be suitably marked to indicate their existence and position.

5) Except as provided in Sentence (4), every glass or transparent door accessible to the public shall be equipped with hardware, bars or other permanent fixtures designed so that the existence and position of such doors is readily apparent.

6) Glass other than safety glass shall not be used for a shower or bathtub enclosure.

## Section 9.7. Windows, Doors and Skylights

### 9.7.1. General

#### 9.7.1.1. Application

1) This Section applies to windows, doors and skylights in *buildings*.

2) For the purpose of this Section, the term “skylight” refers to unit skylights, roof windows and tubular daylighting devices.

3) For the purpose of this Section, the term “doors” includes glazing in doors and sidelights for doors.

### 9.7.2. Required Windows, Doors and Skylights

#### 9.7.2.1. Entrance Doors

1) A door shall be provided at each entrance to a *dwelling unit*.

2) Main entrance doors to *dwelling units* shall be provided with

- a door viewer or transparent glazing in the door, or
- a sidelight.

#### 9.7.2.2. Other Requirements for Windows, Doors and Skylights

1) Minimum sizes of doorways and doors within a *barrier-free* path of travel shall conform to Section 9.5.

2) The protection of window and door openings to protect persons from falling through them shall conform to Article 9.8.8.1.

3) Properties of windows and doors within *exits* shall conform to Section 9.9.

4) Windows and doors installed to provide the required *means of egress* from bedrooms shall conform to Subsection 9.9.10.

5) The location and protection of windows, doors and skylights in order to control the spread of fire shall conform to Subsection 9.10.12.

6) Doors between *dwelling units* and attached garages shall conform to Article 9.10.13.15.

7) The surface *flame-spread rating* for doors and skylights shall conform to Article 9.10.17.1.

8) Windows and doors installed to provide the required access to a *building* for firefighting purposes shall conform to Subsection 9.10.20.

9) Windows and skylights installed to provide required non-heating season ventilation shall conform to Article 9.32.2.2.

10) Windows, doors and skylights shall conform to the energy efficiency requirements in Section 9.36.

**9.7.3. Performance of Windows, Doors and Skylights****9.7.3.1. General Performance Expectations**

**1)** Except as provided in Sentences (2) to (4), windows, doors and skylights and their components separating *conditioned space* from unconditioned space or the exterior shall be designed, constructed and installed so that, when in the closed position, they

- a) resist the ingress of precipitation into interior space (see Note A-9.7.4.2.(1)),
- b) resist wind loads,
- c) control air leakage,
- d) resist the ingress of insects and vermin,
- e) where required, resist forced entry, and
- f) are easily operable when not intended to be fixed.

**2)** Skylights and their components shall be designed, constructed and installed so that they resist snow loads.

**3)** Where windows, doors and skylights and their components separate *suites* from the remainder of the *building*, they shall be designed, constructed and installed so that, when in the closed position, they

- a) control air leakage,
- b) where required, resist forced entry, and
- c) are easily operable when not intended to be fixed.

**4)** Storm doors for sliding doors and their components shall be designed, constructed and installed so that, when in the closed position, they

- a) resist wind loads,
- b) control air leakage to a minimum allowable 5 m<sup>3</sup>h/m and a maximum allowable 8.35 m<sup>3</sup>h/m,
- c) resist the ingress of insects and vermin, and
- d) be easily operable.

**5)** Compliance with the performance requirements described in Sentences (1) to (4) shall be demonstrated by

- a) complying with the requirements in
  - i) Subsection 9.7.4. or 9.7.5., and
  - ii) Subsection 9.7.6., or
- b) design and construction conforming to Part 5.

**9.7.3.2. Heat Transfer Performance**

**1)** Windows, doors and skylights and their components described in Sentence 9.7.1.1.(1) shall be designed, constructed and installed to

- a) minimize surface condensation on the warm side of the component (see Note A-9.7.3.2.(1)(a)), and
- b) ensure comfortable conditions for occupants.

**2)** Compliance with the heat transfer performance requirements described in Sentence (1) shall be demonstrated by

- a) complying with the requirements in Article 9.7.3.3., or
- b) design and construction conforming to Part 5.

**9.7.3.3. Thermal Characteristics of Windows, Doors and Skylights**

**1)** Metal frames and sash of windows, doors and skylights shall incorporate a thermal break.

**2)** Windows and doors described in Sentence (1) do not require a thermal break where they are installed as

- a) vehicular access doors,
- b) storm windows and doors, or
- c) windows and doors that are required to have a *fire-resistance rating*.

**3)** Windows, doors and skylights with or without storm doors or sash that are installed in *buildings* where the intended use of the interior space will not result in

high moisture generation shall have a maximum thermal transmittance (U-value) or minimum temperature index (I) in accordance with Table 9.7.3.3.

**Table 9.7.3.3.**  
**Maximum U-value or Minimum Temperature Index (I) for Windows, Doors and Skylights<sup>(1)(2)</sup>**  
 Forming Part of Sentence 9.7.3.3.(3)

Component	2.5% January Design Temperature					
	Warmer than -15°C		Between -15°C and -30°C		Colder than -30°C	
	max. U-value, W/(m <sup>2</sup> ·K)	min. I	max. U-value, W/(m <sup>2</sup> ·K)	min. I	max. U-value, W/(m <sup>2</sup> ·K)	min. I
Windows and doors	2.5	54	2.0	68	1.7	77
Skylights	3.5	(2)	3.0	(2)	2.7	(2)

**Notes to Table 9.7.3.3.:**

- (1) U-values for specific products can be determined according to measures referenced in AAMA/WDMA/CSA 101/I.S.2/A440, "NAFS – North American Fenestration Standard/Specification for Windows, Doors, and Skylights." Temperature index (I) is determined according to the physical test procedure given in CSA A440.2/A440.3, "Fenestration Energy Performance/User Guide to CSA A440.2-14, Fenestration Energy Performance."
- (2) There is no appropriate test procedure available for testing the condensation resistance of sloped glazing.

**4)** Windows, doors and skylights with or without storm doors or sash that are installed in portions of *buildings* where the intended use of the interior space will result in high moisture generation shall be designed in conformance with Section 5.3. (See Note A-9.25.5.2.)

## 9.7.4. Manufactured Windows, Doors and Skylights

### 9.7.4.1. Application

**1)** This Subsection applies to windows, doors and skylights covered in the scope of AAMA/WDMA/CSA 101/I.S.2/A440, "NAFS – North American Fenestration Standard/Specification for Windows, Doors, and Skylights" (Harmonized Standard).

### 9.7.4.2. General

- 1)** Manufactured and pre-assembled windows, doors and skylights and their installation shall conform to
- AAMA/WDMA/CSA 101/I.S.2/A440, "NAFS – North American Fenestration Standard/Specification for Windows, Doors, and Skylights" (Harmonized Standard),
  - CSA A440S1, "Canadian Supplement to AAMA/WDMA/CSA 101/I.S.2/A440, NAFS – North American Fenestration Standard/Specification for Windows, Doors, and Skylights,"
  - the remainder of this Subsection, and
  - the applicable requirements in Subsection 9.7.6.
- (See Note A-9.7.4.2.(1).)

### 9.7.4.3. Performance Requirements

- 1)** Performance grades for windows, doors and skylights shall be selected according to the Canadian Supplement referenced in Clause 9.7.4.2.(1)(b) so as to be appropriate for the conditions and geographic location in which the window, door or skylight will be installed.
- 2)** Windows, doors and skylights shall conform to the performance grades selected in Sentence (1) when tested in accordance with the Harmonized Standard referenced in Clause 9.7.4.2.(1)(a).
- 3)** The minimum level of performance required for windows, doors and skylights shall be that of the Performance Class R.

- 4)** Exterior wood doors shall conform to CAN/CSA-O132.2 Series, “Wood Flush Doors,” and shall have legibly indicated on them
- the name of the manufacturer,
  - the standard according to which they were produced, and
  - that they are of an exterior type.

## 9.7.5. Site-built Windows, Doors and Skylights

### 9.7.5.1. Application and Compliance

- 1)** Materials, design, construction and installation of windows, doors and skylights that separate *conditioned space* from unconditioned space or the exterior but that are not covered in the scope of AAMA/WDMA/CSA 101/I.S.2/A440, “NAFS – North American Fenestration Standard/Specification for Windows, Doors, and Skylights,” shall conform
- to
    - the remainder of this Subsection or Subsection 9.7.4., and
    - the applicable requirements in Subsection 9.7.6., or
  - to Part 5.
- 2)** Glass for site-built windows, doors, sidelights for doors, and skylights shall comply with Section 9.6.

### 9.7.5.2. Resistance to Forced Entry for Doors

- 1)** Except for exterior doors to garages and to other ancillary spaces, this Article applies to
- swinging entrance doors to *dwelling units*,
  - swinging doors between *dwelling units* and attached garages or other ancillary spaces, and
  - swinging doors that provide access directly or indirectly from a *storage garage* to a *dwelling unit*.
- (See Note A-9.7.5.2.(1).)

**2)** Doors, frames and hardware that conform to a security level of at least Grade 10 as described in the Annex to ASTM F 476, “Security of Swinging Door Assemblies,” are not required to conform to Sentences (3) to (7). (See Note A-9.7.5.2.(2).)

- 3)** Except as permitted in Sentence (2), wood doors as described in Sentence (1) shall
- be solid core or stile-and-rail type,
  - be not less than 45 mm thick, and
  - if of the stile-and-rail type, have a panel thickness of not less than 19 mm, with a total panel area not more than half of the door area.

- 4)** Except as permitted in Sentence (2), doors described in Sentence (1) shall be provided with
- a deadbolt lock with a cylinder having no fewer than 5 pins, and
  - a bolt throw not less than 25 mm long, protected with a solid or hardened free-turning ring or beveled cylinder housing.
- (See Article 9.9.6.7.)

**5)** Except as permitted in Sentence (2), an inactive leaf in double doors used in locations specified in Sentence (1) shall be provided with heavy-duty bolts top and bottom having an engagement of not less than 15 mm.

- 6)** Except as permitted in Sentence (2), hinges for doors described in Sentence (1) shall be fastened
- to wood doors with wood screws not less than 25 mm long and to wood frames with wood screws so that at least 2 screws per hinge penetrate not less than 30 mm into solid wood, or
  - to metal doors and metal frames with machine screws not smaller than No. 10 and not less than 10 mm long.
- (See Note A-9.7.5.2.(6).)

- 7) Strikeplates for deadbolts described in Sentence (4) shall be fastened
  - a) to wood frames with wood screws that penetrate not less than 30 mm into solid wood, or
  - b) to metal frames with machine screws not smaller than No. 8 and not less than 10 mm long.

(See Note A-9.7.5.2.(6))

8) Except for storm or screen doors, doors described in Sentence (1) that swing outward shall be provided with hinges or pins so that the doors cannot be removed when they are in the closed position. (See Note A-9.7.5.2.(8).)

9) Solid blocking shall be provided on both sides at the lock height between the jambs for doors described in Sentence (1) and the structural framing so that the jambs will resist spreading by force.

### 9.7.5.3. Resistance to Forced Entry for Windows

1) In *dwelling units*, windows, any part of which is located within 2 m of adjacent ground level, shall conform to the requirements for resistance to forced entry as described in Clause 5.3.5 of AAMA/WDMA/CSA 101/I.S.2/A440, "NAFS – North American Fenestration Standard/Specification for Windows, Doors, and Skylights." (See Note A-9.7.5.3.(1).)

## 9.7.6. Installation

### 9.7.6.1. Installation of Windows, Doors and Skylights

1) The installation of windows, doors and skylights shall conform to CAN/CSA-A440.4, "Window, Door, and Skylight Installation," except that
 

- a) shims used to support windows, doors and skylights are permitted to be made of treated plywood, and
- b) protection from precipitation for walls incorporating windows or doors and for roofs incorporating skylights, and the interfaces of these walls with windows or doors and of roofs with skylights, shall conform Section 9.27.

2) The installation of manufactured and pre-assembled windows, doors and skylights and the field assembly of manufactured window and door combination units shall conform to the manufacturer's instructions.

3) Windows, doors and skylights shall be sealed to air barriers and vapour barriers.

### 9.7.6.2. Sealants, Trim and Flashing

1) The sealing compound used to seal the glass component of an insulating glazing unit to the sash component shall be compatible with the sealing compound used to edge seal the glass component.

2) Flashing used to protect openings shall conform to Articles 9.27.3.7. and 9.27.3.8.

3) Sealants shall be applied between window frames or trim and the exterior cladding or masonry in conformance with Subsection 9.27.4.

4) All unfinished portions of the frame and other components of aluminum windows, doors or skylights in contact with the edges of masonry, concrete, stucco or plaster shall be protected with an alkali-resistant coating.

## Section 9.8. Stairs, Ramps, Handrails and Guards

### 9.8.1. Application

#### 9.8.1.1. General

1) This Section applies to the design and construction of interior and exterior stairs, steps, ramps, handrails and *guards*.

**9.8.1.2. Stairs, Ramps, Landings, Handrails and Guards in Garages**

1) Where stairs, ramps, landings, handrails or *guards* are installed in garages that serve a single *dwelling unit* or a house with a *secondary suite* including their common spaces, the garage shall be considered to be part of the *dwelling unit* and the requirements for stairs, ramps, landings, handrails and *guards* within *dwelling units* shall apply.

**9.8.1.3. Exit Stairs, Ramps and Landings**

1) Where a stair, ramp or landing forms part of an *exit*, the appropriate requirements in Sections 9.9. and 9.10. shall also apply.

**9.8.1.4. Escalators and Moving Walkways**

1) Escalators and moving *walkways* shall conform to the appropriate requirements in Part 3.

**9.8.2. Stair Dimensions****9.8.2.1. Stair Width**

1) Except as provided in Sentence (2) and Article 9.8.4.7., required *exit* stairs and public stairs serving *buildings* of *residential occupancy* shall have a width of not less than 900 mm.

2) *Exit* stairs serving a single *dwelling unit* or a house with a *secondary suite* including their common spaces shall have a width of not less than 860 mm.

3) Except as provided in Article 9.8.4.7., required *exit* stairs and public stairs serving *buildings* of other than *residential occupancy* shall have a width of not less than the greater of

- a) 900 mm, or
- b) 8 mm per person based on the *occupant load* limits specified in Table 3.1.17.1.

4) Except as provided in Article 9.8.4.7., at least one stair between each floor level within a *dwelling unit*, and exterior stairs serving a single *dwelling unit* except required *exit* stairs, shall have a width of not less than 860 mm.

**9.8.2.2. Height over Stairs**

1) The clear height over stairs shall be measured vertically, over the clear width of the stair, from a straight line tangent to the tread and landing nosings to the lowest point above. (See Note A-3.4.3.4.)

2) Except as provided in Sentences (3) and (4) and Article 9.8.4.7., the clear height over stairs shall not be less than 2 050 mm.

3) Except as provided in Article 9.8.4.7., the clear height over stairs serving a single *dwelling unit* or a house with a *secondary suite* including their common spaces shall not be less than 1 950 mm.

4) The clear height over stairs that are located under beams and ducting in *secondary suites* shall not be less than 1 850 mm.

**9.8.3. Stair Configurations****9.8.3.1. Permitted Configurations**

(See Notes A-9.8.3.1. and A-9.8.4.)

1) Stairs in *buildings* other than *dwelling units* and houses with a *secondary suite*, including their common spaces, shall consist of

- a) straight *flights*,
- b) except as provided in Sentence (4), curved *flights*, or
- c) except as provided in Sentence 9.8.4.7.(2), spiral stairs.

- 2) Stairs within *dwelling units* and houses with a *secondary suite*, including their common spaces, shall consist of
  - a) straight *flights*,
  - b) except as provided in Sentence (4), curved *flights*,
  - c) except as provided in Sentence 9.8.4.7.(2), spiral stairs,
  - d) except as provided in Sentence (3), *flights* with rectangular treads and winders, or
  - e) *flights* with a mix of rectangular and *tapered treads*.
- 3) Only one set of winders described in Article 9.8.4.6. shall be permitted between floor levels.
- 4) Curved *flights* in *exits* shall comply with Sentence 3.4.6.9.(2).
- 5) All *tapered treads* within a *flight* shall turn in the same direction.

**9.8.3.2. Minimum Number of Risers**

- 1) Except for stairs within a *dwelling unit*, at least 3 risers shall be provided in interior *flights*.

**9.8.3.3. Maximum Height of Stairs**

- 1) The vertical height of any *flight* of stairs shall not exceed 3.7 m.

**9.8.4. Step Dimensions**

(See Note A-9.8.4.)

**9.8.4.1. Dimensions for Risers**

(See Note A-9.8.4.)

- 1) Except as provided in Article 9.8.4.7. and except for stairs serving areas only used as *service rooms* or *service spaces*, the rise, which is measured as the vertical nosing-to-nosing distance, shall comply with Table 9.8.4.1.

**Table 9.8.4.1.**  
**Rise for Rectangular Treads, Tapered Treads and Winders**  
 Forming Part of Sentence 9.8.4.1.(1)

Stair Type	Rectangular Treads, <i>Tapered Treads</i> and Winders	
	Rise, mm	
	Max.	Min.
Private <sup>(1)</sup>	200	125
Public <sup>(2)</sup>	180	125

**Notes to Table 9.8.4.1.:**

- (1) Private stairs are exterior and interior stairs that serve
  - (a) single *dwelling units*,
  - (b) houses with a *secondary suite* including their common spaces, or
  - (c) garages that serve a) or b).
- (2) Public stairs are all stairs not described as service stairs or private stairs.

**9.8.4.2. Dimensions for Rectangular Treads**

(See Note A-9.8.4.)

- 1) Except for stairs serving areas only used as *service rooms* or *service spaces*, the *run* shall comply with Table 9.8.4.2.



**Table 9.8.4.2.**  
**Run for Rectangular Treads**  
 Forming Part of Sentence 9.8.4.2.(1)

Stair Type	Rectangular Treads	
	Run, mm	
	Max.	Min.
Private <sup>(1)</sup>	355	255
Public <sup>(2)</sup>	No limit	280

**Notes to Table 9.8.4.2.:**

- (1) Private stairs are exterior and interior stairs that serve
  - (a) single *dwelling units*,
  - (b) houses with a *secondary suite* including their common spaces, or
  - (c) garages that serve a) or b).
- (2) Public stairs are all stairs not described as service stairs or private stairs.

**2)** The depth of a rectangular tread shall be not less than its *run* and not more than its *run* plus 25 mm.

**9.8.4.3. Dimensions of Tapered Treads**

(See Note A-9.8.4.)

**1)** Except as provided in Sentence (2) and Articles 9.8.4.6. and 9.8.4.7., *tapered treads* shall have a *run* that

- a) is not less than 150 mm at the narrow end of the tread, and
- b) complies with the dimensions stated in Table 9.8.4.2. when measured at a point 300 mm from the centre line of the handrail at the narrow end of the tread.

**2)** *Tapered treads* in required *exit* stairs shall conform to the requirements in Article 3.4.6.9.

**3)** The depth of a *tapered tread* shall be not less than its *run* at any point and not more than its *run* at any point plus 25 mm.

**9.8.4.4. Uniformity and Tolerances for Risers, Runs and Treads**

**1)** Except as provided in Sentence (2), risers shall be of uniform height in any one *flight*, with a maximum tolerance of

- a) 5 mm between adjacent treads or landings, and
- b) 10 mm between the tallest and shortest risers in a *flight*.

**2)** Except for required *exit* stairs, where the top or bottom riser in a stair adjoins a sloping finished walking surface, such as a garage floor, driveway or sidewalk, the height of the riser across the stair shall vary by not more than 1 in 12.

**3)** Rectangular treads shall have a uniform *run* with a maximum tolerance of

- a) 5 mm between adjacent treads, and
- b) 10 mm between the deepest and shallowest treads in a *flight*.

**4)** *Tapered treads* in a *flight* shall have a uniform *run* in accordance with the construction tolerances stipulated in Sentence (3) when measured at a point 300 mm from the centre line of the handrail as described in Sentence 9.8.7.1.(5).

**5)** The slope of treads shall not exceed 1 in 50.

**9.8.4.5. Uniformity of Runs in Flights with Mixed Treads within Dwelling Units**

**1)** Except as provided in Sentence (2) and Article 9.8.4.6., where a *flight* of stairs consists of both *tapered treads* and rectangular treads, all the treads shall have a uniform *run* when measured at a point 300 mm from the centre line of the inside handrail.

**2)** Where *tapered treads* are located at the bottom of a mixed-tread *flight*, the *run* of the *tapered treads* when measured at a point 300 mm from the centre line of the inside handrail is permitted to exceed the *run* of the rectangular treads.

#### 9.8.4.6. Winders

(See Note A-9.8.4.6.)

**1)** Individual treads in winders that converge on a centre point shall turn through an angle of

- a) 30° with no deviation above or below 30°, or
- b) 45° with no deviation above or below 45°.

**2)** Where winders are incorporated into a stair, each set shall not turn through more than 90°.

#### 9.8.4.7. Spiral Stairs

(See Note A-9.8.4.7.)

**1)** Spiral stairs shall have

- a) handrails on both sides, the outer handrail being not less than 1 070 mm high,
- b) a clear width not less than 660 mm between the handrails,
- c) risers that are not more than 240 mm high,
- d) treads that
  - i) are a minimum of 190 mm deep at a point 300 mm from the centre line of the handrails at the narrower edge,
  - ii) have a consistent angle and uniform dimension, and
  - iii) turn in the same direction, and
- e) not less than 1 980 mm clear height.

**2)** Spiral stairs conforming to Sentence (1) are permitted to be used as the only *means of egress* where they serve not more than 3 persons.

**3)** Spiral stairs shall not serve as an *exit*.

#### 9.8.4.8. Tread Nosings

(See Notes A-9.8.4.8. and A-9.8.4.)

**1)** Except as permitted by Sentence (2), the top of the nosings of stair treads shall have a rounded or beveled edge extending not less than 6 mm and not more than 14 mm measured horizontally from the front of the nosing.

**2)** If resilient material is used to cover the nosing of a stair tread, the minimum extension of the rounded or beveled edge required by Sentence (1) is permitted to be reduced to 3 mm.

### 9.8.5. Ramps

#### 9.8.5.1. Application

**1)** This Subsection applies to pedestrian ramps, except ramps in a *barrier-free* path of travel.

**2)** Ramps in a *barrier-free* path of travel shall conform to the requirements in Article 3.8.3.5.

#### 9.8.5.2. Ramp Width

(See also Article 9.9.3.2.)

**1)** Except as provided in Sentence (2), ramps shall be not less than 1 100 mm wide.

**2)** Ramps serving a single *dwelling unit* or a house with a *secondary suite* including their common spaces shall be not less than 860 mm wide.

**9.8.5.3. Height over Ramps**

**1)** Except as permitted by Sentence (2), the clear height over ramps shall be not less than 2 050 mm.

**2)** The clear height over ramps serving a single *dwelling unit* or a house with a *secondary suite* including their common spaces shall be not less than 1 950 mm.

**9.8.5.4. Ramp Slope**

- 1)** The slope of ramps shall be not more than
  - a) 1 in 10 for exterior ramps,
  - b) 1 in 10 for interior ramps serving *residential occupancies*,
  - c) 1 in 6 for *industrial occupancies*, and
  - d) 1 in 8 for all other *occupancies*.

**9.8.5.5. Maximum Rise**

**1)** Where the slope of the ramp is greater than 1 in 12, the maximum rise between floors or landings shall be 1 500 mm.

**9.8.6. Landings**

**9.8.6.1. Application**

**1)** This Subsection applies to landings, except landings for ramps in a *barrier-free* path of travel.

**2)** Landings for ramps in a *barrier-free* path of travel shall conform to the requirements in Article 3.8.3.5.

**3)** Finished floors, and ground surfaces with a slope not exceeding 1 in 50, at the top and bottom of stairs or ramps shall be considered as landings.

**9.8.6.2. Required Landings**

**1)** Except as provided in Sentences (2) to (4) and Sentence 9.9.6.6.(2), a landing shall be provided

- a) at the top and bottom of each *flight* of interior and exterior stairs, including stairs in garages,
- b) at the top and bottom of every ramp with a slope greater than 1 in 50,
- c) where a doorway opens onto a stair or ramp,
- d) where a ramp opens onto a stair, and
- e) where a stair opens onto a ramp.

**2)** Where a door at the top of a stair within a *dwelling unit* swings away from the stair, no landing is required between the doorway and the stair.

**3)** A landing may be omitted at the top of an exterior *flight* serving a secondary entrance to a single *dwelling unit* or a house with a *secondary suite*, provided

- a) the stair does not contain more than 3 risers,
- b) the principal door is a sliding door or swings away from the stair, and
- c) only a storm or screen door, if any, swings over the stair and is equipped with hardware to hold it open.

**4)** A landing may be omitted at the bottom of an exterior stair or ramp provided there is no obstruction, such as a gate or door, within the lesser of the width of the stair or ramp or

- a) 900 mm for stairs or ramps serving a single *dwelling unit*, and
- b) 1 100 mm for stairs or ramps not serving a single *dwelling unit*.

**9.8.6.3. Dimensions of Landings**

(See Note A-3.4.6.4.) (See also Articles 9.9.6.1. and 9.9.6.6. regarding landings in *exits*.)

**1)** Except as provided in Sentences (2) to (7), landings shall be at least as wide and as long as the width of the stair or ramp in which they occur.

- 2) Where the landing in a stairway or ramp does not turn or turns less than 90°, the length of the landing need not be more than the lesser of
  - a) the required width of the stair or ramp, or
  - b) 1 100 mm.
- 3) The length of a landing shall be measured perpendicular to the nosings of adjacent steps or to the end of the ramp, at a distance equal to half the length required in Sentence (2) from the narrow edge of the landing.
- 4) Where stair *flights* or ramps of different widths adjoin a single landing, the minimum width of the landing shall be
  - a) where one or more of the stair or ramp widths do not exceed their respective required widths, not less than the greater required stair or ramp width, or
  - b) where all of the widths of the stairs or ramps exceed their respective required widths, not less than the lesser actual stair or ramp width.
- 5) Where a door swings toward a stair, the full arc of the swing shall be over the landing.
- 6) The slope of landings shall not exceed 1 in 50.
- 7) Where a doorway or stairway opens onto the side of a ramp, the landing shall extend for a distance of not less than 300 mm on either side of the doorway or stairway, except on a side abutting an end wall.

**9.8.6.4. Height over Landings**

- 1) Except as permitted by Sentence (2), the clear height over landings shall be not less than 2 050 mm.
- 2) The clear height over landings serving a single *dwelling unit* or a house with a *secondary suite* including their common spaces shall be not less than 1 950 mm.

**9.8.7. Handrails**

**9.8.7.1. Required Handrails**

- 1) Except as provided in Sentences (2) to (4), handrails shall be installed on stairs and ramps in accordance with Table 9.8.7.1.

**Table 9.8.7.1.**  
**Number of Sides of Stair or Ramp Required to Have a Handrail**  
 Forming Part of Sentence 9.8.7.1.(1)

Location of Stair or Ramp	Handrails Serving Stairs			Handrails Serving Ramps	
	Stairs < 1 100 mm Wide		Stairs ≥ 1 100 mm Wide	Ramps < 1 100 mm Wide	Ramps ≥ 1 100 mm Wide
	Straight	Curved	All	Straight or Curved	All
Number of Sides Required to Have a Handrail					
Within a <i>dwelling unit</i> or a house with a <i>secondary suite</i>	1	1	1	1	2
All other locations <sup>(1)</sup>	1	2	2	2	2

**Notes to Table 9.8.7.1.:**

<sup>(1)</sup> See Sentences 9.8.7.1.(2), (3) and (4) for exceptions.

- 2) Except where a stair or ramp serves not more than two *dwelling units*, at least one handrail shall be located not more than 750 mm from the natural path of travel on the stair or ramp. (See Note A-9.8.7.1.(2).)

**3)** Handrails are not required for stairs and ramps serving a single *dwelling unit*, where

- a) interior stairs have not more than 2 risers,
- b) exterior stairs have not more than 3 risers, or
- c) ramps rise not more than 400 mm.

**4)** Only one handrail is required on exterior stairs having more than 3 risers provided such stairs serve not more than one *dwelling unit* or a house with a *secondary suite*.

**5)** Except for stairs with winders, where a *flight* of stairs within a *dwelling unit* consists of *tapered treads*, or a mix of *tapered treads* and rectangular treads, one handrail shall be installed along the narrow end of the treads.

#### 9.8.7.2. Continuity of Handrails

(See Note A-9.8.7.2.)

**1)** Except as provided in Sentence (3), required handrails shall be continuously graspable throughout the length of

- a) ramps, and
- b) *flights* of stairs, from the bottom riser to the top riser.

**2)** Except for stairs or ramps serving a single *dwelling unit* or a house with a *secondary suite* including their common spaces, at least one required handrail shall be continuous throughout the length of the stair or ramp, including at the landing except where interrupted by doorways. (See Note A-3.4.6.5.(10).)

**3)** For stairs or ramps serving a single *dwelling unit* or a house with a *secondary suite* including their common spaces, a handrail is permitted to start from a newel post or volute installed on the bottom tread.

#### 9.8.7.3. Termination of Handrails

**1)** Handrails shall be terminated in a manner that will not obstruct pedestrian travel or create a hazard. (See Note A-9.8.7.3.(1).)

**2)** Except for stairs and ramps serving only one *dwelling unit* or a house with a *secondary suite* including their common spaces, at least one handrail at the sides of a stair or ramp shall extend horizontally not less than 300 mm beyond the top and bottom of each *flight* or ramp. (See Note A-9.8.7.3.(2).)

#### 9.8.7.4. Height of Handrails

(See Note A-9.8.7.4.)

**1)** The height of handrails on stairs and ramps shall be measured vertically from the top of the handrail to

- a) a straight line drawn tangent to the tread nosings of the stair served by the handrail, or
- b) the surface of the ramp, floor or landing served by the handrail.

**2)** Except as provided in Sentence (3) and Clause 3.8.3.5.(1)(e), required handrails shall be 865 mm to 1 070 mm high.

**3)** Handrails installed in addition to required handrails need not comply with Sentence (2).

#### 9.8.7.5. Ergonomic Design

**1)** The clearance between a handrail and the surface behind it shall be not less than

- a) 50 mm, or
- b) where said surface is rough or abrasive, 60 mm.

**2)** All handrails shall be constructed so as to be continually graspable along their entire length with no obstruction on or above them to break a handhold. (See Note A-9.8.7.5.(2).)

**9.8.7.6. Projections into Stairs and Ramps**

**1)** Handrails and constructions below handrails, including handrail supports and stair stringers, shall not project more than 100 mm into the required width of a stair or ramp. (See also Articles 9.8.2.1. and 9.8.5.2.)

**9.8.7.7. Design and Attachment of Handrails**

(See Note A-9.8.7.7.)

**1)** Handrails and their supports shall be designed and constructed to withstand the following loads, which need not be considered to act simultaneously:

- a) a concentrated load of not less than 0.9 kN applied at any point and in any direction for all handrails, and
- b) for handrails other than those serving a single *dwelling unit*, a uniform load of not less than 0.7 kN/m.

**2)** Where exterior or interior handrails serving a single *dwelling unit* or a house with a *secondary suite* including their common spaces are attached to wood studs or blocking, the attachment shall be deemed to comply with Sentence (1), where

- a) the attachment points are spaced not more than 1.2 m apart measured on the horizontal plane,
- b) the first attachment point at either end is located no more than 300 mm from the end of the handrail, and
- c) the fasteners consist of not less than 2 No. 8 wood screws at each point, penetrating not less than 32 mm into solid wood.

**9.8.8. Guards****9.8.8.1. Required Guards**

(See Note A-9.8.8.1.)

**1)** Except as provided in Sentence (2), every surface to which access is provided, including but not limited to *flights* of steps and ramps, exterior landings, porches, balconies, *mezzanines*, galleries and raised *walkways*, shall be protected by a *guard* on each side that is not protected by a wall for the length where

- a) there is a difference in elevation of more than 600 mm between the walking surface and the adjacent surface, or
- b) the adjacent surface within 1.2 m of the walking surface has a slope of more than 1 in 2.

**2)** *Guards* are not required

- a) at loading docks,
- b) at floor pits in *repair garages*, or
- c) where access is provided for maintenance purposes only.

**3)** Doors in *buildings of residential occupancy*, where the finished floor on one side of the door is more than 600 mm above the floor or other constructed surface or ground level on the other side of the door, shall be protected by

- a) a *guard*, or
- b) a mechanism capable of controlling the free swinging or sliding of the door so as to limit any clear unobstructed opening to not more than 100 mm.

**4)** Except as provided in Sentence (5), openable windows in *buildings of residential occupancy* shall be protected by

- a) a *guard*, or
- b) a mechanism capable of controlling the free swinging or sliding of the openable part of the window so as to limit any clear unobstructed opening to not more than 100 mm measured either vertically or horizontally where the other dimension is greater than 380 mm.

(See Note A-9.8.8.1.(4).)

**5)** Windows need not be protected in accordance with Sentence (4), where

- a) the window serves a *dwelling unit* that is not located above another *suite*,
- b) the window serves a house with a *secondary suite*,

- c) the only opening greater than 100 mm by 380 mm is a horizontal opening at the top of the window,
- d) the window sill is located more than 450 mm above the finished floor on one side of the window, or
- e) the window is located in a room or space with the finished floor described in Clause (d) located less than 1 800 mm above the floor or ground on the other side of the window.

(See Note A-9.8.8.1.(4).)

**6)** Except as provided in Sentence (7), glazing installed over *stairs*, ramps and landings that extends to less than 1 070 mm above the surface of the treads, ramp or landing shall be

- a) protected by *guards*, in accordance with this Subsection, or
- b) non-openable and designed to withstand the specified lateral loads for balcony *guards* as provided in Article 4.1.5.14.

**7)** In *dwelling units*, glazing installed over *stairs*, ramps and landings that extends to less than 900 mm above the surface of the treads, ramp or landing shall be

- a) protected by *guards*, in accordance with this Subsection, or
- b) non-openable and designed to withstand the specified lateral loads for balcony *guards* as provided in Article 4.1.5.14.

**8)** Glazing installed in public areas that extends to less than 1 m from the floor and is located above the second *storey* in *buildings of residential occupancy* shall be

- a) protected by *guards* in accordance with this Subsection, or
- b) non-openable and designed to withstand the specified lateral loads for balcony *guards* as provided in Article 4.1.5.14.

**9.8.8.2. Loads on Guards**

(See Note A-9.8.8.2.)

**1)** Except as provided in Sentences (2) and (4), *guards* shall be designed to resist the specified loads prescribed in Table 9.8.8.2.

**Table 9.8.8.2.**  
**Specified Loads for Guards**  
Forming Part of Sentence 9.8.8.2.(1)

Location of <i>Guard</i>	Minimum Specified Loads		
	Horizontal Load Applied Inward or Outward at any Point at the Minimum Required Height of the <i>Guard</i>	Horizontal Load Applied Outward on Elements Within the <i>Guard</i> , Including Solid Panels and Balusters	Evenly Distributed Vertical Load Applied at the Top of the <i>Guard</i>
<i>Guards</i> within <i>dwelling units</i> and exterior <i>guards</i> serving not more than 2 <i>dwelling units</i>	0.5 kN/m OR concentrated load of 1.0 kN applied at any point <sup>(1)</sup>	0.5 kN applied over a maximum width of 300 mm and a height of 300 mm <sup>(2)</sup>	1.5 kN/m
<i>Guards</i> serving access ways to equipment platforms and similar areas where the gathering of many people is improbable	Concentrated load of 1.0 kN applied at any point	Concentrated load of 0.5 kN applied over an area of 100 mm by 100 mm located at any point on the element or elements so as to produce the most critical effect	1.5 kN/m
All other <i>guards</i>	0.75 kN/m OR concentrated load of 1.0 kN applied at any point <sup>(1)</sup>	Concentrated load of 0.5 kN applied over an area of 100 mm by 100 mm located at any point on the element or elements so as to produce the most critical effect	1.5 kN/m

**Notes to Table 9.8.8.2.:**

<sup>(1)</sup> The load that creates the most critical condition shall apply.

<sup>(2)</sup> See Sentence (2).

**2)** For *guards* within *dwelling units* and within houses with a *secondary suite* including their common spaces and for exterior *guards* serving not more than 2 *dwelling units*, where the width and spacing of balusters are such that 3 balusters can be engaged by a load imposed over a 300 mm width, the load shall be imposed so as to engage 3 balusters.

**3)** None of the loads specified in Table 9.8.8.2. need be considered to act simultaneously.

**4)** For *guards* within *dwelling units* and within houses with a *secondary suite* including their common spaces and for exterior *guards* serving not more than 2 *dwelling units*, Table 9.8.8.2. need not apply where the *guard* construction used has been demonstrated to provide effective performance.

### 9.8.8.3. Height of Guards

(See Note A-9.8.8.3.)

**1)** Except as provided in Sentences (2) to (4), all *guards* shall be not less than 1 070 mm high.

**2)** All *guards* within *dwelling units* or within houses with a *secondary suite* including their common spaces shall be not less than 900 mm high.

**3)** Exterior *guards* serving not more than one *dwelling unit* or a house with a *secondary suite* including their common spaces shall be not less than 900 mm high where the walking surface served by the *guard* is not more than 1 800 mm above the finished ground level.

**4)** *Guards* for *flights* of steps, except in required *exit* stairs, shall be not less than 900 mm high.

**5)** The height of *guards* for *flights* of steps shall be measured vertically from the top of the *guard* to a line drawn through the tread nosing served by the *guard*.

### 9.8.8.4. Guards for Floors and Ramps in Garages

**1)** Except for floors of garages referred to in Section 9.35., where garage floors or ramps are 600 mm or more above the adjacent ground or floor level, every opening through a garage floor and the perimeter of floors and ramps that have no exterior walls shall be provided with

- a) a continuous curb not less than 140 mm in height, and
- b) a *guard* not less than 1 070 mm above the floor level.

**2)** Vehicle guardrails shall be designed and constructed to withstand the loading values stipulated in Sentence 4.1.5.15.(1). (See Note A-4.1.5.14. and 4.1.5.15.(1).)

### 9.8.8.5. Openings in Guards

**1)** Except as permitted in Sentences (2) and (3), openings through *guards* shall be of a size that prevents the passage of a spherical object having a diameter of 100 mm. (See Note A-9.8.8.5.(1) and (2).)

**2)** Except where they serve *storage garages*, *guards* in *industrial occupancies* are permitted to consist of

- a) a top railing, and
- b) one or more horizontal intermediate rails spaced such that the size of the openings through the *guard* prevents the passage of a spherical object having a diameter of 535 mm.

(See Note A-9.8.8.5.(1) and (2).)

**3)** Openings through any *guard* that is not required by Article 9.8.8.1. and that serves an *occupancy* other than an *industrial occupancy* shall be of a size that

- a) prevents the passage of a spherical object having a diameter of 100 mm, or
- b) permits the passage of a spherical object having a diameter of 200 mm.

(See Note A-9.8.8.5.(3).)



**9.8.8.6. Design of Guards to Not Facilitate Climbing**

1) Except for *guards* in *industrial occupancies*, *guards* required by Article 9.8.8.1. that protect a level located more than 4.2 m above the adjacent level shall be designed so that no member, attachment or opening located between 140 mm and 900 mm above the level protected by the *guard* facilitates climbing. (See Note A-9.8.8.6.(1).)

**9.8.8.7. Glass in Guards**

- 1) Glass in *guards* shall be
  - a) safety glass of the laminated or tempered type conforming to CAN/CGSB-12.1-M, "Tempered or Laminated Safety Glass," or
  - b) wired glass conforming to CAN/CGSB-12.11-M, "Wired Safety Glass."

**9.8.9. Construction****9.8.9.1. Loads on Stairs and Ramps**

- 1) Except as specified in Articles 9.8.9.4. and 9.8.9.5., stairs and ramps shall be designed for strength and rigidity under uniform loading criteria to support specified loads of
  - a) 1.9 kPa for stairs and ramps serving not more than one *dwelling unit* or a house with a *secondary suite* including their common spaces, and
  - b) 4.8 kPa for other stairs and ramps.

**9.8.9.2. Exterior Concrete Stairs**

- 1) Exterior concrete stairs with more than 2 risers and 2 treads shall be
  - a) supported on unit masonry or concrete walls or piers not less than 150 mm in cross section, or
  - b) cantilevered from the main *foundation* wall.
- 2) Stairs described in Sentence (1), when cantilevered from the *foundation* wall, shall be constructed and installed in conformance with Subsection 9.8.10.
- 3) The depth below ground level for *foundations* for exterior steps shall conform to the requirements in Section 9.12.

**9.8.9.3. Exterior Wood Steps**

- 1) Exterior wood steps shall not be in direct contact with the ground unless suitably treated with a wood preservative.

**9.8.9.4. Wooden Stair Stringers**

- 1) Wooden stair stringers shall
  - a) have a minimum effective depth of 90 mm, measured perpendicularly to the bottom of the stringer at the point of minimum cross-section, and an overall depth of not less than 235 mm,
  - b) be supported and secured top and bottom,
  - c) be not less than 25 mm actual thickness if supported along their length and 38 mm actual thickness if unsupported along their length, and
  - d) except as permitted in Sentence (2), be spaced not more than 900 mm o.c. in stairs serving not more than one *dwelling unit* or a house with a *secondary suite* including their common spaces, and 600 mm o.c. in other stairs.
- 2) For stairs serving not more than one *dwelling unit* or a house with a *secondary suite* including their common spaces, where risers support the front portion of the tread, the space between stringers shall be not more than 1 200 mm.

**9.8.9.5. Treads**

- 1) Stair treads of lumber, plywood or O-2 grade OSB within *dwelling units* shall be not less than 25 mm actual thickness, except that if open risers are used and the distance between stringers exceeds 750 mm, the treads shall be not less than 38 mm actual thickness.

2) Stair treads of plywood or OSB that are not continuously supported by the riser shall have their face grain or direction of face orientation at right angles to the stringers.

#### 9.8.9.6. Finish for Treads and Landings

1) The finish for treads and landings of interior stairs in *dwelling units*, other than stairs to unfinished *basements*, shall consist of hardwood, vertical grain softwood, resilient flooring or other material providing equivalent performance.

2) Treads and landings of interior and exterior stairs and ramps, other than those within *dwelling units* or within houses with a *secondary suite* including their common spaces, shall have a slip-resistant finish or be provided with slip-resistant strips that extend not more than 1 mm above the surface.

### 9.8.10. Cantilevered Precast Concrete Steps

#### 9.8.10.1. Design

1) Exterior concrete steps and their anchorage system that are cantilevered from a *foundation* wall shall be designed and installed to support the loads to which they may be subjected.

#### 9.8.10.2. Anchorage

1) Cantilevered concrete steps referred to in Article 9.8.10.1. shall be anchored to concrete *foundation* walls not less than 200 mm thick.

#### 9.8.10.3. Prevention of Damage Due to Frost

1) Suitable precautions shall be taken during backfilling and grading operations to ensure that subsequent freezing of the *soil* will not cause uplift forces on the underside of cantilevered concrete steps to the extent that the steps or the walls to which they are attached will be damaged.

## Section 9.9. Means of Egress

### 9.9.1. General

#### 9.9.1.1. Application

1) Stairways, handrails and *guards* in a *means of egress* shall conform to the requirements in Section 9.8. as well as to the requirements in this Section.

#### 9.9.1.2. Fire Protection

1) In addition to the fire protection requirements provided in Subsection 9.9.4., *flame-spread ratings*, *fire-resistance ratings* and *fire-protection ratings* for *means of egress* shall conform to Section 9.10.

#### 9.9.1.3. Occupant Load

1) Except for *dwelling units*, the *occupant load* of a *floor area* or part of a *floor area* shall be the number of persons for which such areas are designed, but not fewer than that determined from Table 3.1.17.1., unless it can be shown that the area will be occupied by fewer persons.

2) The *occupant load* for *dwelling units* shall be based on 2 persons per bedroom or sleeping area.

**9.9.2. Types and Purpose of Exits****9.9.2.1. Types of Exits**

1) Except as otherwise provided in this Section, an *exit* from any *floor area* shall be one of the following used singly or in combination:

- a) an exterior doorway,
- b) an exterior passageway,
- c) an exterior ramp,
- d) an exterior stairway,
- e) a fire escape,
- f) a *horizontal exit*,
- g) an interior passageway,
- h) an interior ramp, or
- i) an interior stairway.

2) Fire escapes shall only be used as *exits* on existing *buildings* and shall be designed and installed in conformance with Subsection 3.4.7.

3) Where a *horizontal exit* is used, it shall conform to Sentence 3.4.1.6.(1) and Article 3.4.6.10.

**9.9.2.2. Purpose of Exits**

1) An *exit* shall be designed for no purpose other than for exiting except that an *exit* may also serve as an access to a *floor area*.

**9.9.2.3. Elevators, Slide Escapes and Windows as Means of Egress**

1) Elevators, slide escapes and windows shall not be considered as part of a required *means of egress*.

**9.9.2.4. Principal Entrances**

1) Except for doors serving a single *dwelling unit* or a house with a *secondary suite* including their common spaces, at least one door at every principal entrance to a *building* providing access from the exterior at ground level shall be designed in accordance with the requirements for *exits*.

**9.9.3. Dimensions of Means of Egress****9.9.3.1. Application**

- 1) This Subsection applies to every *means of egress* except
  - a) *exits* that serve not more than one *dwelling unit* or a house with a *secondary suite* including their common spaces, and
  - b) *access to exits* within *dwelling units* and within houses with a *secondary suite* including their common spaces.

**9.9.3.2. Exit Width**

1) Except for doors and corridors, the width of every *exit* facility shall be not less than 900 mm. (See Article 9.9.6.3. for doors, Article 9.8.2.1. for stairs, and Article 9.8.5.2. for ramps.)

**9.9.3.3. Width of Corridors**

1) The width of every *public corridor*, corridor used by the public, and *exit* corridor shall be not less than 1 100 mm. (See also Subsection 9.9.5. for obstructions in corridors.)

**9.9.3.4. Clear Height**

1) Except for stairways, doorways and *storage garages*, the minimum clear height in *exits* and *access to exits* shall be 2.1 m. (See Article 9.8.2.2. for stairs, Article 9.8.5.3. for ramps, Article 9.8.6.4. for landings and Article 9.9.6.2. for doorways.)

**2)** The clear height in *exits* and *access to exits* in *storage garages* shall be not less than 2 m.

## 9.9.4. Fire Protection of Exits

### 9.9.4.1. Application

**1)** Except as provided in Articles 9.9.4.4. and 9.9.4.6., this Subsection applies to the fire protection of all *exits* except *exits* serving not more than one *dwelling unit*.

### 9.9.4.2. Fire Separations for Exits

**1)** Except as provided in Sentences (2) and (5) and Article 9.9.8.5., every *exit* other than an exterior doorway shall be separated from each adjacent *floor area* or from another *exit*

- a) where there is a floor assembly above the *floor area*, by a *fire separation* having a *fire-resistance rating* not less than that required for the floor assembly above the *floor area* (see Article 9.10.9.10.), and
- b) where there is no floor assembly above the *floor area*, by a *fire separation* having a *fire-resistance rating* not less than the greater of
  - i) that required by Subsection 9.10.8. for the floor assembly below, or
  - ii) 45 min.

**2)** Where an *exit* is located in a house with a *secondary suite* including their common spaces, the *exit* shall be protected by a continuous smoke-tight barrier of not less than 12.7 mm thick gypsum board installed on

- a) both sides of walls separating the *exit* from the remainder of the *building*, and
- b) the underside of floor-ceiling framing separating the *exit* from the remainder of the *building*.

(See Sentence 9.10.9.3.(2) for *closures*.)

**3)** A *fire separation* common to 2 *exits* shall be smoke-tight and not be pierced by doorways, duct work, piping or any other opening that may affect the continuity of the separation.

**4)** A *fire separation* that separates an *exit* from the remainder of the *building* shall have no openings except those for electrical wiring, *noncombustible* conduit and *noncombustible* piping that serve only the *exit*, and for standpipes, sprinkler piping, *exit* doorways and wired glass and glass block permitted in Article 9.9.4.3.

**5)** The requirements in Sentences (1) and (2) do not apply to an exterior *exit* passageway provided the passageway has not less than 50% of its exterior sides open to the outdoors and is served by an *exit* stair at each end of the passageway.

### 9.9.4.3. Wired Glass or Glass Block

(See Note A-3.1.8.19.(1).)

**1)** This Article applies to wired glass in doors, and wired glass or glass block in sidelights, where these are installed in *fire separations* between *exit* enclosures and *floor areas*.

**2)** Except as provided in Sentence (3), the combined area of glazing in doors and sidelights shall not exceed 0.8 m<sup>2</sup>.

**3)** Where an *exit* enclosure connects with a *floor area* through an enclosed vestibule or corridor separated from the *floor area* by *fire separations* having not less than a 45 min *fire-resistance rating*, the glazed areas described in Sentence (1) need not be limited as required in Sentence (2).

**9.9.4.4. Openings Near Unenclosed Exterior Exit Stairs and Ramps**

**1)** *Unprotected openings* in exterior walls of the *building* shall be protected with wired glass in fixed steel frames or glass block conforming to Articles 9.10.13.5. and 9.10.13.7., where

- a) an unenclosed exterior *exit* stair or ramp provides the only *means of egress* from a *suite* and is exposed to fire from *unprotected openings* in the exterior walls of
  - i) another *fire compartment*, or
  - ii) another *dwelling unit*, ancillary space or common space in a house with a *secondary suite*, and
- b) *unprotected openings* in the exterior walls of the *building* are within 3 m horizontally and less than 10 m below or less than 5 m above the *exit* stair or ramp.

**9.9.4.5. Openings in Exterior Walls of Exits**

**1)** Either openings in exterior walls of an *exit* or openings in adjacent exterior walls of the *building* the *exit* serves shall be protected with wired glass in fixed steel frames or glass block installed in accordance with Articles 9.10.13.5. and 9.10.13.7., where

- a) the *exit* enclosure has exterior walls that intersect the exterior walls of the *building* at an angle of less than 135° measured on the outside of the *building*, and
- b) the openings in the exterior walls of the *building* are within 3 m horizontally and less than 2 m above the openings in the exterior walls of the *exit*.

(See Note A-9.9.4.5.(1).)

**9.9.4.6. Openings Near Exit Doors**

**1)** *Unprotected openings* shall be protected with wired glass in fixed steel frames or glass block conforming to Articles 9.10.13.5. and 9.10.13.7., where

- a) an exterior *exit* door
  - i) in one *fire compartment* is within 3 m horizontally of an *unprotected opening* serving another *fire compartment*, or
  - ii) in one *dwelling unit*, ancillary space or common space in a house with a *secondary suite* is within 3 m horizontally of the *unprotected openings* serving another *dwelling unit*, ancillary space or common space in a house with a *secondary suite*, and
- b) the exterior walls of the *fire compartments*, *dwelling units*, ancillary spaces and common spaces in a house with a *secondary suite* referred to in Clause (a) intersect at an exterior angle of less than 135°.

**9.9.4.7. Stairways in 2 Storey, Group D or E Buildings**

**1)** Where a *suite* of Group D or E *occupancy* is located partly on the *first storey* and partly on the second *storey*, stairways serving the second *storey* of that *suite* need not be constructed as *exit* stairs provided,

- a) the *building* is not greater than 2 *storeys* in *building height*,
- b) the *suite* is separated from other *occupancies* by at least a 45 min *fire separation*,
- c) the area occupied by the *suite* is not greater than 100 m<sup>2</sup> per *storey*,
- d) the maximum travel distance from any point in the *suite* to an exterior *exit* is not greater than 25 m,
- e) the floor assemblies have a *fire-resistance rating* of not less than 45 min or are of *noncombustible construction*, and
- f) the *basement* and *first storey* are separated by a *fire separation* having a *fire-resistance rating* of not less than 45 min.

## 9.9.5.1.

## 9.9.5. Obstructions and Hazards in Means of Egress

## 9.9.5.1. Application

1) This Subsection applies to obstructions and hazards in every *means of egress* except those within a *dwelling unit* or serving not more than one *dwelling unit*.

## 9.9.5.2. Occupancies in Corridors

1) Where a corridor contains an *occupancy*, the *occupancy* shall not reduce the unobstructed width of the corridor to less than the required width of the corridor.

## 9.9.5.3. Obstructions in Public Corridors

1) Except as permitted in Sentence (2), obstructions located within 1 980 mm of the floor shall not project horizontally more than 100 mm into *exit* passageways, corridors used by the public or *public corridors* in a manner that would create a hazard for visually impaired persons travelling adjacent to walls.

2) The horizontal projection of an obstruction referred to in Sentence (1) is permitted to exceed 100 mm where the obstruction extends to less than 680 mm above the floor. (See Note A-3.3.1.9.(4).)

## 9.9.5.4. Obstructions in Exits

1) Except as permitted in Subsection 9.9.6. and Article 9.8.7.6., no fixture, turnstile or construction shall project within the required width of an *exit*.

## 9.9.5.5. Obstructions in Means of Egress

1) No obstructions such as posts or turnstiles shall be placed so as to restrict the width of a required *means of egress* from a *floor area* or part of a *floor area* to less than 750 mm unless an alternate unobstructed *means of egress* is provided adjacent to and plainly visible from the restricted egress.

2) Except as provided in Sentence (3), no obstructions, such as counter gates, that do not meet the requirements for *exit* doors, shall be placed in a required *means of egress* from a *floor area* or part of a *floor area* unless an alternate unobstructed *means of egress* is provided adjacent to and plainly visible from the restricted egress.

3) Obstructions, such as counter gates, that do not satisfy Sentence (2), are permitted to be placed in a required *means of egress* from a part of a *floor area* in *mercantile occupancies* and *business and personal services occupancies*, provided that the part of the *floor area* served by the obstructed *means of egress* is not generally accessible to the public.

## 9.9.5.6. Mirrors or Draperies

1) No mirror shall be placed in or adjacent to any *exit* so as to confuse the direction of *exit*, and no mirror or draperies shall be placed on or over *exit* doors.

## 9.9.5.7. Fuel-Fired Appliances

1) Fuel-fired *appliances* shall not be installed in an *exit* or corridor serving as an *access to exit*.

## 9.9.5.8. Service Rooms

1) *Service rooms* containing equipment subject to possible explosion, such as *boilers* designed to operate at a pressure in excess of 100 kPa, and certain types of refrigerating and transformer equipment, shall not be located under required *exits*.

## 9.9.5.9. Ancillary Rooms

1) Except in houses with a *secondary suite*, ancillary rooms such as storage rooms, washrooms, toilet rooms, laundry rooms and *service rooms* shall not open directly into an *exit*.

**9.9.6. Doors in a Means of Egress**

**9.9.6.1. Obstructions by Doors**

- 1)** Except as provided in Sentence (4), obstructions created by doors shall be limited in accordance with Sentences (2) and (3)
  - a) at *exit* doors,
  - b) at doors that open into or are located within a *public corridor*, and
  - c) at doors that open into or are located within another facility that provides *access to exit* from a *suite*.
- 2)** When fully open, doors described in Sentence (1) shall not decrease the required *exit* width by more than
  - a) 100 mm in *exit* corridors, and
  - b) 50 mm for other *exit* facilities.
- 3)** The swing of doors described in Sentence (1) shall not reduce the width of the path of travel to less than
  - a) the required *exit* width in *exit* corridors and passageways, and
  - b) 750 mm on *exit* stairs or landings.
- 4)** Doors serving a single *dwelling unit* or a house with a *secondary suite* need not comply with Sentences (2) and (3).

**9.9.6.2. Clear Opening Height at Doorways**

- 1)** Except as provided in Sentences (2) and (3), the clear opening height of doorways shall be not less than 2 030 mm high at
  - a) *exit* doors,
  - b) doors that open into or are located within a *public corridor*, and
  - c) doors that open into or are located within another facility that provides *access to exit* from a *suite*.
- 2)** The clear opening height under door closers and other devices in doorways described in Sentence (1) shall be not less than 1 980 mm.
- 3)** Doorways serving a single *dwelling unit* or a house with a *secondary suite* need not comply with Sentences (1) and (2). (See also Article 9.5.5.1.)

**9.9.6.3. Clear Opening Width at Doorways**

- 1)** Except as provided in Sentence (4), the clear opening width of doorways shall comply with Sentence (2) at
  - a) *exit* doors, and
  - b) doors that open into or are located within a *public corridor* or other facility that provides *access to exit* from a *suite*.
- 2)** Doorways described in Sentence (1) shall be
  - a) not less than 800 mm wide where there is only one door leaf,
  - b) not less than 800 mm wide where multiple-leaf doors are installed with only one active leaf having a latching mechanism described in Article 9.9.6.7., and
  - c) not less than 1 210 mm wide where multiple-leaf doors are installed with two active leaves.
- 3)** In doorways described in Sentence (1) that have multiple-leaf doors installed,
  - a) no active leaf shall be less than 810 mm wide where only one leaf is active, and
  - b) no single leaf shall be less than 610 mm wide where two leaves are active.
- 4)** Doorways serving a single *dwelling unit* or a house with a *secondary suite* need not comply with Sentence (2). (See also Article 9.5.5.1.)

**9.9.6.4. Door Action**

- 1)** Except as provided in Sentences (4) and (5), required *exit* doors and doors in required *means of egress*, except doors in *means of egress* within *dwelling units*, shall swing on the vertical axis.

**2)** Except as provided in Sentence (5), breakaway sliding doors, installed as required *exit* doors or required doors in *means of egress*, shall be identified as swinging doors by means of a label or decal affixed to the door.

**3)** Revolving doors shall comply with Article 3.4.6.15.

**4)** Movable *partitions* used to separate a *public corridor* from an adjacent *business and personal services occupancy* or a *mercantile occupancy* need not conform to Sentence (1), provided the partitions are not located in the only *means of egress*. (See Note A-3.3.1.12.(3).)

**5)** *Exit* doors need not conform to Sentences (1) or (2), where

- a) the doors serve accessory *buildings* where life safety is not adversely affected,
- b) the doors serve *storage garages* or other accessory *buildings* serving not more than one *dwelling unit*, or
- c) the doors
  - i) serve *storage suites* of not more than 20 m<sup>2</sup> in gross area that are in warehousing *buildings* of not more than one *storey*, and
  - ii) open directly to the exterior at ground level.

#### 9.9.6.5. Direction of Door Swing

**1)** Except for doors serving a single *dwelling unit* or a house with a *secondary suite*, *exit* doors that are required to swing shall swing in the direction of *exit* travel.

**2)** Doors that open onto a corridor or other facility that provides *access to exit* from a room or *suite* having an *occupant load* of more than 60 persons shall swing on the vertical axis in the direction of *exit* travel.

**3)** Doors that divide a corridor that is not wholly contained within a *suite* shall swing in the direction of *exit* travel.

**4)** Where a pair of doors is installed in a corridor that provides *access to exit* in both directions, the doors shall

- a) swing in opposite directions, with the door on the right-hand side swinging in the direction of *exit* travel, or
- b) swing in both directions.

#### 9.9.6.6. Nearness of Doors to Stairs

**1)** Except as provided in Sentence (2), the distance between a stair riser and the leading edge of a door during its swing, except for doors serving a single *dwelling unit* or a house with a *secondary suite*, shall be not less than 300 mm.

**2)** Where there is a danger of blockage from ice or snow, an *exit* door, including doors serving a single *dwelling unit*, may open onto not more than one step, provided the riser of such a step does not exceed 150 mm.

#### 9.9.6.7. Door Latching, Locking and Opening Mechanisms

**1)** Principal entrance doors, *exit* doors and doors to *suites*, including exterior doors of *dwelling units*, and other doors in an *access to exit* shall

- a) be openable from the inside or in travelling to an *exit* without requiring keys, special devices or specialized knowledge of the door-opening mechanism, or
- b) be controlled by electromagnetic locking mechanisms in accordance with Sentence 3.4.6.16.(4).

**2)** Except for doors serving a single *dwelling unit* or a house with a *secondary suite*, and doors to accessory *buildings* and to garages serving a single *dwelling unit*, door release hardware on doors in a *means of egress* shall be operable with one hand and the door shall be openable with not more than one releasing operation. (See also Sentence 3.8.3.6.(4) and Note A-3.3.1.13.(4).)

**3)** Door release hardware on doors in a *means of egress* shall be installed not more than 1 200 mm above the finished floor.



4) Except for hotels and motels, a door opening onto a *public corridor* that provides *access to exit* from *suites* shall be designed not to lock automatically if it is equipped with an automatic self-closing device. (See Note A-3.3.4.5.(1).)

#### 9.9.6.8. Effort Required to Open

1) Every *exit* door, except doors serving a single *dwelling unit* or a house with a *secondary suite*, shall be designed and installed so that when the latch is released the door will open in the direction of *exit* travel under a force of not more than 90 N applied to the door release hardware. (See Sentence 3.8.3.6.(8) for door opening forces in a *barrier-free* path of travel.)

### 9.9.7. Access to Exits

#### 9.9.7.1. Egress from Roof Area, Podiums, Terraces, Platforms and Contained Open Spaces

1) An *access to exit* shall be provided from every roof intended for *occupancy* and from every podium, terrace, platform or contained open space.

2) Where a roof is intended for an *occupant load* of more than 60 persons, at least 2 separate *means of egress* shall be provided from the roof to stairs designed in conformance with the requirements for *exit* stairs and located remote from each other.

3) Where a podium, terrace, platform or contained open space is provided, egress requirements shall conform to the appropriate requirements for rooms or *suites* in Article 9.9.7.4.

#### 9.9.7.2. Means of Egress from Suites

1) Except as required in Sentence 9.9.9.3.(1), each *suite* in a *floor area* occupied by more than one *suite* shall have

- a) an exterior *exit* doorway,
- b) a doorway to a *public corridor*, or
- c) a doorway to an exterior passageway.

2) Except as provided in Sentences 9.9.7.3.(1) and 9.9.8.2.(2), from the point where a doorway described in Clause (1)(b) or (c) enters the *public corridor* or exterior passageway, it shall be possible to go in opposite directions to each of 2 separate *exits*.

#### 9.9.7.3. Dead-End Corridors

1) Except for a dead-end corridor that is entirely within a *suite* and except as permitted in Sentence 9.9.9.2.(1), a dead-end corridor is permitted provided it is not more than 6 m long.

#### 9.9.7.4. Number and Spacing of Egress Doors

1) Except for *dwelling units*, at least 2 egress doors shall be provided when the area of a room or *suite*, or the distance measured from any point within the room or *suite* to the nearest egress door, exceeds the values in Table 9.9.7.4.

2) Doors required in Sentence (1) shall be spaced so that in the event that one door is made inaccessible by a fire within such room or *suite*, the other door will provide safe egress.

**Table 9.9.7.4.**  
**Maximum Areas and Travel Distances for Rooms, Suites and Mezzanines with a Single Means of Egress**  
 Forming Part of Sentences 9.9.7.4.(1) and 9.9.8.6.(2)

Occupancy of Room, Suite or Floor Area	Maximum Area of Room, Suite or Floor Area, m <sup>2</sup>	Maximum Distance to Egress Door, m
Group C (except <i>dwelling units</i> )	100	15
Group D	200	25
Group E	150	15
Group F, Division 2	150	10
Group F, Division 3	200	15

### 9.9.7.5. Independent Access to Exit

1) Required *access to exit* from *suites* shall not be through any other *dwelling unit*, *service room* or other *occupancy*.

### 9.9.7.6. Travel Distance within Rooms and Suites

1) Except for *dwelling units*, the travel distance from any point within the room or *suite* to the nearest egress door shall not exceed the maximum travel distance in Article 9.9.8.2.

## 9.9.8. Exits from Floor Areas

### 9.9.8.1. Measurement of Travel Distance

1) Except as provided in Sentences (2) and (3), for the purposes of this Subsection, travel distance means the distance from any point in the *floor area* to an *exit* measured along the path of *exit* travel.

2) Where a room or *suite* is separated from the remainder of the *floor area* by a *fire separation* having a *fire-resistance rating* of at least 45 min or, in a *sprinklered building*, by a *fire separation* which is not required to have a *fire-resistance rating*, the travel distance may be measured from an egress door of the room or *suite* to the nearest *exit*.

3) Where a *public corridor* is not less than 9 m wide and conforms to Subclauses 3.4.2.5.(1)(d)(i) to (d)(iv), the travel distance may be determined in accordance with those Subclauses.

### 9.9.8.2. Number of Required Exits

1) Except as provided in Sentence (2) and Subsection 9.9.9., at least 2 *exits* shall be provided from every *floor area*, spaced so that the travel distance to the nearest *exit* is not more than

- a) 40 m in the case of *business and personal services occupancies*,
- b) 45 m for all *occupancies* where the *floor area* is *sprinklered*, and
- c) 30 m for all other *occupancies*.

2) Except as provided in Subsection 9.9.9., a single *exit* is permitted from each *storey* in *buildings* of 1 and 2 *storeys* in *building height* provided the *floor area* and travel distance requirements conform to those required in Article 9.9.7.4. and the total *occupant load* served by an *exit* facility does not exceed 60 persons.

### 9.9.8.3. Contribution of Each Exit

1) Where more than one *exit* is required from a *floor area*, each *exit* shall be considered as contributing not more than half the required *exit* width.

### 9.9.8.4. Location of Exits

1) Where more than one *exit* is required from a *floor area*, at least 2 *exits* shall be independent of each other and be placed remote from each other along the path of travel between them. (See Note A-9.9.8.4.(1).)

**9.9.8.5. Exiting through a Lobby**

- 1) Not more than one *exit* from a *floor area* above or below the *first storey* is permitted to lead through a lobby.
- 2) The lobby referred to in Sentence (1) shall be not more than 4.5 m above *grade*, and the path of travel through the lobby to the outdoors shall not exceed 15 m.
- 3) The lobby referred to in Sentence (1) shall conform in all respects to the requirements for *exits*, except that rooms other than *service rooms*, storage rooms and rooms of *residential* or *industrial occupancy* are permitted to open directly onto such lobby.
- 4) Where the lobby referred to in Sentence (1) and adjacent *occupancies* that are permitted to open into the lobby are *sprinklered*, the *fire separation* between such *occupancies* and the lobby need not have a *fire-resistance rating*. (See Note A-3.4.4.2.(2)(e).)
- 5) Passenger elevators are permitted to open onto the lobby referred to in Sentence (1) provided the elevator doors are designed to remain closed except while loading and unloading passengers.

**9.9.8.6. Mezzanine Means of Egress**

- 1) Except as permitted by Sentences (2) and (3), the space above a *mezzanine* shall be served by *means of egress* leading to *exits* accessible at the *mezzanine* level, on the same basis as *floor areas*.
- 2) The *means of egress* from a *mezzanine* need not conform to Sentence (1), provided
  - a) the *mezzanine* is not required to terminate at a vertical *fire separation*, as permitted by Sentence 9.10.12.1.(2),
  - b) the *occupant load* of the *mezzanine* is not more than 60,
  - c) the area of the *mezzanine* does not exceed the area limits stated in Table 9.9.7.4., and
  - d) the distance limits stated in Table 9.9.7.4., measured along the path of travel, are not exceeded from any point on the *mezzanine* to
    - i) an egress door serving the space that the *mezzanine* overlooks if the space is served by a single egress door, or
    - ii) an egress stairway leading to an *access to exit* in the space below if that space is required to be served by 2 or more egress doorways in conformance with Sentence 9.9.7.4.(1).
- 3) One of the *means of egress* from a *mezzanine* that is not required to terminate at a *fire separation*, as permitted by Sentence 9.10.12.1.(2), and that exceeds the limits of Sentence (2) is permitted to lead through the room in which the *mezzanine* is located, provided all other *means of egress* from that *mezzanine* lead to *exits* accessible at the *mezzanine* level.
- 4) Except as provided in Sentence (2), the maximum travel distance from any point on a *mezzanine* to the nearest *exit* shall be not more than
  - a) 40 m in a *business and personal services occupancy*,
  - b) 45 m in a *floor area* that is *sprinklered* throughout, provided it does not contain a *high-hazard industrial occupancy*, or
  - c) 30 m in any *floor area* not referred to in Clauses (a) or (b).

**9.9.9. Egress from Dwelling Units****9.9.9.1. Travel Limit to Exits or Egress Doors**

- 1) Except as provided in Sentences (2) and (3), every *dwelling unit* containing more than 1 *storey* shall have *exits* or egress doors located so that it shall not be necessary to travel up or down more than 1 *storey* to reach a level served by
  - a) an egress door to a *public corridor*, enclosed *exit* stair or exterior passageway, or
  - b) an *exit* doorway not more than 1.5 m above adjacent ground level.

**2)** Where a *dwelling unit* is not located above or below another *suite*, the travel limit from a floor level in the *dwelling unit* to an *exit* or egress door may exceed 1 *storey* where that floor level is served by an openable window

- a) providing an unobstructed opening of not less than 1 m in height and 0.55 m in width, and
- b) located so that the sill is not more than
  - i) 1 m above the floor, and
  - ii) 7 m above adjacent ground level.

**3)** The travel limit from a floor level in a *dwelling unit* to an *exit* or egress door may exceed 1 *storey* where that floor level has direct access to a balcony.

### 9.9.9.2. Two Separate Exits

**1)** Except as provided in Sentence 9.9.7.3.(1) and except for *dwelling units* in a house with a *secondary suite*, where an egress door from a *dwelling unit* opens onto a *public corridor* or exterior passageway it shall be possible from the location where the egress door opens onto the corridor or exterior passageway to go in opposite directions to 2 separate *exits* unless the *dwelling unit* has a second and separate *means of egress*.

### 9.9.9.3. Shared Egress Facilities

**1)** Except for *dwelling units* in a house with a *secondary suite*, a *dwelling unit* shall be provided with a second and separate *means of egress* where an egress door from the *dwelling unit* opens onto

- a) an *exit* stairway serving more than one *suite*,
- b) a *public corridor*
  - i) serving more than one *suite*, and
  - ii) served by a single *exit*,
- c) an exterior passageway
  - i) serving more than one *suite*,
  - ii) served by a single *exit* stairway or ramp, and
  - iii) more than 1.5 m above adjacent ground level, or
- d) a balcony
  - i) serving more than one *suite*,
  - ii) served by a single *exit* stairway or ramp, and
  - iii) more than 1.5 m above adjacent ground level.

**2)** Where a *dwelling unit* is located above another *dwelling unit* or common space in a house with a *secondary suite*, the upper *dwelling unit* shall be provided with a second and separate *means of egress* where an egress door from that *dwelling unit* opens onto an exterior passageway that

- a) has a floor assembly with a *fire-resistance rating* less than 45 min,
- b) is served by a single *exit* stairway or ramp, and
- c) is located more than 1.5 m above adjacent ground level.

## 9.9.10. Egress from Bedrooms

### 9.9.10.1. Egress Windows or Doors for Bedrooms

**1)** Except where the *suite* is *sprinklered*, each bedroom or combination bedroom shall have at least one outside window or exterior door openable from the inside without the use of keys, tools or special knowledge and without the removal of sashes or hardware. (See Article 9.5.1.2. and Note A-9.9.10.1.(1).)

- 2)** The window referred to in Sentence (1) shall
- a) provide an unobstructed opening of not less than 0.35 m<sup>2</sup> in area with no dimension less than 380 mm, and
  - b) maintain the required opening during an emergency without the need for additional support.

(See Note A-9.9.10.1.(2).)

**3)** Where a window required in Sentence (1) opens into a window well, a clearance of not less than 760 mm shall be provided in front of the window. (See Note A-9.9.10.1.(3).)

**4)** Where the sash of a window referred to in Sentence (3) swings towards the window well, the operation of the sash shall not reduce the clearance in a manner that would restrict escape in an emergency.

**5)** Where a protective enclosure is installed over the window well referred to in Sentence (3), the enclosure shall be openable from the inside without the use of keys, tools or special knowledge of the opening mechanism.

**9.9.11. Signs**

**9.9.11.1. Application**

**1)** This Subsection applies to all *exits* except those serving not more than one *dwelling unit* or a house with a *secondary suite*.

**9.9.11.2. Visibility of Exits**

**1)** *Exits* shall be located so as to be clearly visible or their locations shall be clearly indicated.

**2)** Where an *exit* door leading directly to the outside is subject to being obstructed by parked vehicles or storage because of its location, a visible sign or a physical barrier prohibiting such obstructions shall be installed on the exterior side of the door.

**9.9.11.3. Exit Signs**

**1)** Every *exit* door shall have an *exit* sign placed over it or adjacent to it if the *exit* serves

- a) a *building* that is 3 *storeys* in *building height*,
- b) a *building* having an *occupant load* of more than 150, or
- c) a room or *floor area* that has a fire escape as part of a required *means of egress*.

**2)** Every *exit* sign shall

- a) be visible on approach to the *exit*,
- b) consist of a green and white or lightly tinted graphical symbol meeting the colour specifications referred to in ISO 3864-1, "Graphical symbols – Safety colours and safety signs – Part 1: Design principles for safety signs and safety markings," and
- c) conform to ISO 7010, "Graphical symbols – Safety colours and safety signs – Registered safety signs," for the following symbols (see Note A-3.4.5.1.(2)(c)):
  - i) E001 emergency exit left,
  - ii) E002 emergency exit right,
  - iii) E005 90-degree directional arrow, and
  - iv) E006 45-degree directional arrow.

**3)** Internally illuminated *exit* signs shall be continuously illuminated and

- a) where illumination of the sign is powered by an electrical circuit, be constructed in conformance with CSA C22.2 No. 141, "Emergency Lighting Equipment," or
- b) where illumination of the sign is not powered by an electrical circuit, be constructed in conformance with CAN/ULC-S572, "Photoluminescent and Self-Luminous Exit Signs and Path Marking Systems."

**4)** Externally illuminated *exit* signs shall be continuously illuminated and be constructed in conformance with CAN/ULC-S572, "Photoluminescent and Self-Luminous Exit Signs and Path Marking Systems." (See Note A-3.4.5.1.(4).)

**5)** The circuitry serving lighting for externally and internally illuminated *exit* signs shall

- a) serve no equipment other than emergency equipment, and
- b) be connected to an emergency power supply as described in Sentences 9.9.12.3.(2), (3) and (7).

**6)** Where no *exit* is visible from a *public corridor*, from a corridor used by the public, or from principal routes serving an open *floor area* having an *occupant load* of more than 150, an *exit* sign conforming to Clauses (2)(b) and (c) with an arrow or pointer indicating the direction of egress shall be provided.

#### 9.9.11.4. Signs for Stairs and Ramps at Exit Level

**1)** In *buildings* that are 3 *storeys* in *building height*, any part of an *exit* ramp or stairway that continues up or down past the lowest *exit level* shall be clearly marked to indicate that it does not lead to an *exit*, if the portion beyond the *exit level* may be mistaken as the direction of *exit* travel.

#### 9.9.11.5. Floor Numbering

- 1)** Arabic numerals indicating the assigned floor number shall be
  - a) mounted permanently on the stair side of the wall at the latch side of doors to *exit* stair shafts,
  - b) not less than 60 mm high, raised approximately 0.8 mm above the surface,
  - c) located 1 500 mm from the finished floor and not more than 300 mm from the door, and
  - d) contrasting in colour with the surface on which they are applied. (See Note A-3.4.6.19.(1)(d).)

### 9.9.12. Lighting

#### 9.9.12.1. Application

**1)** This Subsection applies to the lighting of all *means of egress* except those within *dwelling units* or a house with a *secondary suite*.

#### 9.9.12.2. Required Lighting in Egress Facilities

**1)** Every *exit*, *public corridor* or corridor providing *access to exit* for the public shall be equipped to provide illumination to an average level of not less than 50 lx at floor or tread level and at all points such as angles and intersections at changes of level where there are stairs or ramps.

**2)** The minimum value of the illumination required by Sentence (1) shall be not less than 10 lx.

#### 9.9.12.3. Emergency Lighting

- 1)** Emergency lighting shall be provided in
  - a) *exits*,
  - b) principal routes providing *access to exit* in an open *floor area*,
  - c) corridors used by the public,
  - d) underground *walkways*, and
  - e) *public corridors*.

**2)** Emergency lighting required in Sentence (1) shall be provided from a source of energy separate from the electrical supply for the *building*.

**3)** Lighting required in Sentence (1) shall be designed to be automatically actuated for a period of at least 30 min when the electric lighting in the affected area is interrupted.

**4)** Illumination from lighting required in Sentence (1) shall be provided to average levels of not less than 10 lx at floor or tread level.

**5)** The minimum value of the illumination required by Sentence (4) shall be not less than 1 lx.

6) Where incandescent lighting is provided, lighting equal to 1 W/m<sup>2</sup> of *floor area* shall be considered to meet the requirement in Sentence (4).

7) Where self-contained emergency lighting units are used, they shall conform to CSA C22.2 No. 141, "Emergency Lighting Equipment."

## Section 9.10. Fire Protection

### 9.10.1. Definitions and Application

#### 9.10.1.1. Sloped Roofs

1) For the purposes of this Section, roofs with slopes of 60° or more to the horizontal that are adjacent to a room or space intended for *occupancy* shall be considered as a wall.

#### 9.10.1.2. Testing of Integrated Fire Protection and Life Safety Systems

1) Where life safety and fire protection systems and systems with fire protection and life safety functions are integrated with each other, they shall be tested as a whole in accordance with CAN/ULC-S1001, "Integrated Systems Testing of Fire Protection and Life Safety Systems," to verify that they have been properly integrated. (See Note A-3.2.9.1.(1).)

#### 9.10.1.3. Items under Part 3 Jurisdiction

1) Tents, *air-supported structures*, transformer vaults, *walkways*, elevators and escalators shall conform to Part 3.

2) Where rooms or spaces are intended for an *assembly occupancy*, such rooms or spaces shall conform to Part 3.

3) *Basements* containing more than 1 *storey* or exceeding 600 m<sup>2</sup> in area shall conform to Part 3.

4) Where rooms or spaces are intended for the storage, manufacture or use of hazardous or explosive material, such rooms or spaces shall conform to Part 3. (See Note A-3.3.1.2.(1).)

5) Except as provided in Article 3.3.5.8., facilities for the dispensing of fuel shall not be installed in any *building*.

6) Openings through floors that are not protected by shafts or *closures* shall be protected in conformance with Subsection 3.2.8. (See also Sentence 9.9.4.7.(1).)

7) Chutes and shafts shall conform to Subsection 3.6.3. except where they are entirely contained within a *dwelling unit*.

8) Sprinkler systems shall be designed, constructed and installed in conformance with Articles 3.2.5.12. to 3.2.5.15. and 3.2.5.17.

9) Standpipe and hose systems shall be designed, constructed and installed in conformance with Articles 3.2.5.8. to 3.2.5.11. and 3.2.5.17.

10) Fire pumps shall be installed in conformance with Articles 3.2.5.17. and 3.2.5.18.

11) Where fuel-fired *appliances* are installed on a roof, such *appliances* shall be installed in conformance with Article 3.6.1.5.

#### 9.10.1.4. Items under Part 6 Jurisdiction

1) In kitchens containing commercial cooking equipment used in processes producing grease-laden vapours, the equipment shall be designed and installed in conformance with Article 6.3.1.7. (See Note A-9.10.1.4.(1).)

**9.10.2. Occupancy Classification**

**9.10.2.1. Occupancy Classification**

1) Except as provided in Article 9.10.2.2., every *building* or part thereof shall be classified according to its *major occupancy* as belonging to one of the groups or divisions described in Table 9.10.2.1.

**Table 9.10.2.1.**  
**Occupancy Classifications**  
 Forming Part of Sentence 9.10.2.1.(1)

Group	Division	Description of <i>Major Occupancies</i> <sup>(1)</sup>
C	—	<i>Residential occupancies</i>
D	—	<i>Business and personal services occupancies</i>
E	—	<i>Mercantile occupancies</i>
F	2	<i>Medium-hazard industrial occupancies</i>
F	3	<i>Low-hazard industrial occupancies</i> (Does not include <i>storage garages</i> serving individual <i>dwelling units</i> )

**Notes to Table 9.10.2.1.:**

(1) See Note A-3.1.2.1.(1).

**9.10.2.2. Custodial and Convalescent Homes**

1) Children’s custodial homes and convalescent homes for ambulatory occupants living as a single housekeeping unit in a *dwelling unit* with sleeping accommodation for not more than 10 persons are permitted to be classified as *residential occupancies* (Group C).

**9.10.2.3. Major Occupancies above Other Major Occupancies**

1) Except as permitted in Article 9.10.2.4., in any *building* containing more than one *major occupancy* in which one *major occupancy* is located entirely above another, the requirements of Article 9.10.8.1. for each portion of the *building* containing a *major occupancy* shall be applied to that portion as if the entire *building* was of that *major occupancy*.

**9.10.2.4. Buildings Containing More Than One Major Occupancy**

1) In a *building* containing more than one *major occupancy*, where the aggregate area of all *major occupancies* in a particular group or division does not exceed 10% of the *floor area* on the *storey* on which they are located, they need not be considered as *major occupancies* for the purposes of Articles 9.10.8.1. and 9.10.2.3. provided they are not classified as Group F, Division 2 *occupancies*.

**9.10.3. Ratings**

**9.10.3.1. Fire-Resistance and Fire-Protection Ratings**

1) Where a *fire-resistance rating* or a *fire-protection rating* is required in this Section for an element of a *building*, such rating shall be determined in conformance with

- a) the test methods described in Part 3,
- b) the calculation method presented in Appendix D, or
- c) the construction specifications presented in Tables 9.10.3.1.-A and 9.10.3.1.-B.

**9.10.3.2. Flame-Spread Ratings**

1) Where a *flame-spread rating* is required in this Section for an element of a *building*, such rating shall be determined in accordance with the test methods described in Part 3, or in accordance with Appendix D.



2) Unless the *flame-spread rating* is referred to herein as a “*surface flame-spread rating*,” it shall apply to any surface of the element being considered that would be exposed by cutting through it as well as to the exposed surface of the element.

### 9.10.3.3. Fire Exposure

1) Floor, roof and ceiling assemblies shall be rated for exposure to fire on the underside.

2) Exterior walls shall be rated for exposure to fire from inside the *building*, except that such walls need not comply with the temperature rise limitations required by the standard tests referred to in Article 9.10.3.1. if such walls have a *limiting distance* of not less than 1.2 m, and due allowance is made for the effects of heat radiation in accordance with the requirements in Part 3.

3) Interior vertical *fire separations* required to have *fire-resistance ratings* shall be rated for exposure to fire on each side.

### 9.10.3.4. Suspended Membrane Ceilings

1) Where a ceiling construction has a suspended membrane ceiling with lay-in panels or tiles which contribute to the required *fire-resistance rating*, hold down clips or other means shall be provided to prevent the lifting of such panels or tiles in the event of a fire.

## 9.10.4. Building Size Determination

### 9.10.4.1. Mezzanines not Considered as Storeys

1) Except as required by Sentences (2) and 9.10.4.2.(1), the space above a *mezzanine* is permitted to be excluded from the calculation of *building height*, provided

- a) the aggregate area of *mezzanines* that are not superimposed does not exceed 10% of the *floor area* of the *building* in which they are located, and
- b) the area of *mezzanine* in a *suite* does not exceed 10% of the area of that *suite* on the *storey* on which it is located.

2) Except as required by Sentence 9.10.4.2.(1), the space above a *mezzanine* is permitted to be excluded from the calculation of *building height*, provided

- a) the aggregate area of *mezzanines* that are not superimposed does not exceed 40% of the open area of the room in which they are located (see Note A-3.2.1.1.(3)(a)), and
- b) except as permitted in Sentence (3), the space above the *mezzanine* floor is used as an open area without *partitions* or subdividing walls higher than 1 070 mm above the *mezzanine* floor.

3) The space above a *mezzanine* conforming to Sentence (2) is permitted to include an enclosed space whose area does not exceed 10% of the open area of the room in which the *mezzanine* is located, provided the enclosed space does not obstruct visual communication between the open space above the *mezzanine* and the room in which it is located.

4) For the purpose of determining *occupant load*, the areas of *mezzanines* that are not considered as *storeys* shall be added to the *floor area* of the *storey* on which they are located. (See Note A-9.10.4.1.(4).)

5) Platforms and catwalks intended solely for periodic inspection and maintenance need not be considered as floor assemblies or *mezzanines* for the purpose of calculating *building height*, provided

- a) they are not used for storage, and
- b) they are constructed with *noncombustible* materials, unless the *building* is permitted to be of *combustible construction*.

### 9.10.4.2. More Than One Level of Mezzanine

1) Each level of *mezzanine* that is partly or wholly superimposed above the first level of *mezzanine* shall be considered as a *storey* in calculating the *building height*.

**9.10.4.3.****9.10.4.3. Basement Storage Garages**

1) Where a *basement* is used primarily as a *storage garage*, the *basement* is permitted to be considered as a separate *building* for the purposes of this Section provided the floor above the *basement* and the exterior walls of the *basement* above the adjoining ground level are constructed as *fire separations* of masonry or concrete having a *fire-resistance rating* of not less than 2 h.

**9.10.4.4. Roof-Top Enclosures**

1) Roof-top enclosures provided for elevator machinery, stairways and *service rooms*, used for no purpose other than for service to the *building*, shall not be considered as a *storey* in calculating the *building height*.

**9.10.5. Permitted Openings in Wall and Ceiling Membranes****9.10.5.1. Permitted Openings in Wall and Ceiling Membranes**

1) Except as permitted in Sentences (2) and (4), a membrane forming part of an assembly required to have a *fire-resistance rating* shall not be pierced by openings into the assembly unless the assembly has been tested and rated for such openings.

2) A wall or ceiling membrane forming part of an assembly required to have a *fire-resistance rating* is permitted to be pierced by openings for electrical and similar service outlet boxes provided such outlet boxes are tightly fitted.

3) Where boxes referred to in Sentence (2) are located on both sides of walls required to provide a *fire-resistance rating*, they shall be offset where necessary to maintain the integrity of the *fire separation*.

4) A membrane ceiling forming part of an assembly assigned a *fire-resistance rating* on the basis of Table 9.10.3.1.-B or Appendix D is permitted to be pierced by openings leading to ducts within the ceiling space provided the ducts, the amount of openings and their protection conform to the requirements of Appendix D.

**9.10.6. Construction Types****9.10.6.1. Combustible Elements in Noncombustible Construction**

1) Where a *building* or part of a *building* is required to be of *noncombustible construction*, *combustible* elements shall be limited in conformance with the requirements in Subsection 3.1.5.

**9.10.6.2. Heavy Timber Construction**

1) *Heavy timber construction* shall be considered to have a 45 min *fire-resistance rating* when it is constructed in accordance with the requirements for *heavy timber construction* in Article 3.1.4.7.

**9.10.7. Steel Members****9.10.7.1. Protection of Steel Members**

1) Except as permitted in Article 3.2.2.3., structural steel members used in construction required to have a *fire-resistance rating* shall be protected to provide the required *fire-resistance rating*.

**9.10.8. Fire Resistance and Combustibility in Relation to Occupancy, Height and Supported Elements****9.10.8.1. Fire-Resistance Ratings for Floors and Roofs**

1) Except as otherwise provided in this Subsection, the *fire-resistance ratings* of floors and roofs shall conform to Table 9.10.8.1. (See Subsection 9.10.2. for mixed *occupancies* and Subsection 9.10.21. for construction camps.)

**Table 9.10.8.1.**  
**Fire-Resistance Ratings for Structural Members and Assemblies**  
 Forming Part of Sentence 9.10.8.1.(1)

Major Occupancy	Maximum Building Height, storeys	Minimum Fire-Resistance Rating by Building Element, min		
		Floors Except Floors over Crawl Spaces	Mezzanine Floors	Roofs
Residential (Group C)	3	45	45	—
All other occupancies	2	45	—	—
	3	45	45	45

**9.10.8.2. Fire-Resistance Ratings in Sprinklered Buildings**

- 1) The requirements in Table 9.10.8.1. for roof assemblies to have a *fire-resistance rating* are permitted to be waived in *sprinklered buildings* where
  - a) the sprinkler system is electrically supervised in conformance with Sentence 3.2.4.9.(3), and
  - b) the operation of the sprinkler system will cause a signal to be transmitted to the fire department in conformance with Sentence 3.2.4.7.(4).

**9.10.8.3. Fire-Resistance Ratings for Walls, Columns and Arches**

- 1) Except as otherwise provided in this Subsection, all *loadbearing* walls, columns and arches in the *storey* immediately below a floor or roof assembly shall have a *fire-resistance rating* of not less than that required for the supported floor or roof assembly.
- 2) Light-frame walls, columns, arches and beams as well as *loadbearing* steel elements that support floors between *dwelling units* in a house with a *secondary suite* including their common spaces shall be protected by not less than 12.7 mm thick gypsum board. (See Note A-9.10.8.3.(2).)

**9.10.8.4. Support of Noncombustible Construction**

- 1) Where an assembly is required to be of *noncombustible construction* and to have a *fire-resistance rating*, it shall be supported by *noncombustible construction*.

**9.10.8.5. Service Rooms**

- 1) Construction supporting a *service room* need not conform to Article 9.10.8.3.

**9.10.8.6. Mezzanines**

- 1) *Mezzanines* required to be counted as *storeys* in Articles 9.10.4.1. and 9.10.4.2. shall be constructed in conformance with the requirements for “Floors Except Floors over Crawl Spaces” in Table 9.10.8.1.

**9.10.8.7. Roofs Supporting an Occupancy**

- 1) Where a portion of a roof supports an *occupancy*, that portion shall be constructed as a *fire separation* having a *fire-resistance rating* conforming to the rating for “Floors Except Floors over Crawl Spaces” in Table 9.10.8.1.

**9.10.8.8. Floors of Exterior Passageways**

- 1) Except as provided in Sentences (2) and (3), the floor assembly of every exterior passageway used as part of a *means of egress* shall have a *fire-resistance rating* of not less than 45 min or be of *noncombustible construction*.
- 2) No *fire-resistance rating* is required for floors of exterior passageways serving *buildings* of Group D, E or F *major occupancy* that are not more than 2 *storeys* in *building height*.

- 3) No *fire-resistance rating* is required for floors of exterior passageways serving
  - a) a house with a *secondary suite*, or
  - b) a single *dwelling unit* where no *suite* is located above or below the *dwelling unit* (see also Sentence 9.9.9.3.(2)).

#### 9.10.8.9. Crawl Spaces

1) Where a crawl space exceeds 1.8 m in height or is used for any *occupancy* or as a *plenum in combustible construction* or for the passage of *flue pipes*, it shall be considered as a *basement* in applying the requirements in Article 9.10.8.1.

#### 9.10.8.10. Application to Houses

- 1) Table 9.10.8.1. does not apply to
  - a) a *dwelling unit* that has no other *dwelling unit* above or below it,
  - b) houses with a *secondary suite*, where the floor framing is protected on the underside by a continuous smoke-tight barrier of not less than 12.7 mm thick gypsum board, or
  - c) a *dwelling unit* that is not above or below another *major occupancy*.

#### 9.10.8.11. Part 3 as an Alternative

1) The *fire-resistance ratings* of floors, roofs, *loadbearing walls*, columns and arches need not conform to this Subsection if such assemblies conform in all respects to the appropriate requirements in Section 3.2.

### 9.10.9. Fire Separations and Smoke-tight Barriers between Rooms and Spaces within Buildings

#### 9.10.9.1. Application

- 1) This Subsection applies to
  - a) *fire separations* required between rooms and spaces in *buildings*, and
  - b) smoke-tight barriers required in houses with a *secondary suite* including their common spaces.

#### 9.10.9.2. Continuous Barrier

1) Except as permitted in Article 9.10.9.3., a wall or floor assembly required to be a *fire separation* shall be constructed as a continuous barrier against the spread of fire and retard the passage of smoke.

2) Except as permitted in Article 9.10.9.3., a wall or floor assembly required to be a smoke-tight barrier shall be constructed as a continuous barrier against the spread of smoke.

3) The continuity of a *fire separation* or smoke-tight barrier shall be maintained where it abuts another *fire separation* or smoke-tight barrier, a floor, a ceiling, a roof, or an exterior wall assembly. (See Notes A-9.10.9.2.(3) and A-3.1.8.3.(4).)

4) All gypsum board joints in the assemblies described in Sentences (1) and (2) shall conform to CSA A82.31-M, "Gypsum Board Application," and penetrations in these assemblies shall be sealed using flexible sealant or tape to maintain the integrity of the smoke-tight barrier over the entire surface.

#### 9.10.9.3. Openings to be Protected with Closures

1) Except as permitted in Articles 9.10.9.5., 9.10.9.6. and 9.10.9.7., openings in required *fire separations* shall be protected with *closures* conforming to Subsection 9.10.13.

- 2) Doors in smoke-tight barriers shall
  - a) be solid-core, wood doors at least 45 mm thick, and
  - b) have a self-closing device.

(See Note A-9.10.9.3.(2).)

**9.10.9.4. Floor Assemblies**

- 1) Except as permitted in Sentences (2) to (4), all floor assemblies shall be constructed as *fire separations*.
- 2) Floor assemblies contained within *dwelling units* and within houses with a *secondary suite* need not be constructed as *fire separations*.
- 3) Floor assemblies for which no *fire-resistance rating* is required by Subsection 9.10.8. and floors of *mezzanines* not required to be counted as *storeys* in Articles 9.10.4.1. and 9.10.4.2. need not be constructed as *fire separations*.
- 4) Where a crawl space is not required by Article 9.10.8.9. to be constructed as a *basement*, the floor above it need not be constructed as a *fire separation*.

**9.10.9.5. Interconnected Floor Spaces**

- 1) *Interconnected floor spaces* shall conform to Subsection 3.2.8.

**9.10.9.6. Penetration of Fire Separations**

(See Note A-3.1.9.)

- 1) Piping, tubing, ducts, *chimneys*, wiring, conduit, electrical outlet boxes and other similar service equipment that penetrate a required *fire separation* shall be tightly fitted or fire stopped to maintain the integrity of the separation. (See Note A-9.10.9.6.(1).)
- 2) Penetrations of a *firewall* shall be sealed at the penetration by a *fire stop* that, when subjected to the fire test method in CAN/ULC-S115, "Fire Tests of Firestop Systems," has an FT rating not less than the *fire-resistance rating* for the *fire separation*.
- 3) Except as provided in Sentences (4) to (12) and Article 9.10.9.7., pipes, ducts, electrical boxes, totally enclosed raceways or other similar service equipment that partly or wholly penetrate an assembly required to have a *fire-resistance rating* shall be *noncombustible* unless the assembly has been tested incorporating such equipment. (See Note A-3.1.9.2.(1).)
- 4) Electrical wires or similar wiring enclosed in *noncombustible* totally enclosed raceways are permitted to partly or wholly penetrate an assembly required to have a *fire-resistance rating* without being incorporated in the assembly at the time of testing as required in Sentence (3).
- 5) Single conductor metal-sheathed cables with *combustible* jacketting that are more than 25 mm in overall diameter are permitted to penetrate a *fire separation* required to have a *fire-resistance rating* without being incorporated in the assembly at the time of testing as required in Sentence (3), provided the cables are not grouped and are spaced a minimum of 300 mm apart.
- 6) Electrical wires or cables, single or grouped, with *combustible* insulation or jacketting that is not totally enclosed in raceways of *noncombustible* material, are permitted to partly or wholly penetrate an assembly required to have a *fire-resistance rating* without being incorporated in the assembly at the time of testing as required in Sentence (3), provided the overall diameter of the wiring is not more than 25 mm.
- 7) *Combustible* totally enclosed raceways which are embedded in a concrete floor slab are permitted in an assembly required to have a *fire-resistance rating* without being incorporated in the assembly at the time of testing as required in Sentence (3), where the concrete provides not less than 50 mm of cover between the raceway and the bottom of the slab.
- 8) *Combustible* outlet boxes are permitted in an assembly required to have a *fire-resistance rating* without being incorporated in the assembly at the time of testing as required in Sentence (3), provided the opening through the membrane into the box does not exceed 160 cm<sup>2</sup>.
- 9) *Combustible* water distribution piping is permitted to partly or wholly penetrate a *fire separation* that is required to have a *fire-resistance rating* without being incorporated in the assembly at the time of testing as required in Sentence (3), provided the piping is protected with a *fire stop* in conformance with Sentence 3.1.9.5.(4).

**10)** *Combustible* sprinkler piping is permitted to penetrate a *fire separation* provided the *fire compartments* on each side of the *fire separation* are *sprinklered*.

**11)** Sprinklers are permitted to penetrate a *fire separation* or a membrane forming part of an assembly required to have a *fire-resistance rating* without having to meet the *fire stop* requirements of Sentence (1), provided the annular space created by the penetration of a fire sprinkler is covered by a metal escutcheon plate in accordance with NFPA 13, "Installation of Sprinkler Systems."

**12)** *Combustible* piping for central vacuum systems is permitted to penetrate a *fire separation* provided the installation conforms to the requirements that apply to *combustible* drain, waste and vent piping specified in Sentences 9.10.9.7.(2) to (6).

**13)** *Fire dampers* are permitted to penetrate a *fire separation* or a membrane forming part of an assembly required to have a *fire-resistance rating* without having to meet the *fire stop* requirements of Sentence (1), provided the *fire damper* is

- a) installed in conformance with NFPA 80, "Fire Doors and Other Opening Protectives," or
- b) specifically designed with a *fire stop*.

#### 9.10.9.7. Combustible Drain, Waste and Vent Piping

(See Note A-3.1.9.)

**1)** Except as permitted in Sentences (2) to (6), *combustible* piping shall not be used in any part of a drain, waste and vent piping system where any part of that system partly or wholly penetrates a *fire separation* required to have a *fire-resistance rating* or penetrates a membrane that contributes to the required *fire-resistance rating* of an assembly.

**2)** *Combustible* drain, waste and vent piping not located in a vertical shaft is permitted to penetrate a *fire separation* required to have a *fire-resistance rating* or a membrane that forms part of an assembly required to have a *fire-resistance rating* provided the piping is sealed at the penetration by a *fire stop* that has an F rating not less than the *fire-resistance rating* required for the *fire separation*.

**3)** The rating referred to in Sentence (2) shall be based on CAN/ULC-S115, "Fire Tests of Firestop Systems," with a pressure differential of 50 Pa between the exposed and unexposed sides, with the higher pressure on the exposed side.

**4)** *Combustible* drain piping is permitted to penetrate a horizontal *fire separation* or a membrane that contributes to the required *fire-resistance rating* of a horizontal *fire separation*, provided it leads directly from a *noncombustible* watercloset through a concrete floor slab.

**5)** *Combustible* drain, waste and vent piping is permitted on one side of a vertical *fire separation* provided it is not located in a vertical shaft.

**6)** In *buildings* containing 2 *dwelling units* only, *combustible* drain, waste and vent piping is permitted on one side of a horizontal *fire separation*.

#### 9.10.9.8. Collapse of Combustible Construction

**1)** *Combustible construction* that abuts on or is supported by a *noncombustible fire separation* shall be constructed so that its collapse under fire conditions will not cause collapse of the *fire separation*.

#### 9.10.9.9. Reduction in Thickness of Fire Separation by Beams and Joists

**1)** Where pockets for the support of beams or joists are formed in a masonry or concrete *fire separation*, the remaining total thickness of masonry and/or grout and/or concrete shall be not less than the required equivalent thickness shown for Type S monolithic concrete in Table D-2.1.1. in Appendix D for the required *fire-resistance rating*.

**9.10.9.10. Concealed Spaces above Fire Separations**

**1)** Except as provided in Sentence (2), a *horizontal service space* or other concealed space located above a required vertical *fire separation* shall be divided at the *fire separation* by an equivalent *fire separation* within the space.

**2)** Where a *horizontal service space* or other concealed space is located above a required vertical *fire separation* other than a vertical shaft, such space need not be divided as required in Sentence (1) provided the construction between such space and the space below is constructed as a *fire separation* having a *fire-resistance rating* not less than that required for the vertical *fire separation*, except that where the vertical *fire separation* is not required to have a *fire-resistance rating* greater than 45 min, the *fire-resistance rating* of the ceiling may be reduced to 30 min.

**9.10.9.11. Separation of Residential Occupancies**

**1)** Except as provided in Sentence (2), *residential occupancies* shall be separated from all other *major occupancies* by a *fire separation* having a *fire-resistance rating* of not less than 1 h.

**2)** Except as provided in Sentence (3), a *major occupancy* classified as a *residential occupancy* shall be separated from other *major occupancies* classified as *mercantile* or *medium-hazard industrial occupancies* by a *fire separation* having a *fire-resistance rating* of not less than 2 h.

**3)** Where not more than 2 *dwelling units* are located in a *building* containing a *mercantile occupancy*, such *mercantile occupancy* shall be separated from the *dwelling units* by a *fire separation* having not less than 1 h *fire-resistance rating*.

**9.10.9.12. Residential Suites in Industrial Buildings**

**1)** Not more than one *suite of residential occupancy* shall be contained within a *building* classified as a Group F, Division 2 *major occupancy*.

**9.10.9.13. Separation of Suites**

**1)** Except as required in Article 9.10.9.14. and as permitted by Sentence (2), each *suite* in other than *business and personal services occupancies* shall be separated from adjoining *suites* by a *fire separation* having a *fire-resistance rating* of not less than 45 min.

**2)** In *sprinklered buildings*, *suites of business and personal services occupancy* and *mercantile occupancy* that are served by *public corridors* conforming with Clause 3.3.1.4.(4)(b) are not required to be separated from each other by *fire separations*.

**9.10.9.14. Separation of Residential Suites**

**1)** Except as provided in Sentences (2), (3) and (4) and Article 9.10.21.2., *suites* in *residential occupancies* shall be separated from adjacent rooms and *suites* by a *fire separation* having a *fire-resistance rating* of not less than 45 min.

**2)** Sleeping rooms in boarding and lodging houses where sleeping accommodation is provided for not more than 8 boarders or lodgers need not be separated from the remainder of the *floor area* as required in Sentence (1) where the sleeping rooms form part of the proprietor's residence and do not contain cooking facilities.

**3)** Except as provided in Sentence (4), *dwelling units* that contain 2 or more *storeys* including *basements* shall be separated from the remainder of the *building* by a *fire separation* having a *fire-resistance rating* of not less than 1 h. (See Note A-3.3.4.4.(1).)

**4)** Walls and floor-ceiling framing in a house with a *secondary suite* that separate *dwelling units* from each other or *dwelling units* from ancillary spaces and common spaces need not comply with Sentence (1), where the walls and floor-ceiling framing are protected by a continuous smoke-tight barrier of not less than 12.7 mm thick gypsum board installed on

- a) both sides of walls, and
- b) the underside of floor-ceiling framing.

(See Sentence 9.10.9.3.(2) for  *closures*.)

**9.10.9.15. Separation of Public Corridors**

**1)** Except as provided in Sentences (2), (3) and (4), *public corridors* shall be separated from the remainder of the *building* by a *fire separation* having not less than a 45 min *fire-resistance rating*.

**2)** In other than *residential occupancies*, no *fire-resistance rating* is required for *fire separations* between a *public corridor* and the remainder of the *building* if

- a) the *floor area* is *sprinklered*,
- b) the sprinkler system is electrically supervised in conformance with Sentence 3.2.4.9.(3), and
- c) the operation of the sprinkler system will cause a signal to be transmitted to the fire department in conformance with Sentence 3.2.4.7.(4).

**3)** In other than *residential occupancies*, no *fire separation* is required between a *public corridor* and the remainder of the *building* if

- a) the *floor area* is *sprinklered*,
- b) the sprinkler system is electrically supervised in conformance with Sentence 3.2.4.9.(3),
- c) the operation of the sprinkler system will cause a signal to be transmitted to the fire department in conformance with Sentence 3.2.4.7.(4), and
- d) the corridor exceeds 5 m in width.

**4)** Where a *public corridor* is located in a house with a *secondary suite*, a continuous smoke-tight barrier of not less than 12.7 mm thick gypsum board shall be installed on

- a) both sides of walls separating the corridor from the remainder of the *building*, and
- b) the underside of floor-ceiling framing separating the corridor from the remainder of the *building*.

(See Sentence 9.10.9.3.(2) for *closures*.)

**9.10.9.16. Separation of Storage Garages**

**1)** Except as provided in Sentences (2) and (3), a *storage garage* shall be separated from other *occupancies* by a *fire separation* having not less than a 1.5 h *fire-resistance rating*.

**2)** Except as permitted in Sentence (3), *storage garages* containing 5 motor vehicles or fewer shall be separated from other *occupancies* by a *fire separation* of not less than 1 h.

**3)** Where a *storage garage* serves only the *dwelling unit* to which it is attached or in which it is built, it shall be considered as part of that *dwelling unit* and the *fire separation* required in Sentence (2) need not be provided between the garage and the *dwelling unit*.

**4)** Except as provided in Sentence (5), where a *storage garage* is attached to or built into a *building of residential occupancy*,

- a) an *air barrier system* conforming to Subsection 9.25.3. shall be installed between the garage and the remainder of the *building* to provide an effective barrier to gas and exhaust fumes, and
- b) every door between the garage and the remainder of the *building* shall conform to Article 9.10.13.15.

(See Note A-9.10.9.16.(4).)

**5)** Where membrane materials are used to provide the required airtightness in the *air barrier system*, all joints shall be sealed and structurally supported.

**9.10.9.17. Separation of Repair Garages**

**1)** Except as provided in Sentences (2) and (3), a *repair garage* shall be separated from other *occupancies* by a *fire separation* having a *fire-resistance rating* of not less than 2 h.

**2)** Ancillary spaces directly serving a *repair garage*, including waiting rooms, reception rooms, tool and parts storage areas and supervisory office space, need not be separated from the *repair garage* but shall be separated from other *occupancies* as required in Sentence (1).



**3)** The *fire separation* referred to in Sentence (1) shall have a *fire-resistance rating* of not less than 1 h, where

- a) the *building* is not more than one *storey* in *building height*,
- b) the *building* is operated as a single *suite*, and
- c) the only *occupancy* other than the *repair garage* is a *mercantile occupancy*.

**4)** Except as provided in Sentence (5), where a *building* containing a *repair garage* also contains a *dwelling unit*, an *air barrier system* conforming to Subsection 9.25.3. shall be installed between the *dwelling unit* and the *suite* containing the garage to provide an effective barrier to gas and exhaust fumes. (See Note A-9.10.9.16.(4).)

**5)** Where membrane materials are used to provide the required airtightness in the *air barrier system*, all joints shall be sealed and structurally supported.

#### 9.10.9.18. Exhaust Ducts Serving More Than One Fire Compartment

**1)** Where a *vertical service space* contains an *exhaust duct* that serves more than one *fire compartment*, the duct shall have a fan located at or near the exhaust outlet to ensure that the duct is under negative pressure.

**2)** Individual *fire compartments* referred to in Sentence (1) shall not have fans that exhaust directly into the duct in the *vertical service space*.

#### 9.10.9.19. Central Vacuum Systems

**1)** A central vacuum system shall serve not more than one *suite*.

#### 9.10.10. Service Rooms

##### 9.10.10.1. Application

**1)** This Subsection applies to *service rooms* in all *buildings* except rooms located within a *dwelling unit*.

##### 9.10.10.2. Service Room Floors

**1)** The *fire-resistance rating* requirements in this Subsection do not apply to the floor assembly immediately below a *service room*.

##### 9.10.10.3. Separation of Service Rooms

**1)** Except as provided in Sentence (2) and Articles 9.10.10.5. and 9.10.10.6., *service rooms* shall be separated from the remainder of the *building* by a *fire separation* having a *fire-resistance rating* of not less than 1 h when the *floor area* containing the *service room* is not *sprinklered*.

**2)** Where a room contains a limited quantity of service equipment and the service equipment does not constitute a fire hazard, the requirements in Sentence (1) shall not apply.

##### 9.10.10.4. Location of Fuel-Fired Appliances

**1)** Except as provided in Sentences (2) and (3) and Article 9.10.10.5., fuel-fired *appliances* shall be located in a *service room* separated from the remainder of the *building* by a *fire separation* having not less than a 1 h *fire-resistance rating*.

**2)** Except as required in the *appliance* installation standards referenced in Sentences 6.2.1.5.(1), 9.33.5.2.(1) and 9.33.5.3.(1), fuel-fired *space-heating appliances*,

space-cooling *appliances*, *service water heaters* and laundry *appliances* need not be separated from the remainder of the *building* as required in Sentence (1),

- a) where the *appliances* serve
  - i) not more than one room or *suite*, or
  - ii) a *building* with a *building area* of not more than 400 m<sup>2</sup> and a *building height* of not more than 2 *storeys*, or
- b) where the *appliances*
  - i) serve a house with a *secondary suite* including their common spaces, and
  - ii) are located in a *service room* where both sides of any wall assemblies and the underside of any floor-ceiling framing separating this room from both *dwelling units* or their common spaces are protected by a continuous smoke-tight barrier consisting of not less than 12.7 mm thick gypsum board.

3) Sentence (1) does not apply to fireplaces and cooking *appliances*.

#### 9.10.10.5. Incinerators

1) *Service rooms* containing incinerators shall be separated from the remainder of the *building* by a *fire separation* having a *fire-resistance rating* of not less than 2 h.

2) The design, construction, installation and *alteration* of each indoor incinerator shall conform to NFPA 82, "Incinerators and Waste and Linen Handling Systems and Equipment."

3) Every incinerator shall be connected to a *chimney flue* conforming to the requirements in Section 9.21. and serving no other *appliance*.

4) An incinerator shall not be located in a room with other fuel-fired *appliances*.

#### 9.10.10.6. Storage Rooms

1) Rooms for the temporary storage of *combustible* refuse in all *occupancies* or for public storage in *residential occupancies* shall be separated from the remainder of the *building* by a *fire separation* having not less than a 1 h *fire-resistance rating*, except that a 45 min *fire separation* is permitted where the *fire-resistance rating* of the floor assembly is not required to exceed 45 min, or where such rooms are *sprinklered*.

#### 9.10.11. Firewalls

##### 9.10.11.1. Required Firewalls

1) Except as provided in Article 9.10.11.2., a *party wall* on a property line shall be constructed as a *firewall*. (See Note A-3.2.3.4.(1).)

##### 9.10.11.2. Firewalls Not Required

1) Except as stated in Sentence (2), a *party wall* on a property line of a *building* of *residential occupancy* need not be constructed as a *firewall*, provided it is constructed as a *fire separation* having not less than a 1 h *fire-resistance rating*, where the *party wall* separates

- a) two *dwelling units* where there is no *dwelling unit* above another *dwelling unit*,
- b) a *dwelling unit* and a house with a *secondary suite* including their common spaces, or
- c) two houses with a *secondary suite* including their common spaces.

2) Where a *building* of *residential occupancy* contains more than 2 houses, a *party wall* that separates any 2 adjacent houses with a *secondary suite* from the rest of the *building* shall be constructed as a *firewall* to create separate *buildings* each containing no more than 2 adjacent houses with a *secondary suite*.

3) The wall described in Sentence (1) shall provide continuous protection from the top of the footings to the underside of the roof deck.

4) Any space between the top of the wall described in Sentence (1) and the roof deck shall be tightly filled with mineral wool or *noncombustible* material.

#### 9.10.11.3. Construction of Firewalls

1) Where *firewalls* are used, the requirements in Part 3 shall apply.

### 9.10.12. Prevention of Fire Spread at Exterior Walls and between Storeys

#### 9.10.12.1. Termination of Floors or Mezzanines

1) Except as provided in Sentence (2) and in Articles 9.10.1.3. and 9.10.9.5., the portions of a *floor area* or *mezzanine* that do not terminate at an exterior wall, a *firewall* or a vertical shaft, shall terminate at a vertical *fire separation* having a *fire-resistance rating* not less than that required for the floor assembly that terminates at the separation.

2) A *mezzanine* need not terminate at a vertical *fire separation* where the *mezzanine* is not required to be considered as a *storey* in Articles 9.10.4.1. and 9.10.4.2.

#### 9.10.12.2. Location of Skylights

1) Where a wall in a *building* is exposed to a fire hazard from an adjoining roof of a separate un sprinklered *fire compartment* in the same *building*, the roof shall contain no skylights within a horizontal distance of 5 m of the windows in the exposed wall.

#### 9.10.12.3. Exterior Walls Meeting at an Angle

1) Except as provided in Article 9.9.4.5., where exterior walls of a *building* meet at an external angle of 135° or less, the horizontal distance from an *unprotected opening* in one exterior wall to an *unprotected opening* in the other exterior wall shall be not less than 1.2 m, where these openings are

- a) in different *fire compartments*, or
- b) in different *dwelling units*, ancillary spaces or common spaces in a house with a *secondary suite*.

2) Except as provided in Sentence (3), the exterior wall of each *fire compartment* referred to in Sentence (1) within the 1.2 m distance shall have a *fire-resistance rating* not less than that required for the interior vertical *fire separation* between the compartment and the remainder of the *building*.

3) Where interior walls between *dwelling units*, ancillary spaces or common spaces in a house with a *secondary suite* are not constructed as *fire separations*, the exterior wall of each *dwelling unit*, ancillary space or common space referred to in Sentence (1) within the 1.2 m distance shall be finished on the interior with not less than 12.7 mm thick gypsum board.

#### 9.10.12.4. Protection of Soffits

1) This Article applies to the portion of any soffit enclosing a projection that is

- a) less than 2.5 m vertically above a window or door, and
- b) less than 1.2 m from either side of the window or door.

(See Note A-9.10.12.4.(1).)

2) Except as provided in Sentences (4) and (5), the construction described in Sentence (1) shall have no *unprotected openings* and shall be protected in accordance with Sentence (3), where the soffit encloses

- a) a common *attic* or *roof space* that spans more than 2 *suites* of residential occupancy and projects beyond the exterior wall of the *building*,

- b) a floor space where an upper *storey* projects beyond the exterior wall of a lower *storey* and
    - i) a *fire separation* is required at the floor between the two, or
    - ii) the floor separates *dwelling units* from each other or a *dwelling unit* from an ancillary space or a common space in a house with a *secondary suite*, or
  - c) a floor space where an upper *storey* projects beyond the exterior wall of a lower *storey*, and the projection is continuous across
    - i) a vertical *fire separation* separating two *suites*, or
    - ii) a wall separating *dwelling units* from each other or a *dwelling unit* from an ancillary space or a common space in a house with a *secondary suite*.
- 3)** Protection required by Sentence (2) shall be provided by
- a) *noncombustible* material having a minimum thickness of 0.38 mm and a melting point not below 650°C,
  - b) not less than 12.7 mm thick gypsum soffit board or gypsum board installed according to CSA A82.31-M, "Gypsum Board Application,"
  - c) not less than 11 mm thick plywood,
  - d) not less than 12.5 mm thick OSB or waferboard, or
  - e) not less than 11 mm thick lumber.

(See Note A-9.10.12.4.(3).)

**4)** In the case of a soffit described in Sentence (1) that is at the edge of an *attic* or *roof space* and completely separated from the remainder of that *attic* or *roof space* by *fire blocks*, the requirements in Sentence (2) do not apply.

**5)** Where all *suites* spanned by a common *attic* or *roof space* or situated above or below the projecting floor are *sprinklered*, the requirements of Sentence (2) do not apply, provided that all rooms, including closets and bathrooms, having openings in the wall beneath the soffit are *sprinklered*, notwithstanding any exceptions in the sprinkler standards referenced in Article 3.2.5.12.

**9.10.13. Doors, Dampers and Other Closures in Fire Separations**

**9.10.13.1. Closures**

**1)** Except as provided in Article 9.10.13.2., openings in required *fire separations* shall be protected with a *closure* conforming to Table 9.10.13.1. and shall be installed in conformance with Chapters 2 to 14 of NFPA 80, "Fire Doors and Other Opening Protectives," unless otherwise specified herein. (See also Article 9.10.3.1.)

**Table 9.10.13.1.**  
**Fire-Protection Ratings for Closures**  
 Forming Part of Sentence 9.10.13.1.(1)

Required <i>Fire-Resistance Rating</i> of <i>Fire Separation</i>	Minimum <i>Fire-Protection Rating</i> of <i>Closure</i>
30 or 45 min	20 min <sup>(1)</sup>
1 h	45 min <sup>(1)</sup>
1.5 h	1 h
2 h	1.5 h
3 h	2 h
4 h	3 h

**Notes to Table 9.10.13.1.:**

(1) See Article 9.10.13.2.

**9.10.13.2. Solid Core Wood Door as a Closure**

**1)** A 45 mm thick solid core wood door is permitted to be used where a minimum *fire-protection rating* of 20 min is permitted or between a *public corridor* and a *suite*

provided that the door conforms to CAN/ULC-S113, "Wood Core Doors Meeting the Performance Required by CAN/ULC-S104 for Twenty Minute Fire Rated Closure Assemblies." (See Note A-9.10.13.2.(1).)

**2)** Doors described in Sentence (1) shall have not more than a 6 mm clearance beneath and not more than 3 mm at the sides and top.

#### **9.10.13.3. Unrated Wood Door Frames**

**1)** Doors required to provide a 20 min *fire-protection rating* or permitted to be 45 mm solid core wood shall be mounted in a wood frame of not less than 38 mm thickness where the frame has not been tested and rated.

#### **9.10.13.4. Doors as a Means of Egress**

**1)** Doors forming part of an *exit* or a public *means of egress* shall conform to Subsection 9.9.6. in addition to this Subsection.

#### **9.10.13.5. Wired Glass as a Closure**

**1)** Wired glass conforming to Article 9.6.1.2. which has not been tested in accordance with Article 9.10.3.1. is permitted as a *closure* in a vertical *fire separation* required to have a *fire-resistance rating* of not more than 1 h provided such glass is not less than 6 mm thick and is mounted in conformance with Sentence (2).

**2)** Wired glass described in Sentence (1) shall be mounted in fixed steel frames having a metal thickness of not less than 1.35 mm and a glazing stop of not less than 20 mm on each side of the glass.

**3)** Individual panes of glass described in Sentence (1) shall not exceed 0.8 m<sup>2</sup> in area or 1.4 m in height or width, and the area of glass not structurally supported by mullions shall not exceed 7.5 m<sup>2</sup>.

#### **9.10.13.6. Steel Door Frames**

**1)** Steel door frames forming part of a *closure* in a *fire separation*, including anchorage requirements, shall conform to CAN/ULC-S105, "Fire Door Frames Meeting the Performance Required by CAN/ULC-S104."

#### **9.10.13.7. Glass Block as a Closure**

**1)** Glass block that has not been tested in accordance with Article 9.10.3.1. is permitted as a *closure* in a *fire separation* required to have a *fire-resistance rating* of not more than 1 h. (See Article 9.20.9.6.)

#### **9.10.13.8. Maximum Size of Opening**

**1)** The size of an opening in an interior *fire separation*, even where protected with a *closure*, shall not exceed 11 m<sup>2</sup>, with no dimension greater than 3.7 m, when the *fire compartments* on both sides of the *fire separation* are not *sprinklered*.

**2)** The size of an opening in an interior *fire separation*, even where protected with a *closure*, shall not exceed 22 m<sup>2</sup>, with no dimension greater than 6 m, when the *fire compartments* on both sides of the *fire separation* are *sprinklered*.

#### **9.10.13.9. Door Latch**

**1)** Every swing type door in a *fire separation* shall be equipped with a latch.

#### **9.10.13.10. Self-closing Device**

**1)** Except as described in Sentence (2), every door in a *fire separation* shall have a self-closing device.

**2)** Self-closing doors are not required between *public corridors* and *suites in business and personal services occupancies*, except in dead-end corridors.

**9.10.13.11. Hold-Open Devices**

1) Where hold-open devices are used on doors in required *fire separations*, they shall be installed in accordance with Article 3.1.8.14.

**9.10.13.12. Service Room Doors**

1) Swing-type doors shall open into *service rooms* containing fuel-fired equipment where such doors lead to *public corridors* or rooms used for assembly but shall swing outward from such rooms in all other cases.

**9.10.13.13. Fire Dampers**

1) Except as permitted by Sentences (2) to (5) and Sentence 9.10.5.1.(4), a duct that penetrates an assembly required to be a *fire separation* with a *fire-resistance rating* shall be equipped with a *fire damper* in conformance with Articles 3.1.8.4. and 3.1.8.10.

2) A *fire damper* is not required where a *noncombustible* branch duct pierces a required *fire separation* provided the duct

- a) has a melting point not below 760°C,
- b) has a cross-sectional area less than 130 cm<sup>2</sup>, and
- c) supplies only air-conditioning units or combined air-conditioning and heating units discharging air at not more than 1.2 m above the floor.

3) A *fire damper* is not required where a *noncombustible* branch duct pierces a required *fire separation* around an *exhaust duct* riser in which the airflow is upward provided

- a) the melting point of the branch duct is not below 760°C,
- b) the branch duct is carried up inside the riser not less than 500 mm, and
- c) the *exhaust duct* is under negative pressure as described in Article 9.10.9.18.

4) *Noncombustible* ducts that penetrate a *fire separation* separating a *vertical service space* from the remainder of the *building* need not be equipped with a *fire damper* at the *fire separation* provided

- a) the ducts have a melting point above 760°C, and
- b) each individual duct exhausts directly to the outside at the top of the *vertical service space*.

5) A duct serving commercial cooking equipment and piercing a required *fire separation* need not be equipped with a *fire damper* at the *fire separation*. (See also Article 6.3.1.7.)

**9.10.13.14. Fire Stop Flaps**

1) *Fire stop flaps* in ceiling membranes referred to in Sentence 9.10.5.1.(4) shall

- a) conform to CAN/ULC-S112.2, "Fire Test of Ceiling Firestop Flap Assemblies," and
- b) activate at a temperature approximately 30°C above the normal maximum temperature that occurs in the ducts, whether the air duct system is operating or shut down.

**9.10.13.15. Doors between Garages and Dwelling Units**

1) A door between an attached or built-in garage and a *dwelling unit* shall be tight fitting and weather-stripped to provide an effective barrier against the passage of gas and exhaust fumes and shall be fitted with a self-closing device.

2) A doorway between an attached or built-in garage and a *dwelling unit* shall not be located in a room intended for sleeping.

**9.10.13.16. Door Stops**

1) Where a door is installed so that it may damage the integrity of a *fire separation* if its swing is unrestricted, door stops shall be installed to prevent such damage.

**9.10.14. Spatial Separation Between Buildings****9.10.14.1. Application**

**1)** This Subsection applies to *buildings* other than those to which Subsection 9.10.15. applies.

**9.10.14.2. Area and Location of Exposing Building Face**

- 1)** The area of an *exposing building face* shall be
- a) taken as the exterior wall area facing in one direction on any side of a *building*, and
  - b) calculated as
    - i) the total area measured from the finished ground level to the uppermost ceiling, or
    - ii) the area for each *fire compartment*, where a *building* is divided into *fire compartments* by *fire separations* with *fire-resistance ratings* not less than 45 min.

**2)** For the purpose of using Table 9.10.14.4.-A to determine the maximum aggregate area of *unprotected openings* in an irregularly shaped or skewed exterior wall, the location of the *exposing building face* shall be taken as a vertical plane located so that there are no *unprotected openings* between the vertical plane and the line to which the *limiting distance* is measured. (See Note A-3.2.3.1.(4).)

**3)** For the purpose of using Table 9.10.14.5.-A to determine the required type of construction, cladding and *fire-resistance rating* for an irregularly shaped or skewed exterior wall,

- a) the location of the *exposing building face* shall be taken as a vertical plane located so that no portion of the actual *exposing building face* is between the vertical plane and the line to which the *limiting distance* is measured, and
- b) the value for the maximum area of *unprotected openings* (see second column of Table 9.10.14.5.-A) shall be determined using the *limiting distance* measured from the location described in Clause (a). (See Note A-3.2.3.1.(4).)

**9.10.14.3. Limiting Distance and Fire Department Response**

**1)** Except for the purpose of applying Sentences 9.10.14.4.(2), (3), (8) and (9), and Sentences 9.10.14.5.(3), (8) and (13), a *limiting distance* equal to half the actual *limiting distance* shall be used as input to the requirements of this Subsection, where

- a) the time from receipt of notification of a fire by the fire department until the first fire department vehicle arrives at the *building* exceeds 10 min in 10% or more of all calls to the *building*, and
- b) any *storey* in the *building* is not *sprinklered*.

(See Notes A-3.2.3. and A-3.2.3.1.(8).)

**9.10.14.4. Openings in Exposing Building Face**

**1)** Except as provided in Sentences (6) to (10), the maximum aggregate area of *unprotected openings* in an *exposing building face* shall

- a) conform to Table 9.10.14.4.-A,
- b) conform to Subsection 3.2.3., or
- c) where the *limiting distance* is not less than 1.2 m, be equal to or less than
  - i) the *limiting distance* squared, for *residential occupancies*, *business and personal services occupancies* and *low-hazard industrial occupancies*, and
  - ii) half the *limiting distance* squared, for *mercantile occupancies* and *medium-hazard industrial occupancies*.

**Table 9.10.14.4.-A**  
**Maximum Aggregate Area of Unprotected Openings in Exterior Walls<sup>(1)</sup>**  
 Forming Part of Sentence 9.10.14.4.(1)

Occupancy Classification of Building	Maximum Total Area of Exposing Building Face, m <sup>2</sup>	Maximum Aggregate Area of <i>Unprotected Openings</i> , % of <i>Exposing Building Face Area</i>											
		Limiting Distance, m											
		Less than 1.2	1.2	1.5	2.0	4.0	6.0	8.0	10.0	12.0	16.0	20.0	25.0
<i>Residential, business and personal services, and low-hazard industrial</i>	30	0	7	9	12	39	88	100	—	—	—	—	—
	40	0	7	8	11	32	69	100	—	—	—	—	—
	50	0	7	8	10	28	57	100	—	—	—	—	—
	100	0	7	8	9	18	34	56	84	100	—	—	—
	Over 100	0	7	7	8	12	19	28	40	55	92	100	—
<i>Mercantile and medium-hazard industrial</i>	30	0	4	4	6	20	44	80	100	—	—	—	—
	40	0	4	4	6	16	34	61	97	100	—	—	—
	50	0	4	4	5	14	29	50	79	100	—	—	—
	100	0	4	4	4	9	17	28	42	60	100	—	—
	Over 100	0	4	4	4	6	10	14	20	27	46	70	100

**Notes to Table 9.10.14.4.-A:**

(1) See also Sentences (6) and (7) to calculate the maximum permitted area of *unprotected openings* in *sprinklered buildings* or where wired glass or glass blocks are used.

**2)** Openings in a wall having a *limiting distance* of less than 1.2 m shall be protected by *closures*, of other than wired glass or glass block, whose *fire-protection rating* is in conformance with the *fire-resistance rating* required for the wall. (See Table 9.10.13.1.)

**3)** Except for *buildings* that are *sprinklered* and for openable windows having an unobstructed opening equal to 0.35 m<sup>2</sup> installed in accordance with Sentences 9.9.10.1.(1) and (2), where the *limiting distance* is 2 m or less, individual *unprotected openings* shall be no greater than

- a) the area stated in Table 9.10.14.4.-B, or
- b) where the *limiting distance* is equal to or greater than 1.2 m, the area calculated by

$$\text{Area} = 0.24(2 \times \text{LD} - 1.2)^2$$

where

Area = area of the *unprotected opening*, and

LD = *limiting distance*.

**Table 9.10.14.4.-B**  
**Maximum Concentrated Area of Unprotected Openings**  
 Forming Part of Sentence 9.10.14.4.(3)

Limiting Distance, m	Maximum Area of Individual <i>Unprotected Openings</i> , m <sup>2</sup>
1.2	0.35
1.5	0.78
2.0	1.88



- 4)** The spacing between individual *unprotected openings* described in Sentence (3) that serve a single room or space described in Sentence (5) shall be not less than
- 2 m horizontally of another *unprotected opening* that is on the same *exposing building face* and serves the single room or space, or
  - 2 m vertically of another *unprotected opening* that serves the single room or space, or another room or space on the same *storey*.
- 5)** For the purpose of Sentence (4), “single room or space” shall mean
- two or more adjacent spaces having a full-height separating wall extending less than 1.5 m from the interior face of the exterior wall, or
  - two or more stacked spaces that are on the same *storey*.
- 6)** The maximum aggregate area of *unprotected openings* shall be not more than twice the area determined according to Sentence (1), where the *unprotected openings* are glazed with
- wired glass in steel frames, as described in Article 9.10.13.5., or
  - glass blocks, as described in Article 9.10.13.7.
- 7)** Where the *building* is *sprinklered*, the maximum aggregate area of *unprotected openings* shall be not more than twice the area determined according to Sentence (1), provided all rooms, including closets and bathrooms, that are adjacent to the *exposing building face* and that have *unprotected openings* are *sprinklered*, notwithstanding any exemptions in the sprinkler standards referenced in Article 3.2.5.12.
- 8)** The maximum aggregate area of *unprotected openings* in an *exposing building face* of a *storage garage* need not comply with Sentence (1), where
- all *storeys* are constructed as *open-air storeys*, and
  - the *storage garage* has a *limiting distance* of not less than 3 m.
- 9)** The maximum aggregate area of *unprotected openings* in an *exposing building face* of a *storey* that faces a *street* and is at the same level as the *street* need not comply with Sentence (1), where the *limiting distance* is not less than 9 m.
- 10)** Except as provided in Sentence (11), for garages or accessory *buildings* that serve a single *dwelling unit* only and are detached from any *building*, the maximum aggregate area of glazed openings shall comply with the requirements for *unprotected openings*.
- 11)** The limits on the area of glazed openings stated in Sentence (10) need not apply to the *exposing building face* of a detached garage or accessory *building* facing a *dwelling unit*, where
- the detached garage or accessory *building* serves only one *dwelling unit*,
  - the detached garage or accessory *building* is located on the same property as that *dwelling unit*, and
  - the *dwelling unit* served by the detached garage or accessory *building* is the only *major occupancy* on the property.

#### **9.10.14.5. Construction of Exposing Building Face and Walls above Exposing Building Face**

- 1)** Except as permitted in Sentences (3) to (14), each *exposing building face* and any exterior wall located above an *exposing building face* that encloses an *attic* or *roof space* shall be constructed in conformance with Table 9.10.14.5.-A. (See Note A-9.10.14.5.(1).) (See also Subsection 9.10.8.)

**Table 9.10.14.5-A**  
**Minimum Construction Requirements for Exposing Building Faces**  
 Forming Part of Sentence 9.10.14.5.(1)

<i>Occupancy Classification of Building or Fire Compartment</i>	<i>Maximum Area of Unprotected Openings Permitted, % of Exposing Building Face Area</i>	<i>Minimum Required Fire-Resistance Rating</i>	<i>Type of Construction Required</i>	<i>Type of Cladding Required</i>
<i>Residential, business and personal services, and low-hazard industrial</i>	0 to 10	1 h	<i>Noncombustible</i>	<i>Noncombustible</i>
	> 10 to 25	1 h	<i>Combustible or noncombustible</i>	<i>Noncombustible</i>
	> 25 to 50	45 min	<i>Combustible or noncombustible</i>	<i>Noncombustible</i>
	> 50 to < 100	45 min	<i>Combustible or noncombustible</i>	<i>Combustible or noncombustible</i>
<i>Mercantile and medium-hazard industrial</i>	0 to 10	2 h	<i>Noncombustible</i>	<i>Noncombustible</i>
	> 10 to 25	2 h	<i>Combustible or noncombustible</i>	<i>Noncombustible</i>
	> 25 to 50	1 h	<i>Combustible or noncombustible</i>	<i>Noncombustible</i>
	> 50 to < 100	1 h	<i>Combustible or noncombustible</i>	<i>Combustible or noncombustible</i>

**2)** Except as provided in Sentences (3) to (8), cladding on *exposing building faces* and exterior walls located above *exposing building faces* that enclose an *attic or roof space*, for *buildings or fire compartments* where the maximum permitted area of *unprotected openings* is more than 10% of the *exposing building face*, need not be *noncombustible* where the wall assembly complies with the requirements of Clause 3.1.5.5.(1)(b) when tested in conformance with CAN/ULC-S134, "Fire Test of Exterior Wall Assemblies."

**3)** Except as provided in Sentences (4) to (8) and permitted by Sentence (9), cladding on *exposing building faces* and on exterior walls located above *exposing building faces* of *buildings or fire compartments* where the maximum permitted area of *unprotected openings* is more than 25% but not more than 50% of the *exposing building face* need not be *noncombustible*, where

- a) the *limiting distance* is greater than 5.0 m,
- b) the *limiting distance* is greater than 2.5 m where the area and width-to-height ratio of the *exposing building face* conform to Table 9.10.14.5.-B,
- c) the *building or fire compartment* is *sprinklered*,
- d) the cladding
  - i) conforms to Subsections 9.27.6., 9.27.7., 9.27.8. or 9.27.9.,
  - ii) is installed without furring members, or on furring not more than 25 mm thick, over gypsum sheathing at least 12.7 mm thick or over masonry, and
  - iii) after conditioning in conformance with ASTM D 2898, "Accelerated Weathering of Fire-Retardant-Treated Wood for Fire Testing," has a *flame-spread rating* not greater than 25 when tested in accordance with Sentence 3.1.12.1.(2), or
- e) the cladding
  - i) conforms to Subsection 9.27.12.,
  - ii) is installed with or without furring members over a gypsum sheathing at least 12.7 mm thick or over masonry,
  - iii) has a *flame-spread rating* not greater than 25 when tested in accordance with Sentence 3.1.12.1.(2), and
  - iv) does not exceed 2 mm in thickness exclusive of fasteners, joints and local reinforcements.

**Table 9.10.14.5.-B**  
**Maximum Allowable Area and Ratio of Width to Height of Exposing Building Face**  
 Forming Part of Sentence 9.10.14.5.(3)

Maximum Ratio of Width to Height of <i>Exposing Building Face</i>	Maximum Area of <i>Exposing Building Face</i> , m <sup>2</sup>
1:1	88
2:1	102
3:1	129
4:1	161
5:1	195

- 4)** Except as provided in Sentence (5), where a garage or accessory *building* serves one *dwelling unit* only and is detached from any *building*, the *exposing building face*
- a) need not conform to the minimum required *fire-resistance rating* stated in Table 9.10.14.5.-A, where the *limiting distance* is 0.6 m or more,
  - b) shall have a *fire-resistance rating* of not less than 45 min, where the *limiting distance* is less than 0.6 m, and
  - c) need not conform to the type of cladding required by Table 9.10.14.5.-A, regardless of the *limiting distance*.

- 5)** The requirements regarding *fire-resistance rating*, type of construction and type of cladding need not apply to the *exposing building face* of a detached garage or accessory *building* facing a *dwelling unit*, where

- a) the detached garage or accessory *building* serves only one *dwelling unit*,
- b) the detached garage or accessory *building* is located on the same property as that *dwelling unit*, and
- c) the *dwelling unit* served by the detached garage or accessory *building* is the only *major occupancy* on the property.

- 6)** Except as provided in Sentence (7), *combustible* projections on the exterior of a wall that are more than 1 m above ground level and that could expose an adjacent *building* to fire spread shall not be permitted within

- a) 1.2 m of a property line or the centre line of a *public way*, or
- b) 2.4 m of a *combustible* projection on another *building* on the same property.

- 7)** Except as provided in Sentences (9) to (12), Sentence (6) shall not apply to

- a) *buildings* containing 1 or 2 *dwelling units* only, and
- b) detached garages or accessory *buildings*, where
  - i) the detached garage or accessory *building* serves only one *dwelling unit*,
  - ii) the detached garage or accessory *building* is located on the same property as that *dwelling unit*, and
  - iii) the *dwelling unit* served by the detached garage or accessory *building* is the only *major occupancy* on the property.

(See Note A-9.10.14.5.(7).)

- 8)** Where *combustible* projections on an *exposing building face* are permitted by Sentence (7), are totally enclosed and constructed with solid faces, such as for fireplaces and *chimneys*, and extend within 1.2 m of a property line,

- a) the construction of the face and sides of the projection shall comply with the corresponding requirements for *exposing building faces* for *limiting distances* less than 1.2 m as stated in Sentence (2) or (3), and
- b) where the underside of the projection is more than 0.6 m above finished ground level, it shall be protected by
  - i) not less than 0.38 mm thick *noncombustible* material,
  - ii) unvented aluminum conforming to CAN/CGSB-93.2-M, "Prefinished Aluminum Siding, Soffits, and Fascia, for Residential Use,"
  - iii) not less than 12.7 mm thick gypsum soffit board or gypsum ceiling board installed according to CSA A82.31-M, "Gypsum Board Application,"

- iv) not less than 11 mm thick plywood,
  - v) not less than 12.5 mm thick OSB or waferboard, or
  - vi) not less than 11 mm thick lumber.
- (See Note A-9.10.14.5.(8).)

**9)** Except as provided in Sentence (11), where the *exposing building face* has a *limiting distance* of not more than 0.45 m, projecting roof soffits shall not be constructed above the *exposing building face*. (See Note A-3.2.3.6.(2).)

**10)** Except as provided in Sentence (11), where the *exposing building face* has a *limiting distance* of more than 0.45 m, the face of roof soffits shall not project to less than 0.45 m from the property line. (See Note A-3.2.3.6.(2).)

**11)** The face of a roof soffit is permitted to project to the property line, where it faces a *street*, lane or public thoroughfare. (See Note A-9.10.14.5.(11) and 9.10.15.5.(10).)

**12)** Where roof soffits project to less than 1.2 m from the property line, the centre line of a lane or public thoroughfare, or an imaginary line between two *buildings* or *fire compartments* on the same property, they shall

- a) have no openings, and
- b) be protected by
  - i) not less than 0.38 mm thick sheet steel,
  - ii) unvented aluminum conforming to CAN/CGSB-93.2-M, "Prefinished Aluminum Siding, Soffits, and Fascia, for Residential Use,"
  - iii) not less than 12.7 mm thick gypsum soffit board or gypsum ceiling board installed according to CSA A82.31-M, "Gypsum Board Application,"
  - iv) not less than 11 mm thick plywood,
  - v) not less than 12.5 mm thick OSB or waferboard, or
  - vi) not less than 11 mm thick lumber.

(See Note A-3.2.3.6.(2).)

**13)** Heavy timber and steel columns need not conform to the requirements of Sentence (1), provided the *limiting distance* is not less than 3 m.

**14)** Non-loadbearing wall components need not have a minimum *fire-resistance rating*, where the *building*

- a) is 1 storey in *building height*,
- b) is of *noncombustible construction*,
- c) is classified as a *low-hazard industrial occupancy* and used only for *low fire load occupancies*, such as power-generating plants or plants for the manufacture or storage of *noncombustible* materials, and
- d) has a *limiting distance* of 3 m or more.

## 9.10.15. Spatial Separation Between Houses

### 9.10.15.1. Application

- 1)** This Subsection applies to
  - a) *buildings* that contain only *dwelling units* and have no *dwelling unit* above another *dwelling unit*, and
  - b) houses with a *secondary suite* including their common spaces.

(See Note A-9.10.15.1.(1).)

### 9.10.15.2. Area and Location of Exposing Building Face

- 1)** The area of an *exposing building face* shall be
  - a) taken as the exterior wall area facing in one direction on any side of a *building*, and
  - b) calculated as
    - i) the total area measured from the finished ground level to the uppermost ceiling,

- ii) the area for each *fire compartment*, where a *building* is divided into *fire compartments* by *fire separations* with *fire-resistance ratings* not less than 45 min, or
- iii) except as provided in Sentence (2), where Table 9.10.15.4. is used to determine the maximum aggregate area of glazed openings, the area of any number of individual vertical portions of the wall measured from the finished ground level to the uppermost ceiling. (See Note A-9.10.15.4.(2).)

**2)** Where the *exposing building face* of any section of an exterior wall enclosing a single room or space, or combination room and space, has a *limiting distance* of 2 m or less, that section of the *exposing building face* serving the room or space shall not be divided into portions for the purpose of calculating area of *exposing building face*. (See Sentence 9.10.15.4.(5) and Note A-9.10.15.4.(2).)

**3)** For the purpose of using Table 9.10.15.4. to determine the maximum permitted area of glazed openings in an irregularly shaped or skewed exterior wall, the location of the *exposing building face* shall be taken as a vertical plane located so that there are no glazed openings between the vertical plane and the line to which the *limiting distance* is measured. (See Note A-3.2.3.1.(4).)

**4)** In determining the required cladding-sheathing assembly and *fire-resistance rating* for an irregularly shaped or skewed exterior wall, the location of the *exposing building face* shall be taken as a vertical plane located so that no portion of the actual *exposing building face* is between the vertical plane and the line to which the *limiting distance* is measured. (See Article 9.10.15.5. and Note A-3.2.3.1.(4).)

### 9.10.15.3. Limiting Distance and Fire Department Response

- 1)** Except for the purpose of applying Sentences 9.10.15.2.(2), 9.10.15.4.(3) and 9.10.15.5.(13), a *limiting distance* equal to half the actual *limiting distance* shall be used as input to the requirements of this Subsection, where
- a) the time from receipt of notification of a fire by the fire department until the first fire department vehicle arrives at the *building* exceeds 10 min in 10% or more of all calls to the *building*, and
  - b) any *storey* in the *building* is not *sprinklered*.
- (See Notes A-3.2.3. and A-3.2.3.1.(8).)

### 9.10.15.4. Glazed Openings in Exposing Building Face

- 1)** Except as provided in Sentence (6), the maximum aggregate area of glazed openings in an *exposing building face* shall
- a) conform to Table 9.10.15.4.,
  - b) conform to Subsection 3.2.3., or
  - c) where the *limiting distance* is not less than 1.2 m, be equal to or less than the *limiting distance* squared.

**2)** Where the limits on the area of glazed openings are determined for individual portions of the exterior wall, as described in Subclause 9.10.15.2.(1)(b)(iii), the maximum aggregate area of glazed openings for any portion shall conform to the values in the row of Table 9.10.15.4. corresponding to the maximum total area of *exposing building face* (see column 1 of the Table) that is equal to the sum of all portions of the *exposing building face*. (See Note A-9.10.15.4.(2).)

**3)** Except for *buildings* that are *sprinklered* and for openable windows having an unobstructed opening equal to 0.35 m<sup>2</sup> installed in accordance with Sentences 9.9.10.1.(1) and (2), where the *limiting distance* is 2 m or less, individual glazed openings or a group of glazed openings in an *exposing building face* shall not exceed 50% of the maximum allowable aggregate area of glazed openings determined in Sentence (1).

- 4) The spacing between individual glazed openings described in Sentence (3) serving a single room or space described in Sentence (5) shall be not less than
  - a) 2 m horizontally of another glazed opening that is on the same *exposing building face* and serves the single room or space, or
  - b) 2 m vertically of another glazed opening that serves the single room or space, or another room or space on the same *storey*.
- 5) For the purpose of Sentence (4), “single room or space” shall mean
  - a) two or more adjacent spaces having a full-height separating wall extending less than 1.5 m from the interior face of the exterior wall, or
  - b) two or more stacked spaces that are on the same *storey*.
- 6) The limits on the area of glazed openings shall not apply to the *exposing building face* of a *dwelling unit* facing a detached garage or accessory *building*, where
  - a) the detached garage or accessory *building* serves only one *dwelling unit*,
  - b) the detached garage or accessory *building* is located on the same property as that *dwelling unit*, and
  - c) the *dwelling unit* served by the detached garage or accessory *building* is the only *major occupancy* on the property.

**Table 9.10.15.4.**  
**Maximum Area of Glazed Openings in Exterior Walls of Houses**  
 Forming Part of Sentences 9.10.15.4.(1) and (2)

Maximum Total Area of Exposing Building Face, m <sup>2</sup>	Maximum Aggregate Area of Glazed Openings, % of <i>Exposing Building Face</i> Area											
	Limiting Distance, m											
	Less than 1.2	1.2	1.5	2.0	4.0	6.0	8.0	10.0	12.0	16.0	20.0	25.0
30	0	7	9	12	39	88	100	—	—	—	—	—
40	0	7	8	11	32	69	100	—	—	—	—	—
50	0	7	8	10	28	57	100	—	—	—	—	—
100	0	7	8	9	18	34	56	84	100	—	—	—
Over 100	0	7	7	8	12	19	28	40	55	92	100	—

**9.10.15.5. Construction of Exposing Building Face of Houses**

- 1) Except as provided in Sentences (4) and (13), each *exposing building face* and any exterior wall located above an *exposing building face* that encloses an *attic or roof space* shall be constructed in conformance with Sentences (2) and (3)
  - a) for the *exposing building face* as a whole, or
  - b) for any number of separate portions of the *exposing building face* (see Subclause 9.10.15.2.(1)(b)(iii), Sentence 9.10.15.4.(2), and Note A-9.10.15.4.(2)).
 (See also Subsection 9.10.8.)

- 2) Except as provided in Sentences (4) and (5), where the *limiting distance* is less than 0.6 m, the *exposing building face* and exterior walls located above the *exposing building face* that enclose an *attic or roof space* shall have a *fire-resistance rating* of not less than 45 min, and
  - a) the cladding shall be metal or *noncombustible* cladding installed in accordance with Section 9.20., 9.27. or 9.28. (see Note A-9.10.14.5.(1)),
  - b) the cladding shall
    - i) conform to Subsection 9.27.12.,
    - ii) be installed without furring members over gypsum sheathing at least 12.7 mm thick or over masonry,

- iii) have a *flame-spread rating* not greater than 25 when tested in accordance with Sentence 3.1.12.1.(2), and
- iv) not exceed 2 mm in thickness exclusive of fasteners, joints and local reinforcements, or
- c) the wall assembly shall comply with Clause 3.1.5.5.(1)(b) when tested in conformance with CAN/ULC-S134, "Fire Test of Exterior Wall Assemblies."

**3)** Except as provided in Sentence (4), where the *limiting distance* is equal to or greater than 0.6 m and less than 1.2 m, the *exposing building face* and any exterior wall located above the *exposing building face* that encloses an *attic or roof space* shall have a *fire-resistance rating* of not less than 45 min, and

- a) the cladding shall be metal or *noncombustible* cladding installed in accordance with Section 9.20., Subsection 9.27.11. or Section 9.28. (see Note A-9.10.14.5.(1)),
- b) the cladding shall
  - i) conform to Subsection 9.27.6., 9.27.7., 9.27.8., 9.27.9., or 9.27.10.,
  - ii) be installed without furring members, or on furring not more than 25 mm thick, over gypsum sheathing at least 12.7 mm thick or over masonry, and
  - iii) after conditioning in conformance with ASTM D 2898, "Accelerated Weathering of Fire-Retardant-Treated Wood for Fire Testing," have a *flame-spread rating* not greater than 25 when tested in accordance with Sentence 3.1.12.1.(2),
- c) the cladding shall
  - i) conform to Subsection 9.27.12.,
  - ii) be installed with or without furring members over gypsum sheathing at least 12.7 mm thick or over masonry,
  - iii) have a *flame-spread rating* not greater than 25 when tested in accordance with Sentence 3.1.12.1.(2), and
  - iv) not exceed 2 mm in thickness exclusive of fasteners, joints and local reinforcements, or
- d) the wall assembly shall comply with Clause 3.1.5.5.(1)(b) when tested in conformance with CAN/ULC-S134, "Fire Test of Exterior Wall Assemblies."

**4)** The requirements regarding *fire-resistance rating* and type of cladding-sheathing assembly shall not apply to the *exposing building face* or projections from an *exposing building face* of a *dwelling unit* facing a detached garage or accessory *building*, or a garage or accessory *building* facing a *dwelling unit*, where

- a) the detached garage or accessory *building* serves only one *dwelling unit*,
- b) the detached garage or accessory *building* is located on the same property as that *dwelling unit*, and
- c) the *dwelling unit* served by the detached garage or accessory *building* is the only *major occupancy* on the property.

**5)** Except as provided in Sentence (6), *combustible* projections on the exterior of a wall that are more than 1 m above ground level and that could expose an adjacent *building* to fire spread shall not be permitted within

- a) 1.2 m of a property line or the centre line of a *public way*, or
- b) 2.4 m of a *combustible* projection on another *building* on the same property.

**6)** Except as provided in Sentences (8) to (11), Sentence (5) shall not apply to

- a) *buildings* containing 1 or 2 *dwelling units* only, and
- b) detached garages or accessory *buildings*, where
  - i) the detached garage or accessory *building* serves only one *dwelling unit*,
  - ii) the detached garage or accessory *building* is located on the same property as that *dwelling unit*, and
  - iii) the *dwelling unit* served by the detached garage or accessory *building* is the only *major occupancy* on the property.

(See Note A-9.10.14.5.(7).)

**7)** Where *combustible* projections on an *exposing building face* are permitted by Sentence (6), are totally enclosed and constructed with solid faces, such as for fireplaces and *chimneys*, and extend within 1.2 m of a property line,

- a) the construction of the face and sides of the projection shall comply with the corresponding requirements for *exposing building faces* for *limiting distances* less than 1.2 m as stated in Sentence (2) or (3), and
- b) where the underside of the projection is more than 0.6 m above finished ground level, it shall be protected by
  - i) not less than 0.38 mm thick *noncombustible* material,
  - ii) unvented aluminum conforming to CAN/CGSB-93.2-M, "Prefinished Aluminum Siding, Soffits, and Fascia, for Residential Use,"
  - iii) not less than 12.7 mm thick gypsum soffit board or gypsum ceiling board installed according to CSA A82.31-M, "Gypsum Board Application,"
  - iv) not less than 11 mm thick plywood,
  - v) not less than 12.5 mm thick OSB or waferboard, or
  - vi) not less than 11 mm thick lumber.

(See Note A-9.10.14.5.(8).)

**8)** Except as provided in Sentence (10), where the *exposing building face* has a *limiting distance* of not more than 0.45 m, projecting roof soffits shall not be constructed above the *exposing building face*. (See Note A-3.2.3.6.(2).)

**9)** Except as provided in Sentence (10), where the *exposing building face* has a *limiting distance* of more than 0.45 m, the face of roof soffits shall not project to less than 0.45 m from the property line. (See Note A-3.2.3.6.(2).)

**10)** The face of a roof soffit is permitted to project to the property line, where it faces a *street*, lane or public thoroughfare. (See Note A-9.10.14.5.(11) and 9.10.15.5.(10).)

**11)** Where roof soffits project to less than 1.2 m from the property line, the centre line of a lane or public thoroughfare, or an imaginary line between two *buildings* or *fire compartments* on the same property, they shall

- a) have no openings, and
- b) be protected by
  - i) not less than 0.38 mm thick sheet steel,
  - ii) unvented aluminum conforming to CAN/CGSB-93.2-M, "Prefinished Aluminum Siding, Soffits, and Fascia, for Residential Use,"
  - iii) not less than 12.7 mm thick gypsum soffit board or gypsum ceiling board installed according to CSA A82.31-M, "Gypsum Board Application,"
  - iv) not less than 11 mm thick plywood,
  - v) not less than 12.5 mm thick OSB or waferboard, or
  - vi) not less than 11 mm thick lumber.

(See Note A-3.2.3.6.(2).)

**12)** For *buildings* of *combustible* construction, materials installed to provide the required protection for soffits may be covered with a *combustible* or *noncombustible* finish material.

**13)** Heavy timber and steel columns need not conform to the requirements of Sentence (1), provided the *limiting distance* is not less than 3 m.

## 9.10.16. Fire Blocks

### 9.10.16.1. Required Fire Blocks in Concealed Spaces

**1)** Vertical concealed spaces in interior walls and exterior walls shall be separated by *fire blocks*

- a) one from the other, and
- b) from horizontal concealed spaces.



- 2) Horizontal concealed spaces in attics, roof spaces, ceilings, floors, and crawl spaces shall be separated by *fire blocks*
  - a) one from the other, and
  - b) from vertical concealed spaces.
- 3) *Fire blocks* shall be provided at all interconnections between concealed vertical and horizontal spaces in interior coved ceilings, drop ceilings and soffits where the exposed construction materials within the concealed spaces have a surface *flame-spread rating* greater than 25.
- 4) *Fire blocks* shall be provided at the top and bottom of each run of stairs where they pass through a floor containing concealed space in which the exposed construction materials within the space have a surface *flame-spread rating* greater than 25.
- 5) Unsprinklered concealed spaces of *combustible construction* created by a ceiling, roof space or unoccupied attic space shall be separated by *fire blocks* into compartments
  - a) not more than 60 m in greatest dimension, and
  - b) where such space contains exposed construction materials having a surface *flame-spread rating* greater than 25, not more than 300 m<sup>2</sup> in area.
- 6) No dimension of the concealed space described in Clause (5)(b) shall exceed 20 m.
- 7) Concealed spaces in mansard or gambrel style roofs, exterior cornices, balconies and canopies of *combustible construction* in which the exposed construction materials within the space have a surface *flame-spread rating* exceeding 25 shall have vertical *fire blocks* at intervals of not more than 20 m and at points where such concealed spaces extend across the ends of required vertical *fire separations*.

#### 9.10.16.2. Required Fire Blocks in Wall Assemblies

- 1) Except as permitted in Sentence (2), *fire blocks* shall be provided to block off concealed spaces within wall assemblies, including spaces created by furring,
  - a) at each floor level,
  - b) at each ceiling level where the ceiling contributes to part of the required *fire-resistance rating*, and
  - c) at other locations within the wall, so that the distance between *fire blocks* does not exceed 20 m horizontally and 3 m vertically.
- 2) *Fire blocks* described in Sentence (1) are not required, provided
  - a) the insulated wall assembly contains not more than one concealed air space whose horizontal thickness is not more than 25 mm,
  - b) the exposed construction materials within the space are *noncombustible*,
  - c) the exposed construction materials within the space, including insulation, but not including wiring, piping or similar services, have a *flame-spread rating* of not more than 25, or
  - d) the concealed wall space is filled with insulation.

#### 9.10.16.3. Fire Block Materials

- 1) Except as permitted by Sentences (2) and (3), *fire blocks* shall be constructed of materials that will remain in place and prevent the passage of flames for not less than 15 min when subjected to the standard fire exposure in CAN/ULC-S101, "Fire Endurance Tests of Building Construction and Materials."
- 2) *Fire blocks* are deemed to comply with Sentence (1) if they are constructed of not less than
  - a) 0.38 mm sheet steel,
  - b) 12.7 mm gypsum board,
  - c) 12.5 mm plywood, OSB or waferboard, with joints having continuous supports,
  - d) 2 layers of 19 mm lumber with joints staggered, or
  - e) 38 mm lumber.
- 3) In a *building* permitted to be of *combustible construction*, semi-rigid fibre insulation board produced from glass, rock or slag is permitted to be used to block

the vertical space in a double-frame wall assembly formed at the intersection of the floor assembly and the walls, provided the width of the vertical space does not exceed 25 mm and the insulation board

- a) has a density not less than 45 kg/m<sup>3</sup>,
- b) is securely fastened to one set of studs,
- c) extends from below the bottom of the top plates in the lower *storey* to above the top of the bottom plate in the upper *storey*, and
- d) completely fills the portion of the vertical space between the headers and between the wall plates.

(See Note A-3.1.11.7.(7).)

#### 9.10.16.4. Penetration of Fire Blocks

1) Where *fire blocks* are pierced by pipes, ducts or other elements, the effectiveness of the *fire blocks* shall be maintained around such elements.

#### 9.10.17. Flame-Spread Limits

##### 9.10.17.1. Flame-Spread Rating of Interior Surfaces

1) Except as otherwise provided in this Subsection, the exposed surface of every interior wall and ceiling, including skylights and glazing, shall have a surface *flame-spread rating* of not more than 150.

2) Except as permitted in Sentence (3), doors need not conform to Sentence (1) provided they have a surface *flame-spread rating* of not more than 200.

3) Doors within *dwelling units*, other than garage doors, need not conform to Sentences (1) and (2).

##### 9.10.17.2. Ceilings in Exits or Public Corridors

1) At least 90% of the exposed surface of every ceiling in an *exit* or unsprinklered ceiling in a *public corridor* shall have a surface *flame-spread rating* of not more than 25. (See Article 9.10.17.6.)

##### 9.10.17.3. Walls in Exits

1) Except as provided in Sentence (2), at least 90% of the exposed surfaces of every wall in an *exit* shall have a surface *flame-spread rating* of not more than 25. (See Article 9.10.17.6.)

2) At least 75% of the wall surface of a lobby used as an *exit* in Article 9.9.8.5. shall have a surface *flame-spread rating* of not more than 25. (See Article 9.10.17.6.)

##### 9.10.17.4. Exterior Exit Passageways

1) Where an exterior *exit* passageway provides the only *means of egress* from the rooms or *suites* it serves, the wall and ceiling finishes of that passageway, including the soffit beneath and the *guard* on the passageway, shall have a surface *flame-spread rating* of not more than 25, except that up to 10% of the total wall area and 10% of the total ceiling area is permitted to have a surface *flame-spread rating* of not more than 150.

##### 9.10.17.5. Walls in Public Corridors

1) At least 90% of the total wall surface in any unsprinklered *public corridor* shall have a surface *flame-spread rating* of not more than 75, or at least 90% of the upper half of such walls shall have a surface *flame-spread rating* of not more than 25. (See Article 9.10.17.6.)

##### 9.10.17.6. Calculation of Wall and Ceiling Areas

1) Skylights, glazing, *combustible* doors, and *combustible* light diffusers and lenses shall not be considered in the calculation of wall and ceiling areas in this Subsection.

**9.10.17.7. Corridors Containing an Occupancy**

1) Where a *public corridor* or a corridor used by the public contains an *occupancy*, the interior finish materials used on the walls or ceiling of such *occupancy*, shall have a surface *flame-spread rating* in conformance with that required for *public corridors*.

**9.10.17.8. Light Diffusers and Lenses**

1) Light diffusers and lenses having *flame-spread ratings* that exceed those permitted for the ceiling finish, shall conform to the requirements of Sentence 3.1.13.4.(1).

**9.10.17.9. Combustible Skylights**

1) Individual *combustible* skylights in corridors required to be separated from the remainder of the *building* by *fire separations* shall not exceed 1 m<sup>2</sup> in area and shall be spaced not less than 1.2 m apart.

**9.10.17.10. Protection of Foamed Plastics**

(See Note A-3.1.4.2.)

1) Except as provided in Sentences (2) and (3), foamed plastics that form part of a wall or ceiling assembly shall be protected from adjacent space in the *building*, other than adjacent concealed spaces within *attic or roof spaces*, crawl spaces, wall assemblies and ceiling assemblies

- a) by one of the interior finishes described in Subsections 9.29.4. to 9.29.9.,
- b) provided the *building* does not contain a Group C *major occupancy*, by sheet metal that
  - i) is mechanically fastened to the supporting assembly independent of the insulation,
  - ii) is not less than 0.38 mm thick, and
  - iii) has a melting point not less than 650°C, or
- c) by any thermal barrier that meets the requirements of Sentence 3.1.5.15.(2).

(See Note A-3.1.4.2.(1)(c).)

2) A walk-in cooler or freezer consisting of factory-assembled wall, floor or ceiling panels containing foamed plastics is permitted to be used, provided the panels

- a) are protected on both sides by sheet metal not less than 0.38 mm thick having a melting point not less than 650°C,
- b) do not contain an air space, and
- c) have a *flame-spread rating*, determined by subjecting a sample panel with an assembled joint typical of field installation to the applicable test described in Subsection 3.1.12., that is not more than that permitted for the room or space in which they are located or that they bound.

3) Thermosetting foamed plastic insulation having a *flame-spread rating* of not more than 200 is permitted to be used in factory-assembled doors in *storage garages* serving single *dwelling units* provided that

- a) the insulation is covered on the interior with a metallic foil,
- b) the assembly has a *flame-spread rating* of not more than 200, and
- c) the assembly incorporates no air spaces.

**9.10.17.11. Walls and Ceilings in Bathrooms**

1) The interior finish of walls and ceilings in bathrooms within *suites* of *residential occupancy* shall have a surface *flame-spread rating* of not more than 200.

**9.10.17.12. Coverings or Linings of Ducts**

1) Where a covering or a lining is used with a duct, such lining or covering shall have a *flame-spread rating* conforming to Article 3.6.5.4. or 9.33.6.4.

**9.10.18. Alarm and Detection Systems**

**9.10.18.1. Access Provided through a Firewall**

1) Where access is provided through a *firewall*, the requirements in this Subsection shall apply to the *floor areas* on both sides of the *firewall* as if they were in the same *building*.

**9.10.18.2. Fire Alarm System Required**

1) Except as permitted in Sentences (3) and (4), a fire alarm system shall be installed in *buildings* in which a sprinkler system is installed.

- 2) Except as provided in Sentence (5), a fire alarm system shall be installed
  - a) in every *building* that contains more than 3 *storeys*, including *storeys* below the *first storey*,
  - b) where the total *occupant load* exceeds 300, or
  - c) when the *occupant load* for any *major occupancy* in Table 9.10.18.2. is exceeded.

**Table 9.10.18.2.**  
**Maximum Occupant Load for Buildings without Fire Alarm Systems**  
 Forming Part of Sentence 9.10.18.2.(2)

<i>Major Occupancy Classification</i>	<i>Occupant Load Above which a Fire Alarm System is Required</i>
<i>Residential</i>	10 (sleeping accommodation)
<i>Business and personal services, Mercantile</i>	150 above or below the <i>first storey</i>
<i>Low- or medium-hazard industrial</i>	75 above or below the <i>first storey</i>

3) In *buildings* in which a sprinkler system has been installed in accordance with NFPA 13D, "Installation of Sprinkler Systems in One- and Two-Family Dwellings and Manufactured Homes," a fire alarm system need not be installed.

4) In *buildings* that contain fewer than 9 sprinklers conforming to Sentence 3.2.5.12.(4), a fire alarm system need not be installed.

5) A fire alarm system is not required in a *residential occupancy* where an *exit* or *public corridor* serves not more than 4 *suites* or where each *suite* has direct access to an exterior *exit* facility leading to ground level.

**9.10.18.3. Design and Installation Requirements**

1) Except as stated in Sentence (2) and as required by this Subsection, where fire alarm, fire detection and smoke detection devices and systems are installed, these devices and systems and their installation shall conform to Subsection 3.2.4.

2) The following Articles in Subsection 3.2.4. regarding fire alarm systems do not apply to Part 9 *buildings*: Articles 3.2.4.1., 3.2.4.10., 3.2.4.11., 3.2.4.12., 3.2.4.13. and 3.2.4.22.

**9.10.18.4. Rooms and Spaces Requiring Heat Detectors or Smoke Detectors**

1) Where a fire alarm system is required, every *public corridor* in *buildings* of *residential occupancy* and every *exit* stair shaft shall be provided with *smoke detectors*.

2) Except as provided in Sentence (3), if a fire alarm system is required in a *building* that is not *sprinklered*, *fire detectors* shall be installed in the following spaces:

- a) storage rooms not within *dwelling units*,
- b) *service rooms* not within *dwelling units*,
- c) janitors' rooms
- d) rooms in which hazardous substances are to be used or stored (see Note A-3.3.1.2.(1)),
- e) elevator hoistways, chutes and dumbwaiter shafts, and
- f) laundry rooms in *buildings* of *residential occupancy*, but not those within *dwelling units*.

Copyright © NRC 1941 - 2021 World Rights Reserved © CNRC 1941-2021 Droits réservés pour tous pays

3) *Heat detectors* and *smoke detectors* described in Sentence (2) are not required in *dwelling units* or in *sprinklered buildings* in which the sprinkler system is electrically supervised and equipped with a water flow alarm.

#### 9.10.18.5. Smoke Detectors in Recirculating Air-Handling Systems

1) Except for a recirculating air system serving not more than one *dwelling unit*, where a fire alarm system is required to be installed, every recirculating air-handling system shall be designed to prevent the circulation of smoke upon a signal from a duct-type *smoke detector* where such system supplies more than one *suite* on the same floor or serves more than 1 *storey*.

#### 9.10.18.6. Portions of Buildings Considered as Separate Buildings

1) Except as provided in Sentence (2), where a vertical *fire separation* having a *fire-resistance rating* of not less than 1 h separates a portion of a *building* from the remainder of the *building* and there are no openings through the *fire separation* other than those for piping, tubing, wiring and conduit, the requirements for fire alarm and detection systems may be applied to each portion so separated as if it were a separate *building*.

2) The permission in Sentence (1) to consider separated portions of a *building* as separate *buildings* does not apply to *service rooms* and storage rooms.

#### 9.10.18.7. Central Vacuum Systems

1) Central vacuum cleaning systems serving more than one *suite* or *storey* in *buildings* equipped with a fire alarm system shall be designed to shut down upon activation of the fire alarm system.

#### 9.10.18.8. Open-Air Storage Garages

1) A fire alarm system is not required in a *storage garage* conforming to Article 3.2.2.90. provided there are no other *occupancies* in the *building*.

### 9.10.19. Smoke Alarms

#### 9.10.19.1. Required Smoke Alarms

1) Except as permitted by Article 9.10.19.8., *smoke alarms* conforming to CAN/ULC-S531, "Smoke Alarms," shall be installed in

- each *dwelling unit*,
- each sleeping room not within a *dwelling unit*, and
- ancillary spaces and common spaces not in *dwelling units* in a house with a *secondary suite*.

#### 9.10.19.2. Sound Patterns of Smoke Alarms

1) The sound patterns of *smoke alarms* shall

- meet the temporal patterns of *alarm signals* (see Note A-3.2.4.18.(2)), or
- be a combination of temporal pattern and voice relay.

#### 9.10.19.3. Location of Smoke Alarms

1) Within *dwelling units*, sufficient *smoke alarms* shall be installed so that

- there is at least one *smoke alarm* installed on each *storey*, including *basements*, and
- on any *storey* of a *dwelling unit* containing sleeping rooms, a *smoke alarm* is installed
  - in each sleeping room, and
  - in a location between the sleeping rooms and the remainder of the *storey*, and if the sleeping rooms are served by a hallway, the *smoke alarm* shall be located in the hallway.

(See Note A-9.10.19.3.(1).)

**2)** A *smoke alarm* required by Sentence (1) shall be installed in conformance with CAN/ULC-S553, "Installation of Smoke Alarms."

**3)** *Smoke alarms* required in Article 9.10.19.1. and Sentence (1) shall be installed on or near the ceiling.

#### 9.10.19.4. Power Supply

**1)** Except as provided in Sentences (2) and (3), *smoke alarms* described in Sentence 9.10.19.1.(1) shall

- a) be installed with permanent connections to an electrical circuit (see Note A-3.2.4.20.(7)(a)),
- b) have no disconnect switch between the overcurrent device and the *smoke alarm*, and
- c) in case the regular power supply to the *smoke alarm* is interrupted, be provided with a battery as an alternative power source that can continue to provide power to the *smoke alarm* for a period of no less than 7 days in the normal condition, followed by 4 minutes of alarm.

**2)** Where the *building* is not supplied with electrical power, *smoke alarms* are permitted to be battery-operated.

**3)** *Suites of residential occupancy* are permitted to be equipped with *smoke detectors* in lieu of *smoke alarms*, provided the *smoke detectors*

- a) are capable of independently sounding audible signals within the individual *suites*,
- b) except as permitted in Sentence (4), are installed in conformance with CAN/ULC-S524, "Installation of Fire Alarm Systems," and
- c) form part of the fire alarm system.

(See Note A-3.2.4.20.(8).)

**4)** *Smoke detectors* permitted to be installed in lieu of *smoke alarms* as stated in Sentence (3) are permitted to sound localized alarms within individual *suites*, and need not sound an alarm throughout the rest of the *building*.

#### 9.10.19.5. Interconnection of Smoke Alarms

**1)** Where more than one *smoke alarm* is required in a *dwelling unit*, the *smoke alarms* shall be wired so that the activation of one alarm will cause all alarms within the *dwelling unit* to sound.

**2)** *Smoke alarms* in a house with a *secondary suite* shall be wired so that the activation of any one *smoke alarm* causes all *smoke alarms* within the house with a *secondary suite* to sound.

#### 9.10.19.6. Silencing of Smoke Alarms

**1)** Except as permitted in Sentence (2), a manually operated device shall be incorporated within the circuitry of a *smoke alarm* installed in a *dwelling unit* so that the signal emitted by the *smoke alarm* can be silenced for a period of not more than 10 min, after which the *smoke alarm* will reset and sound again if the level of smoke in the vicinity is sufficient to re-actuate it.

**2)** *Suites of residential occupancy* equipped with *smoke detectors* installed to CAN/ULC-S524, "Installation of Fire Alarm Systems," which are part of the fire alarm system in lieu of *smoke alarms* as permitted in Sentence 9.10.19.4.(3), need not incorporate the manually operated device required in Sentence (1).

#### 9.10.19.7. Instructions for Maintenance and Care

**1)** Where instructions are necessary to describe the maintenance and care required for *smoke alarms* to ensure continuing satisfactory performance, they shall be posted in a location where they will be readily available to the occupants for reference.

**9.10.19.8. Residential Fire Warning Systems**

- 1)** Except where a fire alarm system is installed or required in a *building*, *smoke detectors* forming part of a residential fire warning system installed in conformance with CAN/ULC-S540, "Residential Fire and Life Safety Warning Systems: Installation, Inspection, Testing and Maintenance," are permitted to be installed in lieu of all *smoke alarms* required by Articles 9.10.19.1. and 9.10.19.3., provided that the fire warning system
- is capable of sounding audible signals as stated in Articles 9.10.19.2. and 9.10.19.5.,
  - is powered as stated in Article 9.10.19.4., and
  - is equipped with a silencing device as stated in Article 9.10.19.6.

**9.10.20. Firefighting****9.10.20.1. Windows or Access Panels Required**

- 1)** Except as provided in Sentence (3), a window or access panel providing an opening not less than 1 100 mm high and 550 mm wide and having a sill height of not more than 900 mm above the floor shall be provided on the second and third *storeys* of every *building* in at least one wall facing on a *street* if such *storeys* are not *sprinklered*.
- 2)** Access panels required in Sentence (1) shall be readily openable from both inside and outside or be glazed with plain glass.
- 3)** Access panels required in Sentence (1) need not be provided in
- buildings* containing only *dwelling units* where there is no *dwelling unit* above another *dwelling unit*, or
  - houses with a *secondary suite*.

**9.10.20.2. Access to Basements**

- 1)** Except for *basements* in houses with a *secondary suite* or *basements* serving not more than one *dwelling unit*, each unsprinklered *basement* exceeding 25 m in length or width shall be provided with direct access to the outdoors to at least one *street*.
- 2)** Access required in Sentence (1) may be provided by a door, window or other means that provides an opening not less than 1 100 mm high and 550 mm wide, the sill height of which shall not be more than 900 mm above the floor.
- 3)** Access required in Sentence (1) may also be provided by an interior stair accessible from the outdoors.

**9.10.20.3. Fire Department Access to Buildings**

- 1)** Access for fire department equipment shall be provided to each *building* by means of a *street*, private roadway or yard. (See Notes A-9.10.20.3.(1) and A-3.2.5.6.(1).)
- 2)** Where access to a *building* as required in Sentence (1) is provided by means of a roadway or yard, the design and location of such roadway or yard shall take into account connection with public thoroughfares, weight of firefighting equipment, width of roadway, radius of curves, overhead clearance, location of fire hydrants, location of fire department connections and vehicular parking.

**9.10.20.4. Portable Extinguishers**

- 1)** Portable extinguishers shall be installed in all *buildings*, except within *dwelling units*, in conformance with the appropriate provincial or territorial regulations or municipal bylaws or, in the absence of such regulations or bylaws, the NFC.

**9.10.20.5. Freeze Protection of Fire Protection Systems**

- 1)** Equipment forming part of a fire protection system that may be adversely affected by freezing temperatures and that is located in an unheated area shall be protected from freezing.

**9.10.21.1.****9.10.21. Fire Protection for Construction Camps****9.10.21.1. Requirements for Construction Camps**

1) Except as provided in Articles 9.10.21.2. to 9.10.21.9., construction camps shall conform to Subsections 9.10.1. to 9.10.20.

**9.10.21.2. Separation of Sleeping Rooms**

1) Except for sleeping rooms within *dwelling units*, sleeping rooms in construction camps shall be separated from each other and from the remainder of the *building* by a *fire separation* having not less than a 30 min *fire-resistance rating*.

**9.10.21.3. Floor Assemblies between the First and Second Storey**

1) Except in a *dwelling unit*, a floor assembly in a construction camp *building* separating the *first storey* and the second *storey* shall be constructed as a *fire separation* having not less than a 30 min *fire-resistance rating*.

**9.10.21.4. Walkways Connecting Buildings**

1) *Walkways* of *combustible construction* connecting *buildings* shall be separated from each connected *building* by a *fire separation* having not less than a 45 min *fire-resistance rating*.

**9.10.21.5. Spatial Separations**

1) Construction camp *buildings* shall be separated from each other by a distance of not less than 10 m except as otherwise permitted in Subsections 9.10.14. and 9.10.15.

**9.10.21.6. Flame-Spread Ratings**

1) Except in *dwelling units* and except as provided in Sentence (2), the surface *flame-spread rating* of wall and ceiling surfaces in corridors and *walkways*, exclusive of doors, shall not exceed 25 over not less than 90% of the exposed surface area and not more than 150 over the remaining surface area.

2) Except within *dwelling units*, corridors that provide *access to exit* from sleeping rooms and that have a *fire-resistance rating* of not less than 45 min shall have a *flame-spread rating* conforming to the appropriate requirements in Subsection 9.10.17.

**9.10.21.7. Smoke Detectors**

1) Except in *dwelling units*, corridors providing *access to exit* from sleeping rooms in construction camp *buildings* with sleeping accommodation for more than 10 persons shall be provided with a *smoke detector* connected to the *building* alarm system.

**9.10.21.8. Portable Fire Extinguishers**

1) Each construction camp *building* shall be provided with portable fire extinguishers in conformance with the appropriate provincial or territorial regulations or municipal bylaws or, in the absence of such regulations or bylaws, in conformance with the NFC.

**9.10.21.9. Hose Stations**

1) Every construction camp *building* providing sleeping accommodation for more than 30 persons shall be provided with a hose station that is protected from freezing and is equipped with a hose of sufficient length so that every portion of the *building* is within reach of a hose stream.

2) Hose stations required in Sentence (1) shall be located near an *exit*.

3) Hoses referred to in Sentence (1) shall be not less than 19 mm inside diam and shall be connected to a central water supply or to a storage tank having a capacity of not less than 4 500 L with a pumping system capable of supplying a flow of not less than 5 L/s at a gauge pressure of 300 kPa.



**9.10.22. Fire Protection for Gas, Propane and Electric Cooktops and Ovens**

(See Note A-9.10.22.)

**9.10.22.1. Installation of Cooktops and Ovens**

**1)** Except as required in Sentence (2), natural gas and propane *cooktops* and ovens shall be installed in accordance with the applicable provincial or territorial regulations or municipal bylaws or, in the absence of such regulations or bylaws, with CSA B149.1, "Natural Gas and Propane Installation Code." (See also Article 9.34.1.1.)

**2)** Clearances for and protection around gas, propane and electric ranges shall be not less than those provided in Articles 9.10.22.2. and 9.10.22.3.

**9.10.22.2. Vertical Clearances above Cooktops**

**1)** Except as provided in Sentence (2), framing, finishes and cabinetry installed directly above the location of the *cooktop* shall be not less than 750 mm above the level of *cooktop* burners or elements.

**2)** The vertical clearance described in Sentence (1) for framing, finishes and cabinets located directly above the location of the *cooktop* may be reduced to 600 mm above the level of the elements or burners, provided the framing, finishes and cabinets

- a) are *noncombustible*, or
- b) are protected by a metal hood that projects 125 mm beyond the framing, finishes and cabinets.

**9.10.22.3. Protection around Cooktops**

**1)** Except as provided in Sentences (2) and (3), *combustible* wall framing, finishes or cabinets within 450 mm of the area where the *cooktop* is to be located shall be protected above the level of the heating elements or burners by material providing fire resistance at least equivalent to that provided by a 9.5 mm thickness of gypsum board.

**2)** Counter-top splash boards or back plates that extend above the level of heating elements or burners need not be protected as described in Sentence (1).

**3)** Except for cabinetry described in Article 9.10.22.2., cabinetry located not less than 450 mm above the level of the heating elements or burners need not be protected as described in Sentence (1).

**Section 9.11. Sound Transmission**

(See Note A-9.11.)

**9.11.1. Protection from Airborne Noise****9.11.1.1. Required Protection**

**1)** Except as provided in Sentences (2) and (3), a *dwelling unit* shall be separated from every other space in a *building* in which noise may be generated by

- a) a separating assembly and adjoining constructions, which together provide an *apparent sound transmission class (ASTC)* rating of not less than 47, or
- b) a separating assembly providing a *sound transmission class (STC)* rating of not less than 50 and adjoining constructions that conform to Article 9.11.1.4.

(See Note A-9.11.1.4.)

**2)** Where a house contains a *secondary suite*, each *dwelling unit* shall be separated from every other space in the house in which noise may be transmitted by

- a) construction
  - i) whose joist spaces are filled with sound-absorbing material of not less than 150 mm nominal thickness,
  - ii) whose stud spaces are filled with sound-absorbing material,

- iii) having a resilient channel on one side of the separation spaced 400 or 600 mm o.c., and
  - iv) having not less than 12.7 mm thick gypsum board on ceilings and on both sides of walls, or
  - b) construction providing an *STC* rating of not less than 43, or
  - c) a separating assembly and adjoining constructions, which together provide an *ASTC* rating of not less than 40.
- (See Note A-9.11.1.1.(2).)

**3)** Construction separating a *dwelling unit* from an elevator shaft or refuse chute shall have an *STC* rating of not less than 55.

#### 9.11.1.2. Determination of Sound Transmission Ratings

**1)** The *STC* ratings shall be determined in accordance with ASTM E 413, "Classification for Rating Sound Insulation," using the results from measurements carried out in accordance with ASTM E 90, "Laboratory Measurement of Airborne Sound Transmission Loss of Building Partitions and Elements."

- 2)** The *ASTC* ratings shall be
- a) determined in accordance with ASTM E 413, "Classification for Rating Sound Insulation," using the results from measurements carried out in accordance with ASTM E 336, "Measurement of Airborne Sound Attenuation between Rooms in Buildings," or
  - b) calculated in accordance with Article 5.8.1.4. or 5.8.1.5.

#### 9.11.1.3. Compliance with Required Ratings

- 1)** Compliance with the required *STC* ratings shall be demonstrated through
- a) measurements carried out in accordance with Sentence 9.11.1.2.(1), or
  - b) the construction of separating assemblies conforming to Table 9.10.3.1.-A or 9.10.3.1.-B, as applicable.
- 2)** Compliance with the required *ASTC* ratings shall be demonstrated through
- a) measurements or calculations carried out in accordance with Sentence 9.11.1.2.(2), or
  - b) the construction of separating assemblies conforming to Table 9.10.3.1.-A or 9.10.3.1.-B, as applicable, that have an *STC* rating of not less than 50 in conjunction with flanking assemblies constructed in accordance with Article 9.11.1.4. (see Note A-9.11.1.3.(2)(b)).

#### 9.11.1.4. Adjoining Constructions

(See Note A-9.11.1.4.)

**1)** This Article applies where the required protection is provided in accordance with Clause 9.11.1.1.(1)(b) and compliance is demonstrated in accordance with Clause 9.11.1.3.(2)(b).

**2)** Flanking wall assemblies connected to a separating floor or ceiling assembly shall be constructed with

- a) concrete or concrete block having a mass per area greater than 200 kg/m<sup>2</sup>, or
- b) gypsum board finish that
  - i) is supported on wood or steel framing, and
  - ii) ends or is interrupted where it meets the structure of the separating floor or ceiling assembly.

**3)** Flanking wall and ceiling assemblies connected to a separating wall assembly shall be constructed with

- a) concrete or concrete block having a mass per area greater than 300 kg/m<sup>2</sup>, or
- b) gypsum board finish that
  - i) is supported on wood or steel framing, and
  - ii) ends or is interrupted where it meets the structure of the separating wall assembly or, for double-stud walls, where it meets the space between the two lines of studs.

- 4)** Flanking floor assemblies connected to a separating wall assembly shall be
  - a) constructed
    - i) with concrete having a mass per area greater than 300 kg/m<sup>2</sup>, or
    - ii) in accordance with Section 9.16., or
  - b) supported on joists or trusses that are not continuous across the junction and are covered with floor treatments in accordance with Table 9.11.1.4. for the applicable wall construction.

**Table 9.11.1.4.**  
**Floor Treatments for Flanking Wood-Framed Floor Assemblies in Horizontally Adjoining Spaces**  
 Forming Part of Sentence 9.11.1.4.(4)

Type of Separating Wall Assembly with <i>STC</i> ≥ 50 from Table 9.10.3.1.-A	Minimum Requirements for Floor Treatments Applied Over Subfloor of Wood-Framed Flanking Floor Assemblies on Both Sides of Floor/Wall Junction
W5, W6, W10, W12 (staggered studs)	<ul style="list-style-type: none"> <li>• wood strip flooring not less than 16 mm thick aligned parallel to separating wall, or</li> <li>• one layer of OSB or plywood not less than 15.5 mm thick plus finished flooring, or</li> <li>• one additional material layer plus finished flooring having a combined mass per area not less than 8 kg/m<sup>2(1)</sup></li> </ul>
W4, W11 (staggered studs)	<ul style="list-style-type: none"> <li>• one layer of OSB or plywood not less than 12.5 mm thick plus hardwood strip flooring not less than 19 mm thick aligned parallel to separating wall, or</li> <li>• one additional material layer plus finished flooring having a combined mass per area not less than 16 kg/m<sup>2(1)</sup></li> </ul>
W8, W9 (staggered studs)	<ul style="list-style-type: none"> <li>• concrete or gypsum concrete topping not less than 19 mm thick bonded to the subfloor plus finished flooring, or</li> <li>• one additional material layer plus finished flooring having a combined mass per area not less than 32 kg/m<sup>2(1)</sup></li> </ul>
W13, W14, W15 (double stud walls)	<ul style="list-style-type: none"> <li>• where a continuous subfloor or other rigid materials at the floor/wall junction provide structural connection between the two rows of studs in the separating wall:                             <ul style="list-style-type: none"> <li>• hardwood strip flooring not less than 16 mm thick aligned parallel to separating wall, or</li> <li>• one layer OSB or plywood not less than 15.5 mm thick plus finished flooring, or</li> <li>• one additional material layer plus finished flooring having a combined mass per area not less than 8 kg/m<sup>2(1)</sup></li> </ul> </li> <li>• any finished flooring where the subfloor and other rigid materials are not connected at the floor/wall junction and where there are no structural connections between the two rows of studs in the separating wall</li> </ul>
B1 to B10	<ul style="list-style-type: none"> <li>• any finished flooring</li> </ul>

**Notes to Table 9.11.1.4.:**

(1) See Note A-Table 9.11.1.4.

## **Section 9.12. Excavation**

### **9.12.1. General**

#### **9.12.1.1. Removal of Topsoil and Organic Matter**

- 1)** The topsoil and vegetable matter in all unexcavated areas under a *building* shall be removed.
- 2)** In localities where termite infestation is known to be a problem, all stumps, roots and other wood debris shall be removed from the *soil* to a depth of not less than 300 mm in unexcavated areas under a *building*.
- 3)** The bottom of every *excavation* shall be free of all organic material.

#### **9.12.1.2. Standing Water**

- 1)** *Excavations* shall be kept free of standing water.

**9.12.1.3. Protection from Freezing**

1) The bottom of *excavations* shall be kept from freezing throughout the entire construction period.

**9.12.2. Depth**

**9.12.2.1. Excavation to Undisturbed Soil**

1) *Excavations* for *foundations* shall extend to undisturbed *soil*.

**9.12.2.2. Minimum Depth of Foundations**

1) Except as provided in Sentences (4) to (7), the minimum depth of *foundations* below finished ground level shall conform to Table 9.12.2.2.

**Table 9.12.2.2.**  
**Minimum Depths of Foundations**  
Forming Part of Sentence 9.12.2.2.(1)

Type of Soil	Minimum Depth of <i>Foundation</i> Containing Heated <i>Basement</i> or <i>Crawl Space</i> <sup>(1)</sup>		Minimum Depth of <i>Foundation</i> Containing No Heated Space <sup>(2)</sup>	
	Good <i>Soil</i> Drainage	Poor <i>Soil</i> Drainage	Good <i>Soil</i> Drainage	Poor <i>Soil</i> Drainage
Rock	No limit	No limit	No limit	No limit
Coarse grained <i>soils</i>	No limit	No limit	No limit	Below the depth of frost penetration
Silt	No limit	No limit	Below the depth of frost penetration <sup>(3)</sup>	Below the depth of frost penetration
Clay or <i>soils</i> not clearly defined <sup>(4)</sup>	1.2 m <sup>(3)</sup>	1.2 m	1.2 m but not less than the depth of frost penetration <sup>(3)</sup>	1.2 m but not less than the depth of frost penetration

**Notes to Table 9.12.2.2.:**

- (1) *Foundation* not insulated to reduce heat loss through the footings.
- (2) Including *foundations* insulated to reduce heat loss through the footings.
- (3) Good *soil* drainage to not less than the depth of frost penetration.
- (4) See Note A-Table 9.12.2.2.

2) Where a *foundation* is insulated in a manner that will reduce heat flow to the *soil* beneath the footings, the *foundation* depth shall conform to that required for *foundations* containing no heated space. (See Note A-9.12.2.2.(2).)

3) The minimum depth of *foundations* for exterior concrete steps with more than 2 risers shall conform to Sentences (1), (2) and (5).

4) Concrete steps with 1 and 2 risers are permitted to be laid on ground level.

5) The *foundation* depths required in Sentence (1) are permitted to be decreased where experience with local *soil* conditions shows that lesser depths are satisfactory, or where the *foundation* is designed for lesser depths.

6) The *foundation* depths required by Sentence (1) do not apply to *foundations* for

- a) *buildings*
  - i) that are not of masonry or masonry veneer construction, and
  - ii) whose superstructure conforms to the requirements of the deformation resistance test in CSA Z240.2.1, "Structural Requirements for Manufactured Homes," or
- b) accessory *buildings*
  - i) that are not of masonry or masonry veneer construction,
  - ii) not more than 1 *storey* in height,
  - iii) not more than 55 m<sup>2</sup> in *building area*, and
  - iv) where the distance from finished ground to the underside of the floor joists is not more than 600 mm.

**7)** The *foundation* depths required by Sentence (1) do not apply to *foundations* for decks and other accessible exterior platforms

- a) of not more than 1 *storey*,
- b) not more than 55 m<sup>2</sup> in area,
- c) where the distance from finished ground to the underside of the joists is not more than 600 mm,
- d) not supporting a roof, and
- e) not attached to another structure, unless it can be demonstrated that differential movement will not adversely affect the performance of that structure.

**8)** Where decks or other accessible exterior platforms are supported on surface *foundations* supported on other than coarse-grained *soil* with good drainage or *rock*, access to the *foundation* positions to permit re-levelling of the platform shall be provided

- a) by passageways with a clear height under the platform of not less than 600 mm and a width of not less than 600 mm, or
- b) by installing the decking in a manner that allows easy removal.

**9.12.3. Backfill**

**9.12.3.1. Placement of Backfill**

**1)** Backfill shall be placed to avoid damaging the *foundation* wall, the drainage tile, externally applied thermal insulation and waterproofing or dampproofing of the wall.

**9.12.3.2. Grading of Backfill**

**1)** Backfill shall be *graded* to prevent drainage towards the *foundation* after settling.

**9.12.3.3. Deleterious Debris and Boulders**

**1)** Backfill that is within 600 mm of the *foundation* shall be free of deleterious debris and boulders larger than 250 mm diam. (See Note A-9.12.3.3.(1).)

**2)** Except as provided in Sentence (3), backfill shall not contain pyritic material or material that is susceptible to ice lensing in concentrations that will damage the *building* to a degree that would adversely affect its stability or the performance of assemblies. (See Note A-9.4.4.4.(1).)

**3)** Backfill with material of any concentration that is susceptible to ice lensing is permitted where *foundation* walls are

- a) cast-in-place concrete,
- b) concrete block insulated on the exterior, or
- c) concrete block protected from the backfill by a material that serves as a slip plane.

(See Note A-9.4.4.4.(1).)

**9.12.4. Trenches beneath Footings**

**9.12.4.1. Support of Footings**

**1)** The *soil* in trenches beneath footings for sewers and watermains shall be compacted by tamping up to the level of the footing base, or shall be filled with concrete having a strength not less than 10 MPa to support the footing.

## Section 9.13. Dampproofing, Waterproofing and Soil Gas Control

### 9.13.1. General

#### 9.13.1.1. Scope and Application

- 1) This Section presents measures to control the ingress of water, moisture and soil gas.
- 2) Subsection 9.13.2. applies to below-ground walls and floors-on-ground where drainage is provided in accordance with Section 9.14. over and along the entire below-ground portion of the *foundation* wall.
- 3) Subsection 9.13.3. applies to below-ground walls, floors-on-ground and roofs of underground structures that are subject to hydrostatic pressure.
- 4) Subsection 9.13.4. applies to walls, roofs and floors that are in contact with the ground.

### 9.13.2. Dampproofing

#### 9.13.2.1. Required Dampproofing

- 1) Except as provided in Article 9.13.3.1., where the exterior finished ground level is at a higher elevation than the ground level inside the *foundation* walls, exterior surfaces of *foundation* walls below ground level shall be dampproofed.
- 2) Except as provided in Sentence (3) and Article 9.13.3.1., floors-on-ground shall be dampproofed.
- 3) Dampproofing required in Sentence (2) need not be provided for
  - a) floors in garages,
  - b) floors in unenclosed portions of *buildings*, or
  - c) floors installed over not less than 100 mm of coarse clean granular material containing not more than 10% of material that will pass a 4 mm sieve.

#### 9.13.2.2. Dampproofing Materials

- 1) Materials installed to provide required dampproofing shall be
  - a) capable of protecting assemblies against moisture transfer from the ground,
  - b) compatible with adjoining materials, and
  - c) resistant to mechanisms of deterioration that may reasonably be expected, given the nature, function and exposure of the materials.
- 2) Except as otherwise specified in this Section, materials used for exterior dampproofing shall
  - a) conform to one of the following standards:
    - i) ASTM D 1227, "Emulsified Asphalt Used as a Protective Coating for Roofing," Type III, Class I,
    - ii) ASTM D 4479/D 4479M, "Asphalt Roof Coatings – Asbestos-Free," Type III,
    - iii) CAN/CGSB-51.34-M, "Vapour Barrier, Polyethylene Sheet for Use in Building Construction," or
    - iv) CAN/CSA-A123.4, "Asphalt for Constructing Built-Up Roof Coverings and Waterproofing Systems," or
  - b) have a water vapour permeance of not more than 43 ng/Pa·s·m<sup>2</sup> when tested in accordance with Procedure A (wet cup) of ASTM E 96/E 96M, "Water Vapor Transmission of Materials," and consist of one of the following material types:
    - i) a vapour-resistant coating,
    - ii) a cold-fluid-applied or hot-rubberized bituminous dampproofing membrane,

- iii) a liquid-applied or spray-applied asphalt-based emulsion dampproofing, or
- iv) a type III hot-applied asphalt.

### 9.13.2.3. Preparation of Surface

- 1) The area in which dampproofing is to be carried out shall be kept free of water during the application and curing of the dampproofing system.
- 2) The surface to be dampproofed shall be prepared in accordance with the instructions of the dampproofing material manufacturer.
- 3) Where the dampproofing material is to be applied on insulating concrete form (ICF) walls, the instructions of the ICF wall manufacturer shall be followed.
- 4) Unit masonry walls to be dampproofed shall be parged on the exterior face below ground level with not less than 6 mm of mortar conforming to Section 9.20. coved over the footing.
- 5) Concrete walls to be dampproofed shall have holes and recesses sealed with cement mortar or a mastic or sealant that is suitable for vertical applications and compatible with the dampproofing material.
- 6) The surface required to be dampproofed shall be clean and dry and free of ice, snow, frost, dust, dirt, oil, grease, cracks, projections and depressions, loose particles and debris that could be detrimental to the performance of the material to be applied.

### 9.13.2.4. Application of Dampproofing Material

- 1) Exterior dampproofing shall be applied from finished ground level to the top of the exterior of the footing.
- 2) Unless otherwise stated in this Subsection, dampproofing shall be installed in accordance with the manufacturer's instructions with regard to
  - a) surface priming,
  - b) conditions during application,
  - c) application quantity and rate, and
  - d) curing times.
- 3) Joints, cracks and penetrations shall be sealed to maintain the continuity of the dampproofing, where the dampproofing material is not capable of bridging such discontinuities.

### 9.13.2.5. Moisture Protection for Interior Finishes

(See Note A-9.13.2.5.)

- 1) The interior surface of *foundation* walls below ground level shall be protected by means that minimize the ingress of moisture from the *foundation* wall into interior spaces, where
  - a) a separate interior finish is applied to a concrete or unit masonry wall that is in contact with the *soil*, or
  - b) wood members are placed in contact with such walls for the installation of insulation or finish.
- 2) Except as provided in Sentence (3), where the protection of interior finishes required in Sentence (1) consists of membranes or coatings,
  - a) the membrane or coating shall extend from the *basement* floor surface up to the highest extent of the interior insulation or finish, but not higher than the exterior finished ground level, and
  - b) no membrane or coating with a permeance less than 170 ng/(Pa·s·m<sup>2</sup>) shall be applied to the interior surface of the *foundation* wall above ground level between the insulation and the *foundation* wall.
- 3) Where insulation functions as both moisture protection for interior finishes and as a *vapour barrier* in accordance with Subsection 9.25.4., it shall be applied over the entire interior surface of the *foundation* wall.

**9.13.2.6. Dampproofing of Floors-on-Ground**

- 1)** Where dampproofing is installed below the floor, it shall consist of
  - a) polyethylene not less than 0.15 mm thick with joints lapped not less than 100 mm,
  - b) type S roll roofing with joints lapped not less than 100 mm, or
  - c) rigid extruded/expanded polystyrene with sealed or ship-lapped joints that has
    - i) sufficient compressive strength to support the floor assembly, and
    - ii) a water vapour permeance complying with Clause 9.13.2.2.(2)(a).
- 2)** Where dampproofing is installed between a floor-on-ground and a finished floor, it shall consist of
  - a) rigid extruded/expanded polystyrene with sealed or ship-lapped joints that has
    - i) sufficient compressive strength to support the floor assembly, and
    - ii) a water vapour permeance complying with Clause 9.13.2.2.(2)(b), or
  - b) polyethylene not less than 0.05 mm thick with joints lapped not less than 100 mm.

**9.13.3. Waterproofing****9.13.3.1. Required Waterproofing**

- 1)** Where hydrostatic pressure occurs, waterproofing is required for assemblies separating interior space from the ground to prevent the ingress of water into *building* assemblies and interior spaces.
- 2)** Waterproofing is required for roofs of underground structures to prevent the ingress of water into *building* assemblies and interior spaces.

**9.13.3.2. Waterproofing Materials**

- 1)** Materials installed to provide required waterproofing shall be
  - a) compatible with adjoining materials, and
  - b) resistant to mechanisms of deterioration that may reasonably be expected, given the nature, function and exposure of the materials.
- 2)** Materials used for exterior waterproofing shall conform to
  - a) ASTM D 1227, "Emulsified Asphalt Used as a Protective Coating for Roofing," in which case, they shall be installed in accordance with Sentence 9.13.3.3.(3),
  - b) ASTM D 3019, "Lap Cement Used with Asphalt Roll Roofing, Non-Fibered, Asbestos-Fibered, and Non-Asbestos-Fibered,"
  - c) ASTM D 4479/D 4479M, "Asphalt Roof Coatings – Asbestos-Free," in which case, they shall be installed in accordance with Sentence 9.13.3.3.(3) and with reinforcing material,
  - d) ASTM D 4637/D 4637M, "EPDM Sheet Used In Single-Ply Roof Membrane,"
  - e) ASTM D 4811/D 4811M, "Nonvulcanized (Uncured) Rubber Sheet Used as Roof Flashing,"
  - f) ASTM D 6878/D 6878M, "Thermoplastic Polyolefin Based Sheet Roofing,"
  - g) CGSB 37-GP-9Ma, "Primer, Asphalt, Unfilled, for Asphalt Roofing, Dampproofing and Waterproofing," where a primer is required,
  - h) CAN/CGSB-37.50-M, "Hot-Applied, Rubberized Asphalt for Roofing and Waterproofing,"
  - i) CAN/CGSB-37.54, "Polyvinyl Chloride Roofing and Waterproofing Membrane,"
  - j) CGSB 37-GP-56M, "Membrane, Modified, Bituminous, Prefabricated, and Reinforced for Roofing,"



- k) CAN/CGSB-37.58-M, "Membrane, Elastomeric, Cold-Applied Liquid, for Non-Exposed Use in Roofing and Waterproofing,"
- l) CAN/CSA-A123.2, "Asphalt-Coated Roofing Sheets,"
- m) CAN/CSA-A123.4, "Asphalt for Constructing Built-Up Roof Coverings and Waterproofing Systems," in which case, they shall be installed with reinforcing material, or
- n) CSA A123.17, "Asphalt Glass Felt Used in Roofing and Waterproofing."

### 9.13.3.3. Preparation of Surface

- 1) Surfaces to be waterproofed shall be prepared in accordance with the instructions of the waterproofing material manufacturer.
- 2) Where the waterproofing material is to be applied on ICF walls, the instructions of the ICF wall manufacturer shall be followed.
- 3) Unit masonry walls that are to be waterproofed shall be parged on exterior surfaces below ground level with not less than 6 mm of mortar conforming to Section 9.20. covered over the footing.
- 4) Concrete walls that are to be waterproofed shall have all holes and recesses sealed with mortar or waterproofing material.
- 5) Surfaces required to be waterproofed shall be clean and dry and free of ice, snow, frost, dust, dirt, oil, grease, cracks, projections and depressions, loose particles and debris that could be detrimental to the performance of the waterproofing material.

### 9.13.3.4. Application of Waterproofing Membranes

- 1) Unless otherwise stated in this Subsection, waterproofing shall be installed in accordance with the manufacturer's instructions with regard to
  - a) surface priming,
  - b) conditions during application,
  - c) the required number of layers of reinforcing fabric on *foundation*, footings, floors, walls and structural slabs,
  - d) application quantity and rate, and
  - e) curing times.
- 2) Waterproofing shall be continuous across joints and at junctions between different *building* elements.
- 3) The waterproofed surface shall be protected with a suitable material to minimize mechanical damage during backfilling.
- 4) The area in which the waterproofing is to be carried out shall be kept free of water during the application and curing of the waterproofing system.

### 9.13.3.5. Floor Waterproofing System

- 1) *Basement* floors-on-ground to be waterproofed shall have a system of membrane waterproofing provided between 2 layers of concrete, each of which shall be not less than 75 mm thick, with the floor membrane made continuous with the wall membrane to form a complete seal.

## 9.13.4. Soil Gas Control

(See Note A-9.13.4.)

### 9.13.4.1. Application and Scope

- 1) This Subsection applies to
  - a) wall, roof and floor assemblies separating *conditioned space* from the ground, and
  - b) the rough-in to allow the future protection of *conditioned space* that is separated from the ground by a wall, roof or floor assembly.
- 2) This Subsection addresses the leakage of *soil* gas from the ground into the *building*.

**9.13.4.2. Protection from Soil Gas Ingress**

**1)** All wall, roof and floor assemblies separating *conditioned space* from the ground shall be protected by an *air barrier system* conforming to Subsection 9.25.3.

**2)** Unless the space between the *air barrier system* and the ground is designed to be accessible for the future installation of a subfloor depressurization system, *dwelling units* and *buildings* containing *residential occupancies* shall be provided with the rough-in for a radon extraction system conforming to Article 9.13.4.3.

**3)** Where *buildings* are used for *occupancies* other than those described in Sentence (2), protection from radon ingress and the means to address high radon concentrations in the future shall conform to

- a) Article 9.13.4.3., or
- b) Parts 5 and 6 (see Article 5.4.1.1. and 6.2.1.1.).

(See Note A-9.13.4.2.(3).)

**9.13.4.3. Providing for the Rough-in for a Subfloor Depressurization System**

(See Note A-9.13.4.3.)

**1)** Floors-on-ground shall be provided with a rough-in for subfloor depressurization consisting of

- a) a gas-permeable layer, an inlet and an outlet as described in Sentence (2), or
- b) clean granular material and a pipe as described in Sentence (3).

**2)** The rough-in referred to in Clause (1)(a) shall include

- a) a gas-permeable layer installed in the space between the air barrier and the ground to allow the depressurization of that space,
- b) an inlet that allows for the effective depressurization of the gas-permeable layer (see Note A-9.13.4.3.(2)(b) and (3)(b)(i)), and
- c) an outlet in the *conditioned space* that
  - i) permits connection to depressurization equipment,
  - ii) is sealed to maintain the integrity of the *air barrier system*, and
  - iii) is clearly labeled to indicate that it is intended only for the removal of radon from below the floor-on-ground.

**3)** The rough-in referred to in Clause (1)(b) shall include

- a) clean granular material installed below the floor-on-ground in accordance with Sentence 9.16.2.1.(1), and
- b) a pipe not less than 100 mm in diameter installed through the floor, such that
  - i) its bottom end opens into the granular layer required Clause (a) at or near the centre of the floor and not less than 100 mm of granular material projects beyond the terminus of the pipe measured along its axis (see Note A-9.13.4.3.(2)(b) and (3)(b)(i)),
  - ii) its top end permits connection to depressurization equipment and is provided with an airtight cap, and
  - iii) the pipe is clearly labeled near the cap and, if applicable, every 1.8 m and at every change in direction to indicate that it is intended only for the removal of radon from below the floor-on-ground.

**Section 9.14. Drainage****9.14.1. Scope****9.14.1.1. Application**

**1)** This Section applies to subsurface drainage and to surface drainage.

**9.14.1.2. Crawl Spaces**

**1)** Drainage for crawl spaces shall conform to Section 9.18.

**9.14.1.3. Floors-on-Ground**

- 1) Drainage requirements beneath floors-on-ground shall conform to Section 9.16.

**9.14.2. Foundation Drainage****9.14.2.1. Foundation Wall Drainage**

- 1) Unless it can be shown to be unnecessary, the bottom of every exterior *foundation* wall shall be drained by drainage tile or pipe laid around the exterior of the *foundation* in conformance with Subsection 9.14.3. or by a layer of gravel or crushed *rock* in conformance with Subsection 9.14.4.
- 2) Where mineral fibre insulation or crushed *rock* backfill is provided adjacent to the exterior surface of a *foundation* wall,
  - a) the insulation or backfill shall extend to the footing level to facilitate the drainage of ground water to the *foundation's* drainage system (see Note A-9.14.2.1.(2)(a)), and
  - b) any pyritic material in the crushed *rock* shall be limited to a concentration that will not damage the *building* to a degree that would adversely affect its stability or the performance of assemblies (see Sentence 9.12.3.3.(2) and Note A-9.4.4.4.(1)).

**9.14.3. Drainage Tile and Pipe****9.14.3.1. Material Standards**

- 1) Drain tile and drain pipe for *foundation* drainage shall conform to
  - a) ASTM C 4, "Clay Drain Tile and Perforated Clay Drain Tile,"
  - b) ASTM C 412M, "Concrete Drain Tile (Metric),"
  - c) ASTM C 444M, "Perforated Concrete Pipe (Metric),"
  - d) ASTM C 700, "Vitrified Clay Pipe, Extra Strength, Standard Strength, and Perforated,"
  - e) BNQ 3624-115, "Polyethylene (PE) Pipe and Fittings – Flexible Pipes for Drainage – Characteristics and Test Methods,"
  - f) CAN/CSA-B182.1, "Plastic Drain and Sewer Pipe and Pipe Fittings," or
  - g) CSA G401, "Corrugated Steel Pipe Products."

**9.14.3.2. Minimum Size**

- 1) Drain tile or pipe used for *foundation* drainage shall be not less than 100 mm in diam.

**9.14.3.3. Installation**

- 1) Drain tile or pipe shall be laid on undisturbed or well-compacted *soil* so that the top of the tile or pipe is below the bottom of the floor slab or the ground cover of the crawl space.
- 2) Drain tile or pipe with butt joints shall be laid with 6 mm to 10 mm open joints.
- 3) The top half of joints referred to in Sentence (2) shall be covered with sheathing paper, 0.10 mm polyethylene or No. 15 asphalt or tar-saturated felt.
- 4) The top and sides of drain pipe or tile shall be covered with not less than 150 mm of crushed stone or other coarse clean granular material containing not more than 10% of material that will pass a 4 mm sieve.

**9.14.4.1.****9.14.4. Granular Drainage Layer****9.14.4.1. Type of Granular Material**

- 1) Granular material used to drain the bottom of a *foundation* shall consist of a continuous layer of crushed stone or other coarse clean granular material containing
  - a) not more than 10% of material that will pass a 4 mm sieve, and
  - b) no pyritic material in a concentration that will damage the *building* to a degree that would adversely affect its stability or the performance of assemblies (see Note A-9.4.4.4.(1)).

**9.14.4.2. Installation**

- 1) Granular material described in Article 9.14.4.1. shall be laid on undisturbed or compacted *soil* to a minimum depth of not less than 125 mm beneath the footing of the *building* and extend not less than 300 mm beyond the outside edge of the footings.

**9.14.4.3. Grading**

- 1) The bottom of an *excavation* drained by a granular layer shall be graded so that the entire area described in Article 9.14.4.2. is drained to a sump conforming to Article 9.14.5.2.

**9.14.4.4. Wet Site Conditions**

- 1) Where because of wet site conditions *soil* becomes mixed with the granular drainage material, sufficient additional granular material shall be provided so that the top 125 mm are kept free of *soil*.

**9.14.5. Drainage Disposal****9.14.5.1. Drainage Disposal**

- 1) *Foundation* drains shall drain to a sewer, drainage ditch or dry well.

**9.14.5.2. Sump Pits**

- 1) Where a sump pit is provided it shall be
  - a) not less than 750 mm deep,
  - b) not less than 0.25 m<sup>2</sup> in area, and
  - c) provided with a cover.
- 2) Covers for sump pits shall be designed
  - a) to resist removal by children, and
  - b) to be airtight in accordance with Sentence 9.25.3.3.(7).
- 3) Where gravity drainage is not practical, an automatic sump pump shall be provided to discharge the water from the sump pit described in Sentence (1) into a sewer, drainage ditch or dry well.

**9.14.5.3. Dry Wells**

- 1) Dry wells may be used only when located in areas where the natural *groundwater level* is below the bottom of the dry well.
- 2) Dry wells shall be not less than 5 m from the *building foundation* and located so that drainage is away from the *building*.

**9.14.6. Surface Drainage****9.14.6.1. Surface Drainage**

- 1) The *building* shall be located or the *building* site graded so that water will not accumulate at or near the *building*.

**9.14.6.2. Drainage away from Wells or Septic Disposal Beds**

1) Surface drainage shall be directed away from the location of a water supply well or septic tank disposal bed.

**9.14.6.3. Window Wells**

1) Every window well shall be drained to the footing level or other suitable location.

**9.14.6.4. Catch Basin**

1) Where runoff water from a driveway is likely to accumulate or enter a garage, a catch basin shall be installed to provide adequate drainage.

**9.14.6.5. Downspouts**

1) Downspouts shall conform to Article 9.26.18.2.

**Section 9.15. Footings and Foundations****9.15.1. Application****9.15.1.1. General**

(See Notes A-9.15.1.1. and A-9.4.4.6. and 9.15.1.1.)

- 1) Except as provided in Articles 9.15.1.2. and 9.15.1.3., this Section applies to
  - a) concrete or unit masonry *foundation* walls and concrete footings not subject to surcharge
    - i) on stable *soils* with an allowable bearing pressure of 75 kPa or greater, and
    - ii) for *buildings* of wood-frame or masonry construction,
  - b) wood-frame *foundation* walls and wood or concrete footings not subject to surcharge
    - i) on stable *soils* with an allowable bearing pressure of 75 kPa or greater, and
    - ii) for *buildings* of wood-frame construction, and
  - c) flat insulating concrete form *foundation* walls and concrete footings not subject to surcharge (see Note A-9.15.1.1.(1)(c) and 9.20.1.1.(1)(b))
    - i) on stable *soils* with an allowable bearing pressure of 75 kPa or greater, and
    - ii) for *buildings* of light-frame or flat insulating concrete form construction that are not more than 2 *storeys* in *building height*, with a maximum floor to floor height of 3 m, and containing only a single *dwelling unit*.

2) *Foundations* for applications other than as described in Sentence (1) shall be designed in accordance with Section 9.4.

**9.15.1.2. Permafrost**

1) *Buildings* erected on permafrost shall have *foundations* designed by a *designer* competent in this field in accordance with the appropriate requirements of Part 4.

**9.15.1.3. Foundations for Deformation-Resistant Buildings**

- 1) Where the superstructure of a detached *building* conforms to the requirements of the deformation resistance test in CSA Z240.2.1, "Structural Requirements for Manufactured Homes," the *foundation* shall be constructed in conformance with
  - a) the remainder of this Section, or
  - b) CSA Z240.10.1, "Site Preparation, Foundation, and Anchorage of Manufactured Homes."

**9.15.2.1.****9.15.2. General****9.15.2.1. Concrete**

- 1) Concrete shall conform to Section 9.3.

**9.15.2.2. Unit Masonry Construction**

1) Concrete block shall conform to CSA A165.1, "Concrete Block Masonry Units," and shall have a compressive strength over the average net cross-sectional area of the block of not less than 15 MPa.

2) Mortar, grout, mortar joints, corbelling and protection for unit masonry shall conform to Section 9.20.

- 3) For concrete block *foundation* walls required to be reinforced,
  - a) mortar shall be Type S, conforming to CSA A179, "Mortar and Grout for Unit Masonry,"
  - b) grout shall be coarse, conforming to CSA A179, "Mortar and Grout for Unit Masonry," and
  - c) placement of grout shall conform to CSA A371, "Masonry Construction for Buildings."

**9.15.2.3. Pier-Type Foundations**

1) Where pier-type *foundations* are used, the piers shall be designed to support the applied loads from the superstructure.

2) Where piers are used as a *foundation* system in a *building* of 1 storey in *building height*, the piers shall be installed to support the principal framing members and shall be spaced not more than 3.5 m apart along the framing, unless the piers and their footings are designed for larger spacings.

3) The height of piers described in Sentence (2) shall not exceed 3 times their least dimension at the base of the pier.

4) Where concrete block is used for piers described in Sentence (2), they shall be laid with cores placed vertically, and where the width of the *building* is 4.3 m or less, placed with their longest dimension at right angles to the longest dimension of the *building*.

**9.15.2.4. Wood-Frame Foundations**

- 1) *Foundations* of wood-frame construction shall conform to
  - a) CSA S406, "Permanent Wood Foundations for Housing and Small Buildings," or
  - b) Part 4.

(See Note A-9.15.2.4.(1).)

**9.15.3. Footings****9.15.3.1. Footings Required**

1) Footings shall be provided under walls, pilasters, columns, piers, fireplaces and *chimneys* that bear on *soil* or *rock*, except that footings may be omitted under piers or monolithic concrete walls if the safe *loadbearing* capacity of the *soil* or *rock* is not exceeded.

**9.15.3.2. Support of Footings**

1) Footings shall rest on undisturbed *soil*, *rock* or compacted granular *fill*.

2) Granular *fill* shall not contain pyritic material in a concentration that will damage the *building* to a degree that would adversely affect its stability or the performance of assemblies. (See also Article 9.4.4.4. and Note A-9.4.4.4.(1).)

**9.15.3.3. Application of Footing Width and Area Requirements**

- 1)** Except as provided in Sentence 9.15.3.4.(2), the minimum footing width or area requirements provided in Articles 9.15.3.4. to 9.15.3.7. shall apply to footings, where
  - a) the footings support
    - i) *foundation* walls of masonry, concrete, or flat insulating concrete form walls,
    - ii) above-ground walls of masonry, flat insulating concrete form walls or light wood-frame construction, and
    - iii) floors and roofs of light wood-frame construction,
  - b) the span of supported joists does not exceed 4.9 m, and
  - c) the specified *live load* on any floor supported by the footing does not exceed 2.4 kPa (see Table 4.1.5.3.).
- 2)** Except as provided in Sentence 9.15.3.4.(2), where the span of the supported joists exceeds 4.9 m, footings shall be designed in accordance with Section 4.2.
- 3)** Where the specified *live load* exceeds 2.4 kPa, footings shall be designed in accordance with Section 4.2.

**9.15.3.4. Basic Footing Widths and Areas**

- 1)** Except as provided in Sentences (2) and (3) and in Articles 9.15.3.5. to 9.15.3.7., the minimum footing width or area shall comply with Table 9.15.3.4.
- 2)** Where the supported joist span exceeds 4.9 m in *buildings* with light wood-frame walls, floors and roofs, footing widths shall be determined according to
  - a) Section 4.2., or
  - b) the following formula

$$W = w \bullet [\Sigma sjs / (storeys \bullet 4.9)]$$

where

- W = minimum footing width,
- w = minimum width of footings supporting joists not exceeding 4.9 m, as defined by Table 9.15.3.4.,
- Σ sjs = sum of the supported joist spans on each *storey* whose load is transferred to the footing, and
- storeys* = number of *storeys* supported by the footing.

(See Note A-9.15.3.4.(2).)

- 3)** Where a *foundation* rests on gravel, sand or silt in which the water table level is less than the width of the footings below the *bearing surface*,
  - a) the footing width for walls shall be not less than twice the width required by Sentences (1) and (2), and Articles 9.15.3.5. and 9.15.3.6., and
  - b) the footing area for columns shall be not less than twice the area required by Sentences (1) and (2) and Article 9.15.3.7.

**Table 9.15.3.4.**  
**Minimum Footing Sizes**  
 Forming Part of Sentence 9.15.3.4.(1)

No. of Floors Supported	Minimum Width of Strip Footings, mm		Minimum Footing Area for Columns Spaced 3 m o.c., <sup>(1)</sup> m <sup>2</sup>
	Supporting Exterior Walls <sup>(2)</sup>	Supporting Interior Walls <sup>(3)</sup>	
1	250	200	0.4
2	350	350	0.75
3	450	500	1.0

**Notes to Table 9.15.3.4.:**

- (1) See Sentence 9.15.3.7.(1).
- (2) See Sentence 9.15.3.5.(1).
- (3) See Sentence 9.15.3.6.(1).

**9.15.3.5. Adjustments to Footing Widths for Exterior Walls**

- 1) The strip footing widths for exterior walls shown in Table 9.15.3.4. shall be increased by
- 65 mm for each *storey* of masonry veneer over wood-frame construction supported by the *foundation* wall,
  - 130 mm for each *storey* of masonry construction supported by the *foundation* wall, and
  - 150 mm for each *storey* of flat insulating concrete form wall construction supported by the *foundation* wall.

**9.15.3.6. Adjustments to Footing Widths for Interior Walls**

- 1) The minimum strip footing widths for interior *loadbearing* masonry walls shown in Table 9.15.3.4. shall be increased by 100 mm for each *storey* of masonry construction supported by the footing.
- 2) Footings for interior non-*loadbearing* masonry walls shall be not less than 200 mm wide for walls up to 5.5 m high and the width shall be increased by 100 mm for each additional 2.7 m of height.

**9.15.3.7. Adjustments to Footing Area for Columns**

- 1) The footing area for column spacings other than shown in Table 9.15.3.4. shall be adjusted in proportion to the distance between columns.

**9.15.3.8. Footing Thickness**

- 1) Footing thickness shall be not less than the greater of
- 100 mm, or
  - the width of the projection of the footing beyond the supported element.

**9.15.3.9. Step Footings**

- 1) Where step footings are used,
- the vertical rise between horizontal portions shall not exceed 600 mm, and
  - the horizontal distance between risers shall not be less than 600 mm.

**9.15.4. Foundation Walls****9.15.4.1. Permanent Form Material**

- 1) Insulating concrete form units shall be manufactured of polystyrene conforming to the performance requirements of CAN/ULC-S701, "Thermal Insulation, Polystyrene, Boards and Pipe Covering," for Type 2, 3 or 4 polystyrene.

**9.15.4.2. Foundation Wall Thickness and Required Lateral Support**

- 1) Except as required in Sentence (2), the thickness of *foundation* walls made of unreinforced concrete block or solid concrete and subject to lateral earth pressure shall conform to Table 9.15.4.2.-A for walls not exceeding 3.0 m in unsupported height.
- 2) The thickness of concrete in flat insulating concrete form *foundation* walls shall be not less than the greater of
- 140 mm, or
  - the thickness of the concrete in the wall above.
- 3) *Foundation* walls made of flat insulating concrete form units shall be laterally supported at the top and at the bottom.



**Table 9.15.4.2.-A**  
**Thickness of Solid Concrete and Unreinforced Concrete Block Foundation Walls**  
 Forming Part of Sentence 9.15.4.2.(1)

Type of <i>Foundation</i> Wall	Minimum Wall Thickness, mm	Maximum Height of Finished Ground Above <i>Basement</i> Floor or Crawl Space Ground Cover, m			
		Height of <i>Foundation</i> Wall Laterally Unsupported at the Top <sup>(1)(2)</sup>	Height of <i>Foundation</i> Wall Laterally Supported at the Top <sup>(1)(2)</sup>		
			≤ 3.0 m	≤ 2.5 m	> 2.5 m and ≤ 2.75 m
Solid concrete, 15 MPa min. strength	150	0.8	1.5	1.5	1.4
	200	1.2	2.15	2.15	2.1
	250	1.4	2.3	2.6	2.5
	300	1.5	2.3	2.6	2.85
Solid concrete, 20 MPa min. strength	150	0.8	1.8	1.6	1.6
	200	1.2	2.3	2.3	2.2
	250	1.4	2.3	2.6	2.85
	300	1.5	2.3	2.6	2.85
Unreinforced concrete block	140	0.6	0.8	—	—
	190	0.9	1.2	(3)	(3)
	240	1.2	1.8	(3)	(3)
	290	1.4	2.2	—	—

**Notes to Table 9.15.4.2.-A:**

- (1) See Article 9.15.4.3.
- (2) See Article 9.15.4.6.
- (3) See Table 9.15.4.2.-B.

**4)** The thickness and reinforcing of *foundation* walls made of reinforced concrete block and subject to lateral earth pressure shall conform to Table 9.15.4.2.-B and Sentences (5) to (8), where

- a) the walls are laterally supported at the top,
- b) average stable *soils* are encountered, and
- c) wind loads on the exposed portion of the *foundation* are no greater than 0.70 kPa.

**5)** For concrete block walls required to be reinforced, continuous vertical reinforcement shall

- a) be provided at wall corners, wall ends, wall intersections, at changes in wall height, at the jambs of all openings and at movement joints,
- b) extend from the top of the footing to the top of the *foundation* wall, and
- c) where *foundation* walls are laterally supported at the top, have not less than 50 mm embedment into the footing, if the floor slab does not provide lateral support at the wall base.

**6)** For concrete block walls required to be reinforced, a continuous horizontal bond beam containing not less than one 15M bar shall be installed

- a) along the top of the wall,
- b) at the sill and head of all openings greater than 1.20 m in width, and
- c) at structurally connected floors.

**Table 9.15.4.2.-B**  
**Reinforced Concrete Block Foundation Walls Laterally Supported at the Top<sup>(1)</sup>**  
 Forming Part of Sentence 9.15.4.2.(4)

Maximum Height of Finished Ground Above Basement Floor or Crawl Space Ground Cover, m <sup>(2)</sup>	Size and Spacing of Continuous Vertical Reinforcement, M at mm o.c.					
	190 mm Minimum Wall Thickness			240 mm Minimum Wall Thickness		
	Foundation Wall Height			Foundation Wall Height		
	≤ 2.5 m	≤ 2.75 m	≤ 3.0 m	≤ 2.5 m	≤ 2.75 m	≤ 3.0 m
0.8	(3)	(3)	(3)	(3)	(3)	(3)
1	(3)	1-15M at 1 800	1-15M at 1 800	(3)	(3)	(3)
1.2	(3)	1-15M at 1 600	1-15M at 1 600	(3)	1-20M at 2 000	1-20M at 2 000
1.4	1-15M at 1 600	1-15M at 1 600	1-15M at 1 600	(3)	1-20M at 1 800	1-20M at 1 800
1.6	1-15M at 1 400	1-15M at 1 400	1-15M at 1 400	(3)	1-20M at 1 600	1-20M at 1 600
1.8	1-15M at 1 400	1-15M at 1 400	1-15M at 1 200	(3)	1-20M at 1 600	1-20M at 1 600
2	1-15M at 1 200	1-15M at 1 000 or 1-20M at 1 200	2-15M at 1 200	1-20M at 1 600	1-20M at 1 600	1-20M at 1 600
2.2	2-15M at 1 200	2-15M at 1 000	2-15M at 1 000	1-20M at 1 400	1-20M at 1 400	1-20M at 1 400
2.4	2-15M at 1 000	2-15M at 1 000	2-15M at 800	1-20M at 1 400	1-20M at 1 400	1-20M at 1 200
2.6	n/a	2-15M at 800 or 1-25M at 1 000	2-15M at 800 or 1-25M at 1 000	n/a	1-20M at 1 000	1-20M at 1 000
2.8	n/a	n/a	1-20M at 600	n/a	n/a	1-20M at 800 or 2-15M at 1 000
3	n/a	n/a	1-20M at 400 or 1-25M at 600	n/a	n/a	2-15M at 800

**Notes to Table 9.15.4.2.-B:**

- (1) See Article 9.15.4.3.  
 (2) See Article 9.15.4.6.  
 (3) No reinforcement required.

**7)** In concrete block walls required to be reinforced, all vertical bar reinforcement shall be installed along the centre line of the wall.

**8)** In concrete block walls required to be reinforced, ladder- or truss-type lateral reinforcement not less than 3.8 mm in diameter (no. 9 ASWG) shall be installed in the bed joint of every second masonry course.

**9.15.4.3. Foundation Walls Considered to be Laterally Supported at the Top**

**1)** Sentences (2) to (4) pertain to lateral support for walls described in Sentence 9.15.4.2.(1).

- 2)** *Foundation* walls shall be considered to be laterally supported at the top if
- such walls support a *solid masonry* superstructure,
  - the floor joists are embedded in the top of the *foundation* walls, or
  - the floor system is anchored to the top of the *foundation* walls with anchor bolts, in which case the joists may run either parallel or perpendicular to the *foundation* walls.

**3)** Unless the wall around an opening is reinforced to withstand earth pressure, the portion of the *foundation* wall beneath an opening shall be considered laterally unsupported if

- the opening is more than 1.2 m wide, or
- the total width of the openings in the *foundation* wall constitutes more than 25% of the length of the wall.

**4)** For the purposes of Sentence (3), the combined width of the openings shall be considered as a single opening if the average width is greater than the width of solid wall between them.

**5)** Flat insulating concrete form *foundation* walls shall be considered to be laterally supported at the top if the floor joists are installed according to Article 9.20.17.5.

**9.15.4.4. Foundation Walls Considered to be Laterally Supported at the Bottom**

**1)** Flat insulating concrete form *foundation* walls shall be considered to be laterally supported at the bottom where the *foundation* wall

- a) supports backfill not more than 1.2 m in height,
- b) is supported at the footing by a shear key and at the top by the ground floor framing, or
- c) is doweled to the footing with not less than 15M bars spaced not more than 1.2 m o.c.

**9.15.4.5. Reinforcement for Flat Insulating Concrete Form Foundation Walls**

**1)** Horizontal reinforcement in flat insulating concrete form *foundation* walls shall consist of

- a)
  - i) one 10M bar placed not more than 300 mm from the top of the wall, and
  - ii) 10M bars at 600 mm o.c., and
- b) be located
  - i) in the inside half of the wall section, and
  - ii) with a minimum cover of 30 mm from the inside face of the concrete.

**2)** Vertical reinforcement in flat insulating concrete form *foundation* walls shall be

- a) provided in accordance with
  - i) Table 9.15.4.5.-A for 140 mm walls,
  - ii) Table 9.15.4.5.-B for 190 mm walls, and
  - iii) Table 9.15.4.5.-C for 240 mm walls,
- b) located in the inside half of the wall section with a minimum cover of 30 mm from the inside face of the concrete wall, and
- c) where interrupted by wall openings, placed not more than 600 mm from each side of the openings.

**3)** Cold joints in flat insulating concrete form *foundation* walls shall be reinforced with no less than one 15M bar spaced at not more than 600 mm o.c. and embedded 300 mm on both sides of the joint.

**4)** Reinforcing around openings in flat insulating concrete form *foundation* walls shall comply with Article 9.20.17.3. or 9.20.17.4.

**Table 9.15.4.5.-A**  
**Vertical Reinforcement for 140 mm Flat Insulating Concrete Form Foundation Walls**  
 Forming Part of Sentence 9.15.4.5.(2)

Max. Height of Finished Ground Above Finished <i>Basement</i> Floor, m	Minimum Vertical Reinforcement		
	Maximum Unsupported <i>Basement</i> Wall Height		
	2.44 m	2.75 m	3.0 m
1.35	10M at 400 mm o.c.	10M at 400 mm o.c.	10M at 400 mm o.c.
1.6	10M at 400 mm o.c.	10M at 380 mm o.c.	10M at 380 mm o.c.
2	10M at 380 mm o.c.	10M at 380 mm o.c.	10M at 380 mm o.c.
2.2	10M at 250 mm o.c.	10M at 250 mm o.c.	10M at 250 mm o.c.
2.35	n/a	10M at 250 mm o.c.	10M at 250 mm o.c.
2.6	n/a	10M at 250 mm o.c.	10M at 250 mm o.c.
3	n/a	n/a	15M at 250 mm o.c.

**Table 9.15.4.5.-B**  
**Vertical Reinforcement for 190 mm Flat Insulating Concrete Form Foundation Walls**  
 Forming Part of Sentence 9.15.4.5.(2)

Max. Height of Finished Ground Above Finished <i>Basement</i> Floor, m	Minimum Vertical Reinforcement		
	Maximum Unsupported <i>Basement</i> Wall Height		
	2.44 m	2.75 m	3.0 m
2.2	None required	10M at 400 mm o.c.	10M at 400 mm o.c.
2.35	n/a	10M at 300 mm o.c.	10M at 300 mm o.c.
2.6	n/a	10M at 300 mm o.c.	15M at 400 mm o.c.
3.0	n/a	n/a	15M at 400 mm o.c.

**Table 9.15.4.5.-C**  
**Vertical Reinforcement for 240 mm Flat Insulating Concrete Form Foundation Walls**  
 Forming Part of Sentence 9.15.4.5.(2)

Max. Height of Finished Ground Above Finished <i>Basement</i> Floor, m	Minimum Vertical Reinforcement		
	Maximum Unsupported <i>Basement</i> Wall Height		
	2.44 m	2.75 m	3.0 m
2.2	None required	None required	None required
2.6	n/a	15M at 400 mm o.c.	15M at 400 mm o.c.
3.0	n/a	n/a	15M at 400 mm o.c.

#### 9.15.4.6. Extension above Ground Level

**1)** Exterior *foundation* walls shall extend not less than 150 mm above finished ground level.

#### 9.15.4.7. Reduction in Thickness

**1)** Where the top of a *foundation* wall is reduced in thickness to permit the installation of floor joists, the reduced section shall be not more than 350 mm high and not less than 90 mm thick.

**2)** Where the top of a *foundation* wall is reduced in thickness to permit the installation of a masonry exterior facing, the reduced section shall be

- a) not less than 90 mm thick, and
- b) tied to the facing material with metal ties conforming to Sentence 9.20.9.4.(3) spaced not more than
  - i) 200 mm o.c. vertically, and
  - ii) 900 mm o.c. horizontally.

**3)** The space between wall and facing described in Sentence (2) shall be filled with mortar.

#### 9.15.4.8. Corbelling

**1)** Corbelling of masonry *foundation* walls supporting *cavity walls* shall conform to Article 9.20.12.2.

#### 9.15.4.9. Crack Control Joints

**1)** Crack control joints shall be provided in *foundation* walls more than 25 m long at intervals of not more than 15 m.

**2)** Joints required in Sentence (1) shall be designed to resist moisture penetration and shall be keyed to prevent relative displacement of the wall portions adjacent to the joint.

**9.15.4.10. Interior Masonry Walls**

1) Interior masonry *foundation* walls not subject to lateral earth pressure shall conform to Section 9.20.

**9.15.5. Support of Joists and Beams on Masonry Foundation Walls**

**9.15.5.1. Support of Floor Joists**

1) Except as permitted in Sentence (2), *foundation* walls of hollow masonry units supporting floor joists shall be capped with

- a) not less than 50 mm of concrete,
- b) *solid masonry units* that are 100% solid and not less than 50 mm high, or
- c) semi-solid or hollow *solid masonry units* that have the top course completely filled with mortar, grout or concrete.

2) Capping required in Sentence (1) need not be provided

- a) in localities where termites are not known to occur,
- b) when the joists are supported on a wood plate not less than 38 mm by 89 mm, and
- c) when the siding overlaps the *foundation* wall not less than 12 mm.

**9.15.5.2. Support of Beams**

1) Not less than 190 mm depth of *solid masonry* shall be provided beneath beams supported on masonry.

2) Where the beam referred to in Sentence (1) is supported below the top of the *foundation* walls, the ends of such beams shall be protected from the weather.

**9.15.5.3. Pilasters**

1) Pilasters shall be provided under beams that frame into unit masonry *foundation* walls 140 mm or less in thickness.

2) Pilasters required in Sentence (1) shall be not less than 90 mm by 290 mm and shall be bonded or tied into the wall.

3) The top 200 mm of pilasters required in Sentence (1) shall be *solid masonry* with the cells of hollow or semi-solid units filled with mortar, grout or concrete.

**9.15.6. Parging and Finishing of Masonry Foundation Walls**

**9.15.6.1. Foundation Walls below Ground**

1) Concrete block *foundation* walls shall be parged on the exterior face below ground level as required in Section 9.13.

**9.15.6.2. Foundation Walls above Ground**

1) Exterior surfaces of concrete block *foundation* walls above ground level shall have tooled joints, or shall be parged or otherwise suitably finished.

**9.15.6.3. Form Ties**

1) All form ties shall be removed at least flush with the concrete surface.

**Section 9.16. Floors-on-Ground**

**9.16.1. Scope**

**9.16.1.1. Application**

1) This Section applies to floors supported on ground or on granular *fill* that do not provide structural support for the superstructure.

**9.16.1.2. Structural Floors**

1) Floors-on-ground that support loads from the superstructure shall be designed in conformance with Part 4.

**9.16.1.3. Required Floors-on-Ground**

1) All spaces within *dwelling units*, except crawl spaces, shall be provided with a floor-on-ground, where

- a) access is provided to the space, and
- b) a floor supported by the structure is not provided.

**9.16.1.4. Dampproofing and Waterproofing**

1) Dampproofing and waterproofing shall conform to Section 9.13.

**9.16.2. Material beneath Floors****9.16.2.1. Required Installation of Granular Material**

1) Except as provided in Sentence (2), not less than 100 mm of coarse clean granular material containing not more than 10% of material that will pass a 4 mm sieve shall be placed beneath floors-on-ground. (See also Subsection 9.13.4. and Note A-9.13.4.)

- 2) Granular material need not be installed under
  - a) slabs in garages, carports or accessory *buildings*, or
  - b) *buildings of industrial occupancy* where the nature of the process contained therein permits or requires the use of large openings in the *building* envelope even during the winter.

**9.16.2.2. Support of Floors**

1) Material that is susceptible to changes in volume due to variations in moisture content or chemical-microbiological oxidation shall not be used as *fill* beneath floors-on-ground in a concentration that will damage the *building* to a degree that would adversely affect its stability or the performance of assemblies. (See also Article 9.4.4.4. and Note A-9.4.4.4.(1).)

2) Material that is susceptible to changes in volume due to freezing shall not be used as *fill* beneath floors-on-ground that will be subjected to freezing temperatures. (See also Article 9.4.4.4. and Note A-9.4.4.4.(1).)

3) Except as provided in Sentence (4), *fill* beneath floors-on-ground shall be compacted.

4) *Fill* beneath floors-on-ground need not be compacted where the material is clean coarse aggregate containing not more than 10% of material that will pass a 4 mm sieve.

**9.16.3. Drainage****9.16.3.1. Control of Water Ingress**

1) Except as provided in Article 9.16.3.2. or where it can be shown to be unnecessary, ingress of water underneath a floor-on-ground shall be prevented by grading or drainage.

**9.16.3.2. Hydrostatic Pressure**

1) Where *groundwater levels* may cause hydrostatic pressure beneath a floor-on-ground, the floor-on-ground shall be

- a) a poured concrete slab, and
- b) designed to resist such pressures.

**9.16.3.3. Floor Drains**

1) When floor drains are required (see Section 9.31.), the floor surface shall be sloped so that no water can accumulate.

**9.16.4. Concrete**

**9.16.4.1. Surface Finish**

- 1) The finished surface of concrete floor slabs shall be trowelled smooth and even.
- 2) Dry cement shall not be added to the floor surfaces to absorb surplus water.

**9.16.4.2. Topping Course**

- 1) When a topping course is provided for a concrete floor slab, it shall consist of 1 part cement to 2.5 parts clean, well graded sand by volume, with a water/cement ratio approximately equal to that of the base slab.
- 2) When concrete topping is provided, it shall not be less than 20 mm thick.

**9.16.4.3. Thickness**

- 1) Concrete slabs shall not be less than 75 mm thick exclusive of concrete topping.

**9.16.4.4. Bond Break**

- 1) A bond-breaking material shall be placed between the slab and footings or *rock*.

**9.16.5. Wood**

**9.16.5.1. Wood-Frame Floors**

1) Floors-on-ground constructed of wood shall conform to CSA S406, "Permanent Wood Foundations for Housing and Small Buildings."

**Section 9.17. Columns**

**9.17.1. Scope**

**9.17.1.1. Application**

- 1) This Section applies to columns used to support
  - a) beams carrying loads from not more than 2 wood-frame floors where
    - i) the supported length of joists bearing on such beams does not exceed 5 m, and
    - ii) the *live load* on any floor does not exceed 2.4 kPa (see Table 4.1.5.3.),
  - b) beams or header joists carrying loads from not more than 2 levels of wood-frame balconies, decks or other accessible exterior platforms, or 1 level plus the roof, where
    - i) the supported length of joists bearing on such beams or joists does not exceed 5 m,
    - ii) the sum of the specified snow and *occupancy* loads does not exceed 4.8 kPa (see Sentence 9.4.2.3.(1) for the determination of load on platform-type constructions), and
    - iii) the platform serves only a single *suite* of *residential occupancy*, or
  - c) carport roofs (see Section 9.35.).
- 2) Columns for applications other than as described in Sentence (1) shall be designed in accordance with Part 4.

**9.17.2.1.**

**9.17.2. General**

**9.17.2.1. Location**

- 1) Columns shall be centrally located on a footing conforming to Section 9.15.

**9.17.2.2. Lateral Support**

- 1) Columns shall be securely fastened to the supported member to reduce the likelihood of lateral differential movement between the column and the supported member. (See also Article 9.23.6.2.)
- 2) Except as permitted by Sentence (3), columns shall be laterally supported to resist racking
  - a) directly, or
  - b) by connection to the supported members.
 (See Note A-9.17.2.2.(2).)
- 3) Columns need not be provided with lateral support as described in Sentence (2), where
  - a) the distance from finished ground to the underside of the joists is not more than 600 mm, and
  - b) the columns support a deck with no superstructure.

**9.17.3. Steel Columns**

**9.17.3.1. Size and Thickness**

- 1) Except as permitted in Sentence (2), steel pipe columns shall have an outside diameter of not less than 73 mm and a wall thickness of not less than 4.76 mm.
- 2) Columns of sizes other than as specified in Sentence (1) are permitted to be used where the *loadbearing* capacities are shown to be adequate.

**9.17.3.2. End Bearing Plates**

- 1) Except as permitted in Sentence (2), steel columns shall be fitted with not less than 100 mm by 100 mm by 6.35 mm thick steel plates at each end, and where the column supports a wooden beam, the top plate shall extend across the full width of the beam.
- 2) The top plate required in Sentence (1) need not be provided where a column supports a steel beam and provision is made for the attachment of the column to the beam.

**9.17.3.3. Paint**

- 1) Exterior steel columns shall be treated on the outside surface with at least one coat of rust-inhibitive paint.

**9.17.3.4. Design of Steel Columns**

- (See Note A-9.17.3.4.)
- 1) Where the imposed load does not exceed 36 kN, adjustable steel columns shall conform to CAN/CGSB-7.2, "Adjustable Steel Columns."
  - 2) Steel columns other than those described in Sentence (1) shall be designed in accordance with Part 4.

**9.17.4. Wood Columns**

**9.17.4.1. Column Sizes**

- 1) The width or diameter of a wood column shall be not less than the width of the supported member.



2) Except as provided in Article 9.35.4.2., columns shall be not less than 184 mm for round columns and 140 mm by 140 mm for rectangular columns, unless calculations are provided to show that lesser sizes are adequate.

#### 9.17.4.2. Materials

- 1) Wood columns shall be either solid, glued-laminated or built-up.
- 2) Built-up columns shall consist of not less than 38 mm thick full-length members
  - a) bolted together with not less than 9.52 mm diam bolts spaced not more than 450 mm o.c., or
  - b) nailed together with not less than 76 mm nails spaced not more than 300 mm o.c.
- 3) Glued-laminated columns shall conform to Section 4.3.

#### 9.17.4.3. Columns in Contact with Concrete

1) Wood columns shall be separated from concrete in contact with the ground by 0.05 mm polyethylene film or Type S roll roofing.

### 9.17.5. Unit Masonry Columns

#### 9.17.5.1. Materials

- 1) Unit masonry columns shall be built of masonry units
  - a) conforming to CSA A165.1, "Concrete Block Masonry Units," and
  - b) having a compressive strength over the net area of the block of not less than 15 MPa.

#### 9.17.5.2. Sizes

1) Unit masonry columns shall be not less than 290 mm by 290 mm or 240 mm by 380 mm in size.

### 9.17.6. Solid Concrete Columns

#### 9.17.6.1. Materials

1) Concrete shall conform to Section 9.3.

#### 9.17.6.2. Sizes

1) Concrete columns shall be not less than 200 mm by 200 mm for rectangular columns and 230 mm diam for circular columns.

## Section 9.18. Crawl Spaces

### 9.18.1. General

#### 9.18.1.1. Application

1) This Section applies to crawl spaces whose exterior walls have less than 25% of their total area above exterior ground level open to the outdoors.

#### 9.18.1.2. Foundations

1) *Foundations* enclosing crawl spaces shall conform to Section 9.15.

#### 9.18.1.3. Heated and Unheated Crawl Spaces

- 1) Crawl spaces shall be considered to be heated where the space
  - a) is used as a hot air *plenum*,

- b) contains heating ducts that are not sealed and insulated to minimize heat loss to the space, or
- c) is not separated from heated space in accordance with Section 9.25.

**2)** Heating of heated crawl spaces shall conform to Section 9.33.

**3)** Insulation, an *air barrier system* and a *vapour barrier* shall be installed in the walls of heated crawl spaces in accordance with Section 9.25.

## 9.18.2. Access

### 9.18.2.1. Access Openings

**1)** An access opening of not less than 500 mm by 700 mm shall be provided to each crawl space where the crawl space serves a single *dwelling unit*, and not less than 550 mm by 900 mm for other crawl spaces.

**2)** Access openings shall be fitted with a door or hatch, except when the crawl space is heated and the access opening into the crawl space is from an adjacent heated space.

## 9.18.3. Ventilation

### 9.18.3.1. Ventilation of Unheated Crawl Spaces

**1)** Unheated crawl spaces shall be ventilated by natural or mechanical means.

**2)** Where an unheated crawl space is ventilated by natural means, ventilation shall be provided to the outside air by not less than 0.1 m<sup>2</sup> of unobstructed vent area for every 50 m<sup>2</sup> of *floor area*.

**3)** Vents shall be

- a) uniformly distributed on opposite sides of the *building*, and
- b) designed to prevent the entry of snow, rain and insects.

### 9.18.3.2. Ventilation of Heated Crawl Spaces

**1)** Heated crawl spaces shall be ventilated in accordance with Section 9.32.

## 9.18.4. Clearance

(See also Article 9.3.2.9.)

### 9.18.4.1. Access Way to Services

**1)** Where equipment requiring service such as plumbing cleanouts, traps and burners is located in crawl spaces, an access way with a height and width of not less than 600 mm shall be provided from the access door to the equipment and for a distance of 900 mm on the side or sides of the equipment to be serviced.

## 9.18.5. Drainage

### 9.18.5.1. Drainage

**1)** Except where it can be shown to be unnecessary, the ingress of water into a crawl space shall be controlled by grading or drainage.

**2)** Drainage of *foundation* walls shall conform to Article 9.14.2.1.

**3)** Drainage of the ground cover or floor-on-ground in the crawl space shall conform to Subsection 9.16.3.

**4)** Drains shall conform to Section 9.14.

**9.18.6. Ground Cover****9.18.6.1. Ground Cover in Unheated Crawl Spaces**

- 1) Where a crawl space is unheated, a ground cover shall be provided consisting of not less than
  - a) 50 mm of asphalt,
  - b) 100 mm of 15 MPa Portland cement concrete,
  - c) Type S roll roofing, or
  - d) 0.10 mm polyethylene.
- 2) Joints in sheet-type ground cover required in Sentence (1) shall be lapped not less than 100 mm and weighted down.

**9.18.6.2. Ground Cover in Heated Crawl Spaces**

- 1) Where a crawl space is heated, a ground cover consisting of not less than 0.15 mm polyethylene sheet conforming to CAN/CGSB-51.34-M, "Vapour Barrier, Polyethylene Sheet for Use in Building Construction," shall be installed as part of an *air barrier system* in accordance with Subsection 9.25.3.
- 2) The ground cover required in Sentence (1) shall have its joints lapped not less than 300 mm, and
  - a) be sealed and evenly weighted down, or
  - b) be covered with concrete not less than 50 mm thick.
- 3) The perimeter of the ground cover required in Sentence (1) shall be sealed to the *foundation* wall. (See Notes A-9.13.4., A-9.25.3.4. and 9.25.3.6., and A-9.25.3.6.(2) and (3).)
- 4) All penetrations of the ground cover required in Sentence (1) shall be sealed against air leakage. (See Subsection 9.25.3.)

**9.18.7. Fire Protection****9.18.7.1. Crawl Spaces as Warm Air Plenums**

- 1) Only crawl spaces under 1-storey portions of *dwelling units* shall be used as warm-air *plenums*.
- 2) Enclosing material in crawl spaces described in Sentence (1), including insulation, shall have a surface *flame-spread rating* not greater than 150.
- 3) *Combustible* ground cover in crawl spaces described in Sentence (1) shall be protected beneath each register opening with *noncombustible* material.
- 4) The *noncombustible* register protection described in Sentence (3) shall
  - a) extend not less than 300 mm beyond the projection of the register opening, and
  - b) have up-turned edges.(See Note A-9.18.7.1.(4).)

**Section 9.19. Roof Spaces****9.19.1. Venting****9.19.1.1. Required Venting**

- 1) Except where it can be shown to be unnecessary, where insulation is installed between a ceiling and the underside of the roof sheathing, a space shall be provided between the insulation and the sheathing, and vents shall be installed to permit the transfer of moisture from the space to the exterior. (See Note A-9.19.1.1.(1).)

**9.19.1.2. Vent Requirements**

- 1) Except as provided in Sentence (2), the unobstructed vent area shall be not less than 1/300 of the insulated ceiling area.
- 2) Where the roof slope is less than 1 in 6 or in roofs that are constructed with roof joists, the unobstructed vent area shall be not less than 1/150 of the insulated ceiling area.
- 3) Required vents may be roof type, eave type, gable-end type or any combination thereof, and shall be distributed
  - a) uniformly on opposite sides of the *building*,
  - b) with not less than 25% of the required openings located at the top of the space, and
  - c) with not less than 25% of the required openings located at the bottom of the space.
- 4) Except where each joist space is separately vented, roof joist spaces shall be interconnected by installing purlins not less than 38 mm by 38 mm on the top of the roof joists.
- 5) Vents shall comply with CAN3-A93-M, "Natural Airflow Ventilators for Buildings."

**9.19.1.3. Clearances**

- 1) Except as provided in Sentence (2), not less than 63 mm of space shall be provided between the top of the insulation and the underside of the roof sheathing.
- 2) At the junction of sloped roofs and exterior walls, where preformed baffles are used to contain the insulation, the baffles shall
  - a) provide an unobstructed air space, between the insulation and the underside of the roof sheathing, that is
    - i) not less than 25 mm in dimension, and
    - ii) of sufficient cross area to meet the *attic or roof space* venting requirements of Article 9.19.1.2., and
  - b) extend vertically not less than 50 mm above the top of the insulation.
- 3) Ceiling insulation shall be installed in a manner that will not restrict the free flow of air through roof vents or through any portion of the *attic or roof space*.

**9.19.1.4. Mansard or Gambrel Roof**

- 1) The lower portion of a mansard or gambrel style roof need not be ventilated.
- 2) The upper portion of roofs described in Sentence (1) shall be ventilated in conformance with Articles 9.19.1.1. to 9.19.1.3.

**9.19.2. Access****9.19.2.1. Access**

- 1) Every *attic or roof space* shall be provided with an access hatch where the open space in the *attic or roof space* measures
  - a) 3 m<sup>2</sup> or more in area,
  - b) 1 m or more in length or width, and
  - c) 600 mm or more in height over at least the area described in Clauses (a) and (b).

(See Note A-9.19.2.1.(1).)

- 2) The hatch required in Sentence (1) shall be not less than 550 mm by 900 mm except that, where the hatch serves not more than one *dwelling unit*, the hatch may be reduced to 0.32 m<sup>2</sup> in area with no dimension less than 500 mm.
- 3) Hatchways to *attic or roof spaces* shall be fitted with doors or covers.

## Section 9.20. Masonry and Insulating Concrete Form Walls Not In Contact with the Ground

### 9.20.1. Application

#### 9.20.1.1. General

- 1)** Except as provided in Article 9.20.1.2., this Section applies to
  - a) unreinforced masonry and masonry veneer walls not in contact with the ground, where
    - i) the height of the walls constructed on the *foundation* walls does not exceed 11 m, and
    - ii) the roof or floor assembly above the *first storey* is not of concrete construction, and
  - b) flat insulating concrete form walls not in contact with the ground that (see Note A-9.15.1.1.(1)(c) and 9.20.1.1.(1)(b))
    - i) have a maximum floor-to-floor height of 3 m,
    - ii) are erected in *buildings* not more than 2 *storeys* in *building height* and containing only a single *dwelling unit*, and
    - iii) are erected in locations where the seismic spectral response acceleration,  $S_a(0.2)$ , is not greater than 0.4 (see Note A-9.20.1.2.).

**2)** For walls other than those described in Sentence (1), or where the masonry walls or insulating concrete form walls not in contact with the ground are designed for specified loads on the basis of ultimate and serviceability limit states, Subsection 4.3.2. shall apply.

#### 9.20.1.2. Earthquake Reinforcement

(See Note A-9.20.1.2.)

**1)** In locations where the spectral response acceleration,  $S_a(0.2)$ , is greater than 0.55, *loadbearing* elements of masonry *buildings* more than 1 *storey* in *building height* shall be reinforced with not less than the minimum amount of reinforcement required by Subsection 9.20.15.

**2)** In locations where the spectral response acceleration,  $S_a(0.2)$ , is greater than 0.35 but less than or equal to 0.55, *loadbearing* elements of masonry *buildings* 3 *storeys* in *building height* shall be reinforced with not less than the minimum amount of reinforcement required by Subsection 9.20.15.

### 9.20.2. Masonry Units

#### 9.20.2.1. Masonry Unit Standards

- 1)** Masonry units shall comply with
  - a) ASTM C 73, "Calcium Silicate Brick (Sand-Lime Brick),"
  - b) ASTM C 126, "Ceramic Glazed Structural Clay Facing Tile, Facing Brick, and Solid Masonry Units,"
  - c) ASTM C 212, "Structural Clay Facing Tile,"
  - d) CAN/CSA-A82, "Fired Masonry Brick Made from Clay or Shale,"
  - e) CSA A165.1, "Concrete Block Masonry Units,"
  - f) CSA A165.2, "Concrete Brick Masonry Units," or
  - g) CSA A165.3, "Prefaced Concrete Masonry Units."

#### 9.20.2.2. Used Brick

**1)** Used bricks shall be free of old mortar, soot or other surface coating and shall conform to Article 9.20.2.1.

**9.20.2.3. Glass Blocks**

1) Glass blocks shall not be used as *loadbearing* units or in the construction of fireplaces or *chimneys*.

**9.20.2.4. Cellular Concrete**

1) Masonry made with cellular concrete shall not be used in contact with the *soil* or exposed to the weather.

**9.20.2.5. Stone**

1) Stone shall be sound and durable.

**9.20.2.6. Concrete Blocks Exposed to the Weather**

1) Concrete blocks exposed to the weather shall have density and water absorption characteristics conforming to concrete types A, B, C, or D described in CSA A165.1, "Concrete Block Masonry Units."

**9.20.2.7. Compressive Strength**

1) The compressive strength of concrete blocks shall conform to Table 9.20.2.7.

**Table 9.20.2.7.**  
**Compressive Strength of Concrete Blocks**  
Forming Part of Sentence 9.20.2.7.(1)

Type of Unit	Minimum Compressive Strength Over Net Area, MPa	
	Exposed to Weather	Not Exposed to Weather
Solid or hollow concrete blocks	15	10
Solid <i>loadbearing</i> cellular blocks	Not permitted	5
Solid non- <i>loadbearing</i> cellular blocks	Not permitted	2

**9.20.3. Mortar****9.20.3.1. Mortar Materials**

1) Cementitious materials and aggregates for mortar and grout shall comply with CSA A179, "Mortar and Grout for Unit Masonry."

2) Water and aggregate shall be clean and free of significant amounts of deleterious materials.

3) Lime used in mortar shall be hydrated.

4) If lime putty is used in mortar, it shall be made by slaking quicklime in water for not less than 24 h or soaking hydrated lime in water for not less than 12 h.

**9.20.3.2. Mortar and Grout Mixes**

1) Mortar types shall be in accordance with Table 9.20.3.2.-A.

2) Mortar for glass block masonry shall be

- a) Type S Portland cement-lime where exposed to the exterior, or
- b) Type S or N where protected from the exterior.

3) Mortar shall be mixed within the proportion limits provided in Table 9.20.3.2.-B, with sufficient water to bring the mixture to a consistency adequate for laying masonry units.

4) Grout shall be mixed within the proportion limits provided in Table 9.20.3.2.-C, with sufficient water to provide a suitable flow to fill all voids completely, without excessive segregation or bleeding.

- 5)** Except as provided in Sentence (6), mortar shall be used and placed in final position
  - a) within 1.5 h after mixing when the air temperature is 25°C or higher, or
  - b) within 2.5 h after mixing when the air temperature is less than 25°C.
- 6)** Mortar and grout containing a set-control admixture shall be manufactured off-site in a batching plant and shall be used and placed in final position within a time not exceeding the useful life stipulated by the manufacturer.
- 7)** Grout used for reinforced masonry shall be placed in accordance with the requirements of CSA A371, "Masonry Construction for Buildings."

**Table 9.20.3.2.-A  
Mortar Use**

Forming Part of Sentence 9.20.3.2.(1)

Location	Building Element	Mortar Type
Exterior, Above Ground	Loadbearing walls and columns	S
	Non-loadbearing walls and columns	N or S
	Parapets, chimneys, masonry veneer	N or S
Exterior, At or Below Ground	Foundation walls and columns	S
Interior	Loadbearing walls and columns	N
	Non-loadbearing walls and columns	N

**Table 9.20.3.2.-B  
Mortar Mix Proportions (by volume)**  
Forming Part of Sentence 9.20.3.2.(3)

Mortar Type	Portland Cement	Lime	Masonry Cement Type N	Masonry Cement Type S	Fine Aggregate (damp, loose-state sand)
Type S	1	½	-	-	3½ to 4½
	-	-	-	1	2¼ to 3
	½	-	1	-	3½ to 4½
Type N	1	1	-	-	4½ to 6
	-	-	1	-	2¼ to 3

**Table 9.20.3.2.-C  
Grout Mix Proportions (by volume)**  
Forming Part of Sentence 9.20.3.2.(4)

Portland Cement	Lime	Fine Aggregate (sand)	Coarse Aggregate
1	0 to 1/10	2¼ to 3 times the sum of the cement and lime volumes	1 to 2 times the sum of the cement and lime volumes

**9.20.4. Mortar Joints**

**9.20.4.1. Thickness**

- 1)** Except as provided in Sentence (2), mortar joint thickness for burned clay brick and concrete masonry units shall be 10 mm.
- 2)** Permitted tolerances in head and bed joints shall be not more than ± 5 mm.

**9.20.4.2. Solid Masonry Units**

- 1)** Solid masonry units shall be laid with full head and bed joints.

**9.20.4.3. Laying of Masonry Units**

- 1) Hollow masonry units shall be laid with mortar applied to head and bed joints of both inner and outer face shells.
- 2) Vertically aligned webs of hollow masonry units shall be laid in a full bed of mortar
  - a) under the starting course,
  - b) in all courses of columns, and
  - c) where adjacent to cells or cavities that are to be filled with grout.
- 3) Except for head joints left open for weep holes and ventilation, *solid masonry units* shall be laid with full head and bed joints.

**9.20.5. Masonry Support****9.20.5.1. Masonry Support**

- 1) All masonry shall be supported on masonry, concrete or steel, except that masonry veneer walls may be supported on *foundations* of wood frame constructed in conformance with Sentence 9.15.2.4.(1). (See Note A-9.20.5.1.(1).)
- 2) Every masonry wall shall be at least as thick as the wall it supports, except as otherwise permitted in Article 9.20.12.2.

**9.20.5.2. Lintels or Arches**

- 1) Masonry over openings shall be supported by steel, masonry or reinforced concrete lintels, or masonry arches.
- 2) Steel angle lintels supporting masonry veneer above openings shall
  - a) conform to Table 9.20.5.2., and
  - b) have a bearing length not less than 90 mm.

**Table 9.20.5.2.**  
**Maximum Allowable Spans for Steel Lintels Supporting Masonry Veneer**  
 Forming Part of Sentence 9.20.5.2.(2)

Minimum Angle Size, mm			Maximum Allowable Spans, m		
Vertical Leg	Horizontal Leg	Thickness	Supporting 75 mm Brick	Supporting 90 mm Brick	Supporting 100 mm Stone
89	76	6.4	2.55	—	—
89	89	6.4	2.59	2.47	2.30
102	89	6.4	2.79	2.66	2.48
127	89	7.9	3.47	3.31	3.08
127	89	11	3.64	3.48	3.24

- 3) Steel angle lintels supporting masonry other than veneer, masonry and reinforced concrete lintels, and masonry arches shall be designed in accordance with Part 4 to support the imposed load.
- 4) Steel angle lintels supporting masonry shall be prime painted or otherwise protected from corrosion.

**9.20.6. Thickness and Height****9.20.6.1. Thickness of Exterior Walls**

- 1) Masonry exterior walls, other than *cavity walls*, in 1-storey buildings and the top storeys of 2- and 3-storey buildings shall be not less than 140 mm thick, provided the walls are not more than 2.8 m high at the eaves and 4.6 m high at the peaks of gable ends.
- 2) The exterior walls of the bottom storeys of 2-storey buildings, and exterior walls of the bottom 2 storeys of 3-storey buildings shall be not less than 190 mm thick.



3) In exterior walls composed of more than one wythe, each wythe shall be not less than 90 mm thick.

#### 9.20.6.2. Cavity Walls

1) *Cavity walls* shall be made with not less than 90 mm wide units if the joints are raked and not less than 75 mm wide units if the joints are not raked.

2) The width of a cavity in a *cavity wall* shall be not less than 50 mm and not greater than 150 mm.

3) The minimum thickness of *cavity walls* above the supporting base shall be 230 mm for the top 7.6 m and 330 mm for the remaining portion, except that where 75 mm wide units are used, the wall height above the top of the *foundation* wall shall not exceed 6 m.

#### 9.20.6.3. Thickness of Interior Walls

1) The thickness of *loadbearing* interior walls shall be determined on the basis of the maximum lateral support spacing as provided in Sentences 9.20.10.1.(2) and (3).

- 2) The thickness of interior non-*loadbearing* walls shall be
- determined on the basis of the maximum lateral support spacing as provided in Sentences 9.20.10.1.(2) and (3), and
  - in any case, not less than 65 mm.

#### 9.20.6.4. Masonry Veneer

1) Except for masonry veneer where each masonry unit is supported individually by the structural backing, masonry veneer shall consist of *solid masonry units* not less than 75 mm thick.

2) Veneer described in Sentence (1) over wood-frame walls shall have not less than a 25 mm air space behind the veneer.

3) Masonry veneer less than 90 mm thick shall have unraked joints.

4) Masonry veneer shall conform to Subsection 4.3.2., where the masonry units are required to be individually supported by the structural backing.

#### 9.20.6.5. Parapet Walls

1) The height of parapet walls above the adjacent roof surface shall be not more than 3 times the parapet wall thickness.

- 2) Parapet walls shall be *solid masonry*
- with the cells of hollow or semi-solid units filled with mortar, grout, or concrete, and
  - that extends from the top of the parapet to not less than 300 mm below the adjacent roof level.

#### 9.20.6.6. Stone or Concrete Facings

1) Slab and panel facings of precast concrete and natural or artificial stone shall conform to Subsection 4.3.2.

### 9.20.7. Chases and Recesses

#### 9.20.7.1. Maximum Dimensions

1) Except as permitted in Sentence 9.20.7.2.(2) and Article 9.20.7.4., the depth of any chase or recess shall not exceed one third the thickness of the wall, and the width of the chase or recess shall not exceed 500 mm.

#### 9.20.7.2. Minimum Wall Thickness

1) Except as permitted in Sentence (2) and Article 9.20.7.4., no chase or recess shall be constructed in any wall 190 mm or less in thickness.

2) Recesses may be constructed in 190 mm walls provided they do not exceed 100 mm in depth, 750 mm in height and 500 mm in width.

#### 9.20.7.3. Separation of Chases or Recesses

- 1) Chases and recesses shall be not less than
  - a) 4 times the wall thickness apart, and
  - b) 600 mm away from any pilaster, cross wall, buttress or other vertical element providing required lateral support for the wall.

#### 9.20.7.4. Non-Conforming Chases or Recesses

1) Chases or recesses that do not conform to the limits specified in Articles 9.20.7.1. to 9.20.7.3. shall be considered as openings, and any masonry supported above such a chase or recess shall be supported by a lintel or arch as provided in Article 9.20.5.2.

#### 9.20.7.5. Chases or Recesses Cut into Walls

1) Chases and recesses shall not be cut into walls made with hollow units after the masonry units are in place.

### 9.20.8. Support of Loads

#### 9.20.8.1. Capping of Hollow Masonry Walls

1) Except as permitted in Sentence (2), *loadbearing* walls of hollow masonry units supporting roof or floor framing members shall be capped with not less than 50 mm of *solid masonry* or have the top course filled with concrete.

2) Capping required in Sentence (1) may be omitted where the roof framing is supported on a wood plate not less than 38 mm by 89 mm.

#### 9.20.8.2. Cavity Walls Supporting Framing Members

1) Floor joists supported on *cavity walls* shall be supported on *solid masonry units* not less than 57 mm high.

2) Floor joists described in Sentence (1) shall not project into the cavity.

- 3) Roof and ceiling framing members bearing on *cavity walls* shall be supported on
  - a) *solid masonry units* not less than 57 mm high that bridge the full thickness of the wall, or
  - b) a wood plate not less than 38 mm thick, bearing not less than 50 mm on each wythe.

#### 9.20.8.3. Bearing of Beams and Joists

1) The bearing area under beams and joists shall be sufficient to carry the supported load.

2) In no case shall the minimum length of end bearing of beams supported on masonry be less than 90 mm.

3) The length of end bearing of floor, roof or ceiling joists supported on masonry shall be not less than 40 mm.

#### 9.20.8.4. Support of Beams and Columns

1) Beams and columns supported on masonry walls shall be supported on pilasters where the thickness of the masonry wall or wythe is less than 190 mm.

2) Not less than 190 mm depth of *solid masonry* or concrete shall be provided under the beam or column referred to in Sentence (1).

3) Pilasters required in Sentence (1) shall be bonded or tied to masonry walls.

4) Concrete pilasters required in Sentence (1) shall be not less than 50 mm by 300 mm.

5) Unit masonry pilasters required in Sentence (1) shall be not less than 100 mm by 290 mm.

#### 9.20.8.5. Projection of Masonry Veneer Beyond Supporting Members

- 1) Masonry veneer of *solid masonry units* resting on a bearing support shall not project more than one third of the thickness of the veneer. (See Note A-9.20.8.5.(1).)
- 2) Where the masonry veneer described in Sentence (1) is rough stone masonry,
  - a) the projection shall be measured as the average projection of the units, and
  - b) the thickness of the veneer shall be measured as the average thickness of the veneer.

### 9.20.9. Bonding and Tying

#### 9.20.9.1. Joints to be Offset or Reinforced

- 1) Vertical joints in adjacent masonry courses shall be offset unless each wythe of masonry is reinforced with the equivalent of not less than 2 corrosion-resistant steel bars of 3.76 mm diam placed in the horizontal joints at vertical intervals not exceeding 460 mm.
- 2) Where joints in the reinforcing referred to in Sentence (1) occur, the bars shall be lapped not less than 150 mm.

#### 9.20.9.2. Bonding or Tying of Other than Masonry Veneer

1) Except as provided in Article 9.20.9.5. regarding masonry veneer, masonry walls that consist of 2 or more wythes shall have the wythes bonded or tied together with masonry bonding units as described in Article 9.20.9.3. or with metal ties as described in Article 9.20.9.4.

#### 9.20.9.3. Bonding

- 1) Where wythes are bonded together with masonry units, the bonding units shall comprise not less than 4% of the wall surface area.
- 2) Bonding units described in Sentence (1) shall be spaced not more than 600 mm vertically and horizontally in the case of brick masonry and 900 mm o.c. in the case of block or tile.
- 3) Units described in Sentence (1) shall extend not less than 90 mm into adjacent wythes.

#### 9.20.9.4. Tying

- 1) Where 2 or more wythes are tied together with metal ties of the individual rod type, the ties shall conform to the requirements in Sentences (3) to (6).
- 2) Other ties may be used where it can be shown that such ties provide walls that are at least as strong and as durable as those made with the individual rod type.
- 3) Metal ties of the individual rod type shall
  - a) be corrosion-resistant,
  - b) have a minimum cross-sectional area of not less than 17.8 mm<sup>2</sup>, and
  - c) have not less than a 50 mm portion bent at right angles at each end.
- 4) Metal ties of the individual rod type shall
  - a) extend from within 25 mm of the outer face of the wall to within 25 mm of the inner face of the wall,
  - b) be completely embedded in mortar except for the portion exposed in *cavity walls*, and
  - c) be staggered from course to course.
- 5) Where 2 or more wythes in walls other than *cavity walls* and masonry veneer/masonry backing walls are tied together with metal ties of the individual rod type, the space between wythes shall be completely filled with mortar.

- 6) Ties described in Sentence (5) shall be
  - a) located within 300 mm of openings and spaced not more than 900 mm apart around openings, and
  - b) spaced not more than 900 mm apart horizontally and 460 mm apart vertically at other locations.
- 7) Except as required in Sentences (8) and (9), where the inner and outer wythes of *cavity walls* are tied with individual wire ties, the ties shall be spaced not more than 900 mm apart horizontally and 400 mm apart vertically.
- 8) Within 100 mm of the bottom of each floor or roof assembly where the cavity extends below the assemblies, the ties described in Sentence (7) shall be spaced not more than 600 mm apart horizontally.
- 9) Within 300 mm of any openings, the ties described in Sentence (7) shall be spaced not more than 900 mm apart.

**9.20.9.5. Ties for Masonry Veneer**

- 1) Masonry veneer 75 mm or more in thickness and resting on a bearing support shall be tied to masonry backing or to wood framing members with straps that are
  - a) corrosion-resistant,
  - b) not less than 0.76 mm thick,
  - c) not less than 22 mm wide,
  - d) shaped to provide a key with the mortar, and
  - e) spaced in accordance with Table 9.20.9.5.

**Table 9.20.9.5.**  
**Veneer Tie Spacing**  
Forming Part of Sentence 9.20.9.5.(1)

Maximum Vertical Spacing, mm	Maximum Horizontal Spacing, mm
400	800
500	600
600	400

- 2) Straps described in Sentence (1) that are fastened to wood framing members shall be
  - a) bent at a right angle within 6 mm from the fastener, and
  - b) fastened with corrosion-resistant 3.18 mm diam screws or spiral nails having a wood penetration of not less than 63 mm.
- 3) Masonry veneer individually supported by masonry or wood-frame backing shall be secured to the backing in conformance with Subsection 4.3.2.

**9.20.9.6. Reinforcing for Glass Block**

- 1) Glass block shall have horizontal joint reinforcement of 2 corrosion-resistant bars of not less than 3.76 mm diam or expanded metal strips not less than 75 mm wide
  - a) spaced at vertical intervals of not more than 600 mm for units 200 mm or less in height, and
  - b) installed in every horizontal joint for units higher than 200 mm.
- 2) Reinforcement required in Sentence (1) shall be lapped not less than 150 mm.

**9.20.10. Lateral Support**

**9.20.10.1. Lateral Support Required**

- 1) Masonry walls shall be laterally supported by floor or roof construction or by intersecting masonry walls or buttresses.

- 2) The spacing of supports required in Sentence (1) shall be not more than
  - a) 20 times the wall thickness for all *loadbearing* walls and exterior *non-loadbearing* walls, and
  - b) 36 times the wall thickness for interior *non-loadbearing* walls.
- 3) In applying Sentence (2), the thickness of *cavity walls* shall be taken as the greater of
  - a) two-thirds of the sum of the thicknesses of the wythes, or
  - b) the thickness of the thicker wythe.
- 4) Floor and roof constructions providing lateral support for walls as required in Sentence (1) shall be constructed to transfer lateral loads to walls or buttresses approximately at right angles to the laterally supported walls.

## 9.20.11. Anchorage of Roofs, Floors and Intersecting Walls

### 9.20.11.1. Anchorage to Floor or Roof Assemblies where Masonry Walls Require Lateral Support

- 1) Where required to receive lateral support (see Subsection 9.20.10.), masonry walls shall be anchored to each floor or roof assembly at maximum intervals of 2 m, except that anchorage to floor joists not more than 1 m above *grade* may be omitted.
- 2) Anchors required in Sentence (1) shall be corrosion-resistant and be not less than the equivalent of 40 mm by 4.76 mm thick steel straps.
- 3) Anchors required in Sentence (1) shall be shaped to provide a mechanical key with the masonry and shall be securely fastened to the horizontal support to develop the full strength of the anchor.
- 4) When joists are parallel to the wall, anchors required in Sentence (1) shall extend across not less than 3 joists.

### 9.20.11.2. Bonding and Tying Intersecting Masonry Walls where Walls Require Lateral Support

- 1) Where required to provide lateral support, intersecting walls shall be bonded or tied together.
- 2) Where bonding is used to satisfy the requirements of Sentence (1), 50% of the adjacent masonry units in the intersecting wall, distributed uniformly over the height of the intersection, shall be embedded in the laterally supported wall.
- 3) Where tying is used to satisfy the requirements of Sentence (1), the ties shall be
  - a) corrosion-resistant metal,
  - b) equivalent to not less than 4.76 mm by 40 mm steel strapping,
  - c) spaced not more than 800 mm o.c. vertically, and
  - d) shaped at both ends to provide sufficient mechanical key to develop the strength of the ties.

### 9.20.11.3. Anchoring Intersecting Wood-Frame Walls to Masonry Walls

- 1) Wood-frame walls shall be anchored to masonry walls that they intersect with not less than 4.76 mm diam corrosion-resistant steel rods spaced not more than 900 mm o.c. vertically.
- 2) Anchors required in Sentence (1) shall be fastened to the wood framing at one end and shaped to provide a mechanical key at the other end to develop the strength of the anchor.

### 9.20.11.4. Anchoring Wood-Frame Roof Systems to Masonry Walls

- 1) Except as permitted in Sentence (2), roof systems of wood-frame construction shall be anchored to exterior masonry walls by not less than 12.7 mm diam anchor bolts,
  - a) spaced not more than 2.4 m apart,
  - b) embedded not less than 90 mm into the masonry, and
  - c) fastened to a rafter plate of not less than 38 mm thick lumber.

2) The roof system described in Sentence (1) is permitted to be anchored by nailing the wall furring strips to the side of the rafter plate.

#### 9.20.11.5. Anchoring Masonry Cornices, Sills and Trim to Masonry Walls

1) Cornices, sills or other trim of masonry material which project beyond the wall face shall have not less than 65% of their mass, but not less than 90 mm, within the wall or shall be adequately anchored to the wall with corrosion-resistant anchors.

#### 9.20.11.6. Anchoring to Masonry Piers

1) Where anchor bolts are to be placed in the top of a masonry pier, the pier shall conform to the requirements of Sentence 9.15.2.3.(4) and shall be capped with concrete or reinforced masonry not less than 200 mm thick.

### 9.20.12. Corbelling

#### 9.20.12.1. Corbelling

1) All corbelling shall consist of *solid masonry units*.

2) The units referred to in Sentence (1) shall be corbelled so that the horizontal projection of any unit does not exceed 25 mm and the total projection does not exceed one third of the total wall thickness.

#### 9.20.12.2. Corbelling for Cavity Walls

1) *Cavity walls* of greater thickness than the *foundation* wall on which they rest shall not be corbelled but may project 25 mm over the outer face of the *foundation* wall disregarding parging.

2) Where the *foundation* wall referred to in Sentence (1) is unit masonry, it is permitted to be corbelled to meet flush with the inner face of a *cavity wall* provided

a) the projection of each course does not exceed half the height or one third the thickness of the corbelled unit, and

b) the total corbel does not exceed one third of the *foundation* wall thickness.

(See Note A-9.20.12.2.(2).)

#### 9.20.12.3. Corbelling for Masonry Veneer

1) Masonry veneer resting on a bearing support shall not project more than 25 mm beyond the supporting base where the veneer is not less than 90 mm thick, and 12 mm beyond the supporting base where the veneer is less than 90 mm thick.

2) In the case of rough stone veneer, the projection, measured as the average projection of the stone units, shall not exceed one-third the bed width beyond the supporting base.

### 9.20.13. Control of Rainwater Penetration

#### 9.20.13.1. Materials for Flashing

1) Materials used for flashing shall conform to Table 9.20.13.1.

**Table 9.20.13.1.**  
**Flashing Materials**  
 Forming Part of Sentence 9.20.13.1.(1)

Material	Minimum Thickness, mm	
	Exposed Flashing	Concealed Flashing
Aluminum	0.48	—
Copper	0.46	0.46
Copper or aluminum laminated to felt or kraft paper	—	0.05
Galvanized steel	0.33	0.33
Lead sheet	1.73	1.73
Polyethylene	—	0.50
Roll roofing, Type S	—	standard
Zinc	0.46	0.46

**2)** Aluminum flashing in contact with masonry or concrete shall be effectively coated or separated from the masonry or concrete by an impervious membrane.

**9.20.13.2. Fastening of Flashing**

**1)** Fastening devices for flashing shall be corrosion-resistant and, where metal flashing is used, shall be compatible with the flashing with respect to galvanic action.

**9.20.13.3. Location of Flashing**

- 1)** Flashing shall be installed in masonry and masonry veneer walls
  - a) beneath jointed masonry window sills,
  - b) over the back and top of parapet walls,
  - c) over the heads of glass block panels,
  - d) beneath weep holes, and
  - e) over the heads of window or door openings in exterior walls when the vertical distance between the top of a window or door frame and the bottom edge of the eave exceeds one-quarter of the horizontal eave overhang.

**9.20.13.4. Extension of Flashing**

**1)** When installed beneath jointed masonry window sills or over the heads of openings, flashing shall extend from the front edge of the masonry up behind the sill or lintel.

**9.20.13.5. Flashing for Weep Holes in Masonry/Masonry Walls**

- 1)** Flashing beneath weep holes in *cavity walls* and masonry veneer/masonry backing walls shall
  - a) be bedded not less than 25 mm in the inside wythe,
  - b) extend to not less than 5 mm beyond the outer face of the *building* element below the flashing, and
  - c) be installed with a nominally horizontal slope toward the outside wythe.

**9.20.13.6. Flashing for Weep Holes in Masonry Veneer**

**1)** Flashing beneath weep holes in masonry veneer over masonry backing walls shall conform to the flashing requirements for *cavity walls* and masonry veneer/masonry backing walls in Article 9.20.13.5.

**2)** Flashing beneath weep holes in masonry veneer over wood-frame walls shall be installed so that it extends from a point not less than 5 mm beyond the outer face of the *building* element below the flashing to a point 150 mm up the wood-frame wall.

**3)** Where the frame wall is sheathed with a sheathing membrane, a non-wood-based rigid exterior insulating sheathing or a semi-rigid insulating

sheathing with an integral sheathing membrane, the flashing shall be installed behind the sheathing membrane or insulating sheathing.

4) Flashing described in Sentence (2) is permitted to conform to the requirements for concealed flashing in Table 9.20.13.1.

#### 9.20.13.7. Flashing Joints

1) Joints in flashing shall be made watertight.

#### 9.20.13.8. Required Weep Holes

1) Weep holes spaced not more than 800 mm apart shall be provided at the bottom of

- a) cavities in *cavity walls*, and
- b) cavities or air spaces in masonry veneer walls.

2) The cavities or air spaces described in Sentence (1) shall include those above lintels over window and door openings required to be flashed in conformance with Article 9.20.13.3.

#### 9.20.13.9. Protection of Interior Finish

1) Except as provided in Sentence (3), where the interior finish of the exterior walls of a *building* is a type that may be damaged by moisture, exterior masonry walls, other than *cavity walls* or walls that are protected for their full height by a roof of a carport or porch, shall be covered on the interior surface with sheathing membrane conforming to CAN/CGSB-51.32-M, "Sheathing, Membrane, Breather Type," lapped not less than 100 mm at the joints.

2) In situations described in Sentence (1), flashing shall be provided where water will accumulate, to lead it to the exterior.

3) Where insulation that effectively limits the passage of water is applied by a waterproof adhesive or mortar directly to parged masonry, the requirements for sheathing membrane in Sentence (1) do not apply. (See Note A-9.20.13.9.(3).)

#### 9.20.13.10. Mortar Droppings

1) *Cavity walls* shall be constructed so that mortar droppings are prevented from forming a bridge to allow the passage of rain water across the cavity.

#### 9.20.13.11. Caulking at Door and Window Frames

1) The junction of door and window frames with masonry shall be caulked in conformance with Subsection 9.27.4.

#### 9.20.13.12. Drips beneath Window Sills

1) Where no flashing is installed beneath window sills, such sills shall be provided with a drip not less than 25 mm from the wall surface.

### 9.20.14. Protection during Work

#### 9.20.14.1. Laying Temperature of Mortar and Masonry

1) Mortar and masonry shall be maintained at a temperature not below 5°C during installation and for not less than 48 h after installation.

2) No frozen material shall be used in mortar mix.

#### 9.20.14.2. Protection from Weather

1) The top surface of uncompleted masonry exposed to the weather shall be completely covered with a waterproofing material when construction is not in progress.



**9.20.15. Reinforcement for Earthquake Resistance**

**9.20.15.1. Amount of Reinforcement**

1) Where reinforcement is required in this Section, masonry walls shall be reinforced horizontally and vertically with steel having a total cross-sectional area of not less than 0.002 times the horizontal cross-sectional area of the wall, so that not less than one-third of the required steel area is installed either horizontally or vertically and the remainder in the other direction.

**9.20.15.2. Installation Standard**

1) Where reinforcement for masonry is required in this Section, it shall be installed in conformance with the requirements for reinforced masonry as contained in CSA A371, "Masonry Construction for Buildings."

**9.20.16. Corrosion Resistance**

**9.20.16.1. Corrosion Resistance of Connectors**

1) Carbon steel connectors required to be corrosion-resistant shall be galvanized to at least the minimum standards in Table 9.20.16.1.

**Table 9.20.16.1.  
Minimum Requirements for Galvanizing  
Forming Part of Sentence 9.20.16.1.(1)**

Connector Material	ASTM Standard	Coating Class or Thickness
Wire ties and continuous reinforcing (hot-dipped galvanizing)	ASTM A 153/A 153M	Class B2 or 458 g/m <sup>2</sup>
Hardware and bolts	ASTM A 153/A 153M	See ASTM A 153/A 153M
Strip, plate, bars and rolled sections (not less than 3.18 mm thick)	ASTM A 123/A 123M	610 g/m <sup>2</sup>
Sheet (less than 3.18 mm thick)	ASTM A 123/A 123M	305 g/m <sup>2</sup> on material 0.76 mm thick <sup>(1)</sup>

**Notes to Table 9.20.16.1.:**

(1) ASTM A 123/A 123M does not apply to metal less than 3.18 mm thick. Galvanizing coatings may be interpolated for thicknesses between 3.18 mm and 0.76 mm.

**9.20.17. Above-Ground Flat Insulating Concrete Form Walls**

**9.20.17.1. Thickness of Flat Insulating Concrete Form Walls**

1) The thickness of the concrete in flat insulating concrete form walls not in contact with the ground shall be

- a) not less than 140 mm, and
- b) constant for the entire height of the wall.

**9.20.17.2. Reinforcement for Flat Insulating Concrete Form Walls**

1) Horizontal reinforcement in above-grade flat insulating concrete form walls shall

- a) consist of
  - i) one 10M bar placed not more than 300 mm from the top of the wall, and
  - ii) 10M bars at 600 mm o.c., and
- b) be placed in the middle third of the wall section.

2) Vertical reinforcement in above-grade flat insulating concrete form walls shall

- a) consist of 10M bars at 400 mm o.c., and
- b) be placed in the middle third of the wall section.

3) Vertical reinforcement required by Sentence (2) and interrupted by wall openings shall be placed not more than 600 mm from each side of the opening.

**9.20.17.3. Openings in Non-Loadbearing Flat Insulating Concrete Form Walls**

- 1) No openings shall occur within 1 200 mm of interior and exterior corners of exterior non-*loadbearing* flat insulating concrete form walls.
- 2) Portions of walls above openings in non-*loadbearing* flat insulating concrete form walls shall have a minimum depth of concrete of no less than 200 mm across the width of the opening.
- 3) Openings that are more than 600 mm but not more than 3 000 mm in width in non-*loadbearing* flat insulating concrete form walls shall be reinforced at the top and bottom with one 10M bar.
- 4) Openings more than 3 000 mm in width in non-*loadbearing* flat insulating concrete form walls shall be reinforced on all four sides with two 10M bars.
- 5) Reinforcing bars described in Sentences (3) and (4) shall extend 600 mm beyond the edges of the opening.
- 6) The cumulative width of openings in non-*loadbearing* flat insulating concrete form walls shall not make up more than 70% of the length of any wall.

**9.20.17.4. Openings in Loadbearing Flat Insulating Concrete Form Walls**

- 1) No openings shall occur within 1 200 mm of interior and exterior corners of exterior *loadbearing* flat insulating concrete form walls.
- 2) In *loadbearing* flat insulating concrete form walls, lintels shall be provided over all openings wider than 900 mm.
- 3) Lintels described in Sentence (2) shall be constructed in accordance with Span Table 9.20.17.4.-A, 9.20.17.4.-B or 9.20.17.4.-C.
- 4) Lintels described in Sentence (2) over openings wider than 1 200 mm shall be reinforced for shear with 10M stirrups at a maximum spacing of half the distance from the bottom reinforcing bar to the top of the lintel.

**9.20.17.5. Framing Supported on Flat Insulating Concrete Form Walls**

- 1) Floor joists supported on the side of flat insulating concrete form walls shall be supported with joist hangers secured to wood ledger boards.
- 2) The ledger boards referred to in Sentence (1) shall be not less than
  - a) 38 mm thick, and
  - b) the depth of the floor joists.
- 3) Anchor bolts shall be used to secure ledger boards to flat insulating concrete form walls and shall be
  - a) embedded in the wall to a depth not less than 100 mm, and
  - b) spaced in accordance with Table 9.20.17.5.
- 4) Floor joists and *building* frames supported on the top of flat insulating concrete form walls shall be anchored in conformance with Article 9.23.6.1.

**Table 9.20.17.5.**  
**Maximum Anchor Bolt Spacing for the Connection of Floor Ledgers to Flat Insulating Concrete Form Walls**  
 Forming Part of Sentence 9.20.17.5.(3)

Maximum Clear Floor Span, m	Maximum Anchor Bolt Spacing, mm	
	Staggered 12.7 mm Diameter Anchor Bolts	Staggered 16 mm Diameter Anchor Bolts
2.44	450	500
3.0	400	450
4.0	300	400
5.0	275	325

**9.20.17.6. Anchoring of Roof Framing to the Top of Flat Insulating Concrete Form Walls**

- 1)** Roof framing supported on the top of flat insulating concrete form walls shall be fixed to the top plates, which shall be anchored to the wall with anchor bolts
  - a) not less than 12.7 mm in diameter, and
  - b) spaced at not more than 1 200 mm o.c.
- 2)** The anchor bolts described in Sentence (1) shall be placed in the centre of the flat insulating concrete form wall and shall be embedded no less than 100 mm into the concrete.
- 3)** Attachment of roof framing to wood top plates shall be in accordance with Table 9.23.3.4.

**9.20.17.7. Protection from Precipitation and Damage**

- 1)** Above-ground flat insulating concrete form walls shall be protected from precipitation and damage in conformance with Section 9.27.

**Section 9.21. Masonry and Concrete Chimneys and Flues****9.21.1. General****9.21.1.1. Application**

- 1)** This Section applies to
  - a) rectangular *masonry or concrete chimneys* not more than 12 m in height serving fireplaces or serving *appliances* having a combined total rated heat output of 120 kW or less, and
  - b) *flue pipes* connected to such *chimneys*.
- 2)** *Chimneys*, other than those described in Sentence (1), *gas vents* and *flue pipes* serving gas-, oil- or solid-fuel-burning *appliances* and their associated equipment, including *stoves, cooktops, ovens* and *space heaters*, covered by the standards referenced in Sentences 9.33.5.2.(1) and 9.33.5.3.(1) shall conform to Subsection 9.33.10.
- 3)** *Chimneys* and *flue pipes* other than those described in Sentences (1) and (2) shall conform to Section 6.3.

**9.21.1.2. Chimney or Flue Pipe Walls**

- 1)** The walls of any *chimney* or *flue pipe* shall be constructed so as to be smoke- and flame-tight.

**9.21.2. Chimney Flues****9.21.2.1. Chimney Flue Limitations**

- 1)** A *chimney flue* that serves a fireplace or incinerator shall not serve any other *appliance*.
- 2)** A *chimney flue* that serves a solid-fuel-burning *appliance* shall not be connected to a natural-gas- or propane-fired *appliance*.
- 3)** A *chimney flue* that serves a solid-fuel-burning *appliance* shall not be connected to an oil-burning *appliance* unless the solid-fuel-burning *appliance* is certified for such installation and the installation of both *appliances* meets the requirements of the relevant standards referenced in Article 9.33.5.2.

**9.21.2.2. Connections of More Than One Appliance**

- 1)** Except as required by Article 9.21.2.1., where two or more fuel-burning *appliances* are connected to the same *chimney flue*, the connections shall be made as

described in Sentences (2) to (4) and an adequate draft shall be provided for the connected *appliances* in conformance with the requirements of applicable provincial or territorial regulations or municipal bylaws or, in the absence of such regulations or bylaws, with the requirements of the relevant standards listed in Subsection 9.33.10.

**2)** Where 2 or more fuel-burning *appliances* are connected to the same *chimney flue*, the *appliances* shall be located on the same *storey*.

**3)** The connection referred to in Sentence (2) for a solid-fuel-burning *appliance* shall be made below connections for *appliances* burning other fuels.

**4)** The connection referred to in Sentence (2) for a liquid-fuel-burning *appliance* shall be made below any connections for *appliances* burning natural gas or propane.

**9.21.2.3. Inclined Chimney Flues**

**1)** *Chimney flues* shall not be inclined more than 45° to the vertical.

**9.21.2.4. Size of Chimney Flues**

**1)** Except for *chimneys* serving fireplaces, the size of a *chimney flue* shall conform to the requirements of the *appliance* installation standards referenced in Sentences 9.33.5.2.(1) and 9.33.5.3.(1).

**2)** Where a *chimney flue* serves only one *appliance*, the *flue* area shall be at least equal to that of the *flue pipe* connected to it.

**9.21.2.5. Fireplace Chimneys**

**1)** The size of a *chimney flue* serving a masonry fireplace shall conform to Table 9.21.2.5.-A or 9.21.2.5.-B.

**Table 9.21.2.5.-A**  
**Diameter of Round Flues for Fireplace Chimneys**  
 Forming Part of Sentence 9.21.2.5.(1)

Fireplace Opening, m <sup>2</sup>	Chimney Height, m							
	3.0 to 4.5		> 4.5 to 5.9		> 5.9 to 8.9		> 8.9 to 12	
	Flue Diameter, mm							
	min.	max.	min.	max.	min.	max.	min.	max.
up to 0.150	110	170	100	160	90	150	90	150
0.151 to 0.250	150	210	130	190	130	190	120	180
0.251 to 0.350	180	240	160	220	150	210	140	200
0.351 to 0.500	220	280	200	260	190	250	170	230
0.501 to 0.650	260	320	230	290	220	280	200	260
0.651 to 0.800	290	350	260	320	240	300	220	280
0.801 to 1.00	330	390	290	350	270	330	250	310
1.01 to 1.20	360	420	320	380	300	360	270	330
1.21 to 1.40	390	450	350	410	330	390	300	360
1.41 to 1.60	420	480	380	440	350	410	320	380
1.61 to 1.80	—	—	400	460	370	430	340	400
1.81 to 2.00	—	—	—	—	400	460	360	420
2.01 to 2.20	—	—	—	—	—	—	380	440

Copyright © NRC 1941 - 2021 World Rights Reserved © CNRC 1941-2021 Droits réservés pour tous pays

**Table 9.21.2.5.-B**  
**Rectangular Flue Sizes for Fireplace Chimneys**  
 Forming Part of Sentence 9.21.2.5.(1)

Fireplace Opening, m <sup>2</sup>	Chimney Height, m							
	3.0 to 4.5		> 4.5 to 5.9		> 5.9 to 8.9		> 8.9 to 12	
	Flue Size, mm							
	min.	max.	min.	max.	min.	max.	min.	max.
up to 0.150	200 x 200	200 x 200	100 x 200	100 x 200	100 x 200	100 x 200	100 x 200	100 x 200
0.151 to 0.250	200 x 200	200 x 200	200 x 200	200 x 200	200 x 200	200 x 200	200 x 200	200 x 200
0.251 to 0.350	200 x 300	200 x 300	200 x 200	200 x 300	200 x 200	200 x 200	200 x 200	200 x 200
0.351 to 0.500	300 x 300	300 x 300	200 x 300	200 x 300	200 x 300	200 x 300	200 x 200	200 x 300
0.501 to 0.650	300 x 300	300 x 400	300 x 300	300 x 300	300 x 300	300 x 300	200 x 300	200 x 300
0.651 to 0.800	300 x 400	300 x 400	300 x 300	300 x 400	300 x 300	300 x 300	300 x 300	300 x 300
0.801 to 1.00	400 x 400	400 x 400	300 x 400	300 x 400	300 x 400	300 x 400	300 x 300	300 x 300
1.01 to 1.20	400 x 400	400 x 400	400 x 400	400 x 400	300 x 400	300 x 400	300 x 400	300 x 400
1.21 to 1.40	—	—	400 x 400	400 x 400	400 x 400	400 x 400	300 x 400	300 x 400
1.41 to 1.60	—	—	—	—	400 x 400	400 x 400	400 x 400	400 x 400
1.61 to 1.80	—	—	—	—	—	—	400 x 400	400 x 400
1.81 to 2.00	—	—	—	—	—	—	400 x 400	400 x 400

**9.21.2.6. Oval Chimney Flues**

1) The width of an oval *chimney flue* shall be not less than two-thirds its breadth.

**9.21.3. Chimney Lining**

**9.21.3.1. Lining Materials**

1) Every *masonry or concrete chimney* shall have a lining of clay, concrete, firebrick or metal.

**9.21.3.2. Joints in Chimney Liners**

1) Joints of *chimney liners* shall be sealed to provide a barrier to the passage of *flue* gases and condensate into the cavity between the liner and the surrounding masonry.

2) Joints of clay, concrete or firebrick *chimney liners* shall be struck flush to provide a straight, smooth, aligned *chimney flue*.

**9.21.3.3. Clay Liners**

1) Clay liners shall conform to CAN/CSA-A324-M, "Clay Flue Liners."

2) Liners referred to in Sentence (1) shall be not less than 15.9 mm thick and shall be capable of resisting, without softening or cracking, a temperature of 1 100°C.

**9.21.3.4. Firebrick Liners**

1) Firebrick liners shall conform to ASTM C 27, "Fireclay and High-Alumina Refractory Brick."

2) Firebrick liners shall be laid with high temperature cement mortar conforming to CAN/CGSB-10.3, "Air Setting Refractory Mortar."

**9.21.3.5. Concrete Liners**

1) Concrete *flue* liners shall conform to Clause 4.2.6.4 of CAN/CSA-A405-M, "Design and Construction of Masonry Chimneys and Fireplaces."

**9.21.3.6. Metal Liners**

1) Metal liners shall be constructed of not less than 0.3 mm thick stainless steel.

2) Metal liners referred to in Sentence (1) shall only be used in *chimneys* serving gas- or oil-burning *appliances*. (See Note A-9.21.3.6.(2).)

#### 9.21.3.7. Installation of Chimney Liners

1) *Chimney liners* shall be installed when the surrounding masonry or concrete is placed.

#### 9.21.3.8. Spaces between Liners and Surrounding Masonry

1) A space not less than 10 mm wide shall be left between a *chimney liner* and surrounding masonry.

2) The space required in Sentence (1) shall not be filled with mortar.

#### 9.21.3.9. Mortar for Chimney Liners

1) *Chimney liners* used in *chimneys* for solid-fuel-burning *appliances* shall be laid in a full bed of

- a) high temperature cement mortar conforming to CAN/CGSB-10.3, "Air Setting Refractory Mortar," or
- b) mortar consisting of 1 part Portland cement to 3 parts sand by volume.

2) *Chimney liners* used in *chimneys* for oil- or gas-burning *appliances* shall be laid in a full bed of mortar consisting of 1 part Portland cement to 3 parts sand by volume.

#### 9.21.3.10. Extension of Chimney Liners

1) *Chimney liners* shall extend from a point not less than 200 mm below the lowest *flue pipe* connection to a point not less than 50 mm or more than 100 mm above the *chimney* cap.

### 9.21.4. Masonry and Concrete Chimney Construction

#### 9.21.4.1. Unit Masonry

1) Unit masonry shall conform to Section 9.20.

#### 9.21.4.2. Concrete

1) Concrete shall conform to Section 9.3.

#### 9.21.4.3. Footings

1) Footings for *masonry chimneys* and *concrete chimneys* shall conform to Section 9.15.

#### 9.21.4.4. Height of Chimney Flues

1) A *chimney flue* shall extend not less than

- a) 900 mm above the highest point at which the *chimney* comes in contact with the roof, and
- b) 600 mm above the highest roof surface or structure within 3 m of the *chimney*.

(See Note A-9.21.4.4.(1).)

#### 9.21.4.5. Lateral Stability

1) Except as provided in Sentence (2), *chimneys* shall be braced in accordance with Subsection 4.3.2. to provide lateral stability under wind loads.

2) A *chimney* need not be laterally braced provided

- a) no horizontal outside dimension is less than 400 mm, and
- b) the *chimney* extends not more than 3.6 m above a roof or the masonry wall of which it forms a part.

(See Note A-9.21.4.5.(2).)

**9.21.4.6. Chimney Caps**

- 1) The top of a *chimney* shall have a waterproof cap of reinforced concrete, masonry or metal.
- 2) The cap required in Sentence (1) shall slope from the lining and be provided with a drip not less than 25 mm from the *chimney* wall.
- 3) Cast-in-place concrete caps shall be separated from the *chimney liner* by a bond break and be sealed at that location.
- 4) Jointed precast concrete or masonry *chimney* caps shall have flashing installed beneath the cap extending from the liner to the drip edge.

**9.21.4.7. Cleanout**

- 1) A cleanout opening with a metal frame and a tight-fitting metal door shall be installed near the base of the *chimney flue*.

**9.21.4.8. Wall Thickness**

- 1) The walls of a masonry *chimney* shall be built of *solid masonry units* not less than 75 mm thick.

**9.21.4.9. Separation of Flue Liners**

- 1) *Flue* liners in the same *chimney* shall be separated by not less than 75 mm of masonry or concrete exclusive of liners where clay liners are used, or 90 mm of firebrick where firebrick liners are used.
- 2) *Flue* liners referred to in Sentence (1) shall be installed to prevent significant lateral movement.

**9.21.4.10. Flashing**

- 1) Junctions with adjacent materials shall be adequately flashed to shed water.

**9.21.5. Clearance from Combustible Construction****9.21.5.1. Clearance from Combustible Materials**

- 1) The clearance between *masonry or concrete chimneys* and *combustible* framing shall be not less than
  - a) 50 mm for interior *chimneys*, and
  - b) 12 mm for exterior *chimneys*.(See Note A-9.21.5.1.(1).)
- 2) A clearance of not less than 150 mm shall be provided between a cleanout opening and *combustible* material.
- 3) *Combustible* flooring and subflooring shall have not less than a 12 mm clearance from *masonry or concrete chimneys*.

**9.21.5.2. Sealing of Spaces**

- 1) All spaces between *masonry or concrete chimneys* and *combustible* framing shall be sealed top or bottom with *noncombustible* material.

**9.21.5.3. Support of Joists or Beams**

- 1) Joists or beams may be supported on masonry walls which enclose *chimney flues* provided the *combustible* members are separated from the *flue* by not less than 290 mm of *solid masonry*.

## Section 9.22. Fireplaces

### 9.22.1. General

#### 9.22.1.1. Application

1) Except when otherwise specifically stated herein, this Section applies to masonry fireplaces constructed on-site.

#### 9.22.1.2. Masonry and Concrete

1) Except as otherwise stated in this Section, unit masonry shall conform to Section 9.20. and concrete to Section 9.3.

2) Masonry above openings shall be supported by steel lintels conforming to Sentence 9.20.5.2.(2), reinforced concrete or a masonry arch.

#### 9.22.1.3. Footings

1) Footings for masonry and concrete fireplaces shall conform to Section 9.15.

#### 9.22.1.4. Combustion Air

1) Where a supply of combustion air is provided directly to the fire chamber of a fireplace, including a factory-built fireplace, the installation shall comply with the "Outdoor Air Supply" requirements provided in CAN/CSA-A405-M, "Design and Construction of Masonry Chimneys and Fireplaces."

### 9.22.2. Fireplace Liners

#### 9.22.2.1. Brick or Steel Liners

1) Except where a fireplace is equipped with a steel liner, every fireplace shall have a firebrick liner.

#### 9.22.2.2. Firebrick Liners

1) Firebrick liners shall be not less than

- a) 50 mm thick for the sides and back, and
- b) 25 mm thick for the floor.

2) Firebrick liners shall be laid with high temperature cement mortar conforming to CAN/CGSB-10.3, "Air Setting Refractory Mortar."

3) Joints between a firebrick liner and the adjacent backing masonry shall be offset.

#### 9.22.2.3. Steel Liners

1) Steel liners for fireplaces shall conform to CAN/ULC-S639-M, "Steel Liner Assemblies for Solid-Fuel Burning Masonry Fireplaces," and shall be installed in accordance with the installation instructions in that standard.

### 9.22.3. Fireplace Walls

#### 9.22.3.1. Thickness of Walls

1) Except as provided in Sentence (2), the thickness of the back and sides of a fireplace, including the thickness of any firebrick liner, shall be not less than 190 mm where a metal liner or a firebrick liner less than 51 mm thick is used.

2) When a steel fireplace liner is used with an air circulating chamber surrounding the firebox, the back and sides of the fireplace shall consist of

- a) *solid masonry units* not less than 90 mm thick, or
- b) hollow masonry units not less than 190 mm thick.



**9.22.4. Fire Chamber****9.22.4.1. Fire Chamber Dimensions**

1) The distance from the back of the fire chamber to the plane of the fireplace opening shall be not less than 300 mm.

**9.22.5. Hearth****9.22.5.1. Hearth Extension**

1) Except as required in Sentence (2), fireplaces shall have a *noncombustible* hearth extending not less than 400 mm in front of the fireplace opening and not less than 200 mm beyond each side of the fireplace opening.

2) Where the fire chamber floor is elevated more than 150 mm above the hearth, the dimension of the hearth measured perpendicular to the plane of the fireplace opening shall be increased by not less than

- a) 50 mm for an elevation above 150 mm and not more than 300 mm, and
- b) an additional 25 mm for every 50 mm in elevation above 300 mm.

**9.22.5.2. Support of Hearth**

1) Except as permitted in Sentence (2), the fire chamber floor and hearth shall be supported on a reinforced concrete slab not less than 100 mm thick at its supports and, if cantilevered, not less than 50 mm thick at its unsupported edge.

2) A hearth for a fireplace with an opening raised not less than 200 mm from a *combustible* floor is permitted to be supported on that floor provided the requirements of Clauses 5.3.6.5. to 5.3.6.7. of CAN/CSA-A405-M, "Design and Construction of Masonry Chimneys and Fireplaces," are followed.

**9.22.6. Damper****9.22.6.1. Required Damper and Size**

1) The throat of every fireplace shall be equipped with a metal damper sufficiently large to cover the full area of the throat opening.

**9.22.7. Smoke Chamber****9.22.7.1. Slope of Smoke Chamber**

1) The sides of the smoke chamber connecting a fireplace throat with a *flue* shall not be sloped at an angle greater than 45° to the vertical.

**9.22.7.2. Wall Thickness**

1) The thickness of masonry walls surrounding the smoke chamber shall be not less than 190 mm at the sides, front and back, except that the portions of the back exposed to the outside may be 140 mm thick.

**9.22.8. Factory-Built Fireplaces****9.22.8.1. Conformance to Standard**

1) Factory-built fireplaces and their installation shall conform to CAN/ULC-S610-M, "Factory-Built Fireplaces."

**9.22.9. Clearance of Combustible Material****9.22.9.1. Clearance to the Fireplace Opening**

1) *Combustible* material shall not be placed on or near the face of a fireplace within 150 mm of the fireplace opening, except that where the *combustible* material projects

more than 38 mm out from the face of the fireplace above the opening, such material shall be not less than 300 mm above the top of the opening.

#### 9.22.9.2. Metal Exposed to the Interior

1) Metal exposed to the interior of a fireplace such as the damper control mechanism shall have not less than a 50 mm clearance from any *combustible* material on the face of the fireplace where such metal penetrates through the face of the fireplace.

#### 9.22.9.3. Clearance to Combustible Framing

1) Not less than a 100 mm clearance shall be provided between the back and sides of a fireplace and *combustible* framing, except that a 50 mm clearance is permitted where the fireplace is located in an exterior wall.

2) Not less than a 50 mm clearance shall be provided between the back and sides of the smoke chamber of a fireplace and *combustible* framing, except that a 25 mm clearance is permitted where the fireplace is located in an exterior wall.

#### 9.22.9.4. Heat-Circulating Duct Outlets

- 1) The clearance of *combustible* material above heat-circulating duct outlets from those outlets shall be not less than
- a) 300 mm where the *combustible* material projects not less than 38 mm from the face, and
  - b) 150 mm where the projection is less than 38 mm.

### 9.22.10. Fireplace Inserts and Hearth-Mounted Stoves

#### 9.22.10.1. Appliance Standard

1) Fireplace inserts and hearth-mounted *stoves* vented through the throat of a fireplace shall conform to ULC-S628, "Fireplace Inserts."

#### 9.22.10.2. Installation

1) The installation of fireplace inserts and hearth-mounted *stoves* vented through the throat of a fireplace shall conform to CSA B365, "Installation Code for Solid-Fuel-Burning Appliances and Equipment."

## Section 9.23. Wood-Frame Construction

### 9.23.1. Application

#### 9.23.1.1. Limitations

(See Note A-9.23.1.1.) (See also Note A-9.4.2.1.(1).)

- 1) This Section applies to constructions where wall, floor and roof planes are generally comprised of lumber frames of small repetitive structural members, or engineered components, and where
- a) roof and wall planes are clad, sheathed or braced on at least one side,
  - b) the small repetitive structural members are spaced not more than 600 mm o.c.,
  - c) the constructions do not serve as *foundations*,
  - d) the specified *live load* on supported subfloors and floor framing does not exceed 2.4 kPa, and
  - e) the span of any structural member does not exceed 12.20 m.

(See Note A-9.23.1.1.(1).)

2) Where the conditions in Sentence (1) are exceeded for wood constructions, the design of the framing and fastening shall conform to Subsection 4.3.1.

**9.23.2. General**

**9.23.2.1. Strength and Rigidity**

1) All members shall be so framed, anchored, fastened, tied and braced to provide the necessary strength and rigidity.

**9.23.2.2. Protection from Decay**

1) Ends of wood joists, beams and other members framing into masonry or concrete shall be treated to prevent decay where the bottom of the member is at or below ground level, or a 12 mm air space shall be provided at the end and sides of the member.

2) Air spaces required in Sentence (1) shall not be blocked by insulation, *vapour barriers* or airtight materials.

**9.23.2.3. Protection from Dampness**

1) Except as permitted in Sentence (2), wood framing members that are not pressure-treated with a wood preservative and that are supported on concrete in contact with the ground or *fill* shall be separated from the concrete by not less than 0.05 mm polyethylene film or Type S roll roofing.

2) Dampproofing material referred to in Sentence (1) is not required where the wood member is at least 150 mm above the ground.

**9.23.2.4. Lumber**

1) Lumber shall conform to Subsection 9.3.2.

**9.23.3. Fasteners**

**9.23.3.1. Standards for Nails and Screws**

1) Except as provided in Sentence (2) and unless otherwise indicated, nails specified in this Section shall be common steel wire nails or common spiral nails conforming to

- a) ASTM F 1667, "Driven Fasteners: Nails, Spikes, and Staples," or
- b) CSA B111, "Wire Nails, Spikes and Staples."

2) Nails used to comply with Table 9.23.3.4. shall have a diameter not less than that stated in Table 9.23.3.1. (See Note A-9.23.3.1.(2).)

**Table 9.23.3.1.**  
**Diameter of Nails**  
Forming Part of Sentence 9.23.3.1.(2)

Minimum Length of Nails, mm	Diameter of Nails, mm
57	2.87
63	3.25
76	3.66
82	3.66
101 or greater	4.88

3) Wood screws specified in this Section shall conform to ASME B18.6.1, "Wood Screws (Inch Series)." (See Note A-9.23.3.1.(3).)

**9.23.3.2. Length of Nails**

1) All nails shall be long enough so that not less than half their required length penetrates into the second member.

**9.23.3.3. Prevention of Splitting**

**1)** Splitting of wood members shall be minimized by staggering the nails in the direction of the grain and by keeping nails well in from the edges. (See Note A-9.23.3.3.(1).)

**9.23.3.4. Nailing of Framing**

**1)** Except as provided in Sentence (2), nailing of framing shall conform to Table 9.23.3.4.

**2)** Where the bottom wall plate or sole plate of an exterior wall is not nailed to floor joists, *rim joists* or blocking in conformance with Table 9.23.3.4., the exterior wall is permitted to be fastened to the floor framing by

- a) having plywood, OSB or waferboard sheathing extend down over floor framing and fastened to the floor framing by nails or staples conforming to Article 9.23.3.5., or
- b) tying the wall framing to the floor framing by galvanized-metal strips
  - i) 50 mm wide,
  - ii) not less than 0.41 mm thick,
  - iii) spaced not more than 1.2 m apart, and
  - iv) fastened at each end with at least two 63 mm nails.

**Table 9.23.3.4.**  
**Nailing for Framing**  
Forming Part of Sentence 9.23.3.4.(1)

Construction Detail	Minimum Length of Nails, mm	Minimum Number or Maximum Spacing of Nails
Floor joist or blocking perpendicular to sill plate or top wall plate below – toe nail	82	2 per floor joist or blocking
<i>Rim joist</i> , trimmer joist or blocking – supporting walls with required <i>braced wall panels</i> – to sill plate or top wall plate – toe nail	82	150 mm o.c.
Wood or metal strapping to underside of floor joists	57	2
Cross bridging to joists	57	2 at each end
Double header or trimmer joists	76	300 mm o.c.
Floor joist to stud (balloon construction)	76	2
Ledger strip to wood beam	82	2 per joist
Joist to joist splice (see also Table 9.23.14.8.)	76	2 at each end
Tail joist to adjacent header joist	82	5
(end nailed) around openings	101	3
Each header joist to adjacent trimmer joist	82	5
(end nailed) around openings	101	3
Stud to wall plate (each end) toe nail	63	4
or end nail	82	2
Doubled studs at openings, or studs at walls or wall intersections and corners	76	750 mm o.c.
Doubled top wall plates <sup>(1)</sup>	76	600 mm o.c.
Bottom wall plate or sole plate to floor joists, <i>rim joists</i> or blocking (exterior walls) <sup>(2)</sup>	82	400 mm o.c.
Bottom wall plate or sole plate – in required <i>braced wall panels</i> – to floor joists, <i>rim joists</i> or blocking (exterior walls) <sup>(2)</sup>	82	150 mm o.c.
Interior walls to framing or subflooring	82	600 mm o.c.
Required <i>braced wall panels</i> – in interior walls – to framing above and below	82	150 mm o.c.
Horizontal member over openings in non-loadbearing walls – each end	82	2
Lintels to studs	82	2 at each end
Ceiling joist to plate – toe nail each end	82	2
Roof rafter, roof truss or roof joist to plate – toe nail <sup>(3)</sup>	82	3
Rafter plate to each ceiling joist	101	2

Table 9.23.3.4. (Continued)

Construction Detail	Minimum Length of Nails, mm	Minimum Number or Maximum Spacing of Nails
Rafter to joist (with ridge supported)	76	3
Rafter to joist (with ridge unsupported)	76	see Table 9.23.14.8.
Gusset plate to each rafter at peak	57	4
Rafter to ridge board – toe nail – end nail	82	3
Collar tie to rafter – each end	76	3
Collar tie lateral support to each collar tie	57	2
Jack rafter to hip or valley rafter	82	2
Roof strut to rafter	76	3
Roof strut to <i>loadbearing</i> wall – toe nail	82	2
38 mm x 140 mm or less plank decking to support	82	2
Plank decking wider than 38 mm x 140 mm to support	82	3
38 mm edge laid plank decking to support (toe nail)	76	1
38 mm edge laid plank to each other	76	450 mm o.c.

**Notes to Table 9.23.3.4.:**

- (1) See Article 9.23.11.4. for requirements on the nailing of top plates in *braced wall bands*.
- (2) See Sentence 9.23.3.4.(2).
- (3) See Sentence 9.23.3.4.(3).

**3)** Where the 1-in-50 hourly wind pressure is equal to or greater than 0.8 kPa, roof rafters, joists or trusses shall be tied to the wall framing with connectors that will resist a factored uplift load of 3 kN.

**4)** Galvanized-steel straps are deemed to comply with Sentence (3), provided they are

- a) 50 mm wide,
- b) not less than 0.91 mm thick, and
- c) fastened at each end with at least four 63 mm nails.

**9.23.3.5. Fasteners for Sheathing or Subflooring**

**1)** Except as provided in Sentences (2) to (4), fastening of sheathing and subflooring shall conform to Table 9.23.3.5.-A.

**Table 9.23.3.5.-A**  
Fasteners for Subflooring and for Sheathing where the 1-in-50 HWP < 0.8 kPa and  $S_a(0.2) \leq 0.70$   
Forming Part of Sentence 9.23.3.5.(1)

Element	Minimum Length of Fasteners, mm				Minimum Number or Maximum Spacing of Fasteners
	Common or Spiral Nails	Ring Thread Nails or Screws	Roofing Nails	Staples	
Board lumber 184 mm or less wide	51	45	n/a	51	2 per support
Board lumber more than 184 mm wide	51	45	n/a	51	3 per support
Fibreboard sheathing up to 13 mm thick	n/a	n/a	44	28	150 mm o.c. along edges and 300 mm o.c. along intermediate supports
Gypsum sheathing up to 13 mm thick	n/a	n/a	44	n/a	
Plywood, OSB or waferboard up to 10 mm thick	51	45	n/a	38	
Plywood, OSB or waferboard over 10 mm and up to 20 mm thick	51	45	n/a	51	
Plywood, OSB or waferboard over 20 mm and up to 25 mm thick	57	51	n/a	n/a	

- 2)** Fastening of roof sheathing and sheathing in required *braced wall panels* shall conform to Table 9.23.3.5.-B, where
- the 1-in-50 hourly wind pressure (HWP) is equal to or greater than 0.8 kPa and less than 1.2 kPa and the seismic spectral response acceleration,  $S_a(0.2)$ , is not more than 0.90, or
  - the seismic spectral response acceleration,  $S_a(0.2)$ , is greater than 0.70 and not more than 0.90.

**Table 9.23.3.5.-B**  
**Fasteners for Sheathing where  $0.8 \text{ kPa} \leq 1\text{-in-50 HWP} < 1.2 \text{ kPa}$  and  $S_a(0.2) \leq 0.90$  or where  $0.70 < S_a(0.2) \leq 0.90$**   
 Forming Part of Sentence 9.23.3.5.(2)

Element	Minimum Length of Fasteners, mm			Minimum Number or Maximum Spacing of Fasteners
	Common, Spiral or Ring Thread Nails	Screws	14-gauge Staples	
Board lumber 184 mm or less wide	63	51	63	2 per support
Board lumber more than 184 mm wide	63	51	63	3 per support
Plywood, OSB or waferboard up to 20 mm thick <sup>(1)</sup>	63	51	63	150 mm o.c. along edges and 300 mm o.c. along intermediate supports; and for roof sheathing where HWP is equal to or greater than 0.8 kPa and less than 1.2 kPa, 50 mm o.c. within 1 m of the edges of the roof
Plywood, OSB or waferboard over 20 mm and up to 25 mm thick	63	57	n/a	

**Notes to Table 9.23.3.5.-B:**

(1) See Note A-Table 9.23.3.5.-B.

- 3)** Fastening of roof sheathing and sheathing in required *braced wall panels* shall conform to Table 9.23.3.5.-C, where
- the 1-in-50 hourly wind pressure (HWP) is equal to or greater than 0.8 kPa and less than 1.2 kPa and the spectral response acceleration,  $S_a(0.2)$ , is not more than 1.8, or
  - the seismic spectral response acceleration,  $S_a(0.2)$ , is greater than 0.90 and not more than 1.8.

**Table 9.23.3.5.-C**  
**Fasteners for Sheathing where  $0.8 \text{ kPa} \leq 1\text{-in-50 HWP} < 1.2 \text{ kPa}$  and  $S_a(0.2) \leq 1.8$  or where  $0.90 < S_a(0.2) \leq 1.8$**   
 Forming Part of Sentence 9.23.3.5.(3)

Element	Minimum Length of Fasteners, mm		Minimum Number or Maximum Spacing of Fasteners
	Common, Spiral or Ring Thread Nails	Screws	
Plywood, OSB or waferboard up to 20 mm thick <sup>(1)</sup>	63	51	75 mm o.c. along edges and 300 mm o.c. along intermediate supports; and for roof sheathing where 1-in-50 HWP is equal to or greater than 0.8 kPa and less than 1.2 kPa, 50 mm o.c. within 1 m of the edges of the roof
Plywood, OSB or waferboard over 20 mm and up to 25 mm thick	63	57	

**Notes to Table 9.23.3.5.-C:**

(1) See Note A-Table 9.23.3.5.-B.

- 4)** Fastening of sheathing shall conform to Part 4,
- where the 1-in-50 hourly wind pressure is equal to or greater than 1.2 kPa, or
  - for required *braced wall panels*, where the seismic spectral response acceleration,  $S_a(0.2)$ , is greater than 1.8.

- 5) Staples shall not be less than 1.6 mm in diameter or thickness, with not less than a 9.5 mm crown driven with the crown parallel to framing.
- 6) Roofing nails for the attachment of fibreboard or gypsum sheathing shall not be less than 3.2 mm in diameter with a minimum head diameter of 11.1 mm.
- 7) Flooring screws shall not be less than 3.2 mm in diameter.
- 8) The edges of sheathing in a *braced wall panel* shall be supported and fastened to wood blocking where
  - a) the seismic spectral response acceleration,  $S_a(0.2)$ , is greater than 1.2, or
  - b) the *braced wall panel* supports more than a roof of lightweight construction.

## 9.23.4. Maximum Spans

### 9.23.4.1. Application

- 1) Spans provided in this Subsection for joists, beams and lintels supporting floors shall apply only where
  - a) the floors serve residential areas as described in Table 4.1.5.3., or
  - b) the uniformly distributed *live load* on the floors does not exceed that specified for residential areas as described in Table 4.1.5.3.
- 2) Spans for joists, beams and lintels supporting floors shall be determined according to Subsection 4.1.3. where the supported floors
  - a) serve other than residential areas, or
  - b) support a uniform *live load* in excess of that specified for residential areas.

### 9.23.4.2. Spans for Joists, Rafters and Beams

(See Note A-9.23.4.2.)

- 1) Except as required in Sentence (2) and Article 9.23.14.10., spans for wood joists and rafters shall conform to the spans shown in Span Tables 9.23.4.2.-A to 9.23.4.2.-G for the uniform *live loads* shown in the Tables. (See Article 9.4.2.2.)
- 2) Spans for floor joists that are not selected from Span Tables 9.23.4.2.-A and 9.23.4.2.-B and that are required to be designed for the same loading conditions, shall not exceed the design requirements for uniform loading and vibration criteria. (See Note A-9.23.4.2.(2).)
- 3) Spans for built-up wood and glued-laminated timber floor beams shall conform to the spans in Span Tables 9.23.4.2.-H to 9.23.4.2.-K. (See Article 9.4.2.2.)
- 4) Spans for roof ridge beams shall conform to the spans in Span Table 9.23.4.2.-L for the uniform snow load shown. (See Articles 9.4.2.2. and 9.23.14.8.)

### 9.23.4.3. Steel Beams

- 1) The spans for steel floor beams with laterally supported top flanges shall conform to Table 9.23.4.3. (See Note A-9.23.4.3.(1).)
- 2) Beams described in Sentence (1) shall at least meet the requirements for Grade 350 W steel contained in CSA G40.21, "Structural Quality Steel."

**Table 9.23.4.3.**  
**Maximum Spans for Steel Beams Supporting Floors in Dwelling Units<sup>(1)</sup>**  
 Forming Part of Sentence 9.23.4.3.(1)

Section	Supported Joist Length, m (half the sum of joist spans on both sides of the beam)						
	2.4	3.0	3.6	4.2	4.8	5.4	6.0
<b>One Storey Supported</b>							
W150 x 22	5.5	5.2	4.9	4.8	4.6	4.5	4.3
W200 x 21	6.5	6.2	5.9	5.7	5.4	5.1	4.9
W200 x 27	7.3	6.9	6.6	6.3	6.1	5.9	5.8
W200 x 31	7.8	7.4	7.1	6.8	6.6	6.4	6.2
W250 x 24	8.1	7.6	7.3	7.0	6.6	6.2	5.9
W250 x 33	9.2	8.7	8.3	8.0	7.7	7.5	7.3
W250 x 39	10.0	9.4	9.0	8.6	8.4	8.1	7.9
W310 x 31	10.4	9.8	9.4	8.9	8.4	8.0	7.6
W310 x 39	11.4	10.7	10.2	9.8	9.5	9.2	9.0
<b>Two Storeys Supported</b>							
W150 x 22	4.9	4.4	4.1	3.8	3.5	3.4	3.2
W200 x 21	5.6	5.1	4.6	4.3	4.1	3.8	3.7
W200 x 27	6.4	6.1	5.6	5.3	4.9	4.7	4.4
W200 x 31	6.9	6.5	6.2	5.8	5.4	5.1	4.9
W250 x 24	6.8	6.1	5.6	5.2	4.9	4.6	4.4
W250 x 33	8.2	7.7	7.0	6.5	6.1	5.8	5.5
W250 x 39	8.8	8.3	7.8	7.2	6.8	6.4	6.1
W310 x 31	8.7	7.8	7.2	6.7	6.2	5.9	5.6
W310 x 39	10.0	9.3	8.5	7.9	7.4	7.0	6.7

**Notes to Table 9.23.4.3.:**

(1) See Note A-Table 9.23.4.3.

**9.23.4.4. Concrete Topping**

(See Note A-9.23.4.4.)

**1)** Except as permitted in Sentence (2), where a floor is required to support a concrete topping, the joist spans shown in Span Table 9.23.4.2.-A or the spacing of the members shall be reduced to allow for the loads due to the topping.

**2)** Where a floor is required to support a concrete topping, joist spans are permitted to be selected from Span Table 9.23.4.2.-B provided the concrete

- a) is 38 to 51 mm thick,
- b) is normal weight,
- c) is placed directly on the subflooring, and
- d) has not less than 20 MPa compressive strength after 28 days.

**3)** Where a floor is required to support a concrete topping not more than 51 mm thick, the allowable beam spans shown in Span Tables 9.23.4.2.-H to 9.23.4.2.-K shall be multiplied by 0.8 or the supported length of the floor joists shall be reduced to allow for the loads due to the topping.

**9.23.4.5. Heavy Roofing Materials**

**1)** Where a roof is required to support an additional uniform *dead load* from roofing materials such as concrete roofing tile, or materials other than as specified in



Section 9.27., such as clay roofing tiles, the additional load shall be allowed for by reducing

- a) the spans for roof joists and rafters in Span Tables 9.23.4.2.-D to 9.23.4.2.-G, or the spacing of the members, and
- b) the spans for ridge beams and lintels in Span Tables 9.23.4.2.-L and 9.23.12.3.-A to 9.23.12.3.-D.

(See Note A-9.23.4.2.)

## 9.23.5. Notching and Drilling

### 9.23.5.1. Holes Drilled in Framing Members

1) Holes drilled in roof, floor or ceiling framing members shall be not larger than one-quarter the depth of the member and shall be located not less than 50 mm from the edges, unless the depth of the member is increased by the size of the hole.

### 9.23.5.2. Notching of Framing Members

1) Floor, roof and ceiling framing members are permitted to be notched provided the notch is located on the top of the member within half the joist depth from the edge of bearing and is not deeper than one-third the joist depth, unless the depth of the member is increased by the size of the notch.

### 9.23.5.3. Wall Studs

1) Wall studs shall not be notched, drilled or otherwise damaged so that the undamaged portion of the stud is less than two-thirds the depth of the stud if the stud is *loadbearing* or 40 mm if the stud is *non-loadbearing*, unless the weakened studs are suitably reinforced.

### 9.23.5.4. Top Plates

1) Top plates in walls shall not be notched, drilled or otherwise weakened to reduce the undamaged width to less than 50 mm unless the weakened plates are suitably reinforced.

### 9.23.5.5. Roof Trusses

1) Roof truss members shall not be notched, drilled or otherwise weakened unless such notching or drilling is allowed for in the design of the truss.

## 9.23.6. Anchorage

### 9.23.6.1. Anchorage of Building Frames

1) Except as required by Sentence 9.23.6.3.(1), *building* frames shall be anchored to the *foundation* unless a structural analysis of wind and earthquake pressures shows anchorage is not required.

- 2) Except as provided in Sentences (3) to (6), anchorage shall be provided by
  - a) embedding the ends of the first floor joists in concrete, or
  - b) fastening the sill plate to the *foundation* with not less than 12.7 mm diam anchor bolts spaced not more than 2.4 m o.c.

3) For *buildings* with 2 or more floors supported by frame walls that are in areas where the seismic spectral response acceleration,  $S_a(0.2)$ , is not greater than 0.70 or the 1-in-50 hourly wind pressure (HWP) is equal to or greater than 0.80 kPa but not greater than 1.20 kPa, anchorage shall be provided by fastening the sill plate to the *foundation* with not less than two anchor bolts per *braced wall panel*, where all anchor bolts used are
 

- a) not less than 15.9 mm in diameter, located within 0.5 m of the end of the *foundation*, and spaced not more than 2.4 m o.c. or
- b) not less than 12.7 mm in diameter, located within 0.5 m of the end of the *foundation*, and spaced not more than 1.7 m o.c.

4) For *buildings* supported by frame walls that are in areas where the seismic spectral response acceleration,  $S_a(0.2)$ , is greater than 0.70 but not greater than 1.8 and the 1-in-50 hourly wind pressure (HWP) is not greater than 1.20 kPa, anchorage shall be provided by fastening the sill plate to the *foundation* with not less than two anchor bolts per *braced wall panel* located within 0.5 m of the end of the *foundation* and spaced in accordance with Table 9.23.6.1.

**Table 9.23.6.1.**  
**Anchor Bolt Spacing where the 1-in-50 HWP  $\leq$  1.20 kPa and  $0.70 < S_a(0.2) \leq 1.8$**   
 Forming Part of Sentence 9.23.6.1.(4)

Anchor Bolt Diameter, mm	$S_a(0.2)$	Maximum Spacing of Anchor Bolts Along <i>Braced Wall Band</i> , m				
		Light Construction			Heavy Construction <sup>(1)</sup>	
		Number of Floors Supported <sup>(2)</sup>				
		1	2	3	1	2
12.7	$0.70 < S_a(0.2) \leq 0.80$	2.4	2.3	1.8	2.4	2.0
	$0.80 < S_a(0.2) \leq 0.90$	2.4	2.3	1.8	2.4	2.0
	$0.90 < S_a(0.2) \leq 1.0$	2.4	2.2	1.5	2.4	1.8
	$1.0 < S_a(0.2) \leq 1.1$	2.4	2.1	1.4	2.4	1.6
	$1.1 < S_a(0.2) \leq 1.2$	2.4	2.0	1.3	2.4	1.5
	$1.2 < S_a(0.2) \leq 1.3$	2.4	1.9	1.3	2.4	1.5
	$1.3 < S_a(0.2) \leq 1.35$	2.4	1.8	1.2	2.3	1.4
	$1.35 < S_a(0.2) \leq 1.8$	2.4	1.8	1.1	2.3	1.4
15.9	$0.70 < S_a(0.2) \leq 0.80$	2.4	2.4	2.2	2.4	2.4
	$0.80 < S_a(0.2) \leq 0.90$	2.4	2.4	2.2	2.4	2.4
	$0.90 < S_a(0.2) \leq 1.0$	2.4	2.4	2.1	2.4	2.3
	$1.0 < S_a(0.2) \leq 1.1$	2.4	2.4	1.9	2.4	2.3
	$1.1 < S_a(0.2) \leq 1.2$	2.4	2.4	1.9	2.4	2.2
	$1.2 < S_a(0.2) \leq 1.3$	2.4	2.4	1.8	2.4	2.1
	$1.3 < S_a(0.2) \leq 1.35$	2.4	2.3	1.7	2.4	2.0
	$1.35 < S_a(0.2) \leq 1.8$	2.4	2.2	1.6	2.4	1.9

**Notes to Table 9.23.6.1.:**

(1) See Note A-9.23.13.2.(1)(a)(i).

(2) All constructions include support of a roof load in addition to the indicated number of floors.

- 5) Anchor bolts referred to in Sentences (2) to (4) shall be
- fastened to the sill plate with nuts and washers,
  - embedded not less than 100 mm in the *foundation*, and
  - so designed that they may be tightened without withdrawing them from the *foundation*.

6) Where the seismic spectral response acceleration,  $S_a(0.2)$ , is greater than 1.8 or the 1-in-50 hourly wind pressure is equal to or greater than 1.2 kPa, anchorage shall be designed according to Part 4.

**9.23.6.2. Anchorage of Columns and Posts**

1) Except as provided in Sentences (2) and (3), exterior columns and posts shall be anchored to resist uplift and lateral movement.

- 2) Except as provided in Sentence (3), where columns or posts support balconies, decks, verandas or other exterior platforms, and the distance from finished ground to the underside of the joists is not more than 600 mm,
  - a) the columns or posts shall be anchored to the *foundation* to resist uplift and lateral movement, or
  - b) the supported joists or beams shall be directly anchored to the ground to resist uplift.
- 3) Anchorage is not required for platforms described in Sentence (2) that
  - a) are not more than 1 *storey* in height,
  - b) are not more than 55 m<sup>2</sup> in area,
  - c) do not support a roof, and
  - d) are not attached to another structure, unless it can be demonstrated that differential movement will not adversely affect the performance of the structure to which the platform is attached.

### 9.23.6.3. Anchorage of Smaller Buildings

- 1) *Buildings* not more than 4.3 m wide and not more than 1 *storey* in *building height* that are not anchored in accordance with Sentence 9.23.6.1.(1) shall be anchored in conformance with the requirements of CSA Z240.10.1, "Site Preparation, Foundation, and Anchorage of Manufactured Homes."

### 9.23.7. Sill Plates

#### 9.23.7.1. Size of Sill Plates

- 1) Where sill plates provide bearing for the floor system, they shall be not less than 38 mm by 89 mm material.

#### 9.23.7.2. Levelling and Sealing of Sill Plates

- 1) Sill plates shall be
  - a) levelled by setting them on a full bed of mortar, or
  - b) laid directly on the *foundation* if the top of the *foundation* is level.
 (See also Article 9.23.2.3.)

- 2) The joint between the sill plate for exterior walls and the *foundation* shall be sealed in accordance with Subsection 9.25.3.

### 9.23.8. Beams to Support Floors

#### 9.23.8.1. Bearing for Beams

- 1) Beams shall have even and level bearing and the bearing at end supports shall be not less than 89 mm long, except as stated in the notes to Span Tables 9.23.4.2.-H to 9.23.4.2.-K.

#### 9.23.8.2. Priming of Steel Beams

- 1) Exterior steel beams shall be shop primed.

#### 9.23.8.3. Built-up Wood Beams

(See Note A-9.23.8.3.)

- 1) Where a beam is made up of individual pieces of lumber that are nailed together, the individual members shall be 38 mm or greater in thickness and installed on edge.

- 2) Except as permitted in Sentence (3), where individual members of a built-up beam are butted together to form a joint, the joint shall occur over a support.

- 3) Where a beam is continuous over more than one span, individual members are permitted to be butted together to form a joint at or within 150 mm of the end quarter points of the clear spans, provided the quarter points are not those closest to the ends of the beam.

- 4) Members joined at quarter points shall be continuous over adjacent supports.
- 5) Joints in individual members of a beam that are located at or near the end quarter points shall not occur in adjacent members at the same quarter point and shall not reduce the effective beam width by more than half.
- 6) Not more than one butt joint shall occur in any individual member of a built-up beam within any one span.
- 7) Except as provided in Sentence (8), where 38 mm members are laid on edge to form a built-up beam, individual members shall be nailed together with a double row of nails not less than 89 mm in length, spaced not more than 450 mm apart in each row with the end nails located 100 mm to 150 mm from the end of each piece.
- 8) Where 38 mm members in built-up wood beams are not nailed together as provided in Sentence (7), they shall be bolted together with not less than 12.7 mm diam bolts equipped with washers and spaced not more than 1.2 m o.c., with the end bolts located not more than 600 mm from the ends of the members.

### 9.23.9. Floor Joists

#### 9.23.9.1. End Bearing for Joists

- 1) Except when supported on ribbon boards, floor joists shall have not less than 38 mm length of end bearing.
- 2) Ribbon boards referred to in Sentence (1) shall be not less than 19 mm by 89 mm lumber let into the studs.

#### 9.23.9.2. Joists Supported by Beams

- 1) Floor joists may be supported on the tops of beams or may be framed into the sides of beams.
- 2) When framed into the side of a wood beam, joists referred to in Sentence (1) shall be supported on
  - a) joist hangers or other acceptable mechanical connectors, or
  - b) not less than 38 mm by 64 mm ledger strips nailed to the side of the beam, except that 38 mm by 38 mm ledger strips may be used provided each joist is nailed to the beam by not less than four 89 mm nails, in addition to the nailing for the ledger strip required in Table 9.23.3.4.
- 3) When framed into the side of a steel beam, joists referred to in Sentence (1) shall be supported on the bottom flange of the beam or on not less than 38 mm by 38 mm lumber bolted to the web with not less than 6.3 mm diam bolts spaced not more than 600 mm apart.
- 4) Joists referred to in Sentence (3) shall be spliced above the beam with not less than 38 mm by 38 mm lumber at least 600 mm long to support the flooring.
- 5) Not less than a 12 mm space shall be provided between the splice required in Sentence (4) and the beam to allow for shrinkage of the wood joists.

#### 9.23.9.3. Restraint of Joist Bottoms

- 1) Except as provided in Sentence 9.23.9.4.(1), bottoms of floor joists shall be restrained from twisting at each end by toe-nailing to the supports, end-nailing to the header joists or by providing continuous strapping, blocking between the joists or cross-bridging near the supports.

#### 9.23.9.4. Strapping, Bridging, Furring and Ceilings in Span Tables 9.23.4.2.-A and -B

(See Note A-9.23.4.2.(2).)

- 1) Except as permitted by Sentence (5), where strapping is specified in Span Table 9.23.4.2.-A, it shall be
  - a) not less than 19 mm by 64 mm, nailed to the underside of floor joists,

- b) located not more than 2 100 mm from each support or other rows of strapping, and
  - c) fastened at each end to a sill or header.
- 2)** Where bridging is specified in Span Table 9.23.4.2.-A, it shall consist of not less than 19 mm by 64 mm or 38 mm by 38 mm cross bridging located not more than 2 100 mm from each support or other rows of bridging.
- 3)** Where bridging and strapping are specified in Span Table 9.23.4.2.-A,
- a) bridging shall
    - i) comply with Sentence (2), or
    - ii) consist of 38 mm solid blocking located not more than 2 100 mm from each support or other rows of bridging and securely fastened between the joists, and
  - b) except as provided in Sentence (5), strapping shall comply with Sentence (1) and be installed under the bridging.
- 4)** Bridging specified in Span Table 9.23.4.2.-B shall consist of
- a) bridging as described in Sentence (2), or
  - b) 38 mm solid blocking located not more than 2 100 mm from each support or other rows of bridging and securely fastened between the joists.
- 5)** Strapping described in Sentence (1) and Clause (3)(b) is not required where
- a) furring strips complying with Table 9.29.3.1. are fastened directly to the joists, or
  - b) a panel-type ceiling finish complying with Subsection 9.29.5., 9.29.6., 9.29.7., 9.29.8., or 9.29.9. is attached directly to the joists.
- 6)** Where a ceiling attached to wood furring is specified in Span Table 9.23.4.2.-B,
- a) the ceiling finish shall consist of gypsum board, plywood or OSB not less than 12.7 mm thick, and
  - b) the furring shall be
    - i) 19 mm by 89 mm wood furring spaced at not more than 600 mm o.c., or
    - ii) 19 mm by 64 mm wood furring spaced at not more than 400 mm o.c.

**9.23.9.5. Header Joists**

- 1)** Header joists around floor openings shall be doubled when they exceed 1.2 m in length.
- 2)** The size of header joists exceeding 3.2 m in length shall be determined by calculations.

**9.23.9.6. Trimmer Joists**

- 1)** Trimmer joists around floor openings shall be doubled when the length of the header joist exceeds 800 mm.
- 2)** When the header joist exceeds 2 m in length the size of the trimmer joists shall be determined by calculations.

**9.23.9.7. Support of Tail and Header Joists**

- 1)** When tail joists and header joists are supported by the floor framing, they shall be supported by suitable joist hangers or nailing in accordance with Table 9.23.3.4.

**9.23.9.8. Support of Walls**

- 1)** Non-loadbearing walls parallel to the floor joists shall be supported by joists beneath the wall or on blocking between the joists.

- 2)** Blocking referred to in Sentence (1) for the support of non-*loadbearing* walls shall be
- a) not less than 38 mm by 89 mm lumber, and
  - b) except as required for the fastening of walls constructed with required *braced wall panels*, spaced not more than 1.2 m apart.
- 3)** Except as provided in Sentence (6), non-*loadbearing* interior walls at right angles to the floor joists are not restricted as to location.
- 4)** *Loadbearing* interior walls parallel to floor joists shall be supported by beams or walls of sufficient strength to safely transfer the specified *live loads* to the vertical supports.
- 5)** Unless the joist size is designed to support such loads, *loadbearing* interior walls at right angles to floor joists shall be located
- a) not more than 900 mm from the joist support where the wall does not support a floor, and
  - b) not more than 600 mm from the joist support where the wall supports one or more floors.
- 6)** *Loadbearing* and non-*loadbearing* walls constructed with required *braced wall panels* shall be continuously supported by floor joists, blocking or *rim joists* to allow for the required fastening (see Table 9.23.3.4.).

#### 9.23.9.9. Cantilevered Floor Joists

- 1)** Floor joists supporting roof loads shall not be cantilevered more than 400 mm beyond their supports where 38 mm by 184 mm joists are used and not more than 600 mm beyond their supports where 38 mm by 235 mm or larger joists are used.
- 2)** The cantilevered portions referred to in Sentence (1) shall not support floor loads from other *storeys* unless calculations are provided to show that the design resistances of the cantilevered joists are not exceeded.
- 3)** Where cantilevered floor joists described in Sentences (1) and (2) are at right angles to the main floor joists, the tail joists in the cantilevered portion shall extend inward away from the cantilever support a distance equal to not less than 6 times the length of the cantilever, and shall be end nailed to an interior doubled header joist in conformance with Table 9.23.3.4.

#### 9.23.10. Wall Studs

##### 9.23.10.1. Stud Size and Spacing

- 1)** The size and spacing of studs shall conform to Table 9.23.10.1.

**Table 9.23.10.1.**  
**Size and Spacing of Studs**  
 Forming Part of Sentence 9.23.10.1.(1)

Type of Wall	Supported Loads (including <i>dead loads</i> )	Minimum Stud Size, mm	Maximum Stud Spacing, mm <sup>(1)</sup>	Maximum Unsupported Height, m	
Interior	No load	38 x 38	400	2.4	
		38 x 89 flat <sup>(2)</sup>	400	3.6	
	Attic not accessible by a stairway	38 x 64	600	3.0	
		38 x 64 flat <sup>(2)</sup>	400	2.4	
		38 x 89	600	3.6	
		38 x 89 flat <sup>(2)</sup>	400	2.4	
	Attic accessible by a stairway plus one floor	Roof load plus one floor	38 x 89	400	3.6
		Attic not accessible by stairway plus 2 floors			
	Roof load	Attic accessible by a stairway	38 x 64	400	2.4
		Attic not accessible by a stairway plus one floor	38 x 89	600	3.6
Attic accessible by a stairway plus 2 floors		Roof load plus 2 floors	38 x 89	300	3.6
		64 x 89	400	3.6	
Roof load plus 2 floors		38 x 140	400	4.2	
	Attic accessible by a stairway plus 3 floors	38 x 140	300	4.2	
Exterior	Roof with or without attic storage	38 x 64	400	2.4	
		38 x 89	600	3.0	
	Roof with or without attic storage plus one floor	38 x 89	400	3.0	
		38 x 140	600	3.0	
	Roof with or without attic storage plus 2 floors	38 x 89	300	3.0	
		64 x 89	400	3.0	
	38 x 140	400	3.6		
	Roof with or without attic storage plus 3 floors	38 x 140	300	1.8	

**Notes to Table 9.23.10.1.:**

(1) See Note A-9.4.2.1.(1).

(2) See Article 9.23.10.3.

**9.23.10.2. Bracing and Lateral Support**

**1)** Where *loadbearing* interior walls are not finished in accordance with Section 9.29., blocking or strapping shall be fastened to the studs at mid-height to prevent sideways buckling.

**9.23.10.3. Orientation of Studs**

**1)** Except as permitted in Sentences (2) and (3), all studs shall be placed at right angles to the wall face.

**2)** Studs on the flat are permitted to be used in gable ends of roofs that contain only unfinished space or in non-*loadbearing* interior walls within the limits described in Article 9.23.10.1.

**3)** Wall studs that support only a load from an attic not accessible by a stairway are permitted to be placed on the flat within the limits permitted in Article 9.23.10.1. provided

- a) the studs are clad on not less than one side with plywood, OSB or waferboard sheathing fastened to the face of the studs with a structural adhesive, and
- b) the portion of the roof supported by the studs does not exceed 2.1 m in width.

**9.23.10.4. Continuity of Studs**

**1)** Wall studs shall be continuous for the full *storey* height except at openings and shall not be spliced except by fingerjoining with a structural adhesive. (See Note A-9.23.10.4.(1).)

**9.23.10.5. Support for Cladding, Sheathing and Finishing Materials**

**1)** Corners and intersections shall be designed to provide adequate support for the vertical edges of interior finishes, sheathing and cladding materials, and in no instance shall exterior corners be framed with less than the equivalent of 2 studs.

**2)** Where the vertical edges of interior finishes at wall intersections are supported at vertical intervals by blocking or furring, the vertical distance between such supports shall not exceed the maximum distance between supports specified in Section 9.29.

**9.23.10.6. Studs at Sides of Openings**

**1)** Where the lintel spanning the opening is more than 3 m long, studs shall be tripled on each side of the opening so that

- a) the two inner studs on each side extend from the bottom of the supported lintel to the top of the bottom wall plate, and
- b) the outer stud on each side extends from the bottom of the top wall plate to the bottom wall plate.

**2)** Except as provided in Sentence (3), where the lintel spanning the opening is not more than 3 m long, studs shall be doubled on each side of the opening so that

- a) the inner studs on each side extend from the bottom of the supported lintel to the top of the bottom wall plate, and
- b) the outer stud on each side extends from the bottom of the top wall plate to the bottom wall plate.

**3)** Single studs are permitted to be used on either side of openings

- a) in non-*loadbearing* interior walls not required to have *fire-resistance ratings*, provided the studs extend from the top wall plate to the bottom wall plate, or
- b) in *loadbearing* or non-*loadbearing* interior or exterior walls, provided
  - i) the opening is less than and within the required stud spacing, and
  - ii) no 2 such openings of full stud-space width are located in adjacent stud spaces.

(See Note A-9.23.10.6.(3).)

**9.23.11. Wall Plates****9.23.11.1. Size of Wall Plates**

**1)** Except as provided in Sentence (2), wall plates shall be

- a) not less than 38 mm thick, and
- b) not less than the required width of the wall studs.

**2)** In non-*loadbearing* walls and in *loadbearing* walls where the studs are located directly over framing members, the bottom wall plate is permitted to be 19 mm thick.

**9.23.11.2. Bottom Wall Plates**

**1)** A bottom wall plate shall be provided in all cases.

**2)** The bottom plate in exterior walls shall not project more than one-third the plate width over the support.

**9.23.11.3. Top Plates**

**1)** Except as permitted in Sentences (2) to (4), at least 2 top plates shall be provided in *loadbearing* walls.

**2)** A single top plate is permitted to be used in a section of a *loadbearing* wall containing a lintel provided the top plate forms a tie across the lintel.



**3)** A single top plate is permitted to be used in *loadbearing* walls where the concentrated loads from ceilings, floors and roofs are not more than 50 mm to one side of the supporting studs and in all non-*loadbearing* walls.

**4)** The top plates need not be provided in a section of *loadbearing* wall containing a lintel provided the lintel is tied to the adjacent wall section with not less than

- a) 75 mm by 150 mm by 0.91 mm thick galvanized steel, or
- b) 19 mm by 89 mm by 300 mm wood splice nailed to each wall section with at least three 63 mm nails.

**9.23.11.4. Joints in Top Plates**

**1)** Joints in the top plates of *loadbearing* walls shall be staggered not less than one stud spacing.

**2)** The top plates in *loadbearing* walls shall be lapped or otherwise tied at corners and intersecting walls in accordance with Sentence (4).

**3)** Joints in single top plates used with *loadbearing* walls shall be tied in accordance with Sentence (4).

**4)** Ties referred to in Sentences (2) and (3) shall be the equivalent of not less than 75 mm by 150 mm by 0.91 mm thick galvanized steel nailed to each wall with at least three 63 mm nails.

**5)** Where the seismic spectral response acceleration,  $S_a(0.2)$ , is greater than 0.70 but not more than 1.8, doubled top plates in *braced wall bands* shall be fastened on each side of a splice with 76 mm long common steel wire nails or spiral nails in accordance with Table 9.23.11.4.

**Table 9.23.11.4.**  
**Fasteners in Doubled Top Plate Splice Connections in Braced Wall Bands where  $0.70 < S_a(0.2) \leq 1.8$**   
 Forming Part of Sentence 9.23.11.4.(5)

$S_a(0.2)$	Minimum Number of Nails on Each Side of Doubled Top Plate Splice				
	Light Construction			Heavy Construction <sup>(1)</sup>	
	Number of Supported Floors <sup>(2)</sup>				
	0	1	2	0	1
$0.70 < S_a(0.2) \leq 0.80$	2	5	8	3	8
$0.80 < S_a(0.2) \leq 0.90$	2	5	8	4	8
$0.90 < S_a(0.2) \leq 1.0$	3	6	10	4	10
$1.0 < S_a(0.2) \leq 1.1$	3	7	11	5	11
$1.1 < S_a(0.2) \leq 1.2$	3	7	11	5	12
$1.2 < S_a(0.2) \leq 1.3$	3	8	12	5	12
$1.3 < S_a(0.2) \leq 1.35$	4	8	12	5	13
$1.35 < S_a(0.2) \leq 1.8$	4	8	13	5	13

**Notes to Table 9.23.11.4.:**

(1) See Note A-9.23.13.2.(1)(a)(i).

(2) All constructions include support of a roof load in addition to the number of floors indicated.

**9.23.12. Framing over Openings**

**9.23.12.1. Openings in Non-Loadbearing Walls**

**1)** Except as provided in Sentence (2), openings in non-*loadbearing* walls shall be framed with not less than 38 mm material the same width as the studs, securely nailed to adjacent studs.

**2)** Openings for doors in non-*loadbearing* walls required to be *fire separations* with a *fire-resistance rating* shall be framed with the equivalent of at least two 38 mm thick members that are the same width as the wall plates.

### 9.23.12.2. Openings in Loadbearing Walls

**1)** Openings in *loadbearing* walls greater than the required stud spacing shall be framed with lintels designed to carry the superimposed loads to adjacent studs. (See Note A-9.23.10.6.(3).)

**2)** Except as provided in Sentence 9.23.12.3.(2), where 2 or more members are used in lintels, they shall be fastened together with not less than 82 mm nails in a double row, with nails not more than 450 mm apart in each row.

**3)** Lintel members are permitted to be separated by filler pieces.

### 9.23.12.3. Lintel Spans and Sizes

**1)** Spans and sizes of wood lintels shall conform to the spans shown in Span Tables 9.23.4.2.-L and 9.23.12.3.-A to 9.23.12.3.-D

- a) for *buildings of residential occupancy*,
- b) where the wall studs exceed 38 mm by 64 mm in size,
- c) where the spans of supported joists do not exceed 4.9 m, and
- d) where the spans of trusses do not exceed 9.8 m.

**2)** In *loadbearing* exterior and interior walls of 38 mm by 64 mm framing members, lintels shall consist of

- a) 64 mm thick members on edge, or
- b) 38 mm thick and 19 mm thick members fastened together with a double row of nails not less than 63 mm long and spaced not more than 450 mm apart.

**3)** Lintels referred to in Sentence (2)

- a) shall be not less than 50 mm greater in depth than those shown in Span Tables 9.23.4.2.-L and 9.23.12.3.-A to 9.23.12.3.-D for the maximum spans shown, and
- b) shall not exceed 2.24 m in length.

## 9.23.13. Bracing to Resist Lateral Loads Due to Wind and Earthquake

(See Note A-9.23.13.)

### 9.23.13.1. Requirements for Low to Moderate Wind and Seismic Forces

(See Note A-9.23.13.1.)

**1)** This Article applies in locations where the seismic spectral response acceleration,  $S_a(0.2)$ , is not more than 0.70 and the 1-in-50 hourly wind pressure is less than 0.80 kPa.

**2)** Bracing to resist lateral loads shall be designed and constructed as follows:

- a) exterior walls shall be
  - i) clad with panel-type cladding in accordance with Section 9.27.,
  - ii) sheathed with plywood, OSB, waferboard, fibreboard, gypsum board or diagonal lumber sheathing complying with Subsection 9.23.16. and fastened in accordance with Table 9.23.3.5.-A, or
  - iii) finished on the interior with a panel-type material in accordance with the requirements of Section 9.29., or
- b) in accordance with
  - i) Articles 9.23.13.4. to 9.23.13.7.,
  - ii) Part 4, or
  - iii) good engineering practice such as that provided in CWC 2014, "Engineering Guide for Wood Frame Construction."

**9.23.13.2. Requirements for High Wind and Seismic Forces**

- 1)** Except as provided in Article 9.23.13.1., this Article applies in locations where
  - a) the seismic spectral response acceleration,  $S_a(0.2)$ , is greater than 0.70 but not more than 1.8 and
    - i) the lowest exterior frame wall supports not more than 1 floor in *buildings* of heavy construction (see Note A-9.23.13.2.(1)(a)(i)), or
    - ii) the lowest exterior frame wall supports not more than 2 floors in other types of construction, and
  - b) the 1-in-50 hourly wind pressure is less than 1.20 kPa.
- 2)** Bracing to resist lateral loads shall be designed and constructed in accordance with
  - a) Articles 9.23.13.4. to 9.23.13.7.,
  - b) Part 4, or
  - c) good engineering practice such as that provided in CWC 2014, "Engineering Guide for Wood Frame Construction."

**9.23.13.3. Requirements for Extreme Wind and Seismic Forces**

- 1)** Except as provided in Articles 9.23.13.1. and 9.23.13.2., this Article applies in locations where
  - a) the seismic spectral response acceleration,  $S_a(0.2)$ , is
    - i) greater than 1.8,
    - ii) greater than 0.70 and the lowest exterior frame wall supports more than 2 floors in *buildings* of light construction, or
    - iii) greater than 0.70 and the lowest exterior frame wall supports more than 1 floor in *buildings* of heavy construction, or
  - b) the 1-in-50 hourly wind pressure is equal to or greater than 1.20 kPa.
- 2)** Bracing to resist lateral loads shall be designed and constructed in accordance with
  - a) Part 4, or
  - b) good engineering practice such as that provided in CWC 2014, "Engineering Guide for Wood Frame Construction."

**9.23.13.4. Braced Wall Bands**

(See Note A-9.23.13.4.)

- 1)** *Braced wall bands* shall
  - a) be full *storey* height,
  - b) be not more than 1.2 m wide,
  - c) lap at both ends with another *braced wall band*,
  - d) be aligned with *braced wall bands* on *storeys* above and below, and
  - e) conform to the spacing and dimensions given in Table 9.23.13.5.
- 2)** The perimeter of the *building* shall be located within *braced wall bands*.
- 3)** For split-level *buildings*, a *braced wall band* shall be located where there is a change in floor level greater than the depth of one floor joist.

**9.23.13.5. Braced Wall Panels in Braced Wall Bands**

- 1)** Except as provided in Sentences (2) to (5) and Article 9.23.13.7., *braced wall panels* shall
  - a) be located within *braced wall bands*,
  - b) extend, as applicable, from the top of the supporting footing, slab or subfloor to the underside of the floor, ceiling or roof framing above, and
  - c) conform to the spacing and dimensions given in Table 9.23.13.5.

**Table 9.23.13.5.**  
**Spacing and Dimensions of Braced Wall Bands and Braced Wall Panels**  
 Forming Part of Sentences 9.23.13.4.(1) and 9.23.13.5.(1)

Description	Spacing and Dimensions of <i>Braced Wall Bands</i> and <i>Braced Wall Panels</i> <sup>(1)(2)(3)</sup>	
	Seismic and Wind Loads	
	$0.70 < S_a(0.2) < 1.0$	$1.0 \leq S_a(0.2) \leq 1.8$ or $0.80 \leq \text{HWP} < 1.2 \text{ kPa}$
Maximum distance between centre lines of adjacent <i>braced wall bands</i> measured from the furthest points between centres of the bands	10.6 m	7.6 m
Maximum distance between required <i>braced wall panels</i> measured from the edges of the panels	6.4 m	6.4 m
Maximum distance from the end of a <i>braced wall band</i> to the edge of the closest required <i>braced wall panel</i>	2.4 m	2.4 m
Minimum length of individual <i>braced wall panels</i> : <ul style="list-style-type: none"> <li>• panel located at the end of a <i>braced wall band</i> where the <i>braced wall panel</i> connects to an intersecting <i>braced wall panel</i></li> <li>• panel not located at the end of a <i>braced wall band</i> or <i>braced wall panel</i> located at the end of a <i>braced wall band</i> where the <i>braced wall panel</i> does not connect to an intersecting <i>braced wall panel</i></li> </ul>	600 mm  750 mm	
Minimum total length of all <i>braced wall panels</i> in a <i>braced wall band</i> <ul style="list-style-type: none"> <li>• supporting 3 floors, light construction</li> <li>• supporting 2 floors, heavy construction<sup>(4)</sup></li> <li>• supporting 2 floors, light construction</li> <li>• supporting 1 floor, heavy construction<sup>(4)</sup></li> <li>• supporting 1 floor, light construction</li> <li>• not supporting a floor</li> </ul>	75% of length of <i>braced wall band</i> 75% of length of <i>braced wall band</i> 40% of length of <i>braced wall band</i> 40% of length of <i>braced wall band</i> 25% of length of <i>braced wall band</i> 25% of length of <i>braced wall band</i>	

**Notes to Table 9.23.13.5.:**

- (1) See Note A-Table 9.23.13.5.  
 (2) All constructions include support of a roof load in addition to the indicated number of floors.  
 (3) See Article 9.23.13.7. for alternative methods of compliance.  
 (4) See Sentence 9.23.13.3.(1) for overall limit on application to heavy construction.

**2)** In *basements* or crawl spaces where the perimeter *foundation* walls extend from the footings to the underside of the supported floor, *braced wall bands* constructed with *braced wall panels* shall be spaced not more than

- a) 15 m from the perimeter *foundation* walls,
- b) 15 m from interior *foundation* walls, and
- c) 15 m from adjacent *braced wall bands* constructed with *braced wall panels*.

(See Note A-9.23.13.5.(2).)

**3)** Portions of the perimeter of a single open or enclosed space need not comply with Sentence (1), where

- a) the roof of the space projects not more than
  - i) 3.5 m from the face of the framing of the nearest parallel *braced wall band*, and
  - ii) half the perpendicular plan dimension,
- b) that portion of the perimeter structure does not support a floor, and
- c) the roof of the space is
  - i) integral with the roof of the rest of the *building* with framing members not more than 400 mm o.c., or
  - ii) constructed with roof framing not more than 400 mm o.c. fastened to the wall framing (see Table 9.23.3.4. and Article 9.23.9.1. for balloon framing).

(See Note A-9.23.13.5.(3).)

- 4) Walls in detached garages and in accessory *buildings* serving a single *dwelling unit*, and the front wall of attached garages serving a single *dwelling unit* need not comply with Sentence (1) where these walls do not support a floor.
- 5) *Braced wall panels* in the *braced wall band* at the front of an attached garage serving a single *dwelling unit* need not comply with Sentence (1), provided
  - a) the maximum spacing between the front of the garage and the back wall of the garage does not exceed 7.6 m,
  - b) there is not more than one floor above the garage,
  - c) not less than 50% of the length of the back wall of the garage is constructed of *braced wall panels*, and
  - d) not less than 25% of the length of the side walls is constructed of *braced wall panels*.

**9.23.13.6. Materials in Braced Wall Panels**

- 1) Required *braced wall panels* shall be
  - a) clad with panel-type cladding complying with Section 9.27. and Table 9.23.3.4.,
  - b) sheathed with plywood, OSB, waferboard or diagonal lumber sheathing complying with Subsection 9.23.16. and Table 9.23.13.6., and fastened in accordance with Article 9.23.3.5., or
  - c) finished on the interior with a panel-type material in accordance with the requirements of Section 9.29. and Table 9.23.13.6.

**Table 9.23.13.6.**  
**Minimum Thicknesses of Cladding, Sheathing or Interior Finish for Braced Wall Panels**  
 Forming Part of Sentence 9.23.13.6.(1)

Panel-Type Cladding, Sheathing or Interior Finish	Minimum Thickness			
	Where $S_a(0.2) \leq 0.90$		Where $S_a(0.2) > 0.90$	
	With supports 400 mm o.c.	With supports 600 mm o.c.	With supports 400 mm o.c.	With supports 600 mm o.c.
Gypsum board interior finish <sup>(1)</sup>	12.7 mm	15.9 mm	12.7 mm	15.9 mm
Sheathing complying with CSA O325	W16	W24	W16	W24
OSB O-1 and O-2 grades	11 mm	12.5 mm	11 mm	12.5 mm
Waferboard R-1 grade	9.5 mm	12.5 mm	n/a	n/a
Plywood	11 mm	12.5 mm	11 mm	12.5 mm
Diagonal lumber	17 mm	17 mm	n/a	n/a

**Notes to Table 9.23.13.6.:**

<sup>(1)</sup> See Sentences (5) and (6).

- 2) Except as provided in Sentence (3), required interior *braced wall panels* shall be
  - a) sheathed or finished on both sides with a wood-based material, or
  - b) finished on both sides with gypsum board.
- 3) Required interior *braced wall panels* of wood-based material may be sheathed on one side only, provided
  - a) the sheathing material is plywood, OSB or waferboard, and
  - b) the maximum spacing of fasteners along the edge is half of the maximum spacing shown in Table 9.23.3.5.-B.
- 4) For stacked *braced wall bands*, where the construction of any one *braced wall panel* is required to be of a wood-based material, a wood-based material shall be installed in all the required *braced wall panels* in that *braced wall band*.

**5)** Gypsum board interior finish shall not be considered as an acceptable sheathing material to provide the required bracing in exterior walls. (See Note A-9.23.13.6.(5) and (6).)

**6)** At *braced wall band* spacing intervals of not more than 15 m, *braced wall panels* shall be constructed with OSB, plywood or diagonal lumber. (See Note A-9.23.13.6.(5) and (6).)

### 9.23.13.7. Additional System Considerations

**1)** Except as provided in Sentences (2) and (3), one exterior wall of the uppermost *storey* in each orthogonal direction may be set back from the exterior wall of the *storey* below, provided the adjacent interior *braced wall band* of the *storey* below the setback

- a) is spaced not more than 10.6 m from the exterior wall of the *storey* below the setback wall,
- b) consists of *braced wall panels* that are constructed of a wood-based material in conformance with Sentence 9.23.13.6.(2),
- c) extends to the *foundation*, and
- d) is not taken into consideration when providing *braced wall panels* constructed of a wood-based material at spacing intervals of not more than 15 m as per Sentence 9.23.13.6.(6).

**2)** Where the exterior wall of the uppermost *storey* is set back from the exterior wall of the *storey* below, the roof and floor space supporting the setback wall shall be sheathed with a wood-based material between the exterior wall of the *storey* below the setback and the adjacent interior *braced wall bands* of the *storey* below the setback.

**3)** Where the exterior wall of the uppermost *storey* is set back from the exterior wall of the *storey* below, the exterior walls perpendicular to the setback wall shall

- a) have their top plate connected with nails that are spaced at no greater than half the spacing required in Table 9.23.3.4., and
- b) have their top plate splices fastened with twice the number of nails specified in Sentences 9.23.11.4.(4) and (5).

**4)** The maximum distance between adjacent required *braced wall panels* in a *braced wall band*, measured from the edge of the panels, may be increased to 7.3 m provided that, throughout the height of the *building*, the length of any *braced wall panel* within the *braced wall band* is not less than 1.2 m.

**5)** The maximum spacing between the centre lines of required *braced wall bands* given in Table 9.23.13.5. may be increased from 7.6 m to no more than 10.6 m, provided that the interior *braced wall band* whose spacing is being increased is replaced with an interior *braced wall band* that

- a) consists of *braced wall panels* that are constructed of a wood-based material in conformance with Sentence 9.23.13.6.(2),
- b) extends to the *foundation*, and
- c) is not taken into consideration when providing *braced wall panels* constructed of a wood-based material at spacing intervals no greater than 15 m as per Sentence 9.23.13.6.(6).

**6)** For each orthogonal direction of the *building*, the length of required *braced wall panels* of one exterior wall given in Table 9.23.13.5. may be reduced from 40% to no less than 25% of the length of the *braced wall band*, provided an additional parallel and adjacent interior *braced wall band* is constructed that

- a) is spaced not more than 10.6 m from the exterior wall,
- b) consists of *braced wall panels* that are constructed of a wood-based material in conformance with Sentence 9.23.13.6.(2) and whose lengths sum to no less than 25% of the length of the *braced wall band*,
- c) extends to the *foundation*, and
- d) is not taken into consideration when providing *braced wall panels* constructed of a wood-based material at spacing intervals no greater than 15 m as per Sentence 9.23.13.6.(6).

**7)** Where the length of required *braced wall panels* of an exterior wall is reduced as described in Sentence (6), the ratio of the length of *braced wall panels* in the respective

upper *braced wall bands* to the length of *braced wall panels* in the reduced exterior *braced wall band* shall not exceed 2.

## 9.23.14. Roof and Ceiling Framing

### 9.23.14.1. Continuity of Rafters and Joists

1) Roof rafters and joists and ceiling joists shall be continuous or shall be spliced over vertical supports that extend to suitable bearing.

### 9.23.14.2. Framing around Openings

1) Roof and ceiling framing members shall be doubled on each side of openings greater than 2 rafter or joist spacings wide.

### 9.23.14.3. End Bearing Length

1) The length of end bearing of joists and rafters shall be not less than 38 mm.

### 9.23.14.4. Location and Attachment of Rafters

1) Rafters shall be located directly opposite each other and tied together at the peak, or may be offset by their own thickness if nailed to a ridge board not less than 17.5 mm thick.

2) Except as permitted in Sentence (3), framing members shall be connected by gusset plates or nailing at the peak in conformance with Table 9.23.3.4.

3) Where the roof framing on opposite sides of the peak is assembled separately, such as in the case of factory-built houses, the roof framing on opposite sides is permitted to be fastened together with galvanized-steel strips not less than 200 mm by 75 mm by 0.41 mm thick spaced not more than 1.2 m apart and nailed at each end to the framing by at least two 63 mm nails.

### 9.23.14.5. Shaping of Rafters

1) Rafters shall be shaped at supports to provide even bearing surfaces and supported directly above the exterior walls.

### 9.23.14.6. Hip and Valley Rafters

1) Hip and valley rafters shall be not less than 50 mm greater in depth than the common rafters and not less than 38 mm thick, actual dimension.

### 9.23.14.7. Intermediate Support for Rafters and Joists

1) Ceiling joists and collar ties of not less than 38 mm by 89 mm lumber are permitted to be assumed to provide intermediate support to reduce the span for rafters and joists where the roof slope is 1 in 3 or greater.

2) Collar ties referred to in Sentence (1) more than 2.4 m long shall be laterally supported near their centres by not less than 19 mm by 89 mm continuous members at right angles to the collar ties.

3) Dwarf walls and struts are permitted to be used to provide intermediate support to reduce the span for rafters and joists.

4) When struts are used to provide intermediate support they shall be not less than 38 mm by 89 mm material extending from each rafter to a *loadbearing* wall at an angle of not less than 45° to the horizontal.

5) When dwarf walls are used for rafter support, they shall be framed in the same manner as *loadbearing* walls and securely fastened top and bottom to the roof and ceiling framing to prevent over-all movement.

6) Solid blocking shall be installed between floor joists beneath dwarf walls referred to in Sentence (5) that enclose finished rooms.

**9.23.14.8. Ridge Support**

- 1)** Except as provided in Sentence (4), roof rafters and joists shall be supported at the ridge of the roof by
  - a) a *loadbearing* wall extending from the ridge to suitable bearing, or
  - b) a ridge beam supported by not less than 89 mm length of bearing.
  
- 2)** Except as provided in Sentence (3), the ridge beam referred to in Sentence (1) shall conform to the sizes and spans shown in Span Table 9.23.4.2.-L, provided
  - a) the supported rafter or joist length does not exceed 4.9 m, and
  - b) the roof does not support any concentrated loads.
  
- 3)** The ridge beam referred to in Sentence (1) need not comply with Sentence (2) where
  - a) the beam is of not less than 38 mm by 140 mm material, and
  - b) the beam is supported at intervals not exceeding 1.2 m by not less than 38 mm by 89 mm members extending vertically from the ridge to suitable bearing.
  
- 4)** When the roof slope is 1 in 3 or more, ridge support need not be provided when the lower ends of the rafters are adequately tied to prevent outward movement.
  
- 5)** Ties required in Sentence (4) are permitted to consist of tie rods or ceiling joists forming a continuous tie for opposing rafters and nailed in accordance with Table 9.23.14.8.

**Table 9.23.14.8.**  
**Rafter-to-Joist Nailing (Unsupported Ridge)**  
 Forming Part of Sentences 9.23.14.8.(5) and (6)

Roof Slope	Rafter Spacing, mm	Minimum Number of Nails not less than 76 mm Long											
		Rafter Tied to every Joist						Rafter Tied to Joist every 1.2 m					
		Building Width up to 8 m			Building Width up to 9.8 m			Building Width up to 8 m			Building Width up to 9.8 m		
		Roof Snow Load, kPa			Roof Snow Load, kPa			Roof Snow Load, kPa			Roof Snow Load, kPa		
		1.0 or less	1.5	2.0 or more	1.0 or less	1.5	2.0 or more	1.0 or less	1.5	2.0 or more	1.0 or less	1.5	2.0 or more
1 in 3	400	4	5	6	5	7	8	11	—	—	—	—	—
	600	6	8	9	8	—	—	11	—	—	—	—	—
1 in 2.4	400	4	4	5	5	6	7	7	10	—	9	—	—
	600	5	7	8	7	9	11	7	10	—	—	—	—
1 in 2	400	4	4	4	4	4	5	6	8	9	8	—	—
	600	4	5	6	5	7	8	6	8	9	8	—	—
1 in 1.71	400	4	4	4	4	4	4	5	7	8	7	9	11
	600	4	4	5	5	6	7	5	7	8	7	9	11
1 in 1.33	400	4	4	4	4	4	4	4	5	6	5	6	7
	600	4	4	4	4	4	5	4	5	6	5	6	7
1 in 1	400	4	4	4	4	4	4	4	4	4	4	4	5
	600	4	4	4	4	4	4	4	4	4	4	4	5

**6)** Ceiling joists referred to in Sentence (5) shall be fastened together with at least one more nail per joist splice than required for the rafter to joist connection shown in Table 9.23.14.8.

**7)** Members referred to in Sentence (6) are permitted to be fastened together either directly or through a gusset plate.



**9.23.14.9. Restraint of Joist Bottoms**

**1)** Roof joists supporting a finished ceiling, other than plywood, OSB or waferboard, shall be restrained from twisting along the bottom edges by means of furring, blocking, cross bridging or strapping conforming to Article 9.23.9.3.

**9.23.14.10. Ceiling Joists Supporting Roof Load**

**1)** Except as permitted in Sentence (2), ceiling joists supporting part of the roof load from the rafters shall be not less than 25 mm greater in depth than required for ceiling joists not supporting part of the roof load.

**2)** When the roof slope is 1 in 4 or less, the ceiling joist sizes referred to in Sentence (1) shall be determined from Span Tables 9.23.4.2.-C to 9.23.4.2.-F and 9.23.4.2.-L for roof joists.

**9.23.14.11. Roof Trusses**

- 1)** Roof trusses which are not designed in accordance with Part 4 shall
  - a) be capable of supporting a total ceiling load (*dead load plus live load*) of 0.35 kPa plus two and two-thirds times the specified live roof load for 24 h, and
  - b) not exceed the deflections shown in Table 9.23.14.11. when loaded with the ceiling load plus one and one-third times the specified roof snow load for 1 h.

**Table 9.23.14.11.  
Maximum Roof Truss Deflections**  
Forming Part of Sentence 9.23.14.11.(1)

Truss Span	Type of Ceiling	Maximum Deflection
4.3 m or less	Plaster or gypsum board	1/360 of the span
	Other than plaster or gypsum board	1/180 of the span
Over 4.3 m	Plaster or gypsum board	1/360 of the span
	Other than plaster or gypsum board	1/240 of the span

**2)** The joint connections used in trusses described in Sentence (1) shall be designed in conformance with the requirements in Subsection 4.3.1. (See Note A-9.23.14.11.(2).)

**3)** Where the length of compression web members in roof trusses described in Sentence (1) exceeds 1.83 m, such web members shall be provided with continuous bracing to prevent buckling.

**4)** Bracing required in Sentence (3) shall consist of not less than 19 mm by 89 mm lumber nailed at right angles to the web members near their centres with at least two 63 mm nails for each member.

**5)** Where the ability of a truss design to satisfy the requirements of Sentence (1) is demonstrated by testing, it shall consist of a full scale load test carried out in conformance with CSA S307-M, "Load Test Procedure for Wood Roof Trusses for Houses and Small Buildings."

**6)** Where the ability of a truss design to satisfy the requirements of Sentence (1) is demonstrated by analysis, it shall be carried out in accordance with good engineering practice such as that described in TPIC 2014, "Truss Design Procedures and Specifications for Light Metal Plate Connected Wood Trusses (Limit States Design)."

**9.23.15. Subflooring**

**9.23.15.1. Subflooring Required**

1) Subflooring shall be provided beneath finish flooring where the finish flooring does not have adequate strength to support the specified *live loads* (see Subsection 9.30.3.).

**9.23.15.2. Material Standards**

- 1) Except as provided in Sentence (2), wood-based panels for subfloors shall conform to
  - a) CSA O121, "Douglas Fir Plywood,"
  - b) CSA O151, "Canadian Softwood Plywood,"
  - c) CSA O153, "Poplar Plywood,"
  - d) CSA O325, "Construction Sheathing," or
  - e) CSA O437.0, "OSB and Waferboard."
- 2) Particleboard subflooring may be used only where a *building* is constructed in a factory so that the subfloor will not be exposed to the weather.
- 3) Subflooring described in Sentence (2) shall conform to grade D-2 or D-3 in ANSI A208.1, "Particleboard."
- 4) Subflooring described in Sentence (2) shall have its upper surface and all edges treated to restrict water absorption, where the subfloor is used in bathrooms, kitchens, laundry rooms or other areas subject to periodic wetting. (See Note A-9.23.15.2.(4).)

**9.23.15.3. Edge Support**

1) Where the edges of panel-type subflooring are required to be supported (see Sentence 9.30.2.1.(2)), such support shall consist of tongue-and-groove panel edges or not less than 38 mm by 38 mm blocking securely nailed between framing members.

**9.23.15.4. Direction of Installation**

- 1) Plywood subflooring shall be installed with the surface grain at right angles to the joists and with joints parallel to floor joists staggered.
- 2) OSB subflooring conforming to CSA O325, "Construction Sheathing," or to O-1 and O-2 grades in CSA O437.0, "OSB and Waferboard," and waferboard subflooring conforming to R-1 grade in CSA O437.0 shall be installed so that the direction of face orientation is at right angles to the joists and the joints parallel to the floor joists are staggered. (See Note A-9.23.15.4.(2).)

**9.23.15.5. Subfloor Thickness or Rating**

1) Except as provided in Sentences (2) and (3), subfloors shall conform to either Table 9.23.15.5.-A or 9.23.15.5.-B.

**Table 9.23.15.5.-A**  
**Thickness of Subflooring**  
 Forming Part of Sentences 9.23.15.5.(1) and 9.23.16.7.(1)

Maximum Spacing of Supports, mm	Minimum Thickness, mm			
	Plywood and OSB, O-2 Grade	OSB, O-1 Grade, and Waferboard, R-1 Grade	Particleboard	Lumber
400	15.5	15.9	15.9	17.0
500	15.5	15.9	19.0	19.0
600	18.5	19.0	25.4	19.0

**Table 9.23.15.5.-B**  
**Rating for Subfloor when Applying CSA O325**  
 Forming Part of Sentences 9.23.15.5.(1) and 9.23.16.7.(1)

Maximum Spacing of Supports, mm	Panel Mark	
	Subfloor	Used with Panel-Type Underlay
400	1F16	2F16
500	1F20	2F20
600	1F24	2F24

**2)** Where the finished flooring consists of not less than 19 mm matched wood strip flooring laid at right angles to joists spaced not more than 600 mm o.c., subflooring shall be permitted to consist of not less than

- a) 12.5 mm thick plywood,
- b) 12.5 mm thick OSB conforming to O-2 grade,
- c) 12.7 mm thick OSB conforming to O-1 grade,
- d) 12.7 mm thick waferboard conforming to R-1 grade, or
- e) OSB conforming to 2R32/2F16 grade.

**3)** Except where the flooring consists of ceramic tiles applied with adhesive, where a separate panel-type underlay or concrete topping is applied to a subfloor on joists spaced not more than 400 mm o.c., the subfloor is permitted to consist of not less than

- a) 12.5 mm thick plywood,
- b) 12.5 mm thick OSB conforming to O-2 grade,
- c) 12.7 mm thick OSB conforming to O-1 grade,
- d) 12.7 mm thick waferboard conforming to R-1 grade, or
- e) OSB conforming to 2R32/2F16 grade.

**9.23.15.6. Annular Grooved Nails**

**1)** When resilient flooring is applied directly to an OSB, waferboard, particleboard or plywood subfloor, the subfloor shall be fastened to the supports with annular grooved nails.

**9.23.15.7. Lumber Subflooring**

- 1)** Lumber subflooring shall be laid at an angle of not less than 45° to the joists.
- 2)** Lumber subflooring shall be fully supported at the ends on solid bearing.
- 3)** Lumber for subflooring shall be of uniform thickness and not more than 184 mm wide.

**9.23.16. Roof Sheathing**

**9.23.16.1. Required Roof Sheathing**

**1)** Except where the 1-in-50 hourly wind pressure is less than 0.8 kPa and the seismic spectral response acceleration,  $S_a(0.2)$ , is less than or equal to 0.70, continuous lumber or panel-type roof sheathing shall be installed to support the roofing.

**9.23.16.2. Material Standards**

- 1)** Wood-based panels used for roof sheathing shall conform to the requirements of
  - a) CSA O121, "Douglas Fir Plywood,"
  - b) CSA O151, "Canadian Softwood Plywood,"
  - c) CSA O153, "Poplar Plywood,"
  - d) CSA O325, "Construction Sheathing," or
  - e) CSA O437.0, "OSB and Waferboard."

**9.23.16.3. Direction of Installation**

- 1) Plywood roof sheathing shall be installed with the surface grain at right angles to the roof framing.
- 2) OSB roof sheathing conforming to CSA O325, "Construction Sheathing," or to O-1 and O-2 grades as specified in CSA O437.0, "OSB and Waferboard," shall be installed with the direction of face orientation at right angles to the roof framing members. (See Note A-9.23.15.4.(2).)

**9.23.16.4. Joints in Panel-Type Sheathing**

- 1) Panel-type sheathing board shall be applied so that joints perpendicular to the roof ridge are staggered where
  - a) the sheathing is applied with the surface grain parallel to the roof ridge, and
  - b) the thickness of the sheathing is such that the edges are required to be supported.
- 2) A gap of not less than 2 mm shall be left between sheets of plywood, OSB or waferboard.

**9.23.16.5. Lumber Roof Sheathing**

- 1) Lumber roof sheathing shall not be more than 286 mm wide and shall be applied so that all ends are supported with end joints staggered.
- 2) Lumber roof sheathing shall be installed diagonally, where
  - a) the seismic spectral response acceleration,  $S_a(0.2)$ , is greater than 0.70 but not greater than 1.2, or
  - b) the 1-in-50 hourly wind pressure is equal to or greater than 0.80 kPa but less than 1.20 kPa.
- 3) Lumber roof sheathing shall be designed according to Part 4, where
  - a) the seismic spectral response acceleration,  $S_a(0.2)$ , is greater than 1.2, or
  - b) the 1-in-50 hourly wind pressure is equal to or greater than 1.20 kPa.

**9.23.16.6. Edge Support**

- 1) Where panel-type roof sheathing requires edge support, the support shall consist of metal H clips or not less than 38 mm by 38 mm blocking securely nailed between framing members.

**9.23.16.7. Thickness or Rating**

- 1) The thickness or rating of roof sheathing on a flat roof used as a walking deck shall conform to either Table 9.23.15.5.-A or Table 9.23.15.5.-B for subfloors.
- 2) The thickness or rating of roof sheathing on a roof not used as a walking deck shall conform to either Table 9.23.16.7.-A or Table 9.23.16.7.-B.
- 3) Asphalt-coated or asphalt-impregnated fibreboard not less than 11.1 mm thick conforming to CAN/ULC-S706, "Wood Fibre Insulating Boards for Buildings," is permitted to be used as a roof sheathing over supports spaced not more than 400 mm o.c. provided the roofing consists of
  - a) a continuous sheet of galvanized steel not less than 0.33 mm in thickness, or
  - b) a continuous sheet of aluminum not less than 0.61 mm in thickness.
- 4) All edges of sheathing described in Sentence (3) shall be supported by blocking or framing.

**Table 9.23.16.7.-A**  
**Thickness of Roof Sheathing**  
 Forming Part of Sentence 9.23.16.7.(2)

Maximum Spacing of Supports, mm	Minimum Thickness, mm				
	Plywood, and OSB, O-2 Grade		OSB, O-1 Grade, and Waferboard, R-1 Grade		Lumber
	Edges Supported	Edges Unsupported	Edges Supported	Edges Unsupported	
300	7.5	7.5	9.5	9.5	17.0
400	7.5	9.5	9.5	11.1	17.0
600	9.5	12.5	11.1	12.7	19.0

**Table 9.23.16.7.-B**  
**Rating for Roof Sheathing When Applying CSA O325**  
 Forming Part of Sentence 9.23.16.7.(2)

Maximum Spacing of Supports, mm	Panel Mark	
	Edges Supported	Edges Unsupported
400	2R16	1R16
500	2R20	1R20
600	2R24	1R24

**9.23.17. Wall Sheathing**

**9.23.17.1. Required Sheathing**

1) Exterior walls and gable ends shall be sheathed when the exterior cladding requires intermediate fastening between supports or if the exterior cladding requires solid backing.

**9.23.17.2. Thickness, Rating and Material Standards**

1) Where wall sheathing is required for the purpose of complying with this Section, it shall conform to either Table 9.23.17.2.-A or 9.23.17.2.-B. (See also Article 9.25.5.1.)

**Table 9.23.17.2.-A**  
**Wall Sheathing Thickness and Specifications**  
 Forming Part of Sentence 9.23.17.2.(1)

Type of Sheathing	Minimum Thickness, mm <sup>(1)</sup>		Material Standards
	With Supports 400 mm o.c.	With Supports 600 mm o.c.	
Fibreboard (insulating)	9.5	11.1	CAN/ULC-S706
Gypsum sheathing	9.5	12.7	ASTM C 1177/C 1177M ASTM C 1396/C 1396M <sup>(2)</sup>
Lumber	17.0	17.0	See Table 9.3.2.1.
Mineral Fibre, Rigid Board, Type 2	25	25	CAN/ULC-S702
OSB, O-2 Grade	6.0	7.5	CSA O437.0
OSB, O-1 Grade, and Waferboard, R-1 Grade	6.35	7.9	CSA O437.0
Phenolic, faced	25	25	CAN/CGSB-51.25-M
Plywood (exterior type)	6.0	7.5	CSA O121 CSA O151 CSA O153
Polystyrene, Types 1 and 2	38	38	CAN/ULC-S701
Polystyrene, Types 3 and 4	25	25	CAN/ULC-S701
Polyurethane and Polyisocyanurate Type 1, faced	38	38	CAN/ULC-S704
Polyurethane and Polyisocyanurate Types 2 and 3, faced	25	25	CAN/ULC-S704

Table 9.23.17.2.-A (Continued)

**Notes to Table 9.23.17.2.-A:**

- (1) See also Sentences 9.27.5.1.(2) to (4).  
 (2) The *flame-spread rating* of gypsum board shall be determined in accordance with CAN/ULC-S102, "Test for Surface Burning Characteristics of Building Materials and Assemblies."

**Table 9.23.17.2.-B**  
**Rating for Wall Sheathing when Applying CSA O325**  
 Forming Part of Sentence 9.23.17.2.(1)

Maximum Spacing of Supports, mm	Panel Mark
400	W16
500	W20
600	W24

**9.23.17.3. Attachment of Cladding to Sheathing**

**1)** Gypsum sheathing, rigid insulation and fibreboard shall not be used for the attachment of cladding materials.

**9.23.17.4. Lumber Sheathing**

- 1)** Lumber wall sheathing shall be applied so that all ends are supported.  
**2)** Where lumber wall sheathing is required to provide bracing according to Article 9.23.10.2., it shall be applied with end joints staggered.

**9.23.17.5. Joints in Panel-Type Sheathing**

**1)** A gap of not less than 2 mm shall be left between sheets of plywood, OSB, waferboard or fibreboard.

**9.23.17.6. Mansard Style Roofs**

**1)** Where the bottom portions of mansard style roofs are vented, the vertical framing members behind the sloping portions shall be considered on the same basis as exterior wall studs and shall conform to Articles 9.27.3.2. to 9.27.3.6.

**Section 9.24. Sheet Steel Stud Wall Framing****9.24.1. General****9.24.1.1. Application**

- 1)** This Section applies to sheet steel studs for use in non-*loadbearing* exterior and interior walls.  
**2)** Where *loadbearing* steel studs are used, they shall be designed in conformance with Part 4.

**9.24.1.2. Material Standards**

**1)** Steel studs and runners shall conform to AISI S201, "North American Standard for Cold-Formed Steel Framing - Product Data."

**9.24.1.3. Metal Thickness**

**1)** Metal thickness specified in this Section shall be the minimum base steel thickness exclusive of coatings.

**9.24.1.4. Screws**

- 1) Screws for the application of cladding, sheathing or interior finish materials to steel studs, runners and furring channels shall conform to
  - a) ASTM C 954, "Steel Drill Screws for the Application of Gypsum Panel Products or Metal Plaster Bases to Steel Studs from 0.033 in. (0.84 mm) to 0.112 in. (2.84 mm) in Thickness," or
  - b) ASTM C 1002, "Steel Self-Piercing Tapping Screws for the Application of Gypsum Panel Products or Metal Plaster Bases to Wood Studs or Steel Studs."

**9.24.1.5. Cladding, Sheathing and Interior Finish Required**

- 1) Cladding or sheathing, and interior finish shall be installed on steel stud framing and shall be fastened with screws
  - a) spaced at the appropriate spacing described in Section 9.29., and
  - b) penetrating not less than 10 mm through the metal.

**9.24.2. Size of Framing**

**9.24.2.1. Size and Spacing of Studs in Interior Walls**

- 1) Except as required in Articles 9.24.2.3. and 9.24.2.4., the size and spacing of steel studs for non-loadbearing interior walls shall conform to Table 9.24.2.1.

**Table 9.24.2.1.**  
**Steel Studs for Non-Loadbearing Interior Walls<sup>(1)</sup>**  
 Forming Part of Sentence 9.24.2.1.(1)

Minimum Stud Size, mm	Maximum Stud Spacing, mm	Maximum Wall Height, m
32 x 41	400	3.0
	600	2.7
32 x 64	300	4.4
	400	4.0
	600	3.5
32 x 89	300	5.2
	400	4.6
	600	3.9
32 x 152	300	6.6
	400	5.8
	600	4.9

**Notes to Table 9.24.2.1.:**

<sup>(1)</sup> The values in the Table are based on a single layer of 12.7 mm gypsum panel sheathing installed on each side of the studs. Where one side is not accessible, gypsum panels on only one side will suffice. The values are also based on attaching gypsum panel sheathing using screws not smaller than No. 6 spaced at a maximum of 300 mm at edges and at intermediate supports.

**9.24.2.2. Thickness of Studs**

- 1) Except as required in Article 9.24.2.4., steel studs in non-loadbearing interior walls shall have a metal thickness of not less than 0.46 mm.

**9.24.2.3. Runners**

- 1) Runners for interior and exterior non-loadbearing walls shall have a thickness not less than the thickness of the corresponding studs and shall have not less than 30 mm flanges.

**9.24.2.4. Openings in Fire Separations**

- 1)** Where openings for doors in non-loadbearing fire separations required to have a fire-resistance rating do not exceed 1 200 mm in width,
  - a) the width of steel studs shall be not less than 63 mm, and
  - b) the metal thickness shall be not less than 0.46 mm.
- 2)** Where openings described in Sentence (1) exceed 1 200 mm in width,
  - a) the width of steel studs shall be not less than 91 mm, and
  - b) the metal thickness shall be not less than 0.85 mm.
- 3)** The distance to the first stud beyond the jamb of any door opening in a fire separation required to have a fire-resistance rating shall not exceed 400 mm.
- 4)** Where the distance between the framing over the opening referred to in Sentence (3) and the top runner exceeds 400 mm in such walls, intermediate support shall be installed at intervals of not more than 400 mm above the opening.

**9.24.2.5. Size and Spacing of Studs in Exterior Walls**

- 1)** The size and spacing of non-loadbearing steel studs for exterior walls shall conform to Table 9.24.2.5.

**Table 9.24.2.5.**  
**Size and Spacing of Steel Studs for Non-Loadbearing Exterior Walls**  
 Forming Part of Sentence 9.24.2.5.(1)

Minimum Stud Size, mm	Minimum Metal Thickness, mm	Maximum Stud Length, m		
		Spacing of Studs		
		300 mm o.c.	400 mm o.c.	600 mm o.c.
30 × 91	0.53	3.0	2.4	—
30 × 91	0.69	3.3	2.7	2.4
30 × 91	0.85	3.6	3.0	2.7
30 × 91	1.0	4.0	3.3	3.0

**9.24.3. Installation****9.24.3.1. Installation of Runners**

- 1)** Runners shall be provided at the tops and bottoms of walls.
- 2)** Runners required in Sentence (1) shall be securely attached to the building at approximately 50 mm from the ends, and at intervals of not more than 600 mm o.c. for interior walls and 300 mm o.c. for exterior walls.
- 3)** Fasteners used for attachment described in Sentence (2) shall consist of the equivalent of 63 mm nails or 25 mm screws.
- 4)** Studs at openings and which are not full wall height shall be supported by a runner at the ends of the studs, securely fastened to the full length studs at the sides of the opening.

**9.24.3.2. Fire-Rated Walls**

- 1)** Steel studs used in walls required to have a fire-resistance rating shall be installed so that there is not less than a 12 mm clearance between the top of the stud and the top of the runner to allow for expansion in the event of fire.
- 2)** Except as provided in Article 9.24.3.6., studs in walls referred to in Sentence (1) shall not be attached to the runners in a manner that will prevent such expansion.
- 3)** Framing above doors with steel door frames in non-loadbearing fire separations required to have a fire-resistance rating shall consist of 2 runners on the flat fastened back to back. (See Note A-9.24.3.2.(3).)



4) The upper runner required in Sentence (3) shall be bent at each end to extend upwards not less than 150 mm and fastened to the adjacent studs.

5) A gypsum board filler piece, the width and length of the runner, shall be provided between the door frame referred to in Sentence (3) and the adjacent runner.

#### 9.24.3.3. Orientation of Studs

1) Steel studs shall be installed with webs at right angles to the wall face and, except at openings, shall be continuous for the full wall height.

#### 9.24.3.4. Support for Cladding Materials

1) Corners and intersections of walls shall be constructed to provide support for the cladding materials.

#### 9.24.3.5. Framing around Openings

1) Studs shall be doubled on each side of every opening where such openings involve more than one stud space, and shall be tripled where the openings in exterior walls exceed 2.4 m in width.

2) Studs described in Sentence (1) shall be fastened together by screws, crimping or welding to act as a single structural unit in resisting transverse loads.

#### 9.24.3.6. Attachment of Studs to Runners

1) Studs shall be attached to runners by screws, crimping or welding around wall openings and elsewhere where necessary to keep the studs in alignment during construction.

2) Where clearance for expansion is required in Article 9.24.3.2., attachment required in Sentence (1) shall be applied between studs and bottom runners only.

#### 9.24.3.7. Openings for Fire Dampers

1) Openings for *fire dampers* in *non-loadbearing fire separations* required to have a *fire-resistance rating* shall be framed with double studs on each side of the opening.

2) The sill and header for openings described in Sentence (1) shall consist of a runner track with right angle bends made on each end so as to extend 300 mm above the header or below the sill and fastened to the studs.

3) The openings described in Sentence (1) shall be lined with a layer of gypsum board not less than 12.7 mm thick fastened to stud and runner webs.

## Section 9.25. Heat Transfer, Air Leakage and Condensation Control

### 9.25.1. General

#### 9.25.1.1. Scope and Application

1) This Section is concerned with heat, air and water vapour transfer and measures to control condensation.

2) All walls, ceilings and floors separating *conditioned space* from unconditioned space, the exterior air or the ground shall be

- a) provided with
  - i) thermal insulation conforming to Subsection 9.25.2. and Section 9.36.,

- ii) an air barrier conforming to Subsection 9.25.3. and Section 9.36., and
- iii) a vapour barrier conforming to Subsection 9.25.4., and
- b) constructed in such a way that the properties and relative position of all materials conform to Subsection 9.25.5.

**3)** Insulation and sealing of heating and ventilating ducts shall conform to Sections 9.32., 9.33. and 9.36.

## 9.25.2. Thermal Insulation

### 9.25.2.1. Required Insulation

**1)** All walls, ceilings and floors separating heated space from unheated space, the exterior air or the exterior *soil* shall be provided with sufficient thermal insulation to prevent moisture condensation on their room side during the winter and to ensure comfortable conditions for the occupants. (See Note A-9.1.1.1.(1).)

### 9.25.2.2. Insulation Materials

**1)** Except as required in Sentence (2), thermal insulation shall conform to the requirements of

- a) ASTM C 726, "Mineral Wool Roof Insulation Board,"
- b) CAN/CGSB-51.25-M, "Thermal Insulation, Phenolic, Faced,"
- c) CGSB 51-GP-27M, "Thermal Insulation, Polystyrene, Loose Fill,"
- d) CAN/ULC-S701, "Thermal Insulation, Polystyrene, Boards and Pipe Covering,"
- e) CAN/ULC-S702, "Mineral Fibre Thermal Insulation for Buildings,"
- f) CAN/ULC-S703, "Cellulose Fibre Insulation for Buildings,"
- g) CAN/ULC-S704, "Thermal Insulation, Polyurethane and Polyisocyanurate, Boards, Faced,"
- h) CAN/ULC-S705.1, "Thermal Insulation – Spray Applied Rigid Polyurethane Foam, Medium Density – Material – Specification," or
- i) CAN/ULC-S706, "Wood Fibre Insulating Boards for Buildings."

**2)** The *flame-spread ratings* requirements contained in the standards listed in Sentence (1) shall not apply. (See Note A-9.25.2.2.(2).)

**3)** Insulation in contact with the ground shall be inert to the action of *soil* and water and shall be such that its insulative properties are not significantly reduced by moisture.

### 9.25.2.3. Installation of Thermal Insulation

**1)** Insulation shall be installed so that there is a reasonably uniform insulating value over the entire face of the insulated area.

**2)** Insulation shall be applied to the full width and length of the space between furring or framing.

**3)** Except where the insulation provides the principal resistance to air leakage, thermal insulation shall be installed so that at least one face is in full and continuous contact with an element with low air permeance. (See Note A-9.25.2.3.(3).)

**4)** Insulation on the interior of *foundation* walls enclosing a crawl space shall be applied so that there is not less than 50 mm clearance above the crawl space floor, if the insulation is of a type that may be damaged by water.

**5)** Insulation around concrete slabs-on-ground shall be located so that heat from the *building* is not restricted from reaching the ground beneath the perimeter, where exterior walls are not supported by footings extending below frost level.

**6)** Where insulation is exposed to the weather and subject to mechanical damage, it shall be protected with not less than

- a) 6 mm asbestos-cement board,
- b) 6 mm preservative-treated plywood, or
- c) 12 mm cement parging on wire lath applied to the exposed face and edge.

7) Insulation located in areas where it may be subject to mechanical damage shall be protected by a covering such as gypsum board, plywood, particleboard, OSB, waferboard or hardboard.

8) Insulation in factory-built *buildings* shall be installed so that it will not become dislodged during transportation.

#### 9.25.2.4. Installation of Loose-Fill Insulation

1) Except as provided in Sentences (2) to (6), loose-fill insulation shall be used on horizontal surfaces only.

2) Where loose-fill insulation is installed in an unconfined sloped space, such as an attic space over a sloped ceiling, the supporting slope shall not be more than

- a) 4.5 in 12 for mineral fibre or cellulose fibre insulation, and
- b) 2.5 in 12 for other types of insulation.

3) Loose-fill insulation is permitted to be used in wood-frame walls of existing *buildings*. (See Note A-9.25.2.4.(3).)

4) Where blown-in insulation is installed in above-ground or below-ground wood-frame walls of new *buildings*,

- a) the density of the installed insulation shall be sufficient to preclude settlement,
- b) the insulation shall be installed behind a membrane that will permit visual inspection prior to the installation of the interior finish,
- c) the insulation shall be installed in a manner that will not interfere with the installation of the interior finish, and
- d) no water shall be added to the insulation, unless it can be shown that the added water will not adversely affect other materials in the assembly.

5) Water repellent loose-fill insulation is permitted to be used between the outer and inner wythes of masonry *cavity walls*. (See Note A-9.25.2.4.(5).)

6) Where soffit venting is used, measures shall be taken

- a) to prevent loose-fill insulation from blocking the soffit vents and to maintain an open path for circulation of air from the vents into the *attic or roof space*, and
- b) to minimize airflow into the insulation near the soffit vents to maintain the thermal performance of the material. (See Article 9.19.1.3.)

#### 9.25.2.5. Installation of Spray-Applied Polyurethane

1) Spray-applied polyurethane insulation shall be installed in accordance with CAN/ULC-S705.2, "Thermal Insulation – Spray Applied Rigid Polyurethane Foam, Medium Density – Application."

### 9.25.3. Air Barrier Systems

#### 9.25.3.1. Required Barrier to Air Leakage

1) Wall, ceiling and floor assemblies separating *conditioned space* from unconditioned space or from the ground shall be constructed so as to include an *air barrier system* that will provide a continuous barrier to air leakage

- a) from the interior of the *building* into wall, floor, *attic or roof spaces*, sufficient to prevent excessive moisture condensation in such spaces during the winter, and
- b) from the exterior or the ground inward sufficient to
  - i) prevent moisture condensation on the room side during winter,
  - ii) ensure comfortable conditions for the occupants, and
  - iii) minimize the ingress of *soil* gas.

(See Note A-9.25.3.1.(1).)

**9.25.3.2. Air Barrier System Properties**

(See Note A-9.25.5.1.(1).)

**1)** *Air barrier systems* shall possess the characteristics necessary to provide an effective barrier to air infiltration and exfiltration under differential air pressure due to stack effect, mechanical systems or wind.

**2)** Where polyethylene sheet is used to provide airtightness in the *air barrier system*, it shall conform to CAN/CGSB-51.34-M, "Vapour Barrier, Polyethylene Sheet for Use in Building Construction."

**9.25.3.3. Continuity of the Air Barrier System**

**1)** Where the *air barrier system* consists of an air-impermeable panel-type material, all joints shall be sealed to prevent air leakage.

**2)** Except as provided in Sentence 9.25.3.6.(3), where the *air barrier system* consists of flexible sheet material, all joints shall be

- a) sealed, or
- b) lapped not less than 100 mm and clamped, such as between framing members, furring or blocking, and rigid panels.

**3)** Where an interior wall meets an exterior wall, ceiling, floor or roof required to be provided with air barrier protection, the *air barrier system* shall extend across the intersection.

**4)** Where an interior wall projects through a ceiling or extends to become an exterior wall, spaces in the wall shall be blocked to provide continuity across those spaces with the *air barrier system* in the abutting walls or ceiling.

**5)** Where an interior floor projects through an exterior wall or extends to become an exterior floor, continuity of the *air barrier system* shall be maintained from the abutting walls across the floor assembly.

**6)** Penetrations of the *air barrier system*, such as those created by the installation of doors, windows, electrical wiring, electrical boxes, piping or ductwork, shall be sealed to maintain the integrity of the *air barrier system* over the entire surface.

**7)** Where access hatches and sump pit covers are installed through assemblies constructed with an *air barrier system*, they shall be weatherstripped around their perimeters to prevent air leakage.

**8)** Clearances between *chimneys* or *gas vents* and the surrounding construction that would permit air leakage from within the *building* into a wall or *attic* or *roof space* shall be sealed by *noncombustible* material to prevent such leakage.

**9.25.3.4. Air Leakage Control in Masonry Walls**

(See Note A-9.25.3.4. and 9.25.3.6.)

**1)** Masonry walls required to provide a barrier to the ingress of air from the ground shall

- a) include a course of masonry units without voids, or
- b) be sealed with flashing material extending across the full width of the masonry.

**2)** The masonry course or flashing described in Sentence (1) shall

- a) be located at the level of the adjoining floor and be sealed to it in accordance with Article 9.25.3.6., or
- b) in the absence of a floor, be located at the level of the ground cover required by Article 9.18.6.1. and be sealed to it.

**9.25.3.5. Air Leakage Control in Underground Roofs**

**1)** Waterproofing systems for roofs of underground structures shall be sealed to the air barrier in the walls.

**9.25.3.6. Air Barrier Systems in Floors-on-ground**

(See Note A-9.25.3.4. and 9.25.3.6.)

**1)** Materials used to provide a barrier to the ingress of air through floors-on-ground shall conform to CAN/CGSB-51.34-M, "Vapour Barrier, Polyethylene Sheet for Use in Building Construction."

- 2)** Where the floor-on-ground is a concrete slab, the air barrier shall be
- installed below the slab, or
  - applied to the top of the slab, provided a separate floor is installed over the slab.

(See Note A-9.25.3.6.(2) and (3).)

**3)** Where the air barrier installed below a floor-on-ground is flexible sheet material, joints in the barrier shall be lapped not less than 300 mm. (See Note A-9.25.3.6.(2) and (3).)

**4)** Where installed in conjunction with a framed floor-on-ground or above a floor-on-ground, the air barrier shall be installed in accordance with Article 9.25.3.3.

**5)** A floor-on-ground shall be sealed around its perimeter to the inner surfaces of adjacent walls using flexible sealant.

**6)** All penetrations of a floor-on-ground that are required to drain water from the floor surface shall be sealed in a manner that prevents the upward flow of air without preventing the downward flow of liquid water.

**9.25.4. Vapour Barriers****9.25.4.1. Required Barrier to Vapour Diffusion**

**1)** Thermally insulated wall, ceiling and floor assemblies shall be constructed with a *vapour barrier* so as to provide a barrier to diffusion of water vapour from the interior into wall spaces, floor spaces or *attic or roof spaces*.

**9.25.4.2. Vapour Barrier Materials**

**1)** *Vapour barriers* shall have a permeance not greater than 60 ng/(Pa·s·m<sup>2</sup>) measured in accordance with ASTM E 96/E 96M, "Water Vapor Transmission of Materials," using the desiccant method (dry cup).

**2)** Where the intended use of the interior space will result in high moisture generation, the assembly shall be designed according to Part 5. (See Note A-9.25.4.2.(2).)

**3)** Where polyethylene is installed to serve only as the *vapour barrier*, it shall comply with Clause 4.4, Thermal Stability, and Clause 5.7, Oxidative Induction Time, of CAN/CGSB-51.34-M, "Vapour Barrier, Polyethylene Sheet for Use in Building Construction."

**4)** Membrane-type *vapour barriers* other than polyethylene shall conform to the requirements of CAN/CGSB-51.33-M, "Vapour Barrier Sheet, Excluding Polyethylene, for Use in Building Construction."

**5)** Where a coating is applied to gypsum board to function as the *vapour barrier*, the permeance of the coating shall be determined in accordance with CAN/CGSB-1.501-M, "Method for Permeance of Coated Wallboard."

**6)** Where foamed plastic insulation functions as the *vapour barrier*, it shall be sufficiently thick so as to meet the requirement of Sentence (1).

**9.25.4.3. Installation of Vapour Barriers**

**1)** Products installed to function as the *vapour barrier* shall protect the warm side of wall, ceiling and floor assemblies.

**2)** Where different products are used for the *vapour barrier* and the insulation, the *vapour barrier* shall be installed sufficiently close to the warm side of the insulation to prevent condensation at design conditions. (See Note A-9.25.4.3.(2) and Note A-9.25.5.1.(1).)

**3)** Where the same product is used for the *vapour barrier* and the insulation, the product shall be installed sufficiently close to the warm side of the assembly to prevent condensation at design conditions. (See Notes A-9.25.4.3.(2), A-9.25.5.1.(1) and A-9.25.5.2.)

## 9.25.5. Properties and Position of Materials in the Building Envelope

### 9.25.5.1. General

(See Note A-9.25.5.1.)

**1)** Except as provided in Sentences (2) to (4), sheet and panel-type materials incorporated into assemblies described in Article 9.25.1.1. shall conform to Article 9.25.5.2., where

- a) the material has
  - i) an air leakage characteristic less than  $0.1 \text{ L}/(\text{s}\cdot\text{m}^2)$  at 75 Pa, and
  - ii) a water vapour permeance less than  $60 \text{ ng}/(\text{Pa}\cdot\text{s}\cdot\text{m}^2)$  when measured in accordance with ASTM E 96/E 96M, "Water Vapor Transmission of Materials," using the desiccant method (dry cup) (see Note A-9.25.5.1.(1)(a)(ii)), and
- b) the intended use of the interior space where the materials are installed will not result in high moisture generation.

(See Note A-9.25.5.1.(1).)

**2)** Where the intended use of the interior space will result in high moisture generation, the assembly shall be designed according to Part 5.

**3)** Wood-based sheathing materials not more than 12.5 mm thick and complying with Article 9.23.17.2. need not comply with Sentence (1). (See Note A-9.25.5.1.(3).)

**4)** Where a material has a water vapour permeance not less than  $30 \text{ ng}/(\text{Pa}\cdot\text{s}\cdot\text{m}^2)$  and a thermal resistance not less than  $0.7 \text{ (m}^2\cdot\text{K)}/\text{W}$  and the heating degree-days of the *building* location are less than 6000, the assembly need not comply with Sentence (1).

### 9.25.5.2. Position of Low Permeance Materials

(See Note A-9.25.5.2.)

- 1)** Sheet and panel-type materials described in Article 9.25.5.1. shall be installed
- a) on the warm face of the assembly (see also Article 9.25.4.2.),
  - b) at a location where the ratio between the total thermal resistance of all materials outboard of its innermost impermeable surface and the total thermal resistance of all materials inboard of that surface is not less than that required by Table 9.25.5.2., or
  - c) outboard of an air space that is vented to the outdoors.

**2)** For walls, the air space described in Clause (1)(c) shall comply with Clause 9.27.2.2.(1)(a).

**Table 9.25.5.2.**  
**Ratio of Outboard to Inboard Thermal Resistance**  
 Forming Part of Sentence 9.25.5.2.(1)

Heating Degree-Days of <i>Building</i> Location <sup>(1)</sup> , Celsius degree-days	Minimum Ratio of Total Thermal Resistance Outboard of Material's Inner Surface to Total Thermal Resistance Inboard of Material's Inner Surface
up to 4 999	0.20
5 000 to 5 999	0.30
6 000 to 6 999	0.35
7 000 to 7 999	0.40
8 000 to 8 999	0.50
9 000 to 9 999	0.55
10 000 to 10 999	0.60
11 000 to 11 999	0.65
12 000 or higher	0.75

**Notes to Table 9.25.5.2.:**

(1) See Sentence 1.1.3.1.(1).

## **Section 9.26. Roofing**

### **9.26.1. General**

#### **9.26.1.1. Definitions**

**1)** For the purpose of this Section, the term “roof” shall mean sloped or near-horizontal assemblies that protect the spaces beneath them, including platforms that effectively serve as roofs with respect to the accumulation or drainage of precipitation. (See Note A-9.26.1.1.(1).)

**2)** For the purpose of this Section, the term “roofing” shall mean the primary covering for roofs.

#### **9.26.1.2. Required Protection**

- 1)** Roofs shall be protected with roofing, including flashing, installed so as to
  - a) effectively shed water,
  - b) prevent the ingress of water and moisture into *building* assemblies and occupied space, and
  - c) minimize the ingress of water due to ice damming into *building* assemblies.
- 2)** Compliance with Sentence (1) shall be demonstrated by conforming to
  - a) the remainder of this Subsection, or
  - b) Part 5.

#### **9.26.1.3. Alternative Installation Methods**

**1)** Methods described in CAN3-A123.51-M, “Asphalt Shingle Application on Roof Slopes 1:3 and Steeper,” or in CAN3-A123.52-M, “Asphalt Shingle Application on Roof Slopes 1:6 to Less Than 1:3,” are permitted to be used for asphalt shingle applications not described in this Section.

### **9.26.2. Roofing Materials**

#### **9.26.2.1. Material Standards**

**1)** Where materials used for the preparation of the substrate for roofing are covered in the scope of a standard listed in Table 9.26.2.1.-A, they shall conform to that standard.

**Table 9.26.2.1.-A**  
**Materials for Preparation of the Substrate for Roofing**  
 Forming Part of Sentence 9.26.2.1.(1)

Type of Material	Standards
Sheathing membranes	CAN/CGSB-51.32-M, "Sheathing, Membrane, Breather Type"
Primers	CGSB 37-GP-9Ma, "Primer, Asphalt, Unfilled, for Asphalt Roofing, Dampproofing and Waterproofing"

**2)** Where roofing materials are covered in the scope of a standard listed in Table 9.26.2.1.-B, they shall conform to that standard.

**Table 9.26.2.1.-B**  
**Roofing Materials**  
 Forming Part of Sentence 9.26.2.1.(2)

Types of Roof Covering	Standards
Built-up roofing (BUR)	ASTM D 3019, "Lap Cement Used with Asphalt Roll Roofing, Non-Fibered, Asbestos-Fibered, and Non-Asbestos-Fibered" <sup>(1)</sup> ASTM D 4479/D 4479M, "Asphalt Roof Coatings – Asbestos-Free" CGSB 37-GP-56M, "Membrane, Modified, Bituminous, Prefabricated, and Reinforced for Roofing" CAN/CGSB-37.50-M, "Hot-Applied, Rubberized Asphalt for Roofing and Waterproofing" CAN/CSA-A123.2, "Asphalt-Coated Roofing Sheets" CSA A123.3, "Asphalt Saturated Organic Roofing Felt" CAN/CSA-A123.4, "Asphalt for Constructing Built-Up Roof Coverings and Waterproofing Systems" CSA A123.17, "Asphalt Glass Felt Used in Roofing and Waterproofing"
Single-ply membranes	CAN/CGSB-37.54, "Polyvinyl Chloride Roofing and Waterproofing Membrane" CAN/CGSB-37.58-M, "Membrane, Elastomeric, Cold-Applied Liquid, for Non-Exposed Use in Roofing and Waterproofing" ASTM D 4637/D 4637M, "EPDM Sheet Used In Single-Ply Roof Membrane" ASTM D 4811/D 4811M, "Nonvulcanized (Uncured) Rubber Sheet Used as Roof Flashing" ASTM D 6878/D 6878M, "Thermoplastic Polyolefin Based Sheet Roofing"
Shingles, shakes, tiles, panels	CSA A123.1/A123.5, "Asphalt Shingles Made From Organic Felt and Surfaced with Mineral Granules/Asphalt Shingles Made From Glass Felt and Surfaced with Mineral Granules" CAN/CSA-A220, "Concrete Roof Tiles" CSA O118.1, "Western Red Cedar Shakes and Shingles" CSA O118.2, "Eastern White Cedar Shingles"
Eave protection	CSA A123.22, "Self-Adhering Polymer Modified Bituminous Sheet Materials Used as Steep Roofing Underlayment for Ice Dam Protection"
Flashing	ASTM D 4811/D 4811M, "Nonvulcanized (Uncured) Rubber Sheet Used as Roof Flashing"

**Notes to Table 9.26.2.1.-B:**

(1) For the purpose of this Subsection, ASTM D 3019 shall only apply to the non-fibered and non-asbestos-fibered types (I and III) of asphalt roll roofing.

**9.26.2.2. Installation of Materials**

**1)** Materials listed in Tables 9.26.2.1.-A and 9.26.2.1.-B shall be installed in conformance with the manufacturer's written instructions. (See Sentence 1.5.1.2.(1) of Division A.)



**9.26.2.3. Nails**

- 1)** Nails used for roofing shall be corrosion-resistant roofing or shingle nails conforming to
  - a) ASTM F 1667, "Driven Fasteners: Nails, Spikes, and Staples," or
  - b) CSA B111, "Wire Nails, Spikes and Staples."
- 2)** Nails shall have sufficient length to penetrate through, or 12 mm into, roof sheathing.
- 3)** Nails used with asphalt roofing shall have a head diameter of not less than 9.5 mm and a shank thickness of not less than 2.95 mm.
- 4)** Nails used with wood shingles or shakes shall have a head diameter of not less than 4.8 mm and a shank thickness of not less than 2.0 mm and shall be stainless steel, aluminum or hot-dipped galvanized. (See Note A-9.26.2.3.(4).)

**9.26.2.4. Staples**

- 1)** Staples used to apply asphalt or wood shingles shall be corrosion-resistant and shall be driven with the crown parallel to the eaves.
- 2)** Staples used with asphalt shingles shall be not less than 19 mm long, 1.6 mm diam or thickness, with not less than a 25 mm crown, except that an 11 mm crown may be used as provided in Sentence 9.26.7.4.(2).
- 3)** Staples used with wood shingles shall be not less than 29 mm long, 1.6 mm diam or thickness, with not less than a 9.5 mm crown and shall be stainless steel or aluminum. (See Note A-9.26.2.3.(4).)

**9.26.3. Slope of Roofed Surfaces****9.26.3.1. Slope**

- 1)** Except as provided in Sentences (2) and (3), the slopes on which roof coverings may be applied shall conform to Table 9.26.3.1.
- 2)** Asphalt and gravel or coal tar and gravel roofs may be constructed with lower slopes than required in Sentence (1) when effective drainage is provided by roof drains located at the lowest points on the roofs.
- 3)** Profiled metal roof cladding systems specifically designed for low-slope applications are permitted to be installed with lower slopes than required by Sentence (1), provided they are installed in conformance with the manufacturer's written recommendations.
- 4)** Except where back-slope will not adversely affect adjacent supported or supporting constructions due to water ingress, roofs and constructions that effectively serve as roofs shall be constructed with sufficient slope away from
  - a) exterior walls, and
  - b) *guards* that are connected to the roof, or to a construction that effectively serves as a roof, by more than pickets or posts.(See Notes A-9.26.1.1.(1), A-9.26.4.1. and A-9.27.3.8.(4).)
- 5)** The slope required by Sentence (4) shall be sufficient to maintain a positive slope
  - a) after expected shrinkage of the *building* frame, where these surfaces are supported by exterior walls and exterior columns (see Note A-9.27.3.8.(4)), and
  - b) once design loading is taken into consideration, where these surfaces are cantilevered from exterior walls.

**Table 9.26.3.1.**  
**Roofing Types and Slope Limits**  
 Forming Part of Sentence 9.26.3.1.(1)

Type of Roofing	Minimum Slope	Maximum Slope
Asbestos-Cement Corrugated Sheets	1 in 4	no limit
Asphalt Shingles		
Low slope application	1 in 6	no limit
Normal application	1 in 3	no limit
Built-up Roofing		
Asphalt base (without gravel)	1 in 25	1 in 2
Asphalt base (gravelled)	1 in 50 <sup>(1)</sup>	1 in 4
Coal-tar base (gravelled)	1 in 50 <sup>(1)</sup>	1 in 25
Cold process	1 in 25	1 in 1.33
Cedar Shakes	1 in 3	no limit
Clay Tile	1 in 2	no limit
Glass Fibre Reinforced Polyester Roofing Panels	1 in 4	no limit
Modified Bituminous Membranes	1 in 50	1 in 4
Profiled Metal Roofing	1 in 4 <sup>(1)</sup>	no limit
Roll Roofing		
480 mm wide selvage asphalt roofing	1 in 6	no limit
Cold application felt	1 in 50	1 in 1.33
Smooth and mineral surfaced	1 in 4	no limit
Sheet Metal Shingles	1 in 4 <sup>(1)</sup>	no limit
Slate Shingles	1 in 2	no limit
Wood Shingles	1 in 4	no limit

**Notes to Table 9.26.3.1.:**

(1) See Sentence 9.26.3.1.(3).

## 9.26.4. Flashing at Intersections

### 9.26.4.1. Required Flashing at Intersections

(See Notes A-9.26.4.1. and A-9.26.1.1.(1).)

**1)** Except where the omission of flashing will not adversely affect adjacent supported or supporting constructions, flashing shall be installed at junctions between roofs and

- a) walls that rise above the roof, and
- b) *guards* that are connected to the roof by more than pickets or posts.

**2)** For the purpose of Sentence (1), roofs shall include platforms that effectively serve as roofs with respect to the accumulation or drainage of precipitation.

### 9.26.4.2. Materials

- 1)** Sheet metal flashing shall consist of not less than
- a) 1.73 mm thick sheet lead,
  - b) 0.33 mm thick galvanized steel,
  - c) 0.33 mm thick copper,
  - d) 0.35 mm thick zinc, or
  - e) 0.48 mm thick aluminum.

### 9.26.4.3. Valley Flashing

**1)** Where sloping surfaces of shingled roofs intersect to form a valley, the valley shall be flashed.

- 2)** Valley flashing shall be installed over continuous sheathing.

- 3) Closed valleys shall not be used with rigid shingles on slopes of less than 1 in 1.2.
- 4) Open valleys shall be flashed with at least
  - a) one layer of sheet metal not less than 600 mm wide, or
  - b) 2 layers of roll roofing.

5) The bottom layer of roofing required in Sentence (4) shall consist of at least Type S smooth roll roofing or Type M mineral surface roll roofing (mineral surface down) not less than 457 mm wide, centred in the valley and fastened with nails spaced not more than 450 mm o.c. located 25 mm away from the edges.

6) The top layer of roofing required in Sentence (4) shall consist of at least Type M mineral surface roll roofing (mineral surface up), 914 mm wide, centred in the valley, applied over a 100 mm wide strip of cement along each edge of the bottom layer, and fastened with a sufficient number of nails to hold it in place until the shingles are applied.

#### 9.26.4.4. Intersection of Shingle Roofs and Masonry

- 1) The intersection of shingle roofs and masonry walls or *chimneys* shall be protected with flashing.
- 2) Counter flashing required in Sentence (1) shall be embedded not less than 25 mm in the masonry and shall extend not less than 150 mm down the masonry and lap the lower flashing not less than 100 mm.
- 3) Flashing along the slopes of a roof described in Sentence (1) shall be stepped so that there is not less than a 75 mm head lap in both the lower flashing and counter flashing.
- 4) Where the roof described in Sentence (1) slopes upwards from the masonry, the flashing shall extend up the roof slope to a point equal in height to the flashing on the masonry, but not less than 1.5 times the shingle exposure.

#### 9.26.4.5. Intersection of Shingle Roofs and Walls other than Masonry

- 1) The intersection of shingle roofs and walls clad with other than masonry shall be protected with flashing.
- 2) Flashing required in Sentence (1) shall be installed so that it extends up the wall not less than 75 mm behind the sheathing paper, and extends not less than 75 mm horizontally.
- 3) Along the slope of the roof, the flashing required in Sentence (1) shall be stepped with not less than a 75 mm head lap.

#### 9.26.4.6. Intersection of Built-Up Roofs and Masonry

- 1) The intersection of built-up roofs with masonry walls or *chimneys* shall have a cant strip at the intersection, and a roofing membrane shall be mopped over the cant strip and not less than 150 mm up the wall.
- 2) Counter flashing installed over the intersection referred to in Sentence (1) shall be embedded not less than 25 mm in the masonry, and shall be of sufficient length to extend down not less than 150 mm, lapping the membrane on the masonry not less than 100 mm.

#### 9.26.4.7. Intersection of Built-Up Roofs and Walls other than Masonry

- 1) The intersection of built-up roofs with walls clad with other than masonry shall have a cant strip at the intersection.
- 2) The roofing membrane shall be mopped over the cant strip referred to in Sentence (1).
- 3) Flashing plies shall extend not less than 150 mm up the wall referred to in Sentence (1) behind the sheathing paper.

**9.26.4.8. Chimney Saddles**

- 1) Except as otherwise permitted in Sentence (5), *chimney* saddles shall be installed where the upper side of a *chimney* on a sloping roof is more than 750 mm wide.
- 2) *Chimney* saddles shall be covered with sheet metal or roofing material of weight and quality equivalent to the roofing.
- 3) Saddles shall be flashed where they intersect the roof.
- 4) The intersection of the saddle and the *chimney* shall be flashed and counterflashed as described in Article 9.26.4.4.
- 5) A *chimney* saddle need not be installed if the intersection between the *chimney* and roof is protected by sheet metal flashing that extends up the *chimney* to a height equal to at least one sixth the width of the *chimney*, but not less than 150 mm, and up the roof slope to a point equal in height to the flashing on the *chimney*, but not less than 1.5 times the shingle exposure.
- 6) Flashing described in Sentence (5) at the *chimney* shall be counterflashed as required by Article 9.26.4.4.

**9.26.5. Eave Protection for Shingles and Shakes****9.26.5.1. Required Eave Protection**

- 1) Except as provided in Sentence (2), eave protection shall be provided on shingle, shake or tile roofs, extending from the edge of the roof a minimum of 900 mm up the roof slope to a line not less than 300 mm inside the inner face of the exterior wall.
- 2) Eave protection is not required
  - a) over unheated garages, carports and porches,
  - b) where the roof overhang exceeds 900 mm measured along the roof slope from the edge of the roof to the inner face of the exterior wall,
  - c) on roofs of asphalt shingles installed in accordance with Subsection 9.26.8.,
  - d) on roofs with slopes of 1 in 1.5 or greater, or
  - e) in regions with 3 500 or fewer degree-days.

**9.26.5.2. Materials**

- 1) Eave protection shall be laid beneath the starter strip and shall consist of
  - a) No. 15 asphalt-saturated felt laid in two plies lapped 480 mm and cemented together with lap cement,
  - b) Type M or S roll roofing laid with not less than 100 mm head and end laps cemented together with lap cement,
  - c) glass fibre or polyester fibre coated base sheets, or
  - d) self-sealing composite membranes consisting of modified bituminous coated material.

**9.26.6. Underlay beneath Shingles****9.26.6.1. Materials**

- 1) Except as required in Sentence (2), when underlay is used beneath shingles, it shall be
  - a) asphalt-saturated sheathing paper weighing not less than 0.195 kg/m<sup>2</sup>, or
  - b) No. 15 plain or perforated asphalt-saturated felt.
- 2) Underlay used beneath wood shingles shall be breather type.

**9.26.6.2. Installation**

- 1) When used with shingles, underlay shall be installed parallel to the eaves with head and end lap of not less than 50 mm.
- 2) The top edge of each strip of underlay referred to in Sentence (1) shall be fastened with sufficient roofing nails to hold it in place until the shingles are applied.

**3)** The underlay referred to in Sentence (1) shall overlap the eave protection by not less than 100 mm. (See Article 9.26.10.2. for underlay beneath wood shakes.)

### **9.26.7. Asphalt Shingles on Slopes of 1 in 3 or Greater**

#### **9.26.7.1. Coverage**

**1)** Coverage shall be not less than 2 thicknesses of shingle over the entire roof, disregarding cutouts.

#### **9.26.7.2. Starter Strip**

**1)** A starter strip shall be installed along the lower edge of the roof so that it extends approximately 12 mm beyond the eaves and rake of the roof and fastened along the bottom edge with nails spaced not more than 300 mm o.c.

**2)** Starter strips shall be

- a) at least Type M mineral-surfaced roll roofing not less than 300 mm wide,
- b) shingles of the same weight and quality as those used as a roof covering with tabs facing up the roof slope, or
- c) pre-manufactured starter strips installed with sealant at the eaves.

**3)** Starter strips need not be provided where eave protection of not less than Type M mineral-surfaced roll roofing is provided.

#### **9.26.7.3. Head Lap**

**1)** Shingles shall have a head lap of not less than 50 mm.

#### **9.26.7.4. Fasteners**

**1)** Except as provided in Sentence (2), shingles shall be fastened with at least 4 nails or staples for 1 m wide shingles so that no nails or staples are exposed.

**2)** Where staples with an 11 mm crown are used, shingles shall be fastened with at least 6 staples.

**3)** Fasteners may be reduced for narrower shingles in proportion to the width of the shingle or when shingles incorporating interlocking devices are used.

**4)** Fasteners referred to in Sentences (1) and (2) shall be located 25 mm to 40 mm from each end of each strip shingle with other fasteners equally spaced between them.

**5)** Fasteners referred to in Sentences (1) and (2) shall be located not less than 12 mm above the tops of the cutouts.

#### **9.26.7.5. Securing of Tabs**

**1)** Shingle tabs shall be secured by a spot of plastic cement not exceeding 25 mm diam under the centre of each tab or by interlocking devices or self-sealing strips.

#### **9.26.7.6. Hips and Ridges**

**1)** Shingles on hips and ridges shall be applied so they extend not less than 100 mm on either side of the hip or ridge, and shall be lapped not less than 150 mm.

**2)** Shingles referred to in Sentence (1) shall be fastened with nails or staples on each side located not more than 25 mm from the edge and 25 mm above the butt of the overlying shingle.

#### **9.26.7.7. Eave Protection**

**1)** Eave protection shall conform to Subsection 9.26.5.

#### **9.26.7.8. Flashing**

**1)** Flashing shall conform to Subsection 9.26.4.

**9.26.8. Asphalt Shingles on Slopes of less than 1 in 3****9.26.8.1. Coverage**

1) Except for the first 2 courses, coverage shall be not less than 3 thicknesses of shingle over the entire roof, disregarding cutouts.

**9.26.8.2. Starter Strip**

1) A starter strip shall be installed as in Article 9.26.7.2.

2) Starter strips required in Sentence (1) shall be laid in a continuous band of cement not less than 200 mm wide.

**9.26.8.3. Securing of Tabs**

1) Shingle tabs shall be secured with cold application cement applied at the rate of not less than 0.5 L/m<sup>2</sup> of cemented area, or hot application asphalt applied at the rate of 1 kg/m<sup>2</sup> of cemented area.

**9.26.8.4. Securing of Shingle Courses**

1) The first course of shingles shall be secured by a continuous band of cement along the eaves applied so that the width of the band equals the shingle exposure plus 100 mm.

2) The succeeding courses of shingles shall be secured by a continuous band of cement applied so that the width of the band equals the shingle exposure plus 50 mm.

3) The band required in Sentence (2) shall be located not more than 50 mm above the butt of the overlying course of shingles.

**9.26.8.5. Hips and Ridges**

1) Shingles on hips and ridges shall be not less than 300 mm wide applied to provide triple coverage.

2) Shingles referred to in Sentence (1) shall be cemented to the roof shingles and to each other with a coat of cement and fastened with nails or staples located 40 mm above the butt of the overlying shingle and 50 mm from each edge.

**9.26.8.6. Flashing**

1) Flashing shall conform to Subsection 9.26.4.

**9.26.8.7. Fastening**

1) Shingles shall be fastened in accordance with Article 9.26.7.4.

**9.26.9. Wood Roof Shingles****9.26.9.1. Decking**

1) Except as provided in Sentence 9.23.16.1.(1), decking for wood shingled roofs may be continuous or spaced.

**9.26.9.2. Grade**

1) Western cedar shingles shall be not less than No. 2 grade.

2) Eastern white cedar shingles shall be not less than B (clear) grade.

**9.26.9.3. Size**

1) Wood shingles shall be not less than 400 mm long and not less than 75 mm or more than 350 mm wide.

**9.26.9.4. Spacing and Joints**

1) Shingles shall be spaced approximately 6 mm apart and offset at the joints in adjacent courses not less than 40 mm so that joints in alternate courses are staggered.

**9.26.9.5. Fastening**

1) Shingles shall be fastened with 2 nails or staples located approximately 20 mm from the sides of the shingle and 40 mm above the exposure line.

**9.26.9.6. Exposure**

1) The exposure of wood roof shingles shall conform to Table 9.26.9.6.

**Table 9.26.9.6.**  
**Exposure of Wood Roof Shingles**  
 Forming Part of Sentence 9.26.9.6.(1)

Roof Slope	Maximum Exposure, mm					
	No.1 or A Grade Length of Shingle, mm			No. 2 or B Grade Length of Shingle, mm		
	400	450	600	400	450	600
< 1 in 3	100	115	165	90	100	140
≥ 1 in 3	125	140	190	100	115	165

**9.26.9.7. Flashing**

1) Flashing shall conform to Subsection 9.26.4.

**9.26.9.8. Eave Protection**

1) Eave protection shall conform to Subsection 9.26.5.

**9.26.10. Cedar Roof Shakes**

**9.26.10.1. Size and Thickness**

1) Shakes shall be not less than 450 mm long and not less than 100 mm nor more than 350 mm wide with a butt thickness of not more than 32 mm and not less than 9 mm.

**9.26.10.2. Underlay**

1) Where eave protection is not provided, an underlay conforming to the requirements in Article 9.26.6.1. for wood shingles shall be laid as a strip not less than 900 mm wide along the eaves.

2) A strip of material similar to that described in Sentence (1) not less than 450 mm wide shall be interlaid between each course of shakes with the bottom edge of the strip positioned above the butt line at a distance equal to double the exposure of the shakes.

3) Interlaid strips referred to in Sentence (2) shall be lapped not less than 150 mm at hips and ridges in a manner that will prevent water from reaching the roof sheathing.

**9.26.10.3. Spacing and Joints**

1) Shakes shall be spaced 6 mm to 9 mm apart and the joints in any one course shall be separated not less than 40 mm from joints in adjacent courses.

**9.26.10.4. Fastening**

1) Shakes shall be fastened with nails located approximately 20 mm from the sides of the shakes and 40 mm above the exposure line.

**9.26.10.5. Exposure**

- 1) The exposure of wood shakes shall not exceed
  - a) 190 mm for shakes not less than 450 mm long, and
  - b) 250 mm for shakes not less than 600 mm long.

**9.26.10.6. Flashing**

- 1) Flashing shall conform to Subsection 9.26.4.

**9.26.10.7. Eave Protection**

- 1) Eave protection shall conform to Subsection 9.26.5.

**9.26.10.8. Grade**

- 1) Shakes shall be not less than No. 1 or Handsplit grade.

**9.26.11. Built-Up Roofs****9.26.11.1. Quantity of Materials**

- 1) The quantities of bituminous materials used on built-up roofs shall conform to Table 9.26.11.1.

**Table 9.26.11.1.**  
**Quantities of Bitumen for Built-up Roofs**  
 Forming Part of Sentence 9.26.11.1.(1)

Type of Roof	Amount of Bitumen per Square Metre of Roof Surface	
	Mopping Coats between Layers	Flood Coat
Asphalt and aggregate	1 kg	3 kg
Coal-tar and aggregate	1.2 kg	3.6 kg
Cold process roofing	0.75 L cold process cement	2 L cold process top coating

**9.26.11.2. Coal-Tar and Asphalt Products**

- 1) Coal-tar products and asphalt products shall not be used together in built-up roof construction.

**9.26.11.3. Roof Felts**

- 1) Bitumen roofing felts shall be at least No. 15 felt.

**9.26.11.4. Aggregate Surfacing**

- 1) Aggregate used for surfacing built-up roofs shall be clean, dry and durable and shall consist of particles of gravel, crushed stone or air-cooled blast *furnace* slag having a size of from 6 mm to 15 mm.
- 2) The minimum amount of aggregate surfacing per square metre of roof surface shall be 15 kg gravel or crushed stone or 10 kg crushed slag.

**9.26.11.5. Flashing**

- 1) Flashing for built-up roofs shall conform to Subsection 9.26.4.

**9.26.11.6. Number of Layers**

- 1) Built-up roofing shall consist of not less than 3 mopped-down layers of roofing felt flood coated with bitumen.



**9.26.11.7. Installation of Layers**

- 1) In hot process applications each layer of bitumen-saturated felt shall be laid while the bitumen is hot, with each layer overlapping the previous one.
- 2) The full width under each lap referred to in Sentence (1) shall be coated with bitumen so that in no place does felt touch felt.
- 3) Felt shall be laid free of wrinkles and shall be rolled directly into the hot bitumen and broomed forward and outward from the centre to ensure complete adhesion.

**9.26.11.8. Roofing over Wood-Based Sheathing**

- 1) Except as permitted in Sentence (2), built-up roofing applied over wood, plywood, OSB or waferboard roof sheathing shall be laid over an additional base layer of felt laid dry over the entire roof deck with not less than a 50 mm headlap and a 50 mm sidelap between each sheet.
- 2) Where plywood, OSB or waferboard roof sheathing is used, the dry layer of felt required in Sentence (1) may be omitted when the joints are taped and the sheathing is primed with asphalt.

**9.26.11.9. Attachment to Decking**

- 1) Roofing shall be securely attached to the decking or where insulation is applied above the deck, the insulation shall be securely attached to the deck before the first layer of felt is fastened to the insulation.

**9.26.11.10. Cant Strips**

- 1) Except as permitted in Sentence (4), a cant strip shall be provided at the edges of roofs.
- 2) At least 2 plies of the roofing membrane shall be carried over the top of the cant strip.
- 3) Flashing shall extend over the top of the cant strip and be shaped to form a drip.
- 4) The cant strip required in Sentence (1) need not be provided where a gravel stop is installed at the edge of roofs.
- 5) The roofing membranes shall be carried over the edge of the roof before the gravel stop referred to in Sentence (4) is fastened and 2 plies of roofing membrane mopped to the top surface of the gravel stop before the flood coat is applied.
- 6) The gravel stop referred to in Sentence (4) shall extend over the edge of the roof to form a drip or shall be flashed so that the flashing extends over the edge to form a drip.

**9.26.12. Selvage Roofing****9.26.12.1. Coverage**

- 1) Wide selvage asphalt roofing shall provide double coverage over the entire roof surface.

**9.26.12.2. Joints**

- 1) Plies of selvage roofing shall be cemented together to ensure a watertight joint.

**9.26.13. Sheet Metal Roofing****9.26.13.1. Thickness**

- 1) Sheet metal roofing shall be not less than
  - a) 0.33 mm thick galvanized steel,
  - b) 0.46 mm thick copper,
  - c) 0.46 mm thick zinc, or
  - d) 0.48 mm thick aluminum.

**9.26.13.2. Support**

1) Except as provided in Sentence 9.23.16.1.(1), where sheet metal roofing is not supported by roof decking but spans between spaced supports, the panels shall be designed to support the specified *live loads* for roofs.

**9.26.14. Glass Reinforced Polyester Roofing****9.26.14.1. Support**

1) Except as provided in Sentence 9.23.16.1.(1), where glass-reinforced polyester roofing panels are not supported by roof decking but span between spaced supports, the panels shall be designed to support the specified live roof loads.

**9.26.15. Hot Applied Rubberized Asphalt Roofing****9.26.15.1. Installation**

1) Hot applied rubberized asphalt roofing shall be installed in accordance with CAN/CGSB-37.51-M, "Application for Hot-Applied Rubberized Asphalt for Roofing and Waterproofing."

**9.26.16. Polyvinyl Chloride Sheet Roofing****9.26.16.1. Installation**

1) Polyvinyl chloride sheet applied roofing membrane shall be installed in accordance with CGSB 37-GP-55M, "Application of Sheet Applied Flexible Polyvinyl Chloride Roofing Membrane."

**9.26.17. Concrete Roof Tiles****9.26.17.1. Installation**

1) Except as provided in Sentence 9.23.16.1.(1), concrete roof tiles shall be installed according to CAN/CSA-A220, "Concrete Roof Tiles." (See Note A-9.26.17.1.(1).)

**9.26.18. Roof Drains and Downspouts****9.26.18.1. Roof Drains**

1) When roof drains are provided they shall conform to Part 7.

**9.26.18.2. Downspouts**

1) Where downspouts are provided and are not connected to a sewer, extensions shall be provided to carry rainwater away from the *building* in a manner which will prevent *soil erosion*.

**Section 9.27. Cladding****9.27.1. Application****9.27.1.1. General**

1) Where lumber, wood shingles, shakes, fibre-cement shingles, planks and sheets, plywood, OSB, waferboard, hardboard, vinyl, aluminum or steel, including trim and soffits, are installed as cladding on wood-frame walls exposed to precipitation, the cladding assembly shall comply with

- a) Subsections 9.27.2. to 9.27.12., or
- b) Part 5.

- 2)** Where stucco is installed as cladding on wood-frame or masonry walls exposed to precipitation, the cladding assembly shall comply with
  - a) Subsections 9.27.2. to 9.27.5., and Section 9.28., or
  - b) Part 5.
- 3)** Where masonry serves as cladding on wood-frame or masonry walls exposed to precipitation, the cladding assembly shall comply with
  - a) Subsections 9.27.2. to 9.27.4., and Section 9.20., or
  - b) Part 5.
- 4)** Where asphalt shingles are installed as cladding on wood-frame walls exposed to precipitation, the cladding assembly shall comply with
  - a) Subsections 9.26.7. and 9.27.2. to 9.27.4., or
  - b) Part 5.
- 5)** Where an exterior insulation finish system is installed as cladding on wood-frame, masonry, cold-formed steel stud or cast-in-place concrete walls exposed to precipitation, the cladding assembly shall comply with
  - a) Subsections 9.25.5., 9.27.2. to 9.27.4., and 9.27.13., or
  - b) Part 5.
 (See Note A-9.27.1.1.(5).)
- 6)** Where cladding materials other than those described in Sentences (1) to (5) are installed, or where the cladding materials described in Sentences (1) to (5) are installed on substrates other than those identified in Sentences (1) to (5), the materials and installation shall comply with Part 5.

**9.27.2. Required Protection from Precipitation**

(See Note A-9.27.2.)

**9.27.2.1. Minimizing and Preventing Ingress and Damage**

- 1)** Except where exterior walls are protected from precipitation or where it can be shown that precipitation ingress will not adversely affect occupant health or safety, exterior walls shall be designed and constructed to
  - a) minimize the ingress of precipitation into the assembly, and
  - b) prevent the ingress of precipitation into interior space.
 (See Note A-9.27.2.1.(1).)
- 2)** Except where exterior walls are protected from specific mechanisms of deterioration, such as mechanical impact and ultraviolet radiation, exterior walls shall be designed and constructed to minimize the likelihood of their required performance being reduced to an unacceptable level as a result of those mechanisms.

**9.27.2.2. Minimum Protection from Precipitation Ingress**

(See Note A-9.27.2.2.)

- 1)** Except as provided in Sentence (2), a cladding assembly is deemed to have a capillary break between the cladding and the backing assembly, where
  - a) there is a drained and vented air space not less than 10 mm deep behind the cladding, over the full height and width of the wall (see also Article 9.27.5.3.),
  - b) an open drainage material, not less than 10 mm thick and with a cross-sectional area that is not less than 80% open, is installed between the cladding and the backing, over the full height and width of the wall,
  - c) the cladding is loosely fastened to the backing and behind each cladding component there is a clear air space that is
    - i) continuous for the full width of the component,
    - ii) not less than 10 mm deep at the bottom of the component, and
    - iii) not less than 6 mm deep over not less than 90 mm for every 230 mm of exposed height of the component,

- d) the wall is a masonry *cavity wall* or the cladding is masonry veneer constructed according to Section 9.20., or
- e) the cladding conforms to Subsection 9.27.13.

**2)** The drained and vented air space, and drainage material described in Sentence (1) may be interrupted by

- a) penetrations for windows, doors and services,
- b) flashing, and
- c) furring, provided the furring does not make up more than 20% of the furred area.

**3)** Where a construction projects over the top of the drained and vented air space described in Clause (1)(a) or over the drainage material described in Clause (1)(b), the air space or drainage material shall not be contiguous with concealed spaces in the projecting construction.

**4)** Exterior walls exposed to precipitation shall be protected against precipitation ingress by an exterior cladding assembly consisting of a first plane of protection and a second plane of protection, where such walls enclose spaces of *residential occupancy* or spaces that directly serve spaces of *residential occupancy*.

**5)** Except as provided in Sentence (6), exterior walls exposed to precipitation shall be protected against precipitation ingress by an exterior cladding assembly consisting of a first plane of protection and a second plane of protection incorporating a capillary break, where

- a) the number of degree-days is less than 3400 and the moisture index is greater than 0.90, or
- b) the number of degree-days is 3400 or more, and the moisture index is greater than 1.00.

(See Sentence 1.1.3.1.(1) and Appendix C for information on the moisture index.)

**6)** In exterior walls described in Sentence (5), the first and second planes of protection need not incorporate a capillary break, where

- a) it can be shown that omitting the capillary break will not adversely affect the performance of the *building assemblies*,
- b) the *building* is an accessory *building*, or
- c) the wall
  - i) is constructed of non-moisture-sensitive materials, and intersecting or supported floors are also constructed of non-moisture-sensitive materials, or
  - ii) is constructed as a mass wall of sufficient thickness to minimize the transfer of moisture to the interior.

### 9.27.2.3. First and Second Planes of Protection

**1)** Where walls required to provide protection from precipitation comprise cladding assemblies with first and second planes of protection,

- a) the first plane of protection shall
  - i) consist of cladding with appropriate trim, accessory pieces and fasteners, and
  - ii) be designed and constructed to minimize the passage of rain and snow into the wall by minimizing holes and managing precipitation ingress caused by the kinetic energy of raindrops, surface tension, capillarity, gravity, and air pressure differences (see Subsection 9.27.4.),

- b) the second plane of protection shall be designed and constructed to (see Subsection 9.27.3.)
  - i) intercept all rain and snow that gets past the first plane of protection, and
  - ii) effectively dissipate any rain or snow to the exterior, and
- c) the protection provided by the first and second planes of protection shall be maintained
  - i) at wall penetrations created by the installation of components and services such as windows, doors, ventilation ducts, piping, wiring and electrical outlets, and
  - ii) at the interface with other wall assemblies.

**9.27.2.4. Protection of Cladding from Moisture**

**1)** A clearance of not less than 200 mm shall be provided between finished ground and cladding that is adversely affected by moisture, such as untreated wood, plywood, OSB, waferboard and hardboard.

**2)** A clearance of not less than 50 mm shall be provided between a roof surface and cladding that is adversely affected by moisture, such as untreated wood, plywood, OSB, waferboard and hardboard.

**9.27.3. Second Plane of Protection**

**9.27.3.1. Elements of the Second Plane of Protection**

(See Note A-9.27.3.1.)

**1)** The second plane of protection shall consist of a drainage plane having an appropriate inner boundary and flashing to dissipate rainwater to the exterior.

**2)** Except for cladding systems conforming to Subsection 9.27.13., the inner boundary of the drainage plane shall comply with Articles 9.27.3.2. to 9.27.3.6.

- 3)** The protection provided by the second plane of protection shall be maintained
- a) at wall penetrations created by the installation of components and services such as windows, doors, ventilation ducts, piping, wiring and electrical outlets, and
  - b) at the interface with other wall assemblies.

**4)** Flashing material and its installation shall comply with Articles 9.27.3.7. and 9.27.3.8.

**9.27.3.2. Sheathing Membrane Material Standard**

**1)** Sheathing membranes shall conform to the performance requirements of CAN/CGSB-51.32-M, "Sheathing, Membrane, Breather Type."

**9.27.3.3. Required Sheathing Membrane and Installation**

**1)** Except as provided in Articles 9.27.3.4. to 9.27.3.6., at least one layer of sheathing membrane shall be applied beneath cladding.

**2)** Sheathing membrane required in Sentence (1) shall be applied so that joints are lapped not less than 100 mm.

**3)** Where sheathing membrane required in Sentence (1) is applied horizontally, the upper sheets shall overlap the lower sheets.

**9.27.3.4. Insulating Sheathing in lieu of Sheathing Membrane**

**1)** Where non-wood-based rigid exterior insulating sheathing, or exterior insulating sheathing with an integral sheathing membrane is installed, a separate sheathing membrane is not required.

- 2)** Where insulating sheathing is installed as provided in Sentence (1),
  - a) sheathing panels subject to moisture deterioration shall be sealed at all joints, and
  - b) the joints of sheathing panels not subject to moisture deterioration shall be
    - i) sealed at all joints, or
    - ii) lapped or tongue and groove, and detailed to ensure drainage of water to the exterior.

(See Note A-9.27.3.4.(2).)

### 9.27.3.5. Sheathing Membranes in lieu of Sheathing

**1)** Except as provided in Article 9.27.3.6., where no sheathing is used, at least 2 layers of sheathing membrane shall be applied beneath the cladding. (See Article 9.23.17.1. and Note A-9.27.3.5.(1).)

**2)** All joints in the sheathing membrane required in Sentence (1) shall occur over framing, and the membrane shall be fastened to the framing with roofing nails or staples spaced not more than 150 mm along the edges of the outer layer of sheathing membrane.

**3)** Wall sheathing is permitted to be used in lieu of one layer of sheathing membrane required in Sentence (1), and its thickness need not conform to Table 9.23.17.2.-A.

### 9.27.3.6. Face Sealed Cladding

(See Note A-9.27.3.6.)

**1)** Sheathing membrane is permitted to be omitted beneath cladding when the joints in the cladding are formed to effectively prevent the passage of wind and rain in conformance with Sentences (2) or (3), as applicable.

**2)** Cladding consisting of sheets of plywood, hardboard, OSB, waferboard or fibre cement is considered to meet the requirements of Sentence (1), provided the cladding is applied so that

- a) all edges are directly supported by framing,
- b) the vertical joints between adjacent sheets are sealed and
  - i) covered with battens,
  - ii) shiplapped, or
  - iii) otherwise matched to provide weathertight joints, and
- c) the horizontal joints between adjacent sheets are sealed and
  - i) shiplapped, or
  - ii) otherwise matched to provide weathertight joints.

**3)** Metal siding consisting of sheets of metal is considered to meet the requirements of Sentence (1) where the joints between sheets are of the locked-seam type.

### 9.27.3.7. Flashing Materials

- 1)** Flashing shall consist of not less than
  - a) 1.73 mm thick sheet lead,
  - b) 0.33 mm thick galvanized steel,
  - c) 0.46 mm thick copper,
  - d) 0.46 mm thick zinc,
  - e) 0.48 mm thick aluminum, or
  - f) 1.02 mm thick vinyl.

### 9.27.3.8. Flashing Installation

- 1)** Except as provided in Sentence (2), flashing shall be installed at
  - a) every horizontal junction between cladding elements,

- b) every horizontal offset in the cladding, and
- c) every horizontal line where the cladding substrates change and where
  - i) the substrates differ sufficiently for stresses to be concentrated along that line, or
  - ii) the installation of the cladding on the lower substrate may compromise the drainage of moisture from behind the cladding above.

(See Note A-9.27.3.8.(1).)

- 2)** Flashing need not be installed as described in Sentence (1)
  - a) where the upper cladding elements overlap the lower cladding elements by not less than 25 mm,
  - b) where
    - i) the cladding above and below the joint is installed outboard of a drained and vented air space (see Clause 9.27.2.2.(1)(a)), and
    - ii) the horizontal detail is constructed so as to minimize the ingress of precipitation into the air space, or
  - c) at horizontal construction joints in stucco, where
    - i) the joint is finished with an expansion-contraction strip, and
    - ii) the cladding is installed outboard of a drained and vented air space (see Clause 9.27.2.2.(1)(a)).

**3)** Flashing shall be installed over exterior wall openings where the vertical distance from the bottom of the eave to the top of the trim is more than one-quarter of the horizontal overhang of the eave. (See Note A-9.27.3.8.(3).)

- 4)** Flashing described in Sentences (1) and (3) shall
  - a) extend not less than 50 mm upward inboard of the sheathing membrane or sheathing installed in lieu of the sheathing membrane (see Article 9.27.3.4.),
  - b) have a slope of not less than 6% toward the exterior after the expected shrinkage of the *building* frame,
  - c) terminate at each end with an end-dam
    - i) with a height in millimetres not less than 25 mm or 1/10 the value of the 1-in-5 driving rain wind pressure in Pa, and
    - ii) at the height defined in Subclause (c)(i), extending to the face of the adjacent cladding,
  - d) lap not less than 10 mm vertically over the *building* element below, and
  - e) terminate in a drip offset not less than 5 mm outward from the outer face of the *building* element below.

(See Note A-9.27.3.8.(4).)

**5)** Where the sills of windows and doors installed in exterior walls are not self-flashing, flashing shall be installed between the underside of the window or door and the wall construction below. (See Note A-9.27.3.8.(5).)

## 9.27.4. Sealants

### 9.27.4.1. Required Sealants

- 1)** Sealant shall be provided where required to prevent the entry of water into the structure.
- 2)** Sealant shall be provided between masonry, siding or stucco and the adjacent door and window frames or trim, including sills, unless such locations are completely protected from the entry of rain.
- 3)** Sealant shall be provided at vertical joints between different cladding materials unless the joint is suitably lapped or flashed to prevent the entry of rain. (See Articles 9.7.6.2., 9.20.13.12. and 9.28.1.5.)

### 9.27.4.2. Materials

- 1)** Sealants shall be
  - a) a non-hardening type suitable for exterior use,

- b) selected for their ability to resist the effects of weathering, and
  - c) compatible with and adhere to the substrate to which they are applied.
- (See Note A-9.27.4.2.(1).)

- 2)** Sealants shall conform to
  - a) ASTM C 834, "Latex Sealants,"
  - b) ASTM C 920, "Elastomeric Joint Sealants,"
  - c) ASTM C 1184, "Structural Silicone Sealants," or
  - d) ASTM C 1311, "Solvent Release Sealants."

**3)** Backer rod shall conform to ASTM C 1330, "Cylindrical Sealant Backing for Use with Cold Liquid-Applied Sealants." (See Note A-9.27.4.2.(1).)

## 9.27.5. Attachment of Cladding

### 9.27.5.1. Attachment

**1)** Except as permitted by Sentences (2) to (6), cladding shall be fastened to the framing members or furring members, or to blocking between the framing members.

**2)** Vertical lumber and stucco lath or reinforcing are permitted to be attached to sheathing only where the sheathing consists of not less than

- a) 14.3 mm lumber,
- b) 12.5 mm plywood, or
- c) 12.5 mm OSB or waferboard.

**3)** Vertically applied metal siding and wood shingles and shakes are permitted to be attached to the sheathing only where the sheathing consists of not less than

- a) 14.3 mm lumber,
- b) 7.5 mm plywood, or
- c) 7.5 mm OSB or waferboard.

**4)** Where wood shingles or shakes are applied to sheathing which is not suitable for attaching the shingles or shakes, the shingles or shakes are permitted to be attached to a wood lath not less than 38 mm by 9.5 mm thick securely nailed to the framing and applied as described in Article 9.27.7.5.

**5)** Where asbestos-cement shingles are applied to sheathing that is not suitable for attaching the shingles, the shingles are permitted to be fastened to a wood lath not less than 89 mm by 9.5 mm thick securely nailed to the framing.

**6)** Lath referred to in Sentence (5) shall be applied so that it overlaps the preceding shingle course by not less than 20 mm.

### 9.27.5.2. Blocking

**1)** Blocking for the attachment of cladding shall be not less than 38 mm by 38 mm lumber securely nailed to the framing and spaced not more than 600 mm o.c.

### 9.27.5.3. Furring

**1)** Except as permitted in Sentences 9.27.5.1.(4) and (5), furring for the attachment of cladding shall be not less than 19 mm by 38 mm lumber when applied over sheathing.

**2)** When applied without sheathing, furring referred to in Sentence (1) shall be not less than

- a) 19 mm by 64 mm lumber on supports spaced not more than 400 mm o.c., or
- b) 19 mm by 89 mm lumber on supports spaced not more than 600 mm o.c.

**3)** Furring referred to in Sentence (1) shall be

- a) securely fastened to the framing, and
- b) spaced not more than 600 mm o.c.

### 9.27.5.4. Size and Spacing of Fasteners

**1)** Nail or staple size and spacing for the attachment of cladding and trim shall conform to Table 9.27.5.4.



**Table 9.27.5.4.**  
**Attachment of Cladding**  
 Forming Part of Sentence 9.27.5.4.(1)

Type of Cladding	Minimum Nail or Staple Length, mm	Minimum Number of Nails or Staples	Maximum Nail or Staple Spacing, mm o.c.
Wood trim	51	—	600
Lumber siding or horizontal siding made from sheet material	51	—	600
Metal cladding	38	—	600 (nailed to framing) 400 (nailed to sheathing only)
Wood shakes			
up to 200 mm in width	51	2	—
over 200 mm in width	51	3	—
Wood shingles			
200 mm in width	32	2	—
over 200 mm in width	32	3	—
Panel or sheet type cladding			
up to 7 mm thick	38	—	150 (along edges)
more than 7 mm thick	51	—	300 (along intermediate supports)

**9.27.5.5. Fastener Materials**

**1)** Nails or staples for the attachment of cladding and wood trim shall be corrosion-resistant and shall be compatible with the cladding material.

**9.27.5.6. Expansion and Contraction**

**1)** Fasteners for metal or vinyl cladding shall be positioned to permit expansion and contraction of the cladding.

**9.27.5.7. Penetration of Fasteners**

**1)** Fasteners for shakes and shingles shall penetrate through the nail-holding base or not less than 19 mm into the framing.

**2)** Fasteners for cladding other than that described in Sentence (1) shall penetrate through the nail-holding base or not less than 25 mm into the framing.

**9.27.6. Lumber Siding**

**9.27.6.1. Materials**

**1)** Lumber siding shall be sound, free of knot holes, loose knots, through checks or splits.

**9.27.6.2. Thickness and Width**

**1)** Drop, rustic, novelty, lapped board and vertical wood siding shall be not less than 14.3 mm thick and not more than 286 mm wide.

**2)** Bevel siding shall be

a) not less than 5 mm thick at the top, and

b) not less than

i) 12 mm thick at the butt for siding 184 mm or less in width, and

ii) 14.3 mm thick at the butt for siding wider than 184 mm.

**3)** Bevel siding shall be not more than 286 mm wide.

**9.27.6.3. Joints**

- 1) Lumber siding shall prevent water from entering at the joints by the use of lapped or matched joints or by vertical wood battens.
- 2) Siding shall overlap not less than 1 mm per 16 mm width of lumber, but not less than
  - a) 9.5 mm for matched siding,
  - b) 25 mm for lapped bevel siding, or
  - c) 12 mm for vertical battens.

**9.27.7. Wood Shingles and Shakes****9.27.7.1. Materials**

- 1) Shingles and shakes shall conform to
  - a) CSA O118.1, "Western Red Cedar Shakes and Shingles," or
  - b) CSA O118.2, "Eastern White Cedar Shingles."
- 2) Western cedar shakes shall be not less than No. 1 or Handsplit grade, and western cedar shingles not less than No. 2 grade, except that No. 3 grade may be used for undercoursing.
- 3) Eastern white cedar shingles shall be at least B (clear) grade, except that C grade may be used for the lower course of double course applications.

**9.27.7.2. Width**

- 1) Shingles and shakes shall be not less than 65 mm or more than 350 mm wide.

**9.27.7.3. Fasteners**

- 1) Shingles or shakes shall be fastened with nails or staples located approximately 20 mm from each edge and not less than 25 mm above the exposure line for single-course applications, or approximately 50 mm above the butt for double-course applications.

**9.27.7.4. Offsetting of Joints**

- 1) In single-course application, joints in succeeding courses shall be offset not less than 40 mm so that joints in any 2 of 3 consecutive courses are staggered.
- 2) In double-course application, joints in the outer course shall be offset from joints in the under-course by not less than 40 mm, and joints in succeeding courses shall be offset not less than 40 mm.

**9.27.7.5. Fastening to Lath**

- 1) When lath is used with double-course application [see Sentence 9.27.5.1.(4)], it shall be spaced according to the exposure and securely fastened to the framing.
- 2) The butts of the under-course of the application referred to in Sentence (1) shall rest on the top edge of the lath.
- 3) The outer course of the application referred to in Sentence (1) shall be fastened to the lath with nails of sufficient length to penetrate through the lath.
- 4) The butts of the shingles or shakes shall be so located that they project not less than 12 mm below the bottom edge of the lath referred to in Sentence (1).
- 5) If wood lath is not used, the butts of the under-course shingles or shakes of the application referred to in Sentence (1) shall be located 12 mm above the butts of the outer course.

**9.27.7.6. Exposure and Thickness**

- 1) The exposure and butt thickness of shingles and shakes shall conform to Table 9.27.7.6.

**Table 9.27.7.6.**  
**Exposure and Thickness of Wood Shingles and Shakes**  
 Forming Part of Sentence 9.27.7.6.(1)

Shake or Shingle Length, mm	Maximum Exposure, mm		Minimum Butt Thickness, mm
	Single Coursing	Double Coursing	
400	190	305	10
450	216	356	11
600	292	406	13

**9.27.8. Plywood**

**9.27.8.1. Material Standards**

- 1) Plywood cladding shall be exterior type conforming to
  - a) ANSI/HPVA HP-1, "Hardwood and Decorative Plywood,"
  - b) CSA O121, "Douglas Fir Plywood,"
  - c) CSA O151, "Canadian Softwood Plywood," or
  - d) CSA O153, "Poplar Plywood."

**9.27.8.2. Thickness**

- 1) Plywood cladding shall be not less than 6 mm thick when applied directly to sheathing.
- 2) When applied directly to framing or over furring strips, plywood cladding thickness shall conform to Table 9.27.8.2.

**Table 9.27.8.2.**  
**Minimum Plywood Cladding Thickness**  
 Forming Part of Sentence 9.27.8.2.(2)

Spacing of Supports, mm	Minimum Thickness, mm	
	Face Grain Parallel to Supports	Face Grain Right Angles to Supports
400	8	6
600	11	8

- 3) The thickness of grooved or textured plywood cladding shall be measured at the point of least thickness.

**9.27.8.3. Edge Treatment**

- 1) The edges of plywood cladding shall be treated with a suitable paint or sealer.

**9.27.8.4. Panel Cladding**

- 1) Plywood applied in panels shall have all edges supported.
- 2) Not less than a 2 mm gap shall be provided between panels referred to in Sentence (1).
- 3) Vertical joints in cladding referred to in Sentence (1) shall be protected with batten strips or sealant when the plywood joints are not matched.
- 4) Horizontal joints in cladding referred to in Sentence (1) shall be lapped not less than 25 mm or shall be suitably flashed.

**9.27.8.5. Lapped Strip Siding**

- 1) Plywood applied in horizontal lapped strips shall have not less than a 2 mm gap provided at the butted ends, which shall be caulked.

**2)** The horizontal joints of siding described in Sentence (1) shall be lapped not less than 25 mm.

**3)** Wedges shall be inserted under all vertical butt joints and at all corners when horizontal lapped plywood is applied without sheathing.

## 9.27.9. Hardboard

### 9.27.9.1. Material Standards

**1)** Factory-finished hardboard cladding shall conform to CAN/CGSB-11.5-M, "Hardboard, Precoated, Factory Finished, for Exterior Cladding."

**2)** Hardboard cladding that is not factory finished shall conform to Types 1, 2 or 5 in CAN/CGSB-11.3-M, "Hardboard."

### 9.27.9.2. Thickness

**1)** Type 1 or 2 hardboard cladding shall be not less than

- a) 6 mm thick when applied over sheathing that provides continuous support, and
- b) 7.5 mm thick when applied over furring or framing members not more than 400 mm o.c.

**2)** Type 5 hardboard cladding shall be not less than 9 mm thick when applied over sheathing that provides continuous support or over furring or framing members spaced not more than 400 mm o.c.

**3)** Where hardboard cladding is grooved, the grooves shall not extend more than 1.5 mm into the minimum required thickness. (See Note A-9.27.9.2.(3).)

### 9.27.9.3. Panel Cladding

**1)** Hardboard cladding applied in panels shall have all edges supported with not less than a 5 mm gap provided between sheets.

**2)** Vertical joints in cladding described in Sentence (1) shall be protected with batten strips or sealant when the joints are not matched.

**3)** Horizontal joints in cladding described in Sentence (1) shall be lapped not less than 25 mm or shall be suitably flashed.

### 9.27.9.4. Lapped Strip Siding

**1)** Hardboard applied in horizontal lapped strips shall have not less than a 5 mm gap provided at the butted ends, which shall be sealed or otherwise protected with suitable mouldings.

**2)** The horizontal joints of siding described in Sentence (1) shall overlap not less than 1 mm per 16 mm width of siding board but not less than 9.5 mm for matched joint siding or 25 mm for lapped siding.

### 9.27.9.5. Clearance

**1)** Not less than 3 mm clearance shall be provided between hardboard cladding and door or window frames.

## 9.27.10. OSB and Waferboard

### 9.27.10.1. Material Standard

**1)** OSB and waferboard cladding shall conform to CSA O437.0, "OSB and Waferboard."

### 9.27.10.2. Thickness

**1)** OSB conforming to O-2 grade shall be not less than 6.0 mm thick where applied directly to sheathing.

**2)** OSB conforming to O-2 grade applied directly to framing or over furring strips shall conform to the thickness shown for plywood in Table 9.27.8.2. (See Note A-9.27.10.2.(2).)

**3)** OSB conforming to O-1 grade and waferboard conforming to R-1 grade shall be not less than 7.9 mm thick where applied directly to sheathing.

**4)** Where applied directly to framing or over furring strips, OSB conforming to O-1 grade and waferboard conforming to R-1 grade shall be not less than

- a) 9.5 mm thick on supports spaced not more than 400 mm o.c., and
- b) 12.7 mm thick on supports spaced not more than 600 mm o.c.

### **9.27.10.3. Panel Cladding**

**1)** OSB and waferboard applied in panels shall have all edges supported and treated with a primer or sealer.

**2)** Not less than a 3 mm gap shall be provided between sheets in cladding described in Sentence (1).

**3)** Vertical joints in cladding described in Sentence (1) shall be protected with batten strips or sealant when the OSB and waferboard joints are not matched.

**4)** Horizontal joints in cladding described in Sentence (1) shall be lapped not less than 25 mm or shall be suitably flashed.

### **9.27.10.4. Clearance**

**1)** Not less than a 3 mm clearance shall be provided between OSB and waferboard cladding and door or window frames.

## **9.27.11. Metal**

### **9.27.11.1. Material Standards**

**1)** Horizontal and vertical strip steel siding, including flashing and trim accessories, shall conform to CAN/CGSB-93.4, "Galvanized Steel and Aluminum-Zinc Alloy Coated Steel Siding, Soffits and Fascia, Prefinished, Residential."

**2)** Steel sheet cladding shall have a minimum thickness of 0.3 mm and conform to CAN/CGSB-93.3-M, "Prefinished Galvanized and Aluminum-Zinc Alloy Steel Sheet for Residential Use."

**3)** Horizontal and vertical strip aluminum siding, including flashing and trim accessories, shall conform to CAN/CGSB-93.2-M, "Prefinished Aluminum Siding, Soffits, and Fascia, for Residential Use." (See Note A-9.27.11.1.(3) and (4).)

**4)** Aluminum sheet cladding shall conform to CAN/CGSB-93.1-M, "Sheet, Aluminum Alloy, Prefinished, Residential," and shall have a thickness of not less than 0.58 mm, except that siding supported by backing or sheathing shall have a thickness of not less than 0.46 mm. (See Note A-9.27.11.1.(3) and (4).)

## **9.27.12. Vinyl Siding**

### **9.27.12.1. Material Standard**

**1)** Vinyl siding, including flashing and trim accessories, shall conform to CAN/CGSB-41.24, "Rigid Vinyl Siding, Soffits and Fascia."

### **9.27.12.2. Attachment**

**1)** The attachment of vinyl siding shall conform to the requirements in Subsection 9.27.5. for metal siding.

**9.27.13. Exterior Insulation Finish Systems****9.27.13.1. Application**

**1)** Except as provided in Sentence (2), this Subsection applies to exterior insulation finish systems (EIFS) that

- a) are covered in the scope of CAN/ULC-S716.1, "Exterior Insulation and Finish Systems (EIFS) - Materials and Systems," and
- b) have a geometrically defined drainage cavity with a minimum cavity depth of 10 mm and an open area equal to not less than 13% of the area of a full-size EIFS panel.

(See Note A-9.27.13.1.(1).)

**2)** EIFS that are not covered by Sentence (1) shall comply with Part 5.

**9.27.13.2. Materials**

**1)** The materials used in EIFS shall conform to CAN/ULC-S716.1, "Exterior Insulation and Finish Systems (EIFS) - Materials and Systems."

**2)** The substrate on which the EIFS is installed shall

- a) be compatible with that particular system (see Note A-9.27.13.2.(2)(a)), and
- b) comply with the structural requirements for sheathing materials stated in Section 9.23.

**9.27.13.3. Design and Installation**

**1)** The design and installation of EIFS on the substrate described in Sentence 9.27.13.2.(2) shall comply with

- a) CAN/ULC-S716.2, "Exterior Insulation and Finish Systems (EIFS) - Installation of EIFS Components and Water Resistive Barrier," and
- b) CAN/ULC-S716.3, "Exterior Insulation and Finish System (EIFS) - Design Application."

**Section 9.28. Stucco****9.28.1. General****9.28.1.1. Sheathing beneath Stucco**

**1)** Sheathing shall be provided beneath stucco applied over wood-frame walls except as permitted in Article 9.28.4.2.

**2)** Where applied beneath stucco, sheathing shall conform to Subsection 9.23.17.

**9.28.1.2. Lath and Reinforcing**

**1)** Stucco lath or reinforcing shall be used to attach stucco to any substrate other than masonry.

**2)** Stucco lath or reinforcing shall be used to attach stucco to masonry where

- a) the masonry is soft-burned tile or brick of less strength than the stucco, or
- b) the masonry surface is not sound, clean and sufficiently rough to provide a good key.

**3)** Stucco applied over masonry *chimneys* shall be reinforced.

**9.28.1.3. Concrete Masonry Units**

**1)** Stucco finish shall not be applied over concrete masonry units less than one month old unless the units have been cured by the autoclave process.

**9.28.1.4. Clearance over Ground Level**

**1)** Stucco shall be not less than 200 mm above finished ground level except when it is applied over concrete or masonry.

**9.28.1.5. Flashing and Caulking**

1) Flashing and caulking used with stucco shall conform to Subsections 9.27.3. and 9.27.4., except that if aluminum flashing is used, it shall be separated from the stucco by an impervious membrane or coating. (See Article 9.7.6.2. for caulking around window frames.)

**9.28.2. Stucco Materials**

**9.28.2.1. Portland Cement**

1) Portland cement shall conform to CSA A3001, "Cementitious Materials for Use in Concrete."

**9.28.2.2. Aggregate**

1) Aggregate shall be clean, well-graded natural sand or sand manufactured from crushed stone, gravel or air-cooled blast furnace slag and shall contain no significant amounts of deleterious material.

2) Aggregate grading shall conform to Table 9.28.2.2.

**Table 9.28.2.2.**  
**Aggregate Grading for Stucco**  
Forming Part of Sentence 9.28.2.2.(2)

Sieve Sizes, mm	% Aggregate Passing Sieve	
	Maximum	Minimum
4	—	100
2	—	90
1	90	60
0.5	60	45
0.25	30	10
0.125	5	—

**9.28.2.3. Water**

1) Water shall be clean and free of significant amounts of deleterious material.

**9.28.3. Fasteners**

**9.28.3.1. Materials**

1) Fasteners for stucco lath or reinforcing shall be corrosion-resistant and of a material other than aluminum.

**9.28.3.2. Nails and Staples**

1) Nails for stucco lath or reinforcing shall be not less than 3.2 mm diam with a head diameter of not less than 11.1 mm.

2) Staples for stucco lath or reinforcing shall be not less than 1.98 mm diam or thickness.

3) Staples and nails for attaching stucco lath or reinforcing to vertical surfaces shall be of sufficient length to penetrate 25 mm into framing members or to the full depth of the sheathing where the sheathing is used for attachment.

4) On horizontal surfaces nails for stucco lath or reinforcing shall be not less than 38 mm long.

**9.28.4. Stucco Lath****9.28.4.1. Materials**

- 1) Rib lath or expanded metal stucco mesh shall be
  - a) copper-alloy steel coated with rust-inhibitive paint after fabrication, or
  - b) galvanized.
- 2) Woven or welded wire mesh shall be galvanized.

**9.28.4.2. No Sheathing Required**

1) Sheathing need not be provided beneath stucco where not less than 1.19 mm diam galvanized wire is applied horizontally to the framing at vertical intervals of not more than 150 mm, or where paper-backed welded wire metal lath is used.

**9.28.4.3. Stucco Lath Specifications**

- 1) Stucco lath shall conform to Table 9.28.4.3.

**Table 9.28.4.3.**  
**Stucco Lath**  
Forming Part of Sentence 9.28.4.3.(1)

Location	Type of Lath	Minimum Diam of Wire, mm	Maximum Mesh Opening	Minimum Mass, kg/m <sup>2</sup>
Vertical surfaces	Welded or woven wire	1.15	25 mm	—
		1.30	38 mm	—
		1.50	51 mm	—
	Stucco mesh reinforcing (expanded metal)	—	25.8 cm <sup>2</sup>	0.98
Horizontal surfaces <sup>(1)</sup>	9.5 mm rib lath	—	—	1.84
	Cedar lath	—	—	—

**Notes to Table 9.28.4.3.:**

(1) See Note A-Table 9.28.4.3.

**9.28.4.4. Self-Furring Devices**

1) Stucco lath shall be held not less than 6 mm away from the backing by means of suitable self-furring devices.

**9.28.4.5. Application of Stucco Lath**

- 1) Stucco lath shall be applied with the long dimension horizontal.
- 2) Horizontal and vertical joints in stucco lath shall be lapped not less than 50 mm.
- 3) End joints of stucco lath shall be staggered and shall occur over framing members.
- 4) External corners of stucco lath shall be reinforced with a vertical strip of lath or reinforcing extending not less than 150 mm on both sides of the corner, or the lath or reinforcing shall extend around corners not less than 150 mm.

**9.28.4.6. Fastening**

- 1) Stucco lath shall be fastened in conformance with Subsection 9.27.5.
- 2) Fasteners on vertical surfaces shall be spaced not more than
  - a) 150 mm o.c. vertically and 400 mm o.c. horizontally, or
  - b) 100 mm o.c. vertically and 600 mm o.c. horizontally.
- 3) Nailing patterns other than those required in Sentence (2) are permitted to be used provided there are at least 20 fasteners per square metre of wall surface.



- 4) Fasteners on horizontal surfaces shall be spaced not more than
  - a) 150 mm o.c. along the framing members when members are spaced not more than 400 mm o.c., and
  - b) 100 mm o.c. along members when members are spaced not more than 600 mm o.c.

**9.28.5. Stucco Mixes**

**9.28.5.1. Mixes**

- 1) Stucco mixes shall conform to Table 9.28.5.1.

**Table 9.28.5.1.  
Stucco Mixes**  
Forming Part of Sentence 9.28.5.1.(1)

Materials, volume			
Portland Cement	Masonry Cement	Lime	Aggregate
1	—	0.25 to 1	3.25 to 4 parts per part of cementitious material
1	1	—	

**9.28.5.2. Pigments**

- 1) Pigment if used shall consist of pure mineral oxides inert to the action of sun, lime and cement.
- 2) Pigment shall not exceed 6% of the Portland cement by weight.

**9.28.5.3. Mixing**

- 1) Materials shall be thoroughly mixed before and after water is added.
- 2) Stucco shall be applied not later than 3 h after the initial mixing.

**9.28.6. Stucco Application**

**9.28.6.1. Low Temperature Conditions**

- 1) The base for stucco shall be maintained above freezing.
- 2) Stucco shall be maintained at a temperature of not less than 10°C during application, and for not less than 48 h afterwards.

**9.28.6.2. Number of Coats and Total Thickness**

- 1) Stucco shall be applied with at least 2 base coats and one finish coat, providing a total thickness of not less than 15 mm, measured from the face of the lath or the face of the masonry where no lath is used.

**9.28.6.3. First Coat**

- 1) The first coat shall be not less than 6 mm thick, measured from the face of the lath or masonry, fully embedding the lath.
- 2) The surface of the first coat shall be scored to provide a key with the second coat.

**9.28.6.4. Second Coat**

- 1) The second coat shall be not less than 6 mm thick.
- 2) The surface of the second coat shall be lightly roughened to provide a key with the finish coat if the finish coat is other than stone dash.

**9.28.6.5. Finish Coat**

- 1) When the finish coat is other than stone dash, the base shall be dampened but not saturated before the finish coat is applied.
- 2) The thickness of the finish coat shall be not less than 3 mm.
- 3) When a stone dash finish is used, the stone shall be partially embedded in the second coat before the second coat starts to set or stiffen.

**Section 9.29. Interior Wall and Ceiling Finishes****9.29.1. General****9.29.1.1. Fire Protection and Sound Control**

- 1) A wall or ceiling finish shall also conform to the appropriate requirements in Sections 9.10. and 9.11., in addition to the requirements in this Section.

**9.29.2. Waterproof Wall Finish****9.29.2.1. Where Required**

- 1) Waterproof finish shall be provided to a height of not less than
  - a) 1.8 m above the floor in shower stalls,
  - b) 1.2 m above the rims of bathtubs equipped with showers, and
  - c) 400 mm above the rims of bathtubs not equipped with showers.

**9.29.2.2. Materials**

- 1) Waterproof finish shall consist of ceramic, plastic or metal tile, sheet vinyl, tempered hardboard, laminated thermosetting decorative sheets or linoleum.

**9.29.3. Wood Furring****9.29.3.1. Size and Spacing of Furring**

- 1) Wood furring for the attachment of wall and ceiling finishes shall conform to Table 9.29.3.1.

**Table 9.29.3.1.**  
**Size and Spacing of Furring**  
 Forming Part of Sentence 9.29.3.1.(1)

Maximum Spacing of Furring, mm	Minimum Size of Furring, mm		
	Maximum Spacing of Furring Supports		
	Continuous Supports	400 mm o.c.	600 mm o.c.
300	19 x 38	19 x 38	19 x 64
400	19 x 38	19 x 38	19 x 64
600	19 x 38	19 x 64	19 x 89

**9.29.3.2. Fastening**

- 1) Furring shall be fastened to the framing or to wood blocks with not less than 51 mm nails.

**9.29.4. Plastering**

**9.29.4.1. Application**

1) Application of plaster wall and ceiling finishes, including installation of metal or gypsum lath, shall conform to CSA A82.30-M, "Interior Furring, Lathing and Gypsum Plastering."

**9.29.5. Gypsum Board Finish (Taped Joints)**

**9.29.5.1. Application**

1) The requirements for application of gypsum board in this Subsection apply to the single layer application of gypsum board to wood furring or framing using nails or screws.

2) Gypsum board applications not described in this Subsection shall conform to CSA A82.31-M, "Gypsum Board Application."

**9.29.5.2. Materials**

- 1) Gypsum products shall conform to
  - a) ASTM C 1178/C 1178M, "Coated Glass Mat Water-Resistant Gypsum Backing Panel," or
  - b) ASTM C 1396/C 1396M, "Gypsum Board," except that the *flame-spread rating* of gypsum board shall be determined in accordance with CAN/ULC-S102, "Test for Surface Burning Characteristics of Building Materials and Assemblies."

**9.29.5.3. Maximum Spacing of Supports**

1) Maximum spacing of supports for gypsum board applied as a single layer shall conform to Table 9.29.5.3.

**Table 9.29.5.3.**  
**Spacing of Supports for Gypsum Board**  
 Forming Part of Sentence 9.29.5.3.(1)

Thickness, mm	Orientation of Board to Framing	Maximum Spacing of Supports, mm o.c.		
		Walls	Ceilings	
			Painted Finish	Water-Based Texture Finish
Gypsum board conforming to Sentence 9.29.5.2.(1) (except Sections 9 and 12 of ASTM C 1396/C 1396M)				
9.5	parallel	—	—	—
	perpendicular	400	400	—
12.7	parallel	600	400	—
	perpendicular	600	600	400
15.9	parallel	600	400	—
	perpendicular	600	600	600
Gypsum ceiling board conforming to Clause 9.29.5.2.(1)(b) (only Section 12 of ASTM C 1396/C 1396M)				
12.7	parallel	600	400	—
	perpendicular	600	600	600

**9.29.5.4. Support of Insulation**

1) Gypsum board supporting insulation shall be not less than 12.7 mm thick.

**9.29.5.5. Length of Fasteners**

**1)** The length of fasteners for gypsum board shall conform to Table 9.29.5.5., except that lesser depths of penetration are permitted for assemblies required to have a *fire-resistance rating* provided it can be shown, on the basis of fire tests, that such depths are adequate for the required rating.

**Table 9.29.5.5.**  
**Fastener Penetration into Wood Supports**  
Forming Part of Sentence 9.29.5.5.(1)

Required <i>Fire-Resistance Rating</i> of Assembly	Minimum Penetration, mm			
	Walls		Ceilings	
	Nails	Screws	Nails	Screws
Not required	20	15	20	15
45 min	20	20	30	30
1 h	20	20	45	45
1.5 h	20	20	60	60

**9.29.5.6. Nails**

- 1)** Nails for fastening gypsum board to wood supports shall conform to
- ASTM F 1667, "Driven Fasteners: Nails, Spikes, and Staples," or
  - CSA B111, "Wire Nails, Spikes and Staples."

**9.29.5.7. Screws**

**1)** Screws for fastening gypsum board to wood supports shall conform to ASTM C 1002, "Steel Self-Piercing Tapping Screws for the Application of Gypsum Panel Products or Metal Plaster Bases to Wood Studs or Steel Studs."

**9.29.5.8. Spacing of Nails**

- 1)** For single-layer application on a ceiling, nails shall be spaced
- not more than 180 mm o.c. on ceiling supports, or
  - every 300 mm o.c. along ceiling supports, in pairs about 50 mm apart.
- 2)** Where the ceiling sheets are supported by the wall sheets around the perimeter of the ceiling, this support may be considered as equivalent to nailing at this location.
- 3)** Except as required by Sentence (4), for single-layer application on walls, nails shall be spaced
- not more than 200 mm o.c. on vertical wall supports, or
  - every 300 mm o.c. along vertical wall supports, in pairs about 50 mm apart.
- 4)** For single-layer application on walls, where gypsum board provides required bracing in *braced wall panels*, lateral support for studs, or fire protection, nails shall be spaced not more than 200 mm o.c. on
- vertical wall supports, and
  - top and bottom plates.
- (See Article 9.23.10.2. and Section 9.10.)
- 5)** The uppermost nails on vertical wall supports shall be not more than 200 mm below the ceiling.
- 6)** Nails shall be located not less than 10 mm from the side or edge of the board.
- 7)** Nails shall be driven so that the heads do not puncture the paper.

**9.29.5.9. Spacing of Screws**

**1)** For single-layer application on a ceiling, screws shall be spaced not more than 300 mm o.c. on ceiling supports.

- 2)** Where the ceiling sheets are supported by the wall sheets around the perimeter of the ceiling, this support may be considered as equivalent to screwing at this location.
- 3)** Except as required by Sentence (4), for single-layer application on walls, screws shall be spaced
  - a) not more than 300 mm o.c. on vertical wall supports where the supports are more than 400 mm o.c., or
  - b) not more than 400 mm o.c. on vertical wall supports where the supports are not more than 400 mm o.c.
- 4)** Except as provided in Sentence (5), for single-layer application on walls, where gypsum board provides required bracing in *braced wall panels*, lateral support for studs, or fire protection, screws shall be spaced not more than 300 mm o.c. on
  - a) vertical wall supports, and
  - b) top and bottom plates.
 (See Article 9.23.10.2. and Section 9.10.)
- 5)** Where a *fire-resistance rating* is determined based on Table 9.10.3.1.-A, Sentence (4) need not apply for the purpose of fire protection.
- 6)** Screws shall be located not less than 10 mm from the edge of the board.
- 7)** Screws shall be driven so that the heads do not puncture the paper.

**9.29.5.10. Low Temperature Conditions**

- 1)** In cold weather, heat shall be provided to maintain a temperature not below 10°C for 48 h prior to taping and finishing and maintained for not less than 48 h thereafter.

**9.29.6. Plywood Finish**

**9.29.6.1. Thickness**

- 1)** Except as provided in Sentences (2) and (3), the minimum thickness of plywood interior finish shall conform to Table 9.29.6.1.

**Table 9.29.6.1.**  
**Thickness of Plywood Interior Finish**  
 Forming Part of Articles 9.29.6.1. and 9.29.6.2.

Maximum Spacing of Supports, mm o.c.	Minimum Thickness, mm <sup>(1)</sup>	
	On Supports with no Horizontal Blocking	On Supports with Blocking at Vertical Intervals not Exceeding 1.2 m
400	4.7	4.0
600	8.0	4.7

**Notes to Table 9.29.6.1.:**

<sup>(1)</sup> Thickness limits shall apply to the net effective thickness (NET) of grooved, striated, textured and/or embossed panels and to the actual thickness of flat panels.

- 2)** A manufacturing tolerance of -0.4 mm may be applied to the thicknesses listed in Table 9.29.6.1.
- 3)** No minimum thickness is required where plywood is applied over continuous backing.

**9.29.6.2. Grooved Plywood**

- 1)** Except as permitted in Sentence (2), where plywood for interior finish is grooved, the grooves shall not extend through the face ply and into the plies below the face ply unless the groove is supported by framing or furring.
- 2)** If the grain of the face ply is at right angles to the supporting members, the groove is permitted to extend into plies below the face ply provided the thickness of

the plywood exceeds the value shown in Table 9.29.6.1. by an amount equal to not less than the depth of penetration of the grooves into the plies below the face ply.

### 9.29.6.3. Nails and Staples

1) Except as provided in Sentence (2), nails for attaching plywood finishes shall not be less than 38 mm casing or finishing nails spaced not more than 150 mm o.c. along edge supports and 300 mm o.c. along intermediate supports, except that staples providing equivalent lateral resistance may also be used.

2) Where plywood finish provides required bracing in *braced wall panels*, the plywood shall be fastened in accordance with the fastening requirements for sheathing stated in Sentence 9.23.3.5.(2).

### 9.29.6.4. Edge Support

1) All plywood edges shall be supported by furring, blocking or framing.

## 9.29.7. Hardboard Finish

### 9.29.7.1. Material Standard

1) Hardboard shall conform to CAN/CGSB-11.3-M, "Hardboard."

### 9.29.7.2. Thickness

- 1) Hardboard shall be not less than
  - a) 3 mm thick where applied over continuous backing,
  - b) 6 mm thick when applied over supports spaced not more than 400 mm o.c., and
  - c) 9 mm thick when applied over supports spaced not more than 600 mm o.c.

### 9.29.7.3. Nails

1) Nails for fastening hardboard shall be casing or finishing nails not less than 38 mm long, spaced not more than 150 mm o.c. along edge supports and 300 mm o.c. along intermediate supports.

### 9.29.7.4. Edge Support

1) All hardboard edges shall be supported by furring, blocking or framing where the backing is not continuous.

## 9.29.8. Insulating Fibreboard Finish

### 9.29.8.1. Material Standard

1) Insulating fibreboard shall conform to CAN/ULC-S706, "Wood Fibre Insulating Boards for Buildings."

### 9.29.8.2. Thickness

- 1) Insulating fibreboard sheets shall be not less than 11.1 mm thick on supports not more than 400 mm o.c.
- 2) Insulating fibreboard tile shall be not less than 12.7 mm thick on supports spaced not more than 400 mm o.c.

### 9.29.8.3. Nails

1) Nails for fastening fibreboard sheets shall be not less than 2.6 mm shank diameter casing or finishing nails of sufficient length to penetrate not less than 20 mm into the supports.

2) Nails shall be spaced not more than 100 mm o.c. along edge supports and 200 mm o.c. along intermediate supports.

**9.29.8.4. Edge Support**

- 1) All fibreboard edges shall be supported by blocking, furring or framing.

**9.29.9. Particleboard, OSB or Waferboard Finish**

**9.29.9.1. Material Standard**

- 1) Particleboard finish shall conform to ANSI A208.1, "Particleboard."
- 2) OSB or waferboard finish shall conform to
  - a) CSA O325, "Construction Sheathing," or
  - b) CSA O437.0, "OSB and Waferboard."

**9.29.9.2. Minimum Thickness**

- 1) Except as provided in Sentences (2) and (3), the minimum thickness of O-2 grade OSB used as an interior finish shall conform to that shown for plywood in Table 9.29.6.1.
- 2) Thicknesses listed in Table 9.29.6.1. shall permit a manufacturing tolerance of -0.4 mm.
- 3) No minimum thickness is required where O-2 grade OSB is applied over continuous backing.
- 4) OSB conforming to O-1 grade, waferboard conforming to R-1 grade and particleboard shall be
  - a) not less than 6.35 mm thick on supports not more than 400 mm o.c.,
  - b) not less than 9.5 mm thick on supports not more than 600 mm o.c., and
  - c) not less than 6.35 mm thick on supports not more than 600 mm o.c. in walls where blocking is provided at midwall height.
- 5) OSB conforming to CSA O325, "Construction Sheathing," shall meet the minimum panel mark of
  - a) W16, on supports not more than 400 mm o.c.,
  - b) W24, on supports not more than 600 mm o.c., and
  - c) W16, on supports not more than 600 mm o.c. where blocking is provided at mid-wall height.

**9.29.9.3. Nails**

- 1) Except as provided in Sentence (2), nails for fastening particleboard, OSB or waferboard shall be not less than 38 mm casing or finishing nails spaced not more than 150 mm o.c. along edge supports and 300 mm o.c. along intermediate supports.
- 2) Where OSB or waferboard provides required bracing in *braced wall panels*, the OSB or waferboard shall be fastened in accordance with the fastening requirements for sheathing stated in Sentence 9.23.3.5.(2).

**9.29.9.4. Edge Support**

- 1) All particleboard, OSB or waferboard edges shall be supported by furring, blocking or framing.

**9.29.10. Wall Tile Finish**

**9.29.10.1. Tile Application**

- 1) Ceramic tile shall be set in a mortar base or applied with an adhesive.
- 2) Plastic tile shall be applied with an adhesive.

**9.29.10.2. Mortar Base**

- 1) When ceramic tile is applied to a mortar base the cementitious material shall consist of one part Portland cement to not more than one-quarter part lime by volume.

2) The cementitious material described in Sentence (1) shall be mixed with not less than 3 nor more than 5 parts of aggregate per part of cementitious material by volume.

3) Mortar shall be applied over metal lath or masonry.

4) Ceramic tile applied to a mortar base shall be thoroughly soaked and pressed into place forcing the mortar into the joints while the tile is wet.

#### 9.29.10.3. Adhesives

1) Adhesives to attach ceramic and plastic tile shall be applied to the finish coat or brown coat of plaster that has been steel-trowelled to an even surface or to gypsum board or to masonry provided the masonry has an even surface.

#### 9.29.10.4. Moisture-Resistant Backing

1) Ceramic and plastic tile installed on walls around bathtubs or showers shall be applied over moisture-resistant backing.

#### 9.29.10.5. Joints between Tiles and Bathtub

1) The joints between wall tiles and a bathtub shall be suitably caulked with material conforming to CAN/CGSB-19.22-M, "Mildew-Resistant Sealing Compound for Tubs and Tiles."

## Section 9.30. Flooring

### 9.30.1. General

#### 9.30.1.1. Required Finished Flooring

1) Finished flooring shall be provided in all *residential occupancies*.

#### 9.30.1.2. Water Resistance

1) Where water permeable finished flooring in bathrooms, kitchens, public entrance halls and laundry areas is supported by a subfloor of a type that would be damaged by water, such flooring shall be installed over a membrane with a water permeance not exceeding  $18 \text{ ng}/(\text{Pa}\cdot\text{s}\cdot\text{m}^2)$  when tested in accordance with ASTM E 96/E 96M, "Water Vapor Transmission of Materials." (See Note A-9.30.1.2.(1).)

#### 9.30.1.3. Sleepers

1) Wood sleepers supporting finished flooring over a concrete base supported on the ground shall be not less than 19 mm by 38 mm and shall be treated with a wood preservative.

#### 9.30.1.4. Finish Quality

1) Finished flooring shall have a surface that is smooth, even and free from roughness or open defects.

### 9.30.2. Panel-Type Underlay

#### 9.30.2.1. Required Underlay

1) A panel-type underlay shall be provided under resilient flooring, parquet flooring, ceramic tile, felted-synthetic-fibre floor coverings or carpeting laid over lumber subflooring. (See Sentence 9.30.3.2.(1).)

2) Panel-type underlay shall be provided under resilient flooring, parquet flooring, felted-synthetic-fibre floor coverings or carpeting on panel-type subflooring whose edges are unsupported. (See Article 9.23.15.3.)

3) Panel-type underlay shall be provided under ceramic tile applied with adhesive.



**9.30.2.2. Materials and Thickness**

- 1)** Panel-type underlay shall be not less than 6 mm thick and shall conform to
  - a) ANSI A208.1, "Particleboard,"
  - b) CAN/CGSB-11.3-M, "Hardboard,"
  - c) ANSI/HPVA HP-1, "Hardwood and Decorative Plywood,"
  - d) CSA O121, "Douglas Fir Plywood,"
  - e) CSA O151, "Canadian Softwood Plywood,"
  - f) CSA O153, "Poplar Plywood," or
  - g) CSA O437.0, "OSB and Waferboard."
- 2)** Panel-type underlay under ceramic tile applied with adhesive shall be not less than
  - a) 6 mm thick where the supports are spaced up to 300 mm o.c., and
  - b) 11 mm thick where the supports are spaced wider than 300 mm o.c.

**9.30.2.3. Fastening**

- 1)** Panel-type underlay shall be fastened to the subfloor with staples, annular grooved flooring nails or spiral nails, spaced not more than 150 mm o.c. along the edges and 200 mm o.c. both ways at other locations.
- 2)** Nails for panel-type underlay shall be not less than 19 mm long for 6 mm thick underlay and 22 mm long for 7.9 mm thick underlay.
- 3)** Staples for panel-type underlay shall
  - a) have not less than a 1.2 mm shank diameter or thickness with a 4.7 mm crown, and
  - b) be not less than
    - i) 22 mm long for 6 mm underlay, and
    - ii) 28 mm long for 7.9 mm and 9.5 mm underlay.

**9.30.2.4. Joints Offset**

- 1)** Where panel-type underlay is required to be installed over plywood, OSB or waferboard, the joints in the underlay shall be offset not less than 200 mm from the joints in the underlying subfloor.

**9.30.2.5. Surface Defects**

- 1)** Underlay beneath resilient or ceramic floors applied with an adhesive shall have all holes or open defects on the surface patched so that the defects will not be transmitted to the finished surface.

**9.30.3. Wood Strip Flooring**

**9.30.3.1. Thickness**

- 1)** The thickness of wood strip flooring shall conform to Table 9.30.3.1.

**Table 9.30.3.1.**  
**Thickness of Wood Strip Flooring**  
 Forming Part of Sentence 9.30.3.1.(1)

Type of Flooring	Max. Joist Spacing, mm	Minimum Thickness of Flooring, mm	
		With Subfloor	No Subfloor
Matched hardwood (interior use only)	400	7.9	19.0
	600	7.9	33.3
Matched softwood (interior or exterior use)	400	19.0	19.0
	600	19.0	31.7
Square edge softwood (exterior use only)	400	—	25.4
	600	—	38.1

**9.30.3.2. Strip Direction and End Joints**

- 1) Wood strip flooring shall not be laid parallel to lumber subflooring unless a separate underlay is provided.
- 2) If wood strip flooring is applied without a subfloor, it shall be laid at right angles to the joists so that the end joints are staggered and occur over supports or are end matched.
- 3) If the flooring is end matched, it shall be laid so that no 2 adjoining strips break joints in the same space between supports and each strip bears on no fewer than 2 supports.

**9.30.3.3. Nailing**

- 1) When nails are used, wood strip flooring shall be toe nailed or face nailed with not less than one nail per strip at the spacings shown in Table 9.30.3.3., except that face nailed strips more than 25 mm in width shall have at least 2 nails per strip.

**Table 9.30.3.3.**  
**Nailing of Wood Strip Flooring**  
Forming Part of Sentence 9.30.3.3.(1)

Finish Floor Thickness, mm	Minimum Length of Flooring Nails, mm	Maximum Spacing of Flooring Nails, mm
7.9	38 <sup>(1)</sup>	200
11.1	51	300
19.0	57	400
25.4	63	400
31.7	70	600
38.1	83	600

**Notes to Table 9.30.3.3.:**

(1) See Article 9.30.3.4.

- 2) Face nails shall be countersunk.

**9.30.3.4. Staples**

- 1) Staples are permitted to be used to fasten wood strip flooring not more than 7.9 mm in thickness provided the staples are not less than 29 mm long with a shank diameter of 1.19 mm and with 4.7 mm crowns.

**9.30.4. Parquet Flooring****9.30.4.1. Adhesive**

- 1) Adhesive used to attach parquet block flooring shall be suitable for bonding wood to the applicable subfloor material.

**9.30.5. Resilient Flooring****9.30.5.1. Materials**

- 1) Resilient flooring used on concrete slabs supported on ground shall consist of asphalt, rubber, vinyl-asbestos, unbacked vinyl or vinyl with an inorganic type backing.
- 2) Flooring described in Sentence (1) shall be attached to the base with a suitable waterproof and alkali-resistant adhesive.

**9.30.6. Ceramic Tile****9.30.6.1. Substrate**

- 1) Ceramic tile shall be set in a mortar bed or applied to a sound smooth base with a suitable adhesive.
- 2) Panel-type subfloor to which ceramic tile is to be applied with adhesive shall have its edges supported according to Article 9.23.15.3.

**Section 9.31. Plumbing Facilities****9.31.1. Scope****9.31.1.1. Application**

- 1) This Section applies to the plumbing facilities and *plumbing systems* within *dwelling units*.
- 2) In *occupancies* other than *dwelling units*, plumbing facilities, grab bars, floor drains, and floor and wall finishes around urinals shall conform to Subsection 3.7.2. (See also Section 3.8. regarding *barrier-free* plumbing facilities.)
- 3) Medical gas piping systems shall conform to Subsection 3.7.3.
- 4) Systems used for service water heating shall conform to the energy efficiency requirements in Section 9.36.

**9.31.2. General****9.31.2.1. General**

- 1) The construction, extension, *alteration*, renewal or repair of *plumbing systems* and sewage disposal systems shall conform to Part 7.

**9.31.2.2. Corrosion Protection**

- 1) Metal pipes in contact with cinders or other corrosive material shall be protected by a heavy coating of bitumen or other corrosion protection.

**9.31.2.3. Grab Bars**

- 1) When provided, grab bars shall be capable of resisting a load of not less than 1.3 kN applied vertically or horizontally.

**9.31.3. Water Supply and Distribution****9.31.3.1. Required Water Supply**

- 1) Every *dwelling unit* shall be supplied with potable water.

**9.31.3.2. Required Connections**

- 1) Where a piped water supply is available, piping for hot and cold water shall be connected to every kitchen sink, lavatory, bathtub, shower, slop sink and laundry area.
- 2) Piping for cold water shall be run to every water closet.

**9.31.4. Required Facilities****9.31.4.1. Required Fixtures**

- 1) A kitchen sink, lavatory, bathtub or shower, and water closet shall be provided for every *dwelling unit* where a piped water supply is available.

**9.31.4.2. Hot Water Supply**

1) Where a piped water supply is available a hot water supply shall be provided in every *dwelling unit*.

**9.31.4.3. Floor Drains**

1) Where gravity drainage to a sewer, drainage ditch or dry well is possible, a floor drain shall be installed in a *basement* forming part of a *dwelling unit*.

2) A floor drain shall be provided in a garbage room, incinerator room or *boiler* room serving more than one *dwelling unit*.

**9.31.5. Sewage Disposal****9.31.5.1. Building Sewer**

1) Wastes from every plumbing fixture shall be piped to the *building* sewer.

**9.31.5.2. Discharge of Sewage**

1) *Building* sewers shall discharge into a public sewage system where such system is available.

2) Where a public sewage system is not available, the *building* sewer shall discharge into a *private sewage disposal system*.

**9.31.6. Service Water Heating Facilities****9.31.6.1. Hot Water Supply**

1) Where hot water is required to be supplied in accordance with Article 9.31.4.2., equipment shall

- a) provide an adequate supply of hot water, and
- b) be installed in conformance with Part 7.

**9.31.6.2. Equipment and Installation**

1) *Service water heaters* shall conform to appropriate provincial or territorial requirements or, in the absence of such requirements, to the NPC.

2) The installation of *service water heaters*, including provisions for mounting, clearances and air supply, shall conform to appropriate provincial or territorial requirements or, in the absence of such requirements, to

- a) CSA B51, "Boiler, Pressure Vessel, and Pressure Piping Code,"
- b) CSA B139, "Installation Code for Oil-Burning Equipment,"
- c) CSA B149.1, "Natural Gas and Propane Installation Code,"
- d) CSA B365, "Installation Code for Solid-Fuel-Burning Appliances and Equipment," or
- e) CSA C22.1, "Canadian Electrical Code, Part I."

3) Where the *building* is in a location where the spectral response acceleration,  $S_a(0.2)$ , is greater than 0.55, *service water heaters* shall be secured to the structure to prevent overturning. (See Note A-9.31.6.2.(3).)

**9.31.6.3. Corrosion-Resistant Coating**

1) Where storage tanks for *service water heaters* are of steel, they shall be coated with zinc, vitreous enamel (glass lined), hydraulic cement or other corrosion-resistant material.

**9.31.6.4. Fuel-Burning Heaters**

1) Fuel-burning *service water heaters* shall be connected to a *chimney flue* conforming to Section 9.21.

**9.31.6.5. Heating Coils**

1) Heating coils of *service water heaters* shall not be installed in a *flue* or in the combustion chamber of a *boiler* or *furnace* heating a *building*.

**Section 9.32. Ventilation****9.32.1. General****9.32.1.1. Application**

1) This Section applies to the ventilation of rooms and spaces in *residential occupancies*.

2) Ventilation of all other *occupancies* shall comply with Part 6.

3) A *storage garage* for up to 4 motor vehicles that serves a *residential occupancy* may be considered to be part of that *occupancy*.

4) Systems used for ventilation shall conform to the energy efficiency requirements in Section 9.36.

**9.32.1.2. Required Ventilation**

- 1) Every *residential occupancy* shall incorporate
- provisions for non-heating-season ventilation in accordance with Subsection 9.32.2., and
  - except as required by Sentences (2) and (3), if supplied with electrical power and a heating system, provisions for heating-season ventilation in accordance with Part 6.

2) A self-contained heating-season ventilation system serving a single *dwelling unit* shall comply with Subsection 9.32.3. (See Note A-9.32.1.2.(2).)

3) In houses that contain a *secondary suite*, heating-season ventilation need not be provided for

- exits*,
- public corridors*, and
- ancillary spaces that are not within a *dwelling unit*, except as provided in Sentence (4).

(See Note A-9.32.1.2.(2).)

4) Where ancillary spaces described in Clause (3)(c) contain exhaust devices, these spaces shall be provided with make-up air in accordance with Article 9.32.3.8.

**9.32.1.3. Venting of Laundry-Drying Equipment**

1) *Exhaust ducts* or vents connected to laundry-drying equipment shall discharge directly to the outdoors.

- 2) *Exhaust ducts* connected to laundry-drying equipment shall be
- independent of other *exhaust ducts*,
  - accessible for cleaning, and
  - constructed of a smooth corrosion-resistant material.

(See Note A-9.32.1.3.(2).)

3) Where collective venting of multiple installations of laundry-drying equipment is used, the ventilation system shall

- be connected to a common *exhaust duct* that is vented by one central exhaust fan and incorporates one central lint trap,
- include an interlock to activate the central exhaust fan when laundry-drying equipment is in use, and
- where required by Article 9.32.3.8., be provided with make-up air.

**9.32.2. Non-Heating-Season Ventilation**

**9.32.2.1. Required Ventilation**

- 1) The non-heating-season ventilation required by Clause 9.32.1.2.(1)(a) shall be supplied by
  - a) natural ventilation in accordance with Article 9.32.2.2., or
  - b) a mechanical ventilation system in accordance with Article 9.32.2.3.

**9.32.2.2. Non-Heating-Season Natural Ventilation**

- 1) The unobstructed openable ventilation area to the outdoors for rooms and spaces in residential *buildings* ventilated by natural means shall conform to Table 9.32.2.2.

**Table 9.32.2.2.**  
**Natural Ventilation Area**  
Forming Part of Sentence 9.32.2.2.(1)

	Location	Minimum Unobstructed Area
Within a <i>dwelling unit</i>	Bathrooms or water-closet rooms	0.09 m <sup>2</sup>
	Unfinished <i>basement</i> space	0.2% of the <i>floor area</i>
	Dining rooms, living rooms, bedrooms, kitchens, combined rooms, dens, recreation rooms and all other finished rooms	0.28 m <sup>2</sup> per room or combination of rooms
Other than within a <i>dwelling unit</i>	Bathrooms or water-closet rooms	0.09 m <sup>2</sup> per water closet
	Sleeping areas	0.14 m <sup>2</sup> per occupant
	Laundry rooms, kitchens, recreation rooms	4% of the <i>floor area</i>
	Corridors, storage rooms and other similar public rooms or spaces	2% of the <i>floor area</i>
	Unfinished <i>basement</i> space not used on a shared basis	0.2% of the <i>floor area</i>

- 2) Where a vestibule opens directly off a living or dining room within a *dwelling unit*, ventilation to the outdoors for such rooms may be through the vestibule.
- 3) Openings for natural ventilation other than windows shall provide protection from the weather and insects.
- 4) Screening shall be of corrosion-resistant material.

**9.32.2.3. Non-Heating-Season Mechanical Ventilation**

- 1) Where a habitable room or space is not provided with natural ventilation as described in Article 9.32.2.2. and is mechanically cooled, its non-heating-season mechanical ventilation system shall
  - a) have the capacity to exhaust air from inside the room or space, or to introduce outdoor air into that room or space, at a rate conforming with Table 9.32.2.3., or
  - b) comply with Subsection 9.32.3.
- 2) In applying Clause (1)(a),
  - a) at least one bedroom in each *dwelling unit* shall be designated as the master bedroom,
  - b) air change rates for any combined living/dining or family/dining space shall be determined as if the spaces were individual rooms,
  - c) where a *basement* incorporates rooms of the types designated in Table 9.32.2.3., the assigned air change rate for each room shall be as specified for those types of rooms,
  - d) *basement* areas used for other purposes that exceed 2/3 of the total *basement floor area* shall be assigned an air change rate of 10 L/s,

- e) *basement* areas used for other purposes that are 2/3 of the total *basement floor area* or less shall be assigned an air change rate of 5 L/s, and
- f) other habitable rooms, other than spaces intended solely for access, egress, storage, or service equipment, shall be assigned an air change rate of 5 L/s.

**Table 9.32.2.3.**  
**Air Change Rate**  
Forming Part of Clause 9.32.2.3.(1)(a)

Room or Space	Rate, L/s
Master bedroom	10
Other bedrooms	5
Living room	5
Dining room	5
Family room	5
Recreation room	5
<i>Basement</i>	10
Kitchen	5
Bathroom or water-closet room	5
Laundry room	5
Utility room	5
Other habitable rooms	5

**3)** Where a habitable room or space is not provided with natural ventilation as described in Article 9.32.2.2. and is not mechanically cooled, the non-heating-season mechanical ventilation system shall have the capacity to exhaust indoor air from the room or space or to introduce outdoor air to that room or space at a rate of one air change per hour.

**4)** A non-heating-season mechanical ventilation system shall be designed and installed in conformance with good practice such as that described in the ASHRAE Handbooks and Standards, the HRAI Digest, the Hydronics Institute Manuals and the SMACNA manuals.

**9.32.3. Heating-Season Mechanical Ventilation**

(See Note A-9.32.3.)

**9.32.3.1. Required Ventilation**

**1)** The heating-season ventilation required by Clause 9.32.1.2.(1)(b) shall be provided by a mechanical ventilation system complying with

- a) good practice such as that described in CAN/CSA-F326-M, "Residential Mechanical Ventilation Systems,"
- b) for *dwelling units* with 5 or fewer bedrooms, the balance of this Subsection, or
- c) Part 6.

(See Note A-9.32.3.1.(1).)

**2)** Mechanical ventilation systems complying with the balance of this Subsection shall incorporate at least the following components:

- a) a principal ventilation system complying with Article 9.32.3.3.,
- b) supplemental exhaust fans complying with Article 9.32.3.7., and
- c) protection against depressurization in accordance with Article 9.32.3.8.

**9.32.3.2. Design and Installation**

**1)** Aspects of mechanical ventilation systems not specifically described in this Subsection shall be designed, constructed and installed in accordance with good practice such as that described in the ASHRAE Handbooks and Standards, the HRAI

Digest, the HRAI Residential Mechanical Ventilation Manual, the Hydronics Institute Manuals and the SMACNA manuals.

**2)** Ventilation system equipment installed to meet the requirements of this Section shall be installed in accordance with the manufacturers' instructions and recommendations except that, where such instructions and recommendations are in conflict with the requirements of this Subsection, the requirements of this Subsection shall govern.

**3)** Except where mounted on concrete foundations, fans and heat recovery ventilators shall be isolated from structural components by resilient mountings to minimize the transmission of noise and vibration to occupied spaces.

- 4)** Where flow-regulating dampers are required,
- a) they shall be adjustable and accessible without requiring the removal of fans, motors or insulating materials, or the use of specialized tools, and
  - b) a device on the outside of the duct or device in which they are installed shall indicate the position of the damper.

**5)** Ventilation equipment shall be accessible for inspection, maintenance, repair and cleaning.

**6)** Ventilation equipment installed in unheated spaces shall be installed so as to avoid condensation of moisture on fans and motors, in accordance with the manufacturers' instructions.

**9.32.3.3. Principal Ventilation System**

(See Note A-9.32.3.3.)

- 1)** The principal ventilation system shall incorporate the following components:
- a) a principal ventilation fan complying with this Article, and
  - b) except as permitted by Article 9.32.3.6., provision for the introduction of outdoor air to the *dwelling unit*, in conformance with Article 9.32.3.4. or 9.32.3.5.

**2)** The principal ventilation fan shall be capable of operating at an exhaust capacity complying with Table 9.32.3.3., referred to hereinafter as the "normal operating exhaust capacity." (See Note A-9.32.3.3.(2).)

**Table 9.32.3.3.**  
**Normal Operating Exhaust Capacity of Principal Ventilation Fan**  
 Forming Part of Sentence 9.32.3.3.(2)

Number of Bedrooms in <i>Dwelling Unit</i>	Normal Operating Exhaust Capacity of Principal Ventilation Fan, L/s	
	Minimum	Maximum
1	16	24
2	18	28
3	22	32
4	26	38
5	30	45
More than 5	System must comply with Clause 9.32.3.1.(1)(a)	

**3)** The requirement for a principal ventilation fan may be satisfied by a single fan, by the exhaust side of a heat recovery ventilator, or by a group of fans, provided all fans in the group are controlled simultaneously by a controller complying with Sentences (5), (6) and (7). (See Note A-9.32.3.3.(3).)

**4)** The components of the principal ventilation system shall be approved by their manufacturer for continuous operation.



**5)** The principal ventilation fan shall be controlled by a manual switch located within the living area of the *dwelling unit* and clearly marked "VENTILATION FAN." (See Note A-9.32.3.3.(5).)

**6)** If all controls serving the principal ventilation fan are in the "off" position, the principal ventilation system shall not operate.

**7)** The requirement for a manual switch stated in Sentence (5) can be satisfied by a manual override incorporated in a dehumidistat or other automatic control, provided

- a) the automatic control is located within the living area of the *dwelling unit*, and
- b) the manual override is clearly marked "VENTILATION FAN."

**8)** Where the principal ventilation fan is controlled by a dehumidistat or other automatic control in addition to the manual switch required by Sentence (5), the manual switch shall be capable of activating the fan regardless of the setting of the automatic control.

**9)** Where an exhaust air intake for the principal ventilation fan is connected directly to the return side of the duct system of a forced air heating system or other forced air distribution system, it shall be connected, where applicable, not less than 1 m upstream from the connection of the outdoor air *supply duct* required by Sentence 9.32.3.4.(5).

**10)** Exhaust air intakes for principal ventilation fans located in kitchens, bathrooms and water-closet rooms shall be located in the ceiling or on the wall not less than 2 m above the floor. (See Note A-9.32.3.3.(10).)

#### 9.32.3.4. Ventilation Systems Used in Conjunction with Forced Air Heating Systems

(See Note A-9.32.3.4.)

**1)** Where outdoor air is to be introduced to the *dwelling unit* through a forced air heating system, the provision of outdoor air shall comply with this Article.

**2)** Where the actual normal operating exhaust capacity of the fan installed to satisfy the requirement for a principal ventilation fan exceeds the maximum outdoor airflow permitted by Table 9.32.3.4. for a mixed air temperature of 15°C or exceeds the minimum acceptable return air temperature specified by the manufacturer of the *furnace*, whichever is less, then either

- a) the system shall incorporate a means for tempering outdoor air introduced to the heating system ducts so that a mixed air temperature of 15°C or the minimum acceptable return air temperature specified by the manufacturer of the *furnace*, whichever is less, is achieved when the outdoor air is at the January 2.5% temperature and the indoor air temperature is 22°C, or
- b) this Article shall be considered to be no longer applicable and the mechanical ventilation system shall comply with either Clause 9.32.3.1.(1)(a) or with Article 9.32.3.5.

- 3)** For the purposes of Table 9.32.3.4., the *furnace* airflow shall be determined
- a) by operating the forced air heating system's circulation fan at the rate chosen to satisfy Clause (9)(a) when measuring the return airflow in the *furnace* return air *plenum* immediately upstream of the connection of the outdoor air *supply duct* required by Sentence (5) and then adding this return airflow measurement to the actual normal operating exhaust capacity of the fan installed to satisfy the requirement for a principal ventilation fan, or
  - b) by using the manufacturer's rated flow for the *furnace* for 150 Pa static pressure and the wiring configuration necessary to achieve the flow specified in Clause (9)(a).

**4)** Linear interpolation is permitted in using Table 9.32.3.4.

**Table 9.32.3.4.**  
**Maximum Outdoor Airflow**  
 Forming Part of Sentence 9.32.3.4.(2)

January 2.5% Temperature as per Appendix C, °C	Maximum Outdoor Airflow for Indicated Mixed Temperature, L/s																	
	0	0	0	-10	-10	-10	-20	-20	-20	-30	-30	-30	-40	-40	-40	-50	-50	-50
Minimum Mixed Air Temperature, °C	15	10	5	15	10	5	15	10	5	15	10	5	15	10	5	15	10	5
<i>Furnace Airflow, L/s</i>																		
0	0	0	0	0	0	0	0	0	0	0	0	0	0	0	0	0	0	0
100	32	55	77	22	38	53	17	29	40	13	23	33	11	19	27	10	17	24
200	64	109	155	44	75	106	33	57	81	27	46	65	23	39	55	19	33	47
300	—	—	—	66	113	159	50	86	121	40	69	98	34	58	82	29	50	71
400	—	—	—	—	—	—	—	—	—	54	92	131	45	77	110	39	67	94
500	—	—	—	—	—	—	—	—	—	—	—	—	—	—	—	49	83	118

- 5)** An outdoor air *supply duct* shall be installed between the outdoors and the *furnace* return air *plenum* and shall be connected
  - a) not less than 3 m upstream of the *plenum* connection to the *furnace*, as measured along the length of the duct, or
  - b) through an acceptable mixing device installed in the return air *plenum*.
- 6)** The outdoor air *supply duct* required by Sentence (5) shall incorporate a flow-regulating damper.
- 7)** Where the outdoor air *supply duct* required by Sentence (5) is not connected to an outdoor air supply fan, it shall be connected downstream of all return branch connections.
- 8)** Where the outdoor air *supply duct* required by Sentence (5) is connected to an auxiliary outdoor air supply fan, the auxiliary outdoor air supply fan shall be
  - a) approved by the manufacturer for the handling of untempered outdoor air if it will be handling untempered outdoor air,
  - b) approved by the manufacturer for continuous operation, and
  - c) designed to provide an outdoor air supply flow within ±10% of the actual normal operating exhaust capacity of the exhaust fan installed to satisfy the requirement for a principal ventilation fan.
- 9)** The principal ventilation fan control required by Sentence 9.32.3.3.(5) shall be wired in such a way that
  - a) activation of the principal ventilation fan automatically activates the forced air heating system’s circulation fan to provide an airflow not greater than the space-heating airflow,
  - b) where applicable, activation of the principal ventilation fan automatically activates the auxiliary outdoor air supply fan described in Sentence (8), and
  - c) the auxiliary outdoor air supply fan does not operate when the principal ventilation fan is not operating.
- 10)** With the principal ventilation fan operating at its normal operating exhaust capacity, the airflow in the outdoor air *supply duct* shall be measured and the flow-regulating damper required by Sentence (6) shall be adjusted and permanently fixed so that the airflow in the outdoor air *supply duct* is within ±10% of the actual normal operating exhaust capacity of the principal ventilation fan.
- 11)** The airflow measurements required by Sentences (3) and (10) shall be done using a method accurate to within ±15% of the flow rate being measured.
- 12)** All connections between the ventilation system and the heating system shall be in accordance with Articles 9.33.4.1. and 9.33.5.2.

Copyright © NRC 1941 - 2021 World Rights Reserved © CNRC 1941-2021 Droits réservés pour tous pays

**9.32.3.5. Ventilation Systems Not Used in Conjunction with Forced Air Heating Systems**

(See Note A-9.32.3.5.)

- 1)** Where outdoor air is to be introduced to the *dwelling unit* through means other than a forced air heating system, the provision of outdoor air shall comply with this Article.
- 2)** An outdoor air supply fan shall be installed with a rated capacity within  $\pm 10\%$  of the actual normal operating exhaust capacity of the exhaust fan installed to satisfy the requirement for a principal ventilation fan.
- 3)** The principal ventilation fan control required by Sentence 9.32.3.3.(5) shall be wired in such a way that
  - a) activation of the principal ventilation fan automatically activates the outdoor air supply fan required by Sentence (2), and
  - b) the outdoor air supply fan does not operate when the principal ventilation fan is not operating.
- 4)** The outdoor air supply fan shall be connected to the outdoors through an outdoor air *supply duct*.
- 5)** The outdoor air *supply duct* required by Sentence (4) shall incorporate a flow-regulating damper.
- 6)** With the principal ventilation fan operating at its normal operating exhaust capacity, the airflow in the outdoor air *supply duct* shall be measured and the flow-regulating damper required by Sentence (5) shall be adjusted and permanently fixed so that the airflow in the outdoor air *supply duct* is within  $\pm 10\%$  of the actual normal operating exhaust capacity of the principal ventilation fan.
- 7)** The airflow measurements required by Sentence (6) shall be done using a method accurate to within  $\pm 15\%$  of the flow rate being measured.
- 8)** Except where a heat recovery ventilator is used to supply the outdoor air, the outdoor air shall be tempered to at least  $12^{\circ}\text{C}$  before being circulated to habitable spaces.
- 9)** Any tempering device installed to comply with Sentence (8) shall be installed in accordance with Articles 9.33.4.1. and 9.33.5.2.
- 10)** Except as provided in Sentence (11), outdoor air shall be distributed by a system of trunk and branch *supply ducts*, from the outdoor air supply fan required by Sentence (2) to
  - a) each bedroom,
  - b) any *storey*, including *basements* and heated crawl spaces, without a bedroom, and
  - c) if there is no *storey* without a bedroom, to the principal living area.
- 11)** In a *dwelling unit* in which there is no *storey* without a bedroom, if an exhaust air intake for the principal ventilation fan is located in the principal living area and the principal ventilation fan has no more than 2 exhaust air intakes located in other rooms, distribution of outdoor air to the principal living area is not required.
- 12)** All branch *supply ducts* that are not fitted with diffusers with adjustable balance stops shall be supplied with balancing dampers that
  - a) can be fixed in their adjusted positions, and
  - b) include devices to indicate the positions of the dampers.
- 13)** The air supply outlets through which outdoor air is delivered to the rooms shall be located in the ceiling or in a wall at not less than 2 m above the floor and shall be designed and installed to promote diffusion across the ceiling.
- 14)** Provision shall be made for the free flow of air to or from all rooms by leaving gaps beneath doors, using louvered doors or installing grilles in doors.

**9.32.3.6. Exhaust-Only Ventilation Systems**

(See Note A-9.32.3.6.)

- 1)** A ventilation system with no provision for the introduction of outdoor air to the *dwelling unit* may only be used where the *dwelling unit*
  - a) contains no solid-fuel-burning *appliance*, no fireplace of other than *direct-vented* type, and no other fuel-fired space- or water-heating *appliance* of other than *direct-vented* or *mechanically vented* types, and
  - b) has a forced air distribution system with a circulation fan with a rated capacity equal to at least 5 times the actual normal operating exhaust capacity of the fan installed to satisfy the requirement for a principal ventilation fan, a supply side that complies with Sentences 9.32.3.5.(10) to (12), and a return side that complies with Articles 9.33.6.12. and 9.33.6.13.
- 2)** Except as provided in Sentence (3), where an exhaust-only system is installed, the principal ventilation fan control required by Sentence 9.32.3.3.(5) shall be wired in such a way that, where applicable, activation of the principal ventilation fan automatically activates the circulation fan of the forced air distribution system required by Clause (1)(b) at its rated capacity.
- 3)** Interlocking the forced air distribution system's circulation fan with the principal ventilation fan as required by Sentence (2) is not required where the forced air distribution system is equipped with a control that automatically activates the circulation fan at user-selected intervals.

**9.32.3.7. Supplemental Exhaust**

(See Note A-9.32.3.7.)

- 1)** Except as provided in Sentences (2) and (3), a supplemental exhaust fan with a rated capacity not less than 50 L/s shall be installed in each kitchen.
- 2)** A supplemental exhaust fan is not required in a kitchen where the only exhaust air intake for the principal ventilation fan is located in that kitchen.
- 3)** A supplemental exhaust fan is not required in a kitchen where the principal ventilation fan draws from that kitchen and other rooms, provided
  - a) the principal ventilation fan can be switched to a high exhaust rate equal to not less than 2.5 times the minimum normal operating exhaust capacity specified in Table 9.32.3.3., and
  - b) the high exhaust rate of the principal ventilation fan, as described in Clause (a), is activated by a manual switch in the kitchen labeled "KITCHEN EXHAUST."
- 4)** Where an exhaust air intake for the principal ventilation fan is not located in a bathroom or water-closet room, a supplemental exhaust fan with a rated capacity not less than 25 L/s shall be installed in that bathroom or water-closet room.
- 5)** Where the intake for a supplemental exhaust fan other than a cooking *appliance* exhaust fan serving a *cooktop* is installed in a kitchen, it shall be installed in the ceiling or on the wall at not less than 2 m above the floor.
- 6)** A supplemental exhaust fan required by this Article shall be controlled by a manual switch located in the room served by the fan.
- 7)** Where a kitchen or bathroom is exempted from the requirement to install a supplemental exhaust fan by virtue of Sentences (2) or (3), the principal ventilation fan shall be controlled by a manual switch located in the kitchen or bathroom and wired in parallel with the manual switch required by Sentence 9.32.3.3.(5).
- 8)** Where a supplemental exhaust fan required by this Article is controlled by a dehumidistat or other automatic control in addition to the manual switch required by Sentence (6), the manual switch shall be capable of activating the fan regardless of the setting of the automatic control.

**9.32.3.8. Protection Against Depressurization**

(See Note A-9.32.3.8.)

- 1)** This Article applies to
  - a) *dwelling units* that contain a fuel-fired *space-heating appliance* or fuel-fired water-heating *appliance* of other than *direct-vented* or *mechanically vented* types, and
  - b) ancillary spaces that contain an exhaust device, where the space is not within a *dwelling unit* in a house with a *secondary suite* and where the house with a *secondary suite* contains a fuel-fired *space-heating appliance* or fuel-fired water-heating *appliance* of other than *direct-vented* or *mechanically vented* types.

**2)** Except as provided in Sentences (6) to (8), any mechanical air exhausting device, other than the principal ventilation fan operating at a rate not greater than the maximum permitted by Table 9.32.3.3., shall be provided with outdoor makeup air supplied by a fan rated to deliver outdoor air to the *dwelling unit* at a rate

- a) not less than the exhaust capacity of the device, and
- b) not greater than that exhaust capacity plus 10%.

**3)** An outdoor makeup air supply fan required by Sentence (2) shall be wired so that it is activated whenever the device for which it supplies outdoor makeup air is activated.

- 4)** The outdoor makeup air required by Sentence (2) shall be
  - a) introduced to a normally unoccupied area in the *dwelling unit*, or
  - b) tempered to at least 12°C before being introduced to occupied areas or to a *supply duct* system.

**5)** If the outdoor makeup air required by Sentence (2) is not tempered upstream of the supply fan, the supply fan required by Sentence (2) shall be approved by the manufacturer for the handling of untempered outdoor air.

**6)** The provision of makeup air as described in Sentence (2) is not required in a *dwelling unit* with solid-fuel-burning *appliances*, where all other fuel-fired *appliances* are *direct-vented* or *mechanically vented*.

**7)** The provision of makeup air as described in Sentence (2) is not required if it can be shown using the test procedures in CAN/CGSB-51.71, "Depressurization Test," that the maximum depressurization levels to which fuel-fired space- or water-heating *appliances* and their venting systems will be exposed will not exceed the limits set out in CAN/CGSB-51.71 for the categories of fuel-fired *appliances* and venting systems installed in the *dwelling unit*.

**8)** The provision of makeup air as described in Sentence (2) is not required for mechanical exhausting devices operating a subfloor depressurization system installed for the purpose of reducing the risk of radon ingress.

**9.32.3.9. Carbon Monoxide Alarms**

(See Note A-9.32.3.9.)

**1)** This Article applies to every *building* that contains a *residential occupancy* and that also contains

- a) a fuel-burning *appliance*, or
- b) a *storage garage*.

**2)** Carbon monoxide (CO) alarms required by this Article shall

- a) conform to CAN/CSA-6.19, "Residential Carbon Monoxide Alarming Devices,"
- b) be equipped with an integral alarm that satisfies the audibility requirements of CAN/CSA-6.19, "Residential Carbon Monoxide Alarming Devices,"
- c) have no disconnect switch between the overcurrent device and the CO alarm, where the CO alarm is powered by the *dwelling unit's* electrical system, and
- d) be mechanically fixed at a height recommended by the manufacturer.

- 3)** Where a room contains a solid-fuel-burning *appliance*, a CO alarm conforming to CAN/CSA-6.19, "Residential Carbon Monoxide Alarming Devices," shall be mechanically fixed
- at the manufacturer's recommended height where these instructions specifically mention solid-fuel-burning *appliances*, or
  - in the absence of specific instructions related to solid-fuel-burning *appliances*, on or near the ceiling.
- 4)** Where a fuel-burning *appliance* is installed in a *suite of residential occupancy*, a CO alarm shall be installed
- inside each bedroom, or
  - outside each bedroom, within 5 m of each bedroom door, measured following corridors and doorways.
- 5)** Where a fuel-burning *appliance* is installed in a *service room* that is not in a *suite of residential occupancy*, a CO alarm shall be installed
- either inside each bedroom, or if outside, within 5 m of each bedroom door, measured following corridors and doorways, in every *suite of residential occupancy* that shares a wall or floor/ceiling assembly with the *service room*, and
  - in the *service room*.
- 6)** For each *suite of residential occupancy* that shares a wall or floor/ceiling assembly with a *storage garage* or that is adjacent to an attic or crawl space to which the *storage garage* is also adjacent, a CO alarm shall be installed
- inside each bedroom, or
  - outside each bedroom, within 5 m of each bedroom door, measured following corridors and doorways.
- 7)** Where CO alarms are installed in a house with a *secondary suite* including their common spaces, the CO alarms shall be wired so that the activation of any one CO alarm causes all CO alarms within the house with a *secondary suite* including their common spaces to sound.

**9.32.3.10. Fans**

(See Note A-9.32.3.10.)

- 1)** Except as provided in Sentence (4), capacity ratings for required fans shall be determined in accordance with
- CAN/CSA-C260-M, "Rating the Performance of Residential Mechanical Ventilating Equipment," or
  - HVI Publication 916, "Airflow Test Procedure."
- 2)** Sound ratings for fans shall be determined in accordance with
- CAN/CSA-C260-M, "Rating the Performance of Residential Mechanical Ventilating Equipment," or
  - HVI Publication 915, "Loudness Testing and Rating Procedure."
- 3)** Capacity ratings for fans shall be measured at the external static pressure differentials shown in Table 9.32.3.10.-A.
- 4)** Fans in heat recovery ventilators used to provide one or more required fans shall have their airflow at normal temperature rated in accordance with CAN/CSA-C439, "Rating the Performance of Heat/Energy-Recovery Ventilators."
- 5)** Where a heat recovery ventilator is used to provide one or more required fans, it shall have a low-temperature ventilation reduction factor of not less than 50% when tested in accordance with CAN/CSA-C439, "Rating the Performance of Heat/Energy-Recovery Ventilators," at an outdoor temperature at least as low as the outdoor design temperature for the location where the ventilation system is to be installed, but the outdoor design temperature need not be lower than -25°C.

**Table 9.32.3.10.-A**  
**Minimum External Static Pressure Differential for Rating of Fans**  
 Forming Part of Sentence 9.32.3.10.(3)

Fan Configuration or Application	Minimum External Static Pressure Differential to be Used in Determining Rated Capacity
Fans installed with ducts connected on both sides, any application	100 Pa (0.4 inch water column)
Fans installed with ducts on one side only, used as the principal ventilation fan in exhaust-only systems permitted by Article 9.32.3.6.	62 Pa (0.25 inch water column)
Other required fans	25 Pa (0.1 inch water column)

**6)** Fans, including makeup air supply fans, installed to satisfy Articles 9.32.3.3. to 9.32.3.8. with less than 1 m of duct between themselves and the visible interior surfaces of rooms other than unfinished *basements*, furnace rooms, utility rooms and attics, shall have a sound rating complying with Table 9.32.3.10.-B when operating at the required flow rate.

**7)** Mechanical ventilation devices shall conform to CSA C22.2 No. 113, “Fans and Ventilators.”

**Table 9.32.3.10.-B**  
**Maximum Sound Rating for Fans**  
 Forming Part of Sentence 9.32.3.10.(6)

Fan Application	Maximum Sound Rating, sones	
	Rated according to CAN/CSA-C260-M	Rated according to HVI Publication 915
Principal ventilation fan	2.0	2.5
Supplemental fans installed in bathrooms and their makeup air fans	2.5	3.5
Supplemental fans installed in kitchens and their makeup air fans	No rating required	No rating required

**9.32.3.11. Ducts**

(See Note A-9.32.3.11.)

**1)** Except as provided in Sentence (6), ventilation ducts and their fittings shall conform to the requirements of Article 9.33.6.2., except that *exhaust ducts* serving only a bathroom or water-closet room are permitted to be of *combustible* material, provided they are reasonably airtight and constructed of a material impervious to water.

**2)** *Exhaust ducts* shall not discharge into heated or unheated enclosed spaces.

**3)** Where an *exhaust duct* passes through an unheated space or is not separated from an unheated space by an insulated *building* assembly, the duct shall be insulated to not less than RSI 0.5.

**4)** Where a duct carrying outdoor air that is not tempered and not mixed with indoor air passes through heated space, it shall be

- a) insulated to not less than RSI 0.5, and
- b) provided with a *vapour barrier*.

**5)** All exhaust intakes located within 3 m horizontally of a *cooktop* shall be equipped with a grease filter at the intake end.

**6)** Ductwork for cooking *appliance* exhaust fans shall

- a) be of *noncombustible*, corrosion-resistant material,
- b) lead directly to the outdoors with no connections to other exhaust fans or ducts, and
- c) be equipped with a grease filter at the intake end.

- 7) All ductwork shall be installed to avoid crushing and shall be permanently supported to prevent sagging.
- 8) Joints in all ventilation system ducting shall be sealed with mastic, metal foil duct tape or the manufacturers' specified sealants.
- 9) Except where the size of a duct can be determined using Table 9.32.3.11.-A or Table 9.32.3.11.-B, duct sizes shall be determined according to Subsection 9.33.4.

**Table 9.32.3.11.-A**  
**Equivalent Duct Sizes**  
 Forming Part of Sentence 9.32.3.11.(9)

Fan's External Static Pressure, Pa	Duct Diameter, mm	Maximum Airflow in Duct, L/s						
		7	15	25	35	50	75	100
		Maximum Length of Duct, m						
25	75	6	1	0	0	0	0	0
	100	25	6	2	1	0	0	0
	125	60	17	6	3	1	0	0
	150	60	42	16	8	4	2	1
	175	60	60	34	18	9	4	2
	200	60	60	60	35	18	8	5
50	75	16	4	1	0	0	0	0
	100	60	16	6	3	1	0	0
	125	60	47	18	9	5	2	1
	150	60	60	44	23	12	5	3
	175	60	60	60	49	25	12	7
	200	60	60	60	60	48	22	13
62.5	75	22	5	2	1	0	0	0
	100	60	21	8	4	2	1	0
	125	60	60	24	12	6	3	1
	150	60	60	58	31	15	7	4
	175	60	60	60	60	33	15	9
	200	60	60	60	60	60	29	17
100	75	38	9	3	1	0	0	0
	100	60	36	14	7	3	1	1
	125	60	60	41	22	11	5	3
	150	60	60	60	53	27	12	7
	175	60	60	60	60	57	27	15
	200	60	60	60	60	60	51	30
150	75	59	14	5	2	1	0	0
	100	60	57	22	11	6	2	1
	125	60	60	60	34	17	8	4
	150	60	60	60	60	42	20	11
	175	60	60	60	60	60	42	24
	200	60	60	60	60	60	60	46

- 10) In using Table 9.32.3.11.-A,
  - a) when sizing branch ducts, "maximum length of duct" refers to the physical length of the duct from the interior grille served by that branch duct to the exterior hood,



- b) when sizing a trunk duct, “maximum length of duct” refers to the physical length of the duct from the interior grille of the longest branch served by that trunk to the exterior hood,
- c) outdoor air supply ducts shall be sized as trunk ducts,
- d) “maximum airflow in duct” refers to the maximum airflow rate that a given section of duct (branch or trunk) must provide to satisfy the ventilation system design, and
- e) “fan’s external static pressure” refers to the external static pressure at which the fan is rated to achieve the maximum airflow rate that the fan is required or intended to provide.

**11)** Where flexible duct is used, it may be sized by choosing the next higher diameter in Table 9.32.3.11.-A or by choosing the diameter for a duct twice as long as the actual length.

**12)** Where rectangular duct is used in place of round duct, it shall be selected according to Table 9.32.3.11.-B.

**Table 9.32.3.11.-B**  
**Equivalent Duct Sizes**  
 Forming Part of Sentences 9.32.3.11.(9) and (12)

Required Round Duct Size, mm	Permitted Equivalent Rectangular Duct Size, mm			
	Stack duct	100 mm depth	125 mm depth	150 mm depth
75	75 x 150	50 x 100	—	—
100	75 x 250	75 x 100	75 x 125	75 x 150
125	75 x 250	125 x 100	100 x 125	100 x 150
150	75 x 300	200 x 100	150 x 125	125 x 150
175	75 x 350	275 x 100	200 x 125	175 x 150
> 175	Design to Subsection 9.33.4.			

**9.32.3.12. Heat Recovery Ventilators**

(See Note A-9.32.3.12.)

- 1)** This Article shall apply to heat recovery ventilators installed to provide one or more of the fans required by this Subsection.
- 2)** Two or more heat recovery ventilators shall not be connected in parallel airflow to a common air *supply duct*, unless specifically permitted by the manufacturer.
- 3)** Two or more heat recovery ventilators shall not be connected in parallel airflow to a common downstream *exhaust duct*.
- 4)** All start-up procedures recommended by the manufacturer, including air balancing and airflow determination, shall be followed.
- 5)** A means for the free flow of condensate shall be provided in accordance with the manufacturer’s recommendations or, in their absence, a condensate drain of at least 1/2 inch nominal pipe size pitched in the direction of flow and complete with a trap or condensate pump of sufficient capacity shall be installed and connected to the *dwelling unit’s* drain, waste and vent system.
- 6)** The heat recovery ventilator and all condensate lines shall be installed in a space where the ambient temperature will not adversely affect the operation of the system.

**9.32.3.13. Outdoor Intake and Exhaust Openings**

- 1)** Intake openings shall be located so as to avoid contamination of the ventilation air from other local sources such as automobile exhaust and exhaust from the *building* or adjacent *buildings*.
- 2)** The distance from the bottom of an air intake opening to finished ground or to any nearer and lower permanent horizontal surface shall be not less than 450 mm or the depth of expected snow accumulation, whichever is greater.

- 3) The distance separating air intakes from *building* envelope penetrations that are potential sources of contaminants, such as *gas vents* or oil fill pipes, shall be not less than 900 mm.
- 4) Air intakes shall be clearly labeled as such for identification from locations outside the *dwelling unit*.
- 5) The distance from the bottom of an exhaust outlet to finished ground or to any nearer and lower permanent horizontal surface shall be not less than 100 mm.
- 6) Where air intake and exhaust openings are in exposed locations, provision shall be made to protect them from the entry of precipitation by the use of louvres, weather cowls or other suitable protection.
- 7) Air intake openings shall incorporate screens or grilles to protect against the entry of animals and insects.
- 8) Except for exhaust outlets serving heat recovery ventilators, exhaust outlets shall incorporate backdraft dampers.
- 9) An exhaust outlet that does not incorporate a backdraft damper located at the *building* envelope shall incorporate a screen located at the *building* envelope to protect against the entry of animals.
- 10) Screens, grilles and filters installed in air intake and exhaust openings shall be easily removable for cleaning purposes, without the need for special tools.
- 11) Where screens or grilles are installed in air intake and exhaust openings, the net free area of the air intake or exhaust opening shall be equal to or greater than the required cross-sectional area of the duct served or such openings shall comply with Table 9.32.3.13.
- 12) Screens and grilles shall be of corrosion-resistant material.

**Table 9.32.3.13.**  
**Area of Openings with Screens or Grilles**  
 Forming Part of Sentence 9.32.3.13.(11)

Mesh Size of Screen or Grille, mm	Area of Opening
Less than 4	3 times required area of duct served
4 to 6	2 times required area of duct served
Larger than 6	Required area of duct served

## Section 9.33. Heating and Air-conditioning

### 9.33.1. General

#### 9.33.1.1. Application

- 1) This Section applies to the design and installation of
  - a) heating systems, including requirements for combustion air, and air-conditioning systems serving only one *dwelling unit*, and
  - b) radiant heating systems in houses with a *secondary suite* including their common spaces.
- 2) The design and installation of heating systems, including requirements for combustion air, and air-conditioning systems other than those described in Sentence (1) shall conform to Part 6. (See Note A-9.33.1.1.(2) and Subsection 9.10.10.)
- 3) Air duct distribution systems serving one of the *dwelling units* in a house with a *secondary suite* shall not be directly interconnected with other parts of the house.
- 4) Systems used for heating and air-conditioning shall conform to the energy efficiency requirements in Section 9.36.

**9.33.2. Required Heating Systems****9.33.2.1. Required Heating Systems**

1) Residential *buildings* intended for use in the winter months on a continuing basis shall be equipped with heating facilities conforming to this Section.

**9.33.3. Design Temperatures****9.33.3.1. Indoor Design Temperatures**

1) At the outside winter design temperature, required heating facilities shall be capable of maintaining an indoor air temperature of not less than

- a) 22°C in all living spaces,
- b) 18°C in unfinished *basements*,
- c) 18°C in common *service rooms*, ancillary spaces and *exits* in houses with a *secondary suite*, and
- d) 15°C in heated crawl spaces.

**9.33.3.2. Outdoor Design Temperatures**

1) The outdoor conditions to be used in designing heating and air-conditioning systems shall be determined in conformance with Article 1.1.3.1.

**9.33.4. General Requirements for Heating and Air-conditioning Systems****9.33.4.1. Design of Heating and Air-conditioning Systems**

1) Heating and air-conditioning systems, including ducting, and mechanical heating and refrigeration equipment, shall be designed, constructed and installed to conform to the relevant provincial or territorial regulations or municipal bylaws or, in the absence of such regulations or bylaws, with good practice such as that described in the ASHRAE Handbooks and Standards, the HRAI Digest, the CHC Handbook on Hydronic Heating Systems, the Hydronics Institute Manuals and the SMACNA Manuals. (See also Subsection 9.32.3. for the design of systems that also provide ventilation.)

**9.33.4.2. Installation of Hydronic Heating Systems**

1) The installation of a hydronic heating system shall conform to applicable provincial or territorial regulations or municipal bylaws or, in the absence of such regulations or bylaws, to CSA B214, "Installation Code for Hydronic Heating Systems."

**9.33.4.3. Heating System Control**

1) Where a single heating system serves a house with a *secondary suite*, individual temperature controls shall be provided in each *dwelling unit* served by the system. (See Note A-9.33.4.3.(1).)

**9.33.4.4. Access**

1) Equipment forming part of a heating or air-conditioning system, with the exception of embedded pipes or ducts, shall be installed with provision for access for inspection, maintenance, repair and cleaning.

**9.33.4.5. Protection from Freezing**

1) Equipment forming part of a heating or air-conditioning system that may be adversely affected by freezing temperatures and that is located in an unheated area shall be protected from freezing.

**9.33.4.6.****9.33.4.6. Expansion, Contraction and System Pressure**

1) Heating and cooling systems shall be designed to allow for expansion and contraction of the heat transfer fluid and to maintain the system pressure within the rated working pressure limits of all components of the system.

**9.33.4.7. Structural Movement**

1) Mechanical systems and equipment shall be designed and installed to accommodate the maximum amount of structural movement provided for in the construction of the *building*.

2) Where the *building* is in a location where the spectral response acceleration,  $S_a(0.2)$ , is greater than 0.55, heating and air-conditioning equipment with fuel or power connections shall be secured to the structure to resist overturning and displacement. (See Note A-9.31.6.2.(3).)

**9.33.4.8. Asbestos**

1) Asbestos shall not be used in air distribution systems or equipment in a form or in a location where asbestos fibres could enter the air supply or return systems.

**9.33.4.9. Contaminant Transfer**

1) Systems serving garages, and systems serving other occupied parts of a *dwelling unit* but located in or running through a garage, shall be designed and constructed in a manner such that means are not provided for the transfer of contaminants from the garage into other spaces in the *dwelling unit*.

**9.33.5. Heating and Air-conditioning Appliances and Equipment****9.33.5.1. Capacity of Heating Appliances**

1) The required capacity of heating *appliances* located in a *dwelling unit* and serving only that *dwelling unit*, shall be determined in accordance with CSA F280, "Determining the Required Capacity of Residential Space Heating and Cooling Appliances," except that the design temperatures shall conform to Subsection 9.33.3.

**9.33.5.2. Installation Standards**

1) Except as provided in Articles 9.33.5.3. and 9.33.5.4., the installation of heating and air-conditioning equipment, including mechanical refrigeration equipment, and including provisions for mounting, clearances and air supply, shall conform to applicable provincial or territorial regulations or municipal bylaws or, in the absence of such regulations or bylaws, to

- a) CSA B51, "Boiler, Pressure Vessel, and Pressure Piping Code,"
- b) CSA B52, "Mechanical Refrigeration Code,"
- c) CSA B139, "Installation Code for Oil-Burning Equipment,"
- d) CSA B149.1, "Natural Gas and Propane Installation Code,"
- e) CSA C22.1, "Canadian Electrical Code, Part I," or
- f) CSA C448 Series, "Design and Installation of Earth Energy Systems."

(See also Sentence 9.33.5.3.(1).)

**9.33.5.3. Design, Construction and Installation Standard for Solid-Fuel-Burning Appliances**

(See Note A-9.33.5.3.)

1) The design, construction and installation, including the provision of combustion air, of solid-fuel-burning *appliances* and equipment, including *stoves*, *cooktops*, *ovens* and *space heaters*, shall conform to CSA B365, "Installation Code for Solid-Fuel-Burning Appliances and Equipment."

**9.33.5.4. Fireplaces**

1) Fireplaces shall conform to Section 9.22.

**9.33.6. Air Duct Systems****9.33.6.1. Application**

**1)** The design, construction and installation of air duct distribution systems serving heating systems in which the rated heat input does not exceed 120 kW shall conform to this Subsection.

**2)** Air duct distribution systems in which the rated heat input exceeds 120 kW shall conform to Part 6 and Subsection 3.6.5.

**9.33.6.2. Materials in Air Duct Systems**

**1)** Except as provided in Sentences (2) to (6) and in Article 3.6.4.3., all ducts, duct connectors, associated fittings and *plenums* used in air duct systems shall be constructed of steel, aluminum alloy, copper, clay, asbestos-cement or similar *noncombustible* material.

**2)** Ducts, associated fittings and *plenums* are permitted to contain *combustible* material provided they

- a) conform to the appropriate requirements for Class 1 duct materials in CAN/ULC-S110, "Test for Air Ducts,"
- b) conform to Article 3.1.5.18. and Subsection 3.1.9.,
- c) are not used in vertical runs serving more than 2 *storeys*, and
- d) are not used in air duct systems in which the air temperature may exceed 120°C.

**3)** Duct sealants shall have a *flame-spread rating* of not more than 25 and a smoke developed classification of not more than 50.

**4)** Duct connectors that contain *combustible* materials and that are used between ducts and air outlet units shall

- a) conform to the appropriate requirements for Class 1 air duct materials in CAN/ULC-S110, "Test for Air Ducts,"
- b) be limited to 4 m in length,
- c) be used only in horizontal runs, and
- d) not penetrate required *fire separations*.

**5)** *Combustible* ducts that are part of a duct system carrying only ventilation air and that are contained entirely within a *dwelling unit* need not comply with the requirements of Sentences (1) to (4).

**6)** Except as provided in Sentences 9.33.6.13.(2) and (3), ducts that are part of a return-air duct system and that are contained entirely within a *dwelling unit* need not comply with the requirements of Sentences (1) to (4).

**7)** Materials referred to in Sentences (1) to (6), when used in a location where they may be subjected to excessive moisture, shall

- a) have no appreciable loss of strength when wet, and
- b) be corrosion-resistant.

**9.33.6.3. Tape**

**1)** Tape used for sealing duct joints in air ducts, *plenums* and other parts of air duct systems shall meet the flame-resistance requirements for fabric in CAN/ULC-S109, "Flame Tests of Flame-Resistant Fabrics and Films."

**9.33.6.4. Coverings, Linings, Adhesives and Insulation**

**1)** Coverings, linings and associated adhesives and insulation of air ducts, *plenums* and other parts of air duct systems shall be of *noncombustible* material when exposed to heated air or radiation from heat sources that would result in the exposed surface exceeding a temperature of 120°C.

- 2)** Except as provided in Sentence (3), when *combustible* coverings and linings, including associated adhesives and insulation, are used, they shall have
- a *flame-spread rating* of not more than 25 on any exposed surface or any surface that would be exposed by cutting through the material in any direction, and
  - a smoke developed classification of not more than 50.
- 3)** The outer covering of ducts, *plenums* and other parts of air duct systems used within an assembly of *combustible construction* are permitted to have
- an exposed surface *flame-spread rating* of not more than 75, and
  - a smoke developed classification greater than 50.
- 4)** *Combustible* coverings and linings described in Sentences (2), (3) and (6) shall not flame, glow, smoulder or smoke when tested in accordance with the method of test in ASTM C 411, "Hot-Surface Performance of High-Temperature Thermal Insulation," at the maximum temperature to which the coverings and linings are to be exposed in service.
- 5)** Except as provided in Sentences (6) and (7), foamed plastic insulation shall not be used as part of an air duct or for insulating an air duct.
- 6)** Foamed plastic insulation conforming to Article 9.25.2.2. is permitted to be used to insulate a galvanized steel, stainless steel or aluminum air duct, provided
- the foamed plastic insulation applied to supply ductwork is not less than 3 m from the *furnace* bonnet,
  - the temperature within the ductwork where the insulation is installed is not greater than 50°C,
  - duct joints are taped with a product conforming to Sentence 9.33.6.3.(1),
  - return air *plenums* are separated from the foamed plastic insulation, and
  - the foamed plastic insulation is protected
    - by one of the interior finishes described in Subsections 9.29.4. to 9.29.9.,
    - provided the *building* does not contain a Group C *major occupancy*, by sheet metal that is mechanically fastened to the supporting assembly independent of the insulation, is not less than 0.38 mm thick and has a melting point of 650°C or more, or
    - by any thermal barrier that meets the requirements of Clause 3.1.5.15.(2)(e).
- 7)** Foamed plastic insulation is permitted to be used in a ceiling space that acts as a return air *plenum* provided the foamed plastic insulation is protected from exposure to the *plenum* in accordance with Sentence 3.1.5.14.(4).
- 8)** *Combustible* coverings and linings of ducts, including associated adhesives and insulation, shall be interrupted
- at the immediate area of operation of heat sources in a duct system, such as electric resistance heaters or fuel-burning heaters or *furnaces*, and
  - where the duct penetrates a *fire separation*.
- 9)** Linings of ducts shall be installed so that they will not interfere with the operation of volume or balancing dampers or of *fire dampers*, *fire stop flaps* and other closures.

### 9.33.6.5. Galvanized Steel or Aluminum Supply Ducts

- 1)** Galvanized steel or aluminum *supply ducts* shall conform to Table 9.33.6.5.
- 2)** The design of fittings for ducts shall conform to ANSI/SMACNA 006, "HVAC Duct Construction Standards – Metal and Flexible," except that metal thicknesses shall conform to Table 9.33.6.5.

**Table 9.33.6.5.**  
**Minimum Metal Thickness of Ducts**  
 Forming Part of Article 9.33.6.5.

Type of Duct	Maximum Diameter, mm	Maximum Width or Depth, mm	Minimum metal thickness, mm	
			Duct Material	
			Galvanized Steel	Aluminum
Round ducts serving single <i>dwelling units</i>	125 or less	—	0.254	0.30
Round	350	—	0.33	0.30
	Over 350	—	0.41	0.41
Rectangular, enclosed	—	350	0.33	0.30
	—	Over 350	0.41	0.41
Rectangular, not enclosed, for single <i>dwelling units</i> , with required clearance up to 12 mm	—	350	0.33	0.41
	—	Over 350	0.41	0.48
Rectangular, not enclosed, with required clearance of more than 12 mm	—	350	0.41	0.41
	—	Over 350	0.48	0.48

**9.33.6.6. Construction of Ducts and Plenums**

- 1) Where the installation of heating *supply ducts* in walls and floors creates a space between the duct and construction material, the space shall be fire stopped with *noncombustible* material at each end.
- 2) Ducts shall be securely supported by metal hangers, straps, lugs or brackets, except that, where zero clearance is permitted, wooden brackets are permitted to be used.
- 3) All round duct joints shall be tight-fitting and lapped not less than 25 mm.
- 4) Rectangular duct connections shall be made with S and drive cleats or equivalent mechanical connections.
- 5) Duct systems shall have no openings other than those required for the proper operation and maintenance of the system.

**9.33.6.7. Installation of Ducts and Plenums**

- 1) Air duct systems serving garages shall not be interconnected with other parts of the *dwelling unit*.
- 2) Trunk *supply ducts* shall not be nailed directly to wood members.
- 3) Branch ducts shall be supported at suitable spacings to maintain alignment and prevent sagging.
- 4) Ducts passing through unheated spaces shall have all joints taped or otherwise sealed to ensure that the ducts are airtight throughout their length.
- 5) *Combustible* ducts in concrete slabs-on-ground that are connected to a *furnace supply plenum* shall be located not closer than 600 mm to that *plenum* and not less than 600 mm from its connection to a riser or register.
- 6) Ducts in or beneath concrete slabs-on-ground shall be watertight and corrosion-, decay-, and mildew-resistant.
- 7) Underground ducts shall
  - a) be constructed to provide interior drainage from and access to all low points, and
  - b) not be connected directly to a sewer.

**9.33.6.8. Clearances of Ducts and Plenums**

- 1) The clearance of *furnace plenums* from *combustible* material shall conform to the appropriate standards in Sentence 9.33.5.2.(1).

- 2)** Where the *plenum* clearance required in Sentence (1) is 75 mm or less, the clearance between a *supply duct* and *combustible* material shall
- be equal to the required *plenum* clearance within 450 mm of the *plenum*, and
  - be not less than 12 mm at a distance of 450 mm or more from the *plenum*, except that this clearance may be reduced to zero beyond a bend or offset in the duct sufficiently large to shield the remainder of the *supply duct* from direct radiation from the *furnace* heat exchanger. (See Note A-3.6.5.6.(2).)
- 3)** Where the *plenum* clearance required in Sentence (1) is more than 75 mm but not more than 150 mm, the clearance between a *supply duct* and *combustible* material shall be
- equal to the required *plenum* clearance within a horizontal distance of 1.8 m of the *plenum*, and
  - not less than 12 mm at a horizontal distance of 1.8 m or more from the *plenum*, except that this distance may be reduced to zero beyond a bend or offset in the duct sufficiently large to shield the remainder of the duct from direct radiation from the *furnace* heat exchanger. (See Note A-3.6.5.6.(3).)
- 4)** Where the *plenum* clearance required in Sentence (1) is more than 150 mm, the clearance between a *supply duct* and *combustible* material shall be
- equal to the required *plenum* clearance within a horizontal distance of 1 m of the *plenum*,
  - not less than 150 mm within a horizontal distance between 1 m and 1.8 m from the *plenum*, and
  - not less than 25 mm at a horizontal distance of 1.8 m or more from the *plenum*, except that this distance may be reduced to 8 mm beyond a bend or offset in the duct sufficiently large to shield the remainder of the *supply duct* from direct radiation from the *furnace* heat exchanger. (See Note A-3.6.5.6.(4).)
- 5)** Where a register is installed in a floor directly over a pipeless *furnace*, a double-walled register box with not less than 100 mm between walls, or a register box with the warm-air passage completely surrounded by the cold-air passage, shall be permitted in lieu of the clearances listed in Sentences (2), (3) and (4).

#### 9.33.6.9. Adjustable Dampers and Balance Stops

- 1)** All branch *supply ducts* that are not fitted with diffusers with adjustable balance stops shall be supplied with adjustable dampers and fitted with devices to indicate the positions of the dampers.

#### 9.33.6.10. Warm-Air Supply Outlets and Return Inlets — General

- 1)** Supply outlets and return openings in the *dwelling unit*, when located less than 2 m above the floor, shall be protected by grilles having openings of a size that will not allow the passage of a 15 mm diam sphere.
- 2)** *Combustible* grilles, diffusers and other devices for the supply and return air openings installed in walls and ceilings shall have a *flame-spread rating* of
- not more than 200 in bathrooms, and
  - not more than 150 in rooms or spaces other than bathrooms.

#### 9.33.6.11. Warm-Air Supply Outlets

- 1)** In a *dwelling unit*, a warm-air supply outlet shall be provided in each finished room that is located adjacent to unheated space.
- 2)** Except as provided in Sentence (3), when a room described in Sentence (1) is located adjacent to exterior walls, such outlet shall be located so as to bathe at least one exterior wall or window with warm air, except in bathrooms, utility rooms or kitchens, where this may not be practical.
- 3)** Where the heating system is also designed to provide ventilation air, ceiling outlets or outlets located high on interior walls are permitted to be installed, provided the outlets are designed for this purpose and are installed with diffusers.



4) At least one warm-air supply outlet shall be provided for each 40 m<sup>2</sup> of floor surface area in unfinished *basements* serving *dwelling units*, and it shall be located so as to provide adequate distribution of warm air throughout the *basement*.

5) At least one warm-air supply outlet shall be provided for each 80 m<sup>2</sup> of floor surface area in heated crawl spaces serving *dwelling units*, and it shall be located so as to provide adequate distribution of warm air throughout the crawl space.

6) Except for pipeless *furnaces*, the capacity of warm-air supply outlets serving *dwelling units* shall be not less than the design heat loss from the area served and shall not exceed 3 kW per outlet.

7) In *basements* and heated crawl spaces, the calculated heat gain from the *supply ducts* and *plenum* surfaces is permitted to be considered in calculating the design heat loss.

8) The temperature of supply air at warm-air supply outlets shall not exceed 70°C.

9) Warm-air supply outlets located in finished areas shall be provided with diffusers and adjustable openings and shall not be located on a *furnace plenum*.

#### 9.33.6.12. Return-Air Inlets

1) Return-air inlets shall not be installed in an enclosed room or crawl space that provides combustion air to a *furnace*.

2) Except for unfinished areas and floor levels which are less than 900 mm above or below an adjacent floor level which is provided with a return-air inlet, at least one return-air inlet shall be provided in each floor level in a *dwelling unit*.

3) Provision shall be made for the return of air from all rooms by leaving gaps beneath doors, using louvred doors or installing *return duct* inlets.

#### 9.33.6.13. Return-Air System

(See Note A-9.33.6.13.)

1) The return-air system shall be designed to handle the entire air supply.

2) Where any part of a *return duct* will be exposed to radiation from the *furnace* heat exchanger or other radiating part within the *furnace*, such part of a *return duct* directly above or within 600 mm of the outside *furnace* casing shall be *noncombustible*.

3) *Return ducts* serving solid-fuel-burning *furnaces* shall be constructed of *noncombustible* material.

4) *Combustible return ducts* shall be lined with *noncombustible* material

- a) below floor registers,
- b) at the bottom of vertical ducts, and
- c) under *furnaces* having a bottom return.

5) Spaces between studs or joists used as *return ducts* shall be separated from the unused portions of such spaces by tight-fitting metal stops or wood blocking.

6) A vertical *return duct* shall have openings to return air on not more than one floor.

7) The return-air system shall be designed so that the negative pressure from the circulating fan cannot

- a) affect the *furnace* combustion air supply, nor
- b) draw combustion products from joints or openings in the *furnace* or *flue pipe*.

#### 9.33.6.14. Filters and Odour Removal Equipment

1) Air filters for air duct systems shall conform to the requirements for Class 2 air filter units as described in CAN/ULC-S111, "Fire Tests for Air Filter Units."

2) When electrostatic-type filters are used, they shall be installed so as to ensure that the electric circuit is automatically de-energized when filter access doors are opened or, in *dwelling units*, when the *furnace* circulation fan is not operating.

- 3) When odour removal equipment of the adsorption type is used it shall be
  - a) installed to provide access so that adsorption material can be reactivated or renewed, and
  - b) protected from dust accumulation by air filters installed on the inlet side.

## 9.33.7. Radiators and Convectors

### 9.33.7.1. Recessed Radiators and Convectors

1) Every steam or hot water radiator and convector located in a recess or concealed space or attached to the face of a wall of *combustible construction* shall be provided with a *noncombustible* lining or backing.

### 9.33.7.2. Surface Temperature

1) The exposed surface temperature of a steam or hot water radiator shall not exceed 70°C unless precautions are taken to prevent human contact.

## 9.33.8. Piping for Heating and Cooling Systems

### 9.33.8.1. Piping Materials and Installation

- 1) Piping shall be made from materials designed to withstand the effects of temperatures and pressures that may occur in the system. (See Articles 3.1.5.19., 3.1.9.1. and 9.10.9.6. for fire safety requirements.)
- 2) Every pipe used in a heating or air-conditioning system shall be installed to allow for expansion and contraction due to temperature changes.
- 3) Supports and anchors for piping in a heating or air-conditioning system shall be designed and installed to ensure that undue stress is not placed on the supporting structure.

### 9.33.8.2. Insulation and Coverings

- 1) Insulation and coverings on pipes shall be composed of material suitable for the operating temperature of the system to withstand deterioration from softening, melting, mildew and mould.
- 2) Insulation and coverings on pipes in which the temperature of the fluid exceeds 120°C
  - a) shall be made of *noncombustible* material, or
  - b) shall not flame, glow, smoulder or smoke when tested in accordance with ASTM C 411, "Hot-Surface Performance of High-Temperature Thermal Insulation," at the maximum temperature to which such insulation or covering is to be exposed in service.
- 3) Except as provided in Sentence (6), where *combustible* insulation is used on piping in a horizontal or *vertical service space*, the insulation and coverings on such pipes shall have a *flame-spread rating* throughout the material of not more than
  - a) 25 in *buildings* of *noncombustible construction*, and
  - b) 75 in *buildings* of *combustible construction*.
- 4) Except as provided in Sentence (6), insulation and coverings on piping located in rooms and spaces other than the *service spaces* described in Sentence (3) shall have a *flame-spread rating* not more than that required for the interior finish for the ceiling of the room or space.
- 5) Pipes that are exposed to human contact shall be insulated so that the exposed surface does not exceed 70°C. (See Note A-6.5.1.1.(3).)
- 6) No *flame-spread rating* or smoke developed classification limitations are required where *combustible* insulation and coverings are used on piping when such piping is
  - a) located within a concealed space in a wall,
  - b) located in a floor slab, or
  - c) enclosed in a *noncombustible* raceway or conduit.

**9.33.8.3. Clearances**

1) Clearances between *combustible* material and bare pipes carrying steam or hot water shall conform to Table 9.33.8.3.

**Table 9.33.8.3.**  
**Clearance between Steam or Hot Water Pipes and Combustible Material**  
 Forming Part of Sentence 9.33.8.3.(1)

Steam or Water Temperature (T), °C	Minimum Clearance, mm
T ≤ 95	no clearance required
95 < T ≤ 120	15
T > 120	25

**9.33.8.4. Protection**

1) Where a pipe carrying steam or hot water at a temperature above 120°C passes through a *combustible* floor, ceiling or wall, the construction shall be protected by a sleeve of metal or other *noncombustible* material not less than 50 mm larger in diameter than the pipe.

2) Unprotected steam or hot water pipes that pass through a storage space shall be covered with not less than 25 mm thickness of *noncombustible* insulation to prevent direct contact with the material stored.

**9.33.9. Refrigerating Systems and Equipment for Air-conditioning**

**9.33.9.1. Cooling Units**

1) Where a cooling unit is combined with a fuel-fired *furnace* in the same duct system, the cooling unit shall be installed

- a) in parallel with the heating *furnace*,
- b) upstream of the *furnace*, provided the *furnace* is designed for such application, or
- c) downstream of the *furnace*, provided the cooling unit is designed to prevent excessive temperature or pressure in the refrigeration system.

**9.33.10. Chimneys and Venting Equipment**

**9.33.10.1. Requirement for Venting**

1) Except as provided in Articles 9.33.10.2. and 9.33.10.3., the products of combustion from oil-, gas- and solid-fuel-burning *appliances*, including *stoves*, *cooktops*, *ovens* and *space heaters*, shall be vented in conformance with the applicable *appliance* installation standard listed in Sentences 9.33.5.2.(1) and 9.33.5.3.(1).

**9.33.10.2. Factory-Built Chimneys**

1) *Factory-built chimneys* serving solid-fuel-burning *appliances*, and their installation, shall conform to CAN/ULC-S629-M, "650°C Factory-Built Chimneys." (See Note A-9.33.10.2.(1).)

**9.33.10.3. Masonry or Concrete Chimneys**

1) *Masonry or concrete chimneys* shall conform to Section 9.21.

## Section 9.34. Electrical Facilities

### 9.34.1. General

#### 9.34.1.1. Standard for Electrical Installations

1) Electrical installations, including the service capacity of the installation and the number and distribution of circuits and receptacles, shall meet the requirements of the appropriate provincial, territorial or municipal legislation or, in the absence of such legislation, shall conform to CSA C22.1, "Canadian Electrical Code, Part I."

#### 9.34.1.2. Required Facilities

1) Where electrical services are available, electrical facilities shall be provided for every *building* in conformance with this Section.

#### 9.34.1.3. Location of Equipment in Public Areas

1) Entrance switches, meters, panel boxes, splitter boxes, time clocks and other similar equipment shall not be located in any public area unless adequate precautions are taken to prevent interference with the equipment.

#### 9.34.1.4. Recessed Lighting Fixtures

1) Recessed lighting fixtures shall not be located in insulated ceilings unless the fixtures are designed for such installations.

#### 9.34.1.5. Wiring and Cables

1) Except as required in Sentence (2), optical fibre cables and electrical wires and cables installed in *buildings* permitted to be of *combustible construction* shall

- a) not convey flame or continue to burn for more than 1 min when tested in conformance with the Vertical Flame Test (FT1 rating) in CSA C22.2 No. 0.3, "Test Methods for Electrical Wires and Cables," or
- b) be located in
  - i) totally enclosed *noncombustible* raceways (see Note A-3.1.4.3.(1)(b)(i)),
  - ii) masonry walls,
  - iii) concrete slabs, or
  - iv) totally enclosed non-metallic raceways conforming to Clause 3.1.5.23.(1)(b).

2) Except as permitted in Sentence (3), where a concealed space in a floor or ceiling assembly is used as a *plenum*, electrical wires and cables with *combustible* insulation, jackets or sheathes that are used for the transmission of voice, sound or data and optical fibre cables installed within the *plenum* shall conform to Clause 3.6.4.3.(1)(a).

3) Wires or cables within *plenum* spaces that are used for the transmission of signals in fire alarm, security, radio, and television broadcasting, closed circuit television or community television systems need not meet the requirements of Sentence (2).

### 9.34.2. Lighting Outlets

(See Note A-9.34.2.)

#### 9.34.2.1. Lighting of Entrances

1) An exterior lighting outlet with fixture controlled by a wall switch located within the *building* shall be provided at every entrance to *buildings of residential occupancy*.

#### 9.34.2.2. Outlets in Dwelling Units

1) Except as provided in Sentence (2), a lighting outlet with fixture controlled by a wall switch shall be provided in kitchens, bedrooms, living rooms, utility rooms,

laundry rooms, dining rooms, bathrooms, water-closet rooms, vestibules and hallways in *dwelling units*.

2) Where a receptacle controlled by a wall switch is provided in bedrooms or living rooms, such rooms need not conform to the requirements in Sentence (1).

#### 9.34.2.3. Stairways

1) Every stairway shall be lighted.

2) Except as provided in Sentence (3), 3-way wall switches located at the head and foot of every stairway shall be provided to control at least one lighting outlet with fixture for stairways with 4 or more risers in *dwelling units* and houses with a *secondary suite* including their common spaces.

3) The stairway lighting for *basements* that do not contain finished space or lead to an outside entrance or built-in garage and which serve not more than one *dwelling unit* is permitted to be controlled by a single switch located at the head of the stairs.

#### 9.34.2.4. Basements

1) A lighting outlet with fixture shall be provided for each 30 m<sup>2</sup> or fraction thereof of *floor area* in unfinished *basements*.

2) The outlet required in Sentence (1) nearest the stairs shall be controlled by a wall switch located at the head of the stairs.

#### 9.34.2.5. Storage Rooms

1) A lighting outlet with fixture shall be provided in storage rooms.

#### 9.34.2.6. Garages and Carports

1) A lighting outlet with fixture shall be provided for an attached, built-in or detached garage or carport.

2) Except as provided in Sentence (3), outlets required in Sentence (1) shall be controlled by a wall switch near the doorway.

3) Where the outlet and fixture required in Sentence (1) are ceiling mounted above an area not normally occupied by a parked car, or are wall mounted, a fixture with a built-in switch accessible to an adult of average height is permitted to be used.

4) Where a carport is lighted by a light at the entrance to a *dwelling unit*, additional carport lighting is not required.

#### 9.34.2.7. Public and Service Areas

1) Every public or service area in *buildings* shall be provided with lighting outlets with fixtures controlled by a wall switch or panel to illuminate every portion of such areas.

2) When provided by incandescent lighting, illumination required in Sentence (1) shall conform to Table 9.34.2.7. (See Article 9.9.12.2. for lighting in *means of egress*.)

3) When other types of lighting are used, illumination equivalent to that shown in Table 9.34.2.7. shall be provided.

**Table 9.34.2.7.**  
**Lighting for Public Areas**  
 Forming Part of Sentences 9.34.2.7.(2) and (3)

Room or Space	Minimum Illumination, lx	Minimum Lighting Power Density, W/m <sup>2</sup> of floor area (incandescent lighting)
Storage rooms	50	5
Service rooms and laundry areas	200	20
Garages	50	5
Public water closet rooms	100	10
Service hallways and stairways	50	5
Recreation rooms	100	10

### 9.34.3. Emergency Lighting

#### 9.34.3.1. Criteria for Emergency Lighting

- 1) Emergency lighting shall conform to Subsection 9.9.12.

## Section 9.35. Garages and Carports

### 9.35.1. Scope

#### 9.35.1.1. Application

- 1) This Section applies to garages and carports serving not more than one *dwelling unit*.

#### 9.35.1.2. Construction Requirements

- 1) The construction of a garage or carport shall conform to the requirements for other *buildings* in this Part except as provided in this Section.

### 9.35.2. General

#### 9.35.2.1. Carport Considered to be Garage

- 1) Where a roofed enclosure used for the storage or parking of motor vehicles has more than 60% of the total perimeter enclosed by walls, doors or windows, the enclosure shall be considered a garage.

#### 9.35.2.2. Garage Floor

- 1) Where an attached or built-in garage is provided and where adjacent spaces in the *building* are less than 50 mm above the garage floor,
  - a) the garage floor shall be sloped to the outdoors, or
  - b) where the garage can accommodate not more than 3 vehicles, an airtight curb or *partition* not less than 50 mm high shall be installed at the edges of the garage floor adjacent to interior space.
 (See Note A-9.35.2.2.(1).)

### 9.35.3. Foundations

#### 9.35.3.1. Foundation Required

- 1) Except as permitted in this Subsection, *foundations* conforming to Sections 9.12. and 9.15. shall be provided for the support of carport and garage super-structures, including that portion beneath garage doors.

- 2) Detached garages of less than 55 m<sup>2</sup> *floor area* and not more than 1 *storey* in height that are not of masonry or masonry veneer construction are permitted to be supported on
- wood mud sills, or
  - a 100 mm thick concrete floor slab.

#### 9.35.3.2. Protection from Damage due to Soil Movement

- 1) In clay-type *soils* subject to significant movement with a change in *soil* moisture content, the *foundation* depth of carports or garages connected to a *dwelling unit* directly or by a breezeway shall be approximately the same depth as the main *building foundation*.
- 2) Where slab-on-ground construction is used, a construction joint shall be provided between the main *building* slab and a slab serving an attached garage, breezeway or carport.
- 3) Except as provided in Section 9.12., *foundations* for attached unheated garages or carports shall be below frost level.

#### 9.35.3.3. Drainage

- 1) Detached garages of less than 55 m<sup>2</sup> *floor area* and not more than 1 *storey* in height that are not of masonry or masonry veneer construction need not conform with the *foundation* drainage requirements stated in Section 9.14., where the finished ground level is at or near the elevation of the garage's floor and where the ground slopes away from the *building*.

#### 9.35.3.4. Column Piers

- 1) Piers for the support of carport columns shall extend not less than 150 mm above ground level.
- 2) Piers referred to in Sentence (1) shall project not less than 25 mm beyond the base of the column but in no case be less than 190 mm by 190 mm in size.

### 9.35.4. Walls and Columns

#### 9.35.4.1. Interior Finish

- 1) Interior finish need not be applied to garage and carport walls.

#### 9.35.4.2. Columns

- 1) Columns for garages and carports shall conform to Section 9.17., except that 89 mm by 89 mm wood columns may be used.

#### 9.35.4.3. Anchorage

- 1) Garage or carport walls and columns shall be anchored to the *foundation* to resist wind uplift in conformance with Subsection 9.23.6., except that where a garage is supported on the surface of the ground, ground anchors shall be provided to resist wind uplift.

## Section 9.36. Energy Efficiency

### 9.36.1. General

#### 9.36.1.1. Scope

- 1) This Section is concerned with the energy used by *buildings* as a result of
  - a) the design and construction of the *building* envelope, and
  - b) the design and construction or specification of systems and equipment for
    - i) heating, ventilating or air-conditioning, and
    - ii) service water heating.

(See Note A-9.36.1.1.(1).)

#### 9.36.1.2. Definitions

1) For the purpose of this Section, the term “common space” shall mean all spaces required to be *conditioned spaces* in accordance with the requirements of the Code that are not within a *suite* but shall not include crawl spaces and *vertical service spaces*. (See Note A-9.36.1.3.(3).)

2) For the purpose of this Section, the term “overall thermal transmittance,” or U-value, shall mean the rate, in  $W/(m^2 \cdot K)$ , at which heat is transferred through a *building* assembly that is subject to temperature differences. (See Note A-9.36.1.2.(2).)

3) For the purpose of this Section, the term “effective thermal resistance,” or RSI value, shall mean the inverse of the overall thermal transmittance of an assembly, in  $(m^2 \cdot K)/W$ . (See Note A-9.36.1.2.(3).)

4) For the purpose of this Section, the term “fenestration” shall mean all *building* envelope assemblies, including their frames, that transfer visible light, such as windows, clerestories, skylights, translucent wall panels, glass block assemblies, transoms, sidelights, sliding, overhead or swinging glass doors, and glazed inserts in doors, etc. (See Note A-9.36.1.2.(4).)

#### 9.36.1.3. Compliance and Application

(See Note A-9.36.1.3.)

- 1) Except as provided in Sentences (2) to (5), *buildings* shall comply with
  - a) the prescriptive or trade-off requirements in Subsections 9.36.2. to 9.36.4.,
  - b) the performance requirements in Subsection 9.36.5., or
  - c) the NECB.
- 2) Subsections 9.36.2. to 9.36.4. apply to
  - a) *buildings* of *residential occupancy* to which Part 9 applies,
  - b) *buildings* containing *business and personal services, mercantile* or *low-hazard industrial occupancies* to which Part 9 applies whose combined total *floor area* does not exceed 300 m<sup>2</sup>, excluding parking garages that serve *residential occupancies*, and
  - c) *buildings* containing a mix of the *residential* and *non-residential occupancies* described in Clauses (a) and (b).
- 3) Subsection 9.36.5. applies only to
  - a) houses with or without a *secondary suite*, and
  - b) *buildings* containing only *dwelling units* and common spaces whose total *floor area* does not exceed 20% of the total *floor area* of the *building*.

(See Note A-9.36.1.3.(3).)

4) *Buildings* containing *non-residential occupancies* whose combined total *floor area* exceeds 300 m<sup>2</sup> or *medium-hazard industrial occupancies* shall comply with the NECB.

5) *Buildings* or portions of *buildings* that are not required to be *conditioned spaces* are exempted from the requirements of this Section. (See Note A-9.36.1.3.(5).)



**9.36.2. Building Envelope****9.36.2.1. Scope and Application**

**1)** Except as provided in Sentence (2), this Subsection is concerned with the loss of energy due to heat transfer and air leakage through materials, components and assemblies, including their interfaces, forming part of the *building* envelope where it separates *conditioned space* from unconditioned space, the exterior air or the ground.

**2)** The requirements of this Subsection also apply to components of a *building* envelope assembly that separate a *conditioned space* from an adjoining *storage garage*, even if the *storage garage* is intended to be heated. (See Notes A-9.36.2.1.(2) and A-9.36.1.3.(5).)

**3)** Except for skylight shafts addressed in Sentence 9.36.2.6.(4), for the purpose of this Subsection, wall assemblies inclined less than 60° from the horizontal shall be considered as roof assemblies, and roof assemblies inclined 60° or more from the horizontal shall be considered as wall assemblies.

**4)** The properties, performance and installation of windows, doors and skylights shall also conform to Section 9.7.

**5)** The properties, location and installation of thermal insulation, *air barrier systems*, *vapour barriers*, and materials with low air or vapour permeance shall also conform to Section 9.25.

**9.36.2.2. Determination of Thermal Characteristics of Materials, Components and Assemblies**

**1)** The thermal characteristics of materials shall be determined by calculation or by testing in accordance with the applicable product standards listed in the Code or, in the absence of such standards or where such standards do not address the determination of thermal resistance, in accordance with

- a) ASTM C 177, "Steady-State Heat Flux Measurements and Thermal Transmission Properties by Means of the Guarded-Hot-Plate Apparatus," or
- b) ASTM C 518, "Steady-State Thermal Transmission Properties by Means of the Heat Flow Meter Apparatus."

(See Table A-9.36.2.4.(1)-D for the thermal characteristics of commonly used materials.)

**2)** Calculations and tests performed in accordance with Sentence (1) shall be carried out at an average temperature of 24±2°C and under a temperature differential of 22±2°C.

**3)** The thermal characteristics of windows, doors and skylights shall be determined by calculation or testing in accordance with

- a) CSA A440.2/A440.3, "Fenestration Energy Performance/User Guide to CSA A440.2-14, Fenestration Energy Performance," for the reference sizes listed therein, or
- b) NFRC 100, "Determining Fenestration Product U-factors," and NFRC 200, "Determining Fenestration Product Solar Heat Gain Coefficient and Visible Transmittance at Normal Incidence," for the reference sizes listed therein.

(See Note A-9.36.2.2.(3).)

**4)** The effective thermal resistance of opaque *building* assemblies shall be determined from

- a) calculations conforming to Article 9.36.2.4., or
- b) laboratory tests performed in accordance with ASTM C 1363, "Thermal Performance of Building Materials and Envelope Assemblies by Means of a Hot Box Apparatus," using an indoor air temperature of 21±1°C and an outdoor air temperature of -18±1°C.

**5)** The thermal characteristics of log walls shall be determined by calculation in accordance with Section 305 of ICC 400, "Design and Construction of Log Structures." (See Note A-9.36.2.2.(5).)

**9.36.2.3. Calculation of Ceiling, Wall, Fenestration and Door Areas**

- 1)** The gross ceiling or roof area shall be calculated as the sum of the interior surface areas of insulated ceiling and/or roof assemblies and of skylight openings.
- 2)** Except as permitted by Sentence (3), the gross wall area shall be calculated as the sum of the interior surface areas of all exterior *building* envelope assemblies above the finished ground level that are inclined 60° or more from the horizontal, including
  - a) *rim joists*,
  - b) fenestration and opaque portions of doors,
  - c) insulated walls extending from finished ground level to the interior side of the insulated ceiling and/or roof assembly, and
  - d) the exposed areas of below-ground *building* envelope assemblies, where fenestration or doors are located below the plane of the adjacent finished ground.
 (See Note A-9.36.2.3.(2) and (3).)
- 3)** Where a *building* of *residential occupancy* contains more than 2 *dwelling units*, the gross wall area enclosing *conditioned space* shall be permitted to include the interior surface areas of walls that enclose a *suite*, measured from the top surface of the lowest floor to the underside of the highest ceiling in the *suite*. (See Note A-9.36.2.3.(2) and (3).)
- 4)** Fenestration and door areas shall be the actual sizes of windows, doors and skylights including all related frame and sash members.
- 5)** The fenestration area made of flat panes that are not all in the same plane or curved panes shall be measured along the surface of the glass. (See Note A-9.36.2.3.(5).)

**9.36.2.4. Calculation of Effective Thermal Resistance of Assemblies**

- 1)** In calculating the effective thermal resistance of assemblies for the purpose of comparison with the requirements of Articles 9.36.2.6. and 9.36.2.8., the thermal bridging effect of closely spaced, repetitive structural members, such as studs and joists, and of ancillary members, such as lintels, sills and plates, shall be accounted for. (See Note A-9.36.2.4.(1).)
- 2)** Minor penetrations through assemblies, such as pipes, ducts, equipment with through-the-wall venting, packaged terminal air conditioners or heat pumps, shelf angles, anchors and ties and associated fasteners, and minor structural members that must partially or completely penetrate the *building* envelope to perform their intended function need not be taken into account in the calculation of the effective thermal resistance of that assembly.
- 3)** Major structural penetrations, such as balcony and canopy slabs, beams, columns and ornamentation or appendages that must completely penetrate the *building* envelope to perform their intended function, need not be taken into account in the calculation of the effective thermal resistance of the penetrated assembly, provided
  - a) the insulation is installed tight against the outline of the penetration, and
  - b) the sum of the areas of all such major structural penetrations is limited to a maximum of 2% of the gross wall area calculated as described in Sentence 9.36.2.3.(2).
 (See Note A-9.36.2.4.(3).)
- 4)** Where a component of the *building* envelope is protected by an enclosed unconditioned space, such as a sun porch, enclosed veranda, vestibule or attached garage, the required effective thermal resistance of the *building* envelope component between the *building* and the unconditioned enclosure is permitted to be reduced by 0.16 (m<sup>2</sup>·K)/W. (See Note A-9.36.2.4.(4).)

**9.36.2.5. Continuity of Insulation**

- 1)** Except as provided in Sentences (2) to (9) and in Sentence 9.36.2.4.(3) regarding balcony and canopy slabs, and except for clearances around components required for fire safety reasons, interior *building* components that meet *building* envelope components and major structural members that partly penetrate the *building* envelope shall not break the continuity of the insulation and shall not decrease the effective

thermal resistance at their projected area to less than that required in Articles 9.36.2.6. and 9.36.2.8. (See Note A-9.36.2.5.(1).)

**2)** Where an interior wall, *foundation* wall, *firewall*, *party wall* or structural element penetrates an exterior wall or insulated roof or ceiling and breaks the continuity of the plane of insulation, the penetrating element shall be insulated

- a) on both of its sides, inward or outward from the *building* envelope, for a distance equal to 4 times its uninsulated thickness to an effective thermal resistance not less than that required for exterior walls as stated in Table 9.36.2.6.-A or 9.36.2.6.-B,
- b) within the plane of insulation of the penetrated element to an effective thermal resistance not less than 60% of that required for the penetrated element, or
- c) within itself to an effective thermal resistance not less than that required for the penetrated element.

(See Note A-9.36.2.5.(2).)

**3)** Where a masonry fireplace or flue penetrates an exterior wall and breaks the continuity of the plane of insulation, it shall be insulated within the plane of insulation of the wall or within itself to an effective thermal resistance not less than 55% of that required for the exterior wall as stated in Table 9.36.2.6.-A or 9.36.2.6.-B (See Note A-9.36.2.5.(3).)

**4)** Where an ornamentation or appendage penetrates an exterior wall and breaks the continuity of the plane of insulation, the penetrating element shall be insulated

- a) on both of its sides, inward or outward from the *building* envelope, for a distance equal to 4 times the insulated thickness of the exterior wall to an effective thermal resistance not less than that required for the wall as stated in Table 9.36.2.6.-A or 9.36.2.6.-B,
- b) within the plane of insulation of the wall to an effective thermal resistance not less than 55% of that required for the exterior wall, or
- c) within the penetrating element to an effective thermal resistance not less than that required for the exterior wall.

**5)** Except as provided in Sentences (8) and (9), where two planes of insulation are separated by a *building* envelope assembly and cannot be physically joined, one of the planes of insulation shall be extended for a distance equal to at least 4 times the thickness of the assembly separating the two planes. (See Note A-9.36.2.5.(5).)

**6)** Where mechanical, plumbing or electrical system components, such as pipes, ducts, conduits, cabinets, chases, panels or recessed heaters, are placed within and parallel to a wall assembly required to be insulated, the effective thermal resistance of that wall at the projected area of the system component shall be not less than that required by Tables 9.36.2.6.-A, 9.36.2.6.-B, 9.36.2.8.-A and 9.36.2.8.-B (See Note A-9.36.2.5.(6).)

**7)** Except as permitted by Article 9.36.2.11., where mechanical ducts, plumbing pipes, conduits for electrical services or communication cables are placed within the insulated portion of a floor or ceiling assembly, the effective thermal resistance of the assembly at the projected area of the ducts, pipes, conduits or cables shall be not less than  $2.78 \text{ (m}^2\text{-K)/W}$ .

**8)** Joints and junctions between walls and other *building* envelope components shall be insulated in a manner that provides an effective thermal resistance that is no less than the lower of the minimum values required for the respective adjoining components. (See Note A-9.36.2.5.(8).)

**9)** Sentence (1) does not apply where the continuity of the insulation is interrupted

- a) between the insulation in the *foundation* wall and that of the floor slab,
- b) by an integral perimeter footing of a slab-on-grade (see Sentences 9.25.2.3.(5) and 9.36.2.8.(8)), or
- c) at the horizontal portion of a *foundation* wall that supports masonry veneer and is insulated on the exterior.

**9.36.2.6. Thermal Characteristics of Above-ground Opaque Building Assemblies**

**1)** Except as provided in Sentences (2) and 9.36.2.8.(3) and Articles 9.36.2.5. and 9.36.2.11., the effective thermal resistance of above-ground opaque *building* assemblies or portions thereof shall be not less than that shown for the applicable heating-degree day category in

- a) Table 9.36.2.6.-A, where the ventilation system does not include heat-recovery equipment, or
  - b) Table 9.36.2.6.-B, where the ventilation system includes heat-recovery equipment conforming to Article 9.36.3.9.
- (See Note A-9.36.2.6.(1).)

**Table 9.36.2.6.-A**  
**Effective Thermal Resistance of Above-ground Opaque Assemblies in Buildings without a Heat-Recovery Ventilator**  
 Forming Part of Sentence 9.36.2.6.(1)

Above-ground Opaque <i>Building</i> Assembly	Heating Degree-Days of <i>Building</i> Location, <sup>(1)</sup> in Celsius Degree-Days					
	Zone 4 < 3000	Zone 5 3000 to 3999	Zone 6 4000 to 4999	Zone 7A 5000 to 5999	Zone 7B 6000 to 6999	Zone 8 ≥ 7000
	Minimum Effective Thermal Resistance (RSI), (m <sup>2</sup> ·K)/W					
Ceilings below attics	6.91	8.67	8.67	10.43	10.43	10.43
Cathedral ceilings and flat roofs	4.67	4.67	4.67	5.02	5.02	5.02
Walls <sup>(2)</sup>	2.78	3.08	3.08	3.08	3.85	3.85
Floors over unheated spaces	4.67	4.67	4.67	5.02	5.02	5.02

**Notes to Table 9.36.2.6.-A:**

- (1) See Article 1.1.3.1.
- (2) See Sentence 9.36.2.8.(3) for requirements concerning the above-ground portion of *foundation* walls.

**Table 9.36.2.6.-B**  
**Effective Thermal Resistance of Above-ground Opaque Assemblies in Buildings with a Heat-Recovery Ventilator**  
 Forming Part of Sentence 9.36.2.6.(1)

Above-ground Opaque <i>Building</i> Assembly	Heating Degree-Days of <i>Building</i> Location, <sup>(1)</sup> in Celsius Degree-Days					
	Zone 4 < 3000	Zone 5 3000 to 3999	Zone 6 4000 to 4999	Zone 7A 5000 to 5999	Zone 7B 6000 to 6999	Zone 8 ≥ 7000
	Minimum Effective Thermal Resistance (RSI), (m <sup>2</sup> ·K)/W					
Ceilings below attics	6.91	6.91	8.67	8.67	10.43	10.43
Cathedral ceilings and flat roofs	4.67	4.67	4.67	5.02	5.02	5.02
Walls <sup>(2)</sup>	2.78	2.97	2.97	2.97	3.08	3.08
Floors over unheated spaces	4.67	4.67	4.67	5.02	5.02	5.02

**Notes to Table 9.36.2.6.-B:**

- (1) See Article 1.1.3.1.
- (2) See Sentence 9.36.2.8.(3) for requirements concerning the above-ground portion of *foundation* walls.

**2)** The effective thermal resistance of *rim joists* shall be not less than that required for above-ground walls in Table 9.36.2.6.-A or 9.36.2.6.-B, as applicable.

**3)** A reduction in the effective thermal resistance of ceiling assemblies in attics under sloped roofs is permitted for a length no greater than 1 200 mm but only to the extent imposed by the roof slope and minimum venting clearance, provided the nominal thermal resistance of the insulation directly above the exterior wall is not less than 3.52 (m<sup>2</sup>·K)/W. (See Note A-9.36.2.6.(3).)

**4)** Except for tubular daylighting devices, the minimum effective thermal resistance values for walls stated in Tables 9.36.2.6.-A and 9.36.2.6.-B shall also apply to shafts for skylights.

**9.36.2.7. Thermal Characteristics of Fenestration, Doors and Skylights**

**1)** Except as provided in Sentences (2) to (8) and Article 9.36.2.11., fenestration and doors shall have an overall thermal transmittance (U-value) not greater than, or an Energy Rating not less than, the values listed in Table 9.36.2.7.-A for the applicable heating-degree day category. (See Note A-9.36.2.7.(1) and (2).)

**Table 9.36.2.7.-A  
Required Thermal Characteristics of Fenestration and Doors  
Forming Part of Sentence 9.36.2.7.(1)**

Components	Thermal Characteristics <sup>(1)</sup>	Heating Degree-Days of <i>Building Location</i> , <sup>(2)</sup> in Celsius Degree-Days					
		Zone 4 < 3000	Zone 5 3000 to 3999	Zone 6 4000 to 4999	Zone 7A 5000 to 5999	Zone 7B 6000 to 6999	Zone 8 ≥ 7000
Fenestration <sup>(3)</sup> and doors	Max. U-value, W/(m <sup>2</sup> ·K)	1.80	1.80	1.60	1.60	1.40	1.40
	Min. Energy Rating	21	21	25	25	29	29

**Notes to Table 9.36.2.7.-A:**

- (1) See Note A-Table 9.36.2.7.-A.
- (2) See Article 1.1.3.1.
- (3) Except skylights (see Sentence (2)) and glass block assemblies (see Sentence (4)).

**2)** Skylights shall have an overall thermal transmittance not greater than the values listed in Table 9.36.2.7.-B for the applicable heating-degree day category. (See Note A-9.36.2.7.(1) and (2).)

**Table 9.36.2.7.-B  
Overall Thermal Transmittance of Skylights  
Forming Part of Sentence 9.36.2.7.(2)**

Component	Heating Degree-Days of <i>Building Location</i> , <sup>(1)</sup> in Celsius Degree-Days					
	Zone 4 < 3000	Zone 5 3000 to 3999	Zone 6 4000 to 4999	Zone 7A 5000 to 5999	Zone 7B 6000 to 6999	Zone 8 ≥ 7000
	Maximum Overall Thermal Transmittance, W/(m <sup>2</sup> ·K)					
Skylights	2.90	2.90	2.70	2.70	2.40	2.40

**Notes to Table 9.36.2.7.-B:**

- (1) See Article 1.1.3.1.

**3)** Except for site-assembled or site-glazed factory-made fenestration products, curtain wall construction, and site-built windows and glazed doors that are tested in accordance with Sentence 9.36.2.2.(3), site-built windows and glazed doors need not comply with Sentence (1), provided they are constructed in accordance with one of the options presented in Table 9.36.2.7.-C for the applicable climate zone. (See Note A-9.36.2.7.(3).)

**Table 9.36.2.7.-C**  
**Compliance Options for Site-built Windows and Glazed Portion of Doors**  
 Forming Part of Sentence 9.36.2.7.(3)

Component	Description of Component	Compliance Options							
		Climate Zones 4 and 5 ≤ 3999 HDD			Climate Zones 6 and 7A 4000 to 5999 HDD			Climate Zones 7B and 8 ≥ 6000 HDD	
		1	2	3	1	2	3	1	2
Frame	non-metallic	✓	✓	—	✓	✓	—	✓	✓
	thermally broken metallic	—	—	✓	—	—	✓	—	—
Glazing	double	—	✓	—	—	—	—	—	—
	triple	✓	—	✓	✓	✓	✓	✓	✓
	argon-filled	—	✓	—	✓	—	✓	—	✓
Low-e coating	none	✓	—	—	—	—	—	—	—
	number of panes with ≤ 0.10	—	≥ 1	—	—	—	—	≥ 2	—
	number of panes with ≤ 0.20	—	—	2	≥ 1	2	≥ 2	—	≥ 2
Spacer	size, mm	12.7	—	12.7	≥ 12.7	12.7	≥ 12.7	≥ 12.7	≥ 12.7
	non-metallic	—	✓	—	—	—	—	—	—

**4)** Glass block assemblies separating *conditioned space* from unconditioned space or the exterior shall have

- an overall thermal transmittance of not more than 2.9 W/(m<sup>2</sup>·K), and
- a total aggregate area of not more than 1.85 m<sup>2</sup>.

**5)** One door separating a *conditioned space* from an unconditioned space or the exterior is permitted to have an overall thermal transmittance up to 2.6 W/(m<sup>2</sup>·K).

**6)** Storm windows and doors need not comply with Sentence (1).

**7)** Vehicular access doors separating a *conditioned space* from an unconditioned space or the exterior shall have a nominal thermal resistance of not less than 1.1 (m<sup>2</sup>·K)/W.

**8)** Access hatches separating a *conditioned space* from an unconditioned space shall be insulated to a nominal thermal resistance of not less than 2.6 (m<sup>2</sup>·K)/W.

### 9.36.2.8. Thermal Characteristics of Building Assemblies Below-Grade or in Contact with the Ground

**1)** Except as provided in Sentence (2) and Article 9.36.2.5., the effective thermal resistance of *building* assemblies that are below-grade or in contact with the ground shall be not less than that shown for the applicable heating-degree day category in

- Table 9.36.2.8.-A, where the ventilation system does not include heat-recovery equipment, or
- Table 9.36.2.8.-B, where the ventilation system includes heat-recovery equipment conforming to Article 9.36.3.9.

(See Note A-9.36.2.8.(1).)

**Table 9.36.2.8.-A**  
**Effective Thermal Resistance of Assemblies Below-Grade or in Contact with the Ground in Buildings without a Heat-Recovery Ventilator**  
 Forming Part of Sentences 9.36.2.8.(1) to (9)

Building Assembly Below-Grade or in Contact with the Ground <sup>(1)</sup>	Heating Degree-Days of Building Location, <sup>(2)</sup> in Celsius Degree-Days					
	Zone 4 < 3000	Zone 5 3000 to 3999	Zone 6 4000 to 4999	Zone 7A 5000 to 5999	Zone 7B 6000 to 6999	Zone 8 ≥ 7000
	Minimum Effective Thermal Resistance (RSI), (m <sup>2</sup> -K)/W					
Foundation walls	1.99	2.98	2.98	3.46	3.46	3.97
Unheated floors <sup>(3)</sup>						
below frost line <sup>(4)(5)</sup>	uninsulated	uninsulated	uninsulated	uninsulated	uninsulated	uninsulated
above frost line <sup>(5)</sup>	1.96	1.96	1.96	1.96	1.96	1.96
Heated and unheated floors on permafrost	n/a	n/a	n/a	n/a	4.44	4.44
Heated floors <sup>(6)</sup>	2.32	2.32	2.32	2.84	2.84	2.84
Slabs-on-grade with an integral footing <sup>(6)</sup>	1.96	1.96	1.96	3.72	3.72	4.59

**Notes to Table 9.36.2.8.-A:**

- (1) See Note A-Tables 9.36.2.8.-A and -B.
- (2) See Article 1.1.3.1.
- (3) Does not apply to below-grade floors over heated crawl spaces.
- (4) Typically applies to floors-on-ground in full-height *basements*.
- (5) Refers to undisturbed frost line before house is constructed.
- (6) See Sentence 9.25.2.3.(5) for requirement on placement of insulation. The design of slabs-on-grade with an integral footing is addressed in Part 4 (see Article 9.16.1.2.).

**Table 9.36.2.8.-B**  
**Effective Thermal Resistance of Assemblies Below-Grade or in Contact with the Ground in Buildings with a Heat-Recovery Ventilator**  
 Forming Part of Sentences 9.36.2.8.(1) to (9)

Building Assembly Below-Grade or in Contact with the Ground <sup>(1)</sup>	Heating Degree-Days of Building Location, <sup>(2)</sup> in Celsius Degree-Days					
	Zone 4 < 3000	Zone 5 3000 to 3999	Zone 6 4000 to 4999	Zone 7A 5000 to 5999	Zone 7B 6000 to 6999	Zone 8 ≥ 7000
	Minimum Effective Thermal Resistance (RSI), (m <sup>2</sup> -K)/W					
Foundation walls	1.99	2.98	2.98	2.98	2.98	2.98
Unheated floors <sup>(3)</sup>						
below frost line <sup>(4)(5)</sup>	uninsulated	uninsulated	uninsulated	uninsulated	uninsulated	uninsulated
above frost line <sup>(5)</sup>	1.96	1.96	1.96	1.96	1.96	1.96
Heated and unheated floors on permafrost	n/a	n/a	n/a	n/a	4.44	4.44
Heated floors <sup>(6)</sup>	2.32	2.32	2.32	2.84	2.84	2.84
Slabs-on-grade with an integral footing <sup>(6)</sup>	1.96	1.96	1.96	2.84	2.84	3.72

**Notes to Table 9.36.2.8.-B:**

- (1) See Note A-Tables 9.36.2.8.-A and -B.
- (2) See Article 1.1.3.1.
- (3) Does not apply to below-grade floors over heated crawl spaces.
- (4) Typically applies to floors-on-ground in full-height *basements*.
- (5) Refers to undisturbed frost line before house is constructed.
- (6) See Sentence 9.25.2.3.(5) for requirement on placement of insulation. The design of slabs-on-grade with an integral footing is addressed in Part 4 (see Article 9.16.1.2.).

**2)** Where an entire floor assembly falls into two of the categories listed in Tables 9.36.2.8.-A and 9.36.2.8.-B, the more stringent value shall apply. (See Note A-9.36.2.8.(2).)

**3)** Where the top of a section of *foundation* wall is on average less than 600 mm above the adjoining ground level, the above-ground portion of that section of wall shall be insulated to the effective thermal resistance required in Table 9.36.2.8.-A or 9.36.2.8.-B.

**4)** Unheated floors-on-ground that are above the frost line and have no embedded heating pipes, cables or ducts shall be insulated to the effective thermal resistance required in Table 9.36.2.8.-A or 9.36.2.8.-B

- a) on the exterior of the *foundation* wall down to the footing, or
- b) on the interior of the *foundation* wall and, as applicable,
  - i) beneath the slab for a distance not less than 1.2 m horizontally or vertically down from its perimeter with a thermal break along the edge of the slab that meets at least 50% of the required thermal resistance,
  - ii) on top of the slab for a distance not less than 1.2 m horizontally from its perimeter, or
  - iii) within the wooden sleepers below the floor for a distance not less than 1.2 m horizontally from its perimeter.

(See Note A-9.36.2.8.(4).)

**5)** Except as provided in Sentence (6), floors-on-ground with embedded heating ducts, cables or pipes shall be insulated to the effective thermal resistance required in Table 9.36.2.8.-A or 9.36.2.8.-B under their full bottom surface including the edges.

**6)** Where only a portion of a floor-on-ground has embedded heating ducts, cables or pipes, that heated portion shall be insulated to the effective thermal resistance required in Table 9.36.2.8.-A or 9.36.2.8.-B under its full bottom surface to 1.2 m beyond its perimeter including exterior edges if applicable.

**7)** In addition to the requirements stated in Sentences (5) and (6), heated floors-on-ground shall be insulated to the effective thermal resistance required in Table 9.36.2.8.-A or 9.36.2.8.-B vertically

- a) around their perimeter, or
- b) on the outside of the *foundation* wall, extending down to the level of the bottom of the floor.

**8)** Floors on permafrost shall be insulated to the effective thermal resistance required in Table 9.36.2.8.-A or 9.36.2.8.-B under the entire slab and around all edges, and under the integral perimeter footing.

**9)** Slabs-on-grade with an integral perimeter footing shall

- a) be insulated to the effective thermal resistance required in Table 9.36.2.8.-A or 9.36.2.8.-B under the entire slab and around all edges, but not under the integral perimeter footing, and
- b) be constructed with skirt insulation having the same effective thermal resistance as the insulation installed under the slab.

(See Note A-9.36.2.8.(9).) (See also Sentences 9.25.2.3.(5) and 9.36.2.5.(8).)

**10)** Junctions between below-*grade* assemblies shall be protected from the ingress of *soil* gas in conformance with Subsection 9.25.3.

### 9.36.2.9. Airtightness

**1)** The leakage of air into and out of *conditioned spaces* shall be controlled by constructing

- a) a continuous *air barrier system* in accordance with Sentences (2) to (6), Subsection 9.25.3. and Article 9.36.2.10.,
- b) a continuous *air barrier system* in accordance with Sentences (2) to (6) and Subsection 9.25.3. and a *building* assembly having an air leakage rate not greater than 0.20 L/(s·m<sup>2</sup>) (Type A4) when tested in accordance with



CAN/ULC-S742, "Air Barrier Assemblies – Specification," at a pressure differential of 75 Pa, or

- c) a continuous *air barrier system* in accordance with Sentences (2) to (6) and Subsection 9.25.3. and a *building* assembly having an air leakage rate not greater than 0.20 L/(s·m<sup>2</sup>) when tested in accordance with ASTM E 2357, "Determining Air Leakage of Air Barrier Assemblies," where
  - i) the *building* will not be subjected to sustained wind loads calculated based on a 1-in-50 hourly wind pressure that exceed 0.65 kPa, and
  - ii) the air barrier assembly is installed on the warm side of the thermal insulation of the opaque *building* assembly.

(See Note A-9.36.2.9.(1).)

**2)** An *air barrier system* installed to meet the requirements of Sentence (1) shall be continuous

- a) across construction, control and expansion joints,
- b) across junctions between different *building* materials and assemblies, and
- c) around penetrations through all *building* assemblies.

**3)** Windows, doors and skylights and their components shall comply with the minimum air leakage requirements stated in

- a) AAMA/WDMA/CSA 101/I.S.2/A440, "NAFS – North American Fenestration Standard/Specification for Windows, Doors, and Skylights" (Harmonized Standard), and
- b) CSA A440S1, "Canadian Supplement to AAMA/WDMA/CSA 101/I.S.2/A440, NAFS – North American Fenestration Standard/Specification for Windows, Doors, and Skylights."

**4)** Vehicular access doors that separate heated garages from unconditioned spaces or the exterior shall be weatherstripped around their perimeter to prevent air leakage.

**5)** Fireplaces shall be equipped with doors, enclosures or devices to restrict air movement through the *chimney* when the fireplace is not in use. (See Note A-9.36.2.9.(5).)

**6)** Where the airtight material used in the *air barrier system* is installed toward the exterior of the *building* envelope, its location and properties shall conform to Subsection 9.25.5. (See Note A-9.36.2.9.(6).)

### 9.36.2.10. Construction of Air Barrier Details

**1)** Materials intended to provide the principal resistance to air leakage shall conform to CAN/ULC-S741, "Air Barrier Materials – Specification." (See Note A-9.25.5.1.(1) for air leakage characteristics and water vapour permeance values for a number of common materials.)

- 2)** Materials referred to in Sentence (1) shall be
- a) compatible with adjoining materials, and
  - b) free of holes and cracks.

(See Note A-9.36.2.10.(5)(b).)

**3)** Where the *air barrier system* consists of rigid panel-type material, all joints shall be sealed. (See Note A-9.36.2.10.(5)(b).)

**4)** Where the *air barrier system* consists of timber logs, all joints shall be sealed to resist airflow through gaps between logs that have shifted due to in-service conditions such as shrinkage and settling.

- 5)** Where the *air barrier system* consists of flexible sheet material, all joints shall be
- a) lapped not less than 50 mm,
  - b) sealed (see Note A-9.36.2.10.(5)(b)), and
  - c) structurally supported.

- 6) Sealant material used for the purpose of creating a continuous *air barrier system* shall
- a) be a non-hardening type, or
  - b) conform to
    - i) Subsection 9.27.4.,
    - ii) CAN/ULC-S710.1, "Thermal Insulation – Bead-Applied One Component Polyurethane Air Sealant Foam, Part 1: Material Specification," or
    - iii) CAN/ULC-S711.1, "Thermal Insulation – Bead-Applied Two Component Polyurethane Air Sealant Foam, Part 1: Material Specification."
- 7) Penetrations by electrical wiring, outlets, switches or recessed light fixtures through the plane of airtightness shall be constructed airtight
- a) where the component is designed to provide a seal against air leakage, by sealing the component to the air barrier material (see Note A-9.36.2.10.(7)(a)), or
  - b) where the component is not designed to provide a seal against air leakage, by covering the component with an air barrier material and sealing it to the adjacent air barrier material.
- 8) The joints between the *foundation* wall and the sill plate, between the sill plate and *rim joist*, between the *rim joist* and the subfloor material, and between the subfloor material and the bottom plate of the wall above shall be constructed airtight by
- a) sealing all joints and junctions between the structural components, or
  - b) covering the structural components with an air barrier material and sealing it to the adjacent air barrier material.
- 9) The interfaces between windows, doors and skylights and wall/ceiling assemblies shall be constructed airtight by sealing all joints and junctions between the air barrier material in the wall and the window, door or skylight frame. (See Note A-9.36.2.10.(9).) (See also Subsection 9.7.6.)
- 10) Cantilevered floors and floors over unheated spaces or over the exterior shall be constructed airtight by one of the following methods or a combination thereof:
- a) sealing all joints and junctions between the structural components, or
  - b) covering the structural components with an air barrier material and sealing it to the adjacent air barrier material.
- 11) Interior walls that meet exterior walls or ceilings whose plane of airtightness is on the interior of the *building* envelope and knee walls that separate *conditioned space* from unconditioned space shall be constructed airtight by
- a) sealing all junctions between the structural components,
  - b) covering the structural components with an air barrier material and sealing it to the adjacent air barrier material, or
  - c) maintaining the continuity of the *air barrier system* above or through the interior wall or below or through the knee wall, as applicable.
- 12) Steel-lined *chimneys* that penetrate the *building* envelope shall be constructed airtight by blocking the void between required clearances for metal *chimneys* and surrounding construction with sheet metal and sealant capable of withstanding high temperatures.
- 13) *Masonry or concrete chimneys* that penetrate the *building* envelope shall be constructed airtight by mechanically fastening a metal flange or steel stud that extends not less than 75 mm out from the *chimney* and sealing the air barrier material to it with a sealant capable of withstanding high temperatures.
- 14) Ducts that penetrate the *building* envelope shall be constructed airtight by sealing the penetration through the *building* envelope. (See Note A-9.36.2.10.(14).)

**15)** Plumbing vent stack pipes that penetrate the *building* envelope shall be constructed airtight by

- a) sealing the air barrier material to the vent stack pipe with a compatible sealant or sheathing tape, or
- b) installing a rubber gasket or prefabricated roof flashing at the penetration of the plane of airtightness then sealing it and mechanically fastening it to the top plate.

**16)** Where a *party wall* meets the plane of airtightness, that junction shall be constructed airtight by sealing any voids within the *party wall* at the perimeter to the adjacent air barrier material and by

- a) sealing all junctions between the structural components, or
- b) covering the structural components with an air barrier material and sealing it to the adjacent air barrier material.

**17)** Where the concrete in a flat insulating concrete form wall acts as the air barrier, the continuity of the plane of airtightness shall be maintained between the concrete and adjacent air barrier materials.

### 9.36.2.11. Trade-off Options for Above-ground Building Envelope Components and Assemblies

(See Note A-9.36.2.11.)

**1)** Subject to the limitations stated in Sentences (6) to (8), the trade-off options described in Sentences (2) to (4) apply only to above-ground *building* envelope components and assemblies, or portions thereof, of a single *building*.

**2)** The effective thermal resistance of one or more above-ground opaque *building* envelope assemblies is permitted to be less than that required in Article 9.36.2.6., provided

- a) the total areas of all proposed and reference assemblies are equal,
- b) the effective thermal resistance of one or more other proposed above-ground opaque *building* envelope assembly areas is increased to more than that required by Article 9.36.2.6., and
- c) the sum of the areas of all traded above-ground opaque *building* envelope assemblies divided by their respective effective thermal resistance is less than or equal to what it would be if all assemblies complied with Article 9.36.2.6.

(See Notes A-9.36.2.11.(2) and A-9.36.2.11.(2) and (3).)

**3)** The effective thermal resistance of one or more windows, as calculated in accordance with Sentence (5), is permitted to be less than that required in Article 9.36.2.7., provided

- a) the total areas of all traded windows are equal,
- b) the traded windows are located in the same orientation,
- c) the effective thermal resistance of one or more other windows is increased to more than that required by Article 9.36.2.7., and
- d) the sum of the areas of all traded windows divided by their respective effective thermal resistance is less than or equal to what it would be if all windows complied with Article 9.36.2.7.

(See Notes A-9.36.2.11.(3) and A-9.36.2.11.(2) and (3).)

**4)** The effective thermal resistance of one or more portions of floor insulation or ceiling insulation in attics under sloped roofs in *buildings* that are one *storey* in *building height* is permitted to be less than that required in Article 9.36.2.6., provided

- a) the total area of fenestration, excluding skylights, and doors does not exceed 15% of the above-ground gross wall area as calculated in accordance with Article 9.36.2.3.,
- b) the floor-to-ceiling height measured from the top of the subfloor to the underside of the finished ceiling of the *storey* does not exceed 2.34 m,
- c) the distance measured from the top of the subfloor to the underside of the bottom chord of the truss or joist of the roof is not more than 2.39 m, and
- d) the difference between the sum of the proposed areas of ceilings or floors divided by their respective proposed effective thermal resistance

and the sum of the reference areas of ceilings or floors divided by their respective thermal resistance required in Article 9.36.2.6. is not more than the difference between 17% fenestration and door area and the proposed fenestration and door areas divided by the required effective thermal resistance values for windows and doors in Article 9.36.2.7.

(See Notes A-9.36.2.11.(4) and A-9.36.2.11.(2) and (3).)

**5)** The effective thermal resistance of windows shall be determined using one of the following equations, as applicable:

- a)  $RSI = 1/U$ , where the U-value is known, or
- b)  $RSI = 20/(57-ER)$ , where the energy rating is known.

**6)** The reduction in effective thermal resistance of above-ground opaque *building* envelope assemblies permitted by Sentences (2) and (4) shall result in an RSI value that is not less than

- a) 55% of that required in Article 9.36.2.6. for above-ground walls and joist-type roofs (see Note A-9.36.2.11.(6)(a)), and
- b) 60% of that required in Article 9.36.2.6. for other opaque assemblies.

**7)** The effective thermal resistances of above-ground opaque assemblies with embedded heating cables, pipes or membranes are not permitted to be traded.

**8)** The effective thermal resistances of doors and access hatches described in Sentences 9.36.2.7.(3) to (7) are not permitted to be traded.

### 9.36.3. HVAC Requirements

#### 9.36.3.1. Scope and Application

**1)** This Subsection is concerned with the efficient use of energy by systems and equipment used for heating, ventilating and air-conditioning (HVAC).

**2)** Where HVAC systems, equipment or techniques other than those described in this Subsection are used, the *building* shall be designed and constructed in accordance with the energy efficiency requirements of the NECB.

#### 9.36.3.2. Equipment and Ducts

**1)** HVAC systems shall be sized in accordance with good practice as described in Sections 9.32. and 9.33. (See Note A-9.36.3.2.(1).)

**2)** Ducts shall be designed and installed in accordance with Sections 9.32. and 9.33. (See Note A-9.36.3.2.(2).)

**3)** Except for *exhaust ducts* leading directly to the exterior, ducts and *plenums* carrying conditioned air and located outside the plane of insulation shall

- a) except as provided in Sentence (4), have all joints sealed against air infiltration and exfiltration with
  - i) sealants or gaskets made from liquids, mastics or heat-applied materials,
  - ii) mastic with embedded fabric, or
  - iii) foil-faced butyl tape, and
- b) except as provided in Sentence (5), be insulated to the same level as required in Subsection 9.36.2. for exterior above-ground walls.

**4)** Fabric-backed tape with rubber adhesives shall not be used as a primary sealant to meet the requirements of Clause (3)(a).

**5)** The underside of rectangular ducts installed under an insulated floor over an unconditioned space is permitted to be insulated to a lower level than required in Sentence (3) but not to less than 2.11 (m<sup>2</sup>·K)/W, provided both sides of such ducts are insulated to a compensating higher thermal resistance so that the resulting heat loss does not exceed that of ducts complying with Sentence (3). (See Note A-9.36.3.2.(5).)

**9.36.3.3. Air Intake and Outlet Dampers**

**1)** Except as provided in Sentences (3) and (4), every duct or opening intended to discharge air to the outdoors shall be equipped with

- a) a motorized damper, or
- b) a gravity- or spring-operated backflow damper.

**2)** Except as provided in Sentences (3) and (4) and except in locations with fewer than 3500 heating degree-days as listed in Appendix C, every outdoor air intake duct or opening shall be equipped with a motorized damper that remains in the “open” position if the damper fails.

**3)** Where other regulations are in effect that do not permit dampers, air intakes and outlets need not comply with Sentences (1) and (2).

**4)** Air intakes and outlets serving HVAC systems that are required to operate continuously need not comply with Sentences (1) and (2). (See Note A-9.36.3.3.(4).)

**9.36.3.4. Piping for Heating and Cooling Systems**

**1)** Piping for heating and cooling systems shall be designed and installed in accordance with Subsection 9.33.8. (See Note A-9.36.2.10.(5)(b).)

**2)** Except for high-temperature refrigerant piping, all piping forming part of a heating or air-conditioning system shall be located

- a) inside the plane of insulation, or
- b) within or outside the plane of insulation, provided the piping is insulated to a thermal resistance not less than that required in Subsection 9.36.2. for exterior above-ground walls.

(See Note A-9.36.3.4.(2).)

**9.36.3.5. Equipment for Heating and Air-conditioning Systems**

**1)** Equipment for heating and air-conditioning systems shall be located

- a) inside the plane of insulation, or
- b) outdoors or in an unconditioned space, provided the equipment is designated by the manufacturer for such installation.

(See Note A-9.36.3.5.(1).)

**9.36.3.6. Temperature Controls**

**1)** Except for manually fuelled solid-fuel-fired *appliances*, the supply of heating and cooling energy to each *dwelling unit, suite* or common space shall be controlled by thermostatic controls that activate the appropriate supply when the temperature in a *conditioned space* fluctuates  $\pm 0.5^{\circ}\text{C}$  from the set-point temperature for that space.

**2)** Where heating and cooling systems are controlled by separate thermostatic controls, means shall be provided to prevent these controls from simultaneously calling for heating and cooling.

**3)** Space temperature control devices used to control unitary electric resistance *space heaters* shall conform to CSA C828, “Thermostats Used with Individual Room Electric Space Heating Devices.”

**4)** Controls required by Sentence (1) shall be designed such that lowering the set-point temperature on the thermostat for the heating system will not cause cooling energy to be expended to reach the lowered setting, and raising the set-point temperature on the thermostat for the cooling system will not cause heating energy to be expended to reach the raised setting.

**5)** Automatic devices or manually operated dampers, valves or switches shall be provided, as appropriate for the heating system used, to allow the heating of each zone to be adjusted.

**6)** Heat pumps equipped with supplementary heaters shall incorporate controls to prevent supplementary heater operation when the heating load can be met by the heat pump alone, except during defrost cycles.

7) Heat pumps with a programmable thermostat shall be equipped with setback controls that will temporarily suppress electrical back-up or adaptive anticipation of the recovery point, in order to prevent the activation of supplementary heat during the heat pump's recovery. (See Note A-9.36.3.6.(7).)

#### 9.36.3.7. Humidification

1) Where an HVAC system is equipped with a means for adding moisture to maintain specific humidity levels, an automatic humidity control device shall be provided.

#### 9.36.3.8. Heat Recovery from Dehumidification in Spaces with an Indoor Pool or Hot Tub

(See Note A-9.36.3.8.)

1) Except as provided in Sentences (2) and (3), spaces containing an indoor pool or hot tub shall be equipped with air exhaust systems conforming to Sentence (4) at design conditions. (See also Article 9.25.4.2.)

2) Spaces containing an indoor pool need not comply with Sentence (1), provided a stationary mechanical or desiccant dehumidification system is installed that provides at least 80% of the dehumidification that would result from compliance with Sentence (1).

3) Spaces containing an indoor pool or hot tub having a total water surface area of less than 10 m<sup>2</sup> need not comply with Sentence (1), provided they are equipped with a cover having a nominal thermal resistance not less than 2.1 (m<sup>2</sup>·K)/W.

4) Heat-recovery systems used to meet the requirements of Sentence (1) shall

- a) be capable of recovering at least 40% of the sensible heat from exhausted air when tested in accordance with AHRI 1060 (I-P), "Performance Rating of Air-to-Air Exchangers for Energy Recovery Ventilation Equipment," (see Note A-9.36.3.8.(4)(a)), or
- b) have a sensible-heat-recovery efficiency complying with Sentence 9.36.3.9.(3) when tested in accordance with CAN/CSA-C439, "Rating the Performance of Heat/Energy-Recovery Ventilators."

5) The sensible heat, in kW, referred to in Clause (4)(a), which is the sensible heat content of the total quantity of exhausted air, shall be calculated as follows:

$$\text{Sensible Heat} = 0.00123 \cdot Q \cdot (T_e - T_o)$$

where

$T_e$  = temperature of exhausted air before heat recovery, in °C,

$T_o$  = outdoor 2.5% January design temperature as listed in Appendix C, in °C,  
and

$Q$  = rated capacity of exhaust system at normal temperature of exhausted air, in L/s.

#### 9.36.3.9. Heat Recovery from Ventilation Systems

1) This Article applies where a self-contained mechanical ventilation system is installed whose principal exhaust component is equipped with heat-recovery capability. (See Note A-9.36.3.9.(1).)

2) Where an integrated mechanical system (IMS) with a heat-recovery ventilator provides the principal exhaust ventilation, the IMS shall

- a) be tested in accordance with CSA P.10, "Performance of Integrated Mechanical Systems for Residential Heating and Ventilation," and
- b) have a minimum overall thermal performance factor conforming to Table 9.36.3.10.

3) When tested in conformance with the low-temperature thermal and ventilation test methods described in CAN/CSA-C439, "Rating the Performance of

Heat/Energy-Recovery Ventilators," heat-recovery ventilators described in Sentence (1) shall have a sensible heat-recovery efficiency of

- a) at least 60% at an outside air test temperature of 0°C for locations with a 2.5% January design temperature greater than or equal to -10°C, and
- b) at least 60% at an outside air test temperature of 0°C and at least 55% at an outside air test temperature of -25°C for locations with a 2.5% January design temperature less than -10°C.

(See Note A-9.36.3.9.(3).)

**4)** The requirements of Sentence (3) shall be met using a principal ventilation rate not less than that required in Section 9.32. (See Note A-9.36.3.9.(3).)

**9.36.3.10. Equipment Efficiency**

**1)** HVAC equipment and components shall comply with the performance requirements stated in Table 9.36.3.10. (See Note A-9.36.3.10.(1).)

**Table 9.36.3.10.**  
**HVAC Equipment Performance Requirements**  
Forming Part of Sentences 9.36.3.9.(2) and 9.36.3.10.(1)

Component or Equipment	Heating or Cooling Capacity, kW	Standard	Minimum Performance <sup>(1)</sup>
<b>Air-Cooled Unitary Air Conditioners and Heat Pumps – Electrically Operated</b>			
Split system	≤ 19	CSA C656	SEER = 14.5 EER = 11.5 HSPF = 7.1 (region 5 in standard)
Single-package system	≤ 19	CSA C656 (including General Instruction No. 2)	SEER = 14 EER = 11 HSPF = 7.0 (region 5 in standard)
All systems	> 19	CAN/CSA-C746	See Level 2 in standard
<b>Water-Cooled Unitary Air Conditioners and Heat Pumps – Electrically Operated</b>			
Ground-source and water-source heat pumps			
open loop	< 40	CAN/CSA-C13256-1	COP <sub>c</sub> ≥ 4.75, COP <sub>h</sub> ≥ 3.6
closed loop			COP <sub>c</sub> ≥ 3.93, COP <sub>h</sub> ≥ 3.1
Water-to-water heat pumps			
open loop	< 40	CAN/CSA-C13256-2	COP <sub>c</sub> ≥ 5.60, COP <sub>h</sub> ≥ 3.4
closed loop			COP <sub>c</sub> ≥ 4.21, COP <sub>h</sub> ≥ 2.8
Internal water-loop heat pumps	< 5 ≥ 5 and ≤ 40	CAN/CSA-C13256-1	COP <sub>c</sub> ≥ 3.28, COP <sub>h</sub> ≥ 4.2 COP <sub>c</sub> ≥ 3.52, COP <sub>h</sub> ≥ 4.2
Water-cooled air conditioners – all types	< 19	ANSI/AHRI 210/240 or CTI STD-201RS	COP = 3.54, ICOP = 3.60
<b>Direct-Expansion Ground-Source Heat Pumps – Electrically Operated</b>			
Direct-expansion ground-source heat pumps	≤ 21	CSA C748	EER = 13.0 COP <sub>h</sub> = 3.1

Table 9.36.3.10. (Continued)

Component or Equipment	Heating or Cooling Capacity, kW	Standard	Minimum Performance <sup>(1)</sup>
<b>Room Air Conditioners and Room Air Conditioner Heat Pumps</b>			
Room air conditioners with reverse cycle			
with louvered sides	< 10.55	ANSI/AHAM RAC-1	EER = 8.5
without louvered sides			EER = 8.0
Room air conditioners without reverse cycle and with louvered sides	< 1.8		EER = 10.7
	≥ 1.8 and < 2.3		EER = 10.7
	≥ 2.3 and < 4.1		EER = 10.8
	≥ 4.1 and < 5.9		EER = 10.7
	≥ 5.9		EER = 9.4
Room air conditioner heat pumps with louvered sides	< 5.9		EER = 9.9
	≥ 5.9		EER = 9.5
Room air conditioners without louvered sides and without reverse cycle	< 1.8	CSA C368.1	EER = 9.9
	≥ 1.8 and < 2.3		EER = 9.9
	≥ 2.3 and < 4.1		EER = 9.4
	≥ 4.1 and < 5.9		EER = 9.4
Room air conditioner heat pumps without louvered sides	< 4.1		EER = 9.2
	≥ 4.1		EER = 8.8
Room air conditioner, casement only	All capacities		EER = 9.5
Room air conditioner, casement slider	All capacities		EER = 9.5
<b>Boilers</b>			
Electric <i>boilers</i>	≤ 88	—	Must be equipped with automatic water temperature control <sup>(2)</sup>
Gas-fired <i>boilers</i> <sup>(3)</sup>	≤ 88	CSA P.2	AFUE ≥ 90%
	> 88 and ≤ 117.23	AHRI BTS	E <sub>t</sub> ≥ 83%
Oil-fired <i>boilers</i>	≤ 88	CSA B212 or ANSI/ASHRAE 103	AFUE ≥ 85%
<b>Warm-Air Furnaces, Combination Warm-Air Furnace/Air-conditioning Units, Duct Furnaces and Unit Heaters</b>			
Gas-fired warm-air <i>furnaces</i> <sup>(3)</sup>	≤ 65.9	CSA P.2	AFUE ≥ 92%
	> 65.9 and ≤ 117.23	CAN/CSA-P.8	E <sub>t</sub> ≥ 78.5%
Gas-fired duct <i>furnaces</i> <sup>(3)</sup>	≤ 117.23	ANSI Z83.8/CSA 2.6	E <sub>t</sub> ≥ 81%
Gas-fired <i>unit heaters</i> <sup>(3)</sup>	≤ 117.23	CAN/CSA-P.11	E <sub>t</sub> ≥ 82%
Oil-fired warm-air <i>furnaces</i>	≤ 66	CSA B212	AFUE ≥ 85%
Oil-fired duct <i>furnaces</i> and <i>unit heaters</i>	—	UL 731	E <sub>c</sub> ≥ 80%
Combined space- and water-heating systems (combos)	≤ 87.9 if <i>boiler-based</i> ≤ 73.2 if based on <i>service water heater</i>	CAN/CSA-P.9 <sup>(4)</sup>	TPF = 0.65
Integrated mechanical systems	—	CSA P.10	OTPF = 0.78
<b>Other</b>			
Gas-fired fireplaces and <i>stoves</i> <sup>(3)</sup>	—	—	<sup>(5)</sup>
Solid-fuel-burning space-heating equipment	—	EPA 40 CFR, Part 60, Subpart AAA or CSA B415.1 <sup>(6)</sup>	See standard <sup>(7)</sup>
Dehumidifiers	≤ 87.5 L/day	CAN/CSA-C749	See standard <sup>(7)</sup>



**Table 9.36.3.10. (Continued)**

**Notes to Table 9.36.3.10.:**

- (1) The symbols and abbreviations that appear in this column have the following meanings:
  - AFUE = annual fuel utilization efficiency
  - COP = coefficient of performance, in W/W (COP<sub>c</sub> = in cooling mode and COP<sub>h</sub> = in heating mode)
  - E<sub>c</sub> = combustion efficiency, in %
  - EER = energy efficiency ratio, in (Btu/h)/W (no metric equivalent)
  - E<sub>t</sub> = thermal efficiency
  - FE = fireplace efficiency
  - HSPF = heating season performance factor, in watt-hours
  - ICOP = integrated coefficient of performance, in W/W
  - OTPF = overall thermal performance factor
  - SEER = seasonal energy efficiency ratio, in (Btu/h)/W (no metric equivalent)
  - TPF = thermal performance factor
- (2) No standard addresses the performance efficiency of electric *boilers*; however, their efficiency typically approaches 100%.
- (3) Includes propane.
- (4) See the exception stated in Sentence (3).
- (5) See Sentence (2).
- (6) CSA B415.1 does not apply to *stoves* with an oven whose volume is greater than 0.028 m<sup>3</sup> and automatically fuelled *appliances*.
- (7) Minimum performance values are omitted from the Table in cases where the referenced standard itself contains such requirements.

- 2)** Natural gas and propane fireplaces shall be
  - a) direct-vent (sealed), and
  - b) pilot-on-demand, interrupted or intermittent ignition systems without a standing pilot light.

**3)** The heat source component of combined space- and service water heating systems that are not within the scope of CAN/CSA-P.9, "Performance of Combined Space and Water Heating Systems (Combos)," shall meet the performance requirements stated in Table 9.36.3.10. for the applicable equipment type. (See Note A-9.36.3.10.(3).)

**9.36.3.11. Solar Thermal Systems**

**1)** Space-heating systems that use solar thermal technology shall conform to the manufacturer's design requirements and installation procedures.

**2)** Service water heating systems that use solar thermal technology shall be installed in accordance with the NPC.

**3)** Hot water storage tanks associated with the systems referred to in Sentence (2) shall be installed in a *conditioned space*.

**9.36.4. Service Water Heating Systems**

**9.36.4.1. Scope and Application**

**1)** This Subsection is concerned with the efficient use of energy by systems used to heat service water for household use as well as for indoor pools and hot tubs.

**2)** Where service water heating equipment or techniques other than those described in this Subsection are used, the *building* shall be designed and constructed in accordance with the energy efficiency requirements of the NECB.

**9.36.4.2. Equipment Efficiency**

**1)** *Service water heaters, boilers, pool heaters and storage tanks* shall comply with the performance requirements stated in Table 9.36.4.2. (See Note A-9.36.4.2.(1).)

**2)** Hot service water storage tanks not listed in Table 9.36.4.2. shall be covered with insulation having a minimum thermal resistance of 1.8 (m<sup>2</sup>·K)/W.

**Table 9.36.4.2.**  
**Service Water Heating Equipment Performance Standards**  
 Forming Part of Sentences 9.36.4.2.(1) and (2)

Component	Input <sup>(1)</sup>	Standard	Performance Requirement <sup>(2)</sup>
<b>Storage-Type Service Water Heaters</b>			
Electric	≤ 12 kW (50 L to 270 L capacity)	CAN/CSA-C191	SL ≤ 35 + 0.20V (top inlet)
			SL ≤ 40 + 0.20V (bottom inlet)
	≤ 12 kW (> 270 L and ≤ 454 L capacity)		SL ≤ (0.472V) – 38.5 (top inlet)
			SL ≤ (0.472V) – 33.5 (bottom inlet)
>12 kW (> 75 L capacity)	ANSI Z21.10.3/CSA 4.3 and DOE 10 CFR, Part 431, Subpart G	S = 0.30 + 27/V <sub>m</sub>	
Heat pump water heaters	≤ 24 A and ≤ 250 V	CAN/CSA-C745	EF ≥ 2.0
Gas-fired <sup>(3)</sup>	< 22 kW	CAN/CSA-P3	EF ≥ 0.67 – 0.0005V
	≥ 22 kW	ANSI Z21.10.3/CSA 4.3	E <sub>t</sub> ≥ 80% and standby loss ≤ rated input <sup>(4)</sup> /(800 + 16.57·√V)
Oil-fired	≤ 30.5 kW	CAN/CSA-B211	EF ≥ 0.59 – 0.0005V
	> 30.5 kW	ANSI Z21.10.3/CSA 4.3 and DOE 10 CFR, Part 431, Subpart G	E <sub>t</sub> ≥ 78% and standby loss ≤ (rated input <sup>(4)</sup> /800) + 16.57·√V
<b>Tankless Service Water Heaters</b>			
Gas-fired	≤ 73.2 kW	CAN/CSA-P7	EF ≥ 0.8
	> 73.2 kW	ANSI Z21.10.3/CSA 4.3 and DOE 10 CFR, Part 431, Subpart G	E <sub>t</sub> ≥ 80%
Oil-fired	≤ 61.5 kW <sup>(5)</sup>	DOE 10 CFR, Part 430, Subpart B, Appendix E	EF ≥ 0.59 – 0.0019V <sub>m</sub>
	Other	ANSI Z21.10.3/CSA 4.3 and DOE 10 CFR, Part 431, Subpart G	E <sub>t</sub> ≥ 80%
Electric	—	—	<sup>(6)</sup>
Combined space- and water-heating systems (combos)	≤ 87.9 kW if <i>boiler</i> -based ≤ 73.2 kW if based on <i>service water heater</i>	CAN/CSA-P9	TPF = 0.65
Integrated mechanical systems	—	CSA P.10	OTPF = 0.78
<b>Pool Heaters</b>			
Gas-fired <sup>(3)</sup>	< 117.2 kW	ANSI Z21.56/CSA 4.7 or CSA P.6	E <sub>t</sub> ≥ 82%
Oil-fired	—	CSA B140.12	E <sub>t</sub> ≥ 75%

**Notes to Table 9.36.4.2.:**

(1) 1 kW = 3412 Btu/h

(2) The symbols and abbreviations used in this column have the following meanings:

- EF = energy factor, in %/h
- E<sub>t</sub> = thermal efficiency with 38.9°C water temperature difference
- OTPF = overall thermal performance factor
- S = standby loss, in %/h (percentage heat content of stored water per hour)
- SL = standby loss, in W
- TPF = thermal performance factor
- V = storage volume, in L, as specified by the manufacturer
- V<sub>m</sub> = measured storage volume, in US gallons

(3) Includes propane.

(4) Rated input is measured in watts.

(5) Consistent with the U.S. Congress “National Appliance Energy Conservation Act of 1987.”

(6) No standard addresses the performance efficiency of electric tankless *service water heaters*; however, their efficiency typically approaches 100%.

3) Except for components that are required to be installed outdoors, service water heating equipment shall be installed in a *conditioned space*. (See Note A-9.36.4.2.(3).)

#### 9.36.4.3. Solar Domestic Hot Water Systems

1) Service water heating systems that use solar thermal technology shall conform to the manufacturer's design requirements and installation procedures.

2) Service water heating systems that use solar thermal technology shall be installed in accordance with the NPC.

3) Hot water storage tanks associated with the systems referred to in Sentence (2) shall be installed in a *conditioned space*.

#### 9.36.4.4. Piping

1) The first 2 m of outlet piping downstream and of inlet piping upstream leading from a storage tank or heating vessel shall be covered with piping insulation that is at least 12 mm thick.

2) All piping forming part of a continuously operating recirculating service water heating system shall be covered with piping insulation that is at least 12 mm thick.

3) Where piping forming part of the service water heating system is located outside the *building* envelope or in an unconditioned space, it shall be insulated to a thermal resistance not less than the effective thermal resistance required for the exterior above-ground walls.

#### 9.36.4.5. Controls

1) Service water heating systems with storage tanks shall be equipped with automatic temperature controls capable of adjustment between the minimum and maximum temperature settings permitted for the intended use.

#### 9.36.4.6. Indoor Swimming Pool Equipment Controls

- 1) Heaters for indoor swimming pools shall be equipped with
- a thermostat, and
  - a readily accessible and clearly labeled device that allows the heater to be shut off without adjusting the thermostat setting.

2) Pumps and heaters for indoor swimming pools shall be equipped with time switches or other types of controls that can be set to automatically turn off the pumps and heaters when their operation is not required. (See Note A-9.36.4.6.(2).)

### 9.36.5. Energy Performance Compliance

#### 9.36.5.1. Scope and Application

1) This Subsection is concerned with modeling the energy performance of components, systems and assemblies, including heat gains from internal loads described in Sentence 9.36.5.4.(4), that are addressed in the scope of the prescriptive requirements in Subsections 9.36.2. to 9.36.4. and that are installed in *buildings* described in Sentence 9.36.1.3.(3).

2) Internal loads other than those described in Sentence 9.36.5.4.(4) shall be excluded from the performance compliance calculations as they relate to

- the lighting of unconditioned spaces,
- exterior lighting, and
- the ventilation of unconditioned spaces.

#### 9.36.5.2. Definitions

(See Note A-9.36.5.2.)

1) For the purpose of this Subsection, the term "reference house" shall mean a hypothetical replica of the proposed house design using the same energy sources for the same functions and having the same environmental requirements, *occupancy*,

climatic data and operating schedules, but made to comply with all applicable prescriptive requirements of Subsections 9.36.2. to 9.36.4.

**2)** For the purpose of this Subsection, the term “annual energy consumption” shall mean the annual sum of service water heating and space-conditioning energy consumption of the proposed house design, as calculated in accordance with this Subsection.

**3)** For the purpose of this Subsection, the term “house energy target” shall mean the annual energy consumption of the reference house, as calculated in accordance with this Subsection.

**4)** For the purpose of this Subsection, the term “principal ventilation rate” shall mean the normal operating exhaust capacity of the principal ventilation fan as required by Article 9.32.3.3.

### 9.36.5.3. Compliance

- 1)** The performance compliance calculations shall determine
- a) the annual energy consumption of the proposed house, and
  - b) the house energy target of a reference house.

**2)** The annual energy consumption of the proposed house shall not exceed the house energy target of the reference house. (See Note A-9.36.5.3.(2).)

**3)** In establishing the house energy target, *building* components, systems and assemblies shall be accounted for in accordance with the prescriptive requirements of Subsections 9.36.2. to 9.36.4. for the climate zone under consideration.

**4)** In establishing the annual energy consumption, *building* components, systems and assemblies that are addressed in the scope of the prescriptive requirements of Subsections 9.36.2. to 9.36.4. shall be accounted for for the climate zone under consideration.

**5)** Where the construction techniques or *building* components, systems or assemblies used are more energy-efficient than those prescribed by the prescriptive requirements, the performance compliance calculations are permitted to take this increased performance level into account in the determination of the annual energy consumption, provided it can be quantified and is not dependent on occupant interaction.

**6)** Both the proposed and reference houses shall be modeled using the same climatic data, *soil* conditions, operating schedules in Article 9.36.5.4. and temperature set-points.

### 9.36.5.4. Calculation Methods

**1)** Except as provided in Sentence (2), the energy model calculations shall account for the annual energy consumption of systems and equipment required for

- a) space heating,
- b) ventilation,
- c) service water heating, and
- d) where installed, space cooling.

(See Note A-9.36.5.4.(1).)

**2)** Redundant or back-up equipment for the systems and equipment listed in Sentence (1) is permitted to be excluded from the energy model, provided it is equipped with controls and is not required to meet the space-conditioning load of the house. (See Note A-9.36.5.4.(2).)

- 3)** The schedules used in the energy model shall
- a) be based on a time interval not greater than one hour, where the energy model evaluates the performance of the house over hourly intervals, or
  - b) be applied in an hourly-bin model then averaged, where the energy model does not evaluate the performance of the house over hourly intervals.

- 4)** The energy model calculations shall account for the loads due to heat gains from occupants, lighting and miscellaneous equipment using the default schedule provided in Table 9.36.5.4. for every day of the year and such loads shall be
  - a) multiplied by the following adjustment factors, as applicable:
    - i) 1 for a house with or without a *secondary suite*,
    - ii) 0.625 for each *suite* in a residential *building* containing 2 *suites*,
    - iii) 0.606 for each *suite* in a residential *building* containing 3 *suites*, or
    - iv) 0.598 for each *suite* in a residential *building* containing more than 3 *suites*, and
  - b) increased for each hour by 3.58 W per square metre of *floor area* in common spaces, if applicable.

**Table 9.36.5.4.**  
**Default Schedule for Internal Heat Gain Loads<sup>(1)</sup>**  
 Forming Part of Sentence 9.36.5.4.(4)

Average Load, in W, Before Noon											
12 a.m.	1 a.m.	2 a.m.	3 a.m.	4 a.m.	5 a.m.	6 a.m.	7 a.m.	8 a.m.	9 a.m.	10 a.m.	11 a.m.
786	552	549	523	521	547	634	726	847	880	906	986
Average Load, in W, After Noon											
12 p.m.	1 p.m.	2 p.m.	3 p.m.	4 p.m.	5 p.m.	6 p.m.	7 p.m.	8 p.m.	9 p.m.	10 p.m.	11 p.m.
992	934	898	911	924	1 089	1 410	1 588	1 568	1 483	1 194	952

**Notes to Table 9.36.5.4.:**

<sup>(1)</sup> The schedule indicates at what time of day the heat gains from internal loads and hot water draws are present; it does not account for heat gains from exterior lighting and from lighting of unconditioned spaces.

- 5)** The energy model calculations shall account for the following space-heating temperature set-points:
  - a) 21°C in all living spaces above the *basement*,
  - b) 19°C in *basements* and common spaces, and
  - c) 15°C in crawl spaces intended to be *conditioned spaces*.
- 6)** The energy model calculations shall account for a space-cooling temperature set-point of 25°C in all *conditioned spaces* served by the cooling system.
- 7)** The energy model calculations shall account for a thermostatic control that responds to fluctuations of ±0.5°C from the temperature set-point. (See Note A-9.36.5.4.(7).)
- 8)** If a computer program is used to carry out the compliance calculations, the calculation methods employed in the energy model shall
  - a) be used for both the reference and proposed houses, and
  - b) be tested in accordance with ANSI/ASHRAE 140, "Evaluation of Building Energy Analysis Computer Programs," with variations in the computer program from the range recommended therein reported in accordance with Division C.
- 9)** The proposed and reference houses shall both be modeled using the same approach and assumptions, except where *building* components or energy efficiency features are permitted by this Subsection to be different.
- 10)** The energy model calculations shall account for the effect of airtightness in accordance with Sentence 9.36.5.10.(10) or (11), as applicable.
- 11)** The energy model calculations shall account for heat transfer through elements separating *conditioned space* from unconditioned space, the exterior or the ground.

**9.36.5.5. Climatic Data**

**1)** To calculate the effect of heating and cooling consumption, the energy model calculations shall be performed using climatic data measured at time intervals no greater than one hour for one year (8 760 hours) based on the average of at least 10 years of measured data collected at the weather station nearest to the region in which the proposed house is located. (See Note A-9.36.5.5.(1).)

**2)** For urban regions with several climatic data sets and for locations for which climatic data are not available, the energy model calculations shall be performed using climatic data that best represent the climate at the *building* site.

- 3)** The energy model calculations shall account for ground reflectance by
- a) increasing ground reflectance due to snow cover in a ratio of 30% without snow cover and 70% with snow cover, or
  - b) taking into account changes in ground reflectance throughout the heating season.

**9.36.5.6. Building Envelope Calculations**

**1)** For each hour of the year, the energy model calculations shall account for heat transfer through wall assemblies, roof-ceiling assemblies, including attics where applicable, and exposed floor assemblies due to the thermal characteristics of the particular assembly and thermal bridging.

**2)** The following *building* envelope assemblies and components shall be addressed in the energy model calculations:

- a) above-ground walls and roof-ceiling assemblies,
- b) floors and walls in contact with the ground, and
- c) doors, windows and skylights.

(See Subsection 9.36.2.)

**3)** For each wall assembly, fenestration component, roof-ceiling assembly and exposed floor assembly, the energy model calculations shall account for

- a) the area of the interior side of the insulated surface,
- b) emissivity, and
- c) the effective thermal resistance or overall thermal transmittance, as applicable.

**4)** The energy model calculations shall account for the effect that each assembly in contact with the ground has on below-*grade* heat transfer due to

- a) the geometry of the *foundation*,
- b) *soil* conditions (see Note A-1.1.3.1.(1)), and
- c) the configuration of the insulation.

**5)** The energy model calculations shall account for heat transfer through fenestration separating *conditioned spaces* from the outdoors, including skylights, while accounting for both temperature difference and transmission of solar radiation based on

- a) orientation as a function of azimuth and tilt of the surface,
- b) area of frame opening and glazed area,
- c) overall thermal transmittance, and
- d) solar heat gain coefficient.

**6)** Where the energy model calculations account for the effect of thermal mass, the contents of the house shall be excluded. (See Note A-9.36.5.6.(6).)

**7)** The energy model calculations shall account for the presence of thermally active walls, floors and ceilings with embedded conditioning systems that form part of the *building* envelope.

**8)** Where skylights are installed in the roof, the gross roof area shall be determined in accordance with Sentence 9.36.2.3.(3).

**9)** Skylights shall be considered to have no shading.

**10)** The energy model calculations shall account for the effects of exterior permanent and fixed shading only on solar heat gain from fenestration.

**11)** The ratio of fenestration area to opaque area of doors shall be the same for the proposed and reference houses. (See Note A-9.36.5.6.(11).)

#### 9.36.5.7. HVAC System Calculations

**1)** The energy model calculations shall account for the energy consumption of each heating, ventilating and, where installed, cooling system for each hour of the year. (See Note A-9.36.5.7.(1).)

**2)** Each heating system and, where installed, cooling system shall be accounted for separately in the energy model calculations.

**3)** *Conditioned spaces* in both the reference and proposed houses shall be modeled as being

- a) heated, where only heating systems are provided in the proposed house,
- b) cooled, where only cooling systems are provided in the proposed house, or
- c) heated and cooled, where complete heating and cooling systems are provided in the proposed house.

**4)** The performance requirements stated in Table 9.36.3.10. shall be used in the energy model calculations.

**5)** Where duct and piping losses are accounted for in the energy model calculations, they shall be included for both the proposed and reference houses and calculated the same way for both houses. (See Note A-9.36.5.7.(5).)

**6)** The same time periods shall be used in the simulation of the operation of the ventilation system for both the proposed and reference houses.

**7)** During the heating season, any solar and internal heat gains that cause an increase in space temperature beyond 5.5°C above the setpoint shall be

- a) excluded from the energy model calculations, or
- b) calculated as being vented from the house.

**8)** The energy model calculations shall account for the part-load performance of equipment, including electrical consumption.

**9)** The energy model calculations shall account for the heat-recovery efficiency of heat-recovery ventilators using a minimum of 2 data test points derived from testing in accordance with Clause 9.36.3.9.(3)(a) or (b), as applicable.

#### 9.36.5.8. Service Water Heating System Calculations

**1)** The energy model calculations shall account for the energy consumption of all service water heating systems.

**2)** The performance requirements stated in Table 9.36.4.2. shall be used in the energy model calculations.

**3)** Where piping or standby losses are accounted for in the energy model calculations, they shall be included for both the proposed and reference houses, including their effect on space heating and cooling, and calculated the same way for both houses.

**4)** The energy model calculations shall use a supply cold water temperature, in °C, that is

- a) equal to  $-0.002 (\text{HDD}) + 20.3$ , where  $\text{HDD} < 7\,999$ ,
- b) equal to 4.3, where  $\text{HDD} \geq 8\,000$ , or
- c) determined based on the ground and air temperatures in the climatic data file.

**5)** The energy model calculations shall use a service water delivery temperature of 55°C. (See Note A-9.36.5.8.(5).)

**6)** The energy model calculations shall take into account the service water heating use schedule presented in Table 9.36.5.8. using a load of

- a) 225 L/day for houses with or without a *secondary suite*, or
- b) 140 L/day per *dwelling unit* for other types of residential *buildings*.

**Table 9.36.5.8.**  
**Default Schedule of Service Water Heating Use**  
 Forming Part of Sentence 9.36.5.8.(6)

Type of Small Residential <i>Building</i>	Distribution of Hourly Draws on Service Water Heating, L/h											
	12 a.m.	1 a.m.	2 a.m.	3 a.m.	4 a.m.	5 a.m.	6 a.m.	7 a.m.	8 a.m.	9 a.m.	10 a.m.	11 a.m.
Houses with or without a <i>secondary suite</i> (225 L/day/house)	0	0	0	0	0	0	0	5	20	30	55	27.5
	12 p.m.	1 p.m.	2 p.m.	3 p.m.	4 p.m.	5 p.m.	6 p.m.	7 p.m.	8 p.m.	9 p.m.	10 p.m.	11 p.m.
	7.5	2.5	5	12.5	22.5	15	15	5	2.5	0	0	0
	12 a.m.	1 a.m.	2 a.m.	3 a.m.	4 a.m.	5 a.m.	6 a.m.	7 a.m.	8 a.m.	9 a.m.	10 a.m.	11 a.m.
<i>Dwelling units</i> in other types of residential <i>buildings</i> (140 L/day/ <i>dwelling unit</i> )	0	0	0	0	0	0	0	3.1	12.4	18.7	34.2	17.1
	12 p.m.	1 p.m.	2 p.m.	3 p.m.	4 p.m.	5 p.m.	6 p.m.	7 p.m.	8 p.m.	9 p.m.	10 p.m.	11 p.m.
	4.7	1.6	3.1	7.8	14	9.3	9.3	3.1	1.6	0	0	0
	12 a.m.	1 a.m.	2 a.m.	3 a.m.	4 a.m.	5 a.m.	6 a.m.	7 a.m.	8 a.m.	9 a.m.	10 a.m.	11 a.m.

### 9.36.5.9. General Requirements for Modeling the Proposed House

**1)** Except where permitted by Articles 9.36.5.10. to 9.36.5.12., the energy model calculations for the proposed house shall be consistent with the proposed construction specifications for that house with regard to

- fenestration and opaque *building* envelope assembly type, effective thermal resistance and areas,
- HVAC system types and capacities, and
- service water heating system types and capacities.

(See Note A-9.36.5.9.(1).)

### 9.36.5.10. Modeling Building Envelope of Proposed House

**1)** Except as provided in Sentences (2) and (3), the energy model calculations for the proposed house shall be consistent with the proposed construction specifications for that house with regard to

- the area of the above-ground portion of *foundation* walls,
- the effective thermal resistance of above-ground walls, ceilings below attics, roof assemblies and *rim joists*,
- the maximum overall thermal transmittance of doors, as calculated in accordance with Sentence 9.36.2.2.(3),
- the effective thermal resistance of below-ground walls and slabs-on-ground,
- exterior walls, roof-ceiling assembly, doors, walls, exposed floors, and floors in contact with the ground,
- distribution, orientation and area of fenestration and doors, as calculated in accordance with Article 9.36.2.3.,
- solar heat gain coefficient and overall thermal transmittance of fenestration, as calculated in accordance with Sentence 9.36.2.2.(3),
- configuration of insulation in assemblies in contact with the ground, and
- effective thermal resistance of *foundation* walls.

**2)** Except for penetrations, slab-on-ground edge insulation and assemblies with embedded heating pipes, where a *building* envelope component or assembly covers less than 2% of the total area of the assembly type to which it belongs, its thermal characteristics are not required to be calculated as belonging to a distinct assembly, provided the area of the component or assembly is included in an adjacent assembly having the same orientation (See Note A-9.36.5.10.(2).)

**3)** *Building* envelope assemblies with the same thermal characteristics and orientation are not required to be calculated as distinct assemblies, provided their area is included in an adjacent assembly.

**4)** *Building* envelope assemblies and components separating *conditioned space* from enclosed unconditioned space shall have a solar heat gain coefficient equal to 0.



**5)** Except as stated in Sentence 9.36.5.6.(9), the energy model calculations for the proposed house shall account for the effects of exterior permanent and fixed shading devices, including fins, overhangs, and light shelves, on solar heat gain.

**6)** Where thermal mass is included in the energy model calculations for the proposed house, it shall be set as

- a) the specified mass up to the inside edge of insulation in exterior walls, the mass of interior walls, the mass up to the centre-line of *party walls*, and the mass of floors, as applicable,
- b) the specified mass of the *building* envelope assembly, where the energy model calculations include a transient analysis of thermal transfer of the entire *building* envelope assembly, or
- c) a default value of 0.060 MJ/m<sup>2</sup>·°C.

**7)** Exterior walls, roofs and exposed floors shall have a solar absorptance of 0.4.

**8)** The orientation of the *foundation* of the proposed house as constructed shall be within 22.5° of the orientation used in the energy model calculations.

**9)** The airtightness value used in the energy model calculations for the proposed house shall be

- a) 3.2 air changes per hour at 50 Pa pressure differential, where the construction complies with Section 9.25.,
- b) 2.5 air changes per hour at 50 Pa pressure differential, where it can be shown that the *air barrier system* is constructed in accordance with Subsection 9.25.3. and Articles 9.36.2.9. and 9.36.2.10., or
- c) where airtightness is tested in accordance with Sentence (11),
  - i) the number of air changes per hour at 50 Pa pressure differential, and
  - ii) the equivalent leakage area (see Note A-9.36.5.10.(9)(c)(ii)).

**10)** A design airtightness shall be assigned for use in the energy model calculations until the actual airtightness has been measured in accordance with Sentence (11).

**11)** Where measured airtightness is used in the energy model calculations, it shall be determined in accordance with CAN/CGSB-149.10-M, "Determination of the Airtightness of Building Envelopes by the Fan Depressurization Method,"

- a) as written, or
- b) excluding Clause 6.1.6, which allows intentional openings for mechanical equipment to be left unsealed.

(See Note A-9.36.5.10.(11).)

**12)** Where airtightness is determined in accordance with Sentence (11) using air changes per hour, the result obtained at an air pressure differential of 50 Pa shall be used in the energy model calculations.

**13)** Where airtightness is determined in accordance with Clause (11)(b), its rate shall be adjusted in the energy model calculations to account for air leakage through mechanical equipment.

### 9.36.5.11. Modeling HVAC System of Proposed House

**1)** Where multiple HVAC systems serve a single space, the energy model calculations for the proposed house shall call each system in the order of priority established by the system control in the proposed house.

**2)** Where a heat pump is included in the proposed house, the energy model calculations shall include

- a) the effect of the source temperature on the heat pump's efficiency, and
- b) the temperature at which the heat pump shuts down.

**3)** Permanent supplementary heating systems that are operated by a thermostat or automatic control shall be included in the energy model calculations for the proposed house.

- 4)** The performance characteristics of the heat-recovery ventilation system of the proposed house shall be as specified at not less than the principal ventilation rate required for a system designed in accordance with Section 9.32.
- 5)** The ventilation system shall be modeled as operating 8 hours a day at the principal ventilation rate.
- 6)** The energy model calculations shall determine the required principal ventilation rate, in L/s, in accordance with Article 9.32.3.3. based on the number of bedrooms in the proposed house.
- 7)** The energy model calculations may include duct and piping losses, taking into account the properties of the specified duct and piping insulation of the proposed house.
- 8)** The energy model calculations shall include a heating system and, where installed, a cooling system sized according to the specifications for the proposed house.
- 9)** The energy model calculations shall include the effect of part-load performance of equipment using
- a) the same modeled part-load performance data used for the reference house as per Clause 9.36.5.15.(6)(a),
  - b) the default part-load performance characteristics stated in Clause 9.36.5.15.(6)(b), or
  - c) measured data for the specified equipment.
- (See Note A-9.36.5.11.(9).)
- 10)** Where a heat-recovery ventilator is installed in the proposed house, the energy model calculations shall only account for the recovery of sensible heat using the efficiency ratings in Sentence 9.36.3.9.(3). (See Note A-9.36.5.11.(10).)
- 11)** Except as provided in Sentence (12), where a forced-air system is installed in the proposed house, the energy model calculations shall assume the circulation fan operates when the heating, cooling or principal ventilation system is operating. (See Note A-9.36.5.11.(11).)
- 12)** Where a forced-air system is installed in the proposed house and where the principal ventilation system in the proposed house is a separate, fully ducted ventilation system, the energy model calculations shall assume the circulation fan operates only when the heating or cooling system is operating.
- 13)** Where the proposed house contains multiple HVAC systems, the circulation fan power shall be the sum of the circulation fan power capacity of each system.
- 14)** The ventilation fan power consumption shall be modeled
- a) as being 2.32 W/L/s for each ventilation fan on the exhaust side and, where applicable, on the supply side, or
  - b) as specified, where a heat-recovery ventilator is used.
- 15)** Where a forced-air system is installed in the proposed house, the energy model calculations shall determine the flow rate, in L/s, of the circulation fan in the reference house by multiplying the capacity, in W, of the heating system in the proposed house by
- a) 0.0604 for heat pumps, and
  - b) 0.0251 for all other types of heating systems.
- 16)** Where a forced-air system is installed in the proposed house, the energy model calculations shall determine the minimum electricity requirement, in W, of the circulation fan by multiplying the flow rate, in L/s, of the circulation fan in the reference house, determined in accordance with Sentence (15), by a factor of 2.30.
- 17)** Where a forced-air system is installed in the proposed house, the flow rate of the circulation fan shall be modeled as being the larger of
- a) the flow rate of the circulation fan of the reference house, determined in accordance with Sentence (15), or
  - b) the flow rate of the circulation fan for the forced-air system specified in the design for the proposed house.

**18)** Except as provided in Sentence (19), where a forced-air system is installed in the proposed house, the power capacity of the circulation fan shall be modeled as specified in the design for the proposed house.

**19)** Where the design for the proposed house specifies a forced-air system with a circulation fan flow rate that is lower than that of the flow rate of the circulation fan in the reference house, as determined in accordance with Sentence (15), the electricity capacity, in *W*, of the circulation fan shall be modeled as being the larger of

- a) the electricity capacity specified for the circulation fan in the proposed forced-air system, or
- b) the minimum circulation fan electricity capacity determined in accordance with Sentence (16).

**20)** For natural gas-, oil-, propane- and wood-burning heating systems, the energy model calculations shall set the auxiliary electricity requirements, including that of combustion fans, to those specified for the proposed house.

**9.36.5.12. Modeling Service Water Heating System of Proposed House**

**1)** The service water heating system used in the energy model calculations shall be sized as specified in the design for the proposed house.

- 2)** The energy model calculations may include
- a) piping losses, and
  - b) drain-water heat recovery, provided the calculation of the heat recovered is based on the efficiency of the drain-water heat-recovery unit specified for the proposed house and the energy savings are determined using a drain-water
    - i) inlet temperature to the recovery system of 36°C,
    - ii) flow rate of 9.5 L/min, and
    - iii) flow that is available for recovery 15 min/day for a house and 10 min/day per *suite* for a multi-unit residential *building* with more than 2 *suites*.

(See Note A-9.36.5.12.(2).)

**9.36.5.13. General Requirements for Modeling the Reference House**

**1)** Except as provided in Sentence (2) and Articles 9.36.5.14. to 9.36.5.16., the energy model calculations for the reference house shall be consistent with the prescriptive requirements of Subsections 9.36.2. to 9.36.4. with regard to

- a) fenestration and opaque *building* envelope assembly types and areas,
- b) HVAC system types and capacities, and
- c) service water heating system types and capacities.

(See Note A-9.36.5.9.(1).)

**2)** The energy model calculations for the reference house shall include the same values as those used for the proposed house with regard to

- a) *floor area*,
- b) heated volume, and
- c) number and types of rooms.

**9.36.5.14. Modeling Building Envelope of Reference House**

**1)** The energy model calculations for the reference house shall include the same values as those used for the proposed house with regard to

- a) the gross area of above-ground portion of *foundation* walls,
- b) *soil* conditions,
- c) the orientation of the *foundation*, and
- d) the ratio of fenestration area to opaque area of doors.

**2)** The energy model calculations for the reference house shall use the following set values:

- a) 0.060 MJ/m<sup>2</sup>·°C for thermal mass,
- b) a solar absorptance of 0.4 for the exterior walls, roofs and exposed floors,
- c) 0.26 for the solar heat gain coefficient of fenestration, and
- d) 2.5 air changes per hour at 50 Pa pressure differential for airtightness.

- 3)** The effective thermal resistance and overall thermal transmittance values, as applicable, used in the energy model calculations for the reference house shall be determined for the applicable heating degree-day zone in accordance with
- Table 9.36.2.6.-A for walls, ceilings below attics, roof assemblies and *rim joists*,
  - Table 9.36.2.7.-A for doors, and
  - Table 9.36.2.8.-A for below-*grade* walls and slabs-on-ground.
- 4)** Except as provided in Sentences (5) and (6), the exterior walls, roof-ceiling assembly, doors, walls, exposed floors, and floors of the reference house that are in contact with the ground shall have the same area as those of the proposed house.
- 5)** The area and orientation of fenestration and doors of the reference house shall be modeled as being equally distributed on all sides of the house.
- 6)** The gross wall area and the area of fenestration and doors of the reference house shall be determined in accordance with Article 9.36.2.3.
- 7)** Windows and other glazed components in the reference house shall have a maximum overall thermal transmittance as required in Table 9.36.2.7.-A for the applicable heating degree-day category.
- 8)** The configuration of insulation in assemblies of the reference house that are in contact with the ground shall be modeled as conforming to Article 9.36.2.8.
- 9)** *Foundation* walls shall be modeled using the applicable effective thermal resistance values in Table 9.36.2.8.-A and as conforming to Sentence 9.36.2.8.(2).
- 10)** The fenestration and door area to gross wall area ratio (FDWR) of the reference house shall be
- for houses containing 1 or 2 *dwelling units*,
    - as per the proposed house, where its FDWR is between 17% and 22%,
    - 17%, where the FDWR of the proposed house is less than 17%, or
    - 22%, where the FDWR of the proposed house is greater than 22%, and
  - for *buildings of residential occupancy* containing more than 2 *dwelling units*,
    - the FDWR determined in Clause (a) for the areas determined in accordance with Sentence 9.36.2.3.(2) and, where the FDWR determined in accordance with the calculation in Sentence 9.36.2.3.(3) only does not exceed 40%, or
    - 40% of the gross wall area enclosing *conditioned space* where the area of fenestration and doors is greater than 40% of the gross wall area enclosing *conditioned space* determined in accordance with Sentence 9.36.2.3.(2).

(See Note A-9.36.5.14.(10).)

### 9.36.5.15. Modeling HVAC System of Reference House

- 1)** Where multiple HVAC systems serve a single space, the energy model calculations for the reference house shall use the same order of priority as that used for the proposed house. (See Sentence 9.36.5.11.(1).)
- 2)** The energy model calculations for the reference house shall include the same features as those used for the proposed house with regard to
- the principal heating and cooling energy sources, which are gas, electricity, oil, propane, wood or a heat pump,
  - the primary and secondary energy sources, which are gas, electricity, oil, propane, wood or a heat pump, and
  - the ventilation rate (see Sentence 9.36.5.11.(6)).
- 3)** Except as required in Sentence 9.36.3.8.(1), the reference house shall be modeled without a heat-recovery ventilator.
- 4)** The ventilation system shall be modeled as operating 8 hours a day.

**5)** The heating system and, where installed, the cooling system shall be sized in accordance with Article 9.33.5.1. with regard to total heat output capacity and nominal cooling capacity. (See Note A-9.36.5.15.(5).)

**6)** The part-load performance of HVAC equipment in the reference house shall be calculated using

- a) modeled part-load performance characteristics, where applicable, or
- b) the performance values for each type of system multiplied by an adjustment factor from Table 9.36.5.15.-A, 9.36.5.15.-B or 9.36.5.15.-C as follows:
  - i) for *furnaces*, by multiplying the *furnace* steady-state efficiency by the adjustment factor given in Table 9.36.5.15.-A,
  - ii) for heat pumps and air conditioners, by multiplying the heat pump steady-state coefficient of performance by the adjustment factor given in Table 9.36.5.15.-B, and
  - iii) for *boilers*, combination space-heating and service water heating systems, and integrated mechanical systems, by multiplying the net-full-load heating efficiency by the adjustment factor given in Table 9.36.5.15.-C.

(See Note A-9.36.5.15.(6).)

**Table 9.36.5.15.-A**  
**Part-Load Adjustment Factors for Furnaces**  
 Forming Part of Subclause 9.36.5.15.(6)(b)(i)

Fuel Source	Type of Equipment	Capacity	Part-Load Ratio		
			0.15	0.4	1.0
			Adjustment Factors		
Gas	Warm-air <i>furnaces</i>	≤ 65.9 kW	1.03	1.02	1.0
		> 65.9 kW	0.91	0.97	1.0
	Duct <i>furnaces</i> and <i>unit heaters</i>	All capacities	0.91	0.97	1.0
Oil	All types	All capacities	0.95	0.98	1.0

**Table 9.36.5.15.-B**  
**Part-Load Adjustment Factors for Heat Pumps and Air Conditioners**  
 Forming Part of Subclause 9.36.5.15.(6)(b)(ii)

Type of Equipment	Part-Load Ratio		
	0.15	0.4	1.0
Adjustment Factors			
Air-source heat pumps and air conditioners	0.72	0.86	1.0
Water-source heat pumps	0.93	0.98	1.0
Ground-source heat pumps	0.93	0.98	1.0

**Table 9.36.5.15.-C**  
**Part-Load Adjustment Factors for Boilers, Combination Systems and Integrated Mechanical Systems**  
 Forming Part of Subclause 9.36.5.15.(6)(b)(iii)

Fuel Source	Type of Equipment	Part-Load Ratio		
		0.15	0.4	1.0
		Adjustment Factors		
Gas	<i>Boiler</i>	1.03	1.02	1.0
	Integrated mechanical systems <sup>(1)</sup> within the scope of CSA P.10 <sup>(2)</sup>	N/A	N/A	N/A
	Combination space- and service water heating systems within the scope of CAN/CSA-P.9 <sup>(2)</sup>	N/A	N/A	N/A
	Combination space- and service water heating systems not within the scope of CAN/CSA-P.9	Same as gas boiler		
Oil	<i>Boiler</i>	1.03	1.02	1.0
	Combination space- and service water heating systems within the scope of CAN/CSA-P.9 <sup>(2)</sup>	N/A	N/A	N/A
	Combination space- and service water heating systems not within the scope of CAN/CSA-P.9	Same as oil boiler		

**Notes to Table 9.36.5.15.-C:**

- (1) Integrated mechanical systems perform all three functions of space-heating, water-heating and heat-recovery ventilation.
- (2) The part-load characteristics of these types of systems shall not be accounted for in the energy model calculations.

- 7)** The performance of the HVAC equipment in the reference house shall be modeled
  - a) as conforming to Table 9.36.3.10. for the corresponding type, fuel source and capacity of equipment in the proposed house, or
  - b) where the HVAC equipment for the proposed house is not addressed in Table 9.36.3.10., as a gas warm-air furnace with a minimum performance rating of 92% annual fuel utilization efficiency.
- 8)** Where a heat-recovery ventilator is installed in the reference house, the energy model calculations shall only account for the recovery of sensible heat using the efficiency ratings in Sentence 9.36.3.9.(3). (See Note A-9.36.5.15.(8).)
- 9)** The energy model calculations shall assume all ventilation and circulation fans required to be modeled in the reference house are equipped with permanent-split capacitor (PSC) motors.
- 10)** Where a forced-air system is installed in the reference house, the energy model calculations shall assume the circulation fan operates when the heating, cooling or principal ventilation system is called for.
- 11)** Where the reference house contains multiple HVAC systems, the circulation fan power shall be the sum of the circulation fan power capacity of each system.
- 12)** The principal ventilation flow rate, in L/s, prescribed in Section 9.32. shall be multiplied by 2.32 W/L/s to determine the ventilation fan power capacity, in W, to be used in the energy model calculations for each fan on the exhaust side and, where applicable, on the supply side.

**13)** Where a heat-recovery ventilator is required in the reference house in accordance with Article 9.36.3.8., the ventilation flow rate, in L/s, in the zone served by the pool or hot tub shall be multiplied by 4.18 W/L/s to determine the heat-recovery ventilator power, in W, to be used in the energy model calculations.

**14)** Where a forced-air system is installed in the reference house, the system’s capacity, in W, shall be multiplied by one of the following factors to determine the circulation fan flow rate, in L/s:

- a) 0.0604 for heat pumps, and
- b) 0.0251 for all other types of heating systems.

**15)** Where a forced-air system is installed in the reference house, the circulation fan flow rate, in L/s, shall be multiplied by 2.30 W/L/s to determine the circulation fan power capacity, in W.

**16)** For natural gas-, oil-, propane- and wood-burning heating systems, the energy model calculations shall set the auxiliary electricity capacity, including that of combustion fans, to 208 W during operation.

**9.36.5.16. Modeling Service Water Heating System of Reference House**

**1)** The energy source of the reference house’s service water heating system, which is gas, electricity, oil, propane, wood or a heat pump, shall be the same as that for the system in the proposed house.

**2)** The service water heating system in the reference house shall be sized in accordance with Subsection 9.31.6. with regard to output capacity.

**3)** Except as required by Table 9.36.5.16., the performance of the service water heating equipment in the reference house shall be modeled as conforming to Table 9.36.4.2. for the energy source, capacity and type of service water heating equipment in the proposed house.

**Table 9.36.5.16.**  
**Performance of Service Water Heating (SWH) Equipment in the Reference House**  
 Forming Part of Sentence 9.36.5.16.(3)

Type of SWH Equipment in Proposed House	Input for Proposed SWH Equipment	Type of SWH Equipment to be Used for Reference House	Input for Reference SWH Equipment
Gas-fired tankless <i>service water heater</i>	≤ 73.2 kW	Gas-fired storage type	≤ 22 kW
	> 73.2 kW		> 22 kW
Oil-fired tankless <i>service water heater</i>	≤ 61.5 kW <sup>(1)</sup>	Oil-fired storage type	≤ 30.5 kW <sup>(1)</sup>
	Other		> 30.5 kW
Not listed in Table 9.36.4.2.	—	Gas-fired storage type	≥ 22 kW (E <sub>t</sub> ≥ 80%)

**Notes to Table 9.36.5.16.:**

(1) Consistent with the U.S. Congress “National Appliance Energy Conservation Act of 1987.”

**Section 9.37. Objectives and Functional Statements**

**9.37.1. Objectives and Functional Statements**

**9.37.1.1. Attributions to Acceptable Solutions**

**1)** For the purpose of compliance with this Code as required in Clause 1.2.1.1.(1)(b) of Division A, the objectives and functional statements attributed to the acceptable solutions in this Part shall be the objectives and functional statements listed in Table 9.37.1.1. (See Note A-1.1.2.1.(1).)

**Table 9.37.1.1.**  
**Objectives and Functional Statements Attributed to the**  
**Acceptable Solutions in Part 9**  
 Forming Part of Sentence 9.37.1.1.(1)

Functional Statements and Objectives <sup>(1)</sup>	
<b>9.1.2.1. Floor Area Limits for Secondary Suites</b>	
(1)	[F05-OS1.5] [F05-OS3.7]
<b>9.3.1.1. General</b>	
(1)	[F20-OS2.1] [F20,F21,F80-OS2.3]  [F20-OP2.1,OP2.4] [F21-OP2.3,OP2.4] [F20,F80-OP2.3]  [F20,F21,F80-OH1.1] Applies where concrete supports or is used in the walls of <i>chimneys</i> or fireplaces. [F20,F21,F55,F61,F80-OH1.1,OH1.2] [F20,F21,F61,F80-OH1.3] Applies where concrete supports or is used in an environmental separator.  [F20,F21,F80-OH4] Applies where concrete elements support wood-frame floors.  [F20,F21,F80-OS3.1,OS3.7] Applies to concrete floors or steps, concrete that supports wood-frame floors or steps, and concrete steps that support <i>guards</i> or handrails. [F20,F21,F80-OS3.4] Applies where concrete supports or is used in <i>chimneys</i> or fireplaces.  [F20,F21,F80-OS1.1] Applies where concrete supports or is used in <i>chimneys</i> or fireplaces.
(4)	[F20-OS2.1] [F80-OS2.3] [F20-OS2.3] Applies to elements that support or are part of an environmental separator.  [F20-OP2.1,OP2.4] [F21,F80-OP2.3,OP2.4] [F20-OP2.3] Applies to elements that support or are part of an environmental separator.  [F20,F21,F80-OH1.1] Applies where concrete supports or is used in the walls of <i>chimneys</i> or fireplaces. [F20,F21,F80,F61,F55-OH1.1,OH1.2] [F20,F21,F80,F61-OH1.3] Applies to elements that support or are part of an environmental separator.  [F20,F21,F80-OH4] Applies to elements that support floors.  [F20,F80-OS3.1] Applies to concrete that supports wood-frame floors or steps. [F20,F80-OS3.4,OS3.7] Applies where concrete supports or is used in <i>chimneys</i> or fireplaces.  [F20,F80-OS1.1] Applies where concrete supports or is used in <i>chimneys</i> or fireplaces.

**Table 9.37.1.1. (Continued)**

Functional Statements and Objectives <sup>(1)</sup>	
<b>9.3.1.2. Cement</b>	
(1)	[F20-OS2.1] [F80-OS2.3] [F20-OS2.3] Applies to elements that support or are part of an environmental separator.  [F20-OP2.1,OP2.4] [F80-OP2.3,OP2.4] [F20-OP2.3] Applies to elements that support or are part of an environmental separator.  [F20,F80-OH1.1] Applies where concrete supports or is used in the walls of <i>chimneys</i> or fireplaces. [F20,F80,F61,F55-OH1.1,OH1.2] [F20,F80,F61-OH1.3] Applies where concrete supports or is used in an environmental separator.  [F20,F80-OH4] Applies where concrete elements support wood-frame floors.  [F20,F80-OS3.1] Applies to concrete floors or steps, concrete that supports wood-frame floors or steps, and concrete steps that support <i>guards</i> or handrails. [F20,F80-OS3.4,OS3.7] Applies where concrete supports or is used in <i>chimneys</i> or fireplaces.  [F20,F80-OS1.1] Applies where concrete supports or is used in <i>chimneys</i> or fireplaces.
<b>9.3.1.3. Concrete in Contact with Sulphate Soil</b>	
(1)	[F20-OS2.1] [F80-OS2.3] [F20-OS2.3] Applies to elements that support or are part of an environmental separator.  [F20-OP2.1,OP2.4] [F80-OP2.3,OP2.4] [F20-OP2.3] Applies to elements that support or are part of an environmental separator.  [F80-OH1.1] Applies where concrete supports or is used in the walls of <i>chimneys</i> or fireplaces. [F80-OH1.1,OH1.2,OH1.3] Applies where concrete supports or is used in an environmental separator.  [F80-OH4] Applies where concrete elements support wood-frame floors.  [F80-OS3.1] Applies to concrete floors or steps, concrete that supports wood-frame floors or steps, and concrete steps that support <i>guards</i> or handrails. [F80-OS3.4,OS3.7] Applies where concrete supports or is used in <i>chimneys</i> or fireplaces.  [F80-OS1.1] Applies where concrete is used in footings for <i>chimneys</i> or fireplaces.

Copyright © NRC 1941 - 2021 World Rights Reserved © CNRC 1941-2021 Droits réservés pour tous pays



**Table 9.37.1.1. (Continued)**

Functional Statements and Objectives <sup>(1)</sup>	
<b>9.3.1.4. Aggregates</b>	
(1)	[F20-OS2.1] [F80-OS2.3] [F20-OS2.3] Applies to elements that support or are part of an environmental separator.
	[F20-OP2.1,OP2.4] [F80-OP2.3,OP2.4] [F20-OP2.3] Applies to elements that support or are part of an environmental separator.
	[F20,F80,F61,F55-OH1.1,OH1.2] Applies to elements that support or are part of an environmental separator and to masonry used in <i>chimneys</i> and fireplaces. [F20,F80,F61-OH1.3] Applies to elements that support or are part of an environmental separator and to masonry used in <i>chimneys</i> and fireplaces.
	[F20,F80-OS1.1] Applies to concrete used in <i>chimneys</i> or fireplaces.
	[F20,F80-OS3.1] Applies to floors and elements that support floors. [F20,F80-OS3.4] Applies to concrete used in <i>chimneys</i> or fireplaces.
	[F20,F80-OH4] Applies to floors and elements that support floors.
<b>9.3.1.5. Water</b>	
(1)	[F20-OS2.1] [F80-OS2.3] [F20-OS2.3] Applies to elements that support or are part of an environmental separator.
	[F20-OP2.1,OP2.4] [F80-OP2.3,OP2.4] [F20-OP2.3] Applies to elements that support or are part of an environmental separator.
	[F20,F80,F61,F55-OH1.1,OH1.2] Applies to elements that support or are part of an environmental separator and to masonry used in <i>chimneys</i> and fireplaces. [F20,F80,F61-OH1.3] Applies to elements that support or are part of an environmental separator and to masonry used in <i>chimneys</i> and fireplaces.
	[F20,F80-OH4] Applies where concrete elements support wood-frame floors.
	[F20,F80-OS3.1] Applies to concrete floors or steps, concrete that supports wood-frame floors or steps, and concrete steps that support <i>guards</i> or handrails. [F20,F80-OS3.4,OS3.7] Applies where concrete supports or is used in <i>chimneys</i> or fireplaces.
	[F20,F80-OS1.1] Applies where concrete supports or is used in <i>chimneys</i> or fireplaces.

**Table 9.37.1.1. (Continued)**

Functional Statements and Objectives <sup>(1)</sup>	
<b>9.3.1.6. Compressive Strength</b>	
(1)	(a) [F20-OS2.1] (a) [F21,F80-OS2.3] (a) [F20-OS2.3] Applies to elements that support or are part of an environmental separator.
	(a) [F20-OP2.1,OP2.4] (a) [F21-OP2.3,OP2.4] (a) [F80-OP2.3] (a) [F20-OP2.3] Applies to elements that support or are part of an environmental separator.
	(a) [F20,F80-OH1.1] Applies where concrete supports or is used in the walls of <i>chimneys</i> or fireplaces. (a) [F20,F80,F61,F55-OH1.1,OH1.2] [F20,F80,F61-OH1.3] Applies where concrete supports or is used in an environmental separator.
	(a) [F20,F21,F80-OH4] Applies to elements that support floors.
	(a) [F20,F80-OS3.1] Applies to elements that support floors or steps. (a) [F20,F80-OS3.4,OS3.7] Applies where concrete supports or is used in <i>chimneys</i> or fireplaces.
	(a) [F20,F21,F80-OS1.1] Applies where concrete supports or is used in <i>chimneys</i> or fireplaces.
	(b) [F20-OS2.1] (b) [F21,F80-OS2.3] (b) [F20-OS2.3] Applies to elements that support or are part of an environmental separator.
	(b) [F20-OP2.1,OP2.4] (b) [F21-OP2.3,OP2.4] (b) [F80-OP2.3] (b) [F20-OP2.3] Applies to elements that support or are part of an environmental separator.
	(b) [F20,F21,F80,F61,F55-OH1.1,OH1.2] [F20,F21,F80,F61-OH1.3]
	(b) [F20,F21,F80-OS3.1]
	(c) [F20-OS2.1] [F20,F21,F80-OS2.3]
	(c) [F20-OP2.1] [F20,F21,F80-OP2.3,OP2.4]
	(c) [F20,F21,F80-OS3.1]
(2)	[F80-OS3.1]

Table 9.37.1.1. (Continued)

Functional Statements and Objectives <sup>(1)</sup>	
<b>9.3.1.7. Concrete Mixes</b>	
(1)	(a) [F20-OS2.1] (a) [F21-OS2.3] (a) [F20,F61,F55-OS2.3] Applies to elements that support or are part of an environmental separator.
	(a) [F20-OP2.1,OP2.4] (a) [F21-OP2.3,OP2.4] (a) [F20,F55,F61-OP2.3] Applies to elements that support or are part of an environmental separator.
	(a) [F20,F21,F80-OH1.1] Applies where concrete supports or is used in the walls of <i>chimneys</i> or fireplaces. (a) [F20,F21,F80,F61,F55-OH1.1,OH1.2] [F20,F21,F80,F61-OH1.3] Applies where concrete supports or is used in an environmental separator.
	(a) [F20,F21,F61-OH4] Applies to elements that support floors.
	(a) [F20,F21,F61-OS3.1] Applies to concrete floors or steps, concrete that supports wood-frame floors or steps, and concrete steps that support <i>guards</i> or handrails. (a) [F20,F21,F61-OS3.4,OS3.7] Applies where concrete supports or is used in <i>chimneys</i> or fireplaces.
	(a) [F20,F21,F61-OS1.1] Applies where concrete supports or is used in <i>chimneys</i> or fireplaces.
	(b) [F20-OS2.1] (b) [F21,F80-OS2.3] (b) [F20-OS2.3] Applies where concrete is used in an environmental separator.
	(b) [F20-OP2.1,OP2.4] (b) [F21-OP2.3,OP2.4] (b) [F80-OP2.3] (b) [F20-OP2.3] Applies where concrete is used in an environmental separator.
	(b) [F20,F21,F80,F61,F55-OH1.1,OH1.2] [F20,F21,F80,F61-OH1.3]
	(b) [F20,F21,F80-OS3.1]
	(c) [F20,F21-OS2.1] [F20,F21,F80-OS2.3]
	(c) [F20,F21,F80-OS3.1]
	(c) [F20,F21,F80-OP2.3,OP2.4]

Table 9.37.1.1. (Continued)

Functional Statements and Objectives <sup>(1)</sup>	
(2)	[F20-OS2.1] [F21-OS2.3] [F20,F61,F55-OS2.3] Applies to elements that support or are part of an environmental separator.
	[F20-OP2.1,OP2.4] [F21-OP2.3,OP2.4] [F20,F61,F55-OP2.3] Applies where concrete supports or is used in an environmental separator.
	[F20,F21,F61,F55-OH1.1] Applies where concrete supports or is used in the walls of <i>chimneys</i> or fireplaces. [F20,F21-OH1.2,OH1.3] Applies where concrete supports or is used in an environmental separator.
	[F20,F21,F61,F55-OH4] Applies where concrete elements support wood-frame floors.
	[F20,F80-OS3.1] Applies to concrete floors or steps, concrete that supports wood-frame floors or steps, and concrete steps that support <i>guards</i> or handrails. [F20,F80-OS3.4,OS3.7] Applies where concrete supports or is used in <i>chimneys</i> or fireplaces.
	[F20,F21-OS1.1] Applies where concrete supports or is used in <i>chimneys</i> or fireplaces.
<b>9.3.1.8. Admixtures</b>	
(1)	[F20-OS2.1] [F21-OS2.3] [F20,F61,F55-OS2.3] Applies to elements that support or are part of an environmental separator.
	[F20-OP2.1,OP2.4] [F21-OP2.3,OP2.4] [F80-OP2.3,OP2.4] [F20-OP2.3] Applies to elements that support or are part of an environmental separator.
	[F20,F80-OH1.1] Applies where concrete supports or is used in the walls of <i>chimneys</i> or fireplaces. [F20,F80,F61,F55-OH1.1,OH1.2] [F20,F80,F61-OH1.3] Applies where concrete supports or is used in an environmental separator.
	[F20,F21,F80-OH4] Applies where concrete elements support wood-frame floors.
	[F20,F80-OS3.1] Applies to concrete floors or steps, concrete that supports wood-frame floors or steps, and concrete steps that support <i>guards</i> or handrails. [F20,F80-OS3.4,OS3.7] Applies where concrete supports or is used in <i>chimneys</i> or fireplaces.
	[F20,F21,F80-OS1.1] Applies where concrete supports or is used in <i>chimneys</i> or fireplaces.

**Table 9.37.1.1. (Continued)**

Functional Statements and Objectives <sup>(1)</sup>	
<b>9.3.1.9. Cold Weather Requirements</b>	
(1)	[F20-OS2.1] [F21-OS2.3] [F20-OS2.3] Applies to elements that support or are part of an environmental separator.
	[F20-OP2.1,OP2.4] [F21,F80-OP2.3,OP2.4] [F20-OP2.3] Applies to elements that support or are part of an environmental separator.
	[F20,F80-OH1.1] Applies where concrete supports or is used in the walls of <i>chimneys</i> or fireplaces. [F20,F80,F61,F55-OH1.1,OH1.2] [F20,F80,F61-OH1.3] Applies where concrete supports or is used in an environmental separator.
	[F20,F21,F80-OH4] Applies where concrete elements support wood-frame floors.
	[F20,F80-OS3.1] Applies to concrete floors or steps, concrete that supports wood-frame floors or steps, and concrete steps that support <i>guards</i> or handrails. [F20,F80-OS3.4,OS3.7] Applies where concrete supports or is used in <i>chimneys</i> or fireplaces.
	[F20,F21,F80-OS1.1] Applies where concrete supports or is used in <i>chimneys</i> or fireplaces.
(2)	[F20-OH1.1] Applies where concrete supports or is used in the walls of <i>chimneys</i> or fireplaces. [F20,F61,F55-OH1.1,OH1.2] [F20,F61-OH1.3] Applies where concrete supports or is used in an environmental separator.
	[F20-OS2.1] [F20,F61,F55-OS2.3] Applies to elements that support or are part of an environmental separator.
	[F20-OP2.1,OP2.4] [F20,F61,F55-OP2.3] [F61,F55-OP2.4] Applies to elements that support or are part of an environmental separator.
	[F20-OS1.1] Applies to concrete that supports or is used in <i>chimneys</i> or fireplaces.
	[F20,F61,F55-OS3.1] Applies to floors and elements that support floors. [F20,F61,F55-OS3.4] Applies to concrete that supports or is used in <i>chimneys</i> or fireplaces.
	[F20,F61,F55-OH4] Applies to elements that support floors.

**Table 9.37.1.1. (Continued)**

Functional Statements and Objectives <sup>(1)</sup>	
<b>9.3.2.2. Lumber Grades</b>	
(1)	[F20-OS2.1] [F20,F22-OS2.3] Applies to elements that support or are part of an environmental separator.
	[F20-OP2.1,OP2.4] [F22-OP2.4] [F20,F22-OP2.3] Applies to elements that support or are part of an environmental separator.
	[F22-OS3.1] Applies to floors and elements that support floors. [F22-OS3.7] Applies to walls, or elements that support walls, that contain doors or windows required for emergency egress.
	[F20,F22-OH1.1,OH1.2,OH1.3] Applies to elements that support or are part of an environmental separator.
	[F20,F22-OS1.2] Applies to assemblies required to provide fire resistance.
	[F20,F22-OH4] Applies to floors and elements that support floors.
<b>9.3.2.5. Moisture Content</b>	
(1)	[F21,F80-OS2.3] [F21,F80-OP2.3,OP2.4] [F21,F80-OS3.1] Applies to floors and elements that support floors.
	[F21,F80-OH1.1,OH1.2,OH1.3] Applies to elements that support or are part of an environmental separator.
	[F21,F80-OS1.2] Applies to assemblies required to provide fire resistance.
	[F21,F80-OH4] Applies to floors and elements that support floors.
<b>9.3.2.8. Undersized Lumber</b>	
(1)	[F20-OS2.1] [F20,F22-OS2.3] Applies to elements that support or are part of an environmental separator.
	[F20-OP2.1,OP2.4] [F22-OP2.4] [F20,F22-OP2.3] Applies to elements that support or are part of an environmental separator.
	[F20,F22-OH4] Applies to floors and elements that support floors.
	[F20,F22-OH1.1,OH1.2,OH1.3] Applies to elements that support or are part of an environmental separator.
	[F20,F22-OS1.2] Applies to assemblies required to provide fire resistance.
	[F20,F22-OS3.1] Applies to floors and elements that support floors.

Table 9.37.1.1. (Continued)

Functional Statements and Objectives <sup>(1)</sup>	
<b>9.3.2.9. Termite and Decay Protection</b>	
(1)	[F82,F80-OS2.3]
	[F82,F80-OP2.3,OP2.4]
	[F82,F80,F61,F55-OH1.1,OH1.2] [F82,F80,F61-OH1.3] Applies where structural wood elements support or are used in an environmental separator.
	[F82,F80-OH4] Applies where structural wood elements support or are used in floors.
	[F82,F80-OS3.1] Applies where structural wood elements support or are used in floors.
	[F82,F80-OS1.2] Applies where structural wood elements support or are used in assemblies that are required to provide fire resistance.
(2)	[F80,F82-OS2.3]
	[F80,F82-OP2.3,OP2.4]
	[F82,F80,F61,F55-OH1.1,OH1.2] [F82,F80,F61-OH1.3] Applies where structural wood elements support or are used in an environmental separator.
	[F82,F80-OH4] Applies where structural wood elements support or are used in floors.
	[F82,F80-OS3.1] Applies where structural wood elements support or are used in floors.
	[F82,F80-OS1.2] Applies where structural wood elements support or are used in assemblies that are required to provide fire resistance.
(3)	[F80-OS2.3]
	[F80-OP2.3,OP2.4]
	[F82,F80,F61,F55-OH1.1,OH1.2] [F82,F80,F61-OH1.3] Applies where structural wood elements support or are used in an environmental separator.
	[F80-OH4] Applies where structural wood elements support or are used in floors.
	[F80-OS3.1] Applies where structural wood elements support or are used in floors.
	[F80-OS1.2] Applies where structural wood elements support or are used in assemblies that are required to provide fire resistance.
(4)	[F80-OS2.3,OS2.5]
	[F80-OP2.3,OP2.4,OP2.5]
	[F80,F61,F55-OH1.1,OH1.2] [F80,F61-OH1.3] Applies where cribbing or retaining walls support an environmental separator.
	[F80-OH4] Applies to floors and elements that support floors.
	[F80-OS3.1] Applies where cribbing or retaining walls support floors.
[F80-OS1.2] Applies where cribbing or retaining walls support assemblies that are required to provide fire resistance.	

Table 9.37.1.1. (Continued)

Functional Statements and Objectives <sup>(1)</sup>	
(5)	[F80,F81-OS2.3,OS2.4]
	[F80,F81-OP2.3,OP2.4]
	[F55,F61,F80,F81-OH1.1,OH1.2] [F61,F80,F81-OH1.3] Applies where structural wood elements support or are used in an environmental separator.
	[F80,F81-OH4] Applies where structural wood elements support wood-frame floors.
	[F80,F81-OS3.1] Applies where structural wood elements support or are used in floors.
	[F80,F81-OS1.2] Applies where structural wood elements support or are used in assemblies that are required to provide fire resistance.
(6)	[F20,F60-OS2.3]
	[F20,F61-OP2.3,OP2.4]
	[F20,F55,F61-OH1.1,OH1.2] [F20,F61-OH1.3] Applies where structural wood elements support or are used in an environmental separator.
	[F61,F80-OH4] Applies to floors and elements that support floors.
	[F20,F61-OS3.1] Applies where structural wood elements support or are used in floors.
	[F80,F81-OS1.2] Applies where structural wood elements support or are used in assemblies that are required to provide fire resistance.
<b>9.3.3.2. Galvanized Sheet Steel</b>	
(1)	[F80-OS2.3]
	[F80-OP2.3,OP2.4]
	[F80-OH1.1,OH1.2,OH1.3] Applies where sheet metal is used in an environmental separator.
	[F80-OS3.1] Applies where sheet metal is used in assemblies that support floors.
[F80-OH4] Applies where sheet metal is used in assemblies that support floors.	
(2)	[F80-OS2.3]
	[F80-OP2.3]
	[F80-OH1.1,OH1.2,OH1.3]
<b>9.4.2.2. Specified Snow Loads</b>	
(1)	[F20-OS2.1,OS2.3] [F22-OS2.3]
	[F20-OP2.1,OP2.3] [F22-OP2.3]
	[F22-OH1.1,OH1.2,OH1.3]
(2)	[F20-OS2.1]
	[F20-OP2.1]
<b>9.4.2.3. Platforms Subject to Snow and Occupancy Loads</b>	
(1)	[F20-OS2.1]
	[F20-OP2.1]
<b>9.4.2.4. Attics and Roof Spaces</b>	
(1)	[F20-OS2.1]
	[F20-OP2.1]

**Table 9.37.1.1. (Continued)**

Functional Statements and Objectives <sup>(1)</sup>	
<b>9.4.3.1. Deflections</b>	
(1)	[F22-OS2.3] Applies to elements that support or are part of an environmental separator.
	[F22-OP2.1,OP2.4] [F22-OP2.3] Applies to elements that support or are part of an environmental separator.
	[F22-OH4]
	[F22-OS3.1] Applies to floors and elements that support floors. [F22-OS3.7] Applies to walls, and elements that support walls, that contain doors or windows required for emergency egress.
	[F22-OH1.1,OH1.2,OH1.3] Applies to elements that support or are part of an environmental separator.
<b>9.4.4.1. Allowable Bearing Pressures</b>	
(1)	[F20-OS2.2] [F20-OS2.3] Applies to elements that support or are part of an environmental separator.
	[F20-OP2.2,OP2.4] [F20-OP2.3] Applies to elements that support or are part of an environmental separator.
	[F20-OH1.1,OH1.2,OH1.3] Applies to footings that support an environmental separator.
	[F20-OH4] Applies to footings that support floors and other elements that support floors.
	[F20-OS3.1] Applies to footings that support floors and other elements that support floors. [F20-OS3.7] Applies to footings that support walls that contain doors or windows required for emergency egress.
<b>9.4.4.2. Foundation Capacity in Weaker Soil and Rock</b>	
(1)	[F20-OS2.2] [F20-OS2.3] Applies to elements that support or are part of an environmental separator.
	[F20-OP2.2,OP2.4] [F20-OP2.3] Applies to elements that support or are part of an environmental separator.
	[F20-OH1.1,OH1.2,OH1.3] Applies to elements that support or are part of an environmental separator.
	[F20-OH4] Applies to floors and elements that support floors.
	[F20-OS3.1] Applies to floors and elements that support floors.
(2)	[F20-OS2.2] [F20-OS2.3] Applies to elements that support or are part of an environmental separator.
	[F20-OP2.2,OP2.4] [F20-OP2.3] Applies to elements that support or are part of an environmental separator.
	[F20-OH1.1,OH1.2,OH1.3] Applies to elements that support or are part of an environmental separator.
	[F20-OH4] Applies to floors and elements that support floors.
	[F20-OS3.1] Applies to floors and elements that support floors.

**Table 9.37.1.1. (Continued)**

Functional Statements and Objectives <sup>(1)</sup>	
<b>9.4.4.3. High Water Table</b>	
(1)	[F20-OS2.2] [F20-OS2.3] Applies to elements that support or are part of an environmental separator.
	[F20-OP2.2,OP2.4] [F20-OP2.3] Applies to elements that support or are part of an environmental separator.
	[F20-OH1.1,OH1.2,OH1.3] Applies to elements that support or are part of an environmental separator.
	[F20-OH4] Applies to floors and elements that support floors.
	[F20-OS3.1] Applies to floors and elements that support floors.
<b>9.4.4.4. Soil Movement</b>	
(1)	[F21-OS2.1] [F21-OS2.3] Applies to elements that support or are part of an environmental separator.
	[F21-OP2.1,OP2.4] [F21-OP2.3] Applies to elements that support or are part of an environmental separator.
	[F21-OH1.1,OH1.2,OH1.3] Applies to walls that support or are part of an environmental separator.
	[F21-OH4] Applies to <i>foundations</i> that support floors and other elements that support floors.
	[F21-OS3.1] Applies to footings that support floors and other elements that support floors. [F21-OS3.7] Applies to footings that support walls that contain doors or windows required for emergency egress.
<b>9.4.4.5. Retaining Walls</b>	
(1)	[F20-OS2.1,OS2.3] [F20-OP2.1,OP2.3,OP2.4] [F20-OH1.1,OH1.2,OH1.3] [F20-OH4] Applies to floors and elements that support floors. [F20-OS3.1] Applies to floors and elements that support floors.
<b>9.4.4.6. Walls Supporting Drained Earth</b>	
(1)	[F20-OS2.1,OS2.3] [F20-OP2.1,OP2.3,OP2.4] [F20-OH1.1,OH1.2,OH1.3] [F20-OH4] Applies to floors and elements that support floors. [F20-OS3.1] Applies to floors and elements that support floors. [F20-OS3.7] Applies to walls, and elements that support walls, that contain doors or windows required for emergency egress.
(2)	[F20-OS2.1,OS2.3] [F20-OP2.1,OP2.3,OP2.4] [F20-OH1.1,OH1.2,OH1.3] [F20-OH4] Applies to floors and elements that support floors. [F20-OS3.1] Applies to floors and elements that support floors. [F20-OS3.7] Applies to walls, and elements that support walls, that contain doors or windows required for emergency egress.
<b>9.5.1.2. Combination Rooms</b>	
(2)	[F10-OS3.7]

Table 9.37.1.1. (Continued)

Functional Statements and Objectives <sup>(1)</sup>	
<b>9.5.3.1. Ceiling Heights of Rooms or Spaces</b>	
(1)	[F30-OS3.1] [F10-OS3.7]
(2)	[F30-OS3.1] [F10-OS3.7]
(3)	[F30-OS3.1] [F10-OS3.7]
(4)	[F30-OS3.1] [F10-OS3.7]
<b>9.5.3.2. Mezzanines</b>	
(1)	[F30-OS3.1] [F10-OS3.7]
<b>9.5.3.3. Storage Garages</b>	
(1)	[F30-OS3.1] [F10-OS3.7]
<b>9.5.4.1. Hallway Width</b>	
(1)	[F10-OS3.7]
<b>9.5.5.1. Doorway Opening Sizes</b>	
(1)	[F30-OS3.1] [F10-OS3.7]
(2)	[F10-OS3.7] [F30-OS3.1]
<b>9.5.5.2. Doorways to Public Water-Closet Rooms</b>	
(1)	[F30-OS3.1] [F10-OS3.7]
<b>9.5.5.3. Doorways to Rooms with a Bathtub, Shower or Water Closet</b>	
(2)	[F74-OA2]
<b>9.6.1.2. Material Standards for Glass</b>	
(1)	[F20-OS2.1] [F63-OS2.3]
	(e),(h) [F63-OH1.1] [F51,F63-OH1.2]
	(g) [F03-OS1.2]
(2)	[F30-OS3.1] [F10-OS3.7]
<b>9.6.1.3. Structural Sufficiency of Glass</b>	
(1)	[F20-OS2.1]
(2)	[F20-OS2.1]
(3)	[F30-OS3.1] [F10-OS3.7]
<b>9.6.1.4. Types of Glass and Protection of Glass</b>	
(1)	[F30-OS3.1] [F10-OS3.7]
(3)	[F30-OS3.1] [F10-OS3.7]
(4)	[F30-OS3.1] [F10-OS3.7] Applies to portion of Code text: "... except that such <i>partitions</i> shall be suitably marked to indicate their existence and position."
(5)	[F30-OS3.1] [F10-OS3.7]
(6)	[F20,F30-OS3.1]
<b>9.7.2.1. Entrance Doors</b>	
(1)	[F42-OH2.5]
	[F51,F54-OH1.2] [F40,F61,F42-OH1.1]
	[F61,F42-OS2.3]
(2)	[F35-OS4.2]

Table 9.37.1.1. (Continued)

Functional Statements and Objectives <sup>(1)</sup>	
<b>9.7.3.1. General Performance Expectations</b>	
(1)	[F42,F55,F61,F62,F63-OH1.1]
	[F81-OH1.1] Applies to windows that provide required non-heating season ventilation.
	[F54,F55,F61,F62,F63-OH1.2] [F61,F62,F63-OH1.3]
	[F20,F55,F61-OS2.1,OS2.3]
	[F42-OH2.5]
	[F81-OS3.7]
	[F34-OS4.1]
(2)	[F81-OH1.1] Applies to skylights that provide required non-heating season ventilation.
	[F20,F22-OH1.3]
	[F20-OS2.1,OS2.3]
(3)	[F55-OH1.1]
	[F81-OS3.7]
	[F34-OS4.1]
(4)	[F20,F22-OS2.3]
	[F30-OS3.1]
	[F20,F61-OH1.1,OH1.2]
	[F34-OS4.1]
<b>9.7.3.2. Heat Transfer Performance</b>	
(1)	[F51,F63-OH1.1,OH1.2]
	[F63-OS2.3]
<b>9.7.3.3. Thermal Characteristics of Windows, Doors and Skylights</b>	
(1)	[F63-OH1.1,OH1.2,OH1.3]
	[F63-OS2.3]
(3)	[F63-OH1.1,OH1.2,OH1.3]
	[F63-OS2.3]
(4)	[F63-OH1.1,OH1.2,OH1.3]
	[F63-OS2.3]
	[F63-OS3.1]
<b>9.7.4.2. General</b>	
(1)	[F20,F55,F61,F62,F63-OH1.1]
	[F81-OH1.1] Applies to windows that provide required non-heating season ventilation.
	[F54,F55,F61,F62,F63-OH1.2] [F20,F61,F62,F63-OH1.3]
	[F20,F21,F61-OS2.3]
	[F10-OS1.5] Applies where windows, doors or skylights serve bedrooms, except bedrooms that have direct access to the exterior through an <i>exit</i> door or bedrooms that are in <i>sprinklered suites</i> .
<b>9.7.4.3. Performance Requirements</b>	
(1)	[F20,F55,F61-OH1.1]
	[F55-OH1.2] [F20,F61,F62-OH1.3]
(3)	[F40,F42,F61-OH1.1] [F54,F55,F61,F62-OH1.2] [F61,F62,F63-OH1.3]

**Table 9.37.1.1. (Continued)**

Functional Statements and Objectives <sup>(1)</sup>	
(4)	[F40,F61,F42-OH1.1] [F51,F54-OH1.2]
	[F61,F42-OS2.3]
	[F80-OS3.7]
	[F80-OS4.1]
	[F42-OH2.5]
<b>9.7.5.2. Resistance to Forced Entry for Doors</b>	
(2)	[F34-OS4.1]
(3)	[F20-OS4.1]
(4)	[F34-OS4.1]
(5)	[F34-OS4.1]
(6)	[F20-OS4.1]
(7)	[F20-OS4.1]
(8)	[F34-OS4.1]
(9)	[F20-OS4.1]
<b>9.7.5.3. Resistance to Forced Entry for Windows</b>	
(1)	[F34-OS4.1]
<b>9.7.6.1. Installation of Windows, Doors and Skylights</b>	
(1)	[F20,F54,F55,F61,F63-OH1.1,OH1.2,OH1.3]
	[F20,F61,F63-OS2.3]
(2)	[F54,F55,F61,F63-OH1.1,OH1.2,OH1.3]
	[F61,F63-OS2.3]
(3)	[F55,F61,F63-OS2.3]
	[F55,F61,F63-OH1.1,OH1.2,OH1.3]
<b>9.7.6.2. Sealants, Trim and Flashing</b>	
(1)	[F61,F63-OH1.1,OH1.3] [F51,F54,F61,F63-OH1.2]
	[F61,F63-OS2.3]
(4)	[F80-OS2.1,OS2.3]
	[F80-OP2.1,OP2.3]
	[F80-OH1.1,OH1.2,OH1.3]
<b>9.8.2.1. Stair Width</b>	
(1)	[F30-OS3.1] [F10-OS3.7]
(2)	[F30-OS3.1] [F10-OS3.7]
(3)	[F30-OS3.1] [F10-OS3.7]
(4)	[F30-OS3.1] [F10-OS3.7]
<b>9.8.2.2. Height over Stairs</b>	
(2)	[F30-OS3.1] [F10-OS3.7]
(3)	[F30-OS3.1] [F10-OS3.7]
(4)	[F30-OS3.1] [F10-OS3.7]
<b>9.8.3.1. Permitted Configurations</b>	
(1)	[F30-OS3.1] [F10-OS3.7]
(2)	[F10-OS3.7]
(3)	[F30-OS3.1] [F10-OS3.7]
(4)	[F30-OS3.1] [F10-OS3.7]

**Table 9.37.1.1. (Continued)**

Functional Statements and Objectives <sup>(1)</sup>	
(5)	[F30-OS3.1] [F10-OS3.7]
<b>9.8.3.2. Minimum Number of Risers</b>	
(1)	[F30-OS3.1] [F10-OS3.7]
<b>9.8.3.3. Maximum Height of Stairs</b>	
(1)	[F30-OS3.1]
<b>9.8.4.1. Dimensions for Risers</b>	
(1)	[F30-OS3.1] [F10-OS3.7]
<b>9.8.4.2. Dimensions for Rectangular Treads</b>	
(1)	[F30-OS3.1] [F10-OS3.7]
(2)	[F30-OS3.1] [F10-OS3.7]
<b>9.8.4.3. Dimensions of Tapered Treads</b>	
(1)	[F30-OS3.1] [F10-OS3.7]
(3)	[F30-OS3.1] [F10-OS3.7]
<b>9.8.4.4. Uniformity and Tolerances for Risers, Runs and Treads</b>	
(1)	[F30-OS3.1] [F10-OS3.7]
(2)	[F30-OS3.1] [F10-OS3.7]
(3)	[F30-OS3.1] [F10-OS3.7]
(4)	[F30-OS3.1] [F10-OS3.7]
(5)	[F30-OS3.1] [F10-OS3.7]
<b>9.8.4.5. Uniformity of Runs in Flights with Mixed Treads within Dwelling Units</b>	
(1)	[F30-OS3.1] [F10-OS3.7]
(2)	[F30-OS3.1] [F10-OS3.7]
<b>9.8.4.6. Winders</b>	
(1)	[F30-OS3.1] [F10-OS3.7]
(2)	[F30-OS3.1] [F10-OS3.7]
<b>9.8.4.7. Spiral Stairs</b>	
(1)	F30-OS3.1
(2)	[F30-OS3.1] [F10-OS3.7]
(3)	[F30-OS3.1] [F10-OS3.7]
<b>9.8.4.8. Tread Nosings</b>	
(1)	[F30-OS3.1] [F10-OS3.7]
(2)	[F30-OS3.1] [F10-OS3.7]
<b>9.8.5.2. Ramp Width</b>	
(1)	[F30-OS3.1] [F10-OS3.7]
(2)	[F30-OS3.1] [F10-OS3.7]
<b>9.8.5.3. Height over Ramps</b>	
(1)	[F30-OS3.1] [F10-OS3.7]
(2)	[F30-OS3.1] [F10-OS3.7]
<b>9.8.5.4. Ramp Slope</b>	
(1)	[F30-OS3.1] [F10-OS3.7]
<b>9.8.5.5. Maximum Rise</b>	
(1)	[F30-OS3.1]

Table 9.37.1.1. (Continued)

Functional Statements and Objectives <sup>(1)</sup>	
<b>9.8.6.2. Required Landings</b>	
(1)	[F30-OS3.1] [F10-OS3.7]
<b>9.8.6.3. Dimensions of Landings</b>	
(1)	[F30-OS3.1] [F10-OS3.7]
(2)	[F30-OS3.1] [F10-OS3.7]
(4)	[F30-OS3.1] [F10-OS3.7]
(5)	[F30-OS3.1] [F10-OS3.7]
(6)	[F30-OS3.1] [F10-OS3.7]
(7)	[F30-OS3.1] [F10-OS3.7]
<b>9.8.6.4. Height over Landings</b>	
(1)	[F30-OS3.1] [F10-OS3.7]
(2)	[F30-OS3.1] [F10-OS3.7]
<b>9.8.7.1. Required Handrails</b>	
(1)	[F30-OS3.1] [F10-OS3.7]
(2)	[F10-OS3.7] [F30-OS3.1]
(5)	[F30-OS3.1] [F10-OS3.7]
<b>9.8.7.2. Continuity of Handrails</b>	
(1)	[F30-OS3.1] [F10-OS3.7]
(2)	[F30-OS3.1] [F10-OS3.7] [F73-OA1]
<b>9.8.7.3. Termination of Handrails</b>	
(1)	[F30-OS3.1] [F10-OS3.7]
(2)	[F30-OS3.1] [F10-OS3.7]
<b>9.8.7.4. Height of Handrails</b>	
(2)	[F30-OS3.1] [F10-OS3.7]
<b>9.8.7.5. Ergonomic Design</b>	
(1)	[F30-OS3.1] [F10-OS3.7]
(2)	[F30-OS3.1] [F10-OS3.7]
<b>9.8.7.6. Projections into Stairs and Ramps</b>	
(1)	[F30-OS3.1] [F10-OS3.7]
<b>9.8.7.7. Design and Attachment of Handrails</b>	
(1)	[F20-OS2.1] [F20-OS3.1,OS3.7]
(2)	[F20-OS2.1] [F20-OS3.1,OS3.7]
<b>9.8.8.1. Required Guards</b>	
(1)	[F30-OS3.1] [F10-OS3.7]
(3)	[F30-OS3.1] [F10-OS3.7]
(4)	[F30-OS3.1]
(6)	[F30-OS3.1] [F10-OS3.7]
(7)	[F30-OS3.1] [F10-OS3.7]
(8)	[F30-OS3.1]

Table 9.37.1.1. (Continued)

Functional Statements and Objectives <sup>(1)</sup>	
<b>9.8.8.2. Loads on Guards</b>	
(1)	[F20-OS2.1]
<b>9.8.8.3. Height of Guards</b>	
(1)	[F30-OS3.1] [F10-OS3.7]
(2)	[F30-OS3.1] [F10-OS3.7]
(3)	[F30-OS3.1] [F10-OS3.7]
(4)	[F30-OS3.1] [F10-OS3.7]
<b>9.8.8.4. Guards for Floors and Ramps in Garages</b>	
(1)	[F10-OS3.1]
(2)	[F20-OS2.1]
<b>9.8.8.5. Openings in Guards</b>	
(1)	[F30-OS3.1]
(2)	[F30-OS3.1]
(3)	[F30-OS3.1]
<b>9.8.8.6. Design of Guards to Not Facilitate Climbing</b>	
(1)	[F30-OS3.1]
<b>9.8.8.7. Glass in Guards</b>	
(1)	[F20-OS3.1,OS3.7] [F20-OS2.1]
<b>9.8.9.1. Loads on Stairs and Ramps</b>	
(1)	[F20-OS2.1] [F22-OH4]
<b>9.8.9.2. Exterior Concrete Stairs</b>	
(1)	[F22-OS3.1,OS3.7]
<b>9.8.9.3. Exterior Wood Steps</b>	
(1)	[F80-OS3.1,OS3.7] [F80-OS2.3]
<b>9.8.9.4. Wooden Stair Stringers</b>	
(1)	[F20-OS2.1] [F22-OH4]
(2)	[F22-OH4] [F20-OS2.1]
<b>9.8.9.5. Treads</b>	
(1)	[F22-OH4] [F20-OS2.1]
(2)	[F22-OH4] [F20-OS2.1]
<b>9.8.9.6. Finish for Treads and Landings</b>	
(1)	[F30-OS3.1] [F10-OS3.7]
(2)	[F30-OS3.1] [F10-OS3.7]
<b>9.8.10.1. Design</b>	
(1)	[F22-OS3.1,OS3.7] [F20-OS2.1]



**Table 9.37.1.1. (Continued)**

Functional Statements and Objectives <sup>(1)</sup>	
<b>9.8.10.2. Anchorage</b>	
(1)	[F20-OS2.1]
	[F22-OS3.1,OS3.7]
	[F20-OH1.1,OH1.2,OH1.3]
<b>9.8.10.3. Prevention of Damage Due to Frost</b>	
(1)	[F21-OS3.1]
	[F21-OS2.1]
	[F21-OH1.1,OH1.2,OH1.3]
<b>9.9.1.3. Occupant Load</b>	
(1)	[F10-OS3.7]
(2)	[F10-OS3.7]
<b>9.9.2.2. Purpose of Exits</b>	
(1)	[F10-OS3.7] Applies to "An exit shall be designed for no purpose other than for exiting ..."
<b>9.9.2.3. Elevators, Slide Escapes and Windows as Means of Egress</b>	
(1)	[F10-OS3.7]
<b>9.9.2.4. Principal Entrances</b>	
(1)	[F10-OS3.7]
<b>9.9.3.2. Exit Width</b>	
(1)	[F10-OS3.7]
<b>9.9.3.3. Width of Corridors</b>	
(1)	[F30-OS3.1] [F10-OS3.7]
<b>9.9.3.4. Clear Height</b>	
(1)	[F30-OS3.1] [F10-OS3.7]
(2)	[F30-OS3.1] [F10-OS3.7]
<b>9.9.4.2. Fire Separations for Exits</b>	
(1)	[F05-OS1.5] [F03-OS1.2]
	[F03-OP1.2]
(2)	[F03-OS1.2] [F05-OS1.5]
	[F03-OP1.2]
(3)	[F05-OS1.5]
(4)	[F05-OS1.5] [F03-OS1.2]
	[F03-OP1.2]
<b>9.9.4.3. Wired Glass or Glass Block</b>	
(2)	[F05-OS1.5]
<b>9.9.4.4. Openings Near Unenclosed Exterior Exit Stairs and Ramps</b>	
(1)	[F05-OS1.5]
<b>9.9.4.5. Openings in Exterior Walls of Exits</b>	
(1)	[F05-OS1.5]
<b>9.9.4.6. Openings Near Exit Doors</b>	
(1)	[F05-OS1.5]

**Table 9.37.1.1. (Continued)**

Functional Statements and Objectives <sup>(1)</sup>	
<b>9.9.4.7. Stairways in 2 Storey, Group D or E Buildings</b>	
(1)	[F05-OS1.5]
<b>9.9.5.2. Occupancies in Corridors</b>	
(1)	[F10-OS3.7]
<b>9.9.5.3. Obstructions in Public Corridors</b>	
(1)	[F30-OS3.1]
<b>9.9.5.4. Obstructions in Exits</b>	
(1)	[F10-OS3.7]
<b>9.9.5.5. Obstructions in Means of Egress</b>	
(1)	[F10-OS3.7]
(2)	[F10-OS3.7]
<b>9.9.5.6. Mirrors or Draperies</b>	
(1)	[F10-OS3.7] [F30-OS3.1]
<b>9.9.5.7. Fuel-Fired Appliances</b>	
(1)	[F10-OS1.5]
	[F10-OS3.7]
<b>9.9.5.8. Service Rooms</b>	
(1)	[F10-OS3.7] [F30-OS3.1]
<b>9.9.5.9. Ancillary Rooms</b>	
(1)	[F05,F06-OS1.5]
	[F10-OS3.7]
<b>9.9.6.1. Obstructions by Doors</b>	
(2)	[F30-OS3.1] [F10-OS3.7]
(3)	[F30-OS3.1] [F10-OS3.7]
<b>9.9.6.2. Clear Opening Height at Doorways</b>	
(1)	[F30-OS3.1] [F10-OS3.7]
(2)	[F30-OS3.1] [F10-OS3.7]
<b>9.9.6.3. Clear Opening Width at Doorways</b>	
(2)	[F30-OS3.1] [F10-OS3.7]
(3)	[F30-OS3.1] [F10-OS3.7]
<b>9.9.6.4. Door Action</b>	
(1)	[F10-OS3.7]
(2)	[F10-OS3.7]
<b>9.9.6.5. Direction of Door Swing</b>	
(1)	[F10-OS3.7]
(2)	[F10-OS3.7]
(3)	[F10-OS3.7]
(4)	[F10-OS3.7]
<b>9.9.6.6. Nearness of Doors to Stairs</b>	
(1)	[F30-OS3.1] [F10-OS3.7]
(2)	[F10-OS3.7]

Copyright © NRC 1941 - 2021 World Rights Reserved © CNRC 1941-2021 Droits réservés pour tous pays

Table 9.37.1.1. (Continued)

Functional Statements and Objectives <sup>(1)</sup>	
<b>9.9.6.7. Door Latching, Locking and Opening Mechanisms</b>	
(1)	(a) [F10-OS3.7]
	(b) [F10,F81-OS3.7]
(2)	[F10-OS3.7]
(3)	[F10-OS3.7]
	[F73-OA1]
(4)	[F10-OS3.7]
<b>9.9.6.8. Effort Required to Open</b>	
(1)	[F10-OS3.7]
<b>9.9.7.1. Egress from Roof Area, Podiums, Terraces, Platforms and Contained Open Spaces</b>	
(1)	[F10-OS3.7]
(2)	[F10-OS3.7]
<b>9.9.7.2. Means of Egress from Suites</b>	
(1)	[F10-OS1.5]
(2)	[F10-OS3.7]
<b>9.9.7.3. Dead-End Corridors</b>	
(1)	[F10-OS3.7]
<b>9.9.7.4. Number and Spacing of Egress Doors</b>	
(1)	[F10-OS3.7]
(2)	[F10-OS1.5]
<b>9.9.7.5. Independent Access to Exit</b>	
(1)	[F10-OS3.7]
<b>9.9.8.2. Number of Required Exits</b>	
(1)	[F10-OS3.7]
<b>9.9.8.3. Contribution of Each Exit</b>	
(1)	[F10-OS3.7]
<b>9.9.8.4. Location of Exits</b>	
(1)	[F10-OS1.5]
<b>9.9.8.5. Exiting through a Lobby</b>	
(1)	[F10-OS1.5]
(2)	[F10-OS1.5]
(3)	[F10-OS1.5]
(4)	[F10-OS1.5]
(5)	[F05-OS1.5]
<b>9.9.8.6. Mezzanine Means of Egress</b>	
(1)	[F05-OS1.5]
(4)	[F05-OS1.5]
<b>9.9.9.1. Travel Limit to Exits or Egress Doors</b>	
(1)	[F10-OS3.7]
(2)	[F10-OS3.7]
(3)	[F10-OS3.7]

Table 9.37.1.1. (Continued)

Functional Statements and Objectives <sup>(1)</sup>	
<b>9.9.9.2. Two Separate Exits</b>	
(1)	[F10-OS3.7]
<b>9.9.9.3. Shared Egress Facilities</b>	
(1)	[F10-OS3.7]
(2)	[F10-OS3.7]
<b>9.9.10.1. Egress Windows or Doors for Bedrooms</b>	
(1)	[F10-OS3.7]
(2)	[F10-OS3.7]
(3)	[F10-OS3.7]
(4)	[F10-OS3.7]
(5)	[F10-OS3.7]
<b>9.9.11.2. Visibility of Exits</b>	
(1)	[F10-OS3.7]
(2)	[F10-OS3.7]
<b>9.9.11.3. Exit Signs</b>	
(1)	[F10-OS3.7]
(2)	[F10-OS3.7]
(3)	[F10,F81-OS3.7]
(4)	[F10,F81-OS3.7]
(5)	[F10-OS3.7]
(6)	[F10-OS3.7]
<b>9.9.11.4. Signs for Stairs and Ramps at Exit Level</b>	
(1)	[F10-OS3.7]
<b>9.9.11.5. Floor Numbering</b>	
(1)	[F10-OS3.7]
	[F73-OA1]
<b>9.9.12.2. Required Lighting in Egress Facilities</b>	
(1)	[F30-OS3.1] [F10-OS3.7]
(2)	[F30-OS3.1] [F10-OS3.7]
<b>9.9.12.3. Emergency Lighting</b>	
(1)	[F30-OS3.1] [F10-OS3.7]
(2)	[F30-OS3.1] [F10-OS3.7]
(3)	[F30-OS3.1] [F10-OS3.7]
(4)	[F30-OS3.1] [F10-OS3.7]
(5)	[F30-OS3.1] [F10-OS3.7]
(7)	[F30-OS3.1] [F10-OS3.7]
<b>9.10.1.2. Testing of Integrated Fire Protection and Life Safety Systems</b>	
(1)	[F02,F81,F82-OS1.2,OS1.5]
	[F02,F81,F82-OP1.2]
<b>9.10.1.3. Items under Part 3 Jurisdiction</b>	
(5)	[F01-OS1.1] Applies to portion of Code text: “ ... facilities for the dispensing of fuel shall not be installed in any <i>building</i> .”

Copyright © NRC 1941 - 2021 World Rights Reserved © CNRC 1941-2021 Droits réservés pour tous pays

**Table 9.37.1.1. (Continued)**

Functional Statements and Objectives <sup>(1)</sup>	
<b>9.10.3.4. Suspended Membrane Ceilings</b>	
(1)	[F04-OS1.3]
	[F04-OP1.3]
<b>9.10.4.3. Basement Storage Garages</b>	
(1)	[F03-OS1.2]
	[F03-OP1.2]
<b>9.10.5.1. Permitted Openings in Wall and Ceiling Membranes</b>	
(1)	[F03-OS1.2] [F04-OS1.3]
	[F03-OP1.2] [F04-OP1.3]
(2)	[F04-OS1.3]
	[F04-OP1.3]
(3)	[F03-OS1.2]
	[F03-OP1.2]
(4)	[F04-OS1.2,OS1.3]
	[F04-OP1.3]
<b>9.10.7.1. Protection of Steel Members</b>	
(1)	[F03-OS1.2] [F04-OS1.3]
	[F03-OP1.2] [F04-OP1.3]
<b>9.10.8.1. Fire-Resistance Ratings for Floors and Roofs</b>	
(1)	[F03-OS1.2] [F04-OS1.2,OS1.3] Applies to portion of Code text: "Except as otherwise provided in this Subsection, the <i>fire-resistance ratings</i> of floors and roofs shall conform to Table 9.10.8.1."
	[F03-OP1.2] [F04-OP1.2,OP1.3] Applies to portion of Code text: "Except as otherwise provided in this Subsection, the <i>fire-resistance ratings</i> of floors and roofs shall conform to Table 9.10.8.1."
<b>9.10.8.2. Fire-Resistance Ratings in Sprinklered Buildings</b>	
(1)	(a),(b) [F02,F82-OS1.3] [F13-OS1.5,OS1.2]
	(a),(b) [F02,F82-OP1.3] [F13-OP1.2]
<b>9.10.8.3. Fire-Resistance Ratings for Walls, Columns and Arches</b>	
(1)	[F04-OS1.2,OS1.3]
	[F04-OP1.2,OP1.3]
(2)	[F04-OS1.2,OS1.3]
	[F04-OP1.2,OP1.3]
<b>9.10.8.4. Support of Noncombustible Construction</b>	
(1)	[F04-OS1.3]
	[F04-OP1.3]
<b>9.10.8.7. Roofs Supporting an Occupancy</b>	
(1)	[F03-OS1.2]
	[F03-OP1.2]
<b>9.10.8.8. Floors of Exterior Passageways</b>	
(1)	[F05-OS1.5] [F06-OS1.5,OS1.2]
	[F04-OP1.3] [F06-OP1.2]

**Table 9.37.1.1. (Continued)**

Functional Statements and Objectives <sup>(1)</sup>	
<b>9.10.9.2. Continuous Barrier</b>	
(1)	[F03-OS1.2]
	[F03-OP1.2]
(2)	[F03-OS1.2]
(3)	[F03-OS1.2]
	[F03-OP1.2]
(4)	[F03-OS1.2]
	[F03-OP1.2]
<b>9.10.9.3. Openings to be Protected with Closures</b>	
(1)	[F03-OS1.2]
	[F03-OP1.2]
(2)	[F03-OS1.2]
	[F03-OP1.2]
<b>9.10.9.4. Floor Assemblies</b>	
(1)	[F03-OS1.2]
	[F03-OP1.2]
<b>9.10.9.6. Penetration of Fire Separations</b>	
(1)	[F03-OS1.2]
	[F03-OP1.2]
(2)	[F03-OS1.2]
	[F03-OP1.2]
(3)	[F03-OP1.2] [F04-OP1.3] Applies to portion of Code text: "Except as provided in Sentences (4) to (12) and Article 9.10.9.7., pipes, ducts, electrical boxes, totally enclosed raceways or other similar service equipment that partly or wholly penetrate an assembly required to have a <i>fire-resistance rating</i> shall be <i>noncombustible</i> ..."
	[F03-OS1.2] [F04-OS1.3] Applies to portion of Code text: " Except as provided in Sentences (4) to (12) and Article 9.10.9.7., pipes, ducts, electrical boxes, totally enclosed raceways or other similar service equipment that partly or wholly penetrate an assembly required to have a <i>fire-resistance rating</i> shall be <i>noncombustible</i> ..."
<b>9.10.9.7. Combustible Drain, Waste and Vent Piping</b>	
(1)	[F03-OS1.2] [F04-OS1.3]
	[F03-OP1.2] [F04-OP1.3]
<b>9.10.9.8. Collapse of Combustible Construction</b>	
(1)	[F03-OS1.2]
	[F03-OP1.2]
<b>9.10.9.9. Reduction in Thickness of Fire Separation by Beams and Joists</b>	
(1)	[F03-OS1.2]
	[F03-OP1.2]
<b>9.10.9.10. Concealed Spaces above Fire Separations</b>	
(1)	[F03-OS1.2]
	[F03-OP1.2]

Table 9.37.1.1. (Continued)

Functional Statements and Objectives <sup>(1)</sup>	
(2)	[F03-OS1.2] [F03-OP1.2]
<b>9.10.9.11. Separation of Residential Occupancies</b>	
(1)	[F03-OS1.2] [F03-OP1.2]
(2)	[F03-OS1.2] [F03-OP1.2]
(3)	[F03-OS1.2] [F03-OP1.2]
<b>9.10.9.12. Residential Suites in Industrial Buildings</b>	
(1)	[F02-OS1.2]
<b>9.10.9.13. Separation of Suites</b>	
(1)	[F03-OS1.2] [F03-OP1.2]
(2)	[F02-OS1.2] [F02-OP1.2]
<b>9.10.9.14. Separation of Residential Suites</b>	
(1)	[F03-OS1.2] [F03-OP1.2]
(3)	[F03-OS1.2]
(4)	[F03-OS1.2] [F03-OP1.2]
<b>9.10.9.15. Separation of Public Corridors</b>	
(1)	[F05,F03-OS1.5] [F06-OS1.5,OS1.2] [F03,F06-OP1.2]
(2)	[F03-OS1.2] [F06,F05-OS1.5] [F03,F06-OP1.2]
(3)	[F03-OS1.2] [F06,F05-OS1.5] [F03,F06-OP1.2]
(4)	[F03-OS1.2] [F03-OP1.2]
<b>9.10.9.16. Separation of Storage Garages</b>	
(1)	[F03-OS1.2] [F03-OP1.2]
(2)	[F03-OS1.2] [F03-OP1.2]
(4)	[F44-OS3.4] [F01-OS1.1]
(5)	[F44-OS3.4] [F01-OS1.1]
<b>9.10.9.17. Separation of Repair Garages</b>	
(1)	[F03-OS1.2] [F03-OP1.2]

Table 9.37.1.1. (Continued)

Functional Statements and Objectives <sup>(1)</sup>	
(3)	[F03-OS1.2] [F03-OP1.2]
(4)	[F44-OS3.4] [F44-OS1.1] [F44-OH1.1]
(5)	[F44-OS3.4] [F44-OS1.1] [F44-OH1.1]
<b>9.10.9.18. Exhaust Ducts Serving More Than One Fire Compartment</b>	
(1)	[F03-OS1.2]
(2)	[F03-OS1.2]
<b>9.10.9.19. Central Vacuum Systems</b>	
(1)	[F03-OS1.2]
<b>9.10.10.3. Separation of Service Rooms</b>	
(1)	[F03-OS1.2] [F03,F81-OS1.4] [F03-OP1.2] [F03,F81-OP1.4]
<b>9.10.10.4. Location of Fuel-Fired Appliances</b>	
(1)	[F03-OS1.2] [F03,F81-OS1.4] [F03-OP1.2] [F03,F81-OP1.4]
<b>9.10.10.5. Incinerators</b>	
(1)	[F03-OS1.2] [F03,F81-OS1.4] [F03-OP1.2] [F03,F81-OP1.4]
(2)	[F01-OS1.1]
(3)	[F01-OS1.1] [F40,F61-OH1.1,OH1.3] [F20-OP2.1] [F80-OP2.3] [F20-OS2.1] [F80-OS2.3] [F01-OP1.1]
(4)	[F01,F02-OS1.2]
<b>9.10.10.6. Storage Rooms</b>	
(1)	[F03-OS1.2] [F03-OP1.2]
<b>9.10.11.1. Required Firewalls</b>	
(1)	[F03-OS1.2] [F03-OP3.1] [F03-OP1.2]
<b>9.10.11.2. Firewalls Not Required</b>	
(1)	[F03-OS1.2] [F03-OP3.1]
(2)	[F03-OS1.2] [F03-OP3.1]

**Table 9.37.1.1. (Continued)**

Functional Statements and Objectives <sup>(1)</sup>	
(3)	[F03-OS1.2]
	[F03-OP3.1]
(4)	[F03-OS1.2]
	[F03-OP3.1]
<b>9.10.12.1. Termination of Floors or Mezzanines</b>	
(1)	[F03-OS1.5]
	[F03-OP1.2,OP1.4]
<b>9.10.12.2. Location of Skylights</b>	
(1)	[F03-OS1.2]
	[F03-OP1.2]
<b>9.10.12.3. Exterior Walls Meeting at an Angle</b>	
(1)	[F03-OS1.2]
	[F03-OP1.2]
(2)	[F03-OS1.2]
	[F03-OP1.2]
(3)	[F03-OS1.2]
	[F03-OP1.2]
<b>9.10.12.4. Protection of Soffits</b>	
(2)	[F03-OS1.2]
	[F03-OP1.2]
(3)	[F03-OS1.2]
	[F03-OP1.2]
<b>9.10.13.1. Closures</b>	
(1)	[F03-OS1.2]
	[F03-OP1.2]
<b>9.10.13.2. Solid Core Wood Door as a Closure</b>	
(2)	[F03-OS1.2]
	[F03-OP1.2]
<b>9.10.13.5. Wired Glass as a Closure</b>	
(2)	[F03-OS1.2]
	[F03-OP1.2]
(3)	[F03-OS1.2]
	[F03-OP1.2]
<b>9.10.13.6. Steel Door Frames</b>	
(1)	[F03-OS1.2]
	[F03-OP1.2]
<b>9.10.13.8. Maximum Size of Opening</b>	
(1)	[F03-OS1.2]
	[F03-OP1.2]
(2)	[F03-OS1.2]
	[F03-OP1.2]

**Table 9.37.1.1. (Continued)**

Functional Statements and Objectives <sup>(1)</sup>	
<b>9.10.13.9. Door Latch</b>	
(1)	[F03-OS1.2]
	[F03-OP1.2]
<b>9.10.13.10. Self-closing Device</b>	
(1)	[F03-OS1.2]
	[F03-OP1.2]
<b>9.10.13.12. Service Room Doors</b>	
(1)	[F30-OS3.1] Applies to portion of Code text: "Swing-type doors shall open into <i>service rooms</i> containing fuel-fired equipment where such doors lead to <i>public corridors</i> or rooms used for assembly ..."
	[F10-OS1.5] Applies to portion of Code text: "... but shall swing outward from such rooms in all other cases."
<b>9.10.13.13. Fire Dampers</b>	
(1)	[F03-OS1.2]
	[F03-OP1.2]
<b>9.10.13.14. Fire Stop Flaps</b>	
(1)	[F03-OS1.2,OS1.3]
	[F03-OP1.2,OP1.3]
<b>9.10.13.15. Doors between Garages and Dwelling Units</b>	
(1)	[F44-OS3.4]
	[F01-OS1.1]
(2)	[F44-OS3.4]
	[F01-OS1.1]
<b>9.10.13.16. Door Stops</b>	
(1)	[F81-OS1.4]
	[F81-OP1.4]
<b>9.10.14.3. Limiting Distance and Fire Department Response</b>	
(1)	[F03-OP3.1]
<b>9.10.14.4. Openings in Exposing Building Face</b>	
(1)	[F03-OP3.1]
(2)	[F03-OP3.1]
(3)	[F03-OP3.1]
(4)	[F03-OP3.1]
(6)	[F03-OP3.1]
(7)	[F03-OP3.1]
<b>9.10.14.5. Construction of Exposing Building Face and Walls above Exposing Building Face</b>	
(1)	[F02,F03-OP3.1]
(2)	[F03-OP3.1]
(3)	[F02,F03-OP3.1]
(4)	[F03-OP3.1]
(6)	[F03-OP3.1]
(7)	[F03-OP3.1]
(8)	[F02,F03-OP3.1]

Table 9.37.1.1. (Continued)

Functional Statements and Objectives <sup>(1)</sup>	
(9)	[F03-OP3.1]
(10)	[F03-OP3.1]
(12)	[F03-OP3.1]
<b>9.10.15.3. Limiting Distance and Firefighting Services</b>	
(1)	[F03-OP3.1]
<b>9.10.15.4. Glazed Openings in Exposing Building Face</b>	
(1)	[F03-OP3.1]
(3)	[F03-OP3.1]
(4)	[F03-OP3.1]
<b>9.10.15.5. Construction of Exposing Building Face of Houses</b>	
(2)	[F02,F03-OP3.1]
(3)	[F02,F03-OP3.1]
(5)	[F03-OP3.1]
(7)	[F02,F03-OP3.1]
(8)	[F03-OP3.1]
(9)	[F03-OP3.1]
(11)	[F03-OP3.1]
<b>9.10.16.1. Required Fire Blocks in Concealed Spaces</b>	
(1)	[F03-OS1.2]
	[F03-OP1.2]
(2)	[F03-OS1.2]
	[F03-OP1.2]
(3)	[F03-OS1.2]
	[F03-OP1.2]
(4)	[F03-OS1.2]
	[F03-OP1.2]
(5)	[F03-OS1.2]
	[F03-OP1.2]
(6)	[F02,F03-OS1.2]
	[F02,F03-OP1.2]
(7)	[F02,F03-OS1.2]
	[F02,F03-OP1.2]
<b>9.10.16.2. Required Fire Blocks in Wall Assemblies</b>	
(1)	[F03-OS1.2]
	[F03-OP1.2]
<b>9.10.16.3. Fire Block Materials</b>	
(1)	[F03-OS1.2]
	[F03-OP1.2]
(2)	[F03-OS1.2]
	[F03-OP1.2]
(3)	[F04-OS1.2]
	[F04-OP1.2]

Table 9.37.1.1. (Continued)

Functional Statements and Objectives <sup>(1)</sup>	
<b>9.10.16.4. Penetration of Fire Blocks</b>	
(1)	[F03-OS1.2]
	[F03-OP1.2]
<b>9.10.17.1. Flame-Spread Rating of Interior Surfaces</b>	
(1)	[F02-OS1.2]
<b>9.10.17.2. Ceilings in Exits or Public Corridors</b>	
(1)	[F05-OS1.5]
<b>9.10.17.3. Walls in Exits</b>	
(1)	[F05-OS1.5]
(2)	[F05-OS1.5]
<b>9.10.17.4. Exterior Exit Passageways</b>	
(1)	[F05-OS1.5]
<b>9.10.17.5. Walls in Public Corridors</b>	
(1)	[F05-OS1.5]
<b>9.10.17.9. Combustible Skylights</b>	
(1)	[F02,F05-OS1.5]
<b>9.10.17.10. Protection of Foamed Plastics</b>	
(1)	(a),(b),(c) [F01,F02,F05-OS1.5]
(2)	[F01-OS1.1] [F02-OS1.2]
	[F01-OP1.1] [F02-OP1.2]
(3)	[F01,F02-OS1.2]
<b>9.10.18.1. Access Provided through a Firewall</b>	
(1)	[F11-OS1.5]
<b>9.10.18.2. Fire Alarm System Required</b>	
(1)	[F11-OS1.5] [F13-OS1.2,OS1.5] [F03-OS1.2]
	[F13-OP1.2]
(2)	[F11-OS1.5]
<b>9.10.18.4. Rooms and Spaces Requiring Heat Detectors or Smoke Detectors</b>	
(1)	[F11-OS1.5]
(2)	[F11-OS1.5]
(3)	[F02-OS1.2] Applies to <i>sprinklered buildings</i> . [F11-OS1.5] Applies to the supervision of the system and the flow alarm.
<b>9.10.18.5. Smoke Detectors in Recirculating Air-Handling Systems</b>	
(1)	[F03-OS1.2]
<b>9.10.18.6. Portions of Buildings Considered as Separate Buildings</b>	
(1)	[F03-OS1.2]
(2)	[F11-OS1.2]
<b>9.10.18.7. Central Vacuum Systems</b>	
(1)	[F03-OS1.2]
<b>9.10.19.1. Required Smoke Alarms</b>	
(1)	[F81,F11-OS1.5]

Copyright © NRC 1941 - 2021 World Rights Reserved © CNRC 1941-2021 Droits réservés pour tous pays

**Table 9.37.1.1. (Continued)**

Functional Statements and Objectives <sup>(1)</sup>	
<b>9.10.19.2. Sound Patterns of Smoke Alarms</b>	
(1)	[F11-OS1.5]
<b>9.10.19.3. Location of Smoke Alarms</b>	
(1)	[F11-OS1.5]
(2)	[F81,F11-OS1.5]
(3)	[F11-OS1.5]
<b>9.10.19.4. Power Supply</b>	
(1)	[F11,F81-OS1.5]
(3)	[F11,F81-OS1.5]
<b>9.10.19.5. Interconnection of Smoke Alarms</b>	
(1)	[F11-OS1.5]
(2)	[F11-OS1.5]
<b>9.10.19.6. Silencing of Smoke Alarms</b>	
(1)	[F11,F81-OS1.5]
<b>9.10.19.7. Instructions for Maintenance and Care</b>	
(1)	[F82-OS1.5]
<b>9.10.19.8. Residential Fire Warning Systems</b>	
(1)	[F81,F11-OS1.5]
<b>9.10.20.1. Windows or Access Panels Required</b>	
(1)	[F12-OS1.2,OS1.5]
	[F12-OP1.2]
(2)	[F12-OS1.5,OS1.2]
	[F12-OP1.2]
<b>9.10.20.2. Access to Basements</b>	
(1)	[F12-OS1.2,OS1.5]
	[F12-OP1.2]
(2)	[F12-OS1.2,OS1.5] Applies to portion of Code text: " Access required in Sentence (1) ... provides an opening not less than 1 100 mm high and 550 mm wide, the sill height of which shall not be more than 900 mm above the floor."
	[F12-OP1.2] Applies to portion of Code text: "Access required in Sentence (1) ... provides an opening not less than 1 100 mm high and 550 mm wide, the sill height of which shall not be more than 900 mm above the floor."
<b>9.10.20.3. Fire Department Access to Buildings</b>	
(1)	[F12-OS1.2,OS1.5]
	[F12-OP1.2]
(2)	[F12-OS1.2,OS1.5]
	[F12-OP1.2]
<b>9.10.20.4. Portable Extinguishers</b>	
(1)	[F81,F02,F12-OS1.2]
	[F81,F02,F12-OP1.2]
<b>9.10.20.5. Freeze Protection of Fire Protection Systems</b>	
(1)	[F81,F02-OS1.2]
	[F81,F02-OP1.2]

**Table 9.37.1.1. (Continued)**

Functional Statements and Objectives <sup>(1)</sup>	
<b>9.10.21.2. Separation of Sleeping Rooms</b>	
(1)	[F03-OS1.2]
	[F03-OP1.2]
<b>9.10.21.3. Floor Assemblies between the First and Second Storey</b>	
(1)	[F03-OS1.2,OS1.5]
	[F03-OP1.2]
<b>9.10.21.4. Walkways Connecting Buildings</b>	
(1)	[F03,F06-OS1.2,OS1.5]
	[F03-OP1.2]
	[F03-OP3.1]
<b>9.10.21.5. Spatial Separations</b>	
(1)	[F03-OP3.1]
<b>9.10.21.6. Flame-Spread Ratings</b>	
(1)	[F05-OS1.5,OS1.2]
<b>9.10.21.7. Smoke Detectors</b>	
(1)	[F11-OS1.5]
<b>9.10.21.8. Portable Fire Extinguishers</b>	
(1)	[F81,F12,F02-OP1.2]
	[F81,F12,F02-OS1.2]
<b>9.10.21.9. Hose Stations</b>	
(1)	[F81,F12,F02-OP1.2]
	[F81,F12,F02-OS1.2]
(2)	[F12-OP1.2]
	[F12-OS1.2]
(3)	[F12-OP1.2]
	[F12-OS1.2]
<b>9.10.22.1. Installation of Cooktops and Ovens</b>	
(1)	[F81,F43,F01-OS1.1]
	[F81,F43-OS3.4]
<b>9.10.22.2. Vertical Clearances above Cooktops</b>	
(1)	[F01-OS1.1,OS1.2]
(2)	[F01-OS1.1,OS1.2]
<b>9.10.22.3. Protection around Cooktops</b>	
(1)	[F01-OS1.1,OS1.2]
(3)	[F01-OS1.1,OS1.2]
<b>9.11.1.1. Required Protection</b>	
(1)	[F56-OH3.1]
(2)	[F56-OH3.1]
(3)	[F56-OH3.1]
<b>9.11.1.2. Determination of Sound Transmission Ratings</b>	
(1)	[F56-OH3.1]
(2)	[F56-OH3.1]

Table 9.37.1.1. (Continued)

Functional Statements and Objectives <sup>(1)</sup>	
<b>9.11.1.4. Adjoining Constructions</b>	
(2)	[F56-OH3.1]
(3)	[F56-OH3.1]
(4)	[F56-OH3.1]
<b>9.12.1.1. Removal of Topsoil and Organic Matter</b>	
(1)	[F40,F41,F20-OH1.1]
(2)	[F81-OS2.3]
	[F81-OP2.3,OP2.4]
	[F81-OH1.1,OH1.2,OH1.3] Applies to elements that support or are part of an environmental separator.
	[F81-OS1.2] Applies to assemblies required to provide fire resistance.
	[F81-OS3.1] Applies to floors and elements that support floors.
(3)	[F20,F21,F40,F41-OH1.1] [F20,F21-OH1.2,OH1.3] Applies to elements that support or are part of an environmental separator.
	[F20-OS2.2,OS2.3] [F21-OS2.3]
	[F20-OP2.2] [F20,F21-OP2.3,OP2.4]
	[F20,F21-OH4] Applies to floors and elements that support floors.
	[F20,F21-OS3.1] Applies to floors and elements that support floors.
<b>9.12.1.2. Standing Water</b>	
(1)	[F60-OS2.2,OS2.3]
	[F60-OP2.2,OP2.3,OP2.4]
	[F60-OH1.1,OH1.2,OH1.3] Applies to elements that support or are part of an environmental separator.
	[F60-OH4] Applies to floors and elements that support floors.
	[F60-OS3.1] Applies to floors and elements that support floors.
<b>9.12.1.3. Protection from Freezing</b>	
(1)	[F21-OS2.3]
	[F21-OP2.3,OP2.4]
	[F21-OH1.1,OH1.2,OH1.3] Applies to elements that support or are part of an environmental separator.
	[F21-OH4] Applies to floors and elements that support floors.
	[F21-OS3.1] Applies to floors and elements that support floors.
<b>9.12.2.1. Excavation to Undisturbed Soil</b>	
(1)	[F20-OS2.2,OS2.3]
	[F20-OP2.2,OP2.3,OP2.4]
	[F20-OH1.1,OH1.2,OH1.3] Applies to elements that support or are part of an environmental separator.
	[F20-OH4] Applies to floors and elements that support floors.
	[F20-OS3.1] Applies to floors and elements that support floors.

Table 9.37.1.1. (Continued)

Functional Statements and Objectives <sup>(1)</sup>	
<b>9.12.2.2. Minimum Depth of Foundations</b>	
(1)	[F21-OS2.3]
	[F21-OP2.3,OP2.4]
	[F21-OH1.1,OH1.2,OH1.3] Applies to elements that support or are part of an environmental separator.
	[F21-OS3.1] Applies to floors, elements that support floors, and concrete steps with more than 2 risers.
	[F21-OH4] Applies to floors and elements that support floors.
(8)	[F21-OS2.3]
	[F21-OP2.3,OP2.4]
	[F21-OS3.1]
	[F21-OH4]
<b>9.12.3.1. Placement of Backfill</b>	
(1)	[F81-OS2.1]
	[F81-OS2.3] Applies to elements that support or are part of an environmental separator.
	[F81-OP2.1]
	[F22-OP2.4]
	[F81-OP2.3] Applies to elements that support or are part of an environmental separator.
	[F81-OH1.1,OH1.2,OH1.3] Applies to elements that support or are part of an environmental separator.
	[F22-OH4] Applies to floors and elements that support floors.
	[F22-OS3.1] Applies to floors and elements that support floors. [F22-OS3.7] Applies to walls, and elements that support walls, that contain doors or windows required for emergency egress.
<b>9.12.3.2. Grading of Backfill</b>	
(1)	[F60,F61-OH1.1,OH1.2,OH1.3]
	[F60,F61-OS2.3]
	[F60,F61-OP2.3]
<b>9.12.3.3. Deleterious Debris and Boulders</b>	
(1)	[F81-OS2.3]
	[F81-OP2.3]
	[F81-OH1.1,OH1.2,OH1.3]
	[F81-OS3.1] Applies to floors and elements that support floors.
(2)	[F20-OS2.1,OS2.3]
	[F20-OP2.1,OP2.3]
	[F20-OH1.1,OH1.2,OH1.3]
	[F20-OS3.1] Applies to floors and elements that support floors.
(3)	[F20-OS2.1,OS2.3]
	[F20-OP2.1,OP2.3]
	[F20-OH1.1,OH1.2,OH1.3]
	[F20-OS3.1] Applies to floors and elements that support floors.

Copyright © NRC 1941 - 2021 World Rights Reserved © CNRC 1941-2021 Droits réservés pour tous pays



**Table 9.37.1.1. (Continued)**

Functional Statements and Objectives <sup>(1)</sup>	
<b>9.12.4.1. Support of Footings</b>	
(1)	[F21-OH1.1,OH1.2,OH1.3]
	[F21-OS2.1] [F21-OS2.3] Applies to elements that support or are part of an environmental separator.
	[F21-OP2.2] [F21-OP2.3] Applies to elements that support or are part of an environmental separator.
	[F21-OH2.1] Applies to sewer-line locations beneath footings.
	[F21-OS3.1] Applies to floors and elements that support floors.
<b>9.13.2.1. Required Dampproofing</b>	
(1)	[F61-OH1.1,OH1.2,OH1.3]
	[F61-OS2.3]
(2)	[F61-OH1.1,OH1.2,OH1.3]
	[F61-OS2.3]
<b>9.13.2.2. Dampproofing Materials</b>	
(1)	[F40-OH1.1] [F61-OH1.1,OH1.2,OH1.3]
	[F61-OS2.3]
	[F40-OH1.1] Applies to materials installed to control the ingress of soil gas. [F61-OH1.1,OH1.2,OH1.3] Applies to materials installed to control the ingress of moisture.
[F61-OS2.3]	
<b>9.13.2.3. Preparation of Surface</b>	
(1)	[F40-OH1.1] [F61-OH1.1,OH1.2,OH1.3]
	[F61-OS2.3]
(2)	[F40-OH1.1] [F61-OH1.1,OH1.2,OH1.3]
	[F61-OS2.3]
(3)	[F40-OH1.1] [F61-OH1.1,OH1.2,OH1.3]
	[F61-OS2.3]
(4)	[F40-OH1.1] Applies to dampproofing installed to control the ingress of soil gas. [F61-OH1.1,OH1.2,OH1.3] Applies to dampproofing installed to control the ingress of moisture.
	[F61-OS2.3]
	[F40-OH1.1] Applies to <i>foundation</i> walls where the dampproofing serves to control the ingress of <i>soil</i> gas. [F61-OH1.1,OH1.2,OH1.3] Applies where the dampproofing serves to control the ingress of moisture.
[F61-OS2.3]	
(6)	[F61-OH1.1,OH1.2,OH1.3] [F40-OH1.1] Applies where dampproofing materials are installed to control the infiltration of soil gas.
	[F61-OS2.3]

**Table 9.37.1.1. (Continued)**

Functional Statements and Objectives <sup>(1)</sup>	
<b>9.13.2.4. Application of Dampproofing Material</b>	
(1)	[F40-OH1.1] Applies to dampproofing installed to control the ingress of soil gas. [F61-OH1.1,OH1.2,OH1.3] Applies to dampproofing installed to control the ingress of moisture.
	[F61-OS2.3]
(2)	[F40-OH1.1] [F61-OH1.1,OH1.2,OH1.3]
	[F61-OS2.3]
(3)	[F40-OH1.1] [F61-OH1.1,OH1.2,OH1.3]
	[F61-OS2.3]
<b>9.13.2.5. Moisture Protection for Interior Finishes</b>	
(1)	[F61-OH1.1,OH1.2] [F61-OS2.3]
	[F61-OH1.1,OH1.2,OH1.3] [F61-OS2.3]
(3)	[F61,F80-OH1.1,OH1.2,OH1.3] [F61,F80-OS2.3]
	[F61,F80-OS2.3]
<b>9.13.2.6. Dampproofing of Floors-on-Ground</b>	
(1)	[F61-OH1.1,OH1.2,OH1.3] [F61-OS2.3]
	[F61-OH1.1,OH1.2,OH1.3] [F61-OS2.3]
<b>9.13.3.1. Required Waterproofing</b>	
(1)	[F61-OH1.1,OH1.2,OH1.3] [F61-OS2.3]
	[F61-OH1.1,OH1.2,OH1.3] [F61-OS2.3]
<b>9.13.3.2. Waterproofing Materials</b>	
(1)	[F61-OH1.1,OH1.2,OH1.3] [F61-OS2.3]
	[F61-OH1.1,OH1.2,OH1.3] [F61-OS2.3]
<b>9.13.3.3. Preparation of Surface</b>	
(1)	[F40-OH1.1] [F61-OH1.1,OH1.2,OH1.3]
	[F61-OS2.3]
(2)	[F40-OH1.1] [F61-OH1.1,OH1.2,OH1.3]
	[F61-OS2.3]
(3)	[F61-OH1.1,OH1.2,OH1.3] [F40-OH1.1] Applies where waterproofing materials are installed to control the infiltration of soil gas.
	[F61-OS2.3]

Table 9.37.1.1. (Continued)

Functional Statements and Objectives <sup>(1)</sup>	
(4)	[F61-OH1.1,OH1.2,OH1.3] [F40-OH1.1] Applies where waterproofing materials are installed to control the infiltration of soil gas. [F61-OS2.3]
(5)	[F61-OH1.1,OH1.2,OH1.3] [F40-OH1.1] Applies where waterproofing materials are installed to control the infiltration of soil gas. [F61-OS2.3]
<b>9.13.3.4. Application of Waterproofing Membranes</b>	
(1)	[F40-OH1.1] [F61-OH1.1,OH1.2,OH1.3] [F61-OS2.3]
(2)	[F40-OH1.1] [F61-OH1.1,OH1.2,OH1.3] [F61-OS2.3]
(3)	[F61-OH1.1,OH1.2,OH1.3] [F61-OS2.3]
(4)	[F40-OH1.1] [F61-OH1.1,OH1.2,OH1.3] [F61-OS2.3]
<b>9.13.3.5. Floor Waterproofing System</b>	
(1)	[F61-OH1.1,OH1.2,OH1.3] [F61-OS2.3]
<b>9.13.4.2. Protection from Soil Gas Ingress</b>	
(1)	[F40-OH1.1]
(2)	[F40-OH1.1]
(3)	[F40-OH1.1]
<b>9.13.4.3. Providing for the Rough-in for a Subfloor Depressurization System</b>	
(1)	[F40-OH1.1]
(2)	[F40-OH1.1]
(3)	[F40-OH1.1]
<b>9.14.2.1. Foundation Wall Drainage</b>	
(1)	[F60-OH1.1,OH1.2,OH1.3] [F60-OS2.1,OS2.2,OS2.3] [F60-OP2.1,OP2.2,OP2.3]

Table 9.37.1.1. (Continued)

Functional Statements and Objectives <sup>(1)</sup>	
(2)	(a) [F60-OH1.1,OH1.2,OH1.3] Applies where <i>foundations</i> serve as or support an environmental separator. (a) [F60-OS2.1] (a) [F60-OS2.3] Applies where <i>foundations</i> serve as or support an environmental separator. (b) [F21-OS2.1] (b) [F21-OS2.3] Applies where <i>foundations</i> serve as or support an environmental separator. (b) [F21-OP2.1] (b) [F21-OP2.3] Applies where <i>foundations</i> serve as or support an environmental separator. (b) [F21-OP2.4] Applies where <i>foundations</i> support walls or floors. (b) [F21-OH1.1,OH1.2,OH1.3] Applies where <i>foundations</i> serve as or support an environmental separator. (b) [F21-OH4] Applies where <i>foundations</i> support floors or elements supporting floors. (b) [F21-OS3.1] Applies where <i>foundations</i> support floors or elements supporting floors. (b) [F21-OS3.7] Applies where <i>foundations</i> support walls that contain windows or doors required for emergency egress.
<b>9.14.3.1. Material Standards</b>	
(1)	[F60-OH1.1,OH1.2,OH1.3] [F60-OS2.1,OS2.3] [F60-OP2.1,OP2.3]
<b>9.14.3.2. Minimum Size</b>	
(1)	[F60-OH1.1,OH1.2,OH1.3] [F60-OS2.1,OS2.2,OS2.3] [F60-OP2.1,OP2.2,OP2.3]
<b>9.14.3.3. Installation</b>	
(1)	[F60-OH1.1,OH1.2,OH1.3] [F60-OS2.1,OS2.2,OS2.3] [F60-OP2.1,OP2.2,OP2.3]
(2)	[F60-OH1.1,OH1.2,OH1.3] [F60-OS2.1,OS2.2,OS2.3] [F60-OP2.1,OP2.2,OP2.3]
(3)	[F60-OH1.1,OH1.2,OH1.3] [F60-OS2.1,OS2.2,OS2.3] [F60-OP2.1,OP2.2,OP2.3]
(4)	[F60-OH1.1,OH1.2,OH1.3] [F60-OS2.1,OS2.2,OS2.3] [F60-OP2.1,OP2.2,OP2.3]

**Table 9.37.1.1. (Continued)**

Functional Statements and Objectives <sup>(1)</sup>	
<b>9.14.4.1. Type of Granular Material</b>	
(1)	(a) [F60-OS2.3] [F21-OS2.2]
	(a) [F60-OP2.3] [F21-OP2.6]
	(a) [F60-OH1.1,OH1.2,OH1.3]
	(b) [F21-OS2.1]
	(b) [F21-OS2.3] Applies to elements that support or are part of an environmental separator.
	(b) [F21-OP2.1,OP2.4]
	(b) [F21-OP2.3] Applies to elements that support or are part of an environmental separator.
	(b) [F21-OH1.1,OH1.2,OH1.3] Applies to elements that support or are part of an environmental separator.
(1)	(b) [F21-OH4] Applies to floors and elements that support floors.
	(b) [F21-OS3.1] Applies to floors and elements that support floors.
<b>9.14.4.2. Installation</b>	
(1)	[F60-OH1.1,OH1.2,OH1.3]
	[F60-OS2.1,OS2.2,OS2.3]
	[F60-OP2.1,OP2.2,OP2.3]
<b>9.14.4.3. Grading</b>	
(1)	[F60-OH1.1,OH1.2,OH1.3]
	[F60-OS2.1,OS2.2,OS2.3]
	[F60-OP2.1,OP2.2,OP2.3]
<b>9.14.4.4. Wet Site Conditions</b>	
(1)	[F60-OH1.1,OH1.2,OH1.3]
	[F60-OS2.1,OS2.2,OS2.3]
	[F60-OP2.1,OP2.2,OP2.3]
<b>9.14.5.1. Drainage Disposal</b>	
(1)	[F60-OH1.1,OH1.2,OH1.3]
	[F60-OS2.1,OS2.2,OS2.3]
	[F60-OP2.1,OP2.2,OP2.3]
<b>9.14.5.2. Sump Pits</b>	
(1)	(a),(b) [F60,F61-OH1.1,OH1.3]
	(c) [F40-OH1.1] [F52-OH1.2]
	(a),(b) [F60,F61-OS2.1,OS2.3]
	(c) [F52-OS2.3]
	(a),(b) [F60,F61-OP2.3,OP2.4]
	(c) [F52-OP2.3]
(1)	(c) [F30-OS3.1]
	(c) [F30-OS3.1]
(2)	(a) [F30-OS3.1]
	(b) [F40-OH1.1]
(3)	[F60-OH1.1,OH1.2,OH1.3]
	[F60-OS2.1,OS2.2,OS2.3]
	[F60-OP2.1,OP2.2,OP2.3]

**Table 9.37.1.1. (Continued)**

Functional Statements and Objectives <sup>(1)</sup>	
<b>9.14.5.3. Dry Wells</b>	
(1)	[F60-OH1.1,OH1.2,OH1.3]
	[F60-OS2.1,OS2.2,OS2.3]
	[F60-OP2.1,OP2.2,OP2.3]
(2)	[F60-OH1.1,OH1.2,OH1.3]
	[F60-OS2.1,OS2.2,OS2.3]
	[F60-OP2.1,OP2.2,OP2.3]
<b>9.14.6.1. Surface Drainage</b>	
(1)	[F60-OH1.1,OH1.2,OH1.3]
	[F60-OS2.1,OS2.2,OS2.3]
	[F60-OP2.1,OP2.2,OP2.3]
<b>9.14.6.2. Drainage away from Wells or Septic Disposal Beds</b>	
(1)	[F46-OH2.2] Applies to directing drainage away from the location of a water supply. [F44-OH2.1] Applies to directing drainage away from a septic tank disposal system.
<b>9.14.6.3. Window Wells</b>	
(1)	[F60-OH1.1,OH1.2,OH1.3]
	[F60-OS2.1,OS2.3]
	[F60-OP2.1,OP2.3]
<b>9.14.6.4. Catch Basin</b>	
(1)	[F61-OH1.1,OH1.2,OH1.3]
	[F61-OS2.3]
	[F61-OP2.3]
	[F61-OS3.1]
<b>9.15.1.3. Foundations for Deformation-Resistant Buildings</b>	
(1)	[F20-OS2.2]
	[F20,F22-OS2.3] Applies to elements that support or are part of an environmental separator.
	[F20-OP2.2]
	[F22-OP2.4]
	[F20,F22-OP2.3] Applies to elements that support or are part of an environmental separator.
	[F22-OH1.1,OH1.2,OH1.3] Applies to elements that support or are part of an environmental separator.
	[F22-OH4] Applies to floors and elements that support floors.
[F22-OS3.1] Applies to floors and elements that support floors. [F22-OS3.7] Applies to walls, and elements that support walls, that contain doors or windows required for emergency egress.	

Table 9.37.1.1. (Continued)

Functional Statements and Objectives <sup>(1)</sup>	
<b>9.15.2.2. Unit Masonry Construction</b>	
(1)	[F20-OS2.1] [F20,F21,F61-OS2.3] Applies to elements that support or are part of an environmental separator.
	[F20,F21,F61-OS3.1] Applies to floors and elements that support floors.
	[F20,F21,F61-OH4] Applies to floors and elements that support floors.
	[F20,F21,F61-OH1.1,OH1.2,OH1.3] Applies to elements that support or are part of an environmental separator.
	[F20-OP2.1] [F21,F61-OP2.4] [F20,F21,F61-OP2.3] Applies to elements that support or are part of an environmental separator.
(3)	(a) [F20-OS2.1] (a) [F20,F80-OS2.3] Applies to elements that support or are part of an environmental separator.
	(a) [F20-OP2.1] (a) [F80-OP2.4] (a) [F20,F80-OP2.3] Applies to elements that support or are part of an environmental separator.
	(a) [F20,F80-OH1.1,OH1.2,OH1.3] Applies to elements that support or are part of an environmental separator.
	(a) [F20,F80-OH4] Applies to floors and elements that support floors.
	(a) [F20,F80-OS3.1] Applies to floors and elements that support floors.
	(b) [F20-OS2.1] (b) [F20,F80-OS2.3] Applies to elements that support or are part of an environmental separator.
	(b) [F20-OP2.1] (b) [F80-OP2.4] (b) [F20,F80-OP2.3] Applies to elements that support or are part of an environmental separator.
	(b) [F20,F80-OH1.1,OH1.2,OH1.3] Applies to elements that support or are part of an environmental separator.
	(b) [F20,F80-OH4] Applies to floors and elements that support floors.
	(b) [F20,F80-OS3.1] Applies to floors and elements that support floors.
	(c) [F20-OS2.1] (c) [F20,F61-OS2.3] Applies to elements that support or are part of an environmental separator.
	(c) [F20-OP2.1] (c) [F61-OP2.4] (c) [F20,F61-OP2.3] Applies to elements that support or are part of an environmental separator.
	(c) [F20,F61-OH1.1,OH1.2,OH1.3] Applies to elements that support or are part of an environmental separator.
	(c) [F20,F61-OH4] Applies to floors and elements that support floors.
	(c) [F20,F61-OS3.1] Applies to floors and elements that support floors.

Table 9.37.1.1. (Continued)

Functional Statements and Objectives <sup>(1)</sup>	
<b>9.15.2.3. Pier-Type Foundations</b>	
(1)	[F20-OS2.1,OS2.2] [F20,F22-OS2.3] Applies to elements that support or are part of an environmental separator.
	[F20-OP2.1,OP2.2] [F22-OP2.4] [F20,F22-OP2.3] Applies to elements that support or are part of an environmental separator.
	[F20,F22-OH1.1,OH1.2,OH1.3] Applies to elements that support or are part of an environmental separator.
	[F20,F22-OH4] Applies to floors and elements that support floors.
	[F20,F22-OS3.1] Applies to floors and elements that support floors.
(2)	[F20-OS2.1,OS2.2] [F20,F22-OS2.3] Applies to elements that support or are part of an environmental separator.
	[F20-OP2.1,OP2.2] [F22-OP2.4] [F20,F22-OP2.3] Applies to elements that support or are part of an environmental separator.
	[F20,F22-OH1.1,OH1.2,OH1.3] Applies to elements that support or are part of an environmental separator.
	[F20,F22-OH4] Applies to floors and elements that support floors.
	[F20,F22-OS3.1] Applies to floors and elements that support floors.
(3)	[F20-OS2.1,OS2.4] [F22-OS2.4,OS2.5] [F20,F22-OS2.3] Applies to elements that support or are part of an environmental separator.
	[F20-OP2.1,OP2.4,OP2.5] [F22-OP2.4,OP2.5] [F20,F22-OP2.3] Applies to elements that support or are part of an environmental separator.
	[F20,F22-OH1.1,OH1.2,OH1.3] Applies to elements that support or are part of an environmental separator.
	[F20,F22-OH4] Applies to floors and elements that support floors.
	[F20,F22-OS3.1] Applies to floors and elements that support floors.

**Table 9.37.1.1. (Continued)**

Functional Statements and Objectives <sup>(1)</sup>	
(4)	[F20-OS2.1,OS2.4] [F22-OS2.4,OS2.5] [F20,F22-OS2.3] Applies to elements that support or are part of an environmental separator.
	[F20-OP2.1,OP2.4] [F22-OP2.4,OP2.5] [F20,F22-OP2.3] Applies to elements that support or are part of an environmental separator.
	[F20,F22-OH1.1,OH1.2,OH1.3] Applies to elements that support or are part of an environmental separator.
	[F20,F22-OH4] Applies to floors and elements that support floors.
	[F20,F22-OS3.1] Applies to floors and elements that support floors.
<b>9.15.2.4. Wood-Frame Foundations</b>	
(1)	(a) [F20-OS2.1,OS2.2] (a) [F20,F80-OS2.3] Applies to elements that support or are part of an environmental separator.
	(a) [F20-OP2.1,OP2.2] (a) [F20,F80-OP2.3] Applies to elements that support or are part of an environmental separator.
	(a) [F20,F80-OH1.1,OH1.2,OH1.3] Applies to elements that support or are part of an environmental separator.
	(a) [F20,F80-OH4] Applies to floors and elements that support floors.
	(a) [F20,F80-OS3.1] Applies to floors and elements that support floors.
<b>9.15.3.1. Footings Required</b>	
(1)	[F20-OS2.2] [F20,F21-OS2.3] Applies to elements that support or are part of an environmental separator.
	[F20-OP2.2] [F20,F21-OP2.4] [F20,F21-OP2.3] Applies to elements that support or are part of an environmental separator.
	[F20,F21-OH1.1,OH1.2,OH1.3] Applies to elements that support or are part of an environmental separator.
	[F20,F21-OH4] Applies to floors and elements that support floors.
	[F20,F21-OS3.1] Applies to floors and elements that support floors.
<b>9.15.3.2. Support of Footings</b>	
(1)	[F21-OS2.4] [F21-OS2.3] Applies to elements that support or are part of an environmental separator.
	[F21-OP2.4] [F21-OP2.3] Applies to elements that support or are part of an environmental separator.
	[F21-OH1.1,OH1.2,OH1.3] Applies to elements that support or are part of an environmental separator.
	[F21-OH4] Applies to floors and elements that support floors.
	[F21-OS3.1] Applies to floors and elements that support floors.

**Table 9.37.1.1. (Continued)**

Functional Statements and Objectives <sup>(1)</sup>	
(2)	[F21-OS2.1] [F21-OS2.3] Applies to elements that support or are part of an environmental separator.
	[F21-OP2.1,OP2.4] [F21-OP2.3] Applies to elements that support or are part of an environmental separator.
	[F21-OH1.1,OH1.2,OH1.3] Applies to elements that support or are part of an environmental separator.
	[F21-OH4] Applies to floors and elements that support floors.
	[F21-OS3.1] Applies to floors and elements that support floors.
<b>9.15.3.4. Basic Footing Widths and Areas</b>	
(1)	[F20-OS2.2] [F20,F21-OS2.3] Applies to elements that support or are part of an environmental separator.
	[F20-OP2.1] [F21-OP2.4] [F20,F21-OP2.3] Applies to elements that support or are part of an environmental separator.
	[F20,F21-OH1.1,OH1.2,OH1.3] Applies to elements that support or are part of an environmental separator.
	[F20,F21-OH4] Applies to floors and elements that support floors.
	[F20,F21-OS3.1] Applies to floors and elements that support floors.
(2)	[F20-OS2.2] [F20,F21-OS2.3] Applies to elements that support or are part of an environmental separator.
	[F20-OP2.2] [F21-OP2.4] [F20,F21-OP2.3] Applies to elements that support or are part of an environmental separator.
	[F20,F21-OH1.1,OH1.2,OH1.3] Applies to elements that support or are part of an environmental separator.
	[F20,F21-OH4] Applies to floors and elements that support floors.
	[F20,F21-OS3.1] Applies to floors and elements that support floors.
(3)	[F20-OS2.2] [F20,F21-OS2.3] Applies to elements that support or are part of an environmental separator.
	[F20-OP2.2] [F21-OP2.4] [F20,F21-OP2.3] Applies to elements that support or are part of an environmental separator.
	[F20,F21-OH1.1,OH1.2,OH1.3] Applies to elements that support or are part of an environmental separator.
	[F20,F21-OH4] Applies to floors and elements that support floors.
	[F20,F21-OS3.1] Applies to floors and elements that support floors.

Table 9.37.1.1. (Continued)

Functional Statements and Objectives <sup>(1)</sup>	
<b>9.15.3.5. Adjustments to Footing Widths for Exterior Walls</b>	
(1)	[F20-OS2.2,OS2.3] [F21-OS2.3]
	[F20-OP2.2,OP2.3] [F21-OP2.3,OP2.4]
	[F20,F21-OH1.1,OH1.2,OH1.3]
	[F20,F21-OH4] Applies to floors and elements that support floors.
	[F20,F21-OS3.1] Applies to floors and elements that support floors.
<b>9.15.3.6. Adjustments to Footing Widths for Interior Walls</b>	
(1)	[F20-OS2.2] [F20,F21-OS2.3] Applies to elements that support or are part of an environmental separator.
	[F20-OP2.2] [F21-OP2.4] [F20,F21-OP2.3] Applies to elements that support or are part of an environmental separator.
	[F20,F21-OH1.1,OH1.2,OH1.3] Applies to elements that support or are part of an environmental separator.
	[F20,F21-OH4] Applies to floors and elements that support floors.
	[F20,F21-OS3.1] Applies to floors and elements that support floors.
	[F20-OS2.2] [F20-OP2.2]
(2)	[F20-OS2.2]
	[F20-OP2.2]
<b>9.15.3.7. Adjustments to Footing Area for Columns</b>	
(1)	[F20-OS2.2] [F20,F21-OS2.3] Applies to elements that support or are part of an environmental separator.
	[F20-OP2.2] [F21-OP2.4] [F20,F21-OP2.3] Applies to elements that support or are part of an environmental separator.
	[F20,F21-OH1.1,OH1.2,OH1.3] Applies to elements that support or are part of an environmental separator.
	[F20,F21-OH4] Applies to floors and elements that support floors.
	[F20,F21-OS3.1] Applies to floors and elements that support floors.
	<b>9.15.3.8. Footing Thickness</b>
(1)	[F20-OS2.1] [F20-OS2.3] Applies to elements that support or are part of an environmental separator.
	[F20-OP2.1,OP2.4] [F20-OP2.3] Applies to elements that support or are part of an environmental separator.
	[F20-OH1.1,OH1.2,OH1.3] Applies to elements that support or are part of an environmental separator.
	[F20-OH4] Applies to floors and elements that support floors.
	[F20-OS3.1] Applies to floors and elements that support floors.

Table 9.37.1.1. (Continued)

Functional Statements and Objectives <sup>(1)</sup>	
<b>9.15.3.9. Step Footings</b>	
(1)	[F20,F22-OS2.3,OS2.4]
	[F20,F22-OP2.3,OP2.4]
	[F20,F22-OH1.1,OH1.2,OH1.3] Applies where the <i>foundation</i> supports or is part of an environmental separator.
	[F20,F22-OH4] Applies to <i>foundations</i> that support floors.
	[F20,F22-OS3.1] Applies to <i>foundations</i> that support floors.
<b>9.15.4.1. Permanent Form Material</b>	
(1)	[F22,F63,F55-OH1.1,OH1.2,OH1.3]
<b>9.15.4.2. Foundation Wall Thickness and Required Lateral Support</b>	
(1)	[F20-OS2.1,OS2.3] [F22-OS2.3]
	[F20-OP2.1,OP2.3] [F22-OP2.3,OP2.4]
	[F20,F22-OH1.1,OH1.2,OH1.3]
	[F20,F22-OH4] Applies to floors and elements that support floors.
	[F20,F22-OS3.1] Applies to floors and elements that support floors.
(2)	[F20-OS2.1,OS2.3] [F22-OS2.3]
	[F20-OP2.1,OP2.3] [F22-OP2.3,OP2.4]
	[F20,F22-OH1.1,OH1.2,OH1.3]
	[F20,F22-OH4] Applies to floors and elements that support floors. [F20,F22-OS3.1] Applies to floors and elements that support floors.
(3)	[F20-OS2.1,OS2.3] [F22-OS2.3,OS2.4]
	[F20-OP2.1,OP2.3] [F22-OP2.3,OP2.4]
	[F20,F22-OH1.1,OH1.2,OH1.3]
	[F20,F22-OH4] Applies to floors and elements that support floors.
	[F20,F22-OS3.1] Applies to floors and elements that support floors.
(4)	[F20-OS2.1,OS2.3] [F22-OS2.3]
	[F20-OP2.1,OP2.3] [F22-OP2.3,OP2.4]
	[F20,F22-OH1.1,OH1.2,OH1.3]
	[F20,F22-OH4] Applies to floors and elements that support floors.
	[F20,F22-OS3.1] Applies to floors and elements that support floors.
(5)	[F20-OS2.1,OS2.3] [F22-OS2.3,OS2.4]
	[F20-OP2.1,OP2.3] [F22-OP2.3,OP2.4]
	[F20,F22-OH1.1,OH1.2,OH1.3]
	[F20,F22-OH4] Applies to floors and elements that support floors.
	[F20,F22-OS3.1] Applies to floors and elements that support floors.

Copyright © NRC 1941 - 2021 World Rights Reserved © CNRC 1941-2021 Droits réservés pour tous pays

Table 9.37.1.1. (Continued)

Functional Statements and Objectives <sup>(1)</sup>	
(6)	[F20-OS2.1,OS2.3] [F22-OS2.3,OS2.4]
	[F20-OP2.1,OP2.3] [F22-OP2.3,OP2.4]
	[F20,F22-OH1.1,OH1.2,OH1.3]
	[F20,F22-OH4] Applies to floors and elements that support floors.
	[F20,F22-OS3.1] Applies to floors and elements that support floors.
(7)	[F20-OS2.1,OS2.3] [F22-OS2.3,OS2.4]
	[F20-OP2.1,OP2.3] [F22-OP2.3,OP2.4]
	[F20,F22-OH1.1,OH1.2,OH1.3]
	[F20,F22-OH4] Applies to floors and elements that support floors.
	[F20,F22-OS3.1] Applies to floors and elements that support floors.
(8)	[F20-OS2.1,OS2.3] [F22-OS2.3,OS2.4]
	[F20-OP2.1,OP2.3] [F22-OP2.3,OP2.4]
	[F20,F22-OH1.1,OH1.2,OH1.3]
	[F20,F22-OH4] Applies to floors and elements that support floors.
	[F20,F22-OS3.1] Applies to floors and elements that support floors.
<b>9.15.4.5. Reinforcement for Flat Insulating Concrete Form Foundation Walls</b>	
(1)	[F20-OS2.1,OS2.3] [F22-OS2.3,OS2.4]
	[F20-OP2.1,OP2.3] [F22-OP2.3,OP2.4]
	[F20,F22-OH1.1,OH1.2,OH1.3]
	[F20,F22-OH4] Applies to floors and elements that support floors.
	[F20,F22-OS3.1] Applies to floors and elements that support floors.
(2)	[F20-OS2.1,OS2.3] [F22-OS2.3,OS2.4]
	[F20-OP2.1,OP2.3] [F22-OP2.3,OP2.4]
	[F20,F22-OH1.1,OH1.2,OH1.3]
	[F20,F22-OH4] Applies to floors and elements that support floors.
	[F20,F22-OS3.1] Applies to floors and elements that support floors.
(3)	[F20-OS2.1,OS2.3] [F22-OS2.3,OS2.4]
	[F20-OP2.1,OP2.3] [F22-OP2.3,OP2.4]
	[F20,F22-OH1.1,OH1.2,OH1.3]
	[F20,F22-OH4] Applies to floors and elements that support floors.
	[F20,F22-OS3.1] Applies to floors and elements that support floors.

Table 9.37.1.1. (Continued)

Functional Statements and Objectives <sup>(1)</sup>	
(4)	[F20-OS2.1,OS2.3] [F22-OS2.3,OS2.4]
	[F20-OP2.1,OP2.3] [F22-OP2.3,OP2.4]
	[F20,F22-OH1.1,OH1.2,OH1.3]
	[F20,F22-OH4] Applies to floors and elements that support floors.
	[F20,F22-OS3.1] Applies to floors and elements that support floors.
<b>9.15.4.6. Extension above Ground Level</b>	
(1)	[F61-OH1.1,OH1.2,OH1.3]
	[F61-OS2.3]
	[F61-OP2.3]
<b>9.15.4.7. Reduction in Thickness</b>	
(1)	[F20-OS2.1] [F20-OS2.3] Applies to elements that support or are part of an environmental separator.
	[F20-OP2.1,OP2.4] [F20-OP2.3] Applies to elements that support or are part of an environmental separator.
	[F20-OH1.1,OH1.2,OH1.3] Applies to elements that support or are part of an environmental separator.
	[F20-OH4] Applies to floors and elements that support floors.
	[F20-OS3.1] Applies to floors and elements that support floors.
(2)	[F20-OH1.1,OH1.2,OH1.3] Applies to elements that support or are part of an environmental separator.
	[F20-OS2.1] [F20-OS2.3] Applies to elements that support or are part of an environmental separator.
	[F20-OP2.1,OP2.4] [F20-OP2.3] Applies to elements that support or are part of an environmental separator.
	[F20-OH4] Applies to floors and elements that support floors.
	[F20-OS3.1] Applies to floors and elements that support floors.
(3)	[F20-OS2.1] [F20-OS2.3] Applies to elements that support or are part of an environmental separator.
	[F20-OP2.1,OP2.4] [F20-OP2.3] Applies to elements that support or are part of an environmental separator.
	[F20-OH1.1,OH1.2,OH1.3] Applies to elements that support or are part of an environmental separator.
	[F20-OH4] Applies to floors and elements that support floors.
	[F20-OS3.1] Applies to floors and elements that support floors.
<b>9.15.4.9. Crack Control Joints</b>	
(1)	[F21-OS2.3]
	[F21-OP2.3]
	[F21-OH1.1,OH1.2,OH1.3] Applies to elements that support or are part of an environmental separator.

Table 9.37.1.1. (Continued)

Functional Statements and Objectives <sup>(1)</sup>	
(2)	[F61-OH1.1,OH1.2,OH1.3] Applies to elements that support or are part of an environmental separator. [F20-OS2.1] [F20,F61-OS2.3] Applies to elements that support or are part of an environmental separator. [F20-OP2.1] [F20,F61-OP2.3] Applies to elements that support or are part of an environmental separator.
<b>9.15.5.1. Support of Floor Joists</b>	
(1)	[F20-OS2.1] [F40,F61-OS2.3] Applies to elements that support or are part of an environmental separator. [F20-OP2.1,OP2.4] [F20-OP2.3] [F40,F61-OP2.3,OP2.4] Applies to elements that support or are part of an environmental separator. [F20,F40,F61-OH1.1,OH1.2,OH1.3] Applies to elements that support or are part of an environmental separator. [F20,F40,F61-OH4] Applies to floors and elements that support floors. [F20,F40,F61-OS3.1] Applies to floors and elements that support floors.
<b>9.15.5.2. Support of Beams</b>	
(1)	[F20-OS2.1] [F20-OS2.3] Applies to elements that support or are part of an environmental separator. [F20-OP2.1,OP2.4] [F20-OP2.3] Applies to elements that support or are part of an environmental separator. [F20-OH1.1,OH1.2,OH1.3] Applies to elements that support or are part of an environmental separator. [F20-OH4] Applies to floors and elements that support floors. [F20-OS3.1] Applies to floors and elements that support floors.
(2)	[F80-OS2.3] Applies to elements that support or are part of an environmental separator. [F80-OP2.3,OP2.4] Applies to elements that support or are part of an environmental separator. [F80-OH1.1,OH1.2,OH1.3] Applies to elements that support or are part of an environmental separator. [F80-OH4] Applies to floors and elements that support floors. [F80-OS3.1] Applies to floors and elements that support floors.
<b>9.15.5.3. Pilasters</b>	
(1)	[F20-OS2.1] [F20-OS2.3] Applies to elements that support or are part of an environmental separator. [F20-OP2.1,OP2.4] [F20-OP2.3] Applies to elements that support or are part of an environmental separator. [F20-OH1.1,OH1.2,OH1.3] Applies to elements that support or are part of an environmental separator. [F20-OH4] Applies to floors and elements that support floors. [F20-OS3.1] Applies to floors and elements that support floors.

Table 9.37.1.1. (Continued)

Functional Statements and Objectives <sup>(1)</sup>	
(2)	[F20-OH1.1,OH1.2,OH1.3] Applies to elements that support or are part of an environmental separator. [F20-OS2.1] [F20-OS2.3] Applies to elements that support or are part of an environmental separator. [F20-OP2.1,OP2.4] [F20-OP2.3] Applies to elements that support or are part of an environmental separator. [F20-OH4] Applies to floors and elements that support floors. [F20-OS3.1] Applies to floors and elements that support floors.
(3)	[F20-OS2.1] [F20-OS2.3] Applies to elements that support or are part of an environmental separator. [F20-OP2.1,OP2.4] [F20-OP2.3] Applies to elements that support or are part of an environmental separator. [F20-OH1.1,OH1.2,OH1.3] Applies to elements that support or are part of an environmental separator. [F20-OH4] Applies to floors and elements that support floors. [F20-OS3.1] Applies to floors and elements that support floors.
<b>9.15.6.2. Foundation Walls above Ground</b>	
(1)	[F61-OH1.1,OH1.2,OH1.3] [F61-OS2.3] [F61-OP2.3]
<b>9.15.6.3. Form Ties</b>	
(1)	[F61-OH1.1,OH1.2,OH1.3] Applies to elements that support or are part of an environmental separator. [F30-OS3.1] [F61-OS2.3] Applies to elements that support or are part of an environmental separator. [F61-OP2.3] Applies to elements that support or are part of an environmental separator.
<b>9.16.1.3. Required Floors-on-Ground</b>	
(1)	(a),(b) [F30-OS3.1] (a),(b) [F40-OH2.4]
<b>9.16.2.1. Required Installation of Granular Material</b>	
(1)	[F40,F61-OH1.1] [F60,F61-OH1.2,OH1.3] [F60-OS2.3]
<b>9.16.2.2. Support of Floors</b>	
(1)	[F21-OS2.1,OS2.3] [F21-OP2.1,OP2.3,OP2.4] [F21-OH1.1,OH1.2,OH1.3] [F21-OS3.1]
(2)	[F21-OS2.1,OS2.3] [F21-OP2.1,OP2.3,OP2.4] [F21-OH1.1,OH1.2,OH1.3] [F21-OS3.1]



**Table 9.37.1.1. (Continued)**

Functional Statements and Objectives <sup>(1)</sup>	
(3)	[F22-OS3.1]
<b>9.16.3.1. Control of Water Ingress</b>	
(1)	[F60-OH1.1,OH1.2,OH1.3]
	[F60-OS2.3]
	[F60-OS3.1]
<b>9.16.3.2. Hydrostatic Pressure</b>	
(1)	[F20-OH1.1,OH1.2,OH1.3]
	[F20-OS2.1] [F61-OS2.3]
	[F20-OP2.1] [F61-OP2.3]
	[F20-OS3.1]
<b>9.16.3.3. Floor Drains</b>	
(1)	[F62-OH1.1,OH1.2,OH1.3]
	[F62-OS2.3]
	[F62-OS3.1]
<b>9.16.4.1. Surface Finish</b>	
(1)	[F40-OH2.4]
	[F30,F80-OS3.1]
	[F62-OH1.1,OH1.2,OH1.3]
(2)	[F41-OH1.1]
	[F20,F80-OS3.1]
<b>9.16.4.2. Topping Course</b>	
(1)	[F20,F80-OS3.1]
(2)	[F20,F80-OS3.1]
<b>9.16.4.3. Thickness</b>	
(1)	[F20-OS2.1,OS2.3]
	[F20-OS3.1]
	[F20-OP2.1,OP2.3]
	[F20-OH1.1,OH1.2,OH1.3]
	[F20-OH4]
<b>9.16.4.4. Bond Break</b>	
(1)	[F21-OS3.1]
<b>9.16.5.1. Wood-Frame Floors</b>	
(1)	[F20-OS2.1] [F20-OS2.3] Applies where wood-frame floors-on-ground serve as an environmental separator.
	[F20-OS3.1]
	[F20-OP2.1] [F20-OP2.3] Applies where wood-frame floors-on-ground serve as an environmental separator.
	[F20-OH1.1,OH1.2,OH1.3] Applies where wood-frame floors-on-ground serve as an environmental separator.
	[F20-OH4]

**Table 9.37.1.1. (Continued)**

Functional Statements and Objectives <sup>(1)</sup>	
<b>9.17.2.1. Location</b>	
(1)	[F20-OS2.2] [F20-OS2.3] Applies to elements that support or are part of an environmental separator.
	[F20-OP2.2,OP2.4] [F20-OP2.3] Applies to elements that support or are part of an environmental separator.
	[F20-OH1.1,OH1.2,OH1.3] Applies to elements that support or are part of an environmental separator.
	[F20-OH4] Applies to floors and elements that support floors.
	[F20-OS3.1] Applies to floors and elements that support floors.
<b>9.17.2.2. Lateral Support</b>	
(1)	[F22-OS2.4,OS2.5] [F22-OS2.3] Applies to elements that support or are part of an environmental separator.
	[F22-OP2.4,OP2.5] [F22-OP2.3] Applies to elements that support or are part of an environmental separator.
	[F22-OH1.1,OH1.2,OH1.3] Applies to elements that support or are part of an environmental separator.
	[F22-OH4] Applies to floors and elements that support floors.
	[F22-OS3.1] Applies to floors and elements that support floors. [F22-OS3.7] Applies to walls, and elements that support walls, that contain doors or windows required for emergency egress.
(2)	[F22-OS2.4,OS2.5] [F22-OS2.3] Applies to elements that support or are part of an environmental separator.
	[F22-OP2.4,OP2.5] [F22-OP2.3] Applies to elements that support or are part of an environmental separator.
	[F22-OH1.1,OH1.2,OH1.3] Applies to elements that support or are part of an environmental separator.
	[F22-OH4] Applies to floors and elements that support floors.
	[F22-OS3.1] Applies to floors and elements that support floors. [F22-OS3.7] Applies to walls, and elements that support walls, that contain doors or windows required for emergency egress.
<b>9.17.3.1. Size and Thickness</b>	
(1)	[F20-OS2.1] [F20,F22-OS2.3] Applies to elements that support or are part of an environmental separator.
	[F20-OP2.1] [F20,F22-OP2.4] [F20,F22-OP2.3] Applies to elements that support or are part of an environmental separator.
	[F20,F22-OH1.1,OH1.2,OH1.3] Applies to elements that support or are part of an environmental separator.
	[F20,F22-OH4] Applies to floors and elements that support floors.
	[F20,F22-OS3.1] Applies to floors and elements that support floors.

Table 9.37.1.1. (Continued)

Functional Statements and Objectives <sup>(1)</sup>	
(2)	[F20-OS2.1] [F20,F22-OS2.3] Applies to elements that support or are part of an environmental separator.
	[F20-OP2.1] [F20,F22-OP2.4] [F20,F22-OP2.3] Applies to elements that support or are part of an environmental separator.
	[F20,F22-OH1.1,OH1.2,OH1.3] Applies to elements that support or are part of an environmental separator.
	[F20,F22-OH4] Applies to floors and elements that support floors.
	[F20,F22-OS3.1] Applies to floors and elements that support floors.
<b>9.17.3.2. End Bearing Plates</b>	
(1)	[F20-OS2.1] [F20,F22-OS2.3] Applies to elements that support or are part of an environmental separator.
	[F20-OP2.1] [F20,F22-OP2.4] [F20,F22-OP2.3] Applies to elements that support or are part of an environmental separator.
	[F20,F22-OH1.1,OH1.2,OH1.3] Applies to elements that support or are part of an environmental separator.
	[F20,F22-OH4] Applies to floors and elements that support floors.
	[F20,F22-OS3.1] Applies to floors and elements that support floors.
<b>9.17.3.3. Paint</b>	
(1)	[F80-OS3.1] Applies to floors and elements that support floors.
	[F80-OS2.3]
	[F80-OP2.3,OP2.4]
	[F80-OH1.1,OH1.2,OH1.3]
	[F80-OH4] Applies to floors and elements that support floors.
<b>9.17.3.4. Design of Steel Columns</b>	
(1)	[F20-OS2.1] [F22-OS2.4] [F20,F22-OS2.3] Applies to elements that support or are part of an environmental separator.
	[F20-OP2.1] [F22-OP2.4] [F20,F22-OP2.3] Applies to elements that support or are part of an environmental separator.
	[F20,F22-OH1.1,OH1.2,OH1.3] Applies to elements that support or are part of an environmental separator.
	[F20,F22-OH4] Applies to floors and elements that support floors.
	[F20,F22-OS3.1] Applies to floors and elements that support floors. [F20,F22-OS3.7] Applies to walls, and elements that support walls, that contain doors or windows required for emergency egress.

Table 9.37.1.1. (Continued)

Functional Statements and Objectives <sup>(1)</sup>	
<b>9.17.4.1. Column Sizes</b>	
(1)	[F20-OS2.1] [F20,F22-OS2.3] Applies to elements that support or are part of an environmental separator.
	[F20-OP2.1] [F20,F22-OP2.4] [F20,F22-OP2.3] Applies to elements that support or are part of an environmental separator.
	[F20,F22-OH1.1,OH1.2,OH1.3] Applies to elements that support or are part of an environmental separator.
	[F20,F22-OH4] Applies to floors and elements that support floors.
	[F20,F22-OS3.1] Applies to floors and elements that support floors.
	[F20,F22-OS3.1] Applies to floors and elements that support floors.
(2)	[F20-OS2.1] [F20,F22-OS2.3] Applies to elements that support or are part of an environmental separator.
	[F20-OP2.1] [F20,F22-OP2.4] [F20,F22-OP2.3] Applies to elements that support or are part of an environmental separator.
	[F20,F22-OH1.1,OH1.2,OH1.3] Applies to elements that support or are part of an environmental separator.
	[F20,F22-OH4] Applies to floors and elements that support floors.
	[F20,F22-OS3.1] Applies to floors and elements that support floors.
	[F20,F22-OS3.1] Applies to floors and elements that support floors.
<b>9.17.4.2. Materials</b>	
(1)	[F20-OS2.1] [F20,F22-OS2.3] Applies to elements that support or are part of an environmental separator.
	[F20-OP2.1] [F20,F22-OP2.4] [F20,F22-OP2.3] Applies to elements that support or are part of an environmental separator.
	[F20,F22-OH1.1,OH1.2,OH1.3] Applies to elements that support or are part of an environmental separator.
	[F20,F22-OH4] Applies to floors and elements that support floors.
	[F20,F22-OS3.1] Applies to floors and elements that support floors.
	[F20,F22-OS3.1] Applies to floors and elements that support floors.

Table 9.37.1.1. (Continued)

Functional Statements and Objectives <sup>(1)</sup>	
(2)	[F20-OS2.1] [F20,F22-OS2.3] Applies to elements that support or are part of an environmental separator.
	[F20-OP2.1] [F20,F22-OP2.4] [F20,F22-OP2.3] Applies to elements that support or are part of an environmental separator.
	[F20,F22-OH1.1,OH1.2,OH1.3] Applies to elements that support or are part of an environmental separator.
	[F20,F22-OH4] Applies to floors and elements that support floors.
	[F20,F22-OS3.1] Applies to floors and elements that support floors.
<b>9.17.4.3. Columns in Contact with Concrete</b>	
(1)	[F80-OS2.3] Applies to elements that support or are part of an environmental separator.
	[F80-OP2.4] [F80-OP2.3] Applies to elements that support or are part of an environmental separator.
	[F80-OH4] Applies to floors and elements that support floors.
	[F80-OH1.1,OH1.2,OH1.3] Applies to elements that support or are part of an environmental separator.
	[F80-OS3.1] Applies to floors and elements that support floors.
<b>9.17.5.1. Materials</b>	
(1)	[F20-OS2.1] [F20,F22-OS2.3] Applies to elements that support or are part of an environmental separator.
	[F20-OP2.1] [F20,F22-OP2.4] [F20,F22-OP2.3] Applies to elements that support or are part of an environmental separator.
	[F20,F22-OH1.1,OH1.2,OH1.3] Applies to elements that support or are part of an environmental separator.
	[F20,F22-OH4] Applies to floors and elements that support floors.
	[F20,F22-OS3.1] Applies to floors and elements that support floors.
<b>9.17.5.2. Sizes</b>	
(1)	[F20-OS2.1] [F20,F22-OS2.3] Applies to elements that support or are part of an environmental separator.
	[F20-OP2.1] [F20,F22-OP2.4] [F20,F22-OP2.3] Applies to elements that support or are part of an environmental separator.
	[F20,F22-OH1.1,OH1.2,OH1.3] Applies to elements that support or are part of an environmental separator.
	[F20,F22-OH4] Applies to floors and elements that support floors.
	[F20,F22-OS3.1] Applies to floors and elements that support floors.

Table 9.37.1.1. (Continued)

Functional Statements and Objectives <sup>(1)</sup>	
<b>9.17.6.2. Sizes</b>	
(1)	[F20-OS2.1] [F20,F22-OS2.3] Applies to elements that support or are part of an environmental separator.
	[F20-OP2.1] [F20,F22-OP2.4] [F20,F22-OP2.3] Applies to elements that support or are part of an environmental separator.
	[F20,F22-OH1.1,OH1.2,OH1.3] Applies to elements that support or are part of an environmental separator.
	[F20,F22-OH4] Applies to floors and elements that support floors.
	[F20,F22-OS3.1] Applies to floors and elements that support floors.
	[F20,F22-OS3.1] Applies to floors and elements that support floors.
<b>9.18.2.1. Access Openings</b>	
(1)	[F82-OH1.1,OH1.2]
(2)	[F51,F63-OS2.3] Applies where crawl spaces are unheated and access is from the interior. [F42,F61-OS2.3] Applies where crawl spaces are heated or unheated and access is from the exterior.
	[F63-OS2.3] Applies where crawl spaces are unheated and access is from the interior. [F42,F61-OS2.3] Applies where crawl spaces are heated or unheated and access is from the exterior.
	[F42-OH2.4,OH2.5] Applies where crawl spaces are heated or unheated and access is from the exterior.
	[F42-OH2.4,OH2.5] Applies where crawl spaces are heated or unheated and access is from the exterior.
<b>9.18.3.1. Ventilation of Unheated Crawl Spaces</b>	
(1)	[F62-OH1.1] [F62-OS2.3]
	[F62-OH1.1] [F62-OS2.3]
(3)	(a) [F62-OH1.1,OH1.2] (b) [F61,F42-OH1.1,OH1.2] (a),(b) [F61,F62,F42-OS2.3] (b) [F42-OH2.3,OH2.5]
	(a) [F62-OH1.1,OH1.2] (b) [F61,F42-OH1.1,OH1.2] (a),(b) [F61,F62,F42-OS2.3] (b) [F42-OH2.3,OH2.5]
	(a) [F62-OH1.1,OH1.2] (b) [F61,F42-OH1.1,OH1.2] (a),(b) [F61,F62,F42-OS2.3] (b) [F42-OH2.3,OH2.5]
<b>9.18.4.1. Access Way to Services</b>	
(1)	[F82-OH1.1,OH1.2] [F82-OH2.1]
	[F82-OH1.1,OH1.2] [F82-OH2.1]
<b>9.18.5.1. Drainage</b>	
(1)	[F60-OH1.1,OH1.2] [F60-OS2.3]
	[F60-OH1.1,OH1.2] [F60-OS2.3]
<b>9.18.6.1. Ground Cover in Unheated Crawl Spaces</b>	
(1)	[F61-OH1.1,OH1.2] [F61-OS2.3]
	[F61-OH1.1,OH1.2] [F61-OS2.3]
(2)	[F61-OH1.1,OH1.2] [F61-OS2.3]
	[F61-OH1.1,OH1.2] [F61-OS2.3]

Table 9.37.1.1. (Continued)

Functional Statements and Objectives <sup>(1)</sup>	
<b>9.18.6.2. Ground Cover in Heated Crawl Spaces</b>	
(1)	[F40,F61-OH1.1] [F61-OH1.2] [F61-OS2.3]
(2)	[F40,F61-OH1.1] [F61-OH1.2] [F61-OS2.3]
(3)	[F40-OH1.1]
(4)	[F40,F61-OH1.1,OH1.2] [F61-OS2.3]
<b>9.18.7.1. Crawl Spaces as Warm Air Plenums</b>	
(1)	[F51-OH1.1,OH1.2] [F51-OS2.3]
(2)	[F02-OS1.2]
(3)	[F01-OS1.1]
(4)	(a),(b) [F01-OS1.1]
<b>9.19.1.1. Required Venting</b>	
(1)	[F51,F62-OH1.1,OH1.2] [F51-OH1.3] Applies to sloped roof assemblies that may be subject to ice damming. [F62,F51-OS2.3]
<b>9.19.1.2. Vent Requirements</b>	
(1)	[F51,F62-OH1.1,OH1.2] [F51-OH1.3] Applies to sloped roof assemblies that may be subject to ice damming. [F62,F51-OS2.3]
(2)	[F51,F62-OH1.1,OH1.2] [F51-OH1.3] Applies to sloped roof assemblies that may be subject to ice damming. [F62,F51-OS2.3]
(3)	[F51,F62-OH1.1,OH1.2] [F51-OH1.3] Applies to sloped roof assemblies that may be subject to ice damming. [F62,F51-OS2.3]
(4)	[F51,F62-OH1.1,OH1.2] [F51-OH1.3] Applies to sloped roof assemblies that may be subject to ice damming. [F62,F51-OS2.3]
(5)	[F42,F51,F61,F62-OS2.3] [F42-OH1.1] Applies to resistance to the entry of insects. [F51,F61,F62-OH1.1,OH1.2,OH1.3] [F42-OH2.5] Applies to resistance to the entry of insects.
<b>9.19.1.3. Clearances</b>	
(1)	[F62,F51-OH1.1,OH1.2,OH1.3] [F62,F51-OS2.3]
(2)	[F62,F51-OH1.1,OH1.2,OH1.3] [F62,F51-OS2.3]
(3)	[F51,F62-OH1.1,OH1.2,OH1.3] [F51,F62-OS2.3]

Table 9.37.1.1. (Continued)

Functional Statements and Objectives <sup>(1)</sup>	
<b>9.19.2.1. Access</b>	
(1)	[F82-OS2.3] [F82-OH1.1,OH1.2,OH1.3]
(2)	[F82-OH1.1,OH1.2] [F82-OS2.3]
(3)	[F42-OH1.1] [F61-OH1.1,OH1.2,OH1.3] Applies where access is from the exterior. [F42-OH1.1] Applies where access is from an unheated enclosed space. [F51-OH1.2] Applies where access is from an interior heated space. [F61,F42-OS2.3] Applies where access is from the exterior or an unheated enclosed space. [F42-OH2.5] Applies where access is from the exterior or an unheated enclosed space.
<b>9.20.2.1. Masonry Unit Standards</b>	
(1)	[F20,F80-OS2.1] [F20,F80-OS2.3] Applies to elements that support or are part of an environmental separator or are exposed to moisture. [F20,F80-OP2.1,OP2.4] [F20,F80-OP2.3] Applies to elements that support or are part of an environmental separator or are exposed to moisture. [F20,F80-OH1.1,OH1.2,OH1.3] Applies to elements that support or are part of an environmental separator and to masonry used in <i>chimneys</i> and fireplaces. [F20,F80-OS3.1] Applies to floors and elements that support floors. [F20,F80-OS3.4] Applies to masonry used in <i>chimneys</i> and fireplaces. [F20,F80-OS1.2] Applies to assemblies required to provide fire resistance. [F01-OS1.1,OS1.2] Applies to masonry used in <i>chimneys</i> and fireplaces. [F20,F80-OH4] Applies to floors and elements that support floors. [F20,F80-OP1.2] Applies to assemblies required to provide fire resistance. [F01,F20,F80-OP1.2] Applies to masonry used in <i>chimneys</i> and fireplaces.

**Table 9.37.1.1. (Continued)**

Functional Statements and Objectives <sup>(1)</sup>	
<b>9.20.2.2. Used Brick</b>	
(1)	[F20,F80-OS2.1] [F20,F80-OS2.3] Applies to elements that support or are part of an environmental separator or are exposed to moisture.
	[F20,F80-OP2.1,OP2.4] [F20,F80-OP2.3] Applies to elements that support or are part of an environmental separator or are exposed to moisture.
	[F20,F80-OH1.1,OH1.2,OH1.3] Applies to elements that support or are part of an environmental separator and to masonry used in <i>chimneys</i> and fireplaces.
	[F20,F80-OS1.2] Applies to assemblies required to provide fire resistance. [F01-OS1.1,OS1.2] Applies to masonry used in <i>chimneys</i> and fireplaces.
	[F20,F80-OS3.1] Applies to floors and elements that support floors. [F20,F80-OS3.4] Applies to masonry used in <i>chimneys</i> and fireplaces.
	[F20,F80-OH4] Applies to floors and elements that support floors.
	[F20,F80-OP1.2] Applies to assemblies required to provide fire resistance. [F01-OP1.2] Applies to masonry used in <i>chimneys</i> and fireplaces.
<b>9.20.2.3. Glass Blocks</b>	
(1)	[F20-OS2.1] [F20-OS2.3] Applies to elements that support or are part of an environmental separator or are exposed to moisture.
	[F20-OP2.1,OP2.4] [F20-OP2.3] Applies to elements that support or are part of an environmental separator or are exposed to moisture.
	[F20-OH1.1,OH1.2,OH1.3] Applies to elements that support or are part of an environmental separator and to masonry used in <i>chimneys</i> and fireplaces.
	[F20-OH4] Applies to floors and elements that support floors.
	[F20-OS3.1] Applies to floors and elements that support floors. [F01,F20-OS3.4] Applies to masonry used in <i>chimneys</i> and fireplaces.
	[F01,F20-OS1.1] [F20-OS1.2] Applies to assemblies required to provide fire resistance.
	[F01,F20-OP1.1] [F20-OP1.2] Applies to assemblies required to provide fire resistance.

**Table 9.37.1.1. (Continued)**

Functional Statements and Objectives <sup>(1)</sup>	
<b>9.20.2.4. Cellular Concrete</b>	
(1)	[F80-OS2.1] [F80-OS2.3] Applies to elements that support or are part of an environmental separator or are exposed to moisture.
	[F80-OP2.1,OP2.4] [F80-OP2.3] Applies to elements that support or are part of an environmental separator or are exposed to moisture.
	[F80-OH1.1,OH1.2,OH1.3] Applies to elements that support or are part of an environmental separator and to masonry used in <i>chimneys</i> and fireplaces.
	[F80-OH4] Applies to floors and elements that support floors.
	[F80-OS3.1] Applies to floors and elements that support floors. [F80-OS3.4] Applies to masonry used in <i>chimneys</i> and fireplaces.
	[F80-OP1.2] Applies to masonry used in <i>chimneys</i> and fireplaces.
	[F80-OS1.2] Applies to masonry used in <i>chimneys</i> and fireplaces.
<b>9.20.2.5. Stone</b>	
(1)	[F20,F80-OS2.1] [F20,F80-OS2.3] Applies to elements that support or are part of an environmental separator or are exposed to moisture.
	[F20,F80-OP2.1,OP2.4] [F20,F80-OP2.3] Applies to elements that support or are part of an environmental separator or are exposed to moisture.
	[F20,F80-OH1.1,OH1.2,OH1.3] Applies to elements that support or are part of an environmental separator and to masonry used in <i>chimneys</i> and fireplaces.
	[F20,F80-OS1.2] Applies to assemblies required to provide fire resistance. [F01-OS1.1,OS1.2] Applies to masonry used in <i>chimneys</i> and fireplaces.
	[F20,F80-OH4] Applies to floors and elements that support floors.
	[F20,F80-OP1.2] Applies to assemblies required to provide fire resistance. [F01,F20,F80-OP1.2] Applies to masonry used in <i>chimneys</i> and fireplaces.
<b>9.20.2.6. Concrete Blocks Exposed to the Weather</b>	
(1)	[F80-OS2.1,OS2.3] [F61-OS2.3]
	[F80-OP2.1,OP2.3] [F61-OP2.3]
	[F61,F80-OH1.1,OH1.2,OH1.3]
	[F80-OH4] Applies to floors and elements that support floors.
	[F80-OS3.1] Applies to elements that support floors. [F80-OS3.4] Applies to masonry used in <i>chimneys</i> and fireplaces.
	[F80-OP1.2] Applies to concrete blocks in <i>chimneys</i> and fireplaces.

Copyright © NRC 1941 - 2021 World Rights Reserved © CNRC 1941-2021 Droits réservés pour tous pays

Table 9.37.1.1. (Continued)

Functional Statements and Objectives <sup>(1)</sup>	
<b>9.20.2.7. Compressive Strength</b>	
(1)	[F20,F80-OS2.1] [F20,F80-OS2.3] Applies to elements that support or are part of an environmental separator or are exposed to moisture.
	[F20,F80-OP2.1,OP2.4] [F20,F80-OP2.3] Applies to elements that support or are part of an environmental separator or are exposed to moisture.
	[F20,F80-OH1.1,OH1.2,OH1.3] Applies to elements that support or are part of an environmental separator and to masonry used in <i>chimneys</i> and fireplaces.
	[F20,F80-OS1.2] Applies to assemblies required to provide fire resistance. [F01-OS1.1,OS1.2] Applies to masonry used in <i>chimneys</i> and fireplaces.
	[F20,F80-OH4] Applies to floors and elements that support floors.
	[F20,F80-OS3.1] Applies to floors and elements that support floors. [F20,F80-OS3.4] Applies to masonry used in <i>chimneys</i> and fireplaces.
	[F20,F80-OP1.2] Applies to assemblies required to provide fire resistance. [F01,F20,F80-OP1.2] Applies to masonry used in <i>chimneys</i> and fireplaces.
	<b>9.20.3.1. Mortar Materials</b>
(1)	[F20,F80-OS2.1] [F20,F80-OS2.3] Applies to elements that support or are part of an environmental separator.
	[F20,F80-OP2.1,OP2.4] [F20,F80-OP2.3] Applies to elements that support or are part of an environmental separator.
	[F20,F80-OH1.1,OH1.2,OH1.3] Applies to elements that support or are part of an environmental separator and to masonry used in <i>chimneys</i> and fireplaces.
	[F20,F80-OH4] Applies to floors and elements that support floors.
	[F20,F80-OS3.1] Applies to floors and elements that support floors.
	[F20,F80-OS1.2] Applies to assemblies required to provide fire resistance.
(2)	[F20-OS2.1] [F20-OS2.3] Applies to elements that support or are part of an environmental separator or are exposed to moisture.
	[F20-OP2.1,OP2.4] [F20-OP2.3] Applies to elements that support or are part of an environmental separator or are exposed to moisture.
	[F20-OH1.1,OH1.2,OH1.3] Applies to elements that support or are part of an environmental separator.
	[F20-OS1.2] Applies to assemblies required to provide fire resistance.
	[F20-OH4] Applies to floors and elements that support floors.
	[F20-OS3.1] Applies to floors and elements that support floors.

Table 9.37.1.1. (Continued)

Functional Statements and Objectives <sup>(1)</sup>	
(3)	[F21-OS2.1] [F21-OS2.3] Applies to elements that support or are part of an environmental separator or are exposed to moisture.
	[F21-OP2.1,OP2.4] [F21-OP2.3] Applies to elements that support or are part of an environmental separator or are exposed to moisture.
	[F21-OH1.1,OH1.2,OH1.3] Applies to elements that support or are part of an environmental separator and to masonry used in <i>chimneys</i> and fireplaces.
	[F21-OS1.2] Applies to assemblies required to provide fire resistance.
	[F21-OH4] Applies to floors and elements that support floors.
	[F21-OS3.1] Applies to floors and elements that support floors.
(4)	[F21-OS2.1] [F21-OS2.3] Applies to elements that support or are part of an environmental separator or are exposed to moisture.
	[F21-OP2.1,OP2.4] [F21-OP2.3] Applies to elements that support or are part of an environmental separator or are exposed to moisture.
	[F21-OH1.1,OH1.2,OH1.3] Applies to elements that support or are part of an environmental separator and to masonry used in <i>chimneys</i> and fireplaces.
	[F21-OS1.2] Applies to assemblies required to provide fire resistance.
	[F21-OH4] Applies to floors and elements that support floors.
	[F21-OS3.1] Applies to floors and elements that support floors.
<b>9.20.3.2. Mortar and Grout Mixes</b>	
(1)	[F20,F21,F61-OS2.1] [F20,F21,F61-OS2.3] Applies to elements that support or are part of an environmental separator.
	[F20,F21,F61-OP2.1,OP2.4] [F20,F21,F61-OP2.3] Applies to elements that support or are part of an environmental separator.
	[F20,F21,F61-OH1.1,OH1.2,OH1.3] Applies to elements that support or are part of an environmental separator and to masonry used in <i>chimneys</i> and fireplaces.
	[F20,F21,F61-OH4] Applies to floors and elements that support floors.
	[F20,F21,F61-OS3.1] Applies to floors and elements that support floors.
	[F20,F21-OS1.2] Applies to assemblies required to provide fire resistance.
(2)	(a) [F21,F61,F55-OS2.1,OS2.3]
	(a) [F21,F61,F55-OP2.1,OP2.3]
	(a) [F21,F61,F55-OH1.1,OH1.2,OH1.3]
	(b) [F21-OS2.1]
	(b) [F21-OP2.1]
	(b) [F21,F44-OS1.2] Applies to assemblies required to provide fire resistance.

**Table 9.37.1.1. (Continued)**

Functional Statements and Objectives <sup>(1)</sup>	
(3)	[F20,F21,F61-OS2.1] [F20,F21,F61-OS2.3] Applies to elements that support or are part of an environmental separator.
	[F20,F21,F61-OP2.1,OP2.4] [F20,F21,F61-OP2.3] Applies to elements that support or are part of an environmental separator.
	[F20,F21,F61-OH1.1,OH1.2,OH1.3] Applies to elements that support or are part of an environmental separator and to masonry used in <i>chimneys</i> and fireplaces.
	[F20,F21,F61-OH4] Applies to floors and elements that support floors.
	[F20,F21,F61-OS3.1] Applies to floors and elements that support floors.
	[F20,F21-OS1.2] Applies to assemblies required to provide fire resistance.
(4)	[F20,F21-OS2.1] [F20,F21-OS2.3] Applies to elements that support or are part of an environmental separator.
	[F20,F21-OP2.1,OP2.4] [F20,F21-OP2.3] Applies to elements that support or are part of an environmental separator.
	[F20,F21-OH1.1,OH1.2,OH1.3] Applies to elements that support or are part of an environmental separator and to masonry used in <i>chimneys</i> and fireplaces.
	[F20,F21-OH4] Applies to floors and elements that support floors.
	[F20,F21-OS3.1] Applies to floors and elements that support floors.
	[F20,F21-OS1.2] Applies to assemblies required to provide fire resistance.
(5)	[F20-OS2.1] [F20-OS2.3] Applies to elements that support or are part of an environmental separator.
	[F20-OP2.1,OP2.4] [F20-OP2.3] Applies to elements that support or are part of an environmental separator.
	[F20-OH1.1,OH1.2,OH1.3] Applies to elements that support or are part of an environmental separator and to masonry used in <i>chimneys</i> and fireplaces.
	[F20-OH4] Applies to floors and elements that support floors.
	[F20-OS3.1] Applies to floors and elements that support floors.
	[F20-OS1.2] Applies to assemblies required to provide fire resistance.

**Table 9.37.1.1. (Continued)**

Functional Statements and Objectives <sup>(1)</sup>	
(6)	[F20-OS2.1] [F20-OS2.3] Applies to elements that support or are part of an environmental separator.
	[F20-OP2.1,OP2.4] [F20-OP2.3] Applies to elements that support or are part of an environmental separator.
	[F20-OH1.1,OH1.2,OH1.3] Applies to elements that support or are part of an environmental separator and to masonry used in <i>chimneys</i> and fireplaces.
	[F20-OH4] Applies to floors and elements that support floors.
	[F20-OS3.1] Applies to floors and elements that support floors.
	[F20-OS1.2] Applies to assemblies required to provide fire resistance.
(7)	[F20,F21,F61-OS2.1] [F20,F21,F61-OS2.3] Applies to elements that support or are part of an environmental separator.
	[F20,F21,F61-OP2.1,OP2.4] [F20,F21,F61-OP2.3] Applies to elements that support or are part of an environmental separator.
	[F20,F21,F61-OH1.1,OH1.2,OH1.3] Applies to elements that support or are part of an environmental separator and to masonry used in <i>chimneys</i> and fireplaces.
	[F20,F21,F61-OH4] Applies to floors and elements that support floors.
	[F20,F21,F61-OS3.1] Applies to floors and elements that support floors.
	[F20,F21,F61-OS1.2] Applies to assemblies required to provide fire resistance.
<b>9.20.4.1. Thickness</b>	
(1)	[F20,F61-OH1.1,OH1.2,OH1.3] Applies to elements that support or are part of an environmental separator.
	[F20,F61-OS2.1] [F20,F61-OS2.3] Applies to elements that support or are part of an environmental separator or are exposed to moisture.
	[F20,F61-OP2.1,OP2.4] [F20,F61-OP2.3] Applies to elements that support or are part of an environmental separator or are exposed to moisture.
	[F20,F61-OS1.2] Applies to assemblies required to provide fire resistance.
	[F20,F61-OH4] Applies to floors and elements that support floors.
	[F20,F61-OS3.1] Applies to floors and elements that support floors.

Table 9.37.1.1. (Continued)

Functional Statements and Objectives <sup>(1)</sup>	
(2)	[F20,F61-OH1.1,OH1.2,OH1.3] Applies to elements that support or are part of an environmental separator.
	[F20,F61-OS2.1] [F20,F61-OS2.3] Applies to elements that support or are part of an environmental separator or are exposed to moisture.
	[F20,F61-OP2.1,OP2.4] [F20,F61-OP2.3] Applies to elements that support or are part of an environmental separator or are exposed to moisture.
	[F20,F61-OS1.2] Applies to assemblies required to provide fire resistance.
	[F20,F61-OH4] Applies to floors and elements that support floors.
	[F20,F61-OS3.1] Applies to floors and elements that support floors.
<b>9.20.4.2. Solid Masonry Units</b>	
(1)	[F20-OH1.1,OH1.2,OH1.3] Applies to elements that support or are part of an environmental separator and to masonry used in <i>chimneys</i> and fireplaces.
	[F20-OS2.1] [F20-OS2.3] Applies to elements that support or are part of an environmental separator or are exposed to moisture.
	[F20-OP2.1,OP2.4] [F20-OP2.3] Applies to elements that support or are part of an environmental separator or are exposed to moisture.
	[F20-OS1.2] Applies to assemblies required to provide fire resistance.
	[F20-OH4] Applies to floors and elements that support floors.
	[F20-OS3.1] Applies to floors and elements that support floors.
<b>9.20.4.3. Laying of Masonry Units</b>	
(1)	[F20-OH1.1,OH1.2,OH1.3] Applies to elements that support or are part of an environmental separator and to masonry used in <i>chimneys</i> and fireplaces.
	[F20-OS2.1] [F20-OS2.3] Applies to elements that support or are part of an environmental separator or are exposed to moisture.
	[F20-OP2.1,OP2.4] [F20-OP2.3] Applies to elements that support or are part of an environmental separator or are exposed to moisture.
	[F20-OS1.2] Applies to assemblies required to provide fire resistance.
	[F20-OH4] Applies to floors and elements that support floors.
	[F20-OS3.1] Applies to floors and elements that support floors.

Table 9.37.1.1. (Continued)

Functional Statements and Objectives <sup>(1)</sup>	
(2)	[F20-OS2.1] [F20-OS2.3] Applies to elements that support or are part of an environmental separator.
	[F20-OP2.1,OP2.4] [F20-OP2.3] Applies to elements that support or are part of an environmental separator.
	[F20-OH1.1,OH1.2,OH1.3] Applies to elements that support or are part of an environmental separator and to masonry used in <i>chimneys</i> and fireplaces.
	[F20-OH4] Applies to floors and elements that support floors.
	[F20-OS3.1] Applies to floors and elements that support floors.
	[F20-OS1.2] Applies to assemblies required to provide fire resistance.
(3)	[F20-OS2.1] [F20-OS2.3] Applies to elements that support or are part of an environmental separator.
	[F20-OP2.1,OP2.4] [F20-OP2.3] Applies to elements that support or are part of an environmental separator.
	[F20-OH1.1,OH1.2,OH1.3] Applies to elements that support or are part of an environmental separator and to masonry used in <i>chimneys</i> and fireplaces.
	[F20-OH4] Applies to floors and elements that support floors.
	[F20-OS3.1] Applies to floors and elements that support floors.
	[F20-OS1.2] Applies to assemblies required to provide fire resistance.
<b>9.20.5.1. Masonry Support</b>	
(1)	[F20,F21-OH1.1,OH1.2,OH1.3] Applies to elements that support or are part of an environmental separator.
	[F20,F21-OS2.1] [F20,F21-OS2.3] Applies to elements that support or are part of an environmental separator or are exposed to moisture.
	[F20,F21-OP2.1,OP2.4] [F20,F21-OP2.3] Applies to elements that support or are part of an environmental separator or are exposed to moisture.
	[F20,F21-OS1.2] Applies to assemblies required to provide fire resistance.
	[F20,F21-OH4] Applies to floors and elements that support floors.
	[F20,F21-OS3.1] Applies to floors and elements that support floors.



**Table 9.37.1.1. (Continued)**

Functional Statements and Objectives <sup>(1)</sup>	
(2)	[F20-OH1.1,OH1.2,OH1.3] Applies to elements that support or are part of an environmental separator.
	[F20-OS2.1] [F20-OS2.3] Applies to elements that support or are part of an environmental separator or are exposed to moisture.
	[F20-OP2.1,OP2.4] [F20-OP2.3] Applies to elements that support or are part of an environmental separator or are exposed to moisture.
	[F20-OS1.2] Applies to assemblies required to provide fire resistance.
	[F20-OH4] Applies to floors and elements that support floors.
	[F20-OS3.1] Applies to floors and elements that support floors.
<b>9.20.5.2. Lintels or Arches</b>	
(1)	[F20,F22-OH1.1,OH1.2,OH1.3] Applies to elements that support or are part of an environmental separator.
	[F20,F22-OS2.1] [F20,F22-OS2.3] Applies to elements that support or are part of an environmental separator or are exposed to moisture.
	[F20,F22-OP2.1,OP2.4] [F20,F22-OP2.3] Applies to elements that support or are part of an environmental separator or are exposed to moisture.
	[F20,F22-OS1.2] Applies to assemblies required to provide fire resistance.
	[F20,F22-OH4] Applies to floors and elements that support floors.
	[F20,F22-OS3.1] Applies to floors and elements that support floors.
(2)	[F20,F22-OH1.1,OH1.2,OH1.3] Applies to elements that support or are part of an environmental separator.
	[F20,F22-OS2.1] [F20,F22-OS2.3] Applies to elements that support or are part of an environmental separator.
	[F20,F22-OP2.1,OP2.4] [F20,F22-OP2.3] Applies to elements that support or are part of an environmental separator or are exposed to moisture.
	[F20,F22-OS1.2] Applies to assemblies required to provide fire resistance.
	[F80-OS2.1] [F80-OS2.3] Applies to elements that support or are part of an environmental separator or are exposed to moisture.
	[F80-OP2.1,OP2.4] [F80-OP2.3] Applies to elements that support or are part of an environmental separator or are exposed to moisture.
(4)	[F80-OH1.1,OH1.2,OH1.3] Applies to elements that support or are part of an environmental separator.
	[F80-OS1.2] Applies to assemblies required to provide fire resistance.
	[F80-OH4] Applies to floors and elements that support floors.
	[F80-OS3.1] Applies to floors and elements that support floors.
	[F80-OS3.7] Applies to walls, and elements that support walls, that contain doors or windows required for emergency egress.

**Table 9.37.1.1. (Continued)**

Functional Statements and Objectives <sup>(1)</sup>	
<b>9.20.6.1. Thickness of Exterior Walls</b>	
(1)	[F20,F22-OH1.1,OH1.2,OH1.3] Applies to elements that support or are part of an environmental separator.
	[F20-OS2.1,OS2.5] [F22-OS2.5] [F20,F22-OS2.3] Applies to elements that support or are part of an environmental separator.
	[F20-OP2.1,OP2.4,OP2.5] [F22-OP2.4,OP2.5] [F20,F22-OP2.3] Applies to elements that support or are part of an environmental separator.
	[F20,F22-OH4] Applies to floors and elements that support floors.
	[F20,F22-OS3.1] Applies to floors and elements that support floors.
	[F20,F22-OH1.1,OH1.2,OH1.3] Applies to elements that support or are part of an environmental separator.
(2)	[F20,F22-OH1.1,OH1.2,OH1.3] Applies to elements that support or are part of an environmental separator.
	[F20-OS2.1,OS2.5] [F22-OS2.5] [F20,F22-OS2.3] Applies to elements that support or are part of an environmental separator.
	[F20-OP2.1,OP2.4,OP2.5] [F22-OP2.4,OP2.5] [F20,F22-OP2.3] Applies to elements that support or are part of an environmental separator.
	[F20,F22-OH4] Applies to floors and elements that support floors.
	[F20,F22-OS3.1] Applies to floors and elements that support floors.
	[F20,F22-OH1.1,OH1.2,OH1.3] Applies to elements that support or are part of an environmental separator.
(3)	[F20,F22-OH1.1,OH1.2,OH1.3] Applies to elements that support or are part of an environmental separator.
	[F20-OS2.1,OS2.5] [F22-OS2.5] [F20,F22-OS2.3] Applies to elements that support or are part of an environmental separator.
	[F20-OP2.1,OP2.4,OP2.5] [F22-OP2.4,OP2.5] [F20,F22-OP2.3] Applies to elements that support or are part of an environmental separator.
	[F20,F22-OS1.2] Applies to assemblies required to provide fire resistance.
	[F20,F22-OH4] Applies to floors and elements that support floors.
	[F20,F22-OS3.1] Applies to floors and elements that support floors.

Copyright © NRC 1941 - 2021 World Rights Reserved © CNRC 1941-2021 Droits réservés pour tous pays

Table 9.37.1.1. (Continued)

Functional Statements and Objectives <sup>(1)</sup>	
<b>9.20.6.2. Cavity Walls</b>	
(1)	[F20,F22-OH1.1,OH1.2,OH1.3] Applies to elements that support or are part of an environmental separator. [F20-OS2.1,OS2.5] [F22-OS2.5] [F20,F22-OS2.3] Applies to elements that support or are part of an environmental separator or are exposed to moisture. [F20-OP2.1,OP2.4,OP2.5] [F22-OP2.4,OP2.5] [F20,F22-OP2.3] Applies to elements that support or are part of an environmental separator or are exposed to moisture. [F20,F22-OS1.2] Applies to assemblies required to provide fire resistance. [F20,F22-OH4] Applies to floors and elements that support floors. [F20,F22-OS3.1] Applies to floors and elements that support floors.
(2)	[F20,F22,F61-OH1.1,OH1.2,OH1.3] Applies to elements that support or are part of an environmental separator. [F20-OS2.1,OS2.5] [F22-OS2.5] [F20,F22,F61-OS2.3] Applies to elements that support or are part of an environmental separator. [F20-OP2.1,OP2.4,OP2.5] [F22-OP2.4,OP2.5] [F20,F22,F61-OP2.3] Applies to elements that support or are part of an environmental separator. [F20,F22-OH4] Applies to floors and elements that support floors. [F20,F22-OS3.1] Applies to floors and elements that support floors. [F61-OS1.2] Applies to assemblies required to provide fire resistance.
(3)	[F20,F22-OH1.1,OH1.2,OH1.3] Applies to elements that support or are part of an environmental separator. [F20-OS2.1,OS2.5] [F22-OS2.5] [F20,F22-OS2.3] Applies to elements that support or are part of an environmental separator or are exposed to moisture. [F20-OP2.1,OP2.4,OP2.5] [F22-OP2.4,OP2.5] [F20,F22-OP2.3] Applies to elements that support or are part of an environmental separator. [F20,F22-OH4] Applies to floors and elements that support floors. [F20,F22-OS3.1] Applies to floors and elements that support floors.
<b>9.20.6.3. Thickness of Interior Walls</b>	
(2)	(b) [F20-OS2.1,OS2.3,OS2.5] [F22-OS2.5] (b) [F20-OP2.1,OP2.3,OP2.5] [F22-OP2.5]

Table 9.37.1.1. (Continued)

Functional Statements and Objectives <sup>(1)</sup>	
<b>9.20.6.4. Masonry Veneer</b>	
(1)	[F20-OS2.1,OS2.5] [F22-OS2.5] [F20,F22-OS2.3] Applies to elements that are part of an environmental separator. [F20-OP2.1,OP2.5] [F22-OP2.5] [F20,F22-OP2.3] Applies to elements that are part of an environmental separator. [F20,F22-OH1.1,OH1.2,OH1.3] Applies to elements that are part of an environmental separator. [F20,F22-OS1.2] Applies to assemblies required to provide fire resistance.
(2)	[F61-OS2.3] [F61-OH1.1,OH1.2,OH1.3] [F61-OP2.3] [F61-OS1.2] Applies to assemblies required to provide fire resistance.
(3)	[F20-OS2.1,OS2.3,OS2.5] [F22-OS2.3,OS2.5] [F20-OP2.1,OP2.3,OP2.5] [F22-OP2.3,OP2.5] [F20,F22-OH1.1,OH1.2,OH1.3] [F20,F22-OS1.2] Applies to assemblies required to provide fire resistance.
<b>9.20.6.5. Parapet Walls</b>	
(1)	[F20-OS2.1,OS2.3,OS2.5] [F22-OS2.5] [F20-OP2.1,OP2.3,OP2.5] [F22-OP2.5] [F20,F22-OH1.1,OH1.2,OH1.3]
(2)	[F61-OS2.3] [F61-OP2.3] [F61-OH1.1,OH1.2,OH1.3] [F61-OS1.2]
<b>9.20.7.1. Maximum Dimensions</b>	
(1)	[F20-OS2.1,OS2.5] [F22-OS2.5] [F20,F22-OS2.3] Applies to elements that support or are part of an environmental separator. [F20-OP2.1,OP2.4,OP2.5] [F22-OP2.4,OP2.5] [F20,F22-OP2.3] Applies to elements that support or are part of an environmental separator. [F20,F22-OH1.1,OH1.2,OH1.3] Applies to elements that support or are part of an environmental separator. [F20,F22-OS1.2] Applies to assemblies required to provide fire resistance. [F20,F22-OH4] Applies to floors and elements that support floors. [F20,F22-OS3.1] Applies to floors and elements that support floors.

**Table 9.37.1.1. (Continued)**

Functional Statements and Objectives <sup>(1)</sup>	
<b>9.20.7.2. Minimum Wall Thickness</b>	
(1)	[F20-OS2.1,OS2.5] [F22-OS2.5] [F20,F22-OS2.3] Applies to elements that support or are part of an environmental separator.
	[F20-OP2.1,OP2.4,OP2.5] [F22-OP2.4,OP2.5] [F20,F22-OP2.3] Applies to elements that support or are part of an environmental separator.
	[F20,F22-OH1.1,OH1.2,OH1.3] Applies to elements that support or are part of an environmental separator.
	[F20,F22-OS1.2] Applies to assemblies required to provide fire resistance.
	[F20,F22-OH4] Applies to floors and elements that support floors.
	[F20,F22-OS3.1] Applies to floors and elements that support floors.
(2)	[F20-OS2.1,OS2.5] [F22-OS2.5] [F20,F22-OS2.3] Applies to elements that support or are part of an environmental separator.
	[F20-OP2.1,OP2.4,OP2.5] [F22-OP2.4,OP2.5] [F20,F22-OP2.3] Applies to elements that support or are part of an environmental separator.
	[F20,F22-OH1.1,OH1.2,OH1.3] Applies to elements that support or are part of an environmental separator.
	[F20,F22-OS1.2] Applies to assemblies required to provide fire resistance.
	[F20,F22-OH4] Applies to floors and elements that support floors.
	[F20,F22-OS3.1] Applies to floors and elements that support floors.
<b>9.20.7.3. Separation of Chases or Recesses</b>	
(1)	[F20-OS2.1,OS2.5] [F22-OS2.5] [F20,F22-OS2.3] Applies to elements that support or are part of an environmental separator.
	[F20-OP2.1,OP2.4,OP2.5] [F22-OP2.4,OP2.5] [F20,F22-OP2.3] Applies to elements that support or are part of an environmental separator.
	[F20,F22-OH1.1,OH1.2,OH1.3] Applies to elements that support or are part of an environmental separator.
	[F20,F22-OS1.2] Applies to assemblies required to provide fire resistance.
	[F20,F22-OH4] Applies to floors and elements that support floors.
	[F20,F22-OS3.1] Applies to floors and elements that support floors.

**Table 9.37.1.1. (Continued)**

Functional Statements and Objectives <sup>(1)</sup>	
<b>9.20.7.4. Non-Conforming Chases or Recesses</b>	
(1)	[F20,F22-OS1.2] Applies to assemblies required to provide fire resistance.
	[F20-OS2.1,OS2.5] [F22-OS2.5] [F20,F22-OS2.3] Applies to elements that support or are part of an environmental separator.
	[F20-OP2.1,OP2.4,OP2.5] [F22-OP2.4,OP2.5] [F20,F22-OP2.3] Applies to elements that support or are part of an environmental separator.
	[F20,F22-OH1.1,OH1.2,OH1.3] Applies to elements that support or are part of an environmental separator.
	[F20,F22-OH4] Applies to floors and elements that support floors.
	[F20,F22-OS3.1] Applies to floors and elements that support floors.
<b>9.20.7.5. Chases or Recesses Cut into Walls</b>	
(1)	[F20-OH1.1,OH1.2,OH1.3] Applies to elements that support or are part of an environmental separator.
	[F20-OS2.1] [F20-OS2.3] Applies to elements that support or are part of an environmental separator.
	[F20-OP2.1,OP2.4] [F20-OP2.3] Applies to elements that support or are part of an environmental separator.
	[F20-OS1.2] Applies to assemblies required to provide fire resistance.
	[F20-OH4] Applies to floors and elements that support floors.
	[F20-OS3.1] Applies to floors and elements that support floors.
<b>9.20.8.1. Capping of Hollow Masonry Walls</b>	
(1)	[F20-OH1.1,OH1.2,OH1.3] Applies to elements that support or are part of an environmental separator.
	[F20-OS2.1] [F20-OS2.3] Applies to elements that support or are part of an environmental separator.
	[F20-OP2.1,OP2.4] [F20-OP2.3] Applies to elements that support or are part of an environmental separator.
	[F20-OS1.2] Applies to assemblies required to provide fire resistance.
	[F20-OH4] Applies to floors and elements that support floors.
	[F20-OS3.1] Applies to floors and elements that support floors.

Table 9.37.1.1. (Continued)

Functional Statements and Objectives <sup>(1)</sup>	
(2)	[F20-OH1.1,OH1.2,OH1.3] Applies to elements that support or are part of an environmental separator.
	[F20-OS2.1] [F20-OS2.3] Applies to elements that support or are part of an environmental separator.
	[F20-OP2.1,OP2.4] [F20-OP2.3] Applies to elements that support or are part of an environmental separator.
	[F20-OS1.2] Applies to assemblies required to provide fire resistance.
	[F20-OH4] Applies to floors and elements that support floors.
	[F20-OS3.1] Applies to floors and elements that support floors.
<b>9.20.8.2. Cavity Walls Supporting Framing Members</b>	
(1)	[F20-OH1.1,OH1.2,OH1.3] Applies to elements that support or are part of an environmental separator.
	[F20-OS2.1] [F20-OS2.3] Applies to elements that support or are part of an environmental separator.
	[F20-OP2.1,OP2.4] [F20-OP2.3] Applies to elements that support or are part of an environmental separator.
	[F20-OS1.2] Applies to assemblies required to provide fire resistance.
	[F20-OH4] Applies to floors and elements that support floors.
	[F20-OS3.1] Applies to floors and elements that support floors.
	[F80-OS2.3] [F80-OP2.3]
(3)	[F20-OH1.1,OH1.2,OH1.3] Applies to elements that support or are part of an environmental separator.
	[F20-OS2.1] [F20-OS2.3] Applies to elements that support or are part of an environmental separator.
	[F20-OP2.1,OP2.4] [F20-OP2.3] Applies to elements that support or are part of an environmental separator.
	[F20-OS1.2] Applies to assemblies required to provide fire resistance.
	[F20-OH4] Applies to floors and elements that support floors.
	[F20-OS3.1] Applies to floors and elements that support floors.
<b>9.20.8.3. Bearing of Beams and Joists</b>	
(1)	[F20-OS2.1] [F20-OS2.3] Applies to elements that support or are part of an environmental separator.
	[F20-OP2.1] [F20-OP2.3] Applies to elements that support or are part of an environmental separator.

Table 9.37.1.1. (Continued)

Functional Statements and Objectives <sup>(1)</sup>	
(2)	[F20-OS2.1] [F20-OS2.3] Applies to elements that support or are part of an environmental separator.
	[F20-OP2.1] [F20-OP2.3] Applies to elements that support or are part of an environmental separator.
(3)	[F20-OS2.1] [F20-OS2.3] Applies to elements that support or are part of an environmental separator.
	[F20-OP2.1] [F20-OP2.3] Applies to elements that support or are part of an environmental separator.
<b>9.20.8.4. Support of Beams and Columns</b>	
(1)	[F20-OS2.1,OS2.5] [F22-OS2.5] [F20,F22-OS2.3] Applies to elements that support or are part of an environmental separator.
	[F20-OP2.1,OP2.4,OP2.5] [F22-OP2.4,OP2.5] [F20,F22-OP2.3] Applies to elements that support or are part of an environmental separator.
	[F20,F22-OH1.1,OH1.2,OH1.3] Applies to elements that support or are part of an environmental separator.
	[F20,F22-OS1.2] Applies to assemblies required to provide fire resistance.
	[F20,F22-OH4] Applies to floors and elements that support floors.
	[F20,F22-OS3.1] Applies to floors and elements that support floors.
	[F20-OH1.1,OH1.2,OH1.3] Applies to elements that support or are part of an environmental separator.
(2)	[F20-OS2.1] [F20-OS2.3] Applies to elements that support or are part of an environmental separator.
	[F20-OP2.1,OP2.4] [F20-OP2.3] Applies to elements that support or are part of an environmental separator.
	[F20-OS1.2] Applies to assemblies required to provide fire resistance.
	[F20-OH4] Applies to floors and elements that support floors.
	[F20-OS3.1] Applies to floors and elements that support floors.

**Table 9.37.1.1. (Continued)**

Functional Statements and Objectives <sup>(1)</sup>	
(3)	[F20,F22-OH1.1,OH1.2,OH1.3] Applies to elements that support or are part of an environmental separator.
	[F20-OS2.1,OS2.5] [F22-OS2.5] [F20,F22-OS2.3] Applies to elements that support or are part of an environmental separator.
	[F20-OP2.1,OP2.4,OP2.5] [F22-OP2.4,OP2.5] [F20,F22-OP2.3] Applies to elements that support or are part of an environmental separator.
	[F20,F22-OS1.2] Applies to assemblies required to provide fire resistance.
	[F20,F22-OH4] Applies to floors and elements that support floors.
	[F20,F22-OS3.1] Applies to floors and elements that support floors.
	(4)
[F20-OS2.1,OS2.5] [F22-OS2.5] [F20,F22-OS2.3] Applies to elements that support or are part of an environmental separator.	
[F20-OP2.1,OP2.4,OP2.5] [F22-OP2.4,OP2.5] [F20,F22-OP2.3] Applies to elements that support or are part of an environmental separator.	
[F20,F22-OS1.2] Applies to assemblies required to provide fire resistance.	
[F20,F22-OH4] Applies to floors and elements that support floors.	
[F20,F22-OS3.1] Applies to floors and elements that support floors.	
(5)	
	[F20-OS2.1,OS2.5] [F22-OS2.5] [F20,F22-OS2.3] Applies to elements that support or are part of an environmental separator.
	[F20-OP2.1,OP2.4,OP2.5] [F22-OP2.4,OP2.5] [F20,F22-OP2.3] Applies to elements that support or are part of an environmental separator.
	[F20,F22-OS1.2] Applies to assemblies required to provide fire resistance.
	[F20,F22-OH4] Applies to floors and elements that support floors.
	[F20,F22-OS3.1] Applies to floors and elements that support floors.

**Table 9.37.1.1. (Continued)**

Functional Statements and Objectives <sup>(1)</sup>	
<b>9.20.8.5. Projection of Masonry Veneer Beyond Supporting Members</b>	
(1)	[F20,F22-OH1.1,OH1.2,OH1.3] Applies to elements that support or are part of an environmental separator.
	[F20-OS2.1,OS2.5] [F22-OS2.5] [F20,F22-OS2.3] Applies to elements that support or are part of an environmental separator.
	[F20-OP2.1,OP2.4,OP2.5] [F22-OP2.4,OP2.5] [F20,F22-OP2.3] Applies to elements that support or are part of an environmental separator.
	[F20,F22-OS1.2] Applies to assemblies required to provide fire resistance.
<b>9.20.9.1. Joints to be Offset or Reinforced</b>	
(1)	[F20-OH1.1,OH1.2,OH1.3] Applies to elements that support or are part of an environmental separator.
	[F20-OS2.1] [F20-OS2.3] Applies to elements that support or are part of an environmental separator.
	[F20-OP2.1,OP2.4] [F20-OP2.3] Applies to elements that support or are part of an environmental separator.
	[F20-OS1.2] Applies to assemblies required to provide fire resistance.
	[F20-OH4] Applies to floors and elements that support floors.
	[F20-OS3.1] Applies to floors and elements that support floors.
(2)	[F20-OH1.1,OH1.2,OH1.3] Applies to elements that support or are part of an environmental separator.
	[F20-OS2.1] [F20-OS2.3] Applies to elements that support or are part of an environmental separator.
	[F20-OP2.1,OP2.4] [F20-OP2.3] Applies to elements that support or are part of an environmental separator.
	[F20-OS1.2] Applies to assemblies required to provide fire resistance.
	[F20-OH4] Applies to floors and elements that support floors.
[F20-OS3.1] Applies to floors and elements that support floors.	

Table 9.37.1.1. (Continued)

Functional Statements and Objectives <sup>(1)</sup>	
<b>9.20.9.2. Bonding or Tying of Other than Masonry Veneer</b>	
(1)	[F20-OS2.1,OS2.5] [F22-OS2.5] [F20,F22-OS2.3] Applies to elements that support or are part of an environmental separator.
	[F20-OP2.1,OP2.5] [F22-OP2.4,OP2.5] [F20,F22-OP2.3] Applies to elements that support or are part of an environmental separator.
	[F20,F22-OH1.1,OH1.2,OH1.3] Applies to elements that support or are part of an environmental separator.
	[F20,F22-OH4] Applies to floors and elements that support floors.
	[F20,F22-OS3.1] Applies to floors and elements that support floors. [F20,F22-OS3.7] Applies to walls, and elements that support walls, that contain doors or windows required for emergency egress.
	[F20,F22-OS1.2] Applies to assemblies required to provide fire resistance.
	<b>9.20.9.3. Bonding</b>
(1)	[F20-OH1.1,OH1.2,OH1.3] Applies to elements that support or are part of an environmental separator.
	[F20-OS2.1] [F20-OS2.3] Applies to elements that support or are part of an environmental separator.
	[F20-OP2.1,OP2.4] [F20-OP2.3] Applies to elements that support or are part of an environmental separator.
	[F20-OS1.2] Applies to assemblies required to provide fire resistance.
	[F20-OH4] Applies to floors and elements that support floors.
	[F20-OS3.1] Applies to floors and elements that support floors.
(2)	[F20-OH1.1,OH1.2,OH1.3] Applies to elements that support or are part of an environmental separator.
	[F20-OS2.1] [F20-OS2.3] Applies to elements that support or are part of an environmental separator.
	[F20-OP2.1,OP2.4] [F20-OP2.3] Applies to elements that support or are part of an environmental separator.
	[F20-OS1.2] Applies to assemblies required to provide fire resistance.
	[F20-OH4] Applies to floors and elements that support floors.
	[F20-OS3.1] Applies to floors and elements that support floors.

Table 9.37.1.1. (Continued)

Functional Statements and Objectives <sup>(1)</sup>	
(3)	[F20-OH1.1,OH1.2,OH1.3] Applies to elements that support or are part of an environmental separator.
	[F20-OS2.1] [F20-OS2.3] Applies to elements that support or are part of an environmental separator.
	[F20-OP2.1,OP2.4] [F20-OP2.3] Applies to elements that support or are part of an environmental separator.
	[F20-OS1.2] Applies to assemblies required to provide fire resistance.
	[F20-OH4] Applies to floors and elements that support floors.
	[F20-OS3.1] Applies to floors and elements that support floors.
<b>9.20.9.4. Tying</b>	
(2)	[F20,F80-OH1.1,OH1.2,OH1.3] Applies to elements that support or are part of an environmental separator.
	[F20,F80-OS2.1] [F20,F80-OS2.3] Applies to elements that support or are part of an environmental separator.
	[F20,F80-OP2.1,OP2.4] [F20,F80-OP2.3] Applies to elements that support or are part of an environmental separator.
	[F20,F80-OS1.2] Applies to assemblies required to provide fire resistance.
	[F20,F80-OH4] Applies to floors and elements that support floors.
(3)	[F20,F80-OS3.1] Applies to floors and elements that support floors. [F20,F80-OS3.7] Applies to walls, and elements that support walls, that contain doors or windows required for emergency egress.
	[F20,F80-OH1.1,OH1.2,OH1.3] Applies to elements that support or are part of an environmental separator.
	[F20,F80-OS2.1] [F20,F80-OS2.3] Applies to elements that support or are part of an environmental separator.
	[F20,F80-OP2.1,OP2.4] [F20,F80-OP2.3] Applies to elements that support or are part of an environmental separator.
	[F20,F80-OS1.2] Applies to assemblies required to provide fire resistance.
	[F20,F80-OH4] Applies to floors and elements that support floors.
(3)	[F20,F80-OS3.1] Applies to floors and elements that support floors. [F20,F80-OS3.7] Applies to walls, and elements that support walls, that contain doors or windows required for emergency egress.

**Table 9.37.1.1. (Continued)**

Functional Statements and Objectives <sup>(1)</sup>	
(4)	[F20,F80-OH1.1,OH1.2,OH1.3] Applies to elements that support or are part of an environmental separator.
	[F20,F80-OS2.1] [F20,F80-OS2.3] Applies to elements that support or are part of an environmental separator.
	[F20,F80-OP2.1,OP2.4] [F20,F80-OP2.3] Applies to elements that support or are part of an environmental separator.
	[F20,F80-OS1.2] Applies to assemblies required to provide fire resistance.
	[F20,F80-OH4] Applies to floors and elements that support floors.
	[F20,F80-OS3.1] Applies to floors and elements that support floors. [F20,F80-OS3.7] Applies to walls, and elements that support walls, that contain doors or windows required for emergency egress.
(5)	[F20-OH1.1,OH1.2,OH1.3] Applies to elements that support or are part of an environmental separator.
	[F20-OS2.1] [F20-OS2.3] Applies to elements that support or are part of an environmental separator.
	[F20-OP2.1,OP2.4] [F20-OP2.3] Applies to elements that support or are part of an environmental separator.
	[F20-OS1.2] Applies to assemblies required to provide fire resistance.
	[F20-OH4] Applies to floors and elements that support floors.
	[F20-OS3.1] Applies to floors and elements that support floors.
(6)	[F20-OH1.1,OH1.2,OH1.3] Applies to elements that support or are part of an environmental separator.
	[F20-OS2.1] [F20-OS2.3] Applies to elements that support or are part of an environmental separator.
	[F20-OP2.1,OP2.4] [F20-OP2.3] Applies to elements that support or are part of an environmental separator.
	[F20-OS1.2] Applies to assemblies required to provide fire resistance.
	[F20-OH4] Applies to floors and elements that support floors.
	[F20-OS3.1] Applies to floors and elements that support floors.

**Table 9.37.1.1. (Continued)**

Functional Statements and Objectives <sup>(1)</sup>	
(7)	[F20-OH1.1,OH1.2,OH1.3] Applies to elements that support or are part of an environmental separator.
	[F20-OS2.1] [F20-OS2.3] Applies to elements that support or are part of an environmental separator.
	[F20-OP2.1,OP2.4] [F20-OP2.3] Applies to elements that support or are part of an environmental separator.
	[F20-OS1.2] Applies to assemblies required to provide fire resistance.
	[F20-OH4] Applies to floors and elements that support floors.
	[F20-OS3.1] Applies to floors and elements that support floors.
(8)	[F20-OH1.1,OH1.2,OH1.3] Applies to elements that support or are part of an environmental separator.
	[F20-OS2.1] [F20-OS2.3] Applies to elements that support or are part of an environmental separator.
	[F20-OS1.2] Applies to assemblies required to provide fire resistance.
	[F20-OH4] Applies to floors and elements that support floors.
(9)	[F20-OP2.1,OP2.4] [F20-OP2.3] Applies to elements that support or are part of an environmental separator.
	[F20-OS3.1] Applies to floors and elements that support floors.
	[F20-OH1.1,OH1.2,OH1.3] Applies to elements that support or are part of an environmental separator.
	[F20-OS2.1] [F20-OS2.3] Applies to elements that support or are part of an environmental separator.
(9)	[F20-OP2.1,OP2.4] [F20-OP2.3] Applies to elements that support or are part of an environmental separator.
	[F20-OS1.2] Applies to assemblies required to provide fire resistance.
	[F20-OH4] Applies to floors and elements that support floors.
	[F20-OS3.1] Applies to floors and elements that support floors.
<b>9.20.9.5. Ties for Masonry Veneer</b>	
(1)	[F20,F22,F80-OH1.1,OH1.2,OH1.3] Applies to elements that support or are part of an environmental separator.
	[F20,F80-OS2.1] [F20,F22,F80-OS2.5] [F20,F22,F80-OS2.3] Applies to elements that support or are part of an environmental separator.
	[F20,F80-OP2.1] [F20,F22,F80-OP2.5] [F20,F22,F80-OP2.3] Applies to elements that support or are part of an environmental separator.
	[F20,F22,F80-OS1.2] Applies to assemblies required to provide fire resistance.

Table 9.37.1.1. (Continued)

Functional Statements and Objectives <sup>(1)</sup>	
(2)	[F20,F80-OS2.1] [F20,F80-OS2.3] Applies to elements that support or are part of an environmental separator.
	[F20,F80-OP2.1] [F20,F80-OP2.3] Applies to elements that support or are part of an environmental separator.
	[F20,F80-OH1.1,OH1.2,OH1.3] Applies to elements that support or are part of an environmental separator.
	[F20,F80-OS1.2] Applies to assemblies required to provide fire resistance.
<b>9.20.9.6. Reinforcing for Glass Block</b>	
(1)	[F20-OH1.1,OH1.2,OH1.3] Applies to elements that are part of an environmental separator.
	[F20-OS2.1] [F20-OS2.3] Applies to elements that are part of an environmental separator.
	[F20-OP2.1] [F20-OP2.3] Applies to elements that are part of an environmental separator.
	[F20-OS1.2] Applies to assemblies required to provide fire resistance.
(2)	[F20-OH1.1,OH1.2,OH1.3] Applies to elements that are part of an environmental separator.
	[F20-OS2.1] [F20-OS2.3] Applies to elements that are part of an environmental separator.
	[F20-OP2.1] [F20-OP2.3] Applies to elements that are part of an environmental separator.
	[F20-OS1.2] Applies to assemblies required to provide fire resistance.
<b>9.20.10.1. Lateral Support Required</b>	
(1)	[F20,F22-OH1.1,OH1.2,OH1.3] Applies to elements that support or are part of an environmental separator.
	[F20-OS2.1] [F20,F22-OS2.5] [F20,F22-OS2.3] Applies to elements that support or are part of an environmental separator.
	[F20-OP2.1] [F20,F22-OP2.4,OP2.5] [F20,F22-OP2.3] Applies to elements that support or are part of an environmental separator.
	[F20,F22-OS1.2] Applies to assemblies required to provide fire resistance.
	[F20,F22-OH4] Applies to floors and elements that support floors.
	[F20,F22-OS3.1] Applies to floors and elements that support floors.

Table 9.37.1.1. (Continued)

Functional Statements and Objectives <sup>(1)</sup>	
(2)	(a) [F20,F22-OH1.1,OH1.2,OH1.3] Applies to elements that support or are part of an environmental separator.
	[F20-OS2.1] [F20,F22-OS2.5] (a) [F20,F22-OS2.3] Applies to elements that support or are part of an environmental separator.
	[F20-OP2.1,OP2.4] [F20,F22-OP2.5] (a) [F20,F22-OP2.3] Applies to elements that support or are part of an environmental separator.
	[F20,F22-OS1.2] Applies to assemblies required to provide fire resistance.
	(a) [F20,F22-OH4] Applies to floors and elements that support floors.
	(a) [F20,F22-OS3.1] Applies to floors and elements that support floors.
	(4)
(4)	[F20,F22-OH1.1,OH1.2,OH1.3] Applies to elements that support or are part of an environmental separator.
	[F20-OS2.1] [F20,F22-OS2.5] [F20,F22-OS2.3] Applies to elements that support or are part of an environmental separator or are exposed to moisture.
	[F20-OP2.1] [F20,F22-OP2.4,OP2.5] [F20,F22-OP2.3] Applies to elements that support or are part of an environmental separator or are exposed to moisture.
	[F20,F22-OS1.2] Applies to assemblies required to provide fire resistance.
	[F20,F22-OH4] Applies to floors and elements that support floors.
	[F20,F22-OS3.1] Applies to floors and elements that support floors.
	<b>9.20.11.1. Anchorage to Floor or Roof Assemblies where Masonry Walls Require Lateral Support</b>
(1)	[F20,F22-OH1.1,OH1.2,OH1.3] Applies to elements that support or are part of an environmental separator.
	[F20-OS2.1] [F20,F22-OS2.5] [F20,F22-OS2.3] Applies to elements that support or are part of an environmental separator.
	[F20-OP2.1] [F20,F22-OP2.4,OP2.5] [F20,F22-OP2.3] Applies to elements that support or are part of an environmental separator.
	[F20,F22-OS1.2] Applies to assemblies required to provide fire resistance.
	[F20,F22-OH4] Applies to floors and elements that support floors.
	[F20,F22-OS3.1] Applies to floors and elements that support floors.

Copyright © NRC 1941 - 2021 World Rights Reserved © CNRC 1941-2021 Droits réservés pour tous pays



**Table 9.37.1.1. (Continued)**

Functional Statements and Objectives <sup>(1)</sup>	
(2)	[F20,F80-OH1.1,OH1.2,OH1.3] Applies to elements that support or are part of an environmental separator.
	[F20,F80-OS2.1] [F20,F80-OS2.3] Applies to elements that support or are part of an environmental separator.
	[F20,F80-OP2.1,OP2.4] [F20,F80-OP2.3] Applies to elements that support or are part of an environmental separator or are exposed to moisture.
	[F20,F80-OS1.2] Applies to assemblies required to provide fire resistance.
	[F20,F80-OH4] Applies to floors and elements that support floors.
	[F20,F80-OS3.1] Applies to floors and elements that support floors. [F20,F80-OS3.7] Applies to walls, and elements that support walls, that contain doors or windows required for emergency egress.
(3)	[F20-OH1.1,OH1.2,OH1.3] Applies to elements that support or are part of an environmental separator.
	[F20-OS2.1] [F20-OS2.3] Applies to elements that support or are part of an environmental separator.
	[F20-OP2.1,OP2.4] [F20-OP2.3] Applies to elements that support or are part of an environmental separator or are exposed to moisture.
	[F20-OS1.2] Applies to assemblies required to provide fire resistance.
	[F20-OH4] Applies to floors and elements that support floors.
	[F20-OS3.1] Applies to floors and elements that support floors.
(4)	[F20,F22-OH1.1,OH1.2,OH1.3] Applies to elements that support or are part of an environmental separator.
	[F20-OS2.1] [F20,F22-OS2.5] [F20,F22-OS2.3] Applies to elements that support or are part of an environmental separator.
	[F20-OP2.1] [F20,F22-OP2.4,OP2.5] [F20,F22-OP2.3] Applies to elements that support or are part of an environmental separator or are exposed to moisture.
	[F20,F22-OS1.2] Applies to assemblies required to provide fire resistance.
	[F20,F22-OH4] Applies to floors and elements that support floors.
	[F20,F22-OS3.1] Applies to floors and elements that support floors.

**Table 9.37.1.1. (Continued)**

Functional Statements and Objectives <sup>(1)</sup>	
<b>9.20.11.2. Bonding and Tying Intersecting Masonry Walls where Walls Require Lateral Support</b>	
(1)	[F20,F22-OH1.1,OH1.2,OH1.3] Applies to elements that support or are part of an environmental separator.
	[F20-OS2.1] [F20,F22-OS2.5] [F20,F22-OS2.3] Applies to elements that support or are part of an environmental separator.
	[F20-OP2.1] [F20,F22-OP2.4,OP2.5] [F20,F22-OP2.3] Applies to elements that support or are part of an environmental separator or are exposed to moisture.
	[F20,F22-OS1.2] Applies to assemblies required to provide fire resistance.
	[F20,F22-OH4] Applies to floors and elements that support floors.
	[F20,F22-OS3.1] Applies to floors and elements that support floors.
	[F20-OH1.1,OH1.2,OH1.3] Applies to elements that support or are part of an environmental separator.
(2)	[F20-OS2.1] [F20-OS2.3] Applies to elements that support or are part of an environmental separator.
	[F20-OP2.1,OP2.4] [F20-OP2.3] Applies to elements that support or are part of an environmental separator.
	[F20-OS1.2] Applies to assemblies required to provide fire resistance.
	[F20-OH4] Applies to floors and elements that support floors.
	[F20-OS3.1] Applies to floors and elements that support floors.
	[F20,F80-OS1.2] Applies to assemblies required to provide fire resistance.
(3)	[F20,F80-OS2.1] [F20,F80-OS2.3] Applies to elements that support or are part of an environmental separator.
	[F20,F80-OP2.1,OP2.4] [F20,F80-OP2.3] Applies to elements that support or are part of an environmental separator.
	[F20,F80-OH1.1,OH1.2,OH1.3] Applies to elements that support or are part of an environmental separator.
	[F20,F80-OH4] Applies to floors and elements that support floors.
	[F20,F80-OS3.1] Applies to floors and elements that support floors.
	[F20,F80-OS3.7] Applies to walls, and elements that support walls, that contain doors or windows required for emergency egress.

Table 9.37.1.1. (Continued)

Functional Statements and Objectives <sup>(1)</sup>	
<b>9.20.11.3. Anchoring Intersecting Wood-Frame Walls to Masonry Walls</b>	
(1)	[F20,F22,F80-OH1.1,OH1.2,OH1.3] Applies to elements that support or are part of an environmental separator. [F20,F80-OS2.1] [F20,F22,F80-OS2.5] [F20,F22,F80-OS2.3] Applies to elements that support or are part of an environmental separator. [F20,F80-OP2.1] [F20,F22,F80-OP2.4,OP2.5] [F20,F22,F80-OP2.3] Applies to elements that support or are part of an environmental separator. [F20,F22,F80-OS1.2] Applies to assemblies required to provide fire resistance. [F20,F22,F80-OH4] Applies to floors and elements that support floors. [F20,F22,F80-OS3.1] Applies to floors and elements that support floors. [F20,F22,F80-OS3.7] Applies to walls, and elements that support walls, that contain doors or windows required for emergency egress.
(2)	[F20-OH1.1,OH1.2,OH1.3] Applies to elements that support or are part of an environmental separator. [F20-OS2.1] [F20-OS2.3] Applies to elements that support or are part of an environmental separator. [F20-OP2.1,OP2.4] [F20-OP2.3] Applies to elements that support or are part of an environmental separator. [F20-OS1.2] Applies to assemblies required to provide fire resistance. [F20-OH4] Applies to floors and elements that support floors. [F20-OS3.1] Applies to floors and elements that support floors.
<b>9.20.11.4. Anchoring Wood-Frame Roof Systems to Masonry Walls</b>	
(1)	[F20-OH1.1,OH1.2,OH1.3] [F20-OS2.1,OS2.3] [F20-OP2.1,OP2.3]
(2)	[F20-OH1.1,OH1.2,OH1.3] [F20-OS2.1,OS2.3] [F20-OP2.1,OP2.3]
<b>9.20.11.5. Anchoring Masonry Cornices, Sills and Trim to Masonry Walls</b>	
(1)	[F20,F80-OS2.1,OS2.3,OS2.5] [F22-OS2.5]

Table 9.37.1.1. (Continued)

Functional Statements and Objectives <sup>(1)</sup>	
<b>9.20.11.6. Anchoring to Masonry Piers</b>	
(1)	[F20-OS2.1] [F20-OS2.3] Applies to elements that support or are part of an environmental separator. [F20-OP2.1] [F20-OP2.3] Applies to elements that support or are part of an environmental separator. [F20-OH1.1,OH1.2,OH1.3] Applies to elements that support or are part of an environmental separator. [F20-OH4] Applies to floors and elements that support floors. [F20-OS3.1] Applies to floors and elements that support floors. [F20-OS1.2] Applies to assemblies required to provide fire resistance.
<b>9.20.12.1. Corbelling</b>	
(1)	[F20-OS2.1] [F20-OS2.3] Applies to elements that support or are part of an environmental separator. [F20-OP2.1] [F20-OP2.3] Applies to elements that support or are part of an environmental separator. [F20-OH1.1,OH1.2,OH1.3] Applies to elements that support or are part of an environmental separator. [F20-OS1.2] Applies to assemblies required to provide fire resistance. [F20-OH4] Applies to floors and elements that support floors. [F20-OS3.1] Applies to floors and elements that support floors.
(2)	[F20-OS2.1] [F20-OS2.3] Applies to elements that support or are part of an environmental separator. [F20-OP2.1,OP2.4] [F20-OP2.3] Applies to elements that support or are part of an environmental separator. [F20-OH1.1,OH1.2,OH1.3] Applies to elements that support or are part of an environmental separator. [F20-OS1.2] Applies to assemblies required to provide fire resistance. [F20-OH4] Applies to floors and elements that support floors. [F20-OS3.1] Applies to floors and elements that support floors.
<b>9.20.12.2. Corbelling for Cavity Walls</b>	
(1)	[F20-OH1.1,OH1.2,OH1.3] Applies to elements that support or are part of an environmental separator. [F20-OS2.1] [F20-OS2.3] Applies to elements that support or are part of an environmental separator. [F20-OP2.1,OP2.4] [F20-OP2.3] Applies to elements that support or are part of an environmental separator. [F20-OH4] Applies to floors and elements that support floors. [F20-OS3.1] Applies to floors and elements that support floors.

**Table 9.37.1.1. (Continued)**

Functional Statements and Objectives <sup>(1)</sup>	
(2)	[F20-OH1.1,OH1.2,OH1.3] Applies to elements that support or are part of an environmental separator.
	[F20-OS2.1] [F20-OS2.3] Applies to elements that support or are part of an environmental separator.
	[F20-OP2.1,OP2.4] [F20-OP2.3] Applies to elements that support or are part of an environmental separator.
	[F20-OH4] Applies to floors and elements that support floors.
	[F20-OS3.1] Applies to floors and elements that support floors.
<b>9.20.12.3. Corbelling for Masonry Veneer</b>	
(1)	[F20-OH1.1,OH1.2,OH1.3] Applies to elements that support or are part of an environmental separator.
	[F20-OS2.1] [F20-OS2.3] Applies to elements that support or are part of an environmental separator.
	[F20-OP2.1] [F20-OP2.3] Applies to elements that support or are part of an environmental separator.
(2)	[F20-OH1.1,OH1.2,OH1.3] Applies to elements that support or are part of an environmental separator.
	[F20-OS2.1] [F20-OS2.3] Applies to elements that support or are part of an environmental separator.
	[F20-OP2.1] [F20-OP2.3] Applies to elements that support or are part of an environmental separator.
<b>9.20.13.1. Materials for Flashing</b>	
(1)	[F80-OS2.1,OS2.3]
	[F80-OP2.1,OP2.3]
	[F80-OH1.1,OH1.2,OH1.3]
	[F80-OS1.2] Applies to assemblies required to provide fire resistance.
(2)	[F80-OS2.1,OS2.3]
	[F80-OP2.1,OP2.3]
	[F80-OH1.1,OH1.2,OH1.3]
	[F80-OS1.2] Applies to assemblies required to provide fire resistance.
<b>9.20.13.2. Fastening of Flashing</b>	
(1)	[F80-OH1.1,OH1.2,OH1.3]
	[F80-OS2.1,OS2.3]
	[F80-OP2.1,OP2.3]
	[F80-OS1.2] Applies to assemblies required to provide fire resistance.
<b>9.20.13.3. Location of Flashing</b>	
(1)	[F61,F62-OS2.1,OS2.3]
	[F61,F62-OP2.1,OP2.3]
	[F61,F62-OH1.1,OH1.2,OH1.3]

**Table 9.37.1.1. (Continued)**

Functional Statements and Objectives <sup>(1)</sup>	
<b>9.20.13.4. Extension of Flashing</b>	
(1)	[F61-OS2.1,OS2.3]
	[F61-OP2.1,OP2.3]
	[F61-OH1.1,OH1.2,OH1.3]
	[F61-OS1.2] Applies to assemblies required to provide fire resistance.
<b>9.20.13.5. Flashing for Weep Holes in Masonry/Masonry Walls</b>	
(1)	[F61,F62-OH1.1,OH1.2,OH1.3]
	[F61,F62-OS2.1,OS2.3]
	[F61,F62-OP2.1,OP2.3]
	[F61,F62-OS1.2] Applies to assemblies required to provide fire resistance.
<b>9.20.13.6. Flashing for Weep Holes in Masonry Veneer</b>	
(2)	[F61,F62-OS2.1,OS2.3]
	[F61,F62-OP2.1,OP2.3]
	[F61,F62-OH1.1,OH1.2,OH1.3]
	[F61,F62-OS1.2] Applies to assemblies required to provide fire resistance.
(3)	[F61-OH1.1,OH1.2,OH1.3]
	[F61-OS2.1,OS2.3]
	[F61-OP2.1,OP2.3]
	[F61-OS1.2] Applies to assemblies required to provide fire resistance.
<b>9.20.13.7. Flashing Joints</b>	
(1)	[F61,F62-OH1.1,OH1.2,OH1.3]
	[F61,F62-OS2.1,OS2.3]
	[F61,F62-OP2.1,OP2.3]
	[F61,F62-OS1.2] Applies to assemblies required to provide fire resistance.
<b>9.20.13.8. Required Weep Holes</b>	
(1)	[F62-OS2.1,OS2.3]
	[F62-OP2.1,OP2.3]
	[F62-OH1.1,OH1.2,OH1.3]
	[F62-OS1.2] Applies to assemblies required to provide fire resistance.
<b>9.20.13.9. Protection of Interior Finish</b>	
(1)	[F61-OH1.1,OH1.2,OH1.3]
	[F61-OS2.1,OS2.3]
	[F61-OP2.1,OP2.3]
(2)	[F61,F62-OS2.1,OS2.3]
	[F61,F62-OP2.1,OP2.3]
	[F61,F62-OH1.1,OH1.2,OH1.3]

Table 9.37.1.1. (Continued)

Functional Statements and Objectives <sup>(1)</sup>		
<b>9.20.13.10. Mortar Droppings</b>		
(1)	[F61,F62-OH1.1,OH1.2,OH1.3]	
	[F61,F62-OS2.1,OS2.3]	
	[F61,F62-OP2.1,OP2.3]	
	[F61,F62-OS1.2] Applies to assemblies required to provide fire resistance.	
<b>9.20.13.12. Drips beneath Window Sills</b>		
(1)	[F61,F62-OH1.1,OH1.2,OH1.3]	
	[F61,F62-OS2.1,OS2.3]	
	[F61,F62-OP2.1,OP2.3]	
	[F61,F62-OS1.2] Applies to assemblies required to provide fire resistance.	
<b>9.20.14.1. Laying Temperature of Mortar and Masonry</b>		
(1)	[F20,F80-OS2.1] [F20,F80-OS2.3] Applies to elements that support or are part of an environmental separator or are exposed to moisture.	
	[F20,F80-OP2.1,OP2.4] [F20,F80-OP2.3] Applies to elements that support or are part of an environmental separator or are exposed to moisture.	
	[F20,F80-OH1.1,OH1.2,OH1.3] Applies to elements that support or are part of an environmental separator.	
	[F20,F80-OS1.2] Applies to assemblies required to provide fire resistance.	
	[F20,F80-OH4] Applies to floors and elements that support floors.	
	[F20,F80-OS3.1] Applies to floors and elements that support floors. [F20,F80-OS3.7] Applies to walls, and elements that support walls, that contain doors or windows required for emergency egress.	
	(2)	[F20,F80-OS2.1] [F20,F80-OS2.3] Applies to elements that support or are part of an environmental separator or are exposed to moisture.
		[F20,F80-OP2.1,OP2.4] [F20,F80-OP2.3] Applies to elements that support or are part of an environmental separator or are exposed to moisture.
		[F20,F80-OH1.1,OH1.2,OH1.3] Applies to elements that support or are part of an environmental separator.
		[F20,F80-OS1.2] Applies to assemblies required to provide fire resistance.
[F20,F80-OH4] Applies to floors and elements that support floors.		
[F20,F80-OS3.1] Applies to floors and elements that support floors. [F20,F80-OS3.7] Applies to walls, and elements that support walls, that contain doors or windows required for emergency egress.		
<b>9.20.14.2. Protection from Weather</b>		
(1)	[F80-OS2.1,OS2.3]	
	[F80-OP2.1,OP2.3]	

Table 9.37.1.1. (Continued)

Functional Statements and Objectives <sup>(1)</sup>	
<b>9.20.15.1. Amount of Reinforcement</b>	
(1)	[F20-OS2.1,OS2.3]
	[F20-OP2.1,OP2.3]
<b>9.20.15.2. Installation Standard</b>	
(1)	[F20-OS2.1,OS2.3]
	[F20-OP2.1,OP2.3]
<b>9.20.16.1. Corrosion Resistance of Connectors</b>	
(1)	[F80-OH1.1,OH1.2,OH1.3] Applies to elements that support or are part of an environmental separator.
	[F80-OS2.1] [F80-OS2.3] Applies to elements that support or are part of an environmental separator or are exposed to moisture.
	[F80-OP2.1,OP2.4] [F80-OP2.3] Applies to elements that support or are part of an environmental separator or are exposed to moisture.
	[F80-OS1.2] Applies to assemblies required to provide fire resistance.
	[F80-OH4] Applies to floors and elements that support floors.
	[F80-OS3.1] Applies to floors and elements that support floors. [F80-OS3.7] Applies to walls, and elements that support walls, that contain doors or windows required for emergency egress.
	<b>9.20.17.1. Thickness of Flat Insulating Concrete Form Walls</b>
(1)	[F20-OS2.1] [F22-OS2.4] [F20,F22-OS2.3] Applies to elements that support or are part of an environmental separator.
	[F20-OP2.1] [F22-OP2.4] [F20,F22-OP2.3] Applies to elements that support or are part of an environmental separator.
	[F20,F22-OH1.1,OH1.2,OH1.3] Applies to elements that support or are part of an environmental separator.
	[F20,F22-OH4] Applies to floors and elements that support floors.
	[F20,F22-OS3.1] Applies to floors and elements that support floors. [F20,F22-OS3.7] Applies to walls, and elements that support walls, that contain doors or windows required for emergency egress.

**Table 9.37.1.1. (Continued)**

Functional Statements and Objectives <sup>(1)</sup>	
<b>9.20.17.2. Reinforcement for Flat Insulating Concrete Form Walls</b>	
(1)	[F20-OS2.1] [F22-OS2.4] [F20,F22-OS2.3] Applies to elements that support or are part of an environmental separator.
	[F20-OP2.1] [F22-OP2.4] [F20,F22-OP2.3] Applies to elements that support or are part of an environmental separator.
	[F20,F22-OH1.1,OH1.2,OH1.3] Applies to elements that support or are part of an environmental separator.
	[F20,F22-OH4] Applies to floors and elements that support floors.
	[F20,F22-OS3.1] Applies to floors and elements that support floors. [F20,F22-OS3.7] Applies to walls, and elements that support walls, that contain doors or windows required for emergency egress.
	[F20-OS2.1] [F22-OS2.4] [F20,F22-OS2.3] Applies to elements that support or are part of an environmental separator.
(2)	[F20-OP2.1] [F22-OP2.4] [F20,F22-OP2.3] Applies to elements that support or are part of an environmental separator.
	[F20,F22-OH1.1,OH1.2,OH1.3] Applies to elements that support or are part of an environmental separator.
	[F20,F22-OH4] Applies to floors and elements that support floors.
	[F20,F22-OS3.1] Applies to floors and elements that support floors. [F20,F22-OS3.7] Applies to walls, and elements that support walls, that contain doors or windows required for emergency egress.
	[F20-OS2.1] [F22-OS2.4] [F20,F22-OS2.3] Applies to elements that support or are part of an environmental separator.
	[F20-OP2.1] [F22-OP2.4] [F20,F22-OP2.3] Applies to elements that support or are part of an environmental separator.
(3)	[F20,F22-OH1.1,OH1.2,OH1.3] Applies to elements that support or are part of an environmental separator.
	[F20,F22-OH4] Applies to floors and elements that support floors.
	[F20,F22-OS3.1] Applies to floors and elements that support floors. [F20,F22-OS3.7] Applies to walls, and elements that support walls, that contain doors or windows required for emergency egress.

**Table 9.37.1.1. (Continued)**

Functional Statements and Objectives <sup>(1)</sup>	
<b>9.20.17.3. Openings in Non-Loadbearing Flat Insulating Concrete Form Walls</b>	
(1)	[F20-OS2.1,OS2.3] [F22-OS2.3,OS2.4] [F20-OP2.1,OP2.3] [F22-OP2.3,OP2.4] [F20,F22-OH1.1,OH1.2,OH1.3] [F20,F22-OH4] Applies to floors and elements that support floors. [F20,F22-OS3.1] Applies to floors and elements that support floors. [F20,F22-OS3.7] Applies to walls, and elements that support walls, that contain doors or windows required for emergency egress.
	[F20-OS2.1] [F22-OS2.4] [F20,F22-OS2.3] Applies to elements that support or are part of an environmental separator.
	[F20-OP2.1] [F22-OP2.4] [F20,F22-OP2.3] Applies to elements that support or are part of an environmental separator.
	[F20,F22-OH1.1,OH1.2,OH1.3] Applies to elements that support or are part of an environmental separator.
	[F20,F22-OH4] Applies to floors and elements that support floors. [F20,F22-OS3.1] Applies to floors and elements that support floors. [F20,F22-OS3.7] Applies to walls, and elements that support walls, that contain doors or windows required for emergency egress.
(3)	[F20-OS2.1] [F22-OS2.4] [F20,F22-OS2.3] Applies to elements that support or are part of an environmental separator.
	[F20-OP2.1] [F22-OP2.4] [F20,F22-OP2.3] Applies to elements that support or are part of an environmental separator.
	[F20,F22-OH1.1,OH1.2,OH1.3] Applies to elements that support or are part of an environmental separator.
	[F20,F22-OH4] Applies to floors and elements that support floors. [F20,F22-OS3.1] Applies to floors and elements that support floors. [F20,F22-OS3.7] Applies to walls, and elements that support walls, that contain doors or windows required for emergency egress.

Table 9.37.1.1. (Continued)

Functional Statements and Objectives <sup>(1)</sup>	
(4)	[F20-OS2.1] [F22-OS2.4] [F20,F22-OS2.3] Applies to elements that support or are part of an environmental separator.
	[F20-OP2.1] [F22-OP2.4] [F20,F22-OP2.3] Applies to elements that support or are part of an environmental separator.
	[F20,F22-OH1.1,OH1.2,OH1.3] Applies to elements that support or are part of an environmental separator.
	[F20,F22-OH4] Applies to floors and elements that support floors.
	[F20,F22-OS3.1] Applies to floors and elements that support floors. [F20,F22-OS3.7] Applies to walls, and elements that support walls, that contain doors or windows required for emergency egress.
(5)	[F20-OS2.1] [F22-OS2.4] [F20,F22-OS2.3] Applies to elements that support or are part of an environmental separator.
	[F20-OP2.1] [F22-OP2.4] [F20,F22-OP2.3] Applies to elements that support or are part of an environmental separator.
	[F20,F22-OH1.1,OH1.2,OH1.3] Applies to elements that support or are part of an environmental separator.
	[F20,F22-OH4] Applies to floors and elements that support floors.
	[F20,F22-OS3.1] Applies to floors and elements that support floors. [F20,F22-OS3.7] Applies to walls, and elements that support walls, that contain doors or windows required for emergency egress.
(6)	[F20-OS2.1] [F22-OS2.4] [F20,F22-OS2.3] Applies to elements that support or are part of an environmental separator.
	[F20-OP2.1] [F22-OP2.4] [F20,F22-OP2.3] Applies to elements that support or are part of an environmental separator.
	[F20,F22-OH1.1,OH1.2,OH1.3] Applies to elements that support or are part of an environmental separator.
	[F20,F22-OH4] Applies to floors and elements that support floors.
	[F20,F22-OS3.1] Applies to floors and elements that support floors. [F20,F22-OS3.7] Applies to walls, and elements that support walls, that contain doors or windows required for emergency egress.

Table 9.37.1.1. (Continued)

Functional Statements and Objectives <sup>(1)</sup>	
<b>9.20.17.4. Openings in Loadbearing Flat Insulating Concrete Form Walls</b>	
(1)	[F20-OS2.1] [F22-OS2.4] [F20,F22-OS2.3] Applies to elements that support or are part of an environmental separator.
	[F20-OP2.1] [F22-OP2.4] [F20,F22-OP2.3] Applies to elements that support or are part of an environmental separator.
	[F20,F22-OH1.1,OH1.2,OH1.3] Applies to elements that support or are part of an environmental separator.
	[F20,F22-OH4] Applies to floors and elements that support floors.
	[F20,F22-OS3.1] Applies to floors and elements that support floors. [F20,F22-OS3.7] Applies to walls, and elements that support walls, that contain doors or windows required for emergency egress.
	[F20-OS2.1] [F22-OS2.4] [F20,F22-OS2.3] Applies to elements that support or are part of an environmental separator.
(2)	[F20-OP2.1] [F22-OP2.4] [F20,F22-OP2.3] Applies to elements that support or are part of an environmental separator.
	[F20,F22-OH1.1,OH1.2,OH1.3] Applies to elements that support or are part of an environmental separator.
	[F20,F22-OH4] Applies to floors and elements that support floors.
	[F20,F22-OS3.1] Applies to floors and elements that support floors. [F20,F22-OS3.7] Applies to walls, and elements that support walls, that contain doors or windows required for emergency egress.
	[F20-OS2.1] [F22-OS2.4] [F20,F22-OS2.3] Applies to elements that support or are part of an environmental separator.
	[F20-OP2.1] [F22-OP2.4] [F20,F22-OP2.3] Applies to elements that support or are part of an environmental separator.
(3)	[F20,F22-OP2.3] Applies to elements that support or are part of an environmental separator.
	[F20,F22-OH1.1,OH1.2,OH1.3] Applies to elements that support or are part of an environmental separator.
	[F20,F22-OH4] Applies to floors and elements that support floors.
	[F20,F22-OS3.1] Applies to floors and elements that support floors. [F20,F22-OS3.7] Applies to walls, and elements that support walls, that contain doors or windows required for emergency egress.

Table 9.37.1.1. (Continued)

Functional Statements and Objectives <sup>(1)</sup>	
(4)	[F20-OS2.1] [F20-OS2.3] Applies to elements that support or are part of an environmental separator.
	[F20-OP2.1] [F20-OP2.3] Applies to elements that support or are part of an environmental separator.
	[F20-OH1.1,OH1.2,OH1.3] Applies to elements that support or are part of an environmental separator.
	[F20-OH4] Applies to floors and elements that support floors.
	[F20-OS3.1] Applies to floors and elements that support floors.
<b>9.20.17.5. Framing Supported on Flat Insulating Concrete Form Walls</b>	
(1)	[F20-OS2.1] [F22-OS2.4] [F20,F22-OS2.3] Applies to elements that support or are part of an environmental separator.
	[F20-OP2.1] [F22-OP2.4] [F20,F22-OP2.3] Applies to elements that support or are part of an environmental separator.
	[F20,F22-OH4]
	[F20,F22-OS3.1]
(2)	[F20-OS2.1] [F22-OS2.4] [F20,F22-OS2.3] Applies to elements that support or are part of an environmental separator.
	[F20-OP2.1] [F22-OP2.4] [F20,F22-OP2.3] Applies to elements that support or are part of an environmental separator.
	[F20,F22-OH4]
	[F20,F22-OS3.1]
(3)	[F20-OS2.1] [F22-OS2.4] [F20,F22-OS2.3] Applies to elements that support or are part of an environmental separator.
	[F20-OP2.1] [F22-OP2.4] [F20,F22-OP2.3] Applies to elements that support or are part of an environmental separator.
	[F20,F22-OH4]
	[F20,F22-OS3.1]
<b>9.20.17.6. Anchoring of Roof Framing to the Top of Flat Insulating Concrete Form Walls</b>	
(1)	[F20-OS2.1,OS2.3] [F22-OS2.3,OS2.4]
	[F20-OP2.1,OP2.3] [F22-OP2.3,OP2.4]
	[F20,F22-OH1.1,OH1.2,OH1.3]
(2)	[F20-OS2.1,OS2.3] [F22-OS2.3,OS2.4]
	[F20-OP2.1,OP2.3] [F22-OP2.3,OP2.4]
	[F20-OH1.1,OH1.2,OH1.3]

Table 9.37.1.1. (Continued)

Functional Statements and Objectives <sup>(1)</sup>	
<b>9.21.1.2. Chimney or Flue Pipe Walls</b>	
(1)	[F01-OS1.1] Applies to the walls of any <i>chimney or flue pipe</i> , which are required to be constructed to be flame-tight.
	[F44-OH1.1] Applies to the walls of any <i>chimney or flue pipe</i> , which are required to be constructed to be smoke-tight.
	[F01-OP1.1] Applies to the walls of any <i>chimney or flue pipe</i> , which are required to be constructed to be flame-tight.
<b>9.21.2.1. Chimney Flue Limitations</b>	
(1)	[F44-OH1.1]
	[F44-OS3.4]
(2)	[F44-OH1.1]
	[F44-OS3.4]
(3)	[F44-OS3.4]
	[F44-OH1.1]
<b>9.21.2.2. Connections of More Than One Appliance</b>	
(1)	[F44-OH1.1]
	[F44-OS3.4]
(2)	[F44-OS3.4]
(3)	[F44-OH1.1]
	[F44-OS3.4]
(4)	[F44-OH1.1]
	[F44-OS3.4]
<b>9.21.2.3. Inclined Chimney Flues</b>	
(1)	[F44-OH1.1]
	[F44-OS3.4]
<b>9.21.2.4. Size of Chimney Flues</b>	
(2)	[F44-OH1.1]
	[F44-OS3.4]
<b>9.21.2.5. Fireplace Chimneys</b>	
(1)	[F44-OH1.1]
	[F44-OS3.4]
<b>9.21.2.6. Oval Chimney Flues</b>	
(1)	[F44-OH1.1]
	[F44-OS3.4]
<b>9.21.3.1. Lining Materials</b>	
(1)	[F20-OS2.3]
	[F20-OH1.1]
	[F01-OS1.1]
	[F44-OS3.4]
	[F44,F01,F20-OP1.1]

Table 9.37.1.1. (Continued)

Functional Statements and Objectives <sup>(1)</sup>	
<b>9.21.3.2. Joints in Chimney Liners</b>	
(1)	[F44-OH1.1]
	[F44,F20-OS2.3]
	[F01-OS1.1]
	[F01-OP1.1]
	[F01-OS3.4]
(2)	[F01-OS1.1]
	[F44-OS3.4]
	[F01-OP1.1]
	[F44-OH1.1]
<b>9.21.3.3. Clay Liners</b>	
(1)	[F20-OS2.2]
	[F01-OS1.1]
	[F20,F44-OS3.4]
	[F20,F44-OH1.1]
	[F20,F01-OP1.1]
(2)	[F44-OH1.1]
	[F01,F20-OP1.1]
	[F44-OS3.4]
	[F01,F20-OS1.1]
	[F20-OS2.3] Applies to the liners referred to in Sentence 9.21.3.3.(1), which are required to be not less than 15.9 mm thick.
<b>9.21.3.4. Firebrick Liners</b>	
(1)	[F20,F44-OS3.4]
	[F44-OH1.1]
	[F01-OS1.1]
	[F01-OP1.1]
(2)	[F20-OH1.1]
	[F20,F01-OS1.1]
	[F20-OS2.2]
	[F20,F44-OS3.4]
	[F01,F20-OP1.1]
<b>9.21.3.5. Concrete Liners</b>	
(1)	[F01,F20-OS1.1]
	[F44-OH1.1]
	[F20,F44-OS3.4]
	[F01-OP1.1]
	[F20-OS2.3]

Table 9.37.1.1. (Continued)

Functional Statements and Objectives <sup>(1)</sup>	
<b>9.21.3.6. Metal Liners</b>	
(1)	[F20,F44-OH1.1]
	[F01,F20-OP1.1]
	[F20,F44-OS3.4]
	[F20,F01-OS1.1]
	[F20-OS2.3]
(2)	[F44-OH1.1]
	[F20-OS2.3]
	[F20-OP1.1]
	[F20,F44-OS3.4]
	[F20,F01-OS1.1]
<b>9.21.3.7. Installation of Chimney Liners</b>	
(1)	[F44-OH1.1]
	[F01-OP1.1]
	[F44-OS3.4]
	[F01-OS1.1]
	[F20-OS2.3]
<b>9.21.3.8. Spaces between Liners and Surrounding Masonry</b>	
(1)	[F01-OP1.1]
	[F20-OS2.3]
	[F01-OS1.1]
(2)	[F20-OS1.1]
	[F44-OH1.1]
	[F44-OS3.4]
	[F01-OP1.1]
	[F20-OS2.3]
<b>9.21.3.9. Mortar for Chimney Liners</b>	
(1)	(b) [F20-OS2.3]
	(a),(b) [F01,F20-OP1.1]
	[F20,F44-OH1.1]
	[F20,F44-OS3.4]
	(a),(b) [F01,F20-OS1.1]
(2)	[F20,F01-OP1.1]
	[F20,F44-OH1.1]
	[F20-OS2.3]
	[F44-OS3.4]
	[F20,F01-OS1.1]
<b>9.21.3.10. Extension of Chimney Liners</b>	
(1)	[F20-OS2.3]
	[F44,F20-OH1.1]
	[F44-OS3.4]
	[F01-OS1.1]
	[F01-OP1.1]

Copyright © NRC 1941 - 2021 World Rights Reserved © CNRC 1941-2021 Droits réservés pour tous pays



**Table 9.37.1.1. (Continued)**

Functional Statements and Objectives <sup>(1)</sup>	
<b>9.21.4.4. Height of Chimney Flues</b>	
(1)	(a),(b) [F44-OH1.1]
	(a),(b) [F44-OS3.4]
<b>9.21.4.6. Chimney Caps</b>	
(1)	[F20-OS2.3]
	[F01-OS1.1]
	[F01-OP1.1]
	[F20,F44-OH1.1]
	[F44-OS3.4]
(2)	[F20-OS2.3]
(3)	[F20-OS2.3]
	[F20,F01-OS1.1]
	[F20,F01-OP1.1]
	[F20,F44-OS3.4]
(4)	[F20-OS2.3]
	[F20,F01-OS1.1]
	[F20,F01-OP1.1]
	[F20,F44-OH1.1]
	[F20,F44-OS3.4]
<b>9.21.4.7. Cleanout</b>	
(1)	[F01-OP1.1]
	[F01-OS1.1]
<b>9.21.4.8. Wall Thickness</b>	
(1)	[F20,F22-OS2.1]
	[F01-OP1.1]
	[F01-OS1.1]
	[F22-OP2.1]
<b>9.21.4.9. Separation of Flue Liners</b>	
(1)	[F20,F44-OH1.1]
	[F20,F01-OP1.1]
	[F20,F22-OS2.3]
	[F44-OS3.4]
	[F01-OS1.1]
(2)	[F20,F22-OS2.3]
	[F20,F44-OH1.1]
	[F20,F44-OS3.4]
	[F01-OS1.1]
<b>9.21.4.10. Flashing</b>	
(1)	[F20,F61-OS2.3]
<b>9.21.5.1. Clearance from Combustible Materials</b>	
(1)	(a),(b) [F01-OP1.1]
	(a),(b) [F01-OS1.1]

**Table 9.37.1.1. (Continued)**

Functional Statements and Objectives <sup>(1)</sup>	
(2)	[F01-OP1.1]
	[F01-OS1.1]
(3)	[F01-OP1.1]
	[F01-OS1.1]
<b>9.21.5.2. Sealing of Spaces</b>	
(1)	[F01-OP1.1]
	[F01-OS1.1]
<b>9.21.5.3. Support of Joists or Beams</b>	
(1)	[F01-OP1.1]
	[F01-OS1.1]
<b>9.22.1.2. Masonry and Concrete</b>	
(2)	[F22,F20-OS2.3]
<b>9.22.1.4. Combustion Air</b>	
(1)	[F01-OS1.1]
	[F01-OP1.1]
<b>9.22.2.1. Brick or Steel Liners</b>	
(1)	[F20,F01-OS1.1]
	[F20,F01-OP1.1]
<b>9.22.2.2. Firebrick Liners</b>	
(1)	(a),(b) [F01-OS1.1]
	(a),(b) [F01-OP1.1]
(2)	[F01-OS1.1]
	[F01-OP1.1]
(3)	[F01-OS1.1]
	[F01-OP1.1]
<b>9.22.2.3. Steel Liners</b>	
(1)	[F44-OH1.1]
	[F01-OS1.1]
	[F44-OS3.4]
	[F01-OP1.1]
<b>9.22.3.1. Thickness of Walls</b>	
(1)	[F01-OS1.1]
	[F01-OP1.1]
(2)	(a),(b) [F01-OS1.1]
	(a),(b) [F01-OP1.1]
<b>9.22.4.1. Fire Chamber Dimensions</b>	
(1)	[F44-OH1.1]
	[F44-OS3.4]
<b>9.22.5.1. Hearth Extension</b>	
(1)	[F01-OS1.1]
	[F01-OP1.1]
(2)	(a),(b) [F01-OS1.1]
	(a),(b) [F01-OP1.1]

Copyright © NRC 1941 - 2021 World Rights Reserved © CNRC 1941-2021 Droits réservés pour tous pays

Table 9.37.1.1. (Continued)

Functional Statements and Objectives <sup>(1)</sup>	
<b>9.22.5.2. Support of Hearth</b>	
(1)	[F01-OS1.1]
	[F20-OS2.3]
	[F20,F01-OP1.1]
(2)	[F01-OS1.1]
	[F01-OP1.1]
<b>9.22.6.1. Required Damper and Size</b>	
(1)	[F01-OS1.1]
	[F54-OH1.2]
	[F01-OP1.1]
<b>9.22.7.1. Slope of Smoke Chamber</b>	
(1)	[F44-OH1.1]
	[F44-OS3.4]
<b>9.22.7.2. Wall Thickness</b>	
(1)	[F01-OS1.1]
	[F01-OP1.1]
<b>9.22.8.1. Conformance to Standard</b>	
(1)	[F01-OS1.1]
	[F44-OH1.1]
	[F01-OP1.1]
	[F44-OS3.4]
<b>9.22.9.1. Clearance to the Fireplace Opening</b>	
(1)	[F01-OS1.1]
	[F01-OP1.1]
<b>9.22.9.2. Metal Exposed to the Interior</b>	
(1)	[F01-OS1.1]
	[F01-OP1.1]
<b>9.22.9.3. Clearance to Combustible Framing</b>	
(1)	[F01-OS1.1]
	[F01-OP1.1]
(2)	[F01-OS1.1]
	[F01-OP1.1]
<b>9.22.9.4. Heat-Circulating Duct Outlets</b>	
(1)	(a),(b) [F01-OS1.1]
	(a),(b) [F01-OP1.1]
<b>9.22.10.1. Appliance Standard</b>	
(1)	[F44-OH1.1]
	[F01-OS1.1]
	[F44-OS3.4]
	[F01-OP1.1]

Table 9.37.1.1. (Continued)

Functional Statements and Objectives <sup>(1)</sup>		
<b>9.22.10.2. Installation</b>		
(1)	[F01-OS1.1]	
	[F44-OH1.1]	
	[F01-OP1.1]	
	[F44-OS3.4]	
<b>9.23.2.1. Strength and Rigidity</b>		
(1)	[F20-OS2.1] [F20,F22-OS2.5] [F20,F22-OS2.3] Applies to elements that support or are part of an environmental separator.	
	[F20-OP2.1] [F20,F22-OP2.4,OP2.5] [F20,F22-OP2.3] Applies to elements that support or are part of an environmental separator.	
	[F22-OH4] Applies to floors and elements that support floors.	
	[F20,F22-OS1.2] Applies to assemblies required to provide fire resistance.	
	[F22-OS3.1] Applies to floors and elements that support floors. [F22-OS3.7] Applies to walls, and elements that support walls, that contain doors or windows required for emergency egress.	
	[F20,F22-OH1.1,OH1.2,OH1.3] Applies to elements that support or are part of an environmental separator.	
<b>9.23.2.2. Protection from Decay</b>		
(1)	[F80-OS2.3] [F80-OP2.3,OP2.4] [F80-OH1.1,OH1.2,OH1.3] Applies to elements that support or are part of an environmental separator. [F80-OS1.2] Applies to assemblies required to provide fire resistance. [F80-OH4] Applies to floors and elements that support floors. [F80-OS3.1] Applies to floors and elements that support floors. [F80-OS3.7] Applies to walls, and elements that support walls, that contain doors or windows required for emergency egress.	
	(2)	[F81-OS2.3] [F81-OP2.3] [F81-OH1.1,OH1.2,OH1.3] Applies to elements that support or are part of an environmental separator. [F81-OS1.2] Applies to assemblies required to provide fire resistance. [F81-OH4] Applies to floors and elements that support floors. [F81-OS3.1] Applies to floors and elements that support floors.

**Table 9.37.1.1. (Continued)**

Functional Statements and Objectives <sup>(1)</sup>	
<b>9.23.2.3. Protection from Dampness</b>	
(1)	[F80-OS2.1,OS2.3]
	[F80-OP2.1,OP2.3,OP2.4]
	[F80-OH1.1,OH1.2,OH1.3] Applies to elements that support or are part of an environmental separator.
	[F80-OS1.2] Applies to assemblies required to provide fire resistance.
	[F80-OH4] Applies to floors and elements that support floors.
[F80-OS3.1] Applies to floors and elements that support floors.	
<b>9.23.3.1. Standards for Nails and Screws</b>	
(1)	[F20-OS2.1] [F20,F22-OS2.5] [F20,F22-OS2.3] Applies to elements that support or are part of an environmental separator.
	[F20-OP2.1] [F20,F22-OP2.4,OP2.5] [F20,F22-OP2.3] Applies to elements that support or are part of an environmental separator.
	[F20,F22-OS1.2] Applies to assemblies required to provide fire resistance.
	[F20,F22-OH1.1,OH1.2,OH1.3] Applies to elements that support or are part of an environmental separator.
	[F22-OH4] Applies to floors and elements that support floors.
	[F22-OS3.1] Applies to floors and elements that support floors. [F22-OS3.7] Applies to walls, and elements that support walls, that contain doors or windows required for emergency egress.
(2)	[F20-OS2.1] [F20,F22-OS2.5] [F20,F22-OS2.3] Applies to elements that support or are part of an environmental separator.
	[F20-OP2.1] [F20,F22-OP2.4,OP2.5] [F20,F22-OP2.3] Applies to elements that support or are part of an environmental separator.
	[F20,F22-OS1.2] Applies to assemblies required to provide fire resistance.
	[F20,F22-OH1.1,OH1.2,OH1.3] Applies to elements that support or are part of an environmental separator.
	[F22-OH4] Applies to floors and elements that support floors.
	[F22-OS3.1] Applies to floors and elements that support floors. [F22-OS3.7] Applies to walls, and elements that support walls, that contain doors or windows required for emergency egress.

**Table 9.37.1.1. (Continued)**

Functional Statements and Objectives <sup>(1)</sup>	
(3)	[F20-OS2.1] [F20,F22-OS2.5] [F20,F22-OS2.3] Applies to elements that support or are part of an environmental separator.
	[F20-OP2.1,OP2.5] [F22-OP2.4,OP2.5] [F20,F22-OP2.3] Applies to elements that support or are part of an environmental separator.
	[F20,F22-OH1.1,OH1.2,OH1.3] Applies to elements that support or are part of an environmental separator.
	[F20,F22-OS1.2] Applies to assemblies required to provide fire resistance.
	[F22-OH4] Applies to floors and elements that support floors.
	[F22-OS3.1] Applies to floors and elements that support floors. [F22-OS3.7] Applies to walls, and elements that support walls, that contain doors or windows required for emergency egress.
	[F22-OS3.7] Applies to walls, and elements that support walls, that contain doors or windows required for emergency egress.
<b>9.23.3.2. Length of Nails</b>	
(1)	[F20-OS2.1] [F20,F22-OS2.5] [F20,F22-OS2.3] Applies to elements that support or are part of an environmental separator.
	[F20-OP2.1,OP2.5] [F22-OP2.4,OP2.5] [F20,F22-OP2.3] Applies to elements that support or are part of an environmental separator.
	[F20,F22-OH1.1,OH1.2,OH1.3] Applies to elements that support or are part of an environmental separator.
	[F20,F22-OS1.2] Applies to assemblies required to provide fire resistance.
	[F22-OH4] Applies to floors and elements that support floors.
	[F22-OS3.1] Applies to floors and elements that support floors. [F22-OS3.7] Applies to walls, and elements that support walls, that contain doors or windows required for emergency egress.
<b>9.23.3.3. Prevention of Splitting</b>	
(1)	[F80-OS2.1] [F80-OS2.3] Applies to elements that support or are part of an environmental separator.
	[F80-OP2.1,OP2.4] [F80-OP2.3] Applies to elements that support or are part of an environmental separator.
	[F80-OH1.1,OH1.2,OH1.3] Applies to elements that support or are part of an environmental separator.
	[F80-OS1.2] Applies to assemblies required to provide fire resistance.
	[F80-OH4] Applies to floors and elements that support floors.
	[F80-OS3.1] Applies to floors and elements that support floors.

Table 9.37.1.1. (Continued)

Functional Statements and Objectives <sup>(1)</sup>	
<b>9.23.3.4. Nailing of Framing</b>	
(1)	[F20-OS2.1] [F20,F22-OS2.5] [F20,F22-OS2.3] Applies to elements that support or are part of an environmental separator.
	[F20-OP2.1,OP2.5] [F22-OP2.4,OP2.5] [F20,F22-OP2.3] Applies to elements that support or are part of an environmental separator.
	[F20,F22-OH1.1,OH1.2,OH1.3] Applies to elements that support or are part of an environmental separator.
	[F22-OH4] Applies to floors and elements that support floors.
	[F20,F22-OS1.2] Applies to assemblies required to provide fire resistance.
	[F22-OS3.1] Applies to floors and elements that support floors. [F22-OS3.7] Applies to walls, and elements that support walls, that contain doors or windows required for emergency egress.
(2)	[F20-OS2.1] [F20,F22-OS2.5] [F20,F22-OS2.3] Applies to elements that support or are part of an environmental separator.
	[F20-OP2.1,OP2.5] [F22-OP2.4,OP2.5] [F20,F22-OP2.3] Applies to elements that support or are part of an environmental separator.
	[F20,F22-OH1.1,OH1.2,OH1.3] Applies to elements that support or are part of an environmental separator.
	[F20,F22-OS1.2] Applies to assemblies required to provide fire resistance.
	[F22-OH4] Applies to floors and elements that support floors.
	[F22-OS3.1] Applies to floors and elements that support floors. [F22-OS3.7] Applies to walls, and elements that support walls, that contain doors or windows required for emergency egress.
(3)	[F20-OS2.1] [F20,F22-OS2.3] [F20,F22-OS2.5] [F20-OP2.1,OP2.5] [F20,F22-OP2.3] [F22-OP2.4,OP2.5] [F20,F22-OH1.1,OH1.2,OH1.3] [F20,F22-OS1.2] Applies to assemblies required to provide fire resistance.
(4)	[F20-OS2.1] [F20,F22-OS2.3] [F20,F22-OS2.5] [F20-OP2.1,OP2.5] [F20,F22-OP2.3] [F22-OP2.4,OP2.5] [F20,F22-OH1.1,OH1.2,OH1.3] [F20,F22-OS1.2] Applies to assemblies required to provide fire resistance.

Table 9.37.1.1. (Continued)

Functional Statements and Objectives <sup>(1)</sup>	
<b>9.23.3.5. Fasteners for Sheathing or Subflooring</b>	
(1)	[F22-OH4] Applies to floors and elements that support floors. [F20,F22-OS1.2] Applies to assemblies required to provide fire resistance.
	[F22-OS3.1] Applies to floors and elements that support floors. [F22-OS3.7] Applies to walls, and elements that support walls, that contain doors or windows required for emergency egress.
	[F20-OS2.1] [F20,F22-OS2.5] [F20,F22-OS2.3] Applies to elements that support or are part of an environmental separator.
	[F20-OP2.1,OP2.5] [F22-OP2.4,OP2.5] [F20,F22-OP2.3] Applies to elements that support or are part of an environmental separator.
	[F20,F22-OH1.1,OH1.2,OH1.3] Applies to elements that support or are part of an environmental separator.
(2)	[F22-OH4] Applies to floors and elements that support floors. [F22-OS3.1] Applies to floors and elements that support floors. [F22-OS3.7] Applies to walls, and elements that support walls, that contain doors or windows required for emergency egress.
	[F20-OS2.1] [F20,F22-OS2.5] [F20,F22-OS2.3] Applies to elements that support or are part of an environmental separator.
	[F20-OP2.1,OP2.5] [F22-OP2.4,OP2.5] [F20,F22-OP2.3] Applies to elements that support or are part of an environmental separator.
	[F20,F22-OH1.1,OH1.2,OH1.3] Applies to elements that support or are part of an environmental separator.
(3)	[F22-OH4] Applies to floors and elements that support floors. [F22-OS3.1] Applies to floors and elements that support floors. [F22-OS3.7] Applies to walls, and elements that support walls, that contain doors or windows required for emergency egress.
	[F20-OS2.1] [F20,F22-OS2.5] [F20,F22-OS2.3] Applies to elements that support or are part of an environmental separator.
	[F20-OP2.1,OP2.5] [F22-OP2.4,OP2.5] [F20,F22-OP2.3] Applies to elements that support or are part of an environmental separator.
	[F20,F22-OH1.1,OH1.2,OH1.3] Applies to elements that support or are part of an environmental separator.

**Table 9.37.1.1. (Continued)**

Functional Statements and Objectives <sup>(1)</sup>	
(5)	[F20-OS2.1] [F20,F22-OS2.5] [F20,F22-OS2.3] Applies to elements that support or are part of an environmental separator.
	[F20-OP2.1,OP2.5] [F22-OP2.4,OP2.5] [F20,F22-OP2.3] Applies to elements that support or are part of an environmental separator.
	[F20,F22-OH1.1,OH1.2,OH1.3] Applies to elements that support or are part of an environmental separator.
	[F22-OH4] Applies to floors and elements that support floors.
	[F20,F22-OS1.2] Applies to assemblies required to provide fire resistance.
	[F22-OS3.1] Applies to floors and elements that support floors. [F22-OS3.7] Applies to walls, and elements that support walls, that contain doors or windows required for emergency egress.
	(6)
[F20-OP2.1,OP2.5] [F22-OP2.4,OP2.5] [F20,F22-OP2.3] Applies to elements that support or are part of an environmental separator.	
[F20,F22-OH1.1,OH1.2,OH1.3] Applies to elements that support or are part of an environmental separator.	
[F22-OH4] Applies to floors and elements that support floors.	
[F20,F22-OS1.2] Applies to assemblies required to provide fire resistance.	
[F22-OS3.1] Applies to floors and elements that support floors. [F22-OS3.7] Applies to walls, and elements that support walls, that contain doors or windows required for emergency egress.	
(7)	
	[F20-OP2.1] [F22-OP2.4]
	[F22-OH4] Applies to floors and elements that support floors.
	[F22-OS3.1] Applies to floors and elements that support floors.
	[F20-OS1.2] Applies to assemblies required to provide fire resistance.
(8)	[F20-OS2.1] [F20,F22-OS2.5] [F20,F22-OS2.3] Applies to elements that support or are part of an environmental separator.
	[F20-OP2.1,OP2.5] [F22-OP2.4,OP2.5] [F20,F22-OP2.3] Applies to elements that support or are part of an environmental separator.
	[F20,F22-OH1.1,OH1.2,OH1.3] Applies to elements that support or are part of an environmental separator.

**Table 9.37.1.1. (Continued)**

Functional Statements and Objectives <sup>(1)</sup>		
<b>9.23.4.2. Spans for Joists, Rafters and Beams</b>		
(1)	[F20-OS2.1,OS2.5] [F22-OS2.4,OS2.5] [F20,F22-OS2.3] Applies to elements that support or are part of an environmental separator.	
	[F20-OP2.1,OP2.5] [F22-OP2.4,OP2.5] [F20,F22-OP2.3] Applies to elements that support or are part of an environmental separator.	
	[F20,F22-OH1.1,OH1.2,OH1.3] Applies to elements that support or are part of an environmental separator.	
	[F22-OH4] Applies to floors and elements that support floors.	
	[F20,F22-OS1.2] Applies to assemblies required to provide fire resistance.	
	[F22-OS3.1] Applies to floors and elements that support floors. [F22-OS3.7] Applies to walls, and elements that support walls, that contain doors or windows required for emergency egress.	
	(2)	[F20-OS2.1,OS2.5] [F22-OS2.4,OS2.5] [F20,F22-OS2.3] Applies to elements that support or are part of an environmental separator.
		[F20-OP2.1,OP2.5] [F22-OP2.4,OP2.5] [F20,F22-OP2.3] Applies to elements that support or are part of an environmental separator.
		[F20,F22-OH1.1,OH1.2,OH1.3] Applies to elements that support or are part of an environmental separator.
		[F22-OH4] Applies to floors and elements that support floors.
[F20,F22-OS1.2] Applies to assemblies required to provide fire resistance.		
[F22-OS3.1] Applies to floors and elements that support floors. [F22-OS3.7] Applies to walls, and elements that support walls, that contain doors or windows required for emergency egress.		
(3)		[F20-OS2.1,OS2.3,OS2.5]
	[F20-OP2.1,OP2.3,OP2.5]	
(4)	[F20-OS2.1,OS2.3,OS2.5]	
	[F20-OP2.1,OP2.3,OP2.5]	

Table 9.37.1.1. (Continued)

Table 9.37.1.1. (Continued)

Functional Statements and Objectives <sup>(1)</sup>	
<b>9.23.4.3. Steel Beams</b>	
(1)	[F20-OS2.1,OS2.5] [F22-OS2.4,OS2.5] [F20,F22-OS2.3] Applies to elements that support or are part of an environmental separator.
	[F20-OP2.1,OP2.5] [F22-OP2.4,OP2.5] [F20,F22-OP2.3] Applies to elements that support or are part of an environmental separator.
	[F20,F22-OH1.1,OH1.2,OH1.3] Applies to elements that support or are part of an environmental separator.
	[F20,F22-OS1.2] Applies to assemblies required to provide fire resistance.
	[F22-OS3.1] Applies to floors and elements that support floors. [F22-OS3.7] Applies to walls, and elements that support walls, that contain doors or windows required for emergency egress.
	[F22-OH4] Applies to floors and elements that support floors.
(2)	[F20-OS2.1,OS2.5] [F22-OS2.4,OS2.5] [F20,F22-OS2.3] Applies to elements that support or are part of an environmental separator.
	[F20-OP2.1,OP2.5] [F22-OP2.4,OP2.5] [F20,F22-OP2.3] Applies to elements that support or are part of an environmental separator.
	[F20,F22-OH1.1,OH1.2,OH1.3] Applies to elements that support or are part of an environmental separator.
	[F20,F22-OS1.2] Applies to assemblies required to provide fire resistance.
	[F22-OS3.1] Applies to floors and elements that support floors. [F22-OS3.7] Applies to walls, and elements that support walls, that contain doors or windows required for emergency egress.
	[F22-OH4] Applies to floors and elements that support floors.
<b>9.23.4.4. Concrete Topping</b>	
(1)	[F20-OS2.1,OS2.5] [F22-OS2.4,OS2.5] [F20,F22-OS2.3] Applies to elements that support or are part of an environmental separator.
	[F20-OP2.1,OP2.5] [F22-OP2.4,OP2.5] [F20,F22-OP2.3] Applies to elements that support or are part of an environmental separator.
	[F22-OH4] Applies to floors and elements that support floors.
	[F20,F22-OH1.1,OH1.2,OH1.3] Applies to elements that support or are part of an environmental separator.
	[F20,F22-OS1.2] Applies to assemblies required to provide fire resistance.
	[F22-OS3.1] Applies to floors and elements that support floors. [F22-OS3.7] Applies to walls, and elements that support walls, that contain doors or windows required for emergency egress.

Functional Statements and Objectives <sup>(1)</sup>	
(2)	[F20-OS2.1,OS2.5] [F22-OS2.4,OS2.5] [F20,F22-OS2.3] Applies to elements that support or are part of an environmental separator.
	[F20-OP2.1,OP2.5] [F22-OP2.4,OP2.5] [F20,F22-OP2.3] Applies to elements that support or are part of an environmental separator.
	[F20,F22-OH1.1,OH1.2,OH1.3] Applies to elements that support or are part of an environmental separator.
	[F22-OH4] Applies to floors and elements that support floors.
	[F20,F22-OS1.2] Applies to assemblies required to provide fire resistance.
	[F22-OS3.1] Applies to floors and elements that support floors. [F22-OS3.7] Applies to walls, and elements that support walls, that contain doors or windows required for emergency egress.
(3)	[F20-OS2.1,OS2.5] [F22-OS2.4,OS2.5] [F20,F22-OS2.3] Applies to elements that support or are part of an environmental separator.
	[F20-OP2.1,OP2.5] [F22-OP2.4,OP2.5] [F20,F22-OP2.3] Applies to elements that support or are part of an environmental separator.
	[F20,F22-OH1.1,OH1.2,OH1.3] Applies to elements that support or are part of an environmental separator.
	[F20,F22-OS1.2] Applies to assemblies required to provide fire resistance.
	[F20,F22-OH4] Applies to floors and elements that support floors.
	[F22-OS3.1] Applies to floors and elements that support floors. [F22-OS3.7] Applies to elements that support walls that contain doors or windows required for emergency egress.
<b>9.23.4.5. Heavy Roofing Materials</b>	
(1)	[F20-OS2.1,OS2.5] [F22-OS2.4,OS2.5] [F20,F22-OS2.3] Applies to elements that support or are part of an environmental separator.
	[F20-OP2.1,OP2.5] [F22-OP2.4,OP2.5] [F20,F22-OP2.3] Applies to elements that support or are part of an environmental separator.
	[F20,F22-OH1.1,OH1.2,OH1.3] Applies to elements that support or are part of an environmental separator.
	[F20,F22-OS1.2] Applies to assemblies required to provide fire resistance.
	[F22-OS3.1] Applies to floors and elements that support floors. [F22-OS3.7] Applies to walls, and elements that support walls, that contain doors or windows required for emergency egress.

**Table 9.37.1.1. (Continued)**

Functional Statements and Objectives <sup>(1)</sup>	
<b>9.23.5.1. Holes Drilled in Framing Members</b>	
(1)	[F20-OS2.1,OS2.5] [F22-OS2.5] [F20,F22-OS2.3] Applies to elements that support or are part of an environmental separator.
	[F20-OP2.1,OP2.5] [F22-OP2.4,OP2.5] [F20,F22-OP2.3] Applies to elements that support or are part of an environmental separator.
	[F20,F22-OH1.1,OH1.2,OH1.3] Applies to elements that support or are part of an environmental separator.
	[F20,F22-OS1.2] Applies to assemblies required to provide fire resistance.
	[F22-OS3.1] Applies to floors and elements that support floors. [F22-OS3.7] Applies to walls, and elements that support walls, that contain doors or windows required for emergency egress.
	[F22-OH4] Applies to floors and elements that support floors.
<b>9.23.5.2. Notching of Framing Members</b>	
(1)	[F20-OS2.1,OS2.5] [F22-OS2.5] [F20,F22-OS2.3] Applies to elements that support or are part of an environmental separator.
	[F20-OP2.1,OP2.5] [F22-OP2.4,OP2.5] [F20,F22-OP2.3] Applies to elements that support or are part of an environmental separator.
	[F20,F22-OH1.1,OH1.2,OH1.3] Applies to elements that support or are part of an environmental separator.
	[F20,F22-OS1.2] Applies to assemblies required to provide fire resistance.
	[F22-OS3.1] Applies to floors and elements that support floors. [F22-OS3.7] Applies to walls, and elements that support walls, that contain doors or windows required for emergency egress.
	[F22-OH4] Applies to floors and elements that support floors.
<b>9.23.5.3. Wall Studs</b>	
(1)	[F20-OS2.1,OS2.5] [F22-OS2.5] [F20,F22-OS2.3] Applies to elements that support or are part of an environmental separator.
	[F20-OP2.1,OP2.5] [F22-OP2.4,OP2.5] [F20,F22-OP2.3] Applies to elements that support or are part of an environmental separator.
	[F20,F22-OH1.1,OH1.2,OH1.3] Applies to elements that support or are part of an environmental separator.
	[F22-OH4] Applies to floors and elements that support floors.
	[F20,F22-OS1.2] Applies to assemblies required to provide fire resistance.
	[F22-OS3.1] Applies to floors and elements that support floors. [F22-OS3.7] Applies to walls, and elements that support walls, that contain doors or windows required for emergency egress.

**Table 9.37.1.1. (Continued)**

Functional Statements and Objectives <sup>(1)</sup>	
<b>9.23.5.4. Top Plates</b>	
(1)	[F20-OS2.1,OS2.5] [F22-OS2.5] [F20,F22-OS2.3] Applies to elements that support or are part of an environmental separator.
	[F20-OP2.1,OP2.5] [F22-OP2.4,OP2.5] [F20,F22-OP2.3] Applies to elements that support or are part of an environmental separator.
	[F20,F22-OH1.1,OH1.2,OH1.3] Applies to elements that support or are part of an environmental separator.
	[F22-OH4] Applies to floors and elements that support floors.
	[F20,F22-OS1.2] Applies to assemblies required to provide fire resistance.
	[F22-OS3.1] Applies to floors and elements that support floors. [F22-OS3.7] Applies to walls, and elements that support walls, that contain doors or windows required for emergency egress.
<b>9.23.5.5. Roof Trusses</b>	
(1)	[F20-OS2.1,OS2.5] [F22-OS2.5] [F20,F22-OS2.3] Applies to elements that support or are part of an environmental separator.
	[F20-OP2.1,OP2.5] [F22-OP2.4,OP2.5] [F20,F22-OP2.3] Applies to elements that support or are part of an environmental separator.
	[F20,F22-OH1.1,OH1.2,OH1.3] Applies to elements that support or are part of an environmental separator.
	[F20,F22-OS1.2] Applies to assemblies required to provide fire resistance.
<b>9.23.6.1. Anchorage of Building Frames</b>	
(1)	[F20-OS2.1,OS2.5] [F22-OS2.5] [F20,F22-OS2.3] Applies to elements that support or are part of an environmental separator.
	[F20-OP2.1,OP2.5] [F22-OP2.4,OP2.5] [F20,F22-OP2.3] Applies to elements that support or are part of an environmental separator.
	[F20-OH1.1,OH1.2,OH1.3] Applies to elements that support or are part of an environmental separator.
	[F22-OH4] Applies to floors and elements that support floors.
	[F20-OS3.1] Applies to floors and elements that support floors.

Table 9.37.1.1. (Continued)

Functional Statements and Objectives <sup>(1)</sup>	
(2)	[F20-OS2.1,OS2.5] [F22-OS2.5] [F20,F22-OS2.3] Applies to elements that support or are part of an environmental separator.
	[F20-OP2.1,OP2.5] [F22-OP2.4,OP2.5] [F20,F22-OP2.3] Applies to elements that support or are part of an environmental separator.
	[F20-OH1.1,OH1.2,OH1.3] Applies to elements that support or are part of an environmental separator.
	[F22-OH4] Applies to floors and elements that support floors.
	[F20-OS3.1] Applies to floors and elements that support floors.
(3)	[F20-OS2.1,OS2.5] [F22-OS2.5] [F20,F22-OS2.3] Applies to elements that support or are part of an environmental separator.
	[F20-OP2.1,OP2.5] [F22-OP2.4,OP2.5] [F20,F22-OP2.3] Applies to elements that support or are part of an environmental separator.
	[F20-OH1.1,OH1.2,OH1.3] Applies to elements that support or are part of an environmental separator.
	[F22-OH4] Applies to floors and elements that support floors.
	[F20-OS3.1] Applies to floors and elements that support floors.
(4)	[F20-OS2.1,OS2.5] [F22-OS2.5] [F20,F22-OS2.3] Applies to elements that support or are part of an environmental separator.
	[F20-OP2.1,OP2.5] [F22-OP2.4,OP2.5] [F20,F22-OP2.3] Applies to elements that support or are part of an environmental separator.
	[F20-OH1.1,OH1.2,OH1.3] Applies to elements that support or are part of an environmental separator.
	[F22-OH4] Applies to floors and elements that support floors.
	[F20-OS3.1] Applies to floors and elements that support floors.
(5)	[F20-OS2.1,OS2.5] [F22-OS2.5] [F20,F22-OS2.3] Applies to elements that support or are part of an environmental separator.
	[F20-OP2.1,OP2.5] [F22-OP2.4,OP2.5] [F20,F22-OP2.3] Applies to elements that support or are part of an environmental separator.
	[F20-OH1.1,OH1.2,OH1.3] Applies to elements that support or are part of an environmental separator.
	[F22-OH4] Applies to floors and elements that support floors.
	[F20,F22-OS3.1] Applies to floors and elements that support floors.

Table 9.37.1.1. (Continued)

Functional Statements and Objectives <sup>(1)</sup>	
(6)	[F20-OS2.1,OS2.5] [F22-OS2.5] [F20,F22-OS2.3] Applies to elements that support or are part of an environmental separator.
	[F20-OP2.1,OP2.5] [F22-OP2.4,OP2.5] [F20,F22-OP2.3] Applies to elements that support or are part of an environmental separator.
	[F20-OH1.1,OH1.2,OH1.3] Applies to elements that support or are part of an environmental separator.
	[F22-OH4] Applies to floors and elements that support floors.
	[F20-OS3.1] Applies to floors and elements that support floors.
<b>9.23.6.2. Anchorage of Columns and Posts</b>	
(1)	[F22-OS2.4,OS2.5] [F22-OS2.3] Applies to elements that support or are part of an environmental separator.
	[F22-OP2.4,OP2.5] [F22-OP2.3] Applies to elements that support or are part of an environmental separator.
	[F22-OH1.1,OH1.2,OH1.3] Applies to elements that support or are part of an environmental separator.
	[F22-OH4] Applies to floors and elements that support floors.
	[F22-OS3.1] Applies to floors and elements that support floors. [F22-OS3.7] Applies to walls, and elements that support walls, that contain doors or windows required for emergency egress.
(2)	[F22-OS2.4,OS2.5] [F22-OS2.3] Applies to elements that support or are part of an environmental separator.
	[F22-OP2.4,OP2.5] [F22-OP2.3] Applies to elements that support or are part of an environmental separator.
	[F22-OH4] Applies to floors and elements that support floors.
	[F22-OS3.1] Applies to floors and elements that support floors.
	[F22-OH1.1,OH1.2,OH1.3] Applies to elements that support or are part of an environmental separator.
<b>9.23.6.3. Anchorage of Smaller Buildings</b>	
(1)	[F22-OS2.3,OS2.5]
<b>9.23.7.1. Size of Sill Plates</b>	
(1)	[F20-OS2.1,OS2.5] [F22-OS2.5] [F20,F22-OS2.3] Applies to elements that support or are part of an environmental separator.
	[F20-OP2.1,OP2.5] [F22-OP2.4,OP2.5] [F20,F22-OP2.3] Applies to elements that support or are part of an environmental separator.
	[F20,F22-OH1.1,OH1.2,OH1.3] Applies to elements that support or are part of an environmental separator.
	[F22-OH4] Applies to floors and elements that support floors.
	[F22-OS3.1] Applies to floors and elements that support floors. [F22-OS3.7] Applies to walls, and elements that support walls, that contain doors or windows required for emergency egress.
	[F22-OS1.2] Applies to assemblies required to provide fire resistance.



**Table 9.37.1.1. (Continued)**

Functional Statements and Objectives <sup>(1)</sup>	
<b>9.23.7.2. Levelling and Sealing of Sill Plates</b>	
(1)	[F20-OS2.1,OS2.5] [F22-OS2.4,OS2.5] [F20,F22-OS2.3] Applies to elements that support or are part of an environmental separator.
	[F20-OP2.1,OP2.5] [F22-OP2.4,OP2.5] [F20,F22-OP2.3] Applies to elements that support or are part of an environmental separator.
	[F20,F22-OH1.1,OH1.2,OH1.3] Applies to elements that support or are part of an environmental separator.
	[F20,F22-OH4] Applies to floors and elements that support floors.
	[F20,F22-OS3.1] Applies to floors and elements that support floors.
<b>9.23.8.1. Bearing for Beams</b>	
(1)	[F20-OS2.1,OS2.5] [F22-OS2.5] [F20,F22-OS2.3] Applies to elements that support or are part of an environmental separator.
	[F20-OP2.1,OP2.5] [F22-OP2.5] [F20,F22-OP2.3] Applies to elements that support or are part of an environmental separator.
	[F20,F22-OH1.1,OH1.2,OH1.3] Applies to elements that support or are part of an environmental separator.
	[F20,F22-OH4] Applies to floors and elements that support floors.
	[F20,F22-OS3.1] Applies to floors and elements that support floors.
	[F20,F22-OS3.7] Applies to walls, and elements that support walls, that contain doors or windows required for emergency egress.
	[F20,F22-OS1.2] Applies to assemblies required to provide fire resistance.
<b>9.23.8.2. Priming of Steel Beams</b>	
(1)	[F80-OS2.1] [F80-OS2.3] Applies to elements that support or are part of an environmental separator.
	[F80-OP2.1,OP2.4] [F80-OP2.3] Applies to elements that support or are part of an environmental separator.
	[F80-OH1.1,OH1.2,OH1.3] Applies to elements that support or are part of an environmental separator.
	[F80-OS1.2] Applies to assemblies required to provide fire resistance.
	[F80-OS3.1] Applies to floors and elements that support floors.
	[F80-OH4] Applies to floors and elements that support floors.
<b>9.23.8.3. Built-up Wood Beams</b>	
(1)	[F20-OS2.1] [F20-OP2.1]

**Table 9.37.1.1. (Continued)**

Functional Statements and Objectives <sup>(1)</sup>	
(2)	[F20-OS2.1] [F20-OP2.1]
(3)	[F20-OS2.1] [F20-OP2.1]
(4)	[F20-OS2.1] [F20-OP2.1]
(5)	[F20-OS2.1] [F20-OP2.1]
(6)	[F20-OS2.1] [F20-OP2.1]
(7)	[F20-OS2.1] [F20-OP2.1]
(8)	[F20-OS2.1] [F20-OP2.1]
<b>9.23.9.1. End Bearing for Joists</b>	
(1)	[F20-OS2.1,OS2.5] [F22-OS2.5] [F20,F22-OS2.3] Applies to elements that support or are part of an environmental separator.
	[F20-OP2.1,OP2.5] [F22-OP2.4,OP2.5] [F20,F22-OP2.3] Applies to elements that support or are part of an environmental separator.
	[F20,F22-OH1.1,OH1.2,OH1.3] Applies to elements that support or are part of an environmental separator.
	[F22-OH4]
	[F20,F22-OS1.2] Applies to assemblies required to provide fire resistance.
	[F22-OS3.1]
(2)	[F20,F22-OS1.2] Applies to assemblies required to provide fire resistance. [F22-OS3.1] [F20-OP2.1,OP2.5] [F22-OP2.4,OP2.5] [F20,F22-OP2.3] Applies to elements that support or are part of an environmental separator. [F22-OH4] [F20,F22-OH1.1,OH1.2,OH1.3] Applies to elements that support or are part of an environmental separator. [F20-OS2.1,OS2.5] [F22-OS2.5] [F20,F22-OS2.3] Applies to elements that support or are part of an environmental separator.

Table 9.37.1.1. (Continued)

Functional Statements and Objectives <sup>(1)</sup>	
<b>9.23.9.2. Joists Supported by Beams</b>	
(1)	[F20-OS2.1,OS2.5] [F22-OS2.5] [F20,F22-OS2.3] Applies to elements that support or are part of an environmental separator.
	[F20-OP2.1,OP2.5] [F22-OP2.4,OP2.5] [F20,F22-OP2.3] Applies to elements that support or are part of an environmental separator.
	[F20,F22-OH1.1,OH1.2,OH1.3] Applies to elements that support or are part of an environmental separator.
	[F22-OH4]
	[F20,F22-OS1.2] Applies to assemblies required to provide fire resistance.
	[F22-OS3.1] [F22-OS3.7] Applies to walls, and elements that support walls, that contain doors or windows required for emergency egress.
	(2)
[F20-OP2.1,OP2.5] [F22-OP2.4,OP2.5] [F20,F22-OP2.3] Applies to elements that support or are part of an environmental separator.	
[F20,F22-OH1.1,OH1.2,OH1.3] Applies to elements that support or are part of an environmental separator.	
[F22-OH4]	
[F20,F22-OS1.2] Applies to assemblies required to provide fire resistance.	
[F22-OS3.1] [F22-OS3.7] Applies to walls, and elements that support walls, that contain doors or windows required for emergency egress.	
(3)	
	[F20-OP2.1,OP2.5] [F22-OP2.4,OP2.5] [F20,F22-OP2.3] Applies to elements that support or are part of an environmental separator.
	[F20,F22-OH1.1,OH1.2,OH1.3] Applies to elements that support or are part of an environmental separator.
	[F22-OH4]
	[F20,F22-OS1.2] Applies to assemblies required to provide fire resistance.
	[F22-OS3.1] [F22-OS3.7] Applies to walls, and elements that support walls, that contain doors or windows required for emergency egress.

Table 9.37.1.1. (Continued)

Functional Statements and Objectives <sup>(1)</sup>	
(4)	[F20-OS2.1,OS2.5] [F22-OS2.5] [F20,F22-OS2.3] Applies to elements that support or are part of an environmental separator.
	[F20-OP2.1,OP2.5] [F22-OP2.4,OP2.5] [F20,F22-OP2.3] Applies to elements that support or are part of an environmental separator.
	[F20,F22-OH1.1,OH1.2,OH1.3] Applies to elements that support or are part of an environmental separator.
	[F22-OH4]
	[F20,F22-OS1.2] Applies to assemblies required to provide fire resistance.
	[F22-OS3.1] [F22-OS3.7] Applies to walls, and elements that support walls, that contain doors or windows required for emergency egress.
	(5)
[F20-OP2.1,OP2.5] [F22-OP2.4,OP2.5] [F20,F22-OP2.3] Applies to elements that support or are part of an environmental separator.	
[F20,F22-OH1.1,OH1.2,OH1.3] Applies to elements that support or are part of an environmental separator.	
[F22-OH4]	
[F20,F22-OS1.2] Applies to assemblies required to provide fire resistance.	
[F22-OS3.1] [F22-OS3.7] Applies to walls, and elements that support walls, that contain doors or windows required for emergency egress.	
<b>9.23.9.3. Restraint of Joist Bottoms</b>	
(1)	[F20-OS2.1,OS2.5] [F22-OS2.5] [F20,F22-OS2.3] Applies to elements that support or are part of an environmental separator.
	[F20-OP2.1,OP2.5] [F22-OP2.4,OP2.5] [F20,F22-OP2.3] Applies to elements that support or are part of an environmental separator.
	[F20,F22-OH1.1,OH1.2,OH1.3] Applies to elements that support or are part of an environmental separator.
	[F22-OH4]
	[F20,F22-OS1.2] Applies to assemblies required to provide fire resistance.
	[F22-OS3.1] [F22-OS3.7] Applies to walls, and elements that support walls, that contain doors or windows required for emergency egress.

**Table 9.37.1.1. (Continued)**

Functional Statements and Objectives <sup>(1)</sup>	
<b>9.23.9.4. Strapping, Bridging, Furring and Ceilings in Span Tables 9.23.4.2.-A and -B</b>	
(1)	[F20-OS2.1,OS2.5] [F22-OS2.5] [F20,F22-OS2.3] Applies to elements that support or are part of an environmental separator.
	[F20-OP2.1,OP2.5] [F22-OP2.4,OP2.5] [F20,F22-OP2.3] Applies to elements that support or are part of an environmental separator.
	[F20,F22-OH1.1,OH1.2,OH1.3] Applies to elements that support or are part of an environmental separator.
	[F22-OH4]
	[F20,F22-OS1.2] Applies to assemblies required to provide fire resistance.
	[F22-OS3.1] [F22-OS3.7] Applies to walls, and elements that support walls, that contain doors or windows required for emergency egress.
(2)	[F20-OS2.1,OS2.5] [F22-OS2.5] [F20,F22-OS2.3] Applies to elements that support or are part of an environmental separator.
	[F20-OP2.1,OP2.5] [F22-OP2.4,OP2.5] [F20,F22-OP2.3] Applies to elements that support or are part of an environmental separator.
	[F20,F22-OH1.1,OH1.2,OH1.3] Applies to elements that support or are part of an environmental separator.
	[F22-OH4]
	[F20,F22-OS1.2] Applies to assemblies required to provide fire resistance.
	[F22-OS3.1] [F22-OS3.7] Applies to walls, and elements that support walls, that contain doors or windows required for emergency egress.
(3)	[F20-OS2.1,OS2.5] [F22-OS2.5] [F20,F22-OS2.3] Applies to elements that support or are part of an environmental separator.
	[F20-OP2.1,OP2.5] [F22-OP2.4,OP2.5] [F20,F22-OP2.3] Applies to elements that support or are part of an environmental separator.
	[F20,F22-OH1.1,OH1.2,OH1.3] Applies to elements that support or are part of an environmental separator.
	[F22-OH4]
	[F20,F22-OS1.2] Applies to assemblies required to provide fire resistance.
	[F22-OS3.1] [F22-OS3.7] Applies to walls, and elements that support walls, that contain doors or windows required for emergency egress.

**Table 9.37.1.1. (Continued)**

Functional Statements and Objectives <sup>(1)</sup>	
(4)	[F20-OS2.1,OS2.5] [F22-OS2.5] [F20,F22-OS2.3] Applies to elements that support or are part of an environmental separator.
	[F20-OP2.1,OP2.5] [F22-OP2.4,OP2.5] [F20,F22-OP2.3] Applies to elements that support or are part of an environmental separator.
	[F20,F22-OH1.1,OH1.2,OH1.3] Applies to elements that support or are part of an environmental separator.
	[F22-OH4]
	[F20,F22-OS1.2] Applies to assemblies required to provide fire resistance.
	[F22-OS3.1] [F22-OS3.7] Applies to walls, and elements that support walls, that contain doors or windows required for emergency egress.
(5)	[F20-OS2.1,OS2.5] [F22-OS2.5] [F20,F22-OS2.3] Applies to elements that support or are part of an environmental separator.
	[F20-OP2.1,OP2.5] [F22-OP2.4,OP2.5] [F20,F22-OP2.3] Applies to elements that support or are part of an environmental separator.
	[F20,F22-OH1.1,OH1.2,OH1.3] Applies to elements that support or are part of an environmental separator.
	[F22-OH4]
	[F20,F22-OS1.2] Applies to assemblies required to provide fire resistance.
	[F22-OS3.1] [F22-OS3.7] Applies to walls, and elements that support walls, that contain doors or windows required for emergency egress.
(6)	[F20-OS2.1,OS2.5] [F22-OS2.5] [F20,F22-OS2.3] Applies to elements that support or are part of an environmental separator.
	[F20-OP2.1,OP2.5] [F22-OP2.4,OP2.5] [F20,F22-OP2.3] Applies to elements that support or are part of an environmental separator.
	[F20,F22-OH1.1,OH1.2,OH1.3] Applies to elements that support or are part of an environmental separator.
	[F22-OH4]
	[F20,F22-OS1.2] Applies to assemblies required to provide fire resistance.
	[F22-OS3.1] [F22-OS3.7] Applies to walls, and elements that support walls, that contain doors or windows required for emergency egress.

Table 9.37.1.1. (Continued)

Table 9.37.1.1. (Continued)

Functional Statements and Objectives <sup>(1)</sup>	
<b>9.23.9.5. Header Joists</b>	
(1)	[F20-OS2.1,OS2.5] [F22-OS2.5] [F20,F22-OS2.3] Applies to elements that support or are part of an environmental separator.
	[F20-OP2.1,OP2.5] [F22-OP2.4,OP2.5] [F20,F22-OP2.3] Applies to elements that support or are part of an environmental separator.
	[F20,F22-OH1.1,OH1.2,OH1.3] Applies to elements that support or are part of an environmental separator.
	[F22-OH4]
	[F20,F22-OS1.2] Applies to assemblies required to provide fire resistance.
	[F22-OS3.1] [F22-OS3.7] Applies to walls, and elements that support walls, that contain doors or windows required for emergency egress.
<b>9.23.9.6. Trimmer Joists</b>	
(1)	[F20-OS2.1,OS2.5] [F22-OS2.5] [F20,F22-OS2.3] Applies to elements that support or are part of an environmental separator.
	[F20-OP2.1,OP2.5] [F22-OP2.4,OP2.5] [F20,F22-OP2.3] Applies to elements that support or are part of an environmental separator.
	[F20,F22-OH1.1,OH1.2,OH1.3] Applies to elements that support or are part of an environmental separator.
	[F22-OH4]
	[F20,F22-OS1.2] Applies to assemblies required to provide fire resistance.
	[F22-OS3.1] [F22-OS3.7] Applies to walls, and elements that support walls, that contain doors or windows required for emergency egress.
<b>9.23.9.7. Support of Tail and Header Joists</b>	
(1)	[F20-OS2.1,OS2.5] [F22-OS2.5] [F20,F22-OS2.3] Applies to elements that support or are part of an environmental separator.
	[F20-OP2.1,OP2.5] [F22-OP2.4,OP2.5] [F20,F22-OP2.3] Applies to elements that support or are part of an environmental separator.
	[F20,F22-OH1.1,OH1.2,OH1.3] Applies to elements that support or are part of an environmental separator.
	[F22-OH4]
	[F20,F22-OS1.2] Applies to assemblies required to provide fire resistance.
	[F22-OS3.1] [F22-OS3.7] Applies to walls, and elements that support walls, that contain doors or windows required for emergency egress.

Functional Statements and Objectives <sup>(1)</sup>	
<b>9.23.9.8. Support of Walls</b>	
(1)	[F20-OS2.1,OS2.5] [F22-OS2.5] [F20,F22-OS2.3] Applies to elements that support or are part of an environmental separator.
	[F20-OP2.1,OP2.5] [F22-OP2.4,OP2.5] [F20,F22-OP2.3] Applies to elements that support or are part of an environmental separator.
	[F20,F22-OH1.1,OH1.2,OH1.3] Applies to elements that support or are part of an environmental separator.
	[F22-OH4]
	[F20,F22-OS1.2] Applies to assemblies required to provide fire resistance.
	[F22-OS3.1] [F22-OS3.7] Applies to walls, and elements that support walls, that contain doors or windows required for emergency egress.
(2)	[F20-OS2.1,OS2.5] [F22-OS2.5] [F20,F22-OS2.3] Applies to elements that support or are part of an environmental separator.
	[F20-OP2.1,OP2.5] [F22-OP2.4,OP2.5] [F20,F22-OP2.3] Applies to elements that support or are part of an environmental separator.
	[F20,F22-OH1.1,OH1.2,OH1.3] Applies to elements that support or are part of an environmental separator.
	[F22-OH4]
	[F20,F22-OS1.2] Applies to assemblies required to provide fire resistance.
	[F22-OS3.1] [F22-OS3.7] Applies to walls, and elements that support walls, that contain doors or windows required for emergency egress.
(4)	[F22-OS3.1] [F22-OS3.7] Applies to walls, and elements that support walls, that contain doors or windows required for emergency egress.
	[F20,F22-OS1.2] Applies to assemblies required to provide fire resistance.
	[F20-OP2.1,OP2.5] [F22-OP2.4,OP2.5] [F20,F22-OP2.3] Applies to elements that support or are part of an environmental separator.
	[F22-OH4]
	[F20-OS2.1,OS2.5] [F22-OS2.5] [F20,F22-OS2.3] Applies to elements that support or are part of an environmental separator.
	[F20,F22-OH1.1,OH1.2,OH1.3] Applies to elements that support or are part of an environmental separator.

**Table 9.37.1.1. (Continued)**

Functional Statements and Objectives <sup>(1)</sup>	
(5)	[F20-OS2.1,OS2.5] [F22-OS2.5] [F20,F22-OS2.3] Applies to elements that support or are part of an environmental separator.
	[F20-OP2.1,OP2.5] [F22-OP2.4,OP2.5] [F20,F22-OP2.3] Applies to elements that support or are part of an environmental separator.
	[F20,F22-OH1.1,OH1.2,OH1.3] Applies to elements that support or are part of an environmental separator.
	[F22-OH4]
	[F20,F22-OS1.2] Applies to assemblies required to provide fire resistance.
	[F22-OS3.1] [F22-OS3.7] Applies to walls, and elements that support walls, that contain doors or windows required for emergency egress.
(6)	[F22-OS3.1] [F22-OS3.7] Applies to walls, and elements that support walls, that contain doors or windows required for emergency egress.
	[F20,F22-OS1.2] Applies to assemblies required to provide fire resistance.
	[F20-OP2.1,OP2.5] [F22-OP2.4,OP2.5] [F20,F22-OP2.3] Applies to elements that support or are part of an environmental separator.
	[F22-OH4]
	[F20-OS2.1,OS2.5] [F22-OS2.5] [F20,F22-OS2.3] Applies to elements that support or are part of an environmental separator.
	[F20,F22-OH1.1,OH1.2,OH1.3] Applies to elements that support or are part of an environmental separator.
<b>9.23.9.9. Cantilevered Floor Joists</b>	
(1)	[F20-OS2.1,OS2.5] [F22-OS2.5] [F20,F22-OS2.3] Applies to elements that support or are part of an environmental separator.
	[F20-OP2.1,OP2.5] [F22-OP2.4,OP2.5] [F20,F22-OP2.3] Applies to elements that support or are part of an environmental separator.
	[F20,F22-OH1.1,OH1.2,OH1.3] Applies to elements that support or are part of an environmental separator.
	[F22-OH4]
	[F20,F22-OS1.2] Applies to assemblies required to provide fire resistance.
	[F22-OS3.1] [F22-OS3.7] Applies to walls, and elements that support walls, that contain doors or windows required for emergency egress.

**Table 9.37.1.1. (Continued)**

Functional Statements and Objectives <sup>(1)</sup>		
(2)	[F20-OS2.1,OS2.5] [F22-OS2.5] [F20,F22-OS2.3] Applies to elements that support or are part of an environmental separator.	
	[F20-OP2.1,OP2.5] [F22-OP2.4,OP2.5] [F20,F22-OP2.3] Applies to elements that support or are part of an environmental separator.	
	[F20,F22-OH1.1,OH1.2,OH1.3] Applies to elements that support or are part of an environmental separator.	
	[F22-OH4]	
	[F20,F22-OS1.2] Applies to assemblies required to provide fire resistance.	
	[F22-OS3.1] [F22-OS3.7] Applies to walls, and elements that support walls, that contain doors or windows required for emergency egress.	
(3)	[F20-OS2.1,OS2.5] [F22-OS2.5] [F20,F22-OS2.3] Applies to elements that support or are part of an environmental separator.	
	[F20-OP2.1,OP2.5] [F22-OP2.4,OP2.5] [F20,F22-OP2.3] Applies to elements that support or are part of an environmental separator.	
	[F20,F22-OH1.1,OH1.2,OH1.3] Applies to elements that support or are part of an environmental separator.	
	[F22-OH4]	
	[F20,F22-OS1.2] Applies to assemblies required to provide fire resistance.	
	[F22-OS3.1] [F22-OS3.7] Applies to walls, and elements that support walls, that contain doors or windows required for emergency egress.	
	<b>9.23.10.1. Stud Size and Spacing</b>	
	(1)	[F20-OS2.1,OS2.5] [F22-OS2.5] [F20,F22-OS2.3] Applies to elements that support or are part of an environmental separator.
	[F20-OP2.1,OP2.5] [F22-OP2.4,OP2.5] [F20,F22-OP2.3] Applies to elements that support or are part of an environmental separator.	
	[F20,F22-OH1.1,OH1.2,OH1.3] Applies to elements that support or are part of an environmental separator.	
	[F22-OH4] Applies to floors and elements that support floors.	
	[F20,F22-OS1.2] Applies to assemblies required to provide fire resistance.	
	[F22-OS3.1] Applies to floors and elements that support floors. [F22-OS3.7] Applies to walls, and elements that support walls, that contain doors or windows required for emergency egress.	

Table 9.37.1.1. (Continued)

Table 9.37.1.1. (Continued)

Functional Statements and Objectives <sup>(1)</sup>	
<b>9.23.10.2. Bracing and Lateral Support</b>	
(1)	[F20-OS2.1,OS2.5] [F22-OS2.5] [F20,F22-OS2.3] Applies to walls that support or are part of an environmental separator.
	[F20-OP2.1,OP2.5] [F22-OP2.4,OP2.5] [F20,F22-OP2.3] Applies to walls that support or are part of an environmental separator.
	[F20,F22-OH1.1,OH1.2,OH1.3] Applies to walls that support or are part of an environmental separator.
	[F22-OH4] Applies to walls that support floors.
	[F20,F22-OS1.2] Applies to assemblies required to provide fire resistance.
	[F22-OS3.1] Applies to walls that support floors. [F22-OS3.7] Applies to walls that contain doors or windows required for emergency egress.
<b>9.23.10.3. Orientation of Studs</b>	
(1)	[F20-OS2.1,OS2.5] [F22-OS2.5] [F20,F22-OS2.3] Applies to elements that support or are part of an environmental separator.
	[F20-OP2.1,OP2.5] [F22-OP2.4,OP2.5] [F20,F22-OP2.3] Applies to elements that support or are part of an environmental separator.
	[F20,F22-OH1.1,OH1.2,OH1.3] Applies to elements that support or are part of an environmental separator.
	[F22-OH4] Applies to floors and elements that support floors.
	[F20,F22-OS1.2] Applies to assemblies required to provide fire resistance.
	[F22-OS3.1] Applies to floors and elements that support floors. [F22-OS3.7] Applies to walls, and elements that support walls, that contain doors or windows required for emergency egress.
(3)	[F20-OS2.1,OS2.5] [F22-OS2.5] [F20,F22-OS2.3] Applies to elements that support or are part of an environmental separator.
	[F20,F22-OH1.1,OH1.2,OH1.3] Applies to elements that support or are part of an environmental separator.
	[F20-OP2.1,OP2.5] [F22-OP2.4,OP2.5] [F20,F22-OP2.3] Applies to elements that support or are part of an environmental separator.
	[F20,F22-OS1.2] Applies to assemblies required to provide fire resistance.
	[F22-OS3.1] Applies to floors and elements that support floors. [F22-OS3.7] Applies to walls, and elements that support walls, that contain doors or windows required for emergency egress.

Functional Statements and Objectives <sup>(1)</sup>	
<b>9.23.10.4. Continuity of Studs</b>	
(1)	[F20-OS2.1,OS2.5] [F22-OS2.5] [F20,F22-OS2.3] Applies to elements that support or are part of an environmental separator.
	[F20-OP2.1,OP2.5] [F22-OP2.4,OP2.5] [F20,F22-OP2.3] Applies to elements that support or are part of an environmental separator.
	[F20,F22-OH1.1,OH1.2,OH1.3] Applies to elements that support or are part of an environmental separator.
	[F22-OH4] Applies to floors and elements that support floors.
	[F20,F22-OS1.2] Applies to assemblies required to provide fire resistance.
	[F22-OS3.1] Applies to floors and elements that support floors. [F22-OS3.7] Applies to walls, and elements that support walls, that contain doors or windows required for emergency egress.
<b>9.23.10.5. Support for Cladding, Sheathing and Finishing Materials</b>	
(1)	[F20-OS2.1,OS2.5] [F22-OS2.5] [F20,F22-OS2.3] Applies to elements that support or are part of an environmental separator.
	[F20-OP2.1,OP2.5] [F22-OP2.4,OP2.5] [F20,F22-OP2.3] Applies to elements that support or are part of an environmental separator.
	[F20,F22-OH1.1,OH1.2,OH1.3] Applies to elements that support or are part of an environmental separator.
	[F22-OH4] Applies to floors and elements that support floors.
	[F20,F22-OS1.2] Applies to assemblies required to provide fire resistance.
	[F22-OS3.1] Applies to floors and elements that support floors. [F22-OS3.7] Applies to walls, and elements that support walls, that contain doors or windows required for emergency egress.
(2)	[F20-OS2.1,OS2.5] [F22-OS2.5] [F20,F22-OS2.3] Applies to elements that support or are part of an environmental separator.
	[F20-OP2.1,OP2.5] [F22-OP2.4,OP2.5] [F20,F22-OP2.3] Applies to elements that support or are part of an environmental separator.
	[F20,F22-OH1.1,OH1.2,OH1.3] Applies to elements that support or are part of an environmental separator.
	[F22-OS3.1] Applies to floors and elements that support floors. [F22-OS3.7] Applies to walls, and elements that support walls, that contain doors or windows required for emergency egress.
	[F20,F22-OS1.2] Applies to assemblies required to provide fire resistance.
	[F22-OH4] Applies to floors and elements that support floors.

Table 9.37.1.1. (Continued)

Functional Statements and Objectives <sup>(1)</sup>	
<b>9.23.10.6. Studs at Sides of Openings</b>	
(1)	[F20-OS2.1,OS2.5] [F22-OS2.5] [F20,F22-OS2.3] Applies to elements that support or are part of an environmental separator.
	[F20-OP2.1,OP2.5] [F22-OP2.4,OP2.5] [F20,F22-OP2.3] Applies to elements that support or are part of an environmental separator.
	[F20,F22-OH1.1,OH1.2,OH1.3] Applies to elements that support or are part of an environmental separator.
	[F20,F22-OH4] Applies to floors and elements that support floors.
	[F20,F22-OS3.1] Applies to floors and elements that support floors. [F20,F22-OS3.7] Applies to walls, and elements that support walls, that contain doors or windows required for emergency egress.
	[F20,F22-OS1.2] Applies to assemblies required to provide fire resistance.
(2)	[F20-OS2.1,OS2.5] [F22-OS2.5] [F20,F22-OS2.3] Applies to elements that support or are part of an environmental separator.
	[F20-OP2.1,OP2.5] [F22-OP2.4,OP2.5] [F20,F22-OP2.3] Applies to elements that support or are part of an environmental separator.
	[F20,F22-OH1.1,OH1.2,OH1.3] Applies to elements that support or are part of an environmental separator.
	[F20,F22-OH4] Applies to floors and elements that support floors.
	[F20,F22-OS3.1] Applies to floors and elements that support floors. [F20,F22-OS3.7] Applies to walls, and elements that support walls, that contain doors or windows required for emergency egress.
	[F20,F22-OS1.2] Applies to assemblies required to provide fire resistance.

Table 9.37.1.1. (Continued)

Functional Statements and Objectives <sup>(1)</sup>	
(3)	[F20-OS2.1] (b) [F20,F22-OS2.5] (b) [F20,F22-OS2.3] Applies to elements that support or are part of an environmental separator.
	[F20-OP2.1] (b) [F20-OP2.5] (b) [F22-OP2.4,OP2.5] (b) [F20,F22-OP2.3] Applies to elements that support or are part of an environmental separator.
	(b) [F20,F22-OH1.1,OH1.2,OH1.3] Applies to elements that support or are part of an environmental separator.
	(b) [F20,F22-OH4] Applies to floors and elements that support floors.
	(b) [F20,F22-OS3.1] Applies to floors and elements that support floors. (b) [F20,F22-OS3.7] Applies to walls, and elements that support walls, that contain doors or windows required for emergency egress.
	(b) [F20,F22-OS1.2] Applies to assemblies required to provide fire resistance.
<b>9.23.11.1. Size of Wall Plates</b>	
(1)	[F20-OS2.1,OS2.5] [F22-OS2.5] [F20,F22-OS2.3] Applies to elements that support or are part of an environmental separator.
	[F20-OP2.1,OP2.5] [F22-OP2.4,OP2.5] [F20,F22-OP2.3] Applies to elements that support or are part of an environmental separator.
	[F20,F22-OH1.1,OH1.2,OH1.3] Applies to elements that support or are part of an environmental separator.
	[F22-OS3.1] Applies to floors and elements that support floors. [F22-OS3.7] Applies to walls, and elements that support walls, that contain doors or windows required for emergency egress.
	[F22-OH4] Applies to floors and elements that support floors.
	[F20,F22-OS1.2] Applies to assemblies required to provide fire resistance.
(2)	[F22-OS3.1] Applies to floors and elements that support floors. [F22-OS3.7] Applies to walls, and elements that support walls, that contain doors or windows required for emergency egress.
	[F20,F22-OS1.2] Applies to assemblies required to provide fire resistance.
	[F20-OP2.1,OP2.5] [F22-OP2.4,OP2.5] [F20,F22-OP2.3] Applies to elements that support or are part of an environmental separator.
	[F22-OH4] Applies to floors and elements that support floors.
	[F20,F22-OH1.1,OH1.2,OH1.3] Applies to elements that support or are part of an environmental separator.
	[F20-OS2.1,OS2.5] [F22-OS2.5] [F20,F22-OS2.3] Applies to elements that support or are part of an environmental separator.

Table 9.37.1.1. (Continued)

Functional Statements and Objectives <sup>(1)</sup>	
<b>9.23.11.2. Bottom Wall Plates</b>	
(1)	[F20-OS2.1,OS2.5] [F22-OS2.5] [F20,F22-OS2.3] Applies to elements that support or are part of an environmental separator.
	[F20-OP2.1,OP2.5] [F22-OP2.4,OP2.5] [F20,F22-OP2.3] Applies to elements that support or are part of an environmental separator.
	[F20,F22-OH1.1,OH1.2,OH1.3] Applies to elements that support or are part of an environmental separator.
	[F22-OH4] Applies to floors and elements that support floors.
	[F20,F22-OS1.2] Applies to assemblies required to provide fire resistance.
	[F22-OS3.1] Applies to floors and elements that support floors. [F22-OS3.7] Applies to walls, and elements that support walls, that contain doors or windows required for emergency egress.
	(2)
<b>9.23.11.3. Top Plates</b>	
(1)	[F20-OS2.1,OS2.5] [F22-OS2.5] [F20,F22-OS2.3] Applies to elements that support or are part of an environmental separator.
	[F20-OP2.1,OP2.5] [F22-OP2.4,OP2.5] [F20,F22-OP2.3] Applies to elements that support or are part of an environmental separator.
	[F20,F22-OH1.1,OH1.2,OH1.3] Applies to elements that support or are part of an environmental separator.
	[F22-OH4] Applies to floors and elements that support floors.
	[F20,F22-OS1.2] Applies to assemblies required to provide fire resistance.
	[F22-OS3.1] Applies to floors and elements that support floors. [F22-OS3.7] Applies to walls, and elements that support walls, that contain doors or windows required for emergency egress.

Table 9.37.1.1. (Continued)

Functional Statements and Objectives <sup>(1)</sup>	
(2)	[F20-OS2.1,OS2.5] [F22-OS2.5] [F20,F22-OS2.3] Applies to elements that support or are part of an environmental separator.
	[F20-OP2.1,OP2.5] [F22-OP2.4,OP2.5] [F20,F22-OP2.3] Applies to elements that support or are part of an environmental separator.
	[F20,F22-OH1.1,OH1.2,OH1.3] Applies to elements that support or are part of an environmental separator.
	[F22-OH4] Applies to floors and elements that support floors.
	[F20,F22-OS1.2] Applies to assemblies required to provide fire resistance.
	[F22-OS3.1] Applies to floors and elements that support floors. [F22-OS3.7] Applies to walls, and elements that support walls, that contain doors or windows required for emergency egress.
	(3)
(4)	[F20-OS2.1,OS2.5] [F22-OS2.5] [F20,F22-OS2.3] Applies to elements that support or are part of an environmental separator.
	[F20-OP2.1,OP2.5] [F22-OP2.4,OP2.5] [F20,F22-OP2.3] Applies to elements that support or are part of an environmental separator.
	[F20,F22-OH1.1,OH1.2,OH1.3] Applies to elements that support or are part of an environmental separator.
	[F22-OH4] Applies to floors and elements that support floors.
	[F20,F22-OS1.2] Applies to assemblies required to provide fire resistance.
	[F22-OS3.1] Applies to floors and elements that support floors. [F22-OS3.7] Applies to walls, and elements that support walls, that contain doors or windows required for emergency egress.



**Table 9.37.1.1. (Continued)**

Functional Statements and Objectives <sup>(1)</sup>	
<b>9.23.11.4. Joints in Top Plates</b>	
(1)	[F20-OS2.1,OS2.5] [F22-OS2.5] [F20,F22-OS2.3] Applies to elements that support or are part of an environmental separator.
	[F20-OP2.1,OP2.5] [F22-OP2.4,OP2.5] [F20,F22-OP2.3] Applies to elements that support or are part of an environmental separator.
	[F20,F22-OH1.1,OH1.2,OH1.3] Applies to elements that support or are part of an environmental separator.
	[F22-OH4] Applies to floors and elements that support floors.
	[F22-OS1.2] Applies to assemblies required to provide fire resistance.
	[F22-OS3.1] Applies to floors and elements that support floors. [F22-OS3.7] Applies to walls, and elements that support walls, that contain doors or windows required for emergency egress.
(2)	[F20-OS2.1,OS2.5] [F22-OS2.5] [F20,F22-OS2.3] Applies to elements that support or are part of an environmental separator.
	[F20-OP2.1,OP2.5] [F22-OP2.4,OP2.5] [F20,F22-OP2.3] Applies to elements that support or are part of an environmental separator.
	[F20,F22-OH1.1,OH1.2,OH1.3] Applies to elements that support or are part of an environmental separator.
	[F22-OH4] Applies to floors and elements that support floors.
	[F20,F22-OS1.2] Applies to assemblies required to provide fire resistance.
	[F22-OS3.1] Applies to floors and elements that support floors. [F22-OS3.7] Applies to walls, and elements that support walls, that contain doors or windows required for emergency egress.
(3)	[F20-OS2.1,OS2.5] [F22-OS2.5] [F20,F22-OS2.3] Applies to elements that support or are part of an environmental separator.
	[F20-OP2.1,OP2.5] [F22-OP2.4,OP2.5] [F20,F22-OP2.3] Applies to elements that support or are part of an environmental separator.
	[F20,F22-OH1.1,OH1.2,OH1.3] Applies to elements that support or are part of an environmental separator.
	[F22-OH4] Applies to floors and elements that support floors.
	[F20,F22-OS1.2] Applies to assemblies required to provide fire resistance.
	[F22-OS3.1] Applies to floors and elements that support floors. [F22-OS3.7] Applies to walls, and elements that support walls, that contain doors or windows required for emergency egress.

**Table 9.37.1.1. (Continued)**

Functional Statements and Objectives <sup>(1)</sup>	
(4)	[F20-OS2.1,OS2.5] [F22-OS2.5] [F20,F22-OS2.3] Applies to elements that support or are part of an environmental separator.
	[F20-OP2.1,OP2.5] [F22-OP2.4,OP2.5] [F20,F22-OP2.3] Applies to elements that support or are part of an environmental separator.
	[F20,F22-OH1.1,OH1.2,OH1.3] Applies to elements that support or are part of an environmental separator.
	[F22-OH4] Applies to floors and elements that support floors.
	[F20,F22-OS1.2] Applies to assemblies required to provide fire resistance.
	[F22-OS3.1] Applies to floors and elements that support floors. [F22-OS3.7] Applies to walls, and elements that support walls, that contain doors or windows required for emergency egress.
(5)	[F20-OS2.1,OS2.5] [F22-OS2.5] [F20,F22-OS2.3] Applies to elements that support or are part of an environmental separator.
	[F20-OP2.1,OP2.5] [F22-OP2.4,OP2.5] [F20,F22-OP2.3] Applies to elements that support or are part of an environmental separator.
	[F20,F22-OH1.1,OH1.2,OH1.3] Applies to elements that support or are part of an environmental separator.
	[F22-OH4] Applies to floors and elements that support floors.
	[F20,F22-OS1.2] Applies to assemblies required to provide fire resistance.
	[F22-OS3.1] Applies to floors and elements that support floors. [F22-OS3.7] Applies to walls, and elements that support walls, that contain doors or windows required for emergency egress.
<b>9.23.12.1. Openings in Non-Loadbearing Walls</b>	
(1)	[F20-OS2.1,OS2.5] [F22-OS2.5] [F20,F22-OS2.3] Applies to elements that support or are part of an environmental separator.
	[F20-OP2.1,OP2.5] [F22-OP2.4,OP2.5] [F20,F22-OP2.3] Applies to elements that support or are part of an environmental separator.
	[F20,F22-OH1.1,OH1.2,OH1.3] Applies to elements that support or are part of an environmental separator.
	[F22-OS3.1] Applies to floors and elements that support floors. [F22-OS3.7] Applies to walls, and elements that support walls, that contain doors or windows required for emergency egress.
(2)	[F20,F22-OS1.2]

Table 9.37.1.1. (Continued)

Functional Statements and Objectives <sup>(1)</sup>	
<b>9.23.12.2. Openings in Loadbearing Walls</b>	
(1)	[F20-OS2.1,OS2.5] [F22-OS2.5] [F20,F22-OS2.3] Applies to elements that support or are part of an environmental separator.
	[F20-OP2.1,OP2.5] [F22-OP2.4,OP2.5] [F20,F22-OP2.3] Applies to elements that support or are part of an environmental separator.
	[F20,F22-OH1.1,OH1.2,OH1.3] Applies to elements that support or are part of an environmental separator.
	[F22-OH4] Applies to floors and elements that support floors.
	[F20,F22-OS1.2] Applies to assemblies required to provide fire resistance.
	[F22-OS3.1] Applies to floors and elements that support floors. [F22-OS3.7] Applies to walls, and elements that support walls, that contain doors or windows required for emergency egress.
(2)	[F20-OS2.1,OS2.5] [F22-OS2.5] [F20,F22-OS2.3] Applies to elements that support or are part of an environmental separator.
	[F20-OP2.1,OP2.5] [F22-OP2.4,OP2.5] [F20,F22-OP2.3] Applies to elements that support or are part of an environmental separator.
	[F20,F22-OH1.1,OH1.2,OH1.3] Applies to elements that support or are part of an environmental separator.
	[F22-OH4] Applies to floors and elements that support floors.
	[F20,F22-OS1.2] Applies to assemblies required to provide fire resistance.
	[F22-OS3.1] Applies to floors and elements that support floors. [F22-OS3.7] Applies to walls, and elements that support walls, that contain doors or windows required for emergency egress.
<b>9.23.12.3. Lintel Spans and Sizes</b>	
(1)	[F20-OS2.1,OS2.5] [F22-OS2.5] [F20,F22-OS2.3] Applies to elements that support or are part of an environmental separator.
	[F20-OP2.1,OP2.5] [F22-OP2.4,OP2.5] [F20,F22-OP2.3] Applies to elements that support or are part of an environmental separator.
	[F20,F22-OH1.1,OH1.2,OH1.3] Applies to elements that support or are part of an environmental separator.
	[F22-OH4] Applies to floors and elements that support floors.
	[F20,F22-OS1.2] Applies to assemblies required to provide fire resistance.
	[F22-OS3.1] Applies to floors and elements that support floors. [F22-OS3.7] Applies to walls, and elements that support walls, that contain doors or windows required for emergency egress.

Table 9.37.1.1. (Continued)

Functional Statements and Objectives <sup>(1)</sup>	
(2)	[F20-OS2.1,OS2.5] [F22-OS2.5] [F20,F22-OS2.3] Applies to elements that support or are part of an environmental separator.
	[F20-OP2.1,OP2.5] [F22-OP2.4,OP2.5] [F20,F22-OP2.3] Applies to elements that support or are part of an environmental separator.
	[F20,F22-OH1.1,OH1.2,OH1.3] Applies to elements that support or are part of an environmental separator.
	[F22-OH4] Applies to floors and elements that support floors.
	[F20,F22-OS1.2] Applies to assemblies required to provide fire resistance.
	[F22-OS3.1] Applies to floors and elements that support floors. [F22-OS3.7] Applies to walls, and elements that support walls, that contain doors or windows required for emergency egress.
(3)	[F20-OS2.1,OS2.5] [F22-OS2.5] [F20,F22-OS2.3] Applies to elements that support or are part of an environmental separator.
	[F20-OP2.1,OP2.5] [F22-OP2.4,OP2.5] [F20,F22-OP2.3] Applies to elements that support or are part of an environmental separator.
	[F20,F22-OH1.1,OH1.2,OH1.3] Applies to elements that support or are part of an environmental separator.
	[F22-OH4] Applies to floors and elements that support floors.
	[F20,F22-OS1.2] Applies to assemblies required to provide fire resistance.
	[F22-OS3.1] Applies to floors and elements that support floors. [F22-OS3.7] Applies to walls, and elements that support walls, that contain doors or windows required for emergency egress.
<b>9.23.13.1. Requirements for Low to Moderate Wind and Seismic Forces</b>	
(2)	[F20-OS2.1,OS2.3,OS2.5] [F22-OS2.3,OS2.4,OS2.5]
	[F20-OP2.1,OP2.3,OP2.5] [F22-OP2.3,OP2.4,OP2.5]
	[F20,F22-OH1.1,OH1.2,OH1.3]
	[F20,F22-OS1.2] Applies to assemblies required to provide fire resistance.
	[F22-OS3.1] Applies to walls that support floors. [F22-OS3.7] Applies to walls that contain doors or windows required for emergency egress.
	[F20,F22-OH4] Applies to walls that support floors.

**Table 9.37.1.1. (Continued)**

Functional Statements and Objectives <sup>(1)</sup>	
<b>9.23.13.4. Braced Wall Bands</b>	
(1)	[F20-OS2.1,OS2.3,OS2.5] [F22-OS2.3,OS2.4,OS2.5]
	[F20-OP2.1,OP2.3,OP2.5] [F22-OP2.3,OP2.4,OP2.5]
	[F20,F22-OS1.2] Applies to assemblies required to provide fire resistance.
	[F22-OS3.1] Applies to walls that support floors. [F22-OS3.7] Applies to walls that contain doors or windows required for emergency egress.
	[F20,F22-OH4] Applies to walls that support floors.
	[F20,F22-OH1.1,OH1.2,OH1.3] Applies to elements that support or are part of an environmental separator.
(2)	[F20-OS2.1,OS2.3,OS2.5] [F22-OS2.3,OS2.4,OS2.5]
	[F20-OP2.1,OP2.3,OP2.5] [F22-OP2.3,OP2.4,OP2.5]
	[F20,F22-OH1.1,OH1.2,OH1.3]
	[F20,F22-OS1.2] Applies to assemblies required to provide fire resistance.
	[F22-OS3.1] Applies to walls that support floors. [F22-OS3.7] Applies to walls that contain doors or windows required for emergency egress.
	[F20,F22-OH4] Applies to walls that support floors.
(3)	[F20-OS2.1,OS2.3,OS2.5] [F22-OS2.3,OS2.4,OS2.5]
	[F20-OP2.1,OP2.3,OP2.5] [F22-OP2.3,OP2.4,OP2.5]
	[F20,F22-OS1.2] Applies to assemblies required to provide fire resistance.
	[F22-OS3.1] Applies to walls that support floors. [F22-OS3.7] Applies to walls that contain doors or windows required for emergency egress.
	[F20,F22-OH4] Applies to walls that support floors.
	[F20,F22-OH1.1,OH1.2,OH1.3] Applies to elements that support or are part of an environmental separator.
<b>9.23.13.5. Braced Wall Panels in Braced Wall Bands</b>	
(1)	[F20-OS2.1,OS2.3,OS2.5] [F22-OS2.3,OS2.4,OS2.5]
	[F20-OP2.1,OP2.3,OP2.5] [F22-OP2.3,OP2.4,OP2.5]
	[F20,F22-OS1.2] Applies to assemblies required to provide fire resistance.
	[F22-OS3.1] Applies to walls that support floors. [F22-OS3.7] Applies to walls that contain doors or windows required for emergency egress.
	[F20,F22-OH4] Applies to walls that support floors.
[F20,F22-OH1.1,OH1.2,OH1.3] Applies to elements that support or are part of an environmental separator.	

**Table 9.37.1.1. (Continued)**

Functional Statements and Objectives <sup>(1)</sup>	
(2)	[F20-OS2.1,OS2.3,OS2.5] [F22-OS2.3,OS2.4,OS2.5]
	[F20-OP2.1,OP2.3,OP2.5] [F22-OP2.3,OP2.4,OP2.5]
	[F20,F22-OS1.2] Applies to assemblies required to provide fire resistance.
	[F22-OS3.1] Applies to walls that support floors. [F22-OS3.7] Applies to walls that contain doors or windows required for emergency egress.
	[F20,F22-OH4] Applies to walls that support floors.
[F20,F22-OH1.1,OH1.2,OH1.3] Applies to elements that support or are part of an environmental separator.	
<b>9.23.13.6. Materials in Braced Wall Panels</b>	
(1)	[F20-OS2.1,OS2.3,OS2.5] [F22-OS2.3,OS2.4,OS2.5]
	[F20-OP2.1,OP2.3,OP2.5] [F22-OP2.3,OP2.4,OP2.5]
	[F20,F22-OS1.2] Applies to assemblies required to provide fire resistance.
	[F22-OS3.1] Applies to walls that support floors. [F22-OS3.7] Applies to walls that contain doors or windows required for emergency egress.
	[F20,F22-OH4] Applies to walls that support floors.
[F20,F22-OH1.1,OH1.2,OH1.3] Applies to elements that support or are part of an environmental separator.	
(2)	[F20-OS2.1,OS2.3,OS2.5] [F22-OS2.3,OS2.4,OS2.5]
	[F20-OP2.1,OP2.3,OP2.5] [F22-OP2.3,OP2.4,OP2.5]
	[F20,F22-OS1.2] Applies to assemblies required to provide fire resistance.
	[F22-OS3.1] Applies to walls that support floors. [F20,F22-OH4] Applies to walls that support floors.
(4)	[F20-OS2.1,OS2.3,OS2.5] [F22-OS2.3,OS2.4,OS2.5]
	[F20-OP2.1,OP2.3,OP2.5] [F22-OP2.3,OP2.4,OP2.5]
	[F20,F22-OS1.2] Applies to assemblies required to provide fire resistance.
	[F22-OS3.1] Applies to walls that support floors. [F22-OS3.7] Applies to walls that contain doors or windows required for emergency egress.
[F20,F22-OH4] Applies to walls that support floors.	
[F20,F22-OH1.1,OH1.2,OH1.3] Applies to elements that support or are part of an environmental separator.	
(5)	[F20-OS2.1,OS2.3,OS2.5] [F22-OS2.3,OS2.4,OS2.5]
	[F20-OP2.1,OP2.3,OP2.5] [F22-OP2.3,OP2.4,OP2.5]
	[F20,F22-OS1.2] Applies to assemblies required to provide fire resistance.
	[F22-OS3.1] Applies to walls that support floors. [F22-OS3.7] Applies to walls that contain doors or windows required for emergency egress.
	[F20,F22-OH4] Applies to walls that support floors.
[F20,F22-OH1.1,OH1.2,OH1.3]	

Table 9.37.1.1. (Continued)

Functional Statements and Objectives <sup>(1)</sup>	
(6)	[F20-OS2.1,OS2.3,OS2.5] [F22-OS2.3,OS2.4,OS2.5]
	[F20-OP2.1,OP2.3,OP2.5] [F22-OP2.3,OP2.4,OP2.5]
	[F20,F22-OS1.2] Applies to assemblies required to provide fire resistance.
	[F22-OS3.1] Applies to walls that support floors. [F22-OS3.7] Applies to walls that contain doors or windows required for emergency egress.
	[F20,F22-OH4] Applies to walls that support floors. [F20,F22-OH1.1,OH1.2,OH1.3] Applies to elements that support or are part of an environmental separator.
<b>9.23.13.7. Additional System Considerations</b>	
(7)	[F20-OS2.1,OS2.3,OS2.5] [F22-OS2.3,OS2.4,OS2.5]
	[F20-OP2.1,OP2.3,OP2.5] [F22-OP2.3,OP2.4,OP2.5]
	[F20,F22-OS1.2] Applies to assemblies required to provide fire resistance.
	[F22-OS3.1] Applies to walls that support floors. [F22-OS3.7] Applies to walls that contain doors or windows required for emergency egress.
	[F20,F22-OH4] Applies to walls that support floors. [F20,F22-OH1.1,OH1.2,OH1.3] Applies to elements that support or are part of an environmental separator.
<b>9.23.14.1. Continuity of Rafters and Joists</b>	
(1)	[F20-OS2.1,OS2.5] [F22-OS2.5] [F20,F22-OS2.3] Applies to elements that support or are part of an environmental separator.
	[F20-OP2.1,OP2.5] [F22-OP2.5] [F20,F22-OP2.3] Applies to elements that support or are part of an environmental separator.
	[F20,F22-OH1.1,OH1.2,OH1.3] Applies to elements that support or are part of an environmental separator.
	[F20,F22-OS1.2] Applies to assemblies required to provide fire resistance.
<b>9.23.14.2. Framing around Openings</b>	
(1)	[F20-OS2.1,OS2.5] [F22-OS2.5] [F20,F22-OS2.3] Applies to elements that support or are part of an environmental separator.
	[F20-OP2.1,OP2.5] [F22-OP2.5] [F20,F22-OP2.3] Applies to elements that support or are part of an environmental separator.
	[F20,F22-OH1.1,OH1.2,OH1.3] Applies to elements that support or are part of an environmental separator.
	[F20,F22-OS1.2] Applies to assemblies required to provide fire resistance.

Table 9.37.1.1. (Continued)

Functional Statements and Objectives <sup>(1)</sup>	
<b>9.23.14.3. End Bearing Length</b>	
(1)	[F20-OS2.1,OS2.5] [F22-OS2.5] [F20,F22-OS2.3] Applies to elements that support or are part of an environmental separator.
	[F20-OP2.1,OP2.5] [F22-OP2.5] [F20,F22-OP2.3] Applies to elements that support or are part of an environmental separator.
	[F20,F22-OS1.2] Applies to assemblies required to provide fire resistance.
	[F20,F22-OH1.1,OH1.2,OH1.3] Applies to elements that support or are part of an environmental separator.
<b>9.23.14.4. Location and Attachment of Rafters</b>	
(1)	[F20-OS2.1,OS2.3,OS2.5] [F22-OS2.3,OS2.5] [F20-OP2.1,OP2.3,OP2.5] [F22-OP2.3,OP2.5] [F20,F22-OH1.1,OH1.2,OH1.3]
	[F20,F22-OS1.2] Applies to assemblies required to provide fire resistance.
(2)	[F20-OS2.1,OS2.3,OS2.5] [F22-OS2.3,OS2.5] [F20-OP2.1,OP2.3,OP2.5] [F22-OP2.3,OP2.5] [F20,F22-OH1.1,OH1.2,OH1.3]
	[F20,F22-OS1.2] Applies to assemblies required to provide fire resistance.
(3)	[F20-OS2.1,OS2.3,OS2.5] [F22-OS2.3,OS2.5] [F20-OP2.1,OP2.3,OP2.5] [F22-OP2.3,OP2.5] [F20,F22-OH1.1,OH1.2,OH1.3]
	[F20,F22-OS1.2] Applies to assemblies required to provide fire resistance.
<b>9.23.14.5. Shaping of Rafters</b>	
(1)	[F20-OS2.1,OS2.3,OS2.5] [F22-OS2.3,OS2.5] [F20-OP2.1,OP2.3,OP2.5] [F22-OP2.3,OP2.5] [F20,F22-OH1.1,OH1.2,OH1.3]
	[F20,F22-OS1.2] Applies to assemblies required to provide fire resistance.
<b>9.23.14.6. Hip and Valley Rafters</b>	
(1)	[F20-OS2.1,OS2.3,OS2.5] [F22-OS2.3,OS2.5] [F20-OP2.1,OP2.3,OP2.5] [F22-OP2.3,OP2.5] [F20,F22-OH1.1,OH1.2,OH1.3]
<b>9.23.14.7. Intermediate Support for Rafters and Joists</b>	
(1)	[F20-OS2.1,OS2.3,OS2.5] [F22-OS2.3,OS2.5] [F20-OP2.1,OP2.3,OP2.5] [F22-OP2.3,OP2.5] [F20,F22-OH1.1,OH1.2,OH1.3]
	[F20,F22-OS1.2] Applies to assemblies required to provide fire resistance.
(2)	[F20-OS2.1,OS2.3,OS2.5] [F22-OS2.3,OS2.5] [F20-OP2.1,OP2.3,OP2.5] [F22-OP2.3,OP2.5]

Table 9.37.1.1. (Continued)

Functional Statements and Objectives <sup>(1)</sup>	
(4)	[F20-OS2.1,OS2.3,OS2.5] [F22-OS2.3,OS2.5]
	[F20-OP2.1,OP2.3,OP2.5] [F22-OP2.3,OP2.5]
	[F20,F22-OH1.1,OH1.2,OH1.3]
	[F20,F22-OS1.2] Applies to assemblies required to provide fire resistance.
(5)	[F20-OS2.1,OS2.3,OS2.5] [F22-OS2.3,OS2.5]
	[F20-OP2.1,OP2.3,OP2.5] [F22-OP2.3,OP2.5]
	[F20,F22-OH1.1,OH1.2,OH1.3]
	[F20,F22-OS1.2] Applies to assemblies required to provide fire resistance.
(6)	[F20-OP2.1,OP2.3,OP2.5] [F22-OP2.3,OP2.4,OP2.5]
	[F20,F22-OH1.1,OH1.2,OH1.3]
	[F20-OS2.1,OS2.3,OS2.5] [F22-OS2.3,OS2.5]
	[F22-OH4]
	[F20,F22-OS1.2] Applies to assemblies required to provide fire resistance.
	[F22-OS3.1] Applies to floors and elements that support floors. [F22-OS3.7] Applies to walls, and elements that support walls, that contain doors or windows required for emergency egress.
<b>9.23.14.8. Ridge Support</b>	
(1)	[F20-OS2.1,OS2.3,OS2.5] [F22-OS2.3,OS2.5]
	[F20-OP2.1,OP2.3,OP2.5] [F22-OP2.3,OP2.4,OP2.5]
	[F20,F22-OH1.1,OH1.2,OH1.3]
	[F20,F22-OS1.2] Applies to assemblies required to provide fire resistance.
	[F22-OS3.7] Applies to walls, and elements that support walls, that contain doors or windows required for emergency egress.
(3)	[F20-OS2.1,OS2.3,OS2.5] [F22-OS2.3,OS2.5]
	[F20-OP2.1,OP2.3,OP2.5] [F22-OP2.3,OP2.4,OP2.5]
	[F20,F22-OH1.1,OH1.2,OH1.3]
	[F20,F22-OS1.2] Applies to assemblies required to provide fire resistance.
	[F22-OS3.7] Applies to walls, and elements that support walls, that contain doors or windows required for emergency egress.
(4)	[F20-OS2.1,OS2.3,OS2.5] [F22-OS2.3,OS2.5]
	[F20-OP2.1,OP2.3,OP2.5] [F22-OP2.3,OP2.4,OP2.5]
	[F20,F22-OH1.1,OH1.2,OH1.3]
	[F20,F22-OS1.2] Applies to assemblies required to provide fire resistance.
	[F22-OS3.7] Applies to walls, and elements that support walls, that contain doors or windows required for emergency egress.

Table 9.37.1.1. (Continued)

Functional Statements and Objectives <sup>(1)</sup>	
(5)	[F20-OS2.1,OS2.3,OS2.5] [F22-OS2.3,OS2.5]
	[F20-OP2.1,OP2.3,OP2.5] [F22-OP2.3,OP2.4,OP2.5]
	[F20,F22-OH1.1,OH1.2,OH1.3]
	[F20,F22-OS1.2] Applies to assemblies required to provide fire resistance.
	[F22-OS3.7] Applies to walls, and elements that support walls, that contain doors or windows required for emergency egress.
(6)	[F20-OS2.1,OS2.3,OS2.5] [F22-OS2.3,OS2.5]
	[F20-OP2.1,OP2.3,OP2.5] [F22-OP2.3,OP2.4,OP2.5]
	[F20,F22-OH1.1,OH1.2,OH1.3]
	[F20,F22-OS1.2] Applies to assemblies required to provide fire resistance.
	[F22-OS3.7] Applies to walls, and elements that support walls, that contain doors or windows required for emergency egress.
(7)	[F20-OS2.1,OS2.3,OS2.5] [F22-OS2.3,OS2.5]
	[F20-OP2.1,OP2.3,OP2.5] [F22-OP2.3,OP2.4,OP2.5]
	[F20,F22-OH1.1,OH1.2,OH1.3]
	[F20,F22-OS1.2] Applies to assemblies required to provide fire resistance.
	[F20,F22-OS3.7] Applies to walls, and elements that support walls, that contain doors or windows required for emergency egress.
<b>9.23.14.9. Restraint of Joist Bottoms</b>	
(1)	[F20-OS2.1,OS2.3,OS2.5] [F22-OS2.3,OS2.5]
	[F20-OP2.1,OP2.3,OP2.5] [F22-OP2.3,OP2.5]
	[F20,F22-OH1.1,OH1.2,OH1.3]
	[F20,F22-OS1.2] Applies to assemblies required to provide fire resistance.
<b>9.23.14.10. Ceiling Joists Supporting Roof Load</b>	
(1)	[F20-OS2.1,OS2.3,OS2.5] [F22-OS2.3,OS2.5]
	[F20-OP2.1,OP2.3,OP2.5] [F22-OP2.3,OP2.5]
	[F20,F22-OH1.1,OH1.2,OH1.3]
	[F20,F22-OS1.2] Applies to assemblies required to provide fire resistance.
(2)	[F20-OS2.1,OS2.3,OS2.5] [F22-OS2.3,OS2.5]
	[F20-OP2.1,OP2.3,OP2.5] [F22-OP2.3,OP2.5]
	[F20,F22-OH1.1,OH1.2,OH1.3]
	[F20,F22-OS1.2] Applies to assemblies required to provide fire resistance.
<b>9.23.14.11. Roof Trusses</b>	
(1)	[F20-OS2.1,OS2.3,OS2.5] [F22-OS2.3,OS2.5]
	[F20-OP2.1,OP2.3,OP2.5] [F22-OP2.3,OP2.4,OP2.5]
	(b) [F20,F22-OH1.1,OH1.2,OH1.3]
	(b) [F20,F22-OS1.2] Applies to assemblies required to provide fire resistance.
(3)	[F20-OS2.1,OS2.3,OS2.5] [F22-OS2.3,OS2.5]
	[F20-OP2.1,OP2.3,OP2.5] [F22-OP2.3,OP2.5]

Table 9.37.1.1. (Continued)

Functional Statements and Objectives <sup>(1)</sup>	
(4)	[F20-OS2.1,OS2.3,OS2.5] [F22-OS2.3,OS2.5] [F20-OP2.1,OP2.3,OP2.5] [F22-OP2.3,OP2.5]
(5)	[F20-OS2.1,OS2.3,OS2.5] [F22-OS2.3,OS2.5] [F20-OP2.1,OP2.3,OP2.5] [F22-OP2.3,OP2.5] [F20,F22-OH1.1,OH1.2,OH1.3] [F20,F22-OS1.2] Applies to assemblies required to provide fire resistance.
(6)	[F20-OS2.1,OS2.3,OS2.5] [F22-OS2.3,OS2.5] [F20-OP2.1,OP2.3,OP2.5] [F22-OP2.3,OP2.5] [F20,F22-OH1.1,OH1.2,OH1.3] [F20,F22-OS1.2] Applies to assemblies required to provide fire resistance.
<b>9.23.15.1. Subflooring Required</b>	
(1)	[F20-OS2.1]
<b>9.23.15.2. Material Standards</b>	
(1)	[F22-OS3.1] [F22-OP2.4] [F22-OH4] [F20-OS2.1]
(2)	[F80-OS3.1] [F80-OP2.4] [F80-OH4] [F80-OS2.1]
(3)	[F22-OS3.1] [F22-OP2.4] [F22-OH4] [F20-OS2.1]
(4)	[F80-OS3.1] [F80-OP2.4] [F80-OH4] [F80-OH1.1]
<b>9.23.15.3. Edge Support</b>	
(1)	[F22-OS3.1] [F22-OP2.4] [F22-OH4]
<b>9.23.15.4. Direction of Installation</b>	
(1)	[F22-OS3.1] [F22-OP2.4] [F22-OH4]
(2)	[F22-OS3.1] [F22-OP2.4] [F22-OH4]

Table 9.37.1.1. (Continued)

Functional Statements and Objectives <sup>(1)</sup>	
<b>9.23.15.5. Subfloor Thickness or Rating</b>	
(1)	[F22-OS3.1] [F22-OP2.4] [F22-OH4] [F20-OS2.1]
(2)	[F20-OS2.1] [F22-OS3.1] [F22-OH4] [F22-OP2.4]
(3)	[F20-OS2.1] [F22-OH4] [F22-OS3.1] [F22-OP2.4]
<b>9.23.15.6. Annular Grooved Nails</b>	
(1)	[F81-OS2.3] [F81-OP2.3] [F81-OH1.1]
<b>9.23.15.7. Lumber Subflooring</b>	
(1)	[F22-OS3.1] [F22-OP2.4] [F22-OH4]
(2)	[F22-OS3.1] [F22-OP2.4] [F22-OH4]
(3)	[F22-OS3.1] [F22-OP2.4]
<b>9.23.16.1. Required Roof Sheathing</b>	
(1)	[F20-OS2.1,OS2.3,OS2.5] [F22-OS2.3,OS2.4,OS2.5] [F20-OP2.1,OP2.3,OP2.5] [F22-OP2.3,OP2.4,OP2.5] [F20,F22-OH1.1,OH1.2,OH1.3]
<b>9.23.16.2. Material Standards</b>	
(1)	[F20-OS2.1,OS2.3,OS2.5] [F22-OS2.3,OS2.5] [F20-OP2.1,OP2.3,OP2.5] [F22-OP2.3,OP2.5] [F20,F22-OH1.1,OH1.2,OH1.3] [F20,F22-OS1.2] Applies to assemblies required to provide fire resistance.
<b>9.23.16.3. Direction of Installation</b>	
(1)	[F20-OS2.1,OS2.3,OS2.5] [F22-OS2.3,OS2.5] [F20-OP2.1,OP2.3,OP2.5] [F22-OP2.3,OP2.5] [F20,F22-OH1.1,OH1.2,OH1.3] [F20,F22-OS1.2] Applies to assemblies required to provide fire resistance.

Copyright © NRC 1941 - 2021 World Rights Reserved © CNRC 1941-2021 Droits réservés pour tous pays

Table 9.37.1.1. (Continued)

Functional Statements and Objectives <sup>(1)</sup>	
(2)	[F20-OS2.1,OS2.3,OS2.5] [F22-OS2.3,OS2.5]
	[F20-OP2.1,OP2.3,OP2.5] [F22-OP2.3,OP2.5]
	[F20,F22-OH1.1,OH1.2,OH1.3]
	[F20,F22-OS1.2] Applies to assemblies required to provide fire resistance.
<b>9.23.16.4. Joints in Panel-Type Sheathing</b>	
(1)	[F20-OS2.1,OS2.3,OS2.5] [F22-OS2.3,OS2.5]
	[F20-OP2.1,OP2.3,OP2.5] [F22-OP2.3,OP2.5]
	[F20,F22-OH1.1,OH1.2,OH1.3]
	[F20,F22-OS1.2] Applies to assemblies required to provide fire resistance.
(2)	[F20-OS2.1,OS2.3,OS2.5] [F22-OS2.3,OS2.5]
	[F20-OP2.1,OP2.3,OP2.5] [F22-OP2.3,OP2.5]
	[F20,F22-OH1.1,OH1.2,OH1.3]
	[F20,F22-OS1.2] Applies to assemblies required to provide fire resistance.
<b>9.23.16.5. Lumber Roof Sheathing</b>	
(1)	[F20-OS2.1,OS2.3,OS2.5] [F22-OS2.3,OS2.5]
	[F20-OP2.1,OP2.3,OP2.5] [F22-OP2.3,OP2.5]
	[F20,F22-OH1.1,OH1.2,OH1.3]
	[F20,F22-OS1.2] Applies to assemblies required to provide fire resistance.
(2)	[F20-OS2.1,OS2.3,OS2.5] [F22-OS2.3,OS2.4,OS2.5]
	[F20-OP2.1,OP2.3,OP2.5] [F22-OP2.3,OP2.4,OP2.5]
	[F20,F22-OS1.2] Applies to assemblies required to provide fire resistance.
	[F20,F22-OH1.1,OH1.2,OH1.3]
<b>9.23.16.6. Edge Support</b>	
(1)	[F20-OS2.1,OS2.3,OS2.5] [F22-OS2.3,OS2.5]
	[F20-OP2.1,OP2.3,OP2.5] [F22-OP2.3,OP2.5]
	[F20,F22-OH1.1,OH1.2,OH1.3]
	[F20,F22-OS1.2] Applies to assemblies required to provide fire resistance.
<b>9.23.16.7. Thickness or Rating</b>	
(1)	[F20-OS2.1,OS2.3,OS2.5] [F22-OS2.3,OS2.5]
	[F20-OP2.1,OP2.3,OP2.5] [F22-OP2.3,OP2.4,OP2.5]
	[F20,F22-OH1.1,OH1.2,OH1.3]
	[F22-OH4]
	[F22-OS3.1]
(2)	[F20-OS2.1,OS2.3,OS2.5] [F22-OS2.3,OS2.5]
	[F20-OP2.1,OP2.3,OP2.5] [F22-OP2.3,OP2.5]
	[F20,F22-OH1.1,OH1.2,OH1.3]
	[F20,F22-OS1.2] Applies to assemblies required to provide fire resistance.

Table 9.37.1.1. (Continued)

Functional Statements and Objectives <sup>(1)</sup>	
(3)	[F20-OS2.1,OS2.3,OS2.5] [F22-OS2.3,OS2.5]
	[F20-OP2.1,OP2.3,OP2.5] [F22-OP2.3,OP2.5]
	[F20,F22-OH1.1,OH1.2,OH1.3]
(4)	[F20-OS2.1,OS2.3,OS2.5] [F22-OS2.3,OS2.5]
	[F20-OP2.1,OP2.3,OP2.5] [F22-OP2.3,OP2.5]
	[F20,F22-OH1.1,OH1.2,OH1.3]
<b>9.23.17.1. Required Sheathing</b>	
(1)	[F20-OS2.1,OS2.3,OS2.5] [F22-OS2.3,OS2.5]
	[F20-OP2.1,OP2.3,OP2.5] [F22-OP2.3,OP2.4,OP2.5]
	[F20,F22-OH1.1,OH1.2,OH1.3]
	[F22-OS3.1] Applies to floors and elements that support floors. [F22-OS3.7] Applies to walls, and elements that support walls, that contain doors or windows required for emergency egress.
[F20,F22-OH4] Applies to floors and elements that support floors.	
<b>9.23.17.2. Thickness, Rating and Material Standards</b>	
(1)	[F20-OS2.1,OS2.3,OS2.5] [F22-OS2.3,OS2.5]
	[F20-OP2.1,OP2.3,OP2.5] [F22-OP2.3,OP2.4,OP2.5]
	[F20,F22-OH1.1,OH1.2,OH1.3]
	[F20,F22-OS1.2] Applies to assemblies required to provide fire resistance.
	[F20,F22-OH4] Applies to floors and elements that support floors.
[F20,F22-OS3.1] Applies to floors and elements that support floors.	
<b>9.23.17.4. Lumber Sheathing</b>	
(1)	[F20-OS2.1,OS2.3,OS2.5] [F22-OS2.3,OS2.5]
	[F20-OP2.1,OP2.3,OP2.5] [F22-OP2.3,OP2.4,OP2.5]
	[F20,F22-OH1.1,OH1.2,OH1.3]
	[F20,F22-OS1.2] Applies to assemblies required to provide fire resistance.
	[F20,F22-OH4] Applies to floors and elements that support floors.
[F20,F22-OS3.1] Applies to floors and elements that support floors.	
(2)	[F20-OS2.1,OS2.3,OS2.5] [F22-OS2.3,OS2.5]
	[F20-OP2.1,OP2.3,OP2.5] [F22-OP2.3,OP2.4,OP2.5]
	[F20,F22-OH1.1,OH1.2,OH1.3]
	[F20,F22-OS1.2] Applies to assemblies required to provide fire resistance.
	[F22-OS3.1] Applies to floors and elements that support floors. [F22-OS3.7] Applies to walls, and elements that support walls, that contain doors or windows required for emergency egress.
[F20,F22-OH4] Applies to floors and elements that support floors.	

Table 9.37.1.1. (Continued)

Functional Statements and Objectives <sup>(1)</sup>	
<b>9.23.17.5. Joints in Panel-Type Sheathing</b>	
(1)	[F80,F81-OS2.3]
	[F80,F81-OP2.3,OP2.4]
	[F80,F81-OH1.1,OH1.2,OH1.3]
	[F80,F81-OH4] Applies to floors and elements that support floors.
	[F80,F81-OS3.1] Applies to floors and elements that support floors.
<b>9.24.1.2. Material Standards</b>	
(1)	[F20-OP2.1,OP2.4] [F22,F80-OP2.4] [F20,F22,F80-OP2.3] Applies to elements that support or are part of an environmental separator.
	[F20-OS2.1,OS2.4] [F22,F80-OS2.4] [F20,F22,F80-OS2.3] Applies to elements that support or are part of an environmental separator.
	[F20,F22,F80-OH1.1,OH1.2,OH1.3]
	[F20,F22,F80-OS1.2] Applies to assemblies required to provide fire resistance.
	[F22,F80-OS3.7] Applies to walls, and elements that support walls, that contain doors or windows required for emergency egress.
	[F20,F22,F80-OS1.2] Applies to assemblies required to provide fire resistance.
<b>9.24.1.4. Screws</b>	
(1)	[F20-OP2.1,OP2.4] [F22,F80-OP2.4] [F20,F22,F80-OP2.3] Applies to elements that support or are part of an environmental separator.
	[F20,F22,F80-OS2.1] [F20,F22,F80-OS2.3] Applies to elements that support or are part of an environmental separator.
	[F20,F22,F80-OH1.1,OH1.2,OH1.3]
	[F20,F22,F80-OS1.2] Applies to assemblies required to provide fire resistance.
	[F22,F80-OS3.7] Applies to walls, and elements that support walls, that contain doors or windows required for emergency egress.
<b>9.24.1.5. Cladding, Sheathing and Interior Finish Required</b>	
(1)	[F20,F22,F80-OH1.1,OH1.2,OH1.3]
	[F20,F22,F80-OS2.1] [F20,F22,F80-OS2.3] Applies to elements that support or are part of an environmental separator.
	[F20,F22,F80-OP2.1,OP2.4] [F20,F22,F80-OP2.3] Applies to elements that support or are part of an environmental separator.
	[F20,F22,F80-OS1.2] Applies to assemblies required to provide fire resistance.
	[F22,F80-OS3.7] Applies to walls, and elements that support walls, that contain doors or windows required for emergency egress.

Table 9.37.1.1. (Continued)

Functional Statements and Objectives <sup>(1)</sup>	
<b>9.24.2.1. Size and Spacing of Studs in Interior Walls</b>	
(1)	[F20-OP2.1,OP2.4] [F22-OP2.4]
	[F20-OS2.1,OS2.4] [F22-OS2.4]
	[F22-OS3.7] Applies to walls, and elements that support walls, that contain doors or windows required for emergency egress.
<b>9.24.2.2. Thickness of Studs</b>	
(1)	[F20-OP2.1,OP2.4] [F22-OP2.4]
	[F20-OS2.1,OS2.4] [F22-OS2.4]
	[F22-OS3.7] Applies to walls, and elements that support walls, that contain doors or windows required for emergency egress.
<b>9.24.2.3. Runners</b>	
(1)	[F20,F22-OH1.1,OH1.2,OH1.3]
	[F20-OS2.1,OS2.4] [F22-OS2.4] [F20,F22-OS2.3] Applies to elements that support or are part of an environmental separator.
	[F20-OP2.1,OP2.4] [F22-OP2.4] [F20,F22-OP2.3] Applies to elements that support or are part of an environmental separator.
	[F20,F22-OS1.2] Applies to assemblies required to provide fire resistance.
	[F20,F22-OS1.2] Applies to assemblies required to provide fire resistance.
<b>9.24.2.4. Openings in Fire Separations</b>	
(1)	[F20-OS1.2]
(2)	[F20-OS1.2]
(3)	[F20-OS1.2]
(4)	[F20-OS1.2]
<b>9.24.2.5. Size and Spacing of Studs in Exterior Walls</b>	
(1)	[F20,F22-OH1.1,OH1.2,OH1.3]
	[F20-OS2.1,OS2.3,OS2.4] [F22-OS2.3,OS2.4]
	[F20-OP2.1,OP2.3,OP2.4] [F22-OP2.3,OP2.4]
	[F20,F22-OS1.2] Applies to assemblies required to provide fire resistance.
[F22,F80-OS3.7] Applies to walls, and elements that support walls, that contain doors or windows required for emergency egress.	



Table 9.37.1.1. (Continued)

Functional Statements and Objectives <sup>(1)</sup>	
<b>9.24.3.1. Installation of Runners</b>	
(1)	[F20-OP2.1,OP2.4] [F22-OP2.4] [F20,F22-OP2.3] Applies to elements that support or are part of an environmental separator. [F20,F22-OH1.1,OH1.2,OH1.3] [F20-OS2.1,OS2.4] [F22-OS2.4] [F20,F22-OS2.3] Applies to elements that support or are part of an environmental separator. [F20,F22-OS1.2] Applies to assemblies required to provide fire resistance. [F22,F80-OS3.7] Applies to walls, and elements that support walls, that contain doors or windows required for emergency egress.
(2)	[F20,F22-OH1.1,OH1.2,OH1.3] [F20-OS2.1,OS2.4] [F22-OS2.4] [F20,F22-OS2.3] Applies to elements that support or are part of an environmental separator. [F20-OP2.1,OP2.4] [F22-OP2.4] [F20,F22-OP2.3] Applies to elements that support or are part of an environmental separator. [F20,F22-OS1.2] Applies to assemblies required to provide fire resistance. [F22-OS3.7] Applies to walls, and elements that support walls, that contain doors or windows required for emergency egress.
(3)	[F20,F22-OH1.1,OH1.2,OH1.3] [F20,F22-OS2.1,OS2.4] [F20,F22-OS2.3] Applies to elements that support or are part of an environmental separator. [F20,F22-OP2.1,OP2.4] [F20,F22-OP2.3] Applies to elements that support or are part of an environmental separator. [F20,F22-OS1.2] Applies to assemblies required to provide fire resistance. [F22-OS3.7] Applies to walls, and elements that support walls, that contain doors or windows required for emergency egress.
(4)	[F20,F22-OH1.1,OH1.2,OH1.3] [F20-OS2.1,OS2.4] [F22-OS2.4] [F20,F22-OS2.3] Applies to elements that support or are part of an environmental separator. [F20-OP2.1,OP2.4] [F22-OP2.4] [F20,F22-OP2.3] Applies to elements that support or are part of an environmental separator. [F22-OS3.7] Applies to walls, and elements that support walls, that contain doors or windows required for emergency egress. [F20,F22-OS1.2] Applies to assemblies required to provide fire resistance.

Table 9.37.1.1. (Continued)

Functional Statements and Objectives <sup>(1)</sup>	
<b>9.24.3.2. Fire-Rated Walls</b>	
(1)	[F21-OS1.2]
(2)	[F21-OS1.2]
(3)	[F20-OS1.2]
(4)	[F20-OS1.2]
(5)	[F03-OS1.2]
<b>9.24.3.3. Orientation of Studs</b>	
(1)	[F20,F22-OH1.1,OH1.2,OH1.3] [F20-OS2.1,OS2.4] [F22-OS2.4] [F20,F22-OS2.3] Applies to elements that support or are part of an environmental separator. [F20-OP2.1,OP2.4] [F22-OP2.4] [F20,F22-OP2.3] Applies to elements that support or are part of an environmental separator. [F20,F22-OS1.2] Applies to assemblies required to provide fire resistance. [F22-OS3.7] Applies to walls, and elements that support walls, that contain doors or windows required for emergency egress.
<b>9.24.3.4. Support for Cladding Materials</b>	
(1)	[F20-OH1.1,OH1.2,OH1.3] [F20-OS2.1,OS2.4] [F20-OS2.3] Applies to elements that support or are part of an environmental separator. [F20-OP2.1,OP2.4] [F20-OP2.3] Applies to elements that support or are part of an environmental separator. [F20-OS1.2] Applies to assemblies required to provide fire resistance. [F22-OS3.7] Applies to walls, and elements that support walls, that contain doors or windows required for emergency egress.
<b>9.24.3.5. Framing around Openings</b>	
(1)	[F20,F22-OH1.1,OH1.2,OH1.3] [F20-OS2.1,OS2.4] [F22-OS2.4] [F20,F22-OS2.3] Applies to elements that support or are part of an environmental separator. [F20-OP2.1,OP2.4] [F22-OP2.4] [F20,F22-OP2.3] Applies to elements that support or are part of an environmental separator. [F20,F22-OS1.2] Applies to assemblies required to provide fire resistance. [F22-OS3.7] Applies to walls, and elements that support walls, that contain doors or windows required for emergency egress.

Table 9.37.1.1. (Continued)

Functional Statements and Objectives <sup>(1)</sup>	
(2)	[F20,F22-OH1.1,OH1.2,OH1.3] [F20-OS2.1,OS2.4] [F22-OS2.4] [F20,F22-OS2.3] Applies to elements that support or are part of an environmental separator. [F20-OP2.1,OP2.4] [F22-OP2.4] [F20,F22-OP2.3] Applies to elements that support or are part of an environmental separator. [F20,F22-OS1.2] Applies to assemblies required to provide fire resistance. [F22-OS3.7] Applies to walls, and elements that support walls, that contain doors or windows required for emergency egress.
<b>9.24.3.6. Attachment of Studs to Runners</b>	
(1)	[F20-OS2.1,OS2.4] [F22-OS2.4] [F20,F22-OS2.3] Applies to elements that support or are part of an environmental separator. [F20-OP2.1,OP2.4] [F22-OP2.4] [F20,F22-OP2.3] Applies to elements that support or are part of an environmental separator. [F20,F22-OH1.1,OH1.2,OH1.3] [F20,F22-OS1.2] Applies to assemblies required to provide fire resistance. [F22-OS3.7] Applies to walls, and elements that support walls, that contain doors or windows required for emergency egress.
(2)	[F21-OS1.2]
<b>9.24.3.7. Openings for Fire Dampers</b>	
(1)	[F20-OS1.2]
(2)	[F20-OS1.2]
(3)	[F03-OS1.2]
<b>9.25.1.1. Scope and Application</b>	
(2)	[F51,F63-OH1.1,OH1.2] [F55-OH1.1,OH1.2,OH1.3] [F55,F63-OS2.3]
<b>9.25.2.1. Required Insulation</b>	
(1)	[F51,F63-OH1.1,OH1.2] [F63-OS2.3]
<b>9.25.2.2. Insulation Materials</b>	
(1)	[F51,F63,F80-OH1.1,OH1.2] [F63,F80-OS2.3]
(3)	[F51,F63-OH1.1,OH1.2] [F63-OS2.3]
<b>9.25.2.3. Installation of Thermal Insulation</b>	
(1)	[F51,F63-OH1.1,OH1.2] [F63-OS2.3]
(2)	[F51,F63-OH1.1,OH1.2] [F63-OS2.3]

Table 9.37.1.1. (Continued)

Functional Statements and Objectives <sup>(1)</sup>	
(3)	[F55-OH1.1,OH1.2] [F55-OS2.3]
(4)	[F51,F63,F80-OH1.1,OH1.2] [F63,F80-OS2.3]
(5)	[F21-OH1.1,OH1.2,OH1.3] [F21-OS2.2,OS2.3]
(6)	[F80-OH1.1,OH1.2] [F80-OS2.3]
(7)	[F80-OH1.1,OH1.2] [F80-OS2.3]
(8)	[F21-OH1.1,OH1.2] [F21-OS2.3]
<b>9.25.2.4. Installation of Loose-Fill Insulation</b>	
(1)	[F51,F63-OH1.1,OH1.2] [F63-OS2.3]
(2)	[F51-OH1.1,OH1.2,OH1.3] [F51-OS2.3]
(4)	(a) [F21,F51-OS2.3] (a) [F21,F51-OH1.1,OH1.2] (c) [F81-OS2.1,OS2.3] (c) [F81-OS2.1,OS2.3,OS2.4,OS2.5] Applies where the interior finish provides the required bracing. (c) [F81-OH1.1,OH1.2] (c) [F81-OH1.1,OH1.2,OH1.3] Applies where the interior finish provides the required bracing. (c) [F81-OP2.1,OP2.3,OP2.4,OP2.5] Applies where the interior finish provides to the required bracing. (c) [F81-OP3.1] Applies where the interior finish contributes to the required fire resistance of the wall. (c) [F81-OS3.7] Applies where the interior finish provides the required bracing. (c) [F81-OS3.1] Applies where the interior finish provides the required bracing of walls that support floors. (c) [F81-OH4] Applies where the interior finish provides the required bracing of walls that support floors. (d) [F80-OS2.3] (d) [F80-OH1.1,OH1.2,OH1.3]
(5)	[F51,F63-OH1.1,OH1.2] [F63-OS2.3]
(6)	(a) [F51,F62-OH1.1,OH1.2,OH1.3] (b) [F51,F63-OH1.1,OH1.2] (a) [F62,F51-OS2.3] (b) [F51,F63-OS2.3]
<b>9.25.2.5. Installation of Spray-Applied Polyurethane</b>	
(1)	[F51,F41,F63-OH1.1] [F51,F63-OH1.2] [F63-OS2.3]

Table 9.37.1.1. (Continued)

Functional Statements and Objectives <sup>(1)</sup>	
<b>9.25.3.1. Required Barrier to Air Leakage</b>	
(1)	[F55-OH1.1,OH1.2,OH1.3] [F40-OH1.1]
	[F55-OS2.3]
	[F44-OS1.1] Applies where the <i>air barrier system</i> separates a garage, or <i>suite</i> containing a garage, from residential space.
	[F44-OS3.4] Applies where the <i>air barrier system</i> separates a garage, or <i>suite</i> containing a garage, from residential space.
<b>9.25.3.2. Air Barrier System Properties</b>	
(1)	[F20,F55-OH1.1,OH1.2,OH1.3] [F40-OH1.1]
	[F20,F55-OS2.3]
	[F20,F44-OS1.1] Applies where the <i>air barrier system</i> separates a garage, or <i>suite</i> containing a garage, from residential space.
	[F20,F44-OS3.4] Applies where the <i>air barrier system</i> separates a garage, or <i>suite</i> containing a garage, from residential space.
(2)	[F20,F80,F55-OH1.1,OH1.2,OH1.3] [F40-OH1.1]
	[F20,F80,F55-OS2.3]
	[F20,F80,F44-OS1.1] Applies where the <i>air barrier system</i> separates a garage, or <i>suite</i> containing a garage, from residential space.
	[F20,F80,F44-OS3.4] Applies where the <i>air barrier system</i> separates a garage, or <i>suite</i> containing a garage, from residential space.
<b>9.25.3.3. Continuity of the Air Barrier System</b>	
(1)	[F55-OH1.1,OH1.2,OH1.3] [F40-OH1.1]
	[F55-OS2.3]
	[F44-OS1.1] Applies where the <i>air barrier system</i> separates a garage, or <i>suite</i> containing a garage, from residential space.
	[F44-OS3.4] Applies where the <i>air barrier system</i> separates a garage, or <i>suite</i> containing a garage, from residential space.
(2)	[F55-OH1.1,OH1.2,OH1.3] [F40-OH1.1]
	(a) [F44-OS3.4] Applies where the <i>air barrier system</i> separates a garage, or <i>suite</i> containing a garage, from residential space.
	[F55-OS2.3]
	(a) [F44-OS1.1] Applies where the <i>air barrier system</i> separates a garage, or <i>suite</i> containing a garage, from residential space.
(6)	[F55-OH1.1,OH1.2,OH1.3] [F40-OH1.1]
	[F55-OS2.3]
	[F44-OS1.1] Applies where the <i>air barrier system</i> separates a garage, or <i>suite</i> containing a garage, from residential space.
	[F44-OS3.4] Applies where the <i>air barrier system</i> separates a garage, or <i>suite</i> containing a garage, from residential space.
(7)	[F55-OH1.1,OH1.2,OH1.3] [F40-OH1.1]
	[F55-OS2.3]
(8)	[F01-OS1.1]
<b>9.25.3.4. Air Leakage Control in Masonry Walls</b>	
(1)	[F40-OH1.1]

Table 9.37.1.1. (Continued)

Functional Statements and Objectives <sup>(1)</sup>	
(2)	[F40-OH1.1]
<b>9.25.3.5. Air Leakage Control in Underground Roofs</b>	
(1)	[F40-OH1.1]
<b>9.25.3.6. Air Barrier Systems in Floors-on-ground</b>	
(1)	[F40-OH1.1]
(2)	[F40-OH1.1]
(3)	[F40-OH1.1]
(5)	[F40-OH1.1]
(6)	[F40-OH1.1]
<b>9.25.4.1. Required Barrier to Vapour Diffusion</b>	
(1)	[F63-OH1.1,OH1.2]
	[F63-OS2.3]
<b>9.25.4.2. Vapour Barrier Materials</b>	
(1)	[F63-OS2.3]
	[F63-OH1.1,OH1.2]
(2)	[F62,F63-OS2.3]
	[F62,F63-OH1.1,OH1.2,OH1.3]
(3)	[F63,F80-OS2.3]
	[F63,F80-OH1.1,OH1.2]
(4)	[F63,F80-OS2.3]
	[F63,F80-OH1.1,OH1.2]
(5)	[F63-OS2.3]
	[F63-OH1.1,OH1.2]
(6)	[F63-OS2.3]
	[F63-OH1.1,OH1.2]
<b>9.25.4.3. Installation of Vapour Barriers</b>	
(1)	[F63-OH1.1,OH1.2]
	[F63-OS2.3]
(2)	[F63-OH1.1,OH1.2]
	[F63-OS2.3]
(3)	[F63-OS2.3]
	[F63-OH1.1,OH1.2]
<b>9.25.5.1. General</b>	
(2)	[F62,F63-OS2.3]
	[F62,F63-OH1.1,OH1.2,OH1.3]
<b>9.25.5.2. Position of Low Permeance Materials</b>	
(1)	[F62,F63-OS2.3]
	[F62,F63-OH1.1,OH1.2]
<b>9.26.1.2. Required Protection</b>	
(1)	[F61-OH1.1,OH1.2,OH1.3]
	[F61-OS2.3]

Table 9.37.1.1. (Continued)

Functional Statements and Objectives <sup>(1)</sup>	
<b>9.26.1.3. Alternative Installation Methods</b>	
(1)	[F61-OH1.1,OH1.2,OH1.3] [F61-OS2.3]
<b>9.26.2.1. Material Standards</b>	
(1)	[F61-OH1.1,OH1.2,OH1.3] [F61-OS2.3]
(2)	[F61-OH1.1,OH1.2,OH1.3] [F61-OS2.3]
<b>9.26.2.2. Installation of Materials</b>	
(1)	[F61-OH1.2,OH1.3,OH1.1] [F61-OS2.3]
<b>9.26.2.3. Nails</b>	
(1)	[F20,F80-OH1.1,OH1.2,OH1.3] [F20,F80-OS2.3]
(2)	[F20-OH1.1,OH1.2,OH1.3] [F20-OS2.3]
(3)	[F20-OH1.1,OH1.2,OH1.3] [F20-OS2.3]
(4)	[F20,F80-OH1.1,OH1.2,OH1.3] [F20,F80-OS2.3]
<b>9.26.2.4. Staples</b>	
(1)	[F20,F80-OH1.1,OH1.2,OH1.3] [F20,F80-OS2.3]
(2)	[F20-OH1.1,OH1.2,OH1.3] [F20-OS2.3]
(3)	[F20,F80-OH1.1,OH1.2,OH1.3] [F20,F80-OS2.3]
<b>9.26.3.1. Slope</b>	
(1)	[F20-OS2.1,OS2.3] [F61,F80-OS2.3] [F20,F61,F80-OH1.1,OH1.2,OH1.3]
(2)	[F20,F61,F80-OS2.3] [F20,F61,F80-OH1.1,OH1.2,OH1.3]
(3)	[F61,F80-OS2.3] [F61,F80-OH1.1,OH1.2,OH1.3]
(4)	[F61,F80-OS2.3] [F61,F80-OH1.1,OH1.2,OH1.3]
(5)	[F21-OS2.3] [F21-OH1.1,OH1.2,OH1.3]
<b>9.26.4.1. Required Flashing at Intersections</b>	
(1)	[F61-OS2.3] [F61-OH1.1,OH1.2,OH1.3]

Table 9.37.1.1. (Continued)

Functional Statements and Objectives <sup>(1)</sup>	
<b>9.26.4.2. Materials</b>	
(1)	[F61,F62,F80-OH1.1,OH1.2,OH1.3] [F61,F62,F80-OS2.3]
<b>9.26.4.3. Valley Flashing</b>	
(1)	[F61-OS2.3] [F61-OH1.1,OH1.2,OH1.3]
(2)	[F20-OS2.1,OS2.3] [F22-OS2.3,OS2.4] [F20,F22-OH1.1,OH1.2,OH1.3]
(3)	[F61-OS2.3] [F61-OH1.1,OH1.2,OH1.3]
(4)	[F20,F61,F80-OH1.1,OH1.2,OH1.3] [F20,F61,F80-OS2.3]
(5)	[F20,F61,F80-OH1.1,OH1.2,OH1.3] [F20,F61,F80-OS2.3]
(6)	[F20,F61,F80-OH1.1,OH1.2,OH1.3] [F20,F61,F80-OS2.3]
<b>9.26.4.4. Intersection of Shingle Roofs and Masonry</b>	
(1)	[F61-OH1.1,OH1.2,OH1.3] [F61-OS2.3] [F61-OS1.1] Applies where a shingle roof intersects with a masonry <i>chimney</i> . [F61-OP1.1] Applies where a shingle roof intersects with a masonry <i>chimney</i> . [F61-OS3.4] Applies where a shingle roof intersects with a masonry <i>chimney</i> .
(2)	[F61-OH1.1,OH1.2,OH1.3] [F61-OS2.3] [F61-OS1.1] Applies where counter flashing is installed between a shingle roof and a masonry <i>chimney</i> . [F61-OP1.1] Applies where counter flashing is installed between a shingle roof and a masonry <i>chimney</i> . [F61-OS3.4] Applies where counter flashing is installed between a shingle roof and a masonry <i>chimney</i> .
(3)	[F61-OH1.1,OH1.2,OH1.3] [F61-OS2.3] [F61-OS1.1] Applies where flashing is installed between a shingle roof and a masonry <i>chimney</i> . [F61-OP1.1] Applies where flashing is installed between a shingle roof and a masonry <i>chimney</i> . [F61-OS3.4] Applies where flashing is installed between a shingle roof and a masonry <i>chimney</i> .

**Table 9.37.1.1. (Continued)**

Functional Statements and Objectives <sup>(1)</sup>	
(4)	[F61-OH1.1,OH1.2,OH1.3]
	[F61-OS2.3]
	[F61-OS1.1] Applies where a shingle roof slopes upward from a masonry <i>chimney</i> .
	[F61-OP1.1] Applies where a shingle roof slopes upward from a masonry <i>chimney</i> .
	[F61-OS3.4] Applies where a shingle roof slopes upward from a masonry <i>chimney</i> .
<b>9.26.4.5. Intersection of Shingle Roofs and Walls other than Masonry</b>	
(1)	[F61-OH1.1,OH1.2,OH1.3]
	[F61-OS2.3]
(2)	[F61-OH1.1,OH1.2,OH1.3]
	[F61-OS2.3]
(3)	[F61-OH1.1,OH1.2,OH1.3]
	[F61-OS2.3]
<b>9.26.4.6. Intersection of Built-Up Roofs and Masonry</b>	
(1)	[F61-OH1.1,OH1.2,OH1.3]
	[F61-OS2.3]
	[F61-OS1.1] Applies where a built-up roof intersects with a masonry <i>chimney</i> .
	[F61-OP1.1] Applies where a built-up roof intersects with a masonry <i>chimney</i> .
	[F61-OS3.4] Applies where a built-up roof intersects with a masonry <i>chimney</i> .
(2)	[F61-OH1.1,OH1.2,OH1.3]
	[F61-OS2.3]
	[F61-OS1.1] Applies where counter flashing is installed between a built-up roof and a masonry <i>chimney</i> .
	[F61-OP1.1] Applies where counter flashing is installed between a built-up roof and a masonry <i>chimney</i> .
	[F61-OS3.4] Applies where counter flashing is installed between a built-up roof and a masonry <i>chimney</i> .
<b>9.26.4.7. Intersection of Built-Up Roofs and Walls other than Masonry</b>	
(1)	[F61-OH1.1,OH1.2,OH1.3]
	[F61-OS2.3]
(2)	[F61-OH1.1,OH1.2,OH1.3]
	[F61-OS2.3]
(3)	[F61-OH1.1,OH1.2,OH1.3]
	[F61-OS2.3]
<b>9.26.4.8. Chimney Saddles</b>	
(1)	[F61-OH1.1,OH1.2,OH1.3]
	[F61-OS2.3]
	[F61-OS1.1]
	[F61-OP1.1]
	[F61-OS3.4]

**Table 9.37.1.1. (Continued)**

Functional Statements and Objectives <sup>(1)</sup>	
(2)	[F20,F81-OH1.1,OH1.2,OH1.3]
	[F20,F81-OS2.3]
	[F20,F81-OS1.1]
	[F20,F81-OP1.1]
	[F20,F81-OS3.4]
(3)	[F61-OH1.1,OH1.2,OH1.3]
	[F61-OS2.3]
(5)	[F61-OH1.1,OH1.2,OH1.3]
	[F61-OS2.3]
	[F61-OS1.1]
	[F61-OP1.1]
	[F61-OS3.4]
<b>9.26.5.1. Required Eave Protection</b>	
(1)	[F61-OH1.1,OH1.2,OH1.3]
	[F61-OS2.3]
<b>9.26.5.2. Materials</b>	
(1)	[F61-OH1.1,OH1.2,OH1.3]
	[F61-OS2.3]
<b>9.26.6.1. Materials</b>	
(1)	[F61-OH1.1,OH1.2,OH1.3]
	[F61-OS2.3]
(2)	[F62-OH1.1,OH1.2,OH1.3]
	[F62-OS2.3]
<b>9.26.6.2. Installation</b>	
(1)	[F61-OH1.1,OH1.2,OH1.3]
	[F61-OS2.3]
(2)	[F61-OH1.1,OH1.2,OH1.3]
	[F61-OS2.3]
(3)	[F61-OH1.1,OH1.2,OH1.3]
	[F61-OS2.3]
<b>9.26.7.1. Coverage</b>	
(1)	[F61,F80-OH1.1,OH1.2,OH1.3]
	[F61,F80-OS2.1]
<b>9.26.7.2. Starter Strip</b>	
(1)	[F61-OH1.1,OH1.2,OH1.3]
	[F61-OS2.3]
(2)	[F61,F80-OH1.1,OH1.2,OH1.3]
	[F61,F80-OS2.3]
(3)	[F61-OH1.1,OH1.2,OH1.3]
	[F61-OS2.3]
<b>9.26.7.3. Head Lap</b>	
(1)	[F61-OH1.1,OH1.2,OH1.3]
	[F61-OS2.3]

Table 9.37.1.1. (Continued)

Functional Statements and Objectives <sup>(1)</sup>	
<b>9.26.7.4. Fasteners</b>	
(1)	[F20,F61-OH1.1,OH1.2,OH1.3]
	[F20,F61-OS2.3]
(2)	[F20-OH1.1,OH1.2,OH1.3]
	[F20-OS2.3]
(3)	[F20-OH1.1,OH1.2,OH1.3]
	[F20-OS2.3]
(4)	[F20-OH1.1,OH1.2,OH1.3]
	[F20-OS2.3]
(5)	[F20-OH1.1,OH1.2,OH1.3]
	[F20-OS2.3]
<b>9.26.7.5. Securing of Tabs</b>	
(1)	[F20,F61-OH1.1,OH1.2,OH1.3]
	[F20,F61-OS2.3]
<b>9.26.7.6. Hips and Ridges</b>	
(1)	[F61-OH1.1,OH1.2,OH1.3]
	[F61-OS2.3]
(2)	[F20-OH1.1,OH1.2,OH1.3]
	[F20-OS2.3]
<b>9.26.8.1. Coverage</b>	
(1)	[F61-OH1.1,OH1.2,OH1.3]
	[F61-OS2.3]
<b>9.26.8.2. Starter Strip</b>	
(2)	[F61-OH1.1,OH1.2,OH1.3]
	[F61-OS2.3]
<b>9.26.8.3. Securing of Tabs</b>	
(1)	[F61-OH1.1,OH1.2,OH1.3]
	[F61-OS2.3]
<b>9.26.8.4. Securing of Shingle Courses</b>	
(1)	[F61-OH1.1,OH1.2,OH1.3]
	[F61-OS2.3]
(2)	[F61-OH1.1,OH1.2,OH1.3]
	[F61-OS2.3]
(3)	[F61-OS2.3]
	[F61-OH1.1,OH1.2,OH1.3]
<b>9.26.8.5. Hips and Ridges</b>	
(1)	[F61-OH1.1,OH1.2,OH1.3]
	[F61-OS2.3]
(2)	[F61,F80-OS2.3]
	[F61,F80-OH1.1,OH1.2,OH1.3]
<b>9.26.9.2. Grade</b>	
(1)	[F61-OH1.1,OH1.2,OH1.3]
	[F61-OS2.3]

Table 9.37.1.1. (Continued)

Functional Statements and Objectives <sup>(1)</sup>	
(2)	[F61-OH1.1,OH1.2,OH1.3]
	[F61-OS2.3]
<b>9.26.9.3. Size</b>	
(1)	[F61-OH1.1,OH1.2,OH1.3]
	[F61-OS2.3]
<b>9.26.9.4. Spacing and Joints</b>	
(1)	[F61-OH1.1,OH1.2,OH1.3]
	[F61-OS2.3]
<b>9.26.9.5. Fastening</b>	
(1)	[F20,F80-OH1.1,OH1.2,OH1.3]
	[F20,F80-OS2.3]
<b>9.26.9.6. Exposure</b>	
(1)	[F61-OH1.1,OH1.2,OH1.3]
	[F61-OS2.3]
<b>9.26.10.1. Size and Thickness</b>	
(1)	[F61-OH1.1,OH1.2,OH1.3]
	[F61-OS2.3]
<b>9.26.10.2. Underlay</b>	
(1)	[F61-OH1.1,OH1.2,OH1.3]
	[F61-OS2.3]
(2)	[F61-OH1.1,OH1.2,OH1.3]
	[F61-OS2.3]
(3)	[F61-OH1.1,OH1.2,OH1.3]
	[F61-OS2.3]
<b>9.26.10.3. Spacing and Joints</b>	
(1)	[F61-OH1.1,OH1.2,OH1.3]
	[F61-OS2.3]
<b>9.26.10.4. Fastening</b>	
(1)	[F20,F80-OH1.1,OH1.2,OH1.3]
	[F20,F80-OS2.3]
<b>9.26.10.5. Exposure</b>	
(1)	[F61-OH1.1,OH1.2,OH1.3]
	[F61-OS2.3]
<b>9.26.10.8. Grade</b>	
(1)	[F61-OH1.1,OH1.2,OH1.3]
	[F61-OS2.3]
<b>9.26.11.1. Quantity of Materials</b>	
(1)	[F61-OH1.1,OH1.2,OH1.3]
	[F61-OS2.3]
<b>9.26.11.2. Coal-Tar and Asphalt Products</b>	
(1)	[F61,F80-OH1.1,OH1.2,OH1.3]
	[F61,F80-OS2.3]

**Table 9.37.1.1. (Continued)**

Functional Statements and Objectives <sup>(1)</sup>	
<b>9.26.11.3. Roof Felts</b>	
(1)	[F20-OH1.1,OH1.2,OH1.3] [F20-OS2.3]
<b>9.26.11.4. Aggregate Surfacing</b>	
(1)	[F61-OH1.1,OH1.2,OH1.3] [F61-OS2.3]
(2)	[F61-OH1.1,OH1.2,OH1.3] [F61-OS2.3]
<b>9.26.11.6. Number of Layers</b>	
(1)	[F20,F80-OH1.1,OH1.2,OH1.3] [F20,F80-OS2.3]
<b>9.26.11.7. Installation of Layers</b>	
(1)	[F20-OH1.1,OH1.2,OH1.3] [F20-OS2.3]
(2)	[F61,F81-OH1.1,OH1.2,OH1.3] [F61,F81-OS2.3]
(3)	[F20-OH1.1,OH1.2,OH1.3] [F20-OS2.3]
<b>9.26.11.8. Roofing over Wood-Based Sheathing</b>	
(1)	[F61-OH1.1,OH1.2,OH1.3] [F61-OS2.3]
(2)	[F61-OH1.1,OH1.2,OH1.3] [F61-OS2.3]
<b>9.26.11.9. Attachment to Decking</b>	
(1)	[F61-OH1.1,OH1.2,OH1.3] [F61-OS2.3]
<b>9.26.11.10. Cant Strips</b>	
(1)	[F61-OH1.1,OH1.2,OH1.3] [F61-OS2.3] [F61-OS3.1]
(2)	[F61-OH1.1,OH1.2,OH1.3] [F61-OS2.3]
(3)	[F61-OH1.1,OH1.2,OH1.3] [F61-OS2.3]
(4)	[F61-OH1.1,OH1.2,OH1.3] [F61-OS2.3] [F61-OS3.1]
(5)	[F61-OH1.1,OH1.2,OH1.3] [F61-OS2.3]
(6)	[F61-OH1.1,OH1.2,OH1.3] [F61-OS2.3]

**Table 9.37.1.1. (Continued)**

Functional Statements and Objectives <sup>(1)</sup>	
<b>9.26.12.1. Coverage</b>	
(1)	[F61,F80-OH1.1,OH1.2,OH1.3] [F61,F80-OS2.3]
<b>9.26.12.2. Joints</b>	
(1)	[F61-OH1.1,OH1.2,OH1.3] [F61-OS2.3]
<b>9.26.13.1. Thickness</b>	
(1)	[F61,F80-OH1.1,OH1.2,OH1.3] [F61,F80-OS2.3]
<b>9.26.13.2. Support</b>	
(1)	[F20-OS2.1,OS2.3] [F22-OS2.3,OS2.4] [F20-OP2.1,OP2.3] [F22-OP2.3,OP2.4] [F20,F22-OH1.1,OH1.2,OH1.3]
<b>9.26.14.1. Support</b>	
(1)	[F20,F22-OH1.1,OH1.2,OH1.3] [F20-OS2.1,OS2.3] [F22-OS2.3,OS2.4] [F20-OP2.1,OP2.3] [F22-OP2.3,OP2.4]
<b>9.26.15.1. Installation</b>	
(1)	[F61,F80-OH1.1,OH1.2,OH1.3] [F61,F80-OS2.3]
<b>9.26.16.1. Installation</b>	
(1)	[F61,F80-OH1.1,OH1.2,OH1.3] [F61,F80-OS2.3]
<b>9.26.17.1. Installation</b>	
(1)	[F61-OH1.1,OH1.2,OH1.3] [F61-OS2.3]
<b>9.26.18.2. Downspouts</b>	
(1)	[F61-OH1.1,OH1.2,OH1.3] [F61-OS2.3]
<b>9.27.2.1. Minimizing and Preventing Ingress and Damage</b>	
(1)	[F61-OS2.3] [F61-OH1.1,OH1.2,OH1.3]
(2)	[F80,F81-OS2.3] [F80,F81-OH1.1,OH1.2,OH1.3]
<b>9.27.2.2. Minimum Protection from Precipitation Ingress</b>	
(3)	[F62-OS2.3] [F62-OH1.1,OH1.2,OH1.3]
(4)	[F61,F62-OS2.3] [F61,F62-OH1.1,OH1.2,OH1.3]
(5)	[F61,F62-OS2.3] [F61,F62-OH1.1,OH1.2,OH1.3]

Copyright © NRC 1941 - 2021 World Rights Reserved © CNRC 1941-2021 Droits réservés pour tous pays

Table 9.37.1.1. (Continued)

Functional Statements and Objectives <sup>(1)</sup>	
<b>9.27.2.3. First and Second Planes of Protection</b>	
(1)	[F61,F62-OS2.3] [F61,F62-OH1.1,OH1.2,OH1.3]
<b>9.27.2.4. Protection of Cladding from Moisture</b>	
(1)	[F61,F80-OS2.3] [F61,F80-OH1.1,OH1.2,OH1.3]
(2)	[F61,F80-OS2.3] [F61-OH1.1,OH1.2,OH1.3]
<b>9.27.3.1. Elements of the Second Plane of Protection</b>	
(1)	[F61,F62-OS2.3] [F61,F62-OH1.1,OH1.2,OH1.3]
(3)	[F61,F62-OS2.3] [F61,F62-OH1.1,OH1.2,OH1.3]
<b>9.27.3.2. Sheathing Membrane Material Standard</b>	
(1)	[F20,F61,F62,F55-OS2.3] [F20,F61,F62,F55-OH1.1,OH1.2,OH1.3]
<b>9.27.3.3. Required Sheathing Membrane and Installation</b>	
(1)	[F61,F55-OS2.3] [F61,F55-OH1.1,OH1.2,OH1.3]
(2)	[F61,F55-OS2.3] [F61,F55-OH1.1,OH1.2,OH1.3]
(3)	[F61-OS2.3] [F61-OH1.1,OH1.2,OH1.3]
<b>9.27.3.4. Insulating Sheathing in lieu of Sheathing Membrane</b>	
(2)	[F61,F55-OS2.3] [F61,F55-OH1.1,OH1.2,OH1.3]
<b>9.27.3.5. Sheathing Membranes in lieu of Sheathing</b>	
(1)	[F61,F55-OS2.3] [F61,F55-OH1.1,OH1.2,OH1.3]
(2)	[F61,F55-OS2.3] [F61,F55-OH1.1,OH1.2,OH1.3]
<b>9.27.3.6. Face Sealed Cladding</b>	
(2)	[F20,F61,F55-OS2.3] [F20,F61,F55-OH1.1,OH1.2,OH1.3]
(3)	[F61,F55-OS2.3] [F61,F55-OH1.1,OH1.2,OH1.3]
<b>9.27.3.7. Flashing Materials</b>	
(1)	[F61,F62,F80-OS2.3] [F61,F62,F80-OH1.1,OH1.2,OH1.3]

Table 9.37.1.1. (Continued)

Functional Statements and Objectives <sup>(1)</sup>	
<b>9.27.3.8. Flashing Installation</b>	
(1)	(a),(b),(c)(i) [F61-OS2.3] (a),(b),(c)(i) [F61-OH1.1,OH1.2,OH1.3] (c)(ii) [F61,F62-OS2.3] (c)(ii) [F61,F62-OH1.1,OH1.2,OH1.3]
(2)	(a),(b)(ii),(c)(i) [F61-OS2.3] Applies to detailing of horizontal joints. (a),(b)(ii),(c)(i) [F61-OH1.1,OH1.2,OH1.3] Applies to detailing of horizontal joints. (b)(i),(c)(ii) [F61,F62-OS2.3] Applies to cladding installed outboard of a drained and vented air space. (b)(i), (c)(ii) [F61,F62-OH1.1,OH1.2,OH1.3] Applies to cladding installed outboard of a drained and vented air space.
(3)	[F61,F62-OS2.3] [F61,F62-OH1.1,OH1.2,OH1.3]
(4)	[F61,F62-OS2.3] [F61,F62-OH1.1,OH1.2,OH1.3]
(5)	[F61,F62-OS2.3] [F61,F62-OH1.1,OH1.2,OH1.3]
<b>9.27.4.1. Required Sealants</b>	
(1)	[F61-OH1.1,OH1.2,OH1.3] [F61-OS2.3]
(2)	[F61-OH1.1,OH1.2,OH1.3] [F61-OS2.3]
(3)	[F61-OH1.1,OH1.2,OH1.3] [F61-OS2.3]
<b>9.27.4.2. Materials</b>	
(1)	[F80-OH1.1,OH1.2,OH1.3] [F80-OS2.3]
(2)	[F80-OH1.1,OH1.2,OH1.3] [F80-OS2.3]
(3)	[F80-OH1.1,OH1.2,OH1.3] [F80-OS2.3]



**Table 9.37.1.1. (Continued)**

Functional Statements and Objectives <sup>(1)</sup>	
<b>9.27.5.1. Attachment</b>	
(1)	[F20-OS2.1,OS2.3] [F20-OS2.1,OS2.3,OS2.4] [F22-OS2.3,OS2.4,OS2.5] Applies where panel-type cladding is installed to provide the required bracing.
	[F20-OP2.1,OP2.3,OP2.4] [F22-OP2.3,OP2.4,OP2.5] Applies where panel-type cladding is installed to provide the required bracing.
	[F20-OH1.1,OH1.2,OH1.3] [F20,F22-OH1.1,OH1.2,OH1.3] Applies where panel-type cladding is installed to provide the required bracing.
	[F20,F22-OH4] Applies where panel-type cladding is installed to provide the required bracing of walls that support floors.
	[F20,F22-OS3.1] Applies where panel-type cladding is installed to provide the required bracing of walls that support floors. [F20,F22-OS3.7] Applies where panel-type cladding is installed to provide required bracing of walls that contain doors or windows required for emergency egress.
(2)	[F20-OH1.1,OH1.2,OH1.3]
	[F20-OS2.1,OS2.3]
(3)	[F20-OH1.1,OH1.2,OH1.3]
	[F20-OS2.3]
(4)	[F20-OH1.1,OH1.2,OH1.3]
	[F20-OS2.1,OS2.3]
(5)	[F20-OH1.1,OH1.2,OH1.3]
	[F20-OS2.1,OS2.3]
(6)	[F20-OH1.1,OH1.2,OH1.3]
	[F20-OS2.1,OS2.3]
<b>9.27.5.2. Blocking</b>	
(1)	[F20-OH1.1,OH1.2,OH1.3] [F20,F22-OH1.1,OH1.2,OH1.3] Applies where panel-type cladding is installed to provide the required bracing.
	[F20-OS2.1,OS2.3] [F20-OS2.1,OS2.3,OS2.4] [F22-OS2.3,OS2.4,OS2.5] Applies where panel-type cladding is installed to provide the required bracing.
	[F20-OP2.1,OP2.3,OP2.4] [F22-OP2.3,OP2.4,OP2.5] Applies where panel-type cladding is installed to provide the required bracing.
<b>9.27.5.3. Furring</b>	
(1)	[F20-OH1.1,OH1.2,OH1.3]
	[F20-OS2.1,OS2.3] [F20-OS2.1,OS2.3,OS2.4] [F22-OS2.3,OS2.4,OS2.5] Applies where furring is used for the attachment of panel-type cladding installed to provide the required bracing.

**Table 9.37.1.1. (Continued)**

Functional Statements and Objectives <sup>(1)</sup>	
(2)	[F20-OH1.1,OH1.2,OH1.3] [F20,F22-OH1.1,OH1.2,OH1.3] Applies where furring is used for the attachment of panel-type cladding installed to provide the required bracing.
	[F20-OS2.1,OS2.3] [F20-OS2.1,OS2.3,OS2.4] [F22-OS2.3,OS2.4,OS2.5] Applies where furring is used for the attachment of panel-type cladding installed to provide the required bracing.
(3)	[F20-OH1.1,OH1.2,OH1.3] [F20,F22-OH1.1,OH1.2,OH1.3] Applies where furring is used for the attachment of panel-type cladding installed to provide the required bracing.
	[F20-OS2.1,OS2.3] [F20-OS2.1,OS2.3,OS2.4] [F22-OS2.3,OS2.4,OS2.5] Applies where furring is used for the attachment of panel-type cladding installed to provide the required bracing.
<b>9.27.5.4. Size and Spacing of Fasteners</b>	
(1)	[F20-OH1.1,OH1.2,OH1.3] [F20,F22-OH1.1,OH1.2,OH1.3] Applies to the attachment of panel-type cladding installed to provide the required bracing.
	[F20-OS2.1,OS2.3] [F20-OS2.1,OS2.3,OS2.4] [F22-OS2.3,OS2.4,OS2.5] Applies where panel-type cladding is installed to provide the required bracing.
<b>9.27.5.5. Fastener Materials</b>	
(1)	[F80-OH1.1,OH1.2,OH1.3] [F80-OS2.3] [F80-OS2.3,OS2.4] Applies where panel-type cladding is installed to provide the required bracing.
	[F80-OP2.1,OP2.3,OP2.4,OP2.5] Applies where panel-type cladding is installed to provide the required bracing.
<b>9.27.5.6. Expansion and Contraction</b>	
(1)	[F21-OH1.1,OH1.2,OH1.3]
	[F21-OS2.3]
<b>9.27.5.7. Penetration of Fasteners</b>	
(1)	[F20-OH1.1,OH1.2,OH1.3]
	[F20-OS2.1,OS2.3]
(2)	[F20-OH1.1,OH1.2,OH1.3] [F20,F22-OH1.1,OH1.2,OH1.3] Applies where panel-type cladding is installed to provide the required bracing.
	[F20-OS2.1,OS2.3] [F20-OS2.1,OS2.3,OS2.4] [F22-OS2.3,OS2.4,OS2.5] Applies where panel-type cladding is installed to provide the required bracing.
	[F20-OP2.1,OP2.3,OP2.4] [F22-OP2.3,OP2.4,OP2.5] Applies where panel-type cladding is installed to provide the required bracing.
<b>9.27.6.1. Materials</b>	
(1)	[F61,F20-OH1.1,OH1.2,OH1.3]
	[F62,F20-OS2.3]

Table 9.37.1.1. (Continued)

Functional Statements and Objectives <sup>(1)</sup>	
<b>9.27.6.2. Thickness and Width</b>	
(1)	[F20-OH1.1,OH1.2,OH1.3]
	[F20-OS2.3]
(2)	[F20-OH1.1,OH1.2,OH1.3]
	[F20-OS2.3]
(3)	[F20-OH1.1,OH1.2,OH1.3]
	[F20-OS2.3]
<b>9.27.6.3. Joints</b>	
(1)	[F61-OH1.1,OH1.2,OH1.3]
	[F61-OS2.3]
(2)	[F21,F61-OH1.1,OH1.2,OH1.3]
	[F21,F61-OS2.3]
<b>9.27.7.1. Materials</b>	
(1)	[F61-OH1.1,OH1.2,OH1.3]
	[F61-OS2.3]
(2)	[F61,F20-OH1.1,OH1.2,OH1.3]
	[F61,F20-OS2.3]
(3)	[F61,F20-OH1.1,OH1.2,OH1.3]
	[F61,F20-OS2.3]
<b>9.27.7.2. Width</b>	
(1)	[F61,F20-OH1.1,OH1.2,OH1.3]
	[F61,F20-OS2.3]
<b>9.27.7.3. Fasteners</b>	
(1)	[F61,F20-OH1.1,OH1.2,OH1.3]
	[F61,F20-OS2.3]
<b>9.27.7.4. Offsetting of Joints</b>	
(1)	[F61-OH1.1,OH1.2,OH1.3]
	[F61-OS2.3]
(2)	[F61-OH1.1,OH1.2,OH1.3]
	[F61-OS2.3]
<b>9.27.7.5. Fastening to Lath</b>	
(1)	[F81-OH1.1,OH1.2,OH1.3]
	[F81-OS2.3]
(2)	[F62-OH1.1,OH1.2,OH1.3]
	[F62-OS2.3]
(3)	[F20-OH1.1,OH1.2,OH1.3]
	[F20-OS2.3]
(4)	[F20-OH1.1,OH1.2,OH1.3]
	[F20-OS2.3]
(5)	[F62-OH1.1,OH1.2,OH1.3]
	[F62-OS2.3]

Table 9.37.1.1. (Continued)

Functional Statements and Objectives <sup>(1)</sup>	
<b>9.27.7.6. Exposure and Thickness</b>	
(1)	[F62,F20-OH1.1,OH1.2,OH1.3]
	[F62,F20-OS2.3]
<b>9.27.8.1. Material Standards</b>	
(1)	[F20,F22-OH1.1,OH1.2,OH1.3]
	[F20-OS2.1,OS2.3] [F20-OS2.1,OS2.3,OS2.4] [F22-OS2.3,OS2.4,OS2.5] Applies where panel-type cladding is installed to provide the required bracing.
	[F20-OP2.1,OP2.3,OP2.4] [F22-OP2.3,OP2.4,OP2.5] Applies where panel-type cladding is installed to provide the required bracing.
<b>9.27.8.2. Thickness</b>	
(1)	[F20,F22-OH1.1,OH1.2,OH1.3]
	[F20,F22-OS2.1,OS2.3] [F20-OS2.1,OS2.3,OS2.4] [F22-OS2.3,OS2.4,OS2.5] Applies where panel-type cladding is installed to provide the required bracing.
	[F20,F22-OH1.1,OH1.2,OH1.3]
(2)	[F20,F22-OH1.1,OH1.2,OH1.3]
	[F20-OS2.1,OS2.3] [F20-OS2.1,OS2.3,OS2.4] [F22-OS2.3,OS2.4,OS2.5] Applies where panel-type cladding is installed to provide the required bracing.
	[F20-OP2.1,OP2.3] [F22-OP2.3,OP2.4,OP2.5] Applies where panel-type cladding is installed to provide the required bracing.
<b>9.27.8.3. Edge Treatment</b>	
(1)	[F61-OH1.1,OH1.2,OH1.3]
	[F61-OS2.3] [F61-OS2.3,OS2.4,OS2.5] Applies where panel-type cladding is installed to provide the required bracing.
	[F61-OP2.3,OP2.4,OP2.5] Applies where panel-type cladding is installed to provide the required bracing.
<b>9.27.8.4. Panel Cladding</b>	
(1)	[F20,F22-OH1.1,OH1.2,OH1.3]
	[F20,F22-OS2.1,OS2.3] [F20-OS2.1,OS2.3,OS2.4] [F22-OS2.3,OS2.4,OS2.5] Applies where panel-type cladding is installed to provide the required bracing.
	[F20-OP2.1,OP2.3,OP2.4] [F22-OP2.3,OP2.4,OP2.5] Applies where panel-type cladding is installed to provide the required bracing.
(2)	[F21-OH1.1,OH1.2,OH1.3]
	[F21-OS2.3]
(3)	[F61-OH1.1,OH1.2,OH1.3]
	[F61-OS2.3]
(4)	[F61-OH1.1,OH1.2,OH1.3]
	[F61-OS2.3]

Table 9.37.1.1. (Continued)

Functional Statements and Objectives <sup>(1)</sup>	
<b>9.27.8.5. Lapped Strip Siding</b>	
(1)	[F21,F61-OH1.1,OH1.2,OH1.3]
	[F21,F61-OS2.3]
(2)	[F61-OH1.1,OH1.2,OH1.3]
	[F61-OS2.3]
(3)	[F61-OH1.1,OH1.2,OH1.3]
	[F61-OS2.3]
<b>9.27.9.1. Material Standards</b>	
(1)	[F20,F22-OH1.1,OH1.2,OH1.3]
	[F20-OS2.1,OS2.3] [F20-OS2.1,OS2.3,OS2.4] [F22-OS2.3,OS2.4,OS2.5] Applies where panel-type cladding is installed to provide the required bracing.
(2)	[F20,F22-OH1.1,OH1.2,OH1.3]
	[F20-OS2.1,OS2.3] [F22-OS2.3,OS2.4,OS2.5] Applies where panel-type cladding is installed to provide the required bracing.
<b>9.27.9.2. Thickness</b>	
(1)	[F20,F22-OH1.1,OH1.2,OH1.3]
	[F20,F22-OS2.1,OS2.3] [F20-OS2.1,OS2.3,OS2.4] [F22-OS2.3,OS2.4,OS2.5] Applies where panel-type cladding is installed to provide the required bracing.
	[F20-OP2.1,OP2.3,OP2.4] [F22-OP2.3,OP2.4,OP2.5] Applies where panel-type cladding is installed to provide the required bracing.
(2)	[F20,F22-OH1.1,OH1.2,OH1.3]
	[F20,F22-OS2.1,OS2.3] [F20-OS2.1,OS2.3,OS2.4] [F22-OS2.3,OS2.4,OS2.5] Applies where panel-type cladding is installed to provide the required bracing.
(3)	[F20,F22-OH1.1,OH1.2,OH1.3]
	[F20,F22-OS2.1,OS2.3] [F20-OS2.1,OS2.3,OS2.4] [F22-OS2.3,OS2.4,OS2.5] Applies where panel-type cladding is installed to provide the required bracing.
	[F20-OP2.1,OP2.3,OP2.4] [F22-OP2.3,OP2.4,OP2.5] Applies where panel-type cladding is installed to provide the required bracing.
<b>9.27.9.3. Panel Cladding</b>	
(1)	[F20,F21,F22-OH1.1,OH1.2,OH1.3]
	[F20,F21,F22-OS2.1,OS2.3] [F20-OS2.1,OS2.3,OS2.4] [F22-OS2.3,OS2.4,OS2.5] Applies where panel-type cladding is installed to provide the required bracing.
	[F20-OP2.1,OP2.3,OP2.4] [F22-OP2.3,OP2.4,OP2.5] Applies where panel-type cladding is installed to provide the required bracing.
(2)	[F61-OH1.1,OH1.2,OH1.3]
	[F61-OS2.3]

Table 9.37.1.1. (Continued)

Functional Statements and Objectives <sup>(1)</sup>	
(3)	[F61-OH1.1,OH1.2,OH1.3]
	[F61-OS2.3]
<b>9.27.9.4. Lapped Strip Siding</b>	
(1)	[F61-OH1.1,OH1.2,OH1.3]
	[F61-OS2.3]
(2)	[F61-OH1.1,OH1.2,OH1.3]
	[F61-OS2.3]
<b>9.27.9.5. Clearance</b>	
(1)	[F21-OH1.1,OH1.2,OH1.3]
	[F21-OS2.1,OS2.3] [F21-OS2.1,OS2.3,OS2.4,OS2.5] Applies where panel-type cladding is installed to provide the required bracing.
	[F21-OP2.1,OP2.3,OP2.4,OP2.5] Applies where panel-type cladding is installed to provide the required bracing.
<b>9.27.10.1. Material Standard</b>	
(1)	[F20,F22-OH1.1,OH1.2,OH1.3]
	[F20-OS2.1,OS2.3] [F20-OS2.1,OS2.3,OS2.4] [F22-OS2.3,OS2.4,OS2.5] Applies where panel-type cladding is installed to provide the required bracing.
<b>9.27.10.2. Thickness</b>	
(1)	[F20,F22-OH1.1,OH1.2,OH1.3]
	[F20,F22-OS2.1,OS2.3] [F20-OS2.1,OS2.3,OS2.4] [F22-OS2.3,OS2.4,OS2.5] Applies where panel-type cladding is installed to provide the required bracing.
(2)	[F20,F22-OH1.1,OH1.2,OH1.3]
	[F20,F22-OS2.1,OS2.3] [F20-OS2.1,OS2.3,OS2.4] [F22-OS2.3,OS2.4,OS2.5] Applies where panel-type cladding is installed to provide the required bracing.
(3)	[F20,F22-OH1.1,OH1.2,OH1.3]
	[F20,F22-OS2.1,OS2.3] [F20-OS2.1,OS2.3,OS2.4] [F22-OS2.3,OS2.4,OS2.5] Applies where panel-type cladding is installed to provide the required bracing.
(4)	[F20,F22-OH1.1,OH1.2,OH1.3]
	[F20,F22-OS2.1,OS2.3] [F20-OS2.1,OS2.3,OS2.4] [F22-OS2.3,OS2.4,OS2.5] Applies where panel-type cladding is installed to provide the required bracing.
	[F20-OP2.1,OP2.3,OP2.4] [F22-OP2.3,OP2.4,OP2.5] Applies where panel-type cladding is installed to provide the required bracing.

Table 9.37.1.1. (Continued)

Functional Statements and Objectives <sup>(1)</sup>	
<b>9.27.10.3. Panel Cladding</b>	
(1)	[F20,F22,F80-OH1.1,OH1.2,OH1.3] [F20,F22,F80-OS2.1,OS2.3] [F20,F80-OS2.1,OS2.3,OS2.4][F22,F80-OS2.3,OS2.4,OS2.5] Applies where panel-type cladding is installed to provide the required bracing.
(2)	[F21-OH1.1,OH1.2,OH1.3] [F21-OS2.3]
(3)	[F61-OH1.1,OH1.2,OH1.3] [F61-OS2.3]
(4)	[F61-OH1.1,OH1.2,OH1.3] [F61-OS2.3]
<b>9.27.10.4. Clearance</b>	
(1)	[F21-OH1.1,OH1.2,OH1.3] [F21-OS2.1,OS2.3] [F21-OS2.1,OS2.3,OS2.4,OS2.5] Applies where panel-type cladding is installed to provide the required bracing. [F21-OP2.1,OP2.3,OP2.4,OP2.5] Applies where panel-type cladding is installed to provide the required bracing.
<b>9.27.11.1. Material Standards</b>	
(1)	[F20,F22,F61,F62-OH1.1,OH1.2,OH1.3] [F20-OS2.1,OS2.3][F22,F61,F62-OS2.3]
(2)	[F20,F22,F61-OH1.1,OH1.2,OH1.3] [F20-OS2.1,OS2.3][F22,F61-OS2.3] [F20-OS2.1,OS2.3,OS2.4][F22-OS2.3,OS2.4,OS2.5] Applies where panel-type cladding is installed to provide the required bracing.
(3)	[F20,F22,F61-OH1.1,OH1.2,OH1.3] [F20-OS2.1,OS2.3][F22,F61-OS2.3]
(4)	[F20,F22,F61-OH1.1,OH1.2,OH1.3] [F20-OS2.1,OS2.3][F22,F61-OS2.3] [F20-OS2.1,OS2.3,OS2.4][F22-OS2.3,OS2.4,OS2.5] Applies where panel-type cladding is installed to provide the required bracing.
<b>9.27.12.1. Material Standard</b>	
(1)	[F62,F61,F20-OH1.1,OH1.2,OH1.3] [F62,F61,F20-OS2.3]
<b>9.27.13.1. Application</b>	
(1)	[F61,F62-OH1.1,OH1.2,OH1.3] [F61,F62-OS2.3]
<b>9.27.13.2. Materials</b>	
(1)	[F20,F61,F62-OH1.1,OH1.2,OH1.3] [F20,F61,F62-OS2.3]
(2)	[F20,F22-OH1.1,OH1.2,OH1.3] [F20,F22-OS2.3]

Table 9.37.1.1. (Continued)

Functional Statements and Objectives <sup>(1)</sup>	
<b>9.27.13.3. Design and Installation</b>	
(1)	[F20,F61,F62-OH1.1,OH1.2,OH1.3] [F20,F61,F62-OS2.3]
<b>9.28.1.1. Sheathing beneath Stucco</b>	
(1)	[F20,F22-OH1.1,OH1.2,OH1.3] [F20,F22-OS2.3]
<b>9.28.1.2. Lath and Reinforcing</b>	
(1)	[F20-OH1.1,OH1.2,OH1.3] [F20-OS2.3]
(2)	[F20-OH1.1,OH1.2,OH1.3] [F20-OS2.3]
(3)	[F20,F21-OS1.1] [F20,F21-OS2.3] [F20,F21-OS3.4] [F20,F21-OP1.1] [F20,F21-OH1.1]
<b>9.28.1.3. Concrete Masonry Units</b>	
(1)	[F80-OH1.1,OH1.2,OH1.3] [F80-OS2.3] [F80-OS1.1] Applies where stucco is applied to masonry chimneys. [F80-OS3.4] Applies where stucco is applied to masonry chimneys. [F80-OP1.1] Applies where stucco is applied to masonry chimneys.
<b>9.28.1.4. Clearance over Ground Level</b>	
(1)	[F80-OH1.1,OH1.2,OH1.3] [F80-OS2.3]
<b>9.28.1.5. Flashing and Caulking</b>	
(1)	[F80-OH1.1,OH1.2,OH1.3] Applies to the separation of aluminum flashing from stucco. [F80-OS2.3] Applies to the separation of aluminum flashing from stucco.
<b>9.28.2.1. Portland Cement</b>	
(1)	[F20-OH1.1,OH1.2,OH1.3] [F20-OS2.3] [F20-OS1.1] Applies where stucco is applied to masonry chimneys. [F20-OS3.4] Applies where stucco is applied to masonry chimneys. [F20-OP1.1] Applies where stucco is applied to masonry chimneys.

**Table 9.37.1.1. (Continued)**

Functional Statements and Objectives <sup>(1)</sup>	
<b>9.28.2.2. Aggregate</b>	
(1)	[F80-OH1.1,OH1.2,OH1.3]
	[F80-OS2.3]
	[F80-OS1.1] Applies where stucco is applied to masonry chimneys.
	[F80-OS3.4] Applies where stucco is applied to masonry chimneys.
	[F80-OP1.1] Applies where stucco is applied to masonry chimneys.
(2)	[F20,F80-OH1.1,OH1.2,OH1.3]
	[F20,F80-OS2.3]
	[F20,F80-OS1.1] Applies where stucco is applied to masonry chimneys.
	[F20,F80-OS3.4] Applies where stucco is applied to masonry chimneys.
	[F20,F80-OP1.1] Applies where stucco is applied to masonry chimneys.
<b>9.28.2.3. Water</b>	
(1)	[F80-OH1.1,OH1.2,OH1.3]
	[F80-OS2.3]
	[F80-OS1.1] Applies where stucco is applied to masonry chimneys.
	[F80-OS3.4] Applies where stucco is applied to masonry chimneys.
	[F80-OP1.1] Applies where stucco is applied to masonry chimneys.
<b>9.28.3.1. Materials</b>	
(1)	[F80-OH1.1,OH1.2,OH1.3]
	[F80-OS2.3]
	[F80-OS1.1] Applies where stucco is applied to masonry chimneys.
	[F80-OS3.4] Applies where stucco is applied to masonry chimneys.
	[F80-OP1.1] Applies where stucco is applied to masonry chimneys.
<b>9.28.3.2. Nails and Staples</b>	
(1)	[F20-OH1.1,OH1.2,OH1.3]
	[F20-OS2.3]
	[F20-OS1.1] Applies where stucco is applied to masonry chimneys.
	[F20-OS3.4] Applies where stucco is applied to masonry chimneys.
	[F20-OP1.1] Applies where stucco is applied to masonry chimneys.
(2)	[F20-OH1.1,OH1.2,OH1.3]
	[F20-OS2.3]

**Table 9.37.1.1. (Continued)**

Functional Statements and Objectives <sup>(1)</sup>	
(3)	[F20-OH1.1,OH1.2,OH1.3]
	[F20-OS2.3]
	[F20-OS1.1] Applies where stucco is applied to masonry chimneys.
	[F20-OS3.4] Applies where stucco is applied to masonry chimneys.
	[F20-OP1.1] Applies where stucco is applied to masonry chimneys.
(4)	[F20-OS2.1]
<b>9.28.4.1. Materials</b>	
(1)	[F80-OH1.1,OH1.2,OH1.3]
	[F80-OS2.3]
	[F80-OS1.1] Applies where stucco is applied to masonry chimneys.
	[F80-OS3.4] Applies where stucco is applied to masonry chimneys.
	[F80-OP1.1] Applies where stucco is applied to masonry chimneys.
(2)	[F80-OH1.1,OH1.2,OH1.3]
	[F80-OS2.3]
	[F80-OS1.1] Applies where stucco is applied to masonry chimneys.
	[F80-OS3.4] Applies where stucco is applied to masonry chimneys.
	[F80-OP1.1] Applies where stucco is applied to masonry chimneys.
<b>9.28.4.2. No Sheathing Required</b>	
(1)	[F20-OH1.1,OH1.2,OH1.3]
	[F20-OS2.3]
<b>9.28.4.3. Stucco Lath Specifications</b>	
(1)	[F20-OH1.1,OH1.2,OH1.3]
	[F20-OS2.3]
	[F20-OS1.1] Applies where stucco is applied to masonry chimneys.
	[F20-OS3.4] Applies where stucco is applied to masonry chimneys.
	[F20-OP1.1] Applies where stucco is applied to masonry chimneys.
<b>9.28.4.4. Self-Furring Devices</b>	
(1)	[F20,F80-OH1.1,OH1.2,OH1.3]
	[F20,F80-OS2.3]
	[F20,F80-OS1.1] Applies where stucco is applied to masonry chimneys.
	[F20,F80-OS3.4] Applies where stucco is applied to masonry chimneys.
	[F20,F80-OP1.1] Applies where stucco is applied to masonry chimneys.

Table 9.37.1.1. (Continued)

Functional Statements and Objectives <sup>(1)</sup>	
<b>9.28.4.5. Application of Stucco Lath</b>	
(1)	[F20-OH1.1,OH1.2,OH1.3]
	[F20-OS2.3]
	[F20-OS1.1] Applies where stucco is applied to masonry <i>chimneys</i> .
	[F20-OS3.4] Applies where stucco is applied to masonry <i>chimneys</i> .
	[F20-OP1.1] Applies where stucco is applied to masonry <i>chimneys</i> .
(2)	[F20-OH1.1,OH1.2,OH1.3]
	[F20-OS2.3]
	[F20-OS1.1] Applies where stucco is applied to masonry <i>chimneys</i> .
	[F20-OS3.4] Applies where stucco is applied to masonry <i>chimneys</i> .
	[F20-OP1.1] Applies where stucco is applied to masonry <i>chimneys</i> .
(3)	[F20-OH1.1,OH1.2,OH1.3]
	[F20-OS2.3]
(4)	[F20-OH1.1,OH1.2,OH1.3]
	[F20-OS2.3]
	[F20-OS1.1] Applies where stucco is applied to masonry <i>chimneys</i> .
	[F20-OS3.4] Applies where stucco is applied to masonry <i>chimneys</i> .
	[F20-OP1.1] Applies where stucco is applied to masonry <i>chimneys</i> .
<b>9.28.4.6. Fastening</b>	
(2)	[F20-OH1.1,OH1.2,OH1.3]
	[F20-OS2.3]
	[F20-OS1.1] Applies where stucco is applied to masonry <i>chimneys</i> .
	[F20-OS3.4] Applies where stucco is applied to masonry <i>chimneys</i> .
	[F20-OP1.1] Applies where stucco is applied to masonry <i>chimneys</i> .
(3)	[F20-OH1.1,OH1.2,OH1.3]
	[F20-OS2.3]
	[F20-OS1.1] Applies where stucco is applied to masonry <i>chimneys</i> .
	[F20-OS3.4] Applies where stucco is applied to masonry <i>chimneys</i> .
	[F20-OP1.1] Applies where stucco is applied to masonry <i>chimneys</i> .
(4)	[F20-OS2.1]

Table 9.37.1.1. (Continued)

Functional Statements and Objectives <sup>(1)</sup>	
<b>9.28.5.1. Mixes</b>	
(1)	[F20,F61,F80-OH1.1,OH1.2,OH1.3]
	[F20,F61,F80-OS2.3]
	[F20,F61,F80-OS1.1] Applies where stucco is applied to masonry <i>chimneys</i> .
	[F20,F61,F80-OS3.4] Applies where stucco is applied to masonry <i>chimneys</i> .
	[F20,F61,F80-OP1.1] Applies where stucco is applied to masonry <i>chimneys</i> .
<b>9.28.5.2. Pigments</b>	
(1)	[F20,F80-OH1.1,OH1.2,OH1.3]
	[F20,F80-OS2.3]
	[F20,F80-OS1.1] Applies where stucco is applied to masonry <i>chimneys</i> .
	[F20,F80-OS3.4] Applies where stucco is applied to masonry <i>chimneys</i> .
	[F20,F80-OP1.1] Applies where stucco is applied to masonry <i>chimneys</i> .
(2)	[F20,F80-OH1.1,OH1.2,OH1.3]
	[F20,F80-OS2.3]
<b>9.28.5.3. Mixing</b>	
(1)	[F20,F80-OH1.1,OH1.2,OH1.3]
	[F20,F80-OS2.3]
	[F20,F80-OS1.1] Applies where stucco is applied to masonry <i>chimneys</i> .
	[F20,F80-OS3.4] Applies where stucco is applied to masonry <i>chimneys</i> .
	[F20,F80-OP1.1] Applies where stucco is applied to masonry <i>chimneys</i> .
(2)	[F20,F80-OH1.1,OH1.2,OH1.3]
	[F20,F80-OS2.3]
	[F20,F80-OS1.1] Applies where stucco is applied to masonry <i>chimneys</i> .
	[F20,F80-OS3.4] Applies where stucco is applied to masonry <i>chimneys</i> .
	[F20,F80-OP1.1] Applies where stucco is applied to masonry <i>chimneys</i> .
<b>9.28.6.1. Low Temperature Conditions</b>	
(1)	[F20,F80-OH1.1,OH1.2,OH1.3]
	[F20,F80-OS2.3]
	[F20,F80-OS1.1] Applies where stucco is applied to masonry <i>chimneys</i> .
	[F20,F80-OS3.4] Applies where stucco is applied to masonry <i>chimneys</i> .
	[F20,F80-OP1.1] Applies where stucco is applied to masonry <i>chimneys</i> .

**Table 9.37.1.1. (Continued)**

Functional Statements and Objectives <sup>(1)</sup>	
(2)	[F20,F80-OH1.1,OH1.2,OH1.3]
	[F20,F80-OS2.3]
	[F20,F80-OS1.1] Applies where stucco is applied to masonry chimneys.
	[F20,F80-OS3.4] Applies where stucco is applied to masonry chimneys.
	[F20,F80-OP1.1] Applies where stucco is applied to masonry chimneys.
<b>9.28.6.2. Number of Coats and Total Thickness</b>	
(1)	[F20-OH1.1,OH1.2,OH1.3]
	[F20-OS2.3]
	[F20-OS1.1] Applies where stucco is applied to masonry chimneys.
	[F20-OS3.4] Applies where stucco is applied to masonry chimneys.
	[F20-OP1.1] Applies where stucco is applied to masonry chimneys.
<b>9.28.6.3. First Coat</b>	
(1)	[F20,F80-OH1.1,OH1.2,OH1.3]
	[F20,F80-OS2.3]
	[F20,F80-OS1.1] Applies where stucco is applied to masonry chimneys.
	[F20,F80-OS3.4] Applies where stucco is applied to masonry chimneys.
	[F20,F80-OP1.1] Applies where stucco is applied to masonry chimneys.
(2)	[F20-OH1.1,OH1.2,OH1.3]
	[F20-OS2.3]
	[F20-OS1.1] Applies where stucco is applied to masonry chimneys.
	[F20-OS3.4] Applies where stucco is applied to masonry chimneys.
	[F20-OP1.1] Applies where stucco is applied to masonry chimneys.
<b>9.28.6.4. Second Coat</b>	
(1)	[F20-OH1.1,OH1.2,OH1.3]
	[F20-OS2.3]
	[F20-OS1.1] Applies where stucco is applied to masonry chimneys.
	[F20-OS3.4] Applies where stucco is applied to masonry chimneys.
	[F20-OP1.1] Applies where stucco is applied to masonry chimneys.

**Table 9.37.1.1. (Continued)**

Functional Statements and Objectives <sup>(1)</sup>	
(2)	[F20-OH1.1,OH1.2,OH1.3]
	[F20-OS2.3]
	[F20-OS1.1] Applies where stucco is applied to masonry chimneys.
	[F20-OS3.4] Applies where stucco is applied to masonry chimneys.
	[F20-OP1.1] Applies where stucco is applied to masonry chimneys.
<b>9.28.6.5. Finish Coat</b>	
(1)	[F80-OH1.1,OH1.2,OH1.3]
	[F80-OS2.3]
	[F80-OS1.1] Applies where stucco is applied to masonry chimneys.
	[F80-OS3.4] Applies where stucco is applied to masonry chimneys.
	[F80-OP1.1] Applies where stucco is applied to masonry chimneys.
(2)	[F20-OH1.1,OH1.2,OH1.3]
	[F20-OS2.3]
	[F20-OS1.1] Applies where stucco is applied to masonry chimneys.
	[F20-OS3.4] Applies where stucco is applied to masonry chimneys.
	[F20-OP1.1] Applies where stucco is applied to masonry chimneys.
(3)	[F80-OH1.1,OH1.2,OH1.3]
	[F80-OS2.3]
	[F80-OS1.1] Applies where stucco is applied to masonry chimneys.
	[F80-OS3.4] Applies where stucco is applied to masonry chimneys.
	[F80-OP1.1] Applies where stucco is applied to masonry chimneys.
<b>9.29.2.1. Where Required</b>	
(1)	[F80,F81-OH1.1,OH1.2] Applies where interior finishes support or serve as required environmental separation elements.
	[F80,F81-OS2.3]
	[F80,F81-OS1.2] Applies where interior finishes are required to act as fire protection for foamed plastics or to contribute to the required fire resistance of assemblies.
	[F80,F81-OP2.3,OP2.4]

Copyright © NRC 1941 - 2021 World Rights Reserved © CNRC 1941-2021 Droits réservés pour tous pays

Table 9.37.1.1. (Continued)

Functional Statements and Objectives <sup>(1)</sup>	
<b>9.29.2.2. Materials</b>	
(1)	[F80,F81-OH1.1,OH1.2] Applies where interior finishes support or serve as required environmental separation elements.
	[F80-OS2.3]
	[F80-OS1.2] Applies where interior finishes are required to act as fire protection for foamed plastics or to contribute to the required fire resistance of assemblies.
	[F80-OP2.3,OP2.4]
<b>9.29.3.1. Size and Spacing of Furring</b>	
(1)	[F20,F22-OS2.1]
	[F20,F22-OH1.1,OH1.2] Applies where interior finishes support or serve as required environmental separation elements.
	[F20,F22-OS1.2] Applies where interior finishes are required to act as fire protection for foamed plastics or to contribute to the required fire resistance of assemblies.
	[F20,F22-OP2.1,OP2.4]
<b>9.29.3.2. Fastening</b>	
(1)	[F20-OS2.1]
	[F20-OS1.2] Applies where interior finishes are required to act as fire protection for foamed plastics or to contribute to the required fire resistance of assemblies.
	[F20-OH1.1,OH1.2] Applies where interior finishes support or serve as required environmental separation elements.
	[F20-OP2.1,OP2.4]
<b>9.29.4.1. Application</b>	
(1)	[F20,F80-OS2.1,OS2.3]
	[F20,F22,F80,F81-OH1.1,OH1.2] Applies where interior finishes support or serve as required environmental separation elements.
	[F20,F80-OS1.2] Applies where interior finishes are required to act as fire protection for foamed plastics or to contribute to the required fire resistance of assemblies.
	[F20,F80-OP2.1,OP2.3] [F22,F80-OP2.4]
<b>9.29.5.1. Application</b>	
(2)	[F20,F80-OS2.1,OS2.3]
	[F20,F22,F80,F81-OH1.1,OH1.2] Applies where interior finishes support or serve as required environmental separation elements.
	[F20,F22,F80-OS1.2] Applies where interior finishes are required to act as fire protection for foamed plastics or to contribute to the required fire resistance of assemblies.
	[F20,F80-OP2.1,OP2.3] [F22,F80-OP2.4]

Table 9.37.1.1. (Continued)

Functional Statements and Objectives <sup>(1)</sup>	
<b>9.29.5.2. Materials</b>	
(1)	[F20,F80-OP2.1,OP2.3] [F22,F80-OP2.4]
	[F20,F80-OS2.1,OS2.3]
	[F20,F22,F80-OS1.2] Applies where interior finishes are required to act as fire protection for foamed plastics or to contribute to the required fire resistance of assemblies.
	[F20,F22,F80,F81-OH1.1,OH1.2] Applies where interior finishes support or serve as required environmental separation elements.
<b>9.29.5.3. Maximum Spacing of Supports</b>	
(1)	[F20-OS2.1]
	[F20,F22-OS1.2] Applies where interior finishes are required to act as fire protection for foamed plastics or to contribute to the required fire resistance of assemblies.
	[F20,F22-OH1.1,OH1.2] Applies where interior finishes support or serve as required environmental separation elements.
	[F20-OP2.1] [F20,F22-OP2.4]
<b>9.29.5.4. Support of Insulation</b>	
(1)	[F20-OS2.1]
	[F20,F22-OH1.1,OH1.2] Applies where interior finishes support or serve as required environmental separation elements.
	[F20,F22-OS1.2] Applies where interior finishes are required to act as fire protection for foamed plastics or to contribute to the required fire resistance of assemblies.
	[F20-OP2.1] [F20,F22-OP2.4]
<b>9.29.5.5. Length of Fasteners</b>	
(1)	[F20-OS2.1]
	[F20-OS1.2] Applies where interior finishes are required to act as fire protection for foamed plastics or to contribute to the required fire resistance of assemblies.
	[F20-OH1.1,OH1.2] Applies where interior finishes support or serve as required environmental separation elements.
	[F20-OP2.1,OP2.4]
<b>9.29.5.6. Nails</b>	
(1)	[F20-OS2.1]
	[F20-OS1.2] Applies where interior finishes are required to act as fire protection for foamed plastics or to contribute to the required fire resistance of assemblies.
	[F20-OH1.1,OH1.2] Applies where interior finishes support or serve as required environmental separation elements.
	[F20-OP2.1,OP2.4]



**Table 9.37.1.1. (Continued)**

Functional Statements and Objectives <sup>(1)</sup>	
<b>9.29.5.7. Screws</b>	
(1)	[F20-OS2.1] [F20-OS1.2] Applies where interior finishes are required to act as fire protection for foamed plastics or to contribute to the required fire resistance of assemblies. [F20-OH1.1,OH1.2] Applies where interior finishes support or serve as required environmental separation elements. [F20-OP2.1,OP2.4]
<b>9.29.5.8. Spacing of Nails</b>	
(1)	[F20-OP2.1] [F20-OP2.3] Applies where interior finishes support or serve as required environmental separation elements. [F20-OS2.1] [F20-OS2.3] Applies where interior finishes support or serve as required environmental separation elements. [F20-OH1.1,OH1.2] Applies where interior finishes support or serve as required environmental separation elements. [F20-OS1.2] Applies where interior finishes are required to act as fire protection for foamed plastics or to contribute to the required fire resistance of assemblies. [F20-OP1.2] Applies where interior finishes are required to act as fire protection for foamed plastics or to contribute to the required fire resistance of assemblies.
(3)	[F20-OS2.1] [F20-OS2.3] Applies where interior finishes support or serve as required environmental separation elements. [F20-OP2.1] [F20-OP2.3] Applies where interior finishes support or serve as required environmental separation elements. [F20-OH1.1,OH1.2] Applies where interior finishes support or serve as required environmental separation elements.

**Table 9.37.1.1. (Continued)**

Functional Statements and Objectives <sup>(1)</sup>	
(4)	[F20-OS2.1] [F20-OS2.5] [F22-OS2.4,OS2.5] Applies where interior finishes contribute to the required bracing or lateral support for studs. [F20,F22-OS2.3] Applies where interior finishes support or serve as required environmental separation elements. [F20-OP2.1] [F20-OP2.5] [F22-OP2.4,OP2.5] Applies where interior finishes contribute to the required bracing or lateral support for studs. [F20,F22-OP2.3] Applies where interior finishes support or serve as required environmental separation elements. [F20,F22-OH1.1,OH1.2,OH1.3] Applies where interior finishes contribute to the required bracing or lateral support for studs, or where interior finishes support or serve as required environmental separation elements. [F20-OS1.2] Applies where interior finishes are required to act as fire protection for foamed plastics or contribute to the required fire resistance of assemblies. [F20,F22-OH4] Applies where walls support floors and where interior finishes contribute to the required bracing or lateral support for studs or where interior finishes support or serve as required environmental separation elements. [F20,F22-OS3.1,OS3.7] Applies where walls support floors and where interior finishes contribute to the required bracing or lateral support for studs or where interior finishes support or serve as required environmental separation elements. [F20-OP3.1] Applies where interior finishes are installed to contribute to the required fire resistance of exterior walls. [F20-OP1.2] Applies where interior finishes are required to act as fire protection for foamed plastics or contribute to the required fire resistance of assemblies.

Table 9.37.1.1. (Continued)

Functional Statements and Objectives <sup>(1)</sup>	
(5)	[F20-OS2.1] [F20-OS2.5] [F22-OS2.4,OS2.5] Applies where interior finishes contribute to the required bracing or lateral support for studs. [F20,F22-OS2.3] Applies where interior finishes support or serve as required environmental separation elements.
	[F20-OP2.1] [F20-OP2.5] [F22-OP2.4,OP2.5] Applies where interior finishes contribute to the required bracing or lateral support for studs. [F20,F22-OP2.3] Applies where interior finishes support or serve as required environmental separation elements.
	[F20,F22-OH1.1,OH1.2,OH1.3] Applies where interior finishes contribute to the required bracing or lateral support for studs, or where interior finishes support or serve as required environmental separation elements.
	[F20-OH4] Applies where walls support floors and where interior finishes contribute to the required bracing or lateral support for studs or where interior finishes support or serve as required environmental separation elements.
	[F20-OS3.1,OS3.7] Applies where walls support floors and where interior finishes contribute to the required bracing or lateral support for studs or where interior finishes support or serve as required environmental separation elements.
	[F20-OS1.2] Applies where interior finishes are required to act as fire protection for foamed plastics or to contribute to the required fire resistance of assemblies.
	[F20-OP1.2] Applies where interior finishes are required to act as fire protection for foamed plastics or to contribute to the required fire resistance of assemblies.
	[F20-OP3.1] Applies where interior finishes are installed to contribute to the required fire resistance of exterior walls.

Table 9.37.1.1. (Continued)

Functional Statements and Objectives <sup>(1)</sup>	
(6)	[F20-OS2.1] [F20-OS2.5] [F22-OS2.4,OS2.5] Applies where interior finishes contribute to the required bracing or lateral support for studs. [F20,F22-OS2.3] Applies where interior finishes support or serve as required environmental separation elements.
	[F20-OS1.2] Applies where interior finishes are required to act as fire protection for foamed plastics or to contribute to the required fire resistance of assemblies.
	[F20,F22-OH1.1,OH1.2,OH1.3] Applies where interior finishes support or serve as required environmental separation elements.
	[F20-OP2.1] [F20-OP2.5] [F22-OP2.4,OP2.5] Applies where interior finishes contribute to the required bracing or lateral support for studs. [F20,F22-OP2.3] Applies where interior finishes support or serve as required environmental separation elements.
	[F20-OH4] Applies where walls support floors and where interior finishes contribute to the required bracing or lateral support for studs or where interior finishes support or serve as required environmental separation elements.
	[F20-OP1.2] Applies where interior finishes are required to act as fire protection for foamed plastics or to contribute to the required fire resistance of assemblies.
	[F20-OS3.1,OS3.7] Applies where walls support floors and where interior finishes contribute to the required bracing or lateral support for studs or where interior finishes support or serve as required environmental separation elements.

Table 9.37.1.1. (Continued)

Functional Statements and Objectives <sup>(1)</sup>	
(7)	[F20-OS2.1] [F20-OS2.5] [F22-OS2.4,OS2.5] Applies where interior finishes contribute to the required bracing or lateral support for studs. [F20,F22-OS2.3] Applies where interior finishes support or serve as required environmental separation elements.
	[F20-OP2.1] [F20-OP2.5] [F22-OP2.4,OP2.5] Applies where interior finishes contribute to the required bracing or lateral support for studs. [F20,F22-OP2.3] Applies where interior finishes support or serve as required environmental separation elements.
	[F20,F22-OH1.1,OH1.2,OH1.3] Applies where interior finishes contribute to the required bracing or lateral support for studs, or where interior finishes support or serve as required environmental separation elements.
	[F20-OH4] Applies where walls support floors and where interior finishes contribute to the required bracing or lateral support for studs or where interior finishes support or serve as required environmental separation elements.
	[F20-OS3.1,OS3.7] Applies where walls support floors and where interior finishes contribute to the required bracing or lateral support for studs or where interior finishes support or serve as required environmental separation elements.
	[F20-OS1.2] Applies where interior finishes are required to act as fire protection for foamed plastics or to contribute to the required fire resistance of assemblies.
	[F20-OP1.2] Applies where interior finishes are required to act as fire protection for foamed plastics or to contribute to the required fire resistance of assemblies.
	[F20-OP3.1] Applies where interior finishes are installed to contribute to the required fire resistance of exterior walls.
<b>9.29.5.9. Spacing of Screws</b>	
(1)	[F20-OS2.1] [F20-OS2.3] Applies where interior finishes support or serve as required environmental separation elements.
	[F20-OP2.1] [F20-OP2.3] Applies where interior finishes support or serve as required environmental separation elements.
	[F20-OH1.1,OH1.2] Applies where interior finishes support or serve as required environmental separation elements.
	[F20-OS1.2] Applies where interior finishes are required to act as fire protection for foamed plastics or to contribute to the required fire resistance of assemblies.
	[F20-OP1.2] Applies where interior finishes are required to act as fire protection for foamed plastics or to contribute to the required fire resistance of assemblies.

Table 9.37.1.1. (Continued)

Functional Statements and Objectives <sup>(1)</sup>	
(3)	[F20-OS2.1] [F20-OS2.3] Applies where interior finishes support or serve as required environmental separation elements.
	[F20-OP2.1] [F20-OP2.3] Applies where interior finishes support or serve as required environmental separation elements.
	[F20-OH1.1,OH1.2,OH1.3] Applies where interior finishes support or serve as required environmental separation elements.
	[F20-OS1.2] Applies where gypsum board is required to provide the fire resistance and the rating of the assembly is determined according to Table 9.10.3.1.-A.
	[F20-OP1.2] Applies where gypsum board is required to provide the fire resistance and the rating of the assembly is determined according to Table 9.10.3.1.-A.
(4)	[F20-OP3.1] Applies where interior finishes are installed to contribute to the required fire resistance of exterior walls.
	[F20-OS2.1] [F20-OS2.5] [F22-OS2.4,OS2.5] Applies where interior finishes contribute to the required bracing or lateral support for studs. [F20,F22-OS2.3] Applies where interior finishes support or serve as required environmental separation elements.
	[F20-OP2.1] [F20-OP2.5] [F22-OP2.4,OP2.5] Applies where interior finishes contribute to the required bracing or lateral support for studs. [F20,F22-OP2.3] Applies where interior finishes support or serve as required environmental separation elements.
	[F20,F22-OH1.1,OH1.2,OH1.3] Applies where interior finishes contribute to the required bracing or lateral support for studs, or where interior finishes support or serve as required environmental separation elements.
	[F20-OS1.2] Applies where interior finishes are required to act as fire protection for foamed plastics or contribute to the required fire resistance of assemblies.
	[F20,F22-OS3.1,OS3.7] Applies where the walls support floors and where interior finishes contribute to the required bracing or lateral support for studs or where interior finishes support or serve as required environmental separation elements.
	[F20,F22-OH4] Applies where the walls support floors and where interior finishes contribute to the required bracing or lateral support for studs or where interior finishes support or serve as required environmental separation elements.
	[F20-OP3.1] Applies where interior finishes are installed to contribute to the required fire resistance of exterior walls.
	[F20-OP1.2] Applies where interior finishes are required to act as fire protection for foamed plastics or to contribute to the required fire resistance of assemblies.
	[F20-OP1.2] Applies where interior finishes are required to act as fire protection for foamed plastics or to contribute to the required fire resistance of assemblies.

Table 9.37.1.1. (Continued)

Functional Statements and Objectives <sup>(1)</sup>	
(6)	[F20-OS2.1] [F20-OS2.5] [F22-OS2.4,OS2.5] Applies where interior finishes contribute to the required bracing or lateral support for studs. [F20,F22-OS2.3] Applies where interior finishes support or serve as required environmental separation elements.
	[F20-OP2.1] [F20-OP2.5] [F22-OP2.4,OP2.5] Applies where interior finishes contribute to the required bracing or lateral support for studs. [F20,F22-OP2.3] Applies where interior finishes support or serve as required environmental separation elements.
	[F20,F22-OH1.1,OH1.2,OH1.3] Applies where interior finishes contribute to the required bracing or lateral support for studs, or where interior finishes support or serve as required environmental separation elements.
	[F20-OH4] Applies where walls support floors and where interior finishes contribute to the required bracing or lateral support for studs or where interior finishes support or serve as required environmental separation elements.
	[F20-OS3.1,OS3.7] Applies where walls support floors and where interior finishes contribute to the required bracing or lateral support for studs or where interior finishes support or serve as required environmental separation elements.
	[F20-OS1.2] Applies where interior finishes are required to act as fire protection for foamed plastics or to contribute to the required fire resistance of assemblies.
	[F20-OP1.2] Applies where interior finishes are required to act as fire protection for foamed plastics or to contribute to the required fire resistance of assemblies.
	[F20-OP3.1] Applies where interior finishes are installed to contribute to the required fire resistance of exterior walls.

Table 9.37.1.1. (Continued)

Functional Statements and Objectives <sup>(1)</sup>	
(7)	[F20-OS2.1] [F20-OS2.5] [F22-OS2.4,OS2.5] Applies where interior finishes contribute to the required bracing or lateral support for studs. [F20,F22-OS2.3] Applies where interior finishes support or serve as required environmental separation elements.
	[F20-OP2.1] [F20-OP2.5] [F22-OP2.4,OP2.5] Applies where interior finishes contribute to the required bracing or lateral support for studs. [F20,F22-OP2.3] Applies where interior finishes support or serve as required environmental separation elements.
	[F20,F22-OH1.1,OH1.2,OH1.3] Applies where interior finishes contribute to the required bracing or lateral support for studs, or where interior finishes support or serve as required environmental separation elements.
	[F20-OS3.1,OS3.7] Applies where walls support floors and where interior finishes contribute to the required bracing or lateral support for studs or where interior finishes support or serve as required environmental separation elements.
	[F20-OS1.2] Applies where interior finishes are required to act as fire protection for foamed plastics or to contribute to the required fire resistance of assemblies.
	[F20-OH4] Applies where walls support floors and where interior finishes contribute to the required bracing or lateral support for studs or where interior finishes support or serve as required environmental separation elements.
	[F20-OP1.2] Applies where interior finishes are required to act as fire protection for foamed plastics or to contribute to the required fire resistance of assemblies.
	[F20-OP3.1] Applies where interior finishes are installed to contribute to the required fire resistance of exterior walls.
<b>9.29.5.10. Low Temperature Conditions</b>	
(1)	[F81-OS1.2] Applies where the finishing of joints is required to maintain required <i>fire-resistance ratings</i> .
<b>9.29.6.1. Thickness</b>	
(1)	[F20-OS2.1] [F20,F22-OS1.2] Applies where interior finishes are required to act as fire protection for foamed plastics or to contribute to the required fire resistance of assemblies.
	[F20,F22-OH1.1,OH1.2] Applies where interior finishes support or serve as required environmental separation elements.
	[F20-OP2.1] [F20,F22-OP2.4]
<b>9.29.6.2. Grooved Plywood</b>	
(1)	[F20-OS2.1] [F20,F22-OS1.2] Applies where interior finishes are required to act as fire protection for foamed plastics or to contribute to the required fire resistance of assemblies.
	[F20,F22-OH1.1,OH1.2] Applies where interior finishes support or serve as required environmental separation elements.
	[F20-OP2.1] [F20,F22-OP2.4]

Table 9.37.1.1. (Continued)

Functional Statements and Objectives <sup>(1)</sup>	
<b>9.29.6.3. Nails and Staples</b>	
(1)	[F20-OS2.1]
	[F20,F22-OS1.2] Applies where interior finishes are required to act as fire protection for foamed plastics or to contribute to the required fire resistance of assemblies.
	[F20,F22-OH1.1,OH1.2] Applies where interior finishes support or serve as required environmental separation elements.
	[F20-OP2.1] [F20,F22-OP2.4]
(2)	[F20-OS2.1,OS2.3,OS2.5] [F22-OS2.3,OS2.4,OS2.5]
	[F20-OP2.1,OP2.3,OP2.5] [F22-OP2.3,OP2.4,OP2.5]
	[F20,F22-OS1.2] Applies to assemblies required to provide fire resistance.
	[F22-OS3.1] Applies to walls that support floors. [F22-OS3.7] Applies to walls that contain doors or windows required for emergency egress.
	[F20,F22-OH4] Applies to walls that support floors.
	[F20,F22-OH1.1,OH1.2,OH1.3] Applies to elements that support or are part of an environmental separator.
<b>9.29.6.4. Edge Support</b>	
(1)	[F20-OS2.1]
	[F20,F22-OS1.2] Applies where interior finishes are required to act as fire protection for foamed plastics or to contribute to the required fire resistance of assemblies.
	[F20,F22-OH1.1,OH1.2] Applies where interior finishes support or serve as required environmental separation elements.
	[F20-OP2.1] [F20,F22-OP2.4]
<b>9.29.7.1. Material Standard</b>	
(1)	[F20,F80-OS2.1,OS2.3]
	[F20,F22,F80-OS1.2] Applies where interior finishes are required to act as fire protection for foamed plastics or to contribute to the required fire resistance of assemblies.
	[F20,F22,F80,F81-OH1.1,OH1.2] Applies where interior finishes support or serve as required environmental separation elements.
	[F20,F80-OP2.1,OP2.3] [F22,F80-OP2.4]
<b>9.29.7.2. Thickness</b>	
(1)	[F20-OS2.1]
	[F20,F22-OS1.2] Applies where interior finishes are required to act as fire protection for foamed plastics or to contribute to the required fire resistance of assemblies.
	[F20,F22-OH1.1,OH1.2] Applies where interior finishes support or serve as required environmental separation elements.
	[F20-OP2.1] [F20,F22-OP2.4]

Table 9.37.1.1. (Continued)

Functional Statements and Objectives <sup>(1)</sup>	
<b>9.29.7.3. Nails</b>	
(1)	[F20-OS2.1]
	[F20,F22-OS1.2] Applies where interior finishes are required to act as fire protection for foamed plastics or to contribute to the required fire resistance of assemblies.
	[F20,F22-OH1.1,OH1.2] Applies where interior finishes support or serve as required environmental separation elements.
	[F20-OP2.1] [F20,F22-OP2.4]
<b>9.29.7.4. Edge Support</b>	
(1)	[F20-OS2.1]
	[F20,F22-OH1.1,OH1.2] Applies where interior finishes support or serve as required environmental separation elements.
	[F20,F22-OS1.2] Applies where interior finishes are required to act as fire protection for foamed plastics or to contribute to the required fire resistance of assemblies.
	[F20-OP2.1] [F20,F22-OP2.4]
<b>9.29.8.1. Material Standard</b>	
(1)	[F20,F80-OS2.1,OS2.3]
	[F20,F22,F80-OS1.2] Applies where interior finishes are required to act as fire protection for foamed plastics or to contribute to the required fire resistance of assemblies.
	[F20,F22,F80,F81-OH1.1,OH1.2] Applies where interior finishes support or serve as required environmental separation elements.
	[F20,F80-OP2.1,OP2.3]
<b>9.29.8.2. Thickness</b>	
(1)	[F20-OS2.1]
	[F20,F22-OS1.2] Applies where interior finishes are required to act as fire protection for foamed plastics or to contribute to the required fire resistance of assemblies.
	[F20,F22-OH1.1,OH1.2] Applies where interior finishes support or serve as required environmental separation elements.
	[F20-OP2.1] [F20,F22-OP2.4]
(2)	[F20-OS2.1]
	[F20,F22-OS1.2] Applies where interior finishes are required to act as fire protection for foamed plastics or to contribute to the required fire resistance of assemblies.
	[F20,F22-OH1.1,OH1.2] Applies where interior finishes support or serve as required environmental separation elements.
	[F20-OP2.1] [F20,F22-OP2.4]

Table 9.37.1.1. (Continued)

Functional Statements and Objectives <sup>(1)</sup>	
<b>9.29.8.3. Nails</b>	
(1)	[F20-OS2.1]
	[F20-OS1.2] Applies where interior finishes are required to act as fire protection for foamed plastics or to contribute to the required fire resistance of assemblies.
	[F20-OH1.1,OH1.2] Applies where interior finishes support or serve as required environmental separation elements.
	[F20-OP2.1] [F20-OP2.4]
(2)	[F20-OS2.1]
	[F20,F22-OS1.2] Applies where interior finishes are required to act as fire protection for foamed plastics or to contribute to the required fire resistance of assemblies.
	[F20,F22-OH1.1,OH1.2] Applies where interior finishes support or serve as required environmental separation elements.
	[F20-OP2.1] [F20,F22-OP2.4]
<b>9.29.8.4. Edge Support</b>	
(1)	[F20-OS2.1]
	[F20,F22-OH1.1,OH1.2] Applies where interior finishes support or serve as required environmental separation elements.
	[F20,F22-OS1.2] Applies where interior finishes are required to act as fire protection for foamed plastics or to contribute to the required fire resistance of assemblies.
	[F20-OP2.1] [F20,F22-OP2.4]
<b>9.29.9.1. Material Standard</b>	
(1)	[F20,F80-OS2.1,OS2.3]
	[F20,F22,F80-OS1.2] Applies where interior finishes are required to act as fire protection for foamed plastics or to contribute to the required fire resistance of assemblies.
	[F20,F22,F80,F81-OH1.1,OH1.2] Applies where interior finishes support or serve as required environmental separation elements.
	[F20,F80-OP2.1,OP2.3] [F22,F80-OP2.4]
(2)	[F20,F80-OP2.1,OP2.3] [F22,F80-OP2.4]
	[F20,F80-OS2.1,OS2.3]
	[F20,F22,F80-OS1.2] Applies where interior finishes are required to act as fire protection for foamed plastics or to contribute to the required fire resistance of assemblies.
	[F20,F22,F80,F81-OH1.1,OH1.2] Applies where interior finishes support or serve as required environmental separation elements.

Table 9.37.1.1. (Continued)

Functional Statements and Objectives <sup>(1)</sup>	
<b>9.29.9.2. Minimum Thickness</b>	
(1)	[F20-OS2.1]
	[F20,F22-OS1.2] Applies where interior finishes are required to act as fire protection for foamed plastics or to contribute to the required fire resistance of assemblies.
	[F20,F22-OH1.1,OH1.2] Applies where interior finishes support or serve as required environmental separation elements.
	[F20-OP2.1] [F20,F22-OP2.4]
(4)	[F20-OS2.1]
	[F20,F22-OS1.2] Applies where interior finishes are required to act as fire protection for foamed plastics or to contribute to the required fire resistance of assemblies.
	[F20,F22-OH1.1,OH1.2] Applies where interior finishes support or serve as required environmental separation elements.
	[F20-OP2.1] [F20,F22-OP2.4]
(5)	[F20-OS2.1]
	[F20,F22-OS2.4,OS2.5] Applies where interior finishes contribute to the required bracing or lateral support for studs.
	[F20,F22-OS2.3] Applies where interior finishes support or serve as required environmental separation elements.
	[F20-OP2.1] [F20-OP2.5] [F22-OP2.4,OP2.5] Applies where interior finishes contribute to the required bracing or lateral support for studs.
<b>9.29.9.3. Nails</b>	
(1)	[F20-OS2.1]
	[F20,F22-OS1.2] Applies where interior finishes are required to act as fire protection for foamed plastics or to contribute to the required fire resistance of assemblies.
	[F20,F22-OH1.1,OH1.2] Applies where interior finishes support or serve as required environmental separation elements.
	[F20-OP2.1] [F20,F22-OP2.4]

Table 9.37.1.1. (Continued)

Functional Statements and Objectives <sup>(1)</sup>	
(2)	[F20-OS2.1,OS2.3,OS2.5] [F22-OS2.3,OS2.4,OS2.5]
	[F20-OP2.1,OP2.3,OP2.5] [F22-OP2.3,OP2.4,OP2.5]
	[F20,F22-OS1.2] Applies to assemblies required to provide fire resistance.
	[F22-OS3.1] Applies to walls that support floors. [F22-OS3.7] Applies to walls that contain doors or windows required for emergency egress.
	[F20,F22-OH4] Applies to walls that support floors. [F20,F22-OH1.1,OH1.2,OH1.3] Applies to elements that support or are part of an environmental separator.
<b>9.29.9.4. Edge Support</b>	
(1)	[F20-OS2.1]
	[F20,F22-OH1.1,OH1.2] Applies where interior finishes support or serve as required environmental separation elements.
	[F20,F22-OS1.2] Applies where interior finishes are required to act as fire protection for foamed plastics or to contribute to the required fire resistance of assemblies.
	[F20-OP2.1] [F20,F22-OP2.4]
<b>9.29.10.1. Tile Application</b>	
(1)	[F20,F81-OH1.1,OH1.2] Applies where the substrate serves as a required environmental separation element.
	[F20-OS2.1] [F20-OS2.5] [F22-OS2.4,OS2.5] Applies where the substrate for the tile contributes to the required bracing or lateral support for studs. [F20-OS2.3] Applies where the substrate for the tile serves as a required environmental separation element or where the tile is installed to provide the required waterproof wall finish.
	[F20-OS1.2] Applies where the substrate is required to act as fire protection for foamed plastics or to contribute to the required fire resistance of assemblies.
	[F20-OP2.1] [F20-OP2.5] [F22-OP2.4,OP2.5] Applies where the substrate for the tile contributes to the required bracing or lateral support for studs. [F20-OP2.3] Applies where the substrate for the tile serves as a required environmental separation element or where the tile is installed to provide the required waterproof wall finish.

Table 9.37.1.1. (Continued)

Functional Statements and Objectives <sup>(1)</sup>	
(2)	[F20,F81-OH1.1,OH1.2] Applies where the substrate serves as a required environmental separation element.
	[F20-OS2.1] [F20-OS2.5] [F22-OS2.4,OS2.5] Applies where the substrate for the tile contributes to the required bracing or lateral support for studs. [F20-OS2.3] Applies where the substrate for the tile serves as a required environmental separation element or where the tile is installed to provide the required waterproof wall finish.
	[F20-OS1.2] Applies where the substrate is required to act as fire protection for foamed plastics or to contribute to the required fire resistance of assemblies.
	[F20-OP2.1] [F20-OP2.5] [F22-OP2.4,OP2.5] Applies where the substrate for the tile contributes to the required bracing or lateral support for studs. [F20-OP2.3] Applies where the substrate for the tile serves as a required environmental separation element or where the tile is installed to provide the required waterproof wall finish.
<b>9.29.10.2. Mortar Base</b>	
(1)	[F20-OS2.1] [F20-OS2.5] [F22-OS2.4,OS2.5] Applies where the substrate for the tile contributes to the required bracing or lateral support for studs. [F20,F80-OS2.3] Applies where the substrate for the tile serves as a required environmental separation element or where the tile is installed to provide the required waterproof wall finish.
	[F20,F80-OS1.2] Applies where the substrate is required to act as fire protection for foamed plastics or to contribute to the required fire resistance of assemblies.
	[F20,F80,F81-OH1.1,OH1.2] Applies where the substrate serves as a required environmental separation element.
	[F20-OP2.1] [F20-OP2.5] [F22-OP2.4,OP2.5] Applies where the substrate for the tile contributes to the required bracing or lateral support for studs. [F20-OP2.3] Applies where the substrate for the tile serves as a required environmental separation element or where the tile is installed to provide the required waterproof wall finish.

Table 9.37.1.1. (Continued)

Functional Statements and Objectives <sup>(1)</sup>	
(2)	[F20-OS2.1] [F20-OS2.5] [F22-OS2.4,OS2.5] Applies where the substrate for the tile contributes to the required bracing or lateral support for studs. [F20,F80-OS2.3] Applies where the substrate for the tile serves as a required environmental separation element or where the tile is installed to provide the required waterproof wall finish.
	[F20,F80-OS1.2] Applies where the substrate is required to act as fire protection for foamed plastics or to contribute to the required fire resistance of assemblies.
	[F20,F80,F81-OH1.1,OH1.2] Applies where the substrate serves as a required environmental separation element.
	[F20-OP2.1] [F20-OP2.5] [F22-OP2.4,OP2.5] Applies where the substrate for the tile contributes to the required bracing or lateral support for studs. [F20-OP2.3] Applies where the substrate for the tile serves as a required environmental separation element or where the tile is installed to provide the required waterproof wall finish.
	[F20-OS2.1] [F20-OS2.5] [F22-OS2.4,OS2.5] Applies where the substrate for the tile contributes to the required bracing or lateral support for studs. [F20-OS2.3] Applies where the substrate for the tile serves as a required environmental separation element.
	[F20-OS1.2] Applies where the substrate is required to act as fire protection for foamed plastics or to contribute to the required fire resistance of assemblies. [F20,F81-OH1.1,OH1.2] Applies where the substrate serves as a required environmental separation element. [F20-OP2.1] [F20-OP2.5] [F22-OP2.4,OP2.5] Applies where the substrate for the tile contributes to the required bracing or lateral support for studs. [F20-OP2.3] Applies where the substrate for the tile serves as a required environmental separation element or where the tile is installed to provide the required waterproof wall finish.
(3)	[F20-OS2.1] [F20-OS2.5] [F22-OS2.4,OS2.5] Applies where the substrate for the tile contributes to the required bracing or lateral support for studs. [F20-OS2.3] Applies where the substrate for the tile serves as a required environmental separation element.
	[F20-OS1.2] Applies where the substrate is required to act as fire protection for foamed plastics or to contribute to the required fire resistance of assemblies.
	[F20,F81-OH1.1,OH1.2] Applies where the substrate serves as a required environmental separation element.
	[F20-OP2.1] [F20-OP2.5] [F22-OP2.4,OP2.5] Applies where the substrate for the tile contributes to the required bracing or lateral support for studs. [F20-OP2.3] Applies where the substrate for the tile serves as a required environmental separation element or where the tile is installed to provide the required waterproof wall finish.
	[F20-OS2.1] [F20-OS2.5] [F22-OS2.4,OS2.5] Applies where the substrate for the tile contributes to the required bracing or lateral support for studs. [F20-OS2.3] Applies where the substrate for the tile serves as a required environmental separation element or where the tile is installed to provide the required waterproof wall finish.
	[F20-OH1.1,OH1.2] Applies where the substrate serves as a required environmental separation element. [F20-OS1.2] Applies where the substrate is required to act as fire protection for foamed plastics or to contribute to the required fire resistance of assemblies. [F20-OP2.1] [F20-OP2.5] [F22-OP2.4,OP2.5] Applies where the substrate for the tile contributes to the required bracing or lateral support for studs. [F20-OP2.3] Applies where the substrate for the tile serves as a required environmental separation element or where the tile is installed to provide the required waterproof wall finish.
(4)	[F20-OS2.1] [F20-OS2.5] [F22-OS2.4,OS2.5] Applies where the substrate for the tile contributes to the required bracing or lateral support for studs. [F20-OS2.3] Applies where the substrate for the tile serves as a required environmental separation element or where the tile is installed to provide the required waterproof wall finish.
	[F20-OH1.1,OH1.2] Applies where the substrate serves as a required environmental separation element.
	[F20-OS1.2] Applies where the substrate is required to act as fire protection for foamed plastics or to contribute to the required fire resistance of assemblies.
	[F20-OP2.1] [F20-OP2.5] [F22-OP2.4,OP2.5] Applies where the substrate for the tile contributes to the required bracing or lateral support for studs. [F20-OP2.3] Applies where the substrate for the tile serves as a required environmental separation element or where the tile is installed to provide the required waterproof wall finish.
	[F20-OS2.1] [F20-OS2.5] [F22-OS2.4,OS2.5] Applies where the substrate for the tile contributes to the required bracing or lateral support for studs. [F20-OS2.3] Applies where the substrate for the tile serves as a required environmental separation element or where the tile is installed to provide the required waterproof wall finish.
	[F20-OH1.1,OH1.2] Applies where the substrate serves as a required environmental separation element. [F20-OS1.2] Applies where the substrate is required to act as fire protection for foamed plastics or to contribute to the required fire resistance of assemblies. [F20-OP2.1] [F20-OP2.5] [F22-OP2.4,OP2.5] Applies where the substrate for the tile contributes to the required bracing or lateral support for studs. [F20-OP2.3] Applies where the substrate for the tile serves as a required environmental separation element or where the tile is installed to provide the required waterproof wall finish.

Table 9.37.1.1. (Continued)

Functional Statements and Objectives <sup>(1)</sup>	
<b>9.29.10.3. Adhesives</b>	
(1)	[F20-OH1.1,OH1.2] Applies where the substrate serves as a required environmental separation element.
	[F20-OS2.3]
	[F20-OS1.2] Applies where the substrate is required to act as fire protection for foamed plastics or to contribute to the required fire resistance of assemblies.
	[F20-OP2.3,OP2.4]
<b>9.29.10.4. Moisture-Resistant Backing</b>	
(1)	[F81-OH1.1,OH1.2] Applies where the substrate supports or serves as a required environmental separation element.
	[F20-OS2.3]
	[F20-OS1.2] Applies where the substrate is required to act as fire protection for foamed plastics or to contribute to the required fire resistance of assemblies.
	[F81-OP2.3,OP2.4]
<b>9.29.10.5. Joints between Tiles and Bathtub</b>	
(1)	[F81-OH1.1,OH1.2] Applies where the substrate serves as a required environmental separation element.
	[F81-OS2.3]
	[F81-OS1.2] Applies where the substrate is required to act as fire protection for foamed plastics or to contribute to the required fire resistance of assemblies.
	[F81-OP2.3,OP2.4]
<b>9.30.1.1. Required Finished Flooring</b>	
(1)	[F30-OS3.1]
	[F40,F41-OH2.4]
<b>9.30.1.2. Water Resistance</b>	
(1)	[F80-OS2.3] Applies where finished flooring is required to provide water resistance.
	[F41,F81-OH1.1] Applies where finished flooring is required to provide water resistance.
<b>9.30.1.3. Sleepers</b>	
(1)	[F20,F80-OS3.1]
	[F80-OH1.1] Applies to portion of Code text: "Wood sleepers supporting finished flooring over a concrete base supported on the ground ... shall be treated with a wood preservative."
<b>9.30.2.1. Required Underlay</b>	
(1)	[F81-OS3.1]
	[F81-OS2.3] Applies where finished flooring is required to provide water resistance.
	[F81-OH1.1] Applies where finished flooring is required to provide water resistance.
(2)	[F81-OS3.1]
	[F81-OS2.3] Applies where finished flooring is required to provide water resistance.
	[F81-OH1.1] Applies where finished flooring is required to provide water resistance.



**Table 9.37.1.1. (Continued)**

Functional Statements and Objectives <sup>(1)</sup>	
(3)	[F81-OS3.1]
	[F81-OH1.1] Applies where finished flooring is required to provide water resistance.
	[F81-OS2.3] Applies where finished flooring is required to provide water resistance.
<b>9.30.2.2. Materials and Thickness</b>	
(1)	[F81-OS3.1]
	[F81-OS2.3] Applies where finished flooring is required to provide water resistance.
	[F81-OH1.1] Applies where finished flooring is required to provide water resistance.
(2)	[F81-OS2.3] Applies where finished flooring is required to provide water resistance.
	[F81-OS3.1]
	[F81-OH1.1] Applies where finished flooring is required to provide water resistance.
<b>9.30.2.3. Fastening</b>	
(1)	[F81-OS3.1]
	[F81-OS2.3] Applies where finished flooring is required to provide water resistance.
	[F81-OH1.1] Applies where finished flooring is required to provide water resistance.
(2)	[F81-OS3.1]
	[F81-OS2.3] Applies where finished flooring is required to provide water resistance.
	[F81-OH1.1] Applies where finished flooring is required to provide water resistance.
(3)	[F81-OS3.1]
	[F81-OS2.3] Applies where finished flooring is required to provide water resistance.
	[F81-OH1.1] Applies where finished flooring is required to provide water resistance.
<b>9.30.2.4. Joints Offset</b>	
(1)	[F81-OS3.1]
	[F81-OS2.3] Applies where finished flooring is required to provide water resistance.
	[F81-OH1.1] Applies where finished flooring is required to provide water resistance.
<b>9.30.2.5. Surface Defects</b>	
(1)	[F81-OS3.1]
	[F81-OS2.3] Applies where finished flooring is required to provide water resistance.
	[F81-OH1.1] Applies where finished flooring is required to provide water resistance.
<b>9.30.3.1. Thickness</b>	
(1)	[F30-OS3.1]
	[F20-OS2.1]

**Table 9.37.1.1. (Continued)**

Functional Statements and Objectives <sup>(1)</sup>	
<b>9.30.3.2. Strip Direction and End Joints</b>	
(1)	[F30-OS3.1]
(2)	[F20-OS2.1]
(3)	[F20-OS2.1]
<b>9.30.3.3. Nailing</b>	
(1)	[F30-OS3.1]
(2)	[F30-OS3.1]
<b>9.30.3.4. Staples</b>	
(1)	[F30-OS3.1]
<b>9.30.4.1. Adhesive</b>	
(1)	[F81-OS3.1]
<b>9.30.5.1. Materials</b>	
(1)	[F41,F80-OH1.1]
	[F80-OS3.1]
(2)	[F81,F80-OS3.1]
	[F41-OH1.1]
<b>9.30.6.1. Substrate</b>	
(1)	[F81-OS3.1]
	[F81-OH1.1] Applies where finished flooring is required to provide water resistance.
	[F81-OS2.3] Applies where finished flooring is required to provide water resistance.
(2)	[F81-OH1.1] Applies where finished flooring is required to provide water resistance.
	[F81-OS3.1]
	[F81-OS2.3] Applies where finished flooring is required to provide water resistance.
<b>9.31.2.2. Corrosion Protection</b>	
(1)	[F80-OH2.1]
	[F80-OS2.3]
<b>9.31.2.3. Grab Bars</b>	
(1)	[F20-OS3.1]
<b>9.31.3.1. Required Water Supply</b>	
(1)	[F70,F71-OH2.2,OH2.3]
<b>9.31.3.2. Required Connections</b>	
(1)	[F71-OH2.3]
(2)	[F71,F70-OH2.3]
<b>9.31.4.1. Required Fixtures</b>	
(1)	[F71,F70,F72-OH2.1,OH2.3]
<b>9.31.4.2. Hot Water Supply</b>	
(1)	[F71-OH2.3]
<b>9.31.4.3. Floor Drains</b>	
(1)	[F62,F40,F41-OH1.2,OH1.3] [F62-OH1.1]
(2)	[F62,F52-OH1.2,OH1.3] [F62-OH1.1]

Table 9.37.1.1. (Continued)

Functional Statements and Objectives <sup>(1)</sup>	
<b>9.31.5.1. Building Sewer</b>	
(1)	[F72-OH2.1]
<b>9.31.5.2. Discharge of Sewage</b>	
(1)	[F72-OH2.1]
(2)	[F72-OH2.1]
<b>9.31.6.1. Hot Water Supply</b>	
(1)	(a) [F40-OH2.1,OH2.4] [F71-OH2.3]
<b>9.31.6.2. Equipment and Installation</b>	
(1)	[F31,F30,F81-OS3.2] [F44-OS3.4]
(2)	[F44-OH1.1] [F01-OS1.1]
(3)	[F23-OS3.4] [F01-OS1.1]
<b>9.31.6.3. Corrosion-Resistant Coating</b>	
(1)	[F81,F80-OH2.3]
<b>9.31.6.4. Fuel-Burning Heaters</b>	
(1)	[F41-OH1.1] [F01-OS1.1]
<b>9.31.6.5. Heating Coils</b>	
(1)	[F31-OS3.2] [F71-OH2.3]
<b>9.32.1.2. Required Ventilation</b>	
(1)	[F40,F50,F52-OH1.1] [F51,F52-OH1.2]
(2)	[F40,F50,F52-OH1.1] [F51,F52-OH1.2]
<b>9.32.1.3. Venting of Laundry-Drying Equipment</b>	
(1)	[F50,F44,F40-OH1.1] [F52,F50-OH1.1] [F44-OS3.4] [F01-OS1.1] [F01-OP1.1]
(2)	[F81-OS1.1]
(3)	[F44,F50,F40-OH1.1] [F52,F50-OH1.1] [F44-OS3.4] [F01-OS1.1] [F01-OP1.1]
<b>9.32.2.1. Required Ventilation</b>	
(1)	[F40,F50,F52-OH1.1] [F51,F52-OH1.2]
<b>9.32.2.2. Non-Heating-Season Natural Ventilation</b>	
(1)	[F51,F52-OH1.2] [F40,F52,F50-OH1.1]
(3)	[F42-OH2.5] [F61,F42-OH1.1] [F61,F42-OS2.3]

Table 9.37.1.1. (Continued)

Functional Statements and Objectives <sup>(1)</sup>	
(4)	[F80-OH2.5] [F80,F42-OH1.1,OH1.2]
<b>9.32.2.3. Non-Heating-Season Mechanical Ventilation</b>	
(1)	[F40,F50,F52-OH1.1]
(3)	[F40,F50,F52-OH1.1] [F51,F52-OH1.2]
(4)	[F40,F50,F52-OH1.1] [F51,F52-OH1.2]
<b>9.32.3.1. Required Ventilation</b>	
(1)	[F40,F50,F53-OS3.4] [F40,F50,F52-OH1.1] [F51,F52-OH1.2]
(2)	(a),(b) [F40,F50,F52-OH1.1] (a),(b) [F51,F52-OH1.2] (c) [F53-OH1.1] (c) [F53-OS3.4]
<b>9.32.3.2. Design and Installation</b>	
(1)	[F52-OS2.3] [F40,F52,F50-OH1.1] [F52,F51-OH1.2]
(2)	[F81-OH1.1]
(3)	[F81-OH1.1] [F81-OS3.4]
(4)	[F40,F43,F50,F53-OH1.1] [F43,F53,F82-OS3.4]
(5)	[F82-OH1.1]
(6)	[F63,F81-OH1.1]
<b>9.32.3.3. Principal Ventilation System</b>	
(1)	[F40,F50,F52-OH1.1] [F51,F52-OH1.2]
(2)	[F40,F50,F52-OH1.1] [F51,F52-OH1.2]
(4)	[F80,F81-OH1.1]
(5)	[F81-OH1.1]
(6)	[F81-OH1.1]
(7)	[F81-OH1.1]
(8)	[F81-OH1.1]
(9)	[F40,F50,F52-OH1.1]
(10)	[F40-OH1.1]
<b>9.32.3.4. Ventilation Systems Used in Conjunction with Forced Air Heating Systems</b>	
(2)	[F50,F51,F81-OH1.1] [F51,F81-OH1.2] [F43,F50,F81-OS3.4]
(5)	[F40,F43,F50,F52-OH1.1] (a) [F43,F50,F53-OS3.4] (b) [F43,F50,F81-OS3.4]
(6)	[F53-OH1.1] [F43,F50,F53-OS3.4] [F53,F63-OS2.3]

**Table 9.37.1.1. (Continued)**

Functional Statements and Objectives <sup>(1)</sup>	
(7)	[F40,F50,F52,F53-OH1.1] [F43,F50,F53-OS3.4]
(8)	(a),(b) [F81-OH1.1] (c) [F53-OH1.1] (c) [F53,F63-OS2.3]
(9)	(a),(b) [F43,F53-OH1.1] (c) [F53,F63-OH1.1] (a),(b) [F43,F50,F53-OS3.4] (c) [F53,F63-OS2.3]
(10)	[F53-OH1.1] [F43,F50,F53-OS3.4] [F53,F63-OS2.3]
(11)	[F53-OH1.1]
(12)	[F81-OH1.2]
<b>9.32.3.5. Ventilation Systems Not Used in Conjunction with Forced Air Heating Systems</b>	
(2)	[F53-OH1.1] [F43,F50,F53-OS3.4]
(3)	(a) [F43,F53-OH1.1] (b) [F53,F63-OH1.1] (a) [F43,F50,F53-OS3.4] (b) [F53,F63-OS2.3]
(4)	[F40,F43,F50,F52-OH1.1] [F43,F50,F53-OS3.4]
(5)	[F53-OH1.1] [F53,F63-OS2.3] [F43,F50,F53-OS3.4]
(6)	[F53-OH1.1] [F53,F63-OS2.3] [F43,F50,F53-OS3.4]
(7)	[F53-OH1.1]
(8)	[F51,F54-OH1.2]
(9)	[F54-OH1.2]
(10)	[F40,F50,F52-OH1.1]
(12)	[F40,F50,F52-OH1.1]
(13)	[F51,F54-OH1.2]
(14)	[F40,F50,F52-OH1.1]
<b>9.32.3.6. Exhaust-Only Ventilation Systems</b>	
(1)	[F40,F50,F52-OH1.1] [F43-OS3.4]
(2)	[F40,F50,F52-OH1.1]
(3)	[F40,F50,F52-OH1.1]
<b>9.32.3.7. Supplemental Exhaust</b>	
(1)	[F40,F52-OH1.1]

**Table 9.37.1.1. (Continued)**

Functional Statements and Objectives <sup>(1)</sup>	
(3)	[F40,F52-OH1.1]
(4)	[F40,F52-OH1.1]
(5)	[F40,F52-OH1.1]
(6)	[F81-OH1.1]
(7)	[F81-OH1.1]
(8)	[F81-OH1.1]
<b>9.32.3.8. Protection Against Depressurization</b>	
(2)	[F53-OH1.1] (a) [F43,F50,F53-OS3.4] (b) [F53,F63-OS2.3]
(3)	[F53,F81-OH1.1] [F43,F50,F53,F81-OS3.4]
(4)	[F81-OS3.4] [F81-OH1.1,OH1.2]
(5)	[F53-OH1.1] [F81-OS1.1] [F80,F81-OS3.4]
(7)	[F43,F50,F53-OS3.4] [F53-OH1.1]
<b>9.32.3.9. Carbon Monoxide Alarms</b>	
(2)	(a),(b),(d) [F44-OS3.4] (c) [F81-OS3.4]
(3)	[F44-OS3.4]
(4)	[F44-OS3.4]
(5)	[F44-OS3.4]
(6)	[F44-OS3.4]
(7)	[F11-OS3.4]
<b>9.32.3.10. Fans</b>	
(1)	[F40,F50,F52,F53-OH1.1] [F51,F52-OH1.2] [F53,F63-OS2.3]
(2)	[F81-OH1.1,OH1.2]
(3)	[F53-OH1.1,OH1.2] [F53-OS3.4]
(4)	[F40,F50,F52,F53-OH1.1] [F51,F52-OH1.2]
(5)	[F81-OH1.1,OH1.2]
(6)	[F81-OS3.4] [F81-OH1.1,OH1.2]
(7)	[F40,F50,F52,F53-OH1.1] [F51,F52-OH1.2] [F81-OS3.4]
<b>9.32.3.11. Ducts</b>	
(1)	[F81-OH1.1]
(2)	[F40,F52,F63-OH1.1] [F52,F63-OS2.3]

Copyright © NRC 1941 - 2021 World Rights Reserved © CNRC 1941-2021 Droits réservés pour tous pays

Table 9.37.1.1. (Continued)

Functional Statements and Objectives <sup>(1)</sup>	
(3)	[F63-OH1.1] [F63,F80-OS2.3]
(4)	[F63-OH1.1]
(5)	[F41,F82-OH1.1] [F01,F82-OS1.1]
(6)	(a),(b),(c) [F02,F03-OS1.1] (a) [F80-OS1.1] (c) [F82-OS1.1]
(7)	[F41,F53,F80-OH1.1]
(8)	[F40,F41-OH1.1] [F40,F63-OS2.3]
(9)	[F40,F50,F52,F53-OH1.1] [F53-OS3.4]
(12)	[F40,F50,F52,F53-OH1.1] [F53-OS3.4]
<b>9.32.3.12. Heat Recovery Ventilators</b>	
(2)	[F40,F50,F52-OH1.1]
(3)	[F40,F50,F52-OH1.1]
(4)	[F53-OH1.1,OH1.2] [F53,F63-OS2.3] [F43,F53-OS3.4]
(5)	[F62-OH1.1]
(6)	[F81-OH1.1]
<b>9.32.3.13. Outdoor Intake and Exhaust Openings</b>	
(1)	[F40,F50,F52-OH1.1] [F40,F44,F50-OS3.4]
(2)	[F40,F50,F52,F53-OH1.1] [F43,F53-OS3.4]
(3)	[F40,F50,F52-OH1.1] [F40,F50,F44-OS3.4]
(4)	[F40,F50,F52-OH1.1] [F40,F44,F50,F53-OS3.4]
(5)	[F40,F53-OH1.1]
(6)	[F61-OH1.1] [F61-OS2.3]
(7)	[F42-OH1.1] [F01,F42-OS1.1] [F42-OH2.5]
(8)	[F42,F63-OH1.1] [F01,F42-OS1.1]
(9)	[F42-OH1.1] [F01,F42-OS1.1]
(10)	[F53,F82-OH1.1] [F43,F53,F82-OS3.4]

Table 9.37.1.1. (Continued)

Functional Statements and Objectives <sup>(1)</sup>	
(11)	[F53,F81-OH1.1] [F43,F53-OS3.4]
(12)	[F42,F80-OH2.5] [F01,F42,F80-OS1.1]
<b>9.33.1.1. Application</b>	
(3)	[F40-OH1.1] [F40-OS3.4]
<b>9.33.2.1. Required Heating Systems</b>	
(1)	[F51,F52-OH1.2] [F63-OH1.1] [F63-OS2.3]
<b>9.33.3.1. Indoor Design Temperatures</b>	
(1)	[F51-OH1.2]
<b>9.33.4.1. Design of Heating and Air-conditioning Systems</b>	
(1)	[F41,F63-OH1.1] [F51,F52-OH1.2] [F63-OS2.3] Applies only to heating systems. [F44-OS3.4] Applies only to heating systems.
<b>9.33.4.2. Installation of Hydronic Heating Systems</b>	
(1)	[F01-OS1.1] [F01-OP1.1] [F63-OH1.1] [F51,F52-OH1.2] [F63-OS2.3] [F44-OS3.4] Applies to heating equipment.
<b>9.33.4.3. Heating System Control</b>	
(1)	[F51,F52-OH1.2] [F63-OH1.1]
<b>9.33.4.4. Access</b>	
(1)	[F82-OH1.1,OH1.2] [F82-OS2.3] Applies only to heating systems. [F82-OS1.1] [F82-OP1.1]
<b>9.33.4.5. Protection from Freezing</b>	
(1)	[F81-OH1.1,OH1.2] [F81-OS2.3] Applies only to heating systems.
<b>9.33.4.6. Expansion, Contraction and System Pressure</b>	
(1)	[F20-OH1.1,OH1.2] [F20-OS2.3] [F20-OS2.3] Applies only to heating systems.
<b>9.33.4.7. Structural Movement</b>	
(1)	[F23-OS3.4] [F23-OH1.1,OH1.2] [F23-OS1.1] [F23-OP1.1]
(2)	[F20-OS3.3,OS3.4] [F20-OS1.1]

**Table 9.37.1.1. (Continued)**

Functional Statements and Objectives <sup>(1)</sup>	
<b>9.33.4.8. Asbestos</b>	
(1)	[F43-OH1.1]
<b>9.33.4.9. Contaminant Transfer</b>	
(1)	[F44-OH1.1] [F44-OS3.4]
<b>9.33.5.1. Capacity of Heating Appliances</b>	
(1)	[F63-OH1.1] [F51-OH1.2] [F63-OS2.3]
<b>9.33.5.2. Installation Standards</b>	
(1)	[F01-OP1.1] Applies to heating equipment. [F41,F63,F50-OH1.1] [F51,F52-OH1.2] [F63-OS2.3] Applies to heating equipment. [F44-OS3.4] Applies to heating equipment. [F01-OS1.1] Applies to heating equipment.
<b>9.33.5.3. Design, Construction and Installation Standard for Solid-Fuel-Burning Appliances</b>	
(1)	[F41,F43-OH1.1] [F51-OH1.2] [F51-OS2.3] [F43-OS3.4] [F01-OS1.1] [F01-OP1.1]
<b>9.33.6.2. Materials in Air Duct Systems</b>	
(1)	[F01-OS1.1] [F01-OP1.1]
(2)	(a),(b),(c),(d) [F01-OS1.1] (a),(b),(c),(d) [F01-OP1.1]
(3)	[F01-OS1.1] [F01-OP1.1]
(4)	(a),(b),(c),(d) [F01-OS1.1] (a),(b),(c),(d) [F01-OP1.1]
(7)	(a),(b) [F41,F63-OH1.1] [F50,F51,F52-OH1.2] (a),(b) [F63-OS2.3]
<b>9.33.6.3. Tape</b>	
(1)	[F01-OS1.1] [F01-OP1.1]
<b>9.33.6.4. Coverings, Linings, Adhesives and Insulation</b>	
(1)	[F01-OS1.1] [F01-OP1.1]
(2)	(a),(b) [F01-OS1.1] (a),(b) [F01-OP1.1]
(3)	(a),(b) [F01-OS1.1] (a),(b) [F01-OP1.1]

**Table 9.37.1.1. (Continued)**

Functional Statements and Objectives <sup>(1)</sup>	
(4)	[F01-OS1.1] [F01-OP1.1]
(5)	[F01-OS1.1] [F01-OP1.1]
(6)	[F01-OS1.1] (c) [F01,F02,F05-OS1.5] [F01-OP1.1]
(7)	[F01-OS1.1] [F01-OP1.1]
(8)	(a),(b) [F01,F03-OS1.1] (a),(b) [F01,F03-OP1.1]
(9)	[F63-OH1.1] Applies to ventilation ducts and their fittings. [F51,F52-OH1.2] Applies to air duct distribution systems serving heating systems. [F03-OS1.1] Applies to air duct distribution systems. [F03-OP1.1] Applies to air duct distribution systems. [F63-OS2.3] Applies to air duct distribution systems.
<b>9.33.6.5. Galvanized Steel or Aluminum Supply Ducts</b>	
(1)	[F20-OH1.1,OH1.2] [F01-OS1.1] [F01-OP1.1]
(2)	[F20,F63-OH1.1] [F20,F51,F52-OH1.2] [F20,F63-OS2.3]
<b>9.33.6.6. Construction of Ducts and Plenums</b>	
(1)	[F03-OS1.1] [F03-OP1.1]
(2)	[F01-OS1.1] [F20-OS3.1] [F63-OH1.1] [F51,F52-OH1.2] [F20,F63-OS2.3]
(3)	[F43,F63-OH1.1] [F51,F52-OH1.2] [F01-OS1.1] [F63-OS2.3] [F01-OP1.1]
(4)	[F43,F63-OH1.1] [F51,F52-OH1.2] [F63-OS2.3] [F01-OS1.1] [F01-OP1.1]
(5)	[F63-OH1.1] [F51,F52-OH1.2] [F63-OS2.3] [F01-OS1.1] [F01-OP1.1]

Table 9.37.1.1. (Continued)

Functional Statements and Objectives <sup>(1)</sup>	
<b>9.33.6.7. Installation of Ducts and Plenums</b>	
(1)	[F40-OH1.1]
	[F40-OS3.4]
(2)	[F63-OH1.1] [F51,F52-OH1.2]
	[F63-OS2.3]
	[F01-OS1.1]
	[F01-OP1.1]
(3)	[F63-OH1.1] [F51,F52-OH1.2]
	[F63-OS2.3]
	[F20-OS3.1]
(4)	[F51,F52-OH1.2] [F63,F50-OH1.1]
	[F63,F80-OS2.3]
(5)	[F01-OS1.1]
	[F01-OP1.1]
(6)	[F80-OH1.1,OH1.2]
	[F80-OS2.3]
(7)	(a),(b) [F40,F62-OH1.1,OH1.2]
	(a),(b) [F40,F62-OS2.3]
	(b) [F44-OS3.4]
<b>9.33.6.8. Clearances of Ducts and Plenums</b>	
(2)	(a),(b) [F01-OS1.1]
	(a),(b) [F01-OP1.1]
(3)	(a),(b) [F01-OS1.1]
	(a),(b) [F01-OP1.1]
(4)	(a),(b),(c) [F01-OS1.1]
	(a),(b),(c) [F01-OP1.1]
(5)	[F01-OS1.1]
	[F01-OP1.1]
<b>9.33.6.9. Adjustable Dampers and Balance Stops</b>	
(1)	[F40,F63-OH1.1] [F51,F52-OH1.2]
	[F63-OS2.3] Applies to branch <i>supply ducts</i> that are not fitted with diffusers with adjustable balance stops.
<b>9.33.6.10. Warm-Air Supply Outlets and Return Inlets — General</b>	
(1)	[F81-OS1.1]
	[F81-OH1.1,OH1.2]
	[F81-OS2.3]
(2)	(a),(b) [F01,F02-OS1.1]
	(a),(b) [F01,F02-OP1.1]
<b>9.33.6.11. Warm-Air Supply Outlets</b>	
(1)	[F40,F63-OH1.1] [F51,F52-OH1.2]
	[F63-OS2.3]
(2)	[F63-OH1.1] [F51-OH1.2]
	[F63-OS2.3]

Table 9.37.1.1. (Continued)

Functional Statements and Objectives <sup>(1)</sup>	
(3)	[F40,F63-OH1.1] [F51-OH1.2]
(4)	[F40,F63-OH1.1] [F51-OH1.2]
	[F63-OS2.3]
(5)	[F40,F63-OH1.1] [F51-OH1.2]
	[F63-OS2.3]
(6)	[F40,F63-OH1.1] [F51-OH1.2]
	[F63-OS2.3]
(8)	[F31-OS3.2]
(9)	[F40,F63-OH1.1] [F51-OH1.2]
	[F63-OS2.3] Applies to warm-air supply outlets located in finished areas.
<b>9.33.6.12. Return-Air Inlets</b>	
(1)	[F44,F40-OH1.1]
	[F44,F40-OS3.4]
(2)	[F63-OH1.1] [F51-OH1.2]
(3)	[F63-OH1.1] [F51-OH1.2]
	[F63-OS2.3]
<b>9.33.6.13. Return-Air System</b>	
(1)	[F63-OH1.1] [F51-OH1.2]
	[F63-OS2.3]
(2)	[F01-OS1.1]
	[F01-OP1.1]
(3)	[F01-OS1.1]
	[F01-OP1.1]
(4)	(a),(b),(c) [F01-OS1.1]
	(a),(b),(c) [F01-OP1.1]
(5)	[F51,F52-OH1.1,OH1.2]
	[F51,F52-OS2.3]
(6)	[F63-OH1.1] [F51-OH1.2]
	[F63-OS2.3]
(7)	(a),(b) [F44-OH1.1]
	(a),(b) [F44-OS3.4]
<b>9.33.6.14. Filters and Odour Removal Equipment</b>	
(1)	[F01-OS1.1]
	[F01-OP1.1]
(2)	[F32-OS3.3]
	[F41-OH1.1]
(3)	(a),(b) [F81-OH1.1]
<b>9.33.7.1. Recessed Radiators and Convectors</b>	
(1)	[F01-OS1.1]
	[F01-OP1.1]
<b>9.33.7.2. Surface Temperature</b>	
(1)	[F31-OS3.2]

**Table 9.37.1.1. (Continued)**

Functional Statements and Objectives <sup>(1)</sup>	
<b>9.33.8.1. Piping Materials and Installation</b>	
(1)	[F20-OS3.2]
	[F20-OH1.1,OH1.2]
(2)	[F21,F40-OH1.1] [F21,F51-OH1.2]
(3)	[F20-OS2.2]
<b>9.33.8.2. Insulation and Coverings</b>	
(1)	[F80-OH1.2]
	[F80-OS3.2]
(2)	(a),(b) [F01-OS1.1]
	(a),(b) [F01-OP1.1]
(3)	(a),(b) [F01,F02-OS1.1,OS1.2]
	(a),(b) [F01,F02-OP1.1,OP1.2]
(4)	[F01,F02-OS1.1,OS1.2]
	[F01,F02-OP1.1]
(5)	[F31-OS3.2]
<b>9.33.8.3. Clearances</b>	
(1)	[F01-OS1.1]
	[F01-OP1.1]
<b>9.33.8.4. Protection</b>	
(1)	[F01-OS1.1]
	[F01-OP1.1]
(2)	[F01-OS1.1]
	[F01-OP1.1]
<b>9.33.9.1. Cooling Units</b>	
(1)	(a),(b),(c) [F43-OH1.1] [F51-OH1.2]
<b>9.33.10.2. Factory-Built Chimneys</b>	
(1)	[F01-OS1.1]
	[F44-OS3.4]
	[F44,F41-OH1.1]
	[F01-OP1.1]
<b>9.34.1.1. Standard for Electrical Installations</b>	
(1)	[F32-OS3.3]
	[F01-OS1.1]
	[F01-OP1.1]
<b>9.34.1.3. Location of Equipment in Public Areas</b>	
(1)	[F10-OS3.1] [F32-OS3.3]
<b>9.34.1.4. Recessed Lighting Fixtures</b>	
(1)	[F01-OS1.1]
<b>9.34.1.5. Wiring and Cables</b>	
(1)	[F02-OS1.2]
	[F02-OP1.2]

**Table 9.37.1.1. (Continued)**

Functional Statements and Objectives <sup>(1)</sup>	
<b>9.34.2.1. Lighting of Entrances</b>	
(1)	[F30-OS3.1]
	[F34-OS4.2]
<b>9.34.2.2. Outlets in Dwelling Units</b>	
(1)	[F30-OS3.1]
(2)	[F30-OS3.1]
<b>9.34.2.3. Stairways</b>	
(1)	[F30-OS3.1]
(2)	[F30-OS3.1]
<b>9.34.2.4. Basements</b>	
(1)	[F30-OS3.1]
(2)	[F30-OS3.1]
<b>9.34.2.5. Storage Rooms</b>	
(1)	[F30-OS3.1]
<b>9.34.2.6. Garages and Carports</b>	
(1)	[F30-OS3.1]
(2)	[F30-OS3.1]
(3)	[F30-OS3.1]
<b>9.34.2.7. Public and Service Areas</b>	
(1)	[F30-OS3.1]
(2)	[F30-OS3.1]
(3)	[F30-OS3.1]
<b>9.35.2.2. Garage Floor</b>	
(1)	[F40-OS1.1]
<b>9.35.3.2. Protection from Damage due to Soil Movement</b>	
(1)	[F21-OS2.3]
	[F21-OH1.1,OH1.2,OH1.3]
	[F21-OP2.3,OP2.4]
	[F21-OH4] Applies to floors and elements that support floors.
(2)	[F21-OS3.1] Applies to floors and elements that support floors.
	[F21-OS2.3]
	[F21-OH1.1,OH1.2,OH1.3]
	[F21-OP2.3,OP2.4]
(2)	[F21-OH4] Applies to floors and elements that support floors.
	[F21-OS3.1] Applies to floors and elements that support floors.
	[F21-OS3.1] Applies to floors and elements that support floors.
<b>9.35.3.4. Column Piers</b>	
(1)	[F80-OS2.3]
	[F80-OP2.3]
(2)	[F20-OS2.1,OS2.2]
	[F20-OP2.1,OP2.2]
<b>9.35.4.2. Columns</b>	
(1)	[F20-OS2.1]
	[F20-OP2.1]

Copyright © NRC 1941 - 2021 World Rights Reserved © CNRC 1941-2021 Droits réservés pour tous pays

Table 9.37.1.1. (Continued)

Functional Statements and Objectives <sup>(1)</sup>	
<b>9.35.4.3. Anchorage</b>	
(1)	[F22-OS2.4,OS2.5]
	[F22-OP2.4,OP2.5]
<b>9.36.2.2. Determination of Thermal Characteristics of Materials, Components and Assemblies</b>	
(1)	[F92-OE1.1]
(2)	[F92-OE1.1]
(3)	[F92-OE1.1]
(4)	[F92-OE1.1]
(5)	[F92-OE1.1]
<b>9.36.2.4. Calculation of Effective Thermal Resistance of Assemblies</b>	
(1)	[F92-OE1.1]
(3)	[F92-OE1.1]
<b>9.36.2.5. Continuity of Insulation</b>	
(1)	[F92-OE1.1]
(2)	[F92-OE1.1]
(3)	[F92-OE1.1]
(4)	[F92-OE1.1]
(5)	[F92-OE1.1]
(6)	[F92-OE1.1]
(7)	[F92-OE1.1]
(8)	[F92-OE1.1]
<b>9.36.2.6. Thermal Characteristics of Above-ground Opaque Building Assemblies</b>	
(1)	[F92-OE1.1]
(2)	[F92-OE1.1]
(3)	[F92-OE1.1]
(4)	[F92-OE1.1]
<b>9.36.2.7. Thermal Characteristics of Fenestration, Doors and Skylights</b>	
(1)	[F92-OE1.1]
(2)	[F92-OE1.1]
(3)	[F92-OE1.1]
(4)	[F92-OE1.1]
(5)	[F92-OE1.1]
(7)	[F92-OE1.1]
(8)	[F92-OE1.1]
<b>9.36.2.8. Thermal Characteristics of Building Assemblies Below-Grade or in Contact with the Ground</b>	
(1)	[F92-OE1.1]
(3)	[F92-OE1.1]
(4)	[F92-OE1.1]
(5)	[F92-OE1.1]
(6)	[F92-OE1.1]

Table 9.37.1.1. (Continued)

Functional Statements and Objectives <sup>(1)</sup>	
(7)	[F92-OE1.1]
(8)	[F92-OE1.1]
(9)	[F92-OE1.1]
<b>9.36.2.9. Airtightness</b>	
(1)	[F90-OE1.1]
(2)	[F90-OE1.1]
(3)	[F90-OE1.1]
(4)	[F90-OE1.1]
(5)	[F90-OE1.1]
(6)	[F90-OE1.1]
<b>9.36.2.10. Construction of Air Barrier Details</b>	
(1)	[F90-OE1.1]
(2)	[F90-OE1.1]
(3)	[F90-OE1.1]
(4)	[F90-OE1.1]
(5)	[F90-OE1.1]
(6)	[F90-OE1.1]
(17)	[F90-OE1.1]
<b>9.36.2.11. Trade-off Options for Above-ground Building Envelope Components and Assemblies</b>	
(2)	[F92-OE1.1]
(3)	[F92-OE1.1]
(4)	[F92-OE1.1]
(5)	[F92-OE1.1]
(6)	[F92-OE1.1]
(7)	[F92-OE1.1]
(8)	[F92-OE1.1]
<b>9.36.3.2. Equipment and Ducts</b>	
(1)	[F95-OE1.1]
(3)	[F91,F93-OE1.1]
(4)	[F91,F93-OE1.1]
(5)	[F91,F93-OE1.1]
<b>9.36.3.3. Air Intake and Outlet Dampers</b>	
(1)	[F91,F95-OE1.1]
(2)	[F91,F95-OE1.1]
<b>9.36.3.4. Piping for Heating and Cooling Systems</b>	
(2)	[F93-OE1.1]
<b>9.36.3.5. Equipment for Heating and Air-conditioning Systems</b>	
(1)	[F98-OE1.1]
<b>9.36.3.6. Temperature Controls</b>	
(1)	[F92-OE1.1]
(2)	[F95,F98-OE1.1]
(3)	[F95-OE1.1]



**Table 9.37.1.1. (Continued)**

Functional Statements and Objectives <sup>(1)</sup>	
(4)	[F95-OE1.1]
(5)	[F95-OE1.1]
(6)	[F95-OE1.1]
(7)	[F95-OE1.1]
<b>9.36.3.7. Humidification</b>	
(1)	[F95-OE1.1]
<b>9.36.3.8. Heat Recovery from Dehumidification in Spaces with an Indoor Pool or Hot Tub</b>	
(1)	[F95,F100-OE1.1]
(3)	[F95-OE1.1]
(4)	[F98,F100-OE1.1]
(5)	[F98,F100-OE1.1]
<b>9.36.3.9. Heat Recovery from Ventilation Systems</b>	
(2)	[F95,F100-OE1.1]
(3)	[F95,F100-OE1.1]
(4)	[F95,F98,F100-OE1.1]
<b>9.36.3.10. Equipment Efficiency</b>	
(1)	[F95,F98,F99-OE1.1]
(2)	[F95,F98,F99-OE1.1]
<b>9.36.3.11. Solar Thermal Systems</b>	
(1)	[F95,F98,F99-OE1.1]
(3)	[F93,F96-OE1.1]
<b>9.36.4.2. Equipment Efficiency</b>	
(1)	[F96,F98-OE1.1]
(2)	[F93,F96-OE1.1]
(3)	[F98-OE1.1]
<b>9.36.4.3. Solar Domestic Hot Water Systems</b>	
(1)	[F96,F98-OE1.1]
(3)	[F93,F96-OE1.1]
<b>9.36.4.4. Piping</b>	
(1)	[F93,F96-OE1.1]
(2)	[F93,F96-OE1.1]
(3)	[F93,F96-OE1.1]
<b>9.36.4.5. Controls</b>	
(1)	[F96-OE1.1]
<b>9.36.4.6. Indoor Swimming Pool Equipment Controls</b>	
(1)	[F96-OE1.1]
(2)	[F96-OE1.1]
<b>9.36.5.3. Compliance</b>	
(1)	[F99-OE1.1]
(2)	[F92,F93,F95,F96,F98,F99,F100-OE1.1]
(3)	[F92,F93,F95,F96,F98,F99,F100-OE1.1]
(4)	[F92,F93,F95,F96,F98,F99,F100-OE1.1]

**Table 9.37.1.1. (Continued)**

Functional Statements and Objectives <sup>(1)</sup>	
(5)	[F92,F93,F95,F96,F98,F99,F100-OE1.1]
(6)	[F99-OE1.1]
<b>9.36.5.4. Calculation Methods</b>	
(1)	[F99-OE1.1]
(3)	[F99-OE1.1]
(4)	[F99-OE1.1]
(5)	[F95,F99-OE1.1]
(6)	[F95,F99-OE1.1]
(7)	[F95,F99-OE1.1]
(8)	[F99-OE1.1]
(9)	[F99-OE1.1]
(10)	[F90,F99-OE1.1]
(11)	[F90,F99-OE1.1]
<b>9.36.5.5. Climatic Data</b>	
(1)	[F99-OE1.1]
(2)	[F99-OE1.1]
(3)	[F99-OE1.1]
<b>9.36.5.6. Building Envelope Calculations</b>	
(1)	[F92,F99-OE1.1]
(2)	[F92,F99-OE1.1]
(3)	[F92,F99-OE1.1]
(4)	[F92,F99-OE1.1]
(5)	[F92,F99-OE1.1]
(6)	[F92,F99-OE1.1]
(7)	[F92,F93,F95,F96,F99-OE1.1]
(8)	[F92,F99-OE1.1]
(9)	[F92,F99-OE1.1]
(10)	[F92,F99-OE1.1]
(11)	[F92,F99-OE1.1]
<b>9.36.5.7. HVAC System Calculations</b>	
(1)	[F95,F99-OE1.1]
(2)	[F95,F99-OE1.1]
(3)	[F95,F99-OE1.1]
(4)	[F95,F99-OE1.1]
(5)	[F95,F99-OE1.1]
(6)	[F95,F99-OE1.1]
(7)	[F95,F99-OE1.1]
(8)	[F95,F99-OE1.1]
(9)	[F95,F99-OE1.1]
<b>9.36.5.8. Service Water Heating System Calculations</b>	
(1)	[F96,F99-OE1.1]
(2)	[F96,F99-OE1.1]
(3)	[F96,F99-OE1.1]

Table 9.37.1.1. (Continued)

Functional Statements and Objectives <sup>(1)</sup>	
(4)	[F96,F99-OE1.1]
(5)	[F96,F99-OE1.1]
(6)	[F96,F99-OE1.1]
<b>9.36.5.9. General Requirements for Modeling the Proposed House</b>	
(1)	[F99-OE1.1]
<b>9.36.5.10. Modeling Building Envelope of Proposed House</b>	
(1)	[F92,F95,F99-OE1.1]
(4)	[F92,F95,F99-OE1.1]
(5)	[F92,F95,F99-OE1.1]
(6)	[F92,F95,F99-OE1.1]
(7)	[F92,F95,F99-OE1.1]
(9)	[F90,F91,F92,F95,F99-OE1.1]
(10)	[F90,F99-OE1.1]
(11)	[F90,F99-OE1.1]
(12)	[F90,F99-OE1.1]
(13)	[F90,F99-OE1.1]
<b>9.36.5.11. Modeling HVAC System of Proposed House</b>	
(1)	[F95,F99-OE1.1]
(2)	[F95,F99-OE1.1]
(3)	[F92,F95,F99-OE1.1]
(4)	[F95,F99,F100-OE1.1]
(5)	[F95,F99-OE1.1]
(6)	[F95,F99-OE1.1]
(7)	[F99-OE1.1]
(8)	[F95,F99-OE1.1]
(9)	[F95,F99-OE1.1]
(10)	[F95,F99,F100-OE1.1]
(11)	[F95,F99-OE1.1]
(12)	[F95,F99,F100-OE1.1]
(13)	[F95,F99-OE1.1]
(14)	[F95,F99,F100-OE1.1]
(15)	[F95,F99-OE1.1]
(16)	[F95,F99-OE1.1]
(17)	[F95,F99-OE1.1]
(18)	[F95,F99-OE1.1]
(19)	[F95,F99-OE1.1]
(20)	[F95,F99-OE1.1]
<b>9.36.5.12. Modeling Service Water Heating System of Proposed House</b>	
(1)	[F96,F99-OE1.1]
(2)	[F99-OE1.1]
<b>9.36.5.13. General Requirements for Modeling the Reference House</b>	
(1)	[F99-OE1.1]

Table 9.37.1.1. (Continued)

Functional Statements and Objectives <sup>(1)</sup>	
(2)	[F99-OE1.1]
<b>9.36.5.14. Modeling Building Envelope of Reference House</b>	
(1)	[F92,F95,F99-OE1.1]
(2)	[F90,F91,F92,F95,F99-OE1.1]
(3)	[F92,F95,F99-OE1.1]
(4)	[F92,F95,F99-OE1.1]
(5)	[F92,F99-OE1.1]
(6)	[F92,F95,F99-OE1.1]
(7)	[F92,F99-OE1.1]
(8)	[F92,F99-OE1.1]
(9)	[F92,F99,F95-OE1.1]
(10)	[F92,F99-OE1.1]
<b>9.36.5.15. Modeling HVAC System of Reference House</b>	
(1)	[F95,F99-OE1.1]
(2)	[F95,F99-OE1.1]
(3)	[F95,F99,F100-OE1.1]
(4)	[F95,F99-OE1.1]
(5)	[F95,F99-OE1.1]
(6)	[F95,F99-OE1.1]
(7)	[F95,F99-OE1.1]
(8)	[F95,F99,F100-OE1.1]
(9)	[F95,F99-OE1.1]
(10)	[F95,F99-OE1.1]
(11)	[F95,F99-OE1.1]
(12)	[F95,F99,F100-OE1.1]
(13)	[F95,F99,F100-OE1.1]
(14)	[F95,F99-OE1.1]
(15)	[F95,F99-OE1.1]
(16)	[F95,F99-OE1.1]
<b>9.36.5.16. Modeling Service Water Heating System of Reference House</b>	
(1)	[F95,F99-OE1.1]
(2)	[F95,F99-OE1.1]
(3)	[F95,F99-OE1.1]

**Notes to Table 9.37.1.1.:**

(1) See Parts 2 and 3 of Division A.

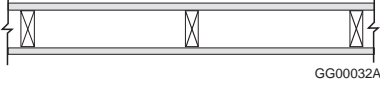
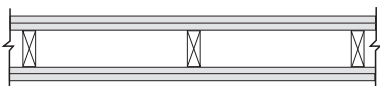
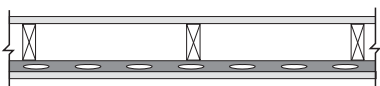
---

# **Fire and Sound Resistance Tables**

# Fire and Sound Resistance Tables

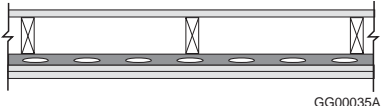
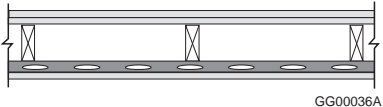
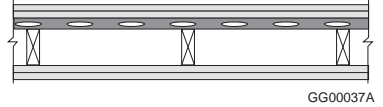
**Table 9.10.3.1.-A**  
**Fire and Sound Resistance of Walls<sup>(1)</sup>**

Forming Part of Article 5.8.1.3., Sentence 9.10.3.1.(1), Articles 9.11.1.3. and 9.11.1.4., and Sentence 9.29.5.9.(5)

Type of Wall	Wall Number	Description	Fire-Resistance Rating <sup>(2)(3)</sup>		Typical Sound Transmission Class <sup>(2)(4)(5)</sup>
			Loadbearing	Non-Loadbearing	
• Wood Studs	<b>W1</b>	<ul style="list-style-type: none"> <li>• 38 mm x 89 mm studs spaced 400 mm or 600 mm o.c.</li> <li>• with or without absorptive material</li> <li>• 1 layer of gypsum board on each side</li> </ul>	 GG00032A		
• Single Row	W1a	<ul style="list-style-type: none"> <li>• W1 with</li> <li>• 89 mm thick absorptive material<sup>(6)</sup></li> <li>• 15.9 mm Type X gypsum board<sup>(7)</sup></li> </ul>	1 h	1 h	36
• Loadbearing or Non-Loadbearing	W1b	<ul style="list-style-type: none"> <li>• W1 with</li> <li>• 89 mm thick absorptive material<sup>(6)</sup></li> <li>• 12.7 mm Type X gypsum board<sup>(7)</sup></li> </ul>	45 min [1 h <sup>(8)</sup> ]	45 min [1 h <sup>(8)</sup> ]	34
	W1c	<ul style="list-style-type: none"> <li>• W1 with</li> <li>• 89 mm thick absorptive material<sup>(6)</sup></li> <li>• 12.7 mm regular gypsum board<sup>(7)(9)</sup></li> </ul>	30 min	30 min [45 min <sup>(8)</sup> ]	32
	W1d	<ul style="list-style-type: none"> <li>• W1 with</li> <li>• no absorptive material</li> <li>• 15.9 mm Type X gypsum board<sup>(7)</sup></li> </ul>	1 h	1 h	32
	W1e	<ul style="list-style-type: none"> <li>• W1 with</li> <li>• no absorptive material</li> <li>• 12.7 mm Type X gypsum board<sup>(7)</sup></li> </ul>	45 min	45 min	32
	<b>W2</b>	<ul style="list-style-type: none"> <li>• 38 mm x 89 mm studs spaced 400 mm or 600 mm o.c.</li> <li>• with or without absorptive material</li> <li>• 2 layers of gypsum board on each side</li> </ul>	 GG00033A		
	W2a	<ul style="list-style-type: none"> <li>• W2 with</li> <li>• 89 mm thick absorptive material<sup>(6)</sup></li> <li>• 15.9 mm Type X gypsum board<sup>(7)</sup></li> </ul>	1.5 h	2 h	38
	W2b	<ul style="list-style-type: none"> <li>• W2 with</li> <li>• 89 mm thick absorptive material<sup>(6)</sup></li> <li>• 12.7 mm Type X gypsum board<sup>(7)</sup></li> </ul>	1 h	1.5 h	38
	W2c	<ul style="list-style-type: none"> <li>• W2 with</li> <li>• 89 mm thick absorptive material<sup>(6)</sup></li> <li>• 12.7 mm regular gypsum board<sup>(7)</sup></li> </ul>	45 min	1 h	36
	W2d	<ul style="list-style-type: none"> <li>• W2 with</li> <li>• no absorptive material</li> <li>• 15.9 mm Type X gypsum board<sup>(7)</sup></li> </ul>	1.5 h	2 h	36
	W2e	<ul style="list-style-type: none"> <li>• W2 with</li> <li>• no absorptive material</li> <li>• 12.7 mm Type X gypsum board<sup>(7)</sup></li> </ul>	1 h	1.5 h	35
	W2f	<ul style="list-style-type: none"> <li>• W2 with</li> <li>• no absorptive material</li> <li>• 12.7 mm regular gypsum board<sup>(7)</sup></li> </ul>	45 min	1 h	34
	<b>W3</b>	<ul style="list-style-type: none"> <li>• 38 mm x 89 mm studs spaced 400 mm or 600 mm o.c.</li> <li>• 89 mm thick absorptive material<sup>(6)</sup></li> <li>• resilient metal channels on one side spaced 400 mm or 600 mm o.c.</li> <li>• 1 layer of gypsum board on each side</li> </ul>	 GG00034A		
	W3a	<ul style="list-style-type: none"> <li>• W3 with</li> <li>• studs spaced 400 mm o.c.</li> <li>• 15.9 mm Type X gypsum board<sup>(7)</sup></li> </ul>	45 min	1 h	45
	W3b	<ul style="list-style-type: none"> <li>• W3 with</li> <li>• studs spaced 600 mm o.c.</li> <li>• 15.9 mm Type X gypsum board<sup>(7)</sup></li> </ul>	45 min	1 h	48
	W3c	<ul style="list-style-type: none"> <li>• W3 with</li> <li>• studs spaced 400 mm or 600 mm o.c.</li> <li>• 12.7 mm Type X gypsum board<sup>(7)</sup></li> </ul>	45 min	45 min	43

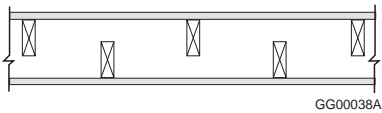
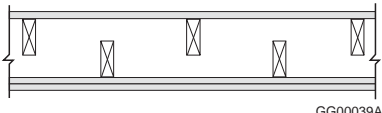
# Fire and Sound Resistance Tables

**Table 9.10.3.1.-A (Continued)**

Type of Wall	Wall Number	Description	Fire-Resistance Rating <sup>(2)(3)</sup>		Typical Sound Transmission Class <sup>(2)(4)(5)</sup>
			Loadbearing	Non-Loadbearing	
	<b>W4</b>	<ul style="list-style-type: none"> <li>• 38 mm x 89 mm studs spaced 400 mm or 600 mm o.c.</li> <li>• 89 mm thick absorptive material<sup>(6)</sup></li> <li>• resilient metal channels on one side spaced 400 mm or 600 mm o.c.</li> <li>• 2 layers of gypsum board on resilient metal channel side</li> <li>• 1 layer of gypsum board on other side</li> </ul>	 GG00035A		
	W4a	<ul style="list-style-type: none"> <li>• W4 with</li> <li>• studs spaced 400 mm o.c.</li> <li>• 15.9 mm Type X gypsum board<sup>(7)</sup></li> </ul>	1 h	1 h [1.5 h <sup>(8)</sup> ]	51
	W4b	<ul style="list-style-type: none"> <li>• W4 with</li> <li>• studs spaced 600 mm o.c.</li> <li>• 15.9 mm Type X gypsum board<sup>(7)</sup></li> </ul>	1 h	1 h [1.5 h <sup>(8)</sup> ]	54
	W4c	<ul style="list-style-type: none"> <li>• W4 with</li> <li>• studs spaced 400 mm o.c.</li> <li>• 12.7 mm Type X gypsum board<sup>(7)</sup></li> </ul>	45 min [1 h <sup>(8)</sup> ]	1 h	49
	W4d	<ul style="list-style-type: none"> <li>• W4 with</li> <li>• studs spaced 600 mm o.c.</li> <li>• 12.7 mm Type X gypsum board<sup>(7)</sup></li> </ul>	45 min [1 h <sup>(8)</sup> ]	1 h	53
	<b>W5</b>	<ul style="list-style-type: none"> <li>• 38 mm x 89 mm studs spaced 400 mm or 600 mm o.c.</li> <li>• 89 mm thick absorptive material<sup>(6)</sup></li> <li>• resilient metal channels on one side spaced 400 mm or 600 mm o.c.</li> <li>• 1 layer of gypsum board on resilient metal channel side</li> <li>• 2 layers of gypsum board on other side</li> </ul>	 GG00036A		
	W5a	<ul style="list-style-type: none"> <li>• W5 with</li> <li>• studs spaced 400 mm o.c.</li> <li>• 15.9 mm Type X gypsum board<sup>(7)</sup></li> </ul>	45 min	1 h	51
	W5b	<ul style="list-style-type: none"> <li>• W5 with</li> <li>• studs spaced 600 mm o.c.</li> <li>• 15.9 mm Type X gypsum board<sup>(7)</sup></li> </ul>	45 min	1 h	54
	W5c	<ul style="list-style-type: none"> <li>• W5 with</li> <li>• studs spaced 400 mm o.c.</li> <li>• 12.7 mm Type X gypsum board<sup>(7)</sup></li> </ul>	45 min	1 h	49
	W5d	<ul style="list-style-type: none"> <li>• W5 with</li> <li>• studs spaced 600 mm o.c.</li> <li>• 12.7 mm Type X gypsum board<sup>(7)</sup></li> </ul>	45 min	1 h	53
	<b>W6</b>	<ul style="list-style-type: none"> <li>• 38 mm x 89 mm studs spaced 400 mm or 600 mm o.c.</li> <li>• with or without absorptive material</li> <li>• resilient metal channels on one side</li> <li>• 2 layers of gypsum board on each side</li> </ul>	 GG00037A		
	W6a	<ul style="list-style-type: none"> <li>• W6 with</li> <li>• studs spaced 400 mm or 600 mm o.c.</li> <li>• 89 mm thick absorptive material<sup>(6)</sup></li> <li>• resilient metal channels spaced 400 mm o.c.</li> <li>• 15.9 mm Type X gypsum board<sup>(7)</sup></li> </ul>	1.5 h	2 h	55
	W6b	<ul style="list-style-type: none"> <li>• W6 with</li> <li>• studs spaced 400 mm or 600 mm o.c.</li> <li>• 89 mm thick absorptive material<sup>(6)</sup></li> <li>• resilient metal channels spaced 600 mm o.c.</li> <li>• 15.9 mm Type X gypsum board<sup>(7)</sup></li> </ul>	1.5 h	2 h	58
	W6c	<ul style="list-style-type: none"> <li>• W6 with</li> <li>• studs spaced 400 mm o.c.</li> <li>• 89 mm thick absorptive material<sup>(6)</sup></li> <li>• resilient metal channels spaced 400 mm o.c.</li> <li>• 12.7 mm Type X gypsum board<sup>(7)</sup></li> </ul>	1 h	1.5 h	53

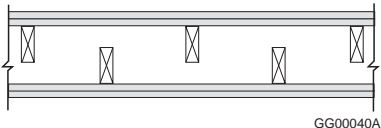
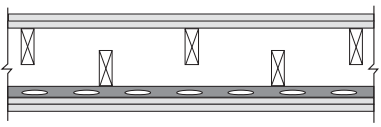
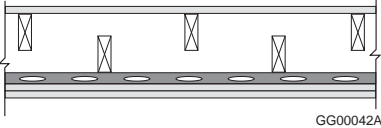
# Fire and Sound Resistance Tables

Table 9.10.3.1.-A (Continued)

Type of Wall	Wall Number	Description	Fire-Resistance Rating <sup>(2)(3)</sup>		Typical Sound Transmission Class <sup>(2)(4)(5)</sup>
			Loadbearing	Non-Loadbearing	
	W6d	W6 with <ul style="list-style-type: none"> <li>• studs spaced 400 mm o.c.</li> <li>• 89 mm thick absorptive material<sup>(6)</sup></li> <li>• resilient metal channels spaced 600 mm o.c.</li> <li>• 12.7 mm Type X gypsum board</li> </ul>	1 h	1.5 h	55
	W6e	W6 with <ul style="list-style-type: none"> <li>• studs spaced 600 mm o.c.</li> <li>• 89 mm thick absorptive material<sup>(6)</sup></li> <li>• resilient metal channels spaced 400 mm o.c.</li> <li>• 12.7 mm Type X gypsum board<sup>(7)</sup></li> </ul>	1 h	1.5 h	55
	W6f	W6 with <ul style="list-style-type: none"> <li>• studs spaced 600 mm o.c.</li> <li>• 89 mm thick absorptive material<sup>(6)</sup></li> <li>• resilient metal channels spaced 600 mm o.c.</li> <li>• 12.7 mm Type X gypsum board<sup>(7)</sup></li> </ul>	1 h	1.5 h	58
	W6g	W6 with <ul style="list-style-type: none"> <li>• studs spaced 400 mm or 600 mm o.c.</li> <li>• 89 mm thick absorptive material<sup>(6)</sup></li> <li>• resilient metal channels spaced 400 mm o.c.</li> <li>• 12.7 mm regular gypsum board<sup>(7)</sup></li> </ul>	45 min	1 h	50
	W6h	W6 with <ul style="list-style-type: none"> <li>• studs spaced 400 mm or 600 mm o.c.</li> <li>• 89 mm thick absorptive material<sup>(6)</sup></li> <li>• resilient metal channels spaced 600 mm o.c.</li> <li>• 12.7 mm regular gypsum board<sup>(7)</sup></li> </ul>	45 min	1 h	52
	W6i	W6 with <ul style="list-style-type: none"> <li>• studs spaced 400 mm or 600 mm o.c.</li> <li>• no absorptive material</li> <li>• resilient metal channels spaced 400 mm or 600 mm o.c.</li> <li>• 15.9 mm Type X gypsum board<sup>(7)</sup></li> </ul>	1.5 h	2 h	47
	W6j	W6 with <ul style="list-style-type: none"> <li>• studs spaced 400 mm or 600 mm o.c.</li> <li>• no absorptive material</li> <li>• resilient metal channels spaced 400 mm or 600 mm o.c.</li> <li>• 12.7 mm Type X gypsum board<sup>(7)</sup></li> </ul>	1 h	1.5 h	46
<ul style="list-style-type: none"> <li>• Wood Studs</li> <li>• Two Rows Staggered on 38 mm x 140 mm Plate</li> <li>• Loadbearing or Non-Loadbearing</li> </ul>	W7	<ul style="list-style-type: none"> <li>• two rows 38 mm x 89 mm studs each spaced 400 mm or 600 mm o.c. staggered on common 38 mm x 140 mm plate</li> <li>• 89 mm thick absorptive material on one side or 65 mm thick on each side<sup>(6)</sup></li> <li>• 1 layer of gypsum board on each side</li> </ul>			
	W7a	W7 with <ul style="list-style-type: none"> <li>• 15.9 mm Type X gypsum board<sup>(7)</sup></li> </ul>	1 h	1 h	47
	W7b	W7 with <ul style="list-style-type: none"> <li>• 12.7 mm Type X gypsum board<sup>(7)</sup></li> </ul>	45 min [1 h <sup>(8)</sup> ]	45 min [1 h <sup>(8)</sup> ]	45
	W7c	W7 with <ul style="list-style-type: none"> <li>• 12.7 mm regular gypsum board<sup>(7)(9)</sup></li> </ul>	30 min	30 min [45 min <sup>(8)</sup> ]	42
	W8	<ul style="list-style-type: none"> <li>• Two rows 38 mm x 89 mm studs each spaced 400 mm or 600 mm o.c. staggered on common 38 mm x 140 mm plate</li> <li>• 89 mm thick absorptive material on one side or 65 mm thick on each side<sup>(6)</sup></li> <li>• 2 layers of gypsum board on one side</li> <li>• 1 layer of gypsum board on other side</li> </ul>			
	W8a	W8 with <ul style="list-style-type: none"> <li>• 15.9 mm Type X gypsum board<sup>(7)</sup></li> </ul>	1 h	1.5 h	52
	W8b	W8 with <ul style="list-style-type: none"> <li>• 12.7 mm Type X gypsum board<sup>(7)</sup></li> </ul>	45 min	1 h	50

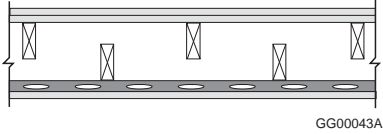
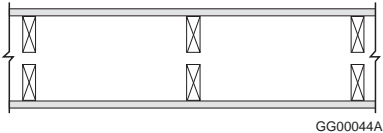
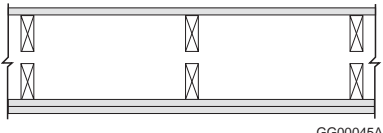
# Fire and Sound Resistance Tables

**Table 9.10.3.1.-A (Continued)**

Type of Wall	Wall Number	Description	Fire-Resistance Rating <sup>(2)(3)</sup>		Typical Sound Transmission Class <sup>(2)(4)(5)</sup>
			Loadbearing	Non-Loadbearing	
	<b>W9</b>	<ul style="list-style-type: none"> <li>two rows 38 mm x 89 mm studs each spaced 400 mm or 600 mm o.c. staggered on common 38 mm x 140 mm plate</li> <li>with or without absorptive material</li> <li>2 layers of gypsum board on each side</li> </ul>	 GG00040A		
	W9a	<ul style="list-style-type: none"> <li>W9 with</li> <li>89 mm thick absorptive material on one side or 65 mm thick on each side<sup>(6)</sup></li> <li>15.9 mm Type X gypsum board<sup>(7)</sup></li> </ul>	1.5 h	2 h	56
	W9b	<ul style="list-style-type: none"> <li>W9 with</li> <li>89 mm thick absorptive material on one side or 65 mm thick on each side<sup>(6)</sup></li> <li>12.7 mm Type X gypsum board<sup>(7)</sup></li> </ul>	1 h	1.5 h	55
	W9c	<ul style="list-style-type: none"> <li>W9 with</li> <li>89 mm thick absorptive material on one side or 65 mm thick on each side<sup>(6)</sup></li> <li>12.7 mm regular gypsum board<sup>(7)</sup></li> </ul>	45 min	1 h	53
	W9d	<ul style="list-style-type: none"> <li>W9 with</li> <li>no absorptive material</li> <li>15.9 mm Type X gypsum board<sup>(7)</sup></li> </ul>	1.5 h	2 h	48
	<b>W10</b>	<ul style="list-style-type: none"> <li>two rows 38 mm x 89 mm studs each spaced 400 mm or 600 mm o.c. staggered on common 38 mm x 140 mm plate</li> <li>with or without absorptive material</li> <li>resilient metal channels on one side spaced 400 mm or 600 mm o.c.</li> <li>2 layers of gypsum board on each side</li> </ul>	 GG00041A		
	W10a	<ul style="list-style-type: none"> <li>W10 with</li> <li>89 mm thick absorptive material on one side or 65 mm thick on each side<sup>(6)</sup></li> <li>15.9 mm Type X gypsum board<sup>(7)</sup></li> </ul>	1.5 h	2 h	62
	W10b	<ul style="list-style-type: none"> <li>W10 with</li> <li>89 mm thick absorptive material on one side or 65 mm thick on each side<sup>(6)</sup></li> <li>12.7 mm Type X gypsum board<sup>(7)</sup></li> </ul>	1 h	1.5 h	60
	W10c	<ul style="list-style-type: none"> <li>W10 with</li> <li>no absorptive material</li> <li>15.9 mm Type X gypsum board<sup>(7)</sup></li> </ul>	1.5 h	2 h	50
	W10d	<ul style="list-style-type: none"> <li>W10 with</li> <li>no absorptive material</li> <li>12.7 mm Type X gypsum board<sup>(7)</sup></li> </ul>	1 h	1.5 h	48
	<b>W11</b>	<ul style="list-style-type: none"> <li>two rows 38 mm x 89 mm studs each spaced 400 mm or 600 mm o.c. staggered on common 38 mm x 140 mm plate</li> <li>89 mm thick absorptive material on one side or 65 mm thick on each side<sup>(6)</sup></li> <li>resilient metal channels on one side spaced 400 mm or 600 mm o.c.</li> <li>2 layers of gypsum board on resilient channel side</li> <li>1 layer of gypsum board on other side</li> </ul>	 GG00042A		
	W11a	<ul style="list-style-type: none"> <li>W11 with</li> <li>15.9 mm Type X gypsum board<sup>(7)</sup></li> </ul>	1 h	1 h	56
	W11b	<ul style="list-style-type: none"> <li>W11 with</li> <li>12.7 mm Type X gypsum board<sup>(7)</sup></li> </ul>	45 min [1 h <sup>(8)</sup> ]	1 h	54

# Fire and Sound Resistance Tables

Table 9.10.3.1.-A (Continued)

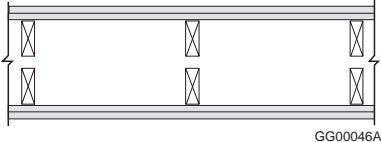
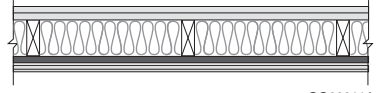
Type of Wall	Wall Number	Description	Fire-Resistance Rating <sup>(2)(3)</sup>		Typical Sound Transmission Class <sup>(2)(4)(5)</sup>
			Loadbearing	Non-Loadbearing	
	<b>W12</b>	<ul style="list-style-type: none"> <li>two rows 38 mm x 89 mm studs each spaced 400 mm or 600 mm o.c. staggered on common 38 mm x 140 mm plate</li> <li>89 mm thick absorptive material on one side or 65 mm thick on each side<sup>(6)</sup></li> <li>resilient metal channels on one side spaced 400 mm or 600 mm o.c.</li> <li>1 layer of gypsum board on resilient metal channel side</li> <li>2 layers of gypsum board on other side</li> </ul>	 GG00043A		
	W12a	W12 with • 15.9 mm Type X gypsum board <sup>(7)</sup>	45 min	1 h	56
	W12b	W12 with • 12.7 mm Type X gypsum board <sup>(7)</sup>	45 min	1 h	54
<ul style="list-style-type: none"> <li>Wood Studs</li> <li>Two Rows on Separate Plates</li> <li>Loadbearing or Non-Loadbearing</li> </ul>	<b>W13</b>	<ul style="list-style-type: none"> <li>two rows 38 mm x 89 mm studs, each spaced 400 mm or 600 mm o.c. on separate 38 mm x 89 mm plates set 25 mm apart</li> <li>with or without absorptive material</li> <li>1 layer of gypsum board on each side</li> </ul>	 GG00044A		
	W13a	W13 with • 89 mm thick absorptive material on each side <sup>(6)(10)</sup> • 15.9 mm Type X gypsum board <sup>(7)</sup>	1 h	1 h	57
	W13b	W13 with • 89 mm thick absorptive material on each side <sup>(6)(10)</sup> • 12.7 mm Type X gypsum board <sup>(7)</sup>	45 min [1 h <sup>(8)</sup> ]	45 min [1 h <sup>(8)</sup> ]	57
	W13c	W13 with • 89 mm thick absorptive material on one side only <sup>(6)(10)</sup> • 15.9 mm Type X gypsum board <sup>(7)</sup>	1 h	1 h	54
	W13d	W13 with • 89 mm thick absorptive material on one side only <sup>(6)(10)</sup> • 12.7 mm Type X gypsum board <sup>(7)</sup>	45 min	45 min	53
	W13e	W13 with • no absorptive material • 15.9 mm Type X gypsum board <sup>(7)</sup>	1 h	1 h	45
	W13f	W13 with • no absorptive material • 12.7 mm Type X gypsum board <sup>(7)</sup>	45 min	45 min	45
	<b>W14</b>	<ul style="list-style-type: none"> <li>two rows 38 mm x 89 mm studs, each spaced 400 mm or 600 mm o.c. on separate 38 mm x 89 mm plates set 25 mm apart</li> <li>with or without absorptive material</li> <li>2 layers of gypsum board on one side</li> <li>1 layer of gypsum board on other side</li> </ul>	 GG00045A		
	W14a	W14 with • 89 mm thick absorptive material on each side <sup>(6)(10)</sup> • 15.9 mm Type X gypsum board <sup>(7)</sup>	1 h	1 h [1.5 h <sup>(8)</sup> ]	61
	W14b	W14 with • 89 mm thick absorptive material on each side <sup>(6)(10)</sup> • 12.7 mm Type X gypsum board <sup>(7)</sup>	45 min	1 h	61
	W14c	W14 with • 89 mm thick absorptive material on one side only <sup>(6)(10)</sup> • 15.9 mm Type X gypsum board <sup>(7)</sup>	1 h	1 h	57
	W14d	W14 with • 89 mm thick absorptive material on one side only <sup>(6)(10)</sup> • 12.7 mm Type X gypsum board <sup>(7)</sup>	45 min	1 h	57
	W14e	W14 with • no absorptive material • 15.9 mm Type X gypsum board <sup>(7)</sup>	1 h	1 h	51

Copyright © NRC 1941 - 2021 World Rights Reserved © CNRC 1941-2021 Droits réservés pour tous pays



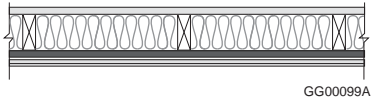
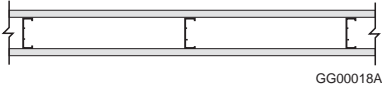
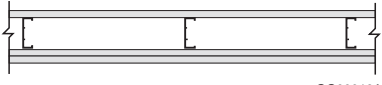
# Fire and Sound Resistance Tables

**Table 9.10.3.1.-A (Continued)**

Type of Wall	Wall Number	Description	Fire-Resistance Rating <sup>(2)(3)</sup>		Typical Sound Transmission Class <sup>(2)(4)(5)</sup>
			Loadbearing	Non-Loadbearing	
	W14f	W14 with • no absorptive material • 12.7 mm Type X gypsum board <sup>(7)</sup>	45 min	1 h	51
	W15	• two rows 38 mm x 89 mm studs, each spaced 400 mm or 600 mm o.c. on separate 38 mm x 89 mm plates set 25 mm apart • with or without absorptive material • 2 layers of gypsum board on each side			
	W15a	W15 with • 89 mm thick absorptive material on each side <sup>(6)(10)</sup> • 15.9 mm Type X gypsum board <sup>(7)</sup>	1.5 h	2 h	66
	W15b	W15 with • 89 mm thick absorptive material on each side <sup>(6)(10)</sup> • 12.7 mm Type X gypsum board <sup>(7)</sup>	1 h	1.5 h	65
	W15c	W15 with • 89 mm thick absorptive material on each side <sup>(6)(10)</sup> • 12.7 mm regular gypsum board <sup>(7)</sup>	45 min	1 h	61
	W15d	W15 with • 89 mm thick absorptive material on one side only <sup>(6)(10)</sup> • 15.9 mm Type X gypsum board <sup>(7)</sup>	1.5 h	2 h	62
	W15e	W15 with • 89 mm thick absorptive material on one side only <sup>(6)(10)</sup> • 12.7 mm Type X gypsum board <sup>(7)</sup>	1 h	1.5 h	60
	W15f	W15 with • 89 mm thick absorptive material on one side only <sup>(6)(10)</sup> • 12.7 mm regular gypsum board <sup>(7)</sup>	45 min	1 h	57
	W15g	W15 with • no absorptive material • 15.9 mm Type X gypsum board <sup>(7)</sup>	1.5 h	2 h	56
	W15h	W15 with • no absorptive material • 12.7 mm Type X gypsum board <sup>(7)</sup>	1 h	1.5 h	55
	W15i	W15 with • no absorptive material • 12.7 mm regular gypsum board <sup>(7)</sup>	45 min	1 h	51
• Exterior Wood Studs • Single Row	EW1	• 38 mm x 89 mm studs spaced 400 mm or 600 mm o.c. • 89 mm thick absorptive material <sup>(8)</sup> • 1 or 2 layers of gypsum board on inside			
• Loadbearing or Non-Loadbearing	EW1a	EW1 with • 1 layer of 15.9 mm Type X gypsum board <sup>(7)(11)</sup> • exterior sheathing and cladding <sup>(12)</sup>	1 h	1 h	n/a
	EW1b	EW1 with • 1 layer 12.7 mm Type X gypsum board <sup>(7)(11)</sup> • exterior sheathing and cladding <sup>(12)</sup>	45 min	45 min	n/a
	EW1c	EW1 with • 2 layers of 12.7 mm regular gypsum board <sup>(7)(11)</sup> • exterior sheathing and cladding <sup>(12)</sup>	45 min	45 min	n/a
	EW1d	EW1 with • 1 layer of 12.7 mm Type X gypsum board <sup>(7)(11)</sup> • exterior sheathing <sup>(13)</sup> • masonry veneer cladding	45 min	45 min	n/a

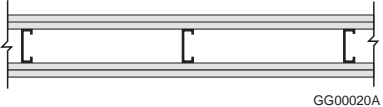
# Fire and Sound Resistance Tables

Table 9.10.3.1.-A (Continued)

Type of Wall	Wall Number	Description	Fire-Resistance Rating <sup>(2)(3)</sup>		Typical Sound Transmission Class <sup>(2)(4)(5)</sup>
			Loadbearing	Non-Loadbearing	
	EW2	<ul style="list-style-type: none"> <li>• wood studs</li> <li>• 89 mm thick glass fiber insulation<sup>(14)</sup></li> <li>• 1 layer of gypsum board on inside</li> </ul>	 GG00099A		
	EW2a	EW2 with <ul style="list-style-type: none"> <li>• 38 mm x 89 mm studs spaced not more than 400 mm o.c.</li> <li>• 15.9 mm Type X gypsum board<sup>(7)(11)</sup></li> <li>• exterior sheathing and cladding<sup>(12)</sup></li> </ul>	1 h	1 h	n/a
	EW2b	EW2 with <ul style="list-style-type: none"> <li>• 38 mm x 89 mm studs spaced not more than 400 mm o.c.</li> <li>• 12.7 mm Type X gypsum board<sup>(7)(11)</sup></li> <li>• exterior sheathing<sup>(13)</sup></li> <li>• masonry veneer cladding</li> </ul>	45 min	45 min	n/a
	EW2c	EW2 with <ul style="list-style-type: none"> <li>• 38 mm x 140 mm studs spaced not more than 600 mm o.c.</li> <li>• 15.9 mm Type X gypsum board<sup>(7)(11)</sup></li> <li>• exterior sheathing and cladding<sup>(12)</sup></li> </ul>	45 min	45 min	n/a
<ul style="list-style-type: none"> <li>• Non-Loadbearing Steel Studs</li> <li>• 0.46 mm (25 Gauge)</li> </ul>	S1	<ul style="list-style-type: none"> <li>• 31 mm x 64 mm steel studs spaced 400 mm or 600 mm o.c.</li> <li>• with or without absorptive material</li> <li>• 1 layer of gypsum board on each side</li> </ul>	 GG00018A		
	S1a	S1 with <ul style="list-style-type: none"> <li>• studs spaced 600 mm o.c.</li> <li>• 65 mm thick absorptive material<sup>(6)</sup></li> <li>• 15.9 mm Type X gypsum board<sup>(7)</sup></li> </ul>	–	45 min [1 h <sup>(8)</sup> ]	43
	S1b	S1 with <ul style="list-style-type: none"> <li>• studs spaced 400 mm o.c.</li> <li>• 65 mm thick absorptive material<sup>(6)</sup></li> <li>• 15.9 mm Type X gypsum board<sup>(7)</sup></li> </ul>	–	45 min [1 h <sup>(8)</sup> ]	39
	S1c	S1 with <ul style="list-style-type: none"> <li>• studs spaced 400 mm or 600 mm o.c.</li> <li>• no absorptive material</li> <li>• 15.9 mm Type X gypsum board<sup>(7)</sup></li> </ul>	–	45 min	35
	S2	<ul style="list-style-type: none"> <li>• 31 mm x 64 mm steel studs spaced 400 mm or 600 mm o.c.</li> <li>• with or without absorptive material</li> <li>• 1 layer of gypsum board on one side</li> <li>• 2 layers of gypsum board on other side</li> </ul>	 GG00019A		
	S2a	S2 with <ul style="list-style-type: none"> <li>• studs spaced 600 mm o.c.</li> <li>• 65 mm thick absorptive material<sup>(6)</sup></li> <li>• 15.9 mm Type X gypsum board<sup>(7)</sup></li> </ul>	–	1 h	50
	S2b	S2 with <ul style="list-style-type: none"> <li>• studs spaced 400 mm o.c.</li> <li>• 65 mm thick absorptive material<sup>(6)</sup></li> <li>• 15.9 mm Type X gypsum board<sup>(7)</sup></li> </ul>	–	1 h	44
	S2c	S2 with <ul style="list-style-type: none"> <li>• studs spaced 600 mm o.c.</li> <li>• 65 mm thick absorptive material<sup>(6)</sup></li> <li>• 12.7 mm Type X gypsum board<sup>(7)</sup></li> </ul>	–	1 h	50
	S2d	S2 with <ul style="list-style-type: none"> <li>• studs spaced 400 mm o.c.</li> <li>• 65 mm thick absorptive material<sup>(6)</sup></li> <li>• 12.7 mm Type X gypsum board<sup>(7)</sup></li> </ul>	–	1 h	42

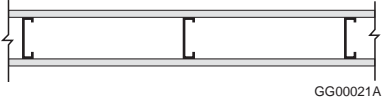
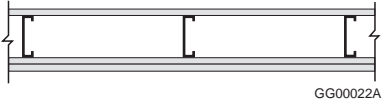
# Fire and Sound Resistance Tables

**Table 9.10.3.1.-A (Continued)**

Type of Wall	Wall Number	Description	Fire-Resistance Rating <sup>(2)(3)</sup>		Typical Sound Transmission Class <sup>(2)(4)(5)</sup>
			Loadbearing	Non-Loadbearing	
	S2e	S2 with • studs spaced 600 mm o.c. • no absorptive material • 15.9 mm Type X gypsum board <sup>(7)</sup>	–	1 h	41
	S2f	S2 with • studs spaced 400 mm o.c. • no absorptive material • 15.9 mm Type X gypsum board <sup>(7)</sup>	–	1 h	37
	S2g	S2 with • studs spaced 600 mm o.c. • no absorptive material • 12.7 mm Type X gypsum board <sup>(7)</sup>	–	1 h	40
	S2h	S2 with • studs spaced 400 mm o.c. • no absorptive material • 12.7 mm Type X gypsum board <sup>(7)</sup>	–	1 h	35
	<b>S3</b>	• 31 mm x 64 mm steel studs spaced 400 mm or 600 mm o.c. • with or without absorptive material • 2 layers of gypsum board on each side			
	S3a	S3 with • studs spaced 600 mm o.c. • 65 mm thick absorptive material <sup>(6)</sup> • 15.9 mm Type X gypsum board <sup>(7)</sup>	–	2 h	54
	S3b	S3 with • studs spaced 400 mm o.c. • 65 mm thick absorptive material <sup>(6)</sup> • 15.9 mm Type X gypsum board <sup>(7)</sup>	–	2 h	51
	S3c	S3 with • studs spaced 600 mm o.c. • 65 mm thick absorptive material <sup>(6)</sup> • 12.7 mm Type X gypsum board <sup>(7)</sup>	–	1.5 h	53
	S3d	S3 with • studs spaced 400 mm o.c. • 65 mm thick absorptive material <sup>(6)</sup> • 12.7 mm Type X gypsum board <sup>(7)</sup>	–	1.5 h	47
	S3e	S3 with • studs spaced 600 mm o.c. • 65 mm thick absorptive material <sup>(6)</sup> • 12.7 mm regular gypsum board <sup>(7)</sup>	–	1 h	49
	S3f	S3 with • studs spaced 400 mm o.c. • 65 mm thick absorptive material <sup>(6)</sup> • 12.7 mm regular gypsum board <sup>(7)</sup>	–	1 h	41
	S3g	S3 with • studs spaced 600 mm o.c. • no absorptive material • 15.9 mm Type X gypsum board <sup>(7)</sup>	–	2 h	45
	S3h	S3 with • studs spaced 400 mm o.c. • no absorptive material • 15.9 mm Type X gypsum board <sup>(7)</sup>	–	2 h	42
	S3i	S3 with • studs spaced 600 mm o.c. • no absorptive material • 12.7 mm Type X gypsum board <sup>(7)</sup>	–	1.5 h	44

# Fire and Sound Resistance Tables

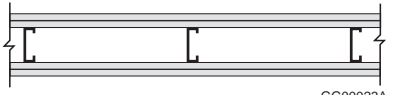
Table 9.10.3.1.-A (Continued)

Type of Wall	Wall Number	Description	Fire-Resistance Rating <sup>(2)(3)</sup>		Typical Sound Transmission Class <sup>(2)(4)(5)</sup>
			Loadbearing	Non-Loadbearing	
	S3j	S3 with • studs spaced 400 mm o.c. • no absorptive material • 12.7 mm Type X gypsum board <sup>(7)</sup>	–	1.5 h	39
	S3k	S3 with • studs spaced 600 mm o.c. • no absorptive material • 12.7 mm regular gypsum board <sup>(7)</sup>	–	1 h	40
	S3l	S3 with • studs spaced 400 mm o.c. • no absorptive material • 12.7 mm regular gypsum board <sup>(7)</sup>	–	1 h	37
	<b>S4</b>	• 31 mm x 92 mm steel studs spaced 400 mm or 600 mm o.c. • with or without absorptive material • 1 layer of gypsum board on each side	 GG00021A		
	S4a	S4 with • studs spaced 600 mm o.c. • 89 mm thick absorptive material <sup>(6)</sup> • 15.9 mm Type X gypsum board <sup>(7)</sup>	–	45 min [1 h <sup>(8)</sup> ]	48
	S4b	S4 with • studs spaced 400 mm o.c. • 89 mm thick absorptive material <sup>(6)</sup> • 15.9 mm Type X gypsum board <sup>(7)</sup>	–	45 min [1 h <sup>(8)</sup> ]	47
	S4c	S4 with • studs spaced 600 mm o.c. • no absorptive material • 15.9 mm Type X gypsum board <sup>(7)</sup>	–	45 min	38
	S4d	S4 with • studs spaced 400 mm o.c. • no absorptive material • 15.9 mm Type X gypsum board <sup>(7)</sup>	–	45 min	38
	<b>S5</b>	• 31 mm x 92 mm steel studs spaced 400 mm or 600 mm o.c. • with or without absorptive material • 1 layer of gypsum board on one side • 2 layers of gypsum board on other side	 GG00022A		
	S5a	S5 with • studs spaced 600 mm o.c. • 89 mm thick absorptive material <sup>(6)</sup> • 15.9 mm Type X gypsum board <sup>(7)</sup>	–	1 h [1.5 h <sup>(8)</sup> ]	53
	S5b	S5 with • studs spaced 400 mm o.c. • 89 mm thick absorptive material <sup>(6)</sup> • 15.9 mm Type X gypsum board <sup>(7)</sup>	–	1 h [1.5 h <sup>(8)</sup> ]	52
	S5c	S5 with • studs spaced 600 mm o.c. • 89 mm thick absorptive material <sup>(6)</sup> • 12.7 mm Type X gypsum board <sup>(7)</sup>	–	1 h [1.5 h <sup>(8)</sup> ]	51
	S5d	S5 with • studs spaced 400 mm o.c. • 89 mm thick absorptive material <sup>(6)</sup> • 12.7 mm Type X gypsum board <sup>(7)</sup>	–	1 h [1.5 h <sup>(8)</sup> ]	50
	S5e	S5 with • studs spaced 600 mm o.c. • no absorptive material • 15.9 mm Type X gypsum board <sup>(7)</sup>	–	1 h	43

Copyright © NRC 1941 - 2021 World Rights Reserved © CNRC 1941-2021 Droits réservés pour tous pays

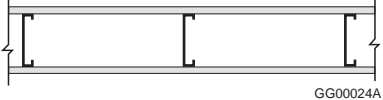
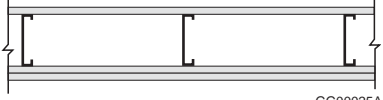
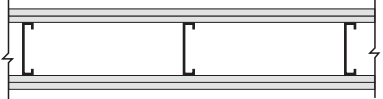
# Fire and Sound Resistance Tables

**Table 9.10.3.1.-A (Continued)**

Type of Wall	Wall Number	Description	Fire-Resistance Rating <sup>(2)(3)</sup>		Typical Sound Transmission Class <sup>(2)(4)(5)</sup>
			Loadbearing	Non-Loadbearing	
	S5f	S5 with • studs spaced 400 mm o.c. • no absorptive material • 15.9 mm Type X gypsum board <sup>(7)</sup>	-	1 h	42
	S5g	S5 with • studs spaced 600 mm o.c. • no absorptive material • 12.7 mm Type X gypsum board <sup>(7)</sup>	-	1 h	41
	S5h	S5 with • studs spaced 400 mm o.c. • no absorptive material • 12.7 mm Type X gypsum board <sup>(7)</sup>	-	1 h	40
	<b>S6</b>	• 31 mm x 92 mm steel studs spaced 400 mm or 600 mm o.c. • with or without absorptive material • 2 layers of gypsum board on each side			
	S6a	S6 with • studs spaced 600 mm o.c. • 89 mm thick absorptive material <sup>(6)</sup> • 15.9 mm Type X gypsum board <sup>(7)</sup>	-	2 h	56
	S6b	S6 with • studs spaced 400 mm o.c. • 89 mm thick absorptive material <sup>(6)</sup> • 15.9 mm Type X gypsum board <sup>(7)</sup>	-	2 h	55
	S6c	S6 with • studs spaced 600 mm o.c. • 89 mm thick absorptive material <sup>(6)</sup> • 12.7 mm Type X gypsum board <sup>(7)</sup>	-	1.5 h	55
	S6d	S6 with • studs spaced 400 mm o.c. • 89 mm thick absorptive material <sup>(6)</sup> • 12.7 mm Type X gypsum board <sup>(7)</sup>	-	1.5 h	54
	S6e	S6 with • studs spaced 600 mm o.c. • 89 mm thick absorptive material <sup>(6)</sup> • 12.7 mm regular gypsum board <sup>(7)</sup>	-	1 h	50
	S6f	S6 with • studs spaced 400 mm o.c. • 89 mm thick absorptive material <sup>(6)</sup> • 12.7 mm regular gypsum board <sup>(7)</sup>	-	1 h	48
	S6g	S6 with • studs spaced 600 mm o.c. • no absorptive material • 15.9 mm Type X gypsum board <sup>(7)</sup>	-	2 h	47
	S6h	S6 with • studs spaced 400 mm o.c. • no absorptive material • 15.9 mm Type X gypsum board <sup>(7)</sup>	-	2 h	45
	S6i	S6 with • studs spaced 600 mm o.c. • no absorptive material • 12.7 mm Type X gypsum board <sup>(7)</sup>	-	1.5 h	45
	S6j	S6 with • studs spaced 400 mm o.c. • no absorptive material • 12.7 mm Type X gypsum board <sup>(7)</sup>	-	1.5 h	44

# Fire and Sound Resistance Tables

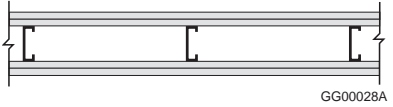
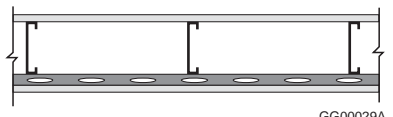
Table 9.10.3.1.-A (Continued)

Type of Wall	Wall Number	Description	Fire-Resistance Rating <sup>(2)(3)</sup>		Typical Sound Transmission Class <sup>(2)(4)(5)</sup>
			Loadbearing	Non-Loadbearing	
	S6k	S6 with • studs spaced 600 mm o.c. • no absorptive material • 12.7 mm regular gypsum board <sup>(7)</sup>	-	1 h	41
	S6l	S6 with • studs spaced 400 mm o.c. • no absorptive material • 12.7 mm regular gypsum board <sup>(7)</sup>	-	1 h	39
	<b>S7</b>	• 31 mm x 152 mm steel studs spaced 400 mm or 600 mm o.c. • with or without absorptive material • 1 layer of gypsum board on each side	 GG00024A		
	S7a	S7 with • 150 mm thick absorptive material <sup>(6)</sup> • 15.9 mm Type X gypsum board <sup>(7)</sup>	-	45 min [1 h <sup>(8)</sup> ]	51
	S7b	S7 with • no absorptive material • 15.9 mm Type X gypsum board <sup>(7)</sup>	-	45 min	41
	<b>S8</b>	• 31 mm x 152 mm steel studs spaced 400 mm or 600 mm o.c. • with or without absorptive material • 1 layer of gypsum board on one side • 2 layers of gypsum board on other side	 GG00025A		
	S8a	S8 with • 150 mm thick absorptive material <sup>(6)</sup> • 15.9 mm Type X gypsum board <sup>(7)</sup>	-	1 h [1.5 h <sup>(8)</sup> ]	55
	S8b	S8 with • 150 mm thick absorptive material <sup>(6)</sup> • 12.7 mm Type X gypsum board <sup>(7)</sup>	-	1 h [1.5 h <sup>(8)</sup> ]	54
	S8c	S8 with • no absorptive material • 15.9 mm Type X gypsum board <sup>(7)</sup>	-	1 h	45
	S8d	S8 with • no absorptive material • 12.7 mm Type X gypsum board <sup>(7)</sup>	-	1 h	44
	<b>S9</b>	• 31 mm x 152 mm steel studs spaced 400 mm or 600 mm o.c. • with or without absorptive material • 2 layers of gypsum board on each side	 GG00026A		
	S9a	S9 with • 150 mm thick absorptive material <sup>(6)</sup> • 15.9 mm Type X gypsum board <sup>(7)</sup>	-	2 h	59
	S9b	S9 with • 150 mm thick absorptive material <sup>(6)</sup> • 12.7 mm Type X gypsum board <sup>(7)</sup>	-	1.5 h	57
	S9c	S9 with • 150 mm thick absorptive material <sup>(6)</sup> • 12.7 mm regular gypsum board <sup>(7)</sup>	-	1 h	53
	S9d	S9 with • no absorptive material • 15.9 mm Type X gypsum board <sup>(7)</sup>	-	2 h	49
	S9e	S9 with • no absorptive material • 12.7 mm Type X gypsum board <sup>(7)</sup>	-	1.5 h	47

Copyright © NRC 1941 - 2021 World Rights Reserved © CNRC 1941-2021 Droits réservés pour tous pays

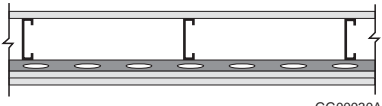
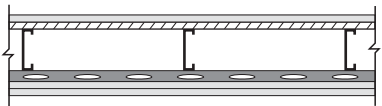
# Fire and Sound Resistance Tables

**Table 9.10.3.1.-A (Continued)**

Type of Wall	Wall Number	Description	Fire-Resistance Rating <sup>(2)(3)</sup>		Typical Sound Transmission Class <sup>(2)(4)(5)</sup>
			Loadbearing	Non-Loadbearing	
	S9f	S9 with <ul style="list-style-type: none"> <li>no absorptive material</li> <li>12.7 mm regular gypsum board<sup>(7)</sup></li> </ul>	-	1 h	43
<ul style="list-style-type: none"> <li>Loadbearing Steel Studs</li> <li>0.84 mm to 1.52 mm Thickness</li> </ul>	S10	<ul style="list-style-type: none"> <li>41 mm x 92 mm loadbearing steel studs spaced 400 mm or 600 mm o.c.</li> <li>with or without cross-bracing on one side</li> <li>with or without absorptive material</li> <li>2 layers gypsum board on each side</li> </ul>			
	S10a	S10 with <ul style="list-style-type: none"> <li>89 mm thick absorptive material<sup>(6)</sup></li> <li>15.9 mm Type X gypsum board<sup>(7)</sup></li> </ul>	1 h	-	38
	S10b	S10 with <ul style="list-style-type: none"> <li>89 mm thick absorptive material<sup>(6)</sup></li> <li>12.7 mm Type X gypsum board<sup>(7)</sup></li> </ul>	45 min [1 h]	-	38
	S10c	S10 with <ul style="list-style-type: none"> <li>89 mm thick absorptive material<sup>(6)</sup></li> <li>12.7 mm regular gypsum board<sup>(7)</sup></li> </ul>	-	-	36
	S10d	S10 with <ul style="list-style-type: none"> <li>no absorptive material</li> <li>15.9 mm Type X gypsum board<sup>(7)</sup></li> </ul>	1 h	-	36
	S10e	S10 with <ul style="list-style-type: none"> <li>no absorptive material</li> <li>12.7 mm Type X gypsum board<sup>(7)</sup></li> </ul>	1 h	-	35
	S10f	S10 with <ul style="list-style-type: none"> <li>no absorptive material</li> <li>12.7 mm regular gypsum board<sup>(7)</sup></li> </ul>	-	-	34
	S11	<ul style="list-style-type: none"> <li>41 mm x 92 mm loadbearing steel studs spaced 400 mm or 600 mm o.c.</li> <li>with or without cross-bracing on one side</li> <li>with or without absorptive material</li> <li>resilient metal channels on one side</li> <li>1 layer gypsum board on each side</li> </ul>			
	S11a	S11 with <ul style="list-style-type: none"> <li>89 mm thick absorptive material<sup>(6)</sup></li> <li>resilient metal channels spaced at 600 mm o.c.</li> <li>15.9 mm Type X gypsum board<sup>(7)</sup></li> </ul>	-	-	50
	S11b	S11 with <ul style="list-style-type: none"> <li>89 mm thick absorptive material<sup>(6)</sup></li> <li>resilient metal channels spaced at 400 mm o.c.</li> <li>15.9 mm Type X gypsum board<sup>(7)</sup></li> </ul>	-	-	47
	S11c	S11 with <ul style="list-style-type: none"> <li>no absorptive material</li> <li>resilient metal channels spaced at 600 mm o.c.</li> <li>15.9 mm Type X gypsum board<sup>(7)</sup></li> </ul>	-	-	41
	S11d	S11 with <ul style="list-style-type: none"> <li>89 mm thick absorptive material<sup>(6)</sup></li> <li>resilient metal channels spaced at 600 mm o.c.</li> <li>12.7 mm Type X gypsum board<sup>(7)</sup></li> </ul>	-	-	47
	S11e	S11 with <ul style="list-style-type: none"> <li>89 mm thick absorptive material<sup>(6)</sup></li> <li>resilient metal channels spaced at 400 mm o.c.</li> <li>12.7 mm Type X gypsum board<sup>(7)</sup></li> </ul>	-	-	45
	S11f	S11 with <ul style="list-style-type: none"> <li>no absorptive material<sup>(6)</sup></li> <li>resilient metal channels spaced at 400 mm o.c.</li> <li>15.9 mm Type X gypsum board<sup>(7)</sup></li> </ul>	-	-	39

# Fire and Sound Resistance Tables

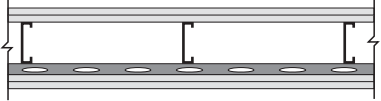
Table 9.10.3.1.-A (Continued)

Type of Wall	Wall Number	Description	Fire-Resistance Rating <sup>(2)(3)</sup>		Typical Sound Transmission Class <sup>(2)(4)(5)</sup>
			Loadbearing	Non-Loadbearing	
	S11g	S11 with <ul style="list-style-type: none"> <li>• no absorptive material<sup>(6)</sup></li> <li>• resilient metal channels spaced at 400 mm o.c.</li> <li>• 12.7 mm Type X gypsum board<sup>(7)</sup></li> </ul>	-	-	36
	S11h	S11 with <ul style="list-style-type: none"> <li>• no absorptive material<sup>(6)</sup></li> <li>• resilient metal channels spaced at 600 mm o.c.</li> <li>• 12.7 mm Type X gypsum board<sup>(7)</sup></li> </ul>	-	-	38
	<b>S12</b>	<ul style="list-style-type: none"> <li>• 41 mm x 92 mm loadbearing steel studs spaced 400 mm or 600 mm o.c.</li> <li>• with or without cross-bracing on one side</li> <li>• with or without absorptive material</li> <li>• resilient metal channels on one side</li> <li>• 2 layers gypsum board on resilient channel side</li> <li>• 1 layer gypsum board on other side</li> </ul>	 GG00030A		
	S12a	S12 with <ul style="list-style-type: none"> <li>• 89 mm thick absorptive material<sup>(6)</sup></li> <li>• resilient metal channels spaced at 600 mm o.c.</li> <li>• 15.9 mm Type X gypsum board<sup>(7)</sup></li> </ul>	-	-	54
	S12b	S12 with <ul style="list-style-type: none"> <li>• no absorptive material</li> <li>• resilient metal channels spaced at 600 mm o.c.</li> <li>• 15.9 mm Type X gypsum board<sup>(7)</sup></li> </ul>	-	-	46
	S12c	S12 with <ul style="list-style-type: none"> <li>• 89 mm thick absorptive material<sup>(6)</sup></li> <li>• resilient metal channels spaced at 400 mm o.c.</li> <li>• 15.9 mm Type X gypsum board<sup>(7)</sup></li> </ul>	-	-	52
	S12d	S12 with <ul style="list-style-type: none"> <li>• no absorptive material</li> <li>• resilient metal channels spaced at 400 mm o.c.</li> <li>• 15.9 mm Type X gypsum board<sup>(7)</sup></li> </ul>	-	-	43
	S12e	S12 with <ul style="list-style-type: none"> <li>• 89 mm thick absorptive material<sup>(6)</sup></li> <li>• resilient metal channels spaced at 600 mm o.c.</li> <li>• 12.7 mm Type X gypsum board<sup>(7)</sup></li> </ul>	-	-	52
	S12f	S12 with <ul style="list-style-type: none"> <li>• no absorptive material</li> <li>• resilient metal channels spaced at 600 mm o.c.</li> <li>• 12.7 mm Type X gypsum board<sup>(7)</sup></li> </ul>	-	-	43
	S12g	S12 with <ul style="list-style-type: none"> <li>• 89 mm thick absorptive material<sup>(6)</sup></li> <li>• resilient metal channels spaced at 400 mm o.c.</li> <li>• 12.7 mm Type X gypsum board<sup>(7)</sup></li> </ul>	-	-	50
	S12h	S12 with <ul style="list-style-type: none"> <li>• no absorptive material</li> <li>• resilient metal channels spaced at 400 mm o.c.</li> <li>• 12.7 mm Type X gypsum board<sup>(7)</sup></li> </ul>	-	-	41
	<b>S13</b>	<ul style="list-style-type: none"> <li>• 41 mm x 92 mm loadbearing steel studs spaced 400 mm or 600 mm o.c.</li> <li>• with or without absorptive material</li> <li>• resilient metal channels on one side spaced at 400 mm o.c.</li> <li>• 2 layers gypsum board on resilient channel side</li> <li>• 1 layer shear membrane and 1 layer gypsum board on other side</li> </ul>	 GG00096A		



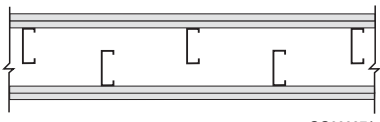
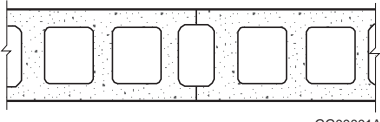
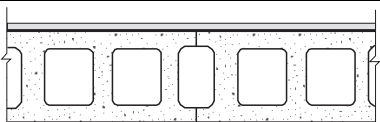
# Fire and Sound Resistance Tables

**Table 9.10.3.1.-A (Continued)**

Type of Wall	Wall Number	Description	Fire-Resistance Rating <sup>(2)(3)</sup>		Typical Sound Transmission Class <sup>(2)(4)(5)</sup>
			Loadbearing	Non-Loadbearing	
	S13a	S13 with • 89 mm thick absorptive material <sup>(6)</sup> • 12.7 mm OSB shear membrane • 12.7 mm Type X gypsum board <sup>(7)</sup>	30 min	–	57
	S14	• 41 mm x 92 mm loadbearing steel studs spaced 400 mm or 600 mm o.c. • with or without absorptive material • resilient metal channels on one side • 2 layers gypsum board on each side			
	S14a	S14 with • 89 mm thick absorptive material <sup>(6)</sup> • resilient metal channels spaced at 600 mm o.c. • 15.9 mm Type X gypsum board <sup>(7)</sup>	1 h	–	60
	S14b	S14 with • 89 mm thick absorptive material <sup>(6)</sup> • resilient metal channels spaced at 600 mm o.c. • 12.7 mm Type X gypsum board <sup>(7)</sup>	45 min [1 h]	–	57
	S14c	S14 with • 89 mm thick absorptive material <sup>(6)</sup> • resilient metal channels spaced at 600 mm o.c. • 12.7 mm regular gypsum board <sup>(7)</sup>	–	–	54
	S14d	S14 with • no absorptive material • resilient metal channels spaced at 600 mm o.c. • 15.9 mm Type X gypsum board <sup>(7)</sup>	1 h	–	51
	S14e	S14 with • studs at 400 mm o.c. • no absorptive material • resilient metal channels spaced at 600 mm o.c. • 12.7 mm Type X gypsum board <sup>(7)</sup>	1 h	–	49
	S14f	S14 with • studs at 600 mm o.c. • no absorptive material • resilient metal channels spaced at 600 mm o.c. • 12.7 mm regular gypsum board <sup>(7)</sup>	1 h	–	50
	S14g	S14 with • no absorptive material • resilient metal channels spaced at 600 mm o.c. • 12.7 mm regular gypsum board <sup>(7)</sup>	–	–	45
	S14h	S14 with • studs at 400 mm o.c. • 89 mm thick absorptive material • resilient metal channels spaced at 400 mm o.c. • 15.9 mm Type X gypsum board <sup>(7)</sup>	1 h	–	58
	S14i	S14 with • studs at 600 mm o.c. • 89 mm thick absorptive material • resilient metal channels spaced at 400 mm o.c. • 15.9 mm Type X gypsum board <sup>(7)</sup>	1 h	–	60
	S14j	S14 with • 89 mm thick absorptive material • resilient metal channels spaced at 400 mm o.c. • 12.7 mm Type X gypsum board <sup>(7)</sup>	45 min [1 h]	–	55
	S14k	S14 with • studs at 400 mm o.c. • no absorptive material • resilient metal channels spaced at 400 mm o.c. • 15.9 mm Type X gypsum board <sup>(7)</sup>	1 h	–	49

# Fire and Sound Resistance Tables

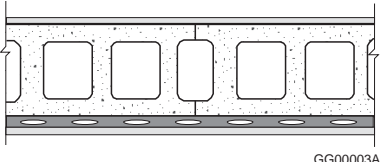
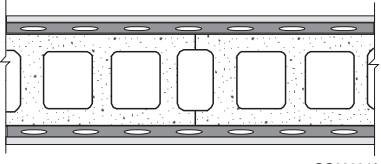
Table 9.10.3.1.-A (Continued)

Type of Wall	Wall Number	Description	Fire-Resistance Rating <sup>(2)(3)</sup>		Typical Sound Transmission Class <sup>(2)(4)(5)</sup>
			Loadbearing	Non-Loadbearing	
	S14l	S14 with <ul style="list-style-type: none"> <li>• studs at 600 mm o.c.</li> <li>• no absorptive material</li> <li>• resilient metal channels spaced at 400 mm o.c.</li> <li>• 15.9 mm Type X gypsum board<sup>(7)</sup></li> </ul>	1 h	–	51
	S14m	S14 with <ul style="list-style-type: none"> <li>• no absorptive material</li> <li>• resilient metal channels spaced at 400 mm o.c.</li> <li>• 12.7 mm Type X gypsum board<sup>(7)</sup></li> </ul>	1 h	–	47
	<b>S15</b>	<ul style="list-style-type: none"> <li>• 2 rows of 92 mm loadbearing steel studs spaced 400 mm or 600 mm o.c.</li> <li>• with cross-bracing</li> <li>• with or without absorptive material</li> <li>• 2 layers of gypsum board each side</li> </ul>	 GG00097A		
	S15a	S15 with <ul style="list-style-type: none"> <li>• 89 mm thick absorptive material in each cavity</li> <li>• 12.7 mm Type X gypsum board<sup>(7)</sup></li> </ul>	1 h	–	68
	S15b	S15 with <ul style="list-style-type: none"> <li>• no absorptive material</li> <li>• 12.7 mm Type X gypsum board<sup>(7)</sup></li> </ul>	1 h	–	52
	S15c	S15 with <ul style="list-style-type: none"> <li>• 89 mm thick absorptive material in each cavity</li> <li>• 15.9 mm Type X gypsum board<sup>(7)</sup></li> </ul>	1 h	–	68
	S15d	S15 with <ul style="list-style-type: none"> <li>• no absorptive material</li> <li>• 15.9 mm Type X gypsum board<sup>(7)</sup></li> </ul>	1.5 h	–	52
• Hollow Concrete Block (Normal Weight Aggregate)	<b>B1</b>	• 140 mm or 190 mm concrete block	 GG00001A		
	B1a	• 140 mm bare concrete block <sup>(5)</sup>	1 h	1 h	48
	B1b	• 190 mm bare concrete block <sup>(5)</sup>	1.5 h	1.5 h	50
	<b>B2</b>	<ul style="list-style-type: none"> <li>• 140 mm or 190 mm concrete block</li> <li>• no absorptive material</li> <li>• 1 layer gypsum-sand plaster or gypsum board on each side</li> </ul>	 GG00002A		
	B2a	B2 with <ul style="list-style-type: none"> <li>• 140 mm concrete block</li> <li>• 12.7 mm gypsum-sand plaster</li> </ul>	2 h	2 h	50
	B2b	B2 with <ul style="list-style-type: none"> <li>• 140 mm concrete block</li> <li>• 12.7 mm Type X gypsum board or 15.9 mm Type X gypsum board<sup>(7)</sup></li> </ul>	2 h	2 h	47
	B2c	B2 with <ul style="list-style-type: none"> <li>• 140 mm concrete block</li> <li>• 12.7 mm regular gypsum board<sup>(7)</sup></li> </ul>	1.5 h	1.5 h	46
	B2d	B2 with <ul style="list-style-type: none"> <li>• 190 mm concrete block</li> <li>• 12.7 mm gypsum-sand plaster</li> </ul>	2.5 h	2.5 h	51
	B2e	B2 with <ul style="list-style-type: none"> <li>• 190 mm concrete block</li> <li>• 15.9 mm Type X gypsum board<sup>(7)</sup></li> </ul>	3 h	3 h	50

Copyright © NRC 1941 - 2021 World Rights Reserved © CNRC 1941-2021 Droits réservés pour tous pays

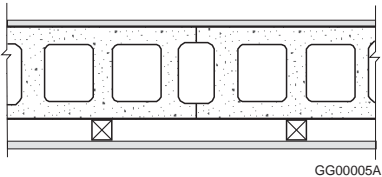
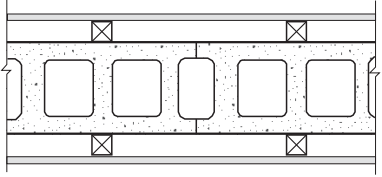
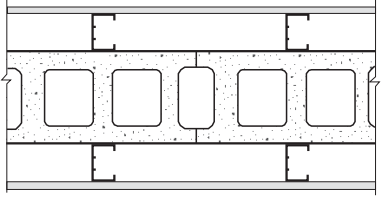
# Fire and Sound Resistance Tables

**Table 9.10.3.1.-A (Continued)**

Type of Wall	Wall Number	Description	Fire-Resistance Rating <sup>(2)(3)</sup>		Typical Sound Transmission Class <sup>(2)(4)(5)</sup>
			Loadbearing	Non-Loadbearing	
	B2f	B2 with • 190 mm concrete block • 12.7 mm Type X gypsum board <sup>(7)</sup>	2.5 h	2.5 h	49
	B2g	B2 with • 190 mm concrete block • 12.7 mm regular gypsum board <sup>(7)</sup>	2 h	2 h	48
	<b>B3</b>	<ul style="list-style-type: none"> <li>• 140 mm or 190 mm concrete block</li> <li>• resilient metal channels on one side spaced at 400 mm or 600 mm o.c.</li> <li>• absorptive material filling resilient metal channel space<sup>(6)</sup></li> <li>• 1 layer gypsum board on each side</li> </ul>			
	B3a	B3 with • 140 mm concrete block • 12.7 mm Type X gypsum board or 15.9 mm Type X gypsum board <sup>(7)</sup>	2 h	2 h	51
	B3b	B3 with • 140 mm concrete block • 12.7 mm regular gypsum board <sup>(7)(9)</sup>	1.5 h	1.5 h	48
	B3c	B3 with • 190 mm concrete block • 15.9 mm Type X gypsum board <sup>(7)</sup>	3 h	3 h	54
	B3d	B3 with • 190 mm concrete block • 12.7 mm Type X gypsum board <sup>(7)</sup>	2.5 h	2.5 h	53
	B3e	B3 with • 190 mm concrete block • 12.7 mm regular gypsum board <sup>(7)(9)</sup>	2 h	2 h	51
	<b>B4</b>	<ul style="list-style-type: none"> <li>• 140 mm or 190 mm concrete block</li> <li>• resilient metal channels on each side spaced at 400 mm or 600 mm o.c.</li> <li>• with or without absorptive material</li> <li>• 1 layer gypsum board on each side</li> </ul>			
	B4a	B4 with • 140 mm concrete block • 12.7 mm Type X gypsum board <sup>(7)</sup> , or 15.9 mm Type X gypsum board <sup>(7)</sup>	2 h	2 h	47
	B4b	B4 with • 140 mm concrete block • 12.7 mm regular gypsum board <sup>(7)(9)</sup>	1.5 h	1.5 h	42
	B4c	B4 with • 190 mm concrete block • 15.9 mm Type X gypsum board <sup>(7)</sup>	3 h	3 h	50
	B4d	B4 with • 190 mm concrete block • 12.7 mm Type X gypsum board <sup>(7)</sup>	2.5 h	2.5 h	49
	B4e	B4 with • 190 mm concrete block • 12.7 mm regular gypsum board <sup>(7)(9)</sup>	2 h	2 h	45

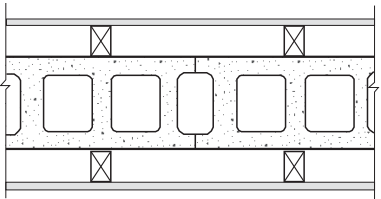
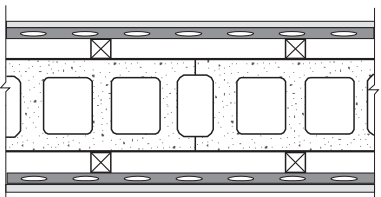
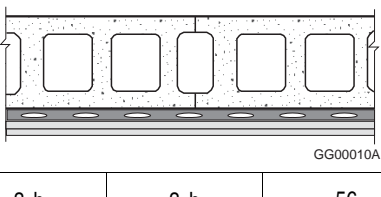
# Fire and Sound Resistance Tables

Table 9.10.3.1.-A (Continued)

Type of Wall	Wall Number	Description	Fire-Resistance Rating <sup>(2)(3)</sup>		Typical Sound Transmission Class <sup>(2)(4)(5)</sup>
			Loadbearing	Non-Loadbearing	
	<b>B5</b>	<ul style="list-style-type: none"> <li>• 190 mm concrete block</li> <li>• 38 mm x 38 mm horizontal or vertical wood strapping on one side spaced at 600 mm o.c.</li> <li>• with or without absorptive material</li> <li>• 1 layer gypsum board on each side</li> </ul>			
	B5a	B5 with • 15.9 mm Type X gypsum board <sup>(7)</sup>	3 h	3 h	54
	B5b	B5 with • 12.7 mm Type X gypsum board <sup>(7)</sup>	2.5 h	2.5 h	53
	B5c	B5 with • 12.7 mm regular gypsum board <sup>(7)(9)</sup>	2 h	2 h	51
	<b>B6</b>	<ul style="list-style-type: none"> <li>• 140 mm or 190 mm concrete block</li> <li>• 38 mm x 38 mm horizontal or vertical wood strapping on each side spaced at 600 mm o.c.</li> <li>• absorptive material filling strapping space on each side<sup>(6)</sup></li> <li>• 1 layer gypsum board on each side</li> </ul>			
	B6a	B6 with • 140 mm concrete block • 12.7 mm Type X gypsum board or 15.9 mm Type X gypsum board <sup>(7)</sup>	2 h	2 h	57
	B6b	B6 with • 140 mm concrete block • 12.7 mm regular gypsum board <sup>(7)(9)</sup>	1.5 h	1.5 h	56
	B6c	B6 with • 190 mm concrete block • 15.9 mm Type X gypsum board <sup>(7)</sup>	3 h	3 h	60
	B6d	B6 with • 190 mm concrete block • 12.7 mm Type X gypsum board <sup>(7)</sup>	2.5 h	2.5 h	59
	B6e	B6 with • 190 mm concrete block • 12.7 regular gypsum board <sup>(7)(9)</sup>	2 h	2 h	57
	<b>B7</b>	<ul style="list-style-type: none"> <li>• 190 mm concrete block</li> <li>• 65 mm steel studs each side spaced at 600 mm o.c.</li> <li>• absorptive material filling stud space on each side<sup>(6)</sup></li> <li>• 1 layer gypsum board on each side</li> </ul>			
	B7a	B7 with • 15.9 mm Type X gypsum board <sup>(7)</sup>	3 h	3 h	71
	B7b	B7 with • 12.7 mm Type X gypsum board <sup>(7)</sup>	2.5 h	2.5 h	70
	B7c	B7 with • 12.7 mm regular gypsum board <sup>(7)(9)</sup>	2 h	2 h	69

# Fire and Sound Resistance Tables

**Table 9.10.3.1.-A (Continued)**

Type of Wall	Wall Number	Description	Fire-Resistance Rating <sup>(2)(3)</sup>		Typical Sound Transmission Class <sup>(2)(4)(5)</sup>
			Loadbearing	Non-Loadbearing	
	<b>B8</b>	<ul style="list-style-type: none"> <li>• 190 mm concrete block</li> <li>• 38 mm x 64 mm wood studs on each side spaced at 600 mm o.c.</li> <li>• absorptive material filling stud space on each side<sup>(6)</sup></li> <li>• 1 layer gypsum board on each side</li> </ul>	 <p style="text-align: right; font-size: small;">GG00008A</p>		
	B8a	B8 with • 15.9 mm Type X gypsum board <sup>(7)</sup>	3 h	3 h	71
	B8b	B8 with • 12.7 mm Type X gypsum board <sup>(7)</sup>	2.5 h	2.5 h	70
	B8c	B8 with • 12.7 mm regular gypsum board <sup>(7)(9)</sup>	2 h	2 h	69
	<b>B9</b>	<ul style="list-style-type: none"> <li>• 190 mm concrete block</li> <li>• 50 mm metal Z-bars on each side spaced at 600 mm o.c. (or 38 mm x 38 mm horizontal or vertical wood strapping plus resilient metal channels)</li> <li>• absorptive material filling Z-bar space on each side<sup>(6)</sup></li> <li>• 1 layer gypsum board on each side</li> </ul>	 <p style="text-align: right; font-size: small;">GG00009A</p>		
	B9a	B9 with • 15.9 mm Type X gypsum board <sup>(7)</sup>	3 h	3 h	65
	B9b	B9 with • 12.7 mm Type X gypsum board <sup>(7)</sup>	2.5 h	2.5 h	64
	B9c	B9 with • 12.7 mm regular gypsum board <sup>(7)(9)</sup>	2 h	2 h	63
	<b>B10</b>	<ul style="list-style-type: none"> <li>• 190 mm concrete block</li> <li>• resilient metal channels on one side spaced at 600 mm o.c.</li> <li>• absorptive material filling resilient metal channel space<sup>(6)</sup></li> <li>• 2 layers gypsum board on one side only</li> </ul>	 <p style="text-align: right; font-size: small;">GG00010A</p>		
	B10a	B10 with • 15.9 mm Type X gypsum board <sup>(7)</sup>	3 h	3 h	56
	B10b	B10 with • 12.7 mm Type X gypsum board <sup>(7)</sup>	2.5 h	2.5 h	55
	B10c	B10 with • 12.7 mm regular gypsum board <sup>(7)</sup>	2 h	2 h	54

**Notes to Table 9.10.3.1.-A:**

- (1) See Note A-9.10.3.1.
- (2) *Fire-resistance ratings* and *STC ratings* of wood-frame construction were evaluated only for constructions with solid-sawn 38 mm x 89 mm lumber. However, the *fire-resistance ratings* and *STC ratings* provided for 38 mm x 89 mm wood-frame construction may be applied to wood-frame constructions with solid-sawn 38 mm x 140 mm lumber; in some cases the ratings may be conservative. Where 38 mm x 140 mm framing is used and absorptive material is called for, the absorptive material must be 140 mm thick. (See D-1.2.1.(2) in Appendix D for the significance of *fire-resistance ratings*.) The *STC ratings* may also be applied to fingerjoined lumber. The *fire-resistance ratings* are applicable to constructions using fingerjoined lumber that has been manufactured with a heat-resistant adhesive (HRA) in accordance with NLGA special product standard SPS-1, "Fingerjoined Structural Lumber," or SPS-3, "Fingerjoined "Vertical Stud Use Only" Lumber." (See also A-9.23.10.4.(1).)
- (3) For all *fire-resistance ratings*, the given spacing for framing is a maximum value.
- (4) Sound ratings listed are based on the most reliable laboratory test data available for specimens conforming to installation details required by CSA A82.31-M, "Gypsum Board Application." Results of specific tests may differ slightly because of measurement precision and minor variations in construction details. These results should only be used where the actual construction details, including spacing of fasteners and supporting framing, correspond exactly to the details of the test specimens on which the ratings are based. Assemblies with *sound transmission class ratings*

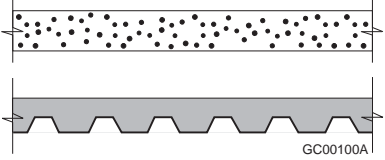
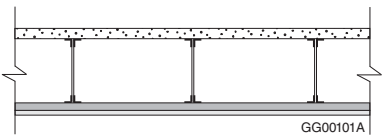
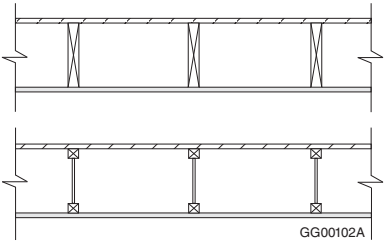
## Fire and Sound Resistance Tables

Table 9.10.3.1.-A (Continued)

- of 50 or more require acoustical sealant applied around electrical boxes and other openings, and at the junction of intersecting walls and floors, except intersection of walls constructed of concrete or *solid masonry units* where the masonry joints at the intersection are mortared.
- (5) Sound ratings are only valid where there are no discernible cracks or voids in the visible surfaces. For concrete blocks, surfaces must be sealed by at least 2 coats of paint or other surface finish described in Section 9.29. to prevent sound leakage.
  - (6) Sound absorptive material includes fibre processed from rock, slag, glass or cellulose fibre. It must fill at least 90% of the cavity thickness for the wall to have the listed *STC* value. The absorptive material should not overfill the cavity to the point of producing significant outward pressure on the finishes; such an assembly will not achieve the *STC* rating. Where the absorptive material used with steel stud assemblies is in batt form, "steel stud batts," which are wide enough to fill the cavity from the web of one stud to the web of the adjacent stud, must be used.
  - (7) The complete descriptions of indicated finishes are as follows:
    - 12.7 mm regular gypsum board – 12.7 mm regular gypsum board conforming to Article 9.29.5.2.
    - 12.7 mm Type X gypsum board – 12.7 mm special fire-resistant Type X gypsum board conforming to Article 9.29.5.2.
    - 15.9 mm Type X gypsum board – 15.9 mm special fire-resistant Type X gypsum board conforming to Article 9.29.5.2.
    - Except for exterior walls (see Note 9), the outer layer of finish on both sides of the wall must have its joints taped and finished.
    - Fastener types and spacing must conform to CSA A82.31-M, "Gypsum Board Application."
  - (8) Absorptive material required for the higher *fire-resistance rating* is mineral fibre processed from rock or slag with a mass of at least 4.8 kg/m<sup>2</sup> for 150 mm thickness, 2.8 kg/m<sup>2</sup> for 89 mm thickness and 2.0 kg/m<sup>2</sup> for 65 mm thickness and completely filling the wall cavity. For assemblies with double wood studs on separate plates, absorptive material is required in the stud cavities on both sides.
  - (9) Regular gypsum board used in single layer assemblies must be installed so all edges are supported.
  - (10) Where bracing material, such as diagonal lumber or plywood, OSB, gypsum board or fibreboard sheathing is installed on the inner face of one row of studs in double stud assemblies, the *STC* rating will be reduced by 3 for any assemblies containing absorptive material in both rows of studs or in the row of studs opposite to that to which the bracing material is attached. Attaching such layers on both inner faces of the studs may drastically reduce the *STC* value but enough data to permit assignment of *STC* ratings for this situation is not available. The *fire-resistance rating* is not affected by the inclusion of such bracing.
  - (11) For exterior walls, the finish joints must be taped and finished for the outer layer of the interior side only. The gypsum board on the exterior side may be replaced with gypsum sheathing of the same thickness and type (regular or Type X).
  - (12) Includes any exterior wall sheathing and cladding combination allowed under Part 9 other than foamed plastic sheathing. The cladding portion can include foamed plastic outboard of noncombustible, structural wood-based or gypsum-based sheathing conforming to the minimum thicknesses listed in Table 9.23.17.2.-A.
  - (13) Includes any exterior wall sheathing listed in Table 9.23.17.2.-A and masonry veneer cladding conforming to Section 9.20. Foamed plastic sheathing is permitted in EW1d and EW2b walls without the use of other sheathing, provided it is directly attached to the framing.
  - (14) The glass fibre insulation filling the cavity shall have a mass per unit area of not less than 1.0 kg/m<sup>2</sup> of wall surface.

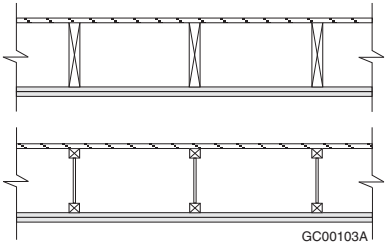
# Fire and Sound Resistance Tables

**Table 9.10.3.1.-B**  
**Fire and Sound Resistance of Floors, Ceilings and Roofs<sup>(1)</sup>**  
 Forming Part of Article 5.8.1.3., Sentences 9.10.3.1.(1) and 9.10.5.1.(4), and Article 9.11.1.3.

Type of Assembly	Assembly Number	Description <sup>(2)(3)(4)</sup>	Fire-Resistance Rating <sup>(5)(6)(7)(8)</sup>	Typical Sound Transmission Class <sup>(5)(6)(9)(10)</sup> (STC)	Typical Impact Insulation Class <sup>(5)(9)(11)</sup> (IIC)
<b>Floors and Ceilings</b>					
Concrete Slabs	<b>F1</b>	<ul style="list-style-type: none"> <li>concrete floors</li> </ul>			
	F1a	<ul style="list-style-type: none"> <li>90 mm reinforced concrete with 20 mm minimum cover over reinforcing steel</li> </ul>	1 h	47	23
	F1b	<ul style="list-style-type: none"> <li>130 mm reinforced concrete with 25 mm minimum cover over reinforcing steel</li> </ul>	2 h	52	27
	F1c	<ul style="list-style-type: none"> <li>pre-stressed hollow core slab 200 mm deep with 25 mm minimum cover over reinforcing steel</li> </ul>	1 h	50	28
	F1d	<ul style="list-style-type: none"> <li>150 mm composite slab on 75 mm steel deck with 152 x 152 x MW3.8 x MW3.8 wire mesh</li> </ul>	-	51	21
	F1e	<ul style="list-style-type: none"> <li>150 mm composite slab on 75 mm steel deck with 152 x 152 x MW3.8 x MW3.8 wire mesh</li> <li>resilient metal channels 400 mm or 600 mm o.c.</li> <li>2 layers of 12.7 mm Type X gypsum board or 2 layers of 15.9 mm Type X gypsum board</li> </ul>	1.5 h	57	36
Open Web Steel Joists	<b>F2</b>	<ul style="list-style-type: none"> <li>open web steel joists with concrete floor</li> </ul>			
	F2a	<ul style="list-style-type: none"> <li>50 mm thick concrete deck</li> <li>on open web steel joists spaced 400 mm o.c.</li> <li>furring channels spaced not more than 600 mm o.c. wired to underside of joists</li> <li>1 layer of 15.9 mm Type X gypsum board on ceiling side</li> </ul>	45 min	53	27
	F2b	<ul style="list-style-type: none"> <li>65 mm regular concrete minimum 155 kg/m<sup>2</sup></li> <li>on composite steel joists spaced 1250 mm o.c.</li> <li>furring channels spaced not more than 600 mm o.c. wired to underside of joists</li> <li>1 layer of 12.7 mm or 15.9 mm Type X gypsum board on ceiling side</li> </ul>	1.5 h	53	28
Wood Floor Joists <sup>(12)</sup>	<b>F3<sup>(13)</sup></b>	<ul style="list-style-type: none"> <li>subfloor of 15.5 mm plywood, OSB or waferboard, or 17 mm tongue and groove lumber</li> <li>on wood joists or wood I-joists spaced not more than 600 mm o.c.</li> <li>with or without absorptive material in cavity</li> <li>1 layer of gypsum board on ceiling side</li> </ul>			
	F3a	<ul style="list-style-type: none"> <li>F3 with</li> <li>no absorptive material in cavity</li> <li>15.9 mm Type X gypsum board</li> </ul>	-	29	27
	F3b	<ul style="list-style-type: none"> <li>F3 with</li> <li>absorptive material in cavity</li> <li>15.9 mm Type X gypsum board</li> </ul>	-	31	30

# Fire and Sound Resistance Tables

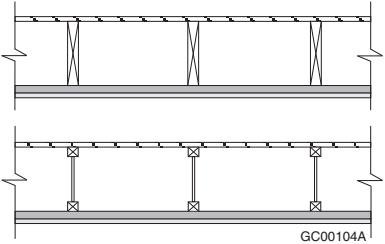
Table 9.10.3.1.-B (Continued)

Type of Assembly	Assembly Number	Description <sup>(2)(3)(4)</sup>	Fire-Resistance Rating <sup>(5)(6)(7)(8)</sup>	Typical Sound Transmission Class <sup>(5)(6)(9)(10)</sup> (STC)	Typical Impact Insulation Class <sup>(5)(9)(11)</sup> (IIC)
	F3c	F3 with <ul style="list-style-type: none"> <li>no absorptive material in cavity</li> <li>12.7 mm Type X gypsum board</li> </ul>	-	27	26
	F3d	F3 with <ul style="list-style-type: none"> <li>absorptive material in cavity</li> <li>12.7 mm Type X gypsum board</li> </ul>	-	29	29
	F3e	F3 with <ul style="list-style-type: none"> <li>no absorptive material in cavity</li> <li>12.7 mm regular gypsum board</li> </ul>	-	27	25
	F3f	F3 with <ul style="list-style-type: none"> <li>absorptive material in cavity</li> <li>12.7 mm regular gypsum board</li> </ul>	-	29	28
	<b>F4<sup>(13)</sup></b>	<ul style="list-style-type: none"> <li>subfloor of 15.5 mm plywood, OSB or waferboard, or 17 mm tongue and groove lumber</li> <li>on wood joists or wood I-joists spaced not more than 600 mm o.c.</li> <li>with or without absorptive material in cavity</li> <li>2 layers of gypsum board on ceiling side</li> </ul>			
	F4a	F4 with <ul style="list-style-type: none"> <li>wood joists or wood I-joists spaced 400 mm o.c.</li> <li>no absorptive material in cavity</li> <li>15.9 mm Type X gypsum board</li> </ul>	1 h	33	31
	F4b	F4 with <ul style="list-style-type: none"> <li>wood joists or wood I-joists spaced 600 mm o.c.</li> <li>no absorptive material in cavity</li> <li>15.9 mm Type X gypsum board</li> </ul>	1 h	34	31
	F4c	F4 with <ul style="list-style-type: none"> <li>wood joists or wood I-joists spaced 400 mm o.c.</li> <li>absorptive material in cavity</li> <li>15.9 mm Type X gypsum board</li> </ul>	45 min [1 h] <sup>(14)</sup>	35	34
	F4d	F4 with <ul style="list-style-type: none"> <li>wood joists or wood I-joists spaced 600 mm o.c.</li> <li>absorptive material in cavity</li> <li>15.9 mm Type X gypsum board</li> </ul>	45 min	38	34
	F4e	F4 with <ul style="list-style-type: none"> <li>wood joists or wood I-joists spaced 400 mm o.c.</li> <li>no absorptive material in cavity</li> <li>12.7 mm Type X gypsum board</li> </ul>	1 h	32	30
	F4f	F4 with <ul style="list-style-type: none"> <li>wood joists or wood I-joists spaced 400 mm o.c.</li> <li>no absorptive material in cavity</li> <li>12.7 mm Type X gypsum board</li> </ul>	45 min	33	30
	F4g	F4 with <ul style="list-style-type: none"> <li>wood joists or wood I-joists spaced 400 mm o.c.</li> <li>absorptive material in cavity</li> <li>12.7 mm Type X gypsum board</li> </ul>	45 min	34	33
	F4h	F4 with <ul style="list-style-type: none"> <li>wood joists or wood I-joists spaced 600 mm o.c.</li> <li>absorptive material in cavity</li> <li>12.7 mm Type X gypsum board</li> </ul>	-	35	33



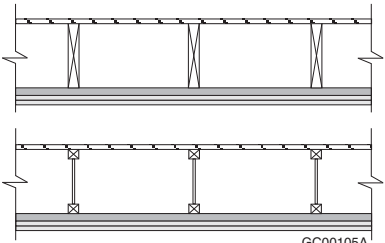
# Fire and Sound Resistance Tables

**Table 9.10.3.1.-B (Continued)**

Type of Assembly	Assembly Number	Description <sup>(2)(3)(4)</sup>	Fire-Resistance Rating <sup>(5)(6)(7)(8)</sup>	Typical Sound Transmission Class <sup>(5)(6)(9)(10)</sup> (STC)	Typical Impact Insulation Class <sup>(5)(9)(11)</sup> (IIC)
	F4i	F4 with <ul style="list-style-type: none"> <li>no absorptive material in cavity</li> <li>12.7 mm regular gypsum board</li> </ul>	-	31	30
	F4j	F4 with <ul style="list-style-type: none"> <li>absorptive material in cavity</li> <li>12.7 mm regular gypsum board</li> </ul>	-	33	33
	<b>F5<sup>(13)</sup></b>	<ul style="list-style-type: none"> <li>subfloor of 15.5 mm plywood, OSB or waferboard, or 17 mm tongue and groove lumber</li> <li>on wood joists or wood I-joists spaced not more than 600 mm o.c.</li> <li>with or without absorptive material in cavity</li> <li>steel furring channels spaced 400 mm or 600 mm o.c.</li> <li>1 layer of gypsum board on ceiling side</li> </ul>			
	F5a	F5 with <ul style="list-style-type: none"> <li>no absorptive material in cavity</li> <li>steel furring channels spaced 400 mm o.c.</li> <li>15.9 mm Type X gypsum</li> </ul>	30 min	35	37
	F5b	F5 with <ul style="list-style-type: none"> <li>no absorptive material in cavity</li> <li>steel furring channels spaced 600 mm o.c.</li> <li>15.9 mm Type X gypsum board</li> </ul>	30 min	37	30
	F5c	F5 with <ul style="list-style-type: none"> <li>absorptive material in cavity</li> <li>steel furring channels spaced 400 mm o.c.</li> <li>15.9 mm Type X gypsum board</li> </ul>	30 min [45 min] <sup>(15)</sup>	38	30
	F5d	F5 with <ul style="list-style-type: none"> <li>absorptive material in cavity</li> <li>steel furring channels spaced 600 mm o.c.</li> <li>15.9 mm Type X gypsum board</li> </ul>	30 min	40	33
	F5e	F5 with <ul style="list-style-type: none"> <li>no absorptive material in cavity</li> <li>steel furring channels spaced 400 mm o.c.</li> <li>12.7 mm Type X gypsum board</li> </ul>	30 min	33	26
	F5f	F5 with <ul style="list-style-type: none"> <li>no absorptive material in cavity</li> <li>steel furring channels spaced 600 mm o.c.</li> <li>12.7 mm Type X gypsum board</li> </ul>	30 min	35	29
	F5g	F5 with <ul style="list-style-type: none"> <li>absorptive material in cavity</li> <li>steel furring channels spaced 400 mm o.c.</li> <li>12.7 mm Type X gypsum board</li> </ul>	30 min [45 min] <sup>(15)</sup>	36	29
	F5h	F5 with <ul style="list-style-type: none"> <li>absorptive material in cavity</li> <li>steel furring channels spaced 600 mm o.c.</li> <li>12.7 mm Type X gypsum board</li> </ul>	30 min	38	32
	F5i	F5 with <ul style="list-style-type: none"> <li>no absorptive material in cavity</li> <li>steel furring channels spaced 400 mm o.c.</li> <li>12.7 mm regular gypsum board</li> </ul>	< 30 min	33	25
	F5j	F5 with <ul style="list-style-type: none"> <li>no absorptive material in cavity</li> <li>steel furring channels spaced 600 mm o.c.</li> <li>12.7 mm regular gypsum board</li> </ul>	< 30 min	35	28

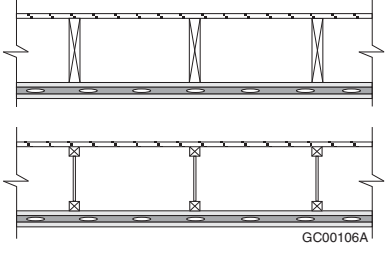
# Fire and Sound Resistance Tables

Table 9.10.3.1.-B (Continued)

Type of Assembly	Assembly Number	Description <sup>(2)(3)(4)</sup>	Fire-Resistance Rating <sup>(5)(6)(7)(8)</sup>	Typical Sound Transmission Class <sup>(5)(6)(9)(10)</sup> (STC)	Typical Impact Insulation Class <sup>(5)(9)(11)</sup> (IIC)
	F5k	F5 with <ul style="list-style-type: none"> <li>• absorptive material in cavity</li> <li>• steel furring channels spaced 400 mm o.c.</li> <li>• 12.7 mm regular gypsum board</li> </ul>	< 30 min	36	28
	F5l	F5 with <ul style="list-style-type: none"> <li>• absorptive material in cavity</li> <li>• steel furring channels spaced 600 mm o.c.</li> <li>• 12.7 mm regular gypsum board</li> </ul>	< 30 min	38	33
	F6 <sup>(13)</sup>	<ul style="list-style-type: none"> <li>• subfloor of 15.5 mm plywood, OSB or waferboard, or 17 mm tongue and groove lumber</li> <li>• on wood joists or wood I-joists spaced not more than 600 mm o.c.</li> <li>• with or without absorptive material in cavity</li> <li>• steel furring channels spaced 400 mm or 600 mm o.c.</li> <li>• 2 layers of gypsum board on ceiling side</li> </ul>	 <p style="text-align: right; font-size: small;">GC00105A</p>		
	F6a <sup>(16)</sup>	F6 with <ul style="list-style-type: none"> <li>• no absorptive material in cavity</li> <li>• steel furring channels spaced 400 mm o.c.</li> <li>• 15.9 mm Type X gypsum board</li> </ul>	1 h	39	32
	F6b <sup>(16)</sup>	F6 with <ul style="list-style-type: none"> <li>• no absorptive material in cavity</li> <li>• steel furring channels spaced 600 mm o.c.</li> <li>• 15.9 mm Type X gypsum board</li> </ul>	1 h	41	32
	F6c <sup>(16)</sup>	F6 with <ul style="list-style-type: none"> <li>• absorptive material in cavity</li> <li>• steel furring channels spaced 400 mm o.c.</li> <li>• 15.9 mm Type X gypsum board</li> </ul>	1 h	42	35
	F6d <sup>(16)</sup>	F6 with <ul style="list-style-type: none"> <li>• absorptive material in cavity</li> <li>• steel furring channels spaced 600 mm o.c.</li> <li>• 15.9 mm Type X gypsum board</li> </ul>	1 h	44	37
	F6e <sup>(16)</sup>	F6 with <ul style="list-style-type: none"> <li>• no absorptive material in cavity</li> <li>• steel furring channels spaced 400 mm o.c.</li> <li>• 12.7 mm Type X gypsum board</li> </ul>	1 h	38	30
	F6f <sup>(16)</sup>	F6 with <ul style="list-style-type: none"> <li>• no absorptive material in cavity</li> <li>• steel furring channels spaced 600 mm o.c.</li> <li>• 12.7 mm Type X gypsum board</li> </ul>	1 h	40	33
	F6g <sup>(16)</sup>	F6 with <ul style="list-style-type: none"> <li>• absorptive material in cavity</li> <li>• steel furring channels spaced 400 mm o.c.</li> <li>• 12.7 mm Type X gypsum board</li> </ul>	1 h	41	33
	F6h <sup>(16)</sup>	F6 with <ul style="list-style-type: none"> <li>• absorptive material in cavity</li> <li>• steel furring channels spaced 600 mm o.c.</li> <li>• 12.7 mm Type X gypsum board</li> </ul>	45 min [1 h] <sup>(17)</sup>	43	36
	F6i	F6 with <ul style="list-style-type: none"> <li>• no absorptive material in cavity</li> <li>• steel furring channels spaced 400 mm o.c.</li> <li>• 12.7 mm regular gypsum board</li> </ul>	-	37	30

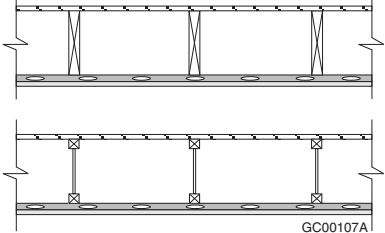
# Fire and Sound Resistance Tables

**Table 9.10.3.1.-B (Continued)**

Type of Assembly	Assembly Number	Description <sup>(2)(3)(4)</sup>	Fire-Resistance Rating <sup>(5)(6)(7)(8)</sup>	Typical Sound Transmission Class <sup>(5)(6)(9)(10)</sup> (STC)	Typical Impact Insulation Class <sup>(5)(9)(11)</sup> (IIC)
	F6j	F6 with <ul style="list-style-type: none"> <li>• no absorptive material in cavity</li> <li>• steel furring channels spaced 600 mm o.c.</li> <li>• 12.7 mm regular gypsum board</li> </ul>	-	39	33
	F6k	F6 with <ul style="list-style-type: none"> <li>• absorptive material in cavity</li> <li>• steel furring channels spaced 400 mm o.c.</li> <li>• 12.7 mm regular gypsum board</li> </ul>	-	40	33
	F6l	F6 with <ul style="list-style-type: none"> <li>• absorptive material in cavity</li> <li>• steel furring channels spaced 600 mm o.c.</li> <li>• 12.7 mm regular gypsum board</li> </ul>	-	42	36
	F7 <sup>(13)</sup>	<ul style="list-style-type: none"> <li>• subfloor of 15.5 mm plywood, OSB or waferboard, or 17 mm tongue and groove lumber</li> <li>• on wood joists or wood I-joists spaced not more than 600 mm o.c.</li> <li>• with or without absorptive material in cavity</li> <li>• 1 layer of gypsum board attached directly to joists on ceiling side</li> <li>• resilient metal channels spaced 400 mm or 600 mm o.c. attached to joists through gypsum board</li> <li>• 1 layer of gypsum board attached to resilient metal channels</li> </ul>			
	F7a <sup>(16)</sup>	F7 with <ul style="list-style-type: none"> <li>• no absorptive material in cavity</li> <li>• 15.9 mm Type X gypsum board</li> <li>• resilient metal channels</li> <li>• 15.9 mm Type X gypsum board</li> </ul>	1 h	35	27
	F7b <sup>(16)</sup>	F7 with <ul style="list-style-type: none"> <li>• absorptive material in cavity</li> <li>• 15.9 mm Type X gypsum board</li> <li>• resilient metal channels</li> <li>• 15.9 mm Type X gypsum board</li> </ul>	1 h	37	30
	F7c <sup>(16)</sup>	F7 with <ul style="list-style-type: none"> <li>• no absorptive material in cavity</li> <li>• 12.7 mm Type X gypsum board</li> <li>• resilient metal channels</li> <li>• 12.7 mm Type X gypsum board</li> </ul>	1 h	35	27
	F7d <sup>(16)</sup>	F7 with <ul style="list-style-type: none"> <li>• absorptive material in cavity</li> <li>• 12.7 mm Type X gypsum board</li> <li>• resilient metal channels</li> <li>• 12.7 mm Type X gypsum board</li> </ul>	1 h	37	30
	F7e	F7 with <ul style="list-style-type: none"> <li>• no absorptive material in cavity</li> <li>• 12.7 mm regular gypsum board</li> <li>• resilient metal channels</li> <li>• 12.7 mm regular gypsum board</li> </ul>	-	32	26
	F7f	F7 with <ul style="list-style-type: none"> <li>• absorptive material in cavity</li> <li>• 12.7 mm regular gypsum board</li> <li>• resilient metal channels</li> <li>• 12.7 mm regular gypsum board</li> </ul>	-	35	28

# Fire and Sound Resistance Tables

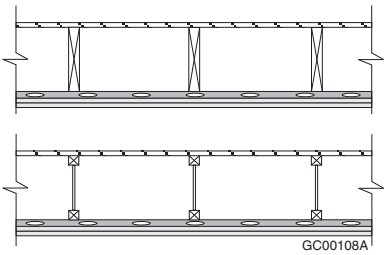
Table 9.10.3.1.-B (Continued)

Type of Assembly	Assembly Number	Description <sup>(2)(3)(4)</sup>	Fire-Resistance Rating <sup>(5)(6)(7)(8)</sup>	Typical Sound Transmission Class <sup>(5)(6)(9)(10)</sup> (STC)	Typical Impact Insulation Class <sup>(5)(9)(11)</sup> (IIC)
	<b>F8<sup>(13)</sup></b>	<ul style="list-style-type: none"> <li>• subfloor of 15.5 mm plywood, OSB or waferboard, or 17 mm tongue and groove lumber</li> <li>• on wood joists or wood I-joists spaced not more than 600 mm o.c.</li> <li>• with or without absorptive material in cavity</li> <li>• resilient metal channels spaced 400 mm or 600 mm o.c.</li> <li>• 1 layer of gypsum board on ceiling side</li> </ul>			
	F8a	<ul style="list-style-type: none"> <li>• F8 with</li> <li>• no absorptive material in cavity</li> <li>• resilient metal channels spaced 400 mm o.c.</li> <li>• 15.9 mm Type X gypsum board</li> </ul>	30 min	41	33
	F8b	<ul style="list-style-type: none"> <li>• F8 with</li> <li>• no absorptive material in cavity</li> <li>• resilient metal channels spaced 600 mm o.c.</li> <li>• 15.9 mm Type X gypsum board</li> </ul>	30 min	43	36
	F8c	<ul style="list-style-type: none"> <li>• F8 with</li> <li>• absorptive material in cavity</li> <li>• resilient metal channels spaced 400 mm o.c.</li> <li>• 15.9 mm Type X gypsum board</li> </ul>	30 min [45 min] <sup>(15)</sup>	48	41
	F8d	<ul style="list-style-type: none"> <li>• F8 with</li> <li>• absorptive material in cavity</li> <li>• resilient metal channels spaced 600 mm o.c.</li> <li>• 15.9 mm Type X gypsum board</li> </ul>	30 min	50	44
	F8e	<ul style="list-style-type: none"> <li>• F8 with</li> <li>• no absorptive material in cavity</li> <li>• resilient metal channels spaced 400 mm o.c.</li> <li>• 12.7 mm Type X gypsum board</li> </ul>	30 min	39	32
	F8f	<ul style="list-style-type: none"> <li>• F8 with</li> <li>• no absorptive material in cavity</li> <li>• resilient metal channels spaced 600 mm o.c.</li> <li>• 12.7 mm Type X gypsum board</li> </ul>	30 min	41	35
	F8g	<ul style="list-style-type: none"> <li>• F8 with</li> <li>• absorptive material in cavity</li> <li>• resilient metal channels spaced 400 mm o.c.</li> <li>• 12.7 mm Type X gypsum board</li> </ul>	30 min [45 min] <sup>(15)</sup>	46	40
	F8h	<ul style="list-style-type: none"> <li>• F8 with</li> <li>• absorptive material in cavity</li> <li>• resilient metal channels spaced 600 mm o.c.</li> <li>• 12.7 mm Type X gypsum board</li> </ul>	30 min	48	43
	F8i	<ul style="list-style-type: none"> <li>• F8 with</li> <li>• no absorptive material in cavity</li> <li>• resilient metal channels spaced 400 mm o.c.</li> <li>• 12.7 mm regular gypsum board</li> </ul>	< 30 min	41	31
	F8j	<ul style="list-style-type: none"> <li>• F8 with</li> <li>• no absorptive material in cavity</li> <li>• resilient metal channels spaced 600 mm o.c.</li> <li>• 12.7 mm regular gypsum board</li> </ul>	< 30 min	41	34
	F8k	<ul style="list-style-type: none"> <li>• F8 with</li> <li>• absorptive material in cavity</li> <li>• resilient metal channels spaced 400 mm o.c.</li> <li>• 12.7 mm regular gypsum board</li> </ul>	< 30 min	46	39

Copyright © NRC 1941 - 2021 World Rights Reserved © CNRC 1941-2021 Droits réservés pour tous pays

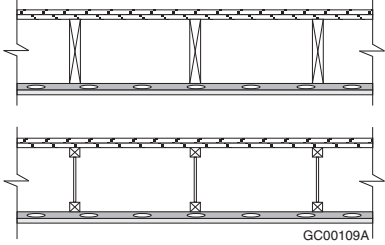
# Fire and Sound Resistance Tables

**Table 9.10.3.1.-B (Continued)**

Type of Assembly	Assembly Number	Description <sup>(2)(3)(4)</sup>	Fire-Resistance Rating <sup>(5)(6)(7)(8)</sup>	Typical Sound Transmission Class <sup>(5)(6)(9)(10)</sup> (STC)	Typical Impact Insulation Class <sup>(5)(9)(11)</sup> (IIC)
	F8l	F8 with <ul style="list-style-type: none"> <li>• absorptive material in cavity</li> <li>• resilient metal channels spaced 600 mm o.c.</li> <li>• 12.7 mm regular gypsum board</li> </ul>	< 30 min	48	42
	F9 <sup>(13)</sup>	<ul style="list-style-type: none"> <li>• subfloor of 15.5 mm plywood, OSB or waferboard, or 17 mm tongue and groove lumber</li> <li>• on wood joists or wood I-joists spaced not more than 600 mm o.c.</li> <li>• with or without absorptive material in cavity</li> <li>• resilient metal channels spaced 400 mm or 600 mm o.c.</li> <li>• 2 layers of gypsum board on ceiling side</li> </ul>			
	F9a <sup>(16)</sup>	F9 with <ul style="list-style-type: none"> <li>• no absorptive material in cavity</li> <li>• resilient metal channels spaced 400 mm o.c.</li> <li>• 15.9 mm Type X gypsum board</li> </ul>	1 h	45	38
	F9b <sup>(16)</sup>	F9 with <ul style="list-style-type: none"> <li>• no absorptive material in cavity</li> <li>• resilient metal channels spaced 600 mm o.c.</li> <li>• 15.9 mm Type X gypsum board</li> </ul>	1 h	47	40
	F9c <sup>(16)</sup>	F9 with <ul style="list-style-type: none"> <li>• absorptive material in cavity</li> <li>• resilient metal channels spaced 400 mm o.c.</li> <li>• 15.9 mm Type X gypsum board</li> </ul>	1 h [1.5 h] <sup>(18)</sup>	52 [54] <sup>(18)</sup>	46
	F9d <sup>(16)</sup>	F9 with <ul style="list-style-type: none"> <li>• absorptive material in cavity</li> <li>• resilient metal channels spaced 600 mm o.c.</li> <li>• 15.9 mm Type X gypsum board</li> </ul>	1 h [1.5 h] <sup>(18)</sup>	54 [56] <sup>(18)</sup>	48
	F9e <sup>(16)</sup>	F9 with <ul style="list-style-type: none"> <li>• no absorptive material in cavity</li> <li>• resilient metal channels spaced 400 mm o.c.</li> <li>• 12.7 mm Type X gypsum board</li> </ul>	1 h	44	36
	F9f <sup>(16)</sup>	F9 with <ul style="list-style-type: none"> <li>• no absorptive material in cavity</li> <li>• resilient metal channels spaced 600 mm o.c.</li> <li>• 12.7 mm Type X gypsum board</li> </ul>	1 h	46	39
	F9g <sup>(16)</sup>	F9 with <ul style="list-style-type: none"> <li>• absorptive material in cavity</li> <li>• resilient metal channels spaced 400 mm o.c.</li> <li>• 12.7 mm Type X gypsum board</li> </ul>	1 h [1.5 h] <sup>(18)</sup>	51 [53] <sup>(18)</sup>	44
	F9h <sup>(16)</sup>	F9 with <ul style="list-style-type: none"> <li>• absorptive material in cavity</li> <li>• resilient metal channels spaced 600 mm o.c.</li> <li>• 12.7 mm Type X gypsum board</li> </ul>	45 min [1 h] <sup>(17)</sup>	53	47
	F9i	F9 with <ul style="list-style-type: none"> <li>• no absorptive material in cavity</li> <li>• resilient metal channels spaced 400 mm o.c.</li> <li>• 12.7 mm regular gypsum board</li> </ul>	-	43	36
	F9j	F9 with <ul style="list-style-type: none"> <li>• no absorptive material in cavity</li> <li>• resilient metal channels spaced 600 mm o.c.</li> <li>• 12.7 mm regular gypsum board</li> </ul>	-	45	39

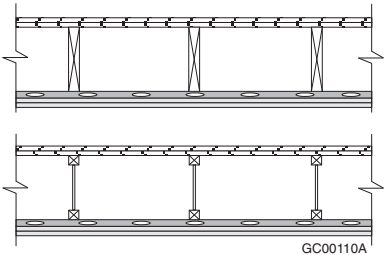
# Fire and Sound Resistance Tables

Table 9.10.3.1.-B (Continued)

Type of Assembly	Assembly Number	Description <sup>(2)(3)(4)</sup>	Fire-Resistance Rating <sup>(5)(6)(7)(8)</sup>	Typical Sound Transmission Class <sup>(5)(6)(9)(10)</sup> (STC)	Typical Impact Insulation Class <sup>(5)(9)(11)</sup> (IIC)
	F9k	F9 with <ul style="list-style-type: none"> <li>• absorptive material in cavity</li> <li>• resilient metal channels spaced 400 mm o.c.</li> <li>• 12.7 mm regular gypsum board</li> </ul>	-	50	44
	F9l	F9 with <ul style="list-style-type: none"> <li>• absorptive material in cavity</li> <li>• resilient metal channels spaced 600 mm o.c.</li> <li>• 12.7 mm regular gypsum board</li> </ul>	-	52	47
	F10 <sup>(13)</sup>	<ul style="list-style-type: none"> <li>• one subfloor layer of 11 mm sanded plywood, or OSB or waferboard</li> <li>• one subfloor layer of 15.5 mm plywood, OSB or waferboard, or 17 mm tongue and groove lumber</li> <li>• on wood joists or wood I-joists spaced not more than 600 mm o.c.</li> <li>• with or without absorptive material in cavity</li> <li>• resilient metal channels spaced 300, 400 or 600 mm o.c.</li> <li>• 1 layer of gypsum board on ceiling side</li> </ul>			
	F10a	F10 with <ul style="list-style-type: none"> <li>• no absorptive material in cavity</li> <li>• resilient metal channels spaced 400 mm o.c.</li> <li>• 15.9 mm Type X gypsum board</li> </ul>	30 min	44	34
	F10b	F10 with <ul style="list-style-type: none"> <li>• no absorptive material in cavity</li> <li>• resilient metal channels spaced 600 mm o.c.</li> <li>• 15.9 mm Type X gypsum board</li> </ul>	30 min	46	37
	F10c	F10 with <ul style="list-style-type: none"> <li>• absorptive material in cavity</li> <li>• resilient metal channels spaced 400 mm o.c.</li> <li>• 15.9 mm Type X gypsum board</li> </ul>	30 min [45 min] <sup>(17)</sup>	51	42
	F10d	F10 with <ul style="list-style-type: none"> <li>• absorptive material in cavity</li> <li>• resilient metal channels spaced 600 mm o.c.</li> <li>• 15.9 mm Type X gypsum board</li> </ul>	30 min [45 min] <sup>(15)</sup>	53	45
	F10e	F10 with <ul style="list-style-type: none"> <li>• wood joists spaced at 400 mm o.c.</li> <li>• absorptive material in cavity</li> <li>• resilient metal channels spaced 400 mm o.c.</li> <li>• 15.9 mm Type X gypsum board</li> </ul>	1 h <sup>(19)</sup>	53 <sup>(19)</sup>	44
	F10f <sup>(20)</sup>	F10 with <ul style="list-style-type: none"> <li>• wood I-joists spaced at 400 mm o.c.</li> <li>• absorptive material in cavity</li> <li>• resilient metal channels spaced 300 mm o.c.</li> <li>• 15.9 mm Type X gypsum board</li> </ul>	1 h <sup>(19)</sup>	52 <sup>(19)</sup>	43
	F10g	F10 with <ul style="list-style-type: none"> <li>• no absorptive material in cavity</li> <li>• resilient metal channels spaced 400 mm o.c.</li> <li>• 12.7 mm Type X gypsum board</li> </ul>	30 min	42	33
	F10h	F10 with <ul style="list-style-type: none"> <li>• no absorptive material in cavity</li> <li>• resilient metal channels spaced 600 mm o.c.</li> <li>• 12.7 mm Type X gypsum board</li> </ul>	30 min	44	36
	F10i	F10 with <ul style="list-style-type: none"> <li>• absorptive material in cavity</li> <li>• resilient metal channels spaced 400 mm o.c.</li> <li>• 12.7 mm Type X gypsum board</li> </ul>	30 min [45 min] <sup>(17)</sup>	49	41

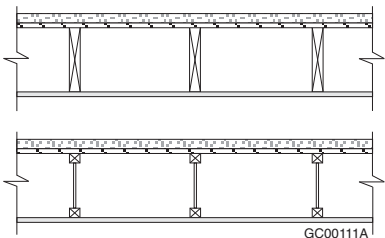
# Fire and Sound Resistance Tables

**Table 9.10.3.1.-B (Continued)**

Type of Assembly	Assembly Number	Description <sup>(2)(3)(4)</sup>	Fire-Resistance Rating <sup>(5)(6)(7)(8)</sup>	Typical Sound Transmission Class <sup>(5)(6)(9)(10)</sup> (STC)	Typical Impact Insulation Class <sup>(5)(9)(11)</sup> (IIC)
	F10j	F10 with <ul style="list-style-type: none"> <li>• absorptive material in cavity</li> <li>• resilient metal channels spaced 600 mm o.c.</li> <li>• 12.7 mm Type X gypsum board</li> </ul>	30 min [45 min] <sup>(15)</sup>	51	44
	F10k	F10 with <ul style="list-style-type: none"> <li>• no absorptive material in cavity</li> <li>• resilient metal channels spaced 400 mm o.c.</li> <li>• 12.7 mm regular gypsum board</li> </ul>	-	42	33
	F10l	F10 with <ul style="list-style-type: none"> <li>• no absorptive material in cavity</li> <li>• resilient metal channels spaced 600 mm o.c.</li> <li>• 12.7 mm regular gypsum board</li> </ul>	-	44	35
	F10m	F10 with <ul style="list-style-type: none"> <li>• absorptive material in cavity</li> <li>• resilient metal channels spaced 400 mm o.c.</li> <li>• 12.7 mm regular gypsum board</li> </ul>	-	49	41
	F10n	F10 with <ul style="list-style-type: none"> <li>• absorptive material in cavity</li> <li>• resilient metal channels spaced 600 mm o.c.</li> <li>• 12.7 mm regular gypsum board</li> </ul>	-	51	43
	F11 <sup>(13)</sup>	<ul style="list-style-type: none"> <li>• one subfloor layer of 11 mm sanded plywood, or OSB or waferboard</li> <li>• one subfloor layer of 15.5 mm plywood, OSB or waferboard, or 17 mm tongue and groove lumber</li> <li>• on wood joists or wood I-joists spaced not more than 600 mm o.c.</li> <li>• with or without absorptive material in cavity</li> <li>• resilient metal channels spaced 400 mm or 600 mm o.c.</li> <li>• 2 layers of gypsum board on ceiling side</li> </ul>			
	F11a <sup>(16)</sup>	F11 with <ul style="list-style-type: none"> <li>• no absorptive material in cavity</li> <li>• resilient metal channels spaced 400 mm o.c.</li> <li>• 15.9 mm Type X gypsum board</li> </ul>	1 h	48	39
	F11b <sup>(16)</sup>	F11 with <ul style="list-style-type: none"> <li>• no absorptive material in cavity</li> <li>• resilient metal channels spaced 600 mm o.c.</li> <li>• 15.9 mm Type X gypsum board</li> </ul>	1 h	50	42
	F11c <sup>(16)</sup>	F11 with <ul style="list-style-type: none"> <li>• absorptive material in cavity</li> <li>• resilient metal channels spaced 400 mm o.c.</li> <li>• 15.9 mm Type X gypsum board</li> </ul>	1 h [1.5 h] <sup>(18)</sup>	55 [56] <sup>(18)</sup>	47
	F11d <sup>(16)</sup>	F11 with <ul style="list-style-type: none"> <li>• absorptive material in cavity</li> <li>• resilient metal channels spaced 600 mm o.c.</li> <li>• 15.9 mm Type X gypsum board</li> </ul>	1 h [1.5 h] <sup>(18)</sup>	57 [58] <sup>(18)</sup>	50
	F11e <sup>(16)</sup>	F11 with <ul style="list-style-type: none"> <li>• wood joists spaced 400 mm o.c.</li> <li>• absorptive material in cavity</li> <li>• resilient metal channels spaced 400 mm o.c.</li> <li>• 15.9 mm Type X gypsum board</li> </ul>	1.5 h <sup>(21)</sup>	56 <sup>(21)</sup>	47
	F11f <sup>(20)</sup>	F11 with <ul style="list-style-type: none"> <li>• wood I-joists spaced 400 mm o.c.</li> <li>• absorptive material in cavity</li> <li>• resilient metal channels spaced 300 mm o.c.</li> <li>• 15.9 mm Type X gypsum board</li> </ul>	1.5 h <sup>(21)</sup>	56 <sup>(21)</sup>	46

# Fire and Sound Resistance Tables

Table 9.10.3.1.-B (Continued)

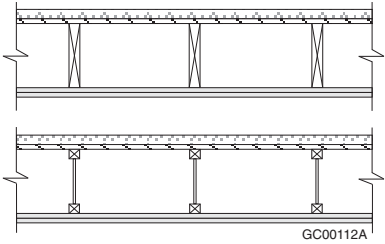
Type of Assembly	Assembly Number	Description <sup>(2)(3)(4)</sup>	Fire-Resistance Rating <sup>(5)(6)(7)(8)</sup>	Typical Sound Transmission Class <sup>(5)(6)(9)(10)</sup> (STC)	Typical Impact Insulation Class <sup>(5)(9)(11)</sup> (IIC)
	F11g <sup>(16)</sup>	F11 with <ul style="list-style-type: none"> <li>no absorptive material in cavity</li> <li>resilient metal channels spaced 400 mm o.c.</li> <li>12.7 mm Type X gypsum board</li> </ul>	1 h	47	38
	F11h <sup>(16)</sup>	F11 with <ul style="list-style-type: none"> <li>no absorptive material in cavity</li> <li>resilient metal channels spaced 600 mm o.c.</li> <li>12.7 mm Type X gypsum board</li> </ul>	1 h	49	40
	F11i <sup>(16)</sup>	F11 with <ul style="list-style-type: none"> <li>absorptive material in cavity</li> <li>resilient metal channels spaced 400 mm o.c.</li> <li>12.7 mm Type X gypsum board</li> </ul>	1 h [1.5 h] <sup>(18)</sup>	54 [55] <sup>(18)</sup>	46
	F11j <sup>(16)</sup>	F11 with <ul style="list-style-type: none"> <li>absorptive material in cavity</li> <li>resilient metal channels spaced 600 mm o.c.</li> <li>12.7 mm Type X gypsum board</li> </ul>	45 min [1 h] <sup>(17)</sup>	56	48
	F11k	F11 with <ul style="list-style-type: none"> <li>no absorptive material in cavity</li> <li>resilient metal channels spaced 400 mm o.c.</li> <li>12.7 mm regular gypsum board</li> </ul>	-	46	37
	F11l	F11 with <ul style="list-style-type: none"> <li>no absorptive material in cavity</li> <li>resilient metal channels spaced 600 mm o.c.</li> <li>12.7 mm regular gypsum board</li> </ul>	-	48	40
	F11m	F11 with <ul style="list-style-type: none"> <li>absorptive material in cavity</li> <li>resilient metal channels spaced 400 mm o.c.</li> <li>12.7 mm regular gypsum board</li> </ul>	-	53	45
	F11n	F11 with <ul style="list-style-type: none"> <li>absorptive material in cavity</li> <li>resilient metal channels spaced 600 mm o.c.</li> <li>12.7 mm regular gypsum board</li> </ul>	-	55	48
	<b>F12<sup>(13)</sup></b>	<ul style="list-style-type: none"> <li>25 mm gypsum-concrete topping (at least 44 kg/m<sup>2</sup>)</li> <li>subfloor of 15.5 mm plywood, OSB or waferboard, or 17 mm tongue and groove lumber</li> <li>on wood joists or wood I-joists spaced not more than 600 mm o.c.</li> <li>with or without absorptive material in cavity</li> <li>1 layer of gypsum board on ceiling side</li> </ul>			
	F12a	F12 with <ul style="list-style-type: none"> <li>no absorptive material in cavity</li> <li>15.9 mm Type X gypsum board</li> </ul>	-	41	13
	F12b	F12 with <ul style="list-style-type: none"> <li>absorptive material in cavity</li> <li>15.9 mm Type X gypsum board</li> </ul>	-	43	16
	F12c	F12 with <ul style="list-style-type: none"> <li>no absorptive material in cavity</li> <li>12.7 mm Type X gypsum board</li> </ul>	-	39	12
	F12d	F12 with <ul style="list-style-type: none"> <li>absorptive material in cavity</li> <li>12.7 mm Type X gypsum board</li> </ul>	-	41	15

Copyright © NRC 1941 - 2021 World Rights Reserved © CNRC 1941-2021 Droits réservés pour tous pays



# Fire and Sound Resistance Tables

**Table 9.10.3.1.-B (Continued)**

Type of Assembly	Assembly Number	Description <sup>(2)(3)(4)</sup>	Fire-Resistance Rating <sup>(5)(6)(7)(8)</sup>	Typical Sound Transmission Class <sup>(5)(6)(9)(10)</sup> (STC)	Typical Impact Insulation Class <sup>(5)(9)(11)</sup> (IIC)
	F12e	F12 with <ul style="list-style-type: none"> <li>no absorptive material in cavity</li> <li>12.7 mm regular gypsum board</li> </ul>	-	39	12
	F12f	F12 with <ul style="list-style-type: none"> <li>absorptive material in cavity</li> <li>12.7 mm regular gypsum board</li> </ul>	-	41	15
	<b>F13<sup>(13)</sup></b>	<ul style="list-style-type: none"> <li>25 mm gypsum-concrete topping (at least 44 kg/m<sup>2</sup>)</li> <li>subfloor of 15.5 mm plywood, OSB or waferboard, or 17 mm tongue and groove lumber</li> <li>on wood joists or wood I-joists spaced not more than 600 mm o.c.</li> <li>with or without absorptive material in cavity</li> <li>2 layers of gypsum board on ceiling side</li> </ul>	 <p style="text-align: right; font-size: small;">GC00112A</p>		
	F13a	F13 with <ul style="list-style-type: none"> <li>wood joists or wood I-joists spaced 400 mm o.c.</li> <li>no absorptive material in cavity</li> <li>15.9 mm Type X gypsum board</li> </ul>	1 h	43	16
	F13b	F13 with <ul style="list-style-type: none"> <li>wood joists or wood I-joists spaced 600 mm o.c.</li> <li>no absorptive material in cavity</li> <li>15.9 mm Type X gypsum board</li> </ul>	1 h	45	16
	F13c	F13 with <ul style="list-style-type: none"> <li>wood joists or wood I-joists spaced 400 mm o.c.</li> <li>absorptive material in cavity</li> <li>15.9 mm Type X gypsum board</li> </ul>	45 min [1 h] <sup>(14)</sup>	45	19
	F13d	F13 with <ul style="list-style-type: none"> <li>wood joists or wood I-joists spaced 600 mm o.c.</li> <li>absorptive material in cavity</li> <li>15.9 mm Type X gypsum board</li> </ul>	45 min	47	19
	F13e	F13 with <ul style="list-style-type: none"> <li>wood joists or wood I-joists spaced 400 mm o.c.</li> <li>no absorptive material in cavity</li> <li>12.7 mm Type X gypsum board</li> </ul>	1 h	42	15
	F13f	F13 with <ul style="list-style-type: none"> <li>wood joists or wood I-joists spaced 600 mm o.c.</li> <li>no absorptive material in cavity</li> <li>12.7 mm Type X gypsum board</li> </ul>	45 min	44	15
	F13g	F13 with <ul style="list-style-type: none"> <li>wood joists or wood I-joists spaced 400 mm o.c.</li> <li>absorptive material in cavity</li> <li>12.7 mm Type X gypsum board</li> </ul>	45 min	44	18
	F13h	F13 with <ul style="list-style-type: none"> <li>wood joists or wood I-joists spaced 600 mm o.c.</li> <li>no absorptive material in cavity</li> <li>12.7 mm Type X gypsum board</li> </ul>	-	46	18
	F13i	F13 with <ul style="list-style-type: none"> <li>no absorptive material in cavity</li> <li>12.7 mm regular gypsum board</li> </ul>	-	41	14
	F13j	F13 with <ul style="list-style-type: none"> <li>absorptive material in cavity</li> <li>12.7 mm regular gypsum board</li> </ul>	-	45	14

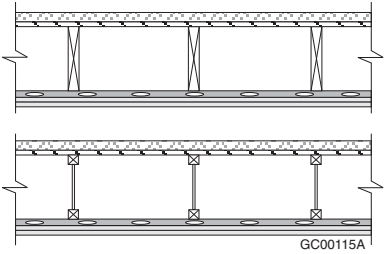
# Fire and Sound Resistance Tables

Table 9.10.3.1.-B (Continued)

Type of Assembly	Assembly Number	Description <sup>(2)(3)(4)</sup>	Fire-Resistance Rating <sup>(5)(6)(7)(8)</sup>	Typical Sound Transmission Class <sup>(5)(6)(9)(10)</sup> (STC)	Typical Impact Insulation Class <sup>(5)(9)(11)</sup> (IIC)
	<b>F14<sup>(13)</sup></b>	<ul style="list-style-type: none"> <li>• 25 mm gypsum-concrete topping (at least 44 kg/m<sup>2</sup>)</li> <li>• subfloor of 15.5 mm plywood, OSB or waterboard, or 17 mm tongue and groove lumber</li> <li>• on wood joists or wood I-joists spaced not more than 600 mm o.c.</li> <li>• with or without absorptive material in cavity</li> <li>• resilient metal channels spaced 300, 400 or 600 mm o.c.</li> <li>• 1 layer of gypsum board on ceiling side</li> </ul>			
	F14a	<ul style="list-style-type: none"> <li>• F14 with</li> <li>• no absorptive material in cavity</li> <li>• resilient metal channels spaced 400 mm o.c.</li> <li>• 15.9 mm Type X gypsum board</li> </ul>	-	53	22
	F14b	<ul style="list-style-type: none"> <li>• F14 with</li> <li>• no absorptive material in cavity</li> <li>• resilient metal channels spaced 600 mm o.c.</li> <li>• 15.9 mm Type X gypsum board</li> </ul>	-	55	22
	F14c	<ul style="list-style-type: none"> <li>• F14 with</li> <li>• absorptive material in cavity</li> <li>• resilient metal channels spaced 400 mm o.c.</li> <li>• 15.9 mm Type X gypsum board</li> </ul>	30 min [45 min] <sup>(17)</sup>	60	30
	F14d	<ul style="list-style-type: none"> <li>• F14 with</li> <li>• absorptive material in cavity</li> <li>• resilient metal channels spaced 600 mm o.c.</li> <li>• 15.9 mm Type X gypsum board</li> </ul>	-	62	30
	F14e	<ul style="list-style-type: none"> <li>• F14 with</li> <li>• wood joists spaced 400 mm o.c.</li> <li>• absorptive material in cavity</li> <li>• resilient metal channels spaced 400 mm o.c.</li> <li>• 15.9 mm Type X gypsum board</li> </ul>	1 h <sup>(19)</sup>	60 <sup>(19)</sup>	31
	F14f <sup>(20)</sup>	<ul style="list-style-type: none"> <li>• F14 with</li> <li>• wood I-joists spaced 400 mm o.c.</li> <li>• absorptive material in cavity</li> <li>• resilient metal channels spaced 300 mm o.c.</li> <li>• 15.9 mm Type X gypsum board</li> </ul>	1 h <sup>(19)</sup>	61 <sup>(19)</sup>	31
	F14g	<ul style="list-style-type: none"> <li>• F14 with</li> <li>• no absorptive material in cavity</li> <li>• resilient metal channels spaced 400 mm o.c.</li> <li>• 12.7 mm Type X gypsum board</li> </ul>	-	51	21
	F14h	<ul style="list-style-type: none"> <li>• F14 with</li> <li>• no absorptive material in cavity</li> <li>• resilient metal channels spaced 600 mm o.c.</li> <li>• 12.7 mm Type X gypsum board</li> </ul>	-	53	21
	F14i	<ul style="list-style-type: none"> <li>• F14 with</li> <li>• absorptive material in cavity</li> <li>• resilient metal channels spaced 400 mm o.c.</li> <li>• 12.7 mm Type X gypsum board</li> </ul>	-	58	29
	F14j	<ul style="list-style-type: none"> <li>• F14 with</li> <li>• absorptive material in cavity</li> <li>• resilient metal channels spaced 600 mm o.c.</li> <li>• 12.7 mm Type X gypsum board</li> </ul>	-	60	29
	F14k	<ul style="list-style-type: none"> <li>• F14 with</li> <li>• no absorptive material in cavity</li> <li>• resilient metal channels spaced 400 mm o.c.</li> <li>• 12.7 mm regular gypsum board</li> </ul>	-	51	21

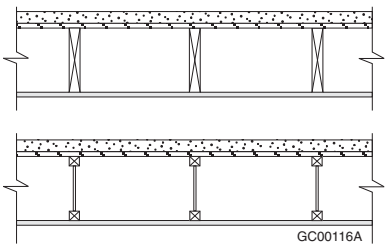
# Fire and Sound Resistance Tables

**Table 9.10.3.1.-B (Continued)**

Type of Assembly	Assembly Number	Description <sup>(2)(3)(4)</sup>	Fire-Resistance Rating <sup>(5)(6)(7)(8)</sup>	Typical Sound Transmission Class <sup>(5)(6)(9)(10)</sup> (STC)	Typical Impact Insulation Class <sup>(5)(9)(11)</sup> (IIC)
	F14l	F14 with <ul style="list-style-type: none"> <li>no absorptive material in cavity</li> <li>resilient metal channels spaced 600 mm o.c.</li> <li>12.7 mm regular gypsum board</li> </ul>	-	53	21
	F14m	F14 with <ul style="list-style-type: none"> <li>absorptive material in cavity</li> <li>resilient metal channels spaced 400 mm o.c.</li> <li>12.7 mm regular gypsum board</li> </ul>	-	58	29
	F14n	F14 with <ul style="list-style-type: none"> <li>absorptive material in cavity</li> <li>resilient metal channels spaced 600 mm o.c.</li> <li>12.7 mm regular gypsum board</li> </ul>	-	60	29
	<b>F15<sup>(13)</sup></b>	<ul style="list-style-type: none"> <li>25 mm gypsum-concrete topping (at least 44 kg/m<sup>2</sup>)</li> <li>subfloor of 15.5 mm plywood, OSB or waferboard, or 17 mm tongue and groove lumber</li> <li>on wood joists or wood I-joists spaced not more than 600 mm o.c.</li> <li>with or without absorptive material in cavity</li> <li>resilient metal channels spaced 400 mm or 600 mm o.c.</li> <li>2 layers of gypsum board on ceiling side</li> </ul>	 <p style="text-align: right; font-size: small;">GC00115A</p>		
	F15a <sup>(16)</sup>	F15 with <ul style="list-style-type: none"> <li>no absorptive material in cavity</li> <li>resilient metal channels spaced 400 mm o.c.</li> <li>15.9 mm Type X gypsum board</li> </ul>	1 h <sup>(22)</sup>	57	25
	F15b <sup>(16)</sup>	F15 with <ul style="list-style-type: none"> <li>no absorptive material in cavity</li> <li>resilient metal channels spaced 600 mm o.c.</li> <li>15.9 mm Type X gypsum board</li> </ul>	1 h	59	25
	F15c <sup>(16)</sup>	F15 with <ul style="list-style-type: none"> <li>absorptive material in cavity</li> <li>resilient metal channels spaced 400 mm o.c.</li> <li>15.9 mm Type X gypsum board</li> </ul>	1 h [1.5 h] <sup>(18)</sup>	64 [65] <sup>(18)</sup>	33
	F15d <sup>(16)</sup>	F15 with <ul style="list-style-type: none"> <li>absorptive material in cavity</li> <li>resilient metal channels spaced 600 mm o.c.</li> <li>15.9 mm Type X gypsum board</li> </ul>	1 h [1.5 h] <sup>(18)</sup>	66 [67] <sup>(18)</sup>	33
	F15e <sup>(16)</sup>	F15 with <ul style="list-style-type: none"> <li>wood joists spaced 400 mm o.c.</li> <li>absorptive material in cavity</li> <li>resilient metal channels spaced 400 mm o.c.</li> <li>15.9 mm Type X gypsum board</li> </ul>	1.5 h <sup>(21)</sup>	65 <sup>(21)</sup>	33
	F15f <sup>(20)</sup>	F15 with <ul style="list-style-type: none"> <li>wood I-joists spaced 400 mm o.c.</li> <li>absorptive material in cavity</li> <li>resilient metal channels spaced 300 mm o.c.</li> <li>15.9 mm Type X gypsum board</li> </ul>	1.5 h <sup>(21)</sup>	64 <sup>(21)</sup>	33
	F15g <sup>(16)</sup>	F15 with <ul style="list-style-type: none"> <li>no absorptive material in cavity</li> <li>resilient metal channels spaced 400 mm o.c.</li> <li>12.7 mm Type X gypsum board</li> </ul>	1 h	56	24
	F15h <sup>(16)</sup>	F15 with <ul style="list-style-type: none"> <li>no absorptive material in cavity</li> <li>resilient metal channels spaced 600 mm o.c.</li> <li>12.7 mm Type X gypsum board</li> </ul>	1 h	58	24

# Fire and Sound Resistance Tables

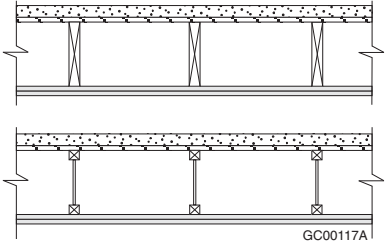
Table 9.10.3.1.-B (Continued)

Type of Assembly	Assembly Number	Description <sup>(2)(3)(4)</sup>	Fire-Resistance Rating <sup>(5)(6)(7)(8)</sup>	Typical Sound Transmission Class <sup>(5)(6)(9)(10)</sup> (STC)	Typical Impact Insulation Class <sup>(5)(9)(11)</sup> (IIC)
	F15j <sup>(16)</sup>	F15 with <ul style="list-style-type: none"> <li>• absorptive material in cavity</li> <li>• resilient metal channels spaced 400 mm o.c.</li> <li>• 12.7 mm Type X gypsum board</li> </ul>	1 h [1.5 h] <sup>(18)</sup>	63 [64] <sup>(18)</sup>	32
	F15j <sup>(16)</sup>	F15 with <ul style="list-style-type: none"> <li>• absorptive material in cavity</li> <li>• resilient metal channels spaced 600 mm o.c.</li> <li>• 12.7 mm Type X gypsum board</li> </ul>	45 min [1 h] <sup>(17)</sup>	65	32
	F15k	F15 with <ul style="list-style-type: none"> <li>• no absorptive material in cavity</li> <li>• resilient metal channels spaced 400 mm o.c.</li> <li>• 12.7 mm regular gypsum board</li> </ul>	-	55	23
	F15l	F15 with <ul style="list-style-type: none"> <li>• no absorptive material in cavity</li> <li>• resilient metal channels spaced 600 mm o.c.</li> <li>• 12.7 mm regular gypsum board</li> </ul>	-	57	23
	F15m	F15 with <ul style="list-style-type: none"> <li>• absorptive material in cavity</li> <li>• resilient metal channels spaced 400 mm o.c.</li> <li>• 12.7 mm regular gypsum board</li> </ul>	-	62	31
	F15n	F15 with <ul style="list-style-type: none"> <li>• absorptive material in cavity</li> <li>• resilient metal channels spaced 600 mm o.c.</li> <li>• 12.7 mm regular gypsum board</li> </ul>	-	64	31
	F16 <sup>(13)</sup>	<ul style="list-style-type: none"> <li>• 38 mm concrete topping (at least 70 kg/m<sup>2</sup>)</li> <li>• subfloor of 15.5 mm plywood, OSB or waferboard, or 17 mm tongue and groove lumber</li> <li>• on wood joists or wood I-joists spaced not more than 600 mm o.c.</li> <li>• with or without absorptive material in cavity</li> <li>• 1 layer of gypsum board on ceiling side</li> </ul>			
	F16a	F 16 with <ul style="list-style-type: none"> <li>• no absorptive material in cavity</li> <li>• 15.9 mm Type X gypsum board</li> </ul>	-	44	22
	F16b	F16 with <ul style="list-style-type: none"> <li>• absorptive material in cavity</li> <li>• 15.9 mm Type X gypsum board</li> </ul>	-	46	25
	F16c	F16 with <ul style="list-style-type: none"> <li>• no absorptive material in cavity</li> <li>• 12.7 mm Type X gypsum board</li> </ul>	-	43	21
	F16d	F16 with <ul style="list-style-type: none"> <li>• absorptive material in cavity</li> <li>• 12.7 mm Type X gypsum board</li> </ul>	-	45	24
	F16e	F16 with <ul style="list-style-type: none"> <li>• no absorptive material in cavity</li> <li>• 12.7 mm regular gypsum board</li> </ul>	-	42	21
	F16f	F16 with <ul style="list-style-type: none"> <li>• absorptive material in cavity</li> <li>• 12.7 mm regular gypsum board</li> </ul>	-	44	24

Copyright © NRC 1941 - 2021 World Rights Reserved © CNRC 1941-2021 Droits réservés pour tous pays

# Fire and Sound Resistance Tables

**Table 9.10.3.1.-B (Continued)**

Type of Assembly	Assembly Number	Description <sup>(2)(3)(4)</sup>	Fire-Resistance Rating <sup>(5)(6)(7)(8)</sup>	Typical Sound Transmission Class <sup>(5)(6)(9)(10)</sup> (STC)	Typical Impact Insulation Class <sup>(5)(9)(11)</sup> (IIC)
	<b>F17<sup>(13)</sup></b>	<ul style="list-style-type: none"> <li>• 38 mm concrete topping (at least 70 kg/m<sup>2</sup>)</li> <li>• subfloor of 15.5 mm plywood, OSB or waferboard, or 17 mm tongue and groove lumber</li> <li>• on wood joists or wood I-joists spaced not more than 600 mm o.c.</li> <li>• with or without absorptive material in cavity</li> <li>• 2 layers of gypsum board on ceiling side</li> </ul>			
	F17a	<ul style="list-style-type: none"> <li>• F17 with</li> <li>• wood joists or wood I-joists spaced 400 mm o.c.</li> <li>• no absorptive material in cavity</li> <li>• 15.9 mm Type X gypsum board</li> </ul>	1 h	48	24
	F17b	<ul style="list-style-type: none"> <li>• F17 with</li> <li>• wood joists or wood I-joists spaced 600 mm o.c.</li> <li>• no absorptive material in cavity</li> <li>• 15.9 mm Type X gypsum board</li> </ul>	1 h	51	24
	F17c	<ul style="list-style-type: none"> <li>• F17 with</li> <li>• wood joists or wood I-joists spaced 400 mm o.c.</li> <li>• absorptive material in cavity</li> <li>• 15.9 mm Type X gypsum board</li> </ul>	45 min [1 h] <sup>(14)</sup>	48	27
	F17d	<ul style="list-style-type: none"> <li>• F17 with</li> <li>• wood joists or wood I-joists spaced 600 mm o.c.</li> <li>• absorptive material in cavity</li> <li>• 15.9 mm Type X gypsum board</li> </ul>	45 min	51	27
	F17e	<ul style="list-style-type: none"> <li>• F17 with</li> <li>• wood joists or wood I-joists spaced 400 mm o.c.</li> <li>• no absorptive material in cavity</li> <li>• 12.7 mm Type X gypsum board</li> </ul>	1 h	47	23
	F17f	<ul style="list-style-type: none"> <li>• F17 with</li> <li>• wood joists or wood I-joists spaced 600 mm o.c.</li> <li>• no absorptive material in cavity</li> <li>• 12.7 mm Type X gypsum board</li> </ul>	45 min	48	23
	F17g	<ul style="list-style-type: none"> <li>• F17 with</li> <li>• wood joists or wood I-joists spaced 400 mm o.c.</li> <li>• absorptive material in cavity</li> <li>• 12.7 mm Type X gypsum board</li> </ul>	45 min	49	26
	F17h	<ul style="list-style-type: none"> <li>• F17 with</li> <li>• wood joists or wood I-joists spaced 600 mm o.c.</li> <li>• absorptive material in cavity</li> <li>• 12.7 mm Type X gypsum board</li> </ul>	-	50	26
	F17i	<ul style="list-style-type: none"> <li>• F17 with</li> <li>• no absorptive material in cavity</li> <li>• 12.7 mm regular gypsum board</li> </ul>	-	47	23
	F17j	<ul style="list-style-type: none"> <li>• F17 with</li> <li>• absorptive material in cavity</li> <li>• 12.7 mm regular gypsum board</li> </ul>	-	49	26

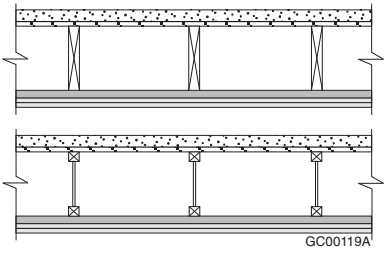
# Fire and Sound Resistance Tables

Table 9.10.3.1.-B (Continued)

Type of Assembly	Assembly Number	Description <sup>(2)(3)(4)</sup>	Fire-Resistance Rating <sup>(5)(6)(7)(8)</sup>	Typical Sound Transmission Class <sup>(5)(6)(9)(10)</sup> (STC)	Typical Impact Insulation Class <sup>(5)(9)(11)</sup> (IIC)
	<b>F18<sup>(13)</sup></b>	<ul style="list-style-type: none"> <li>• 38 mm concrete topping (at least 70 kg/m<sup>2</sup>)</li> <li>• subfloor of 15.5 mm plywood, OSB or waferboard, or 17 mm tongue and groove lumber</li> <li>• on wood joists or wood I-joists spaced not more than 600 mm o.c.</li> <li>• with or without absorptive material in cavity</li> <li>• steel furring channels spaced 400 mm or 600 mm o.c.</li> <li>• 1 layer of gypsum board on ceiling side</li> </ul>			
	F18a	<ul style="list-style-type: none"> <li>• F18 with</li> <li>• no absorptive material in cavity</li> <li>• steel furring channels spaced 400 mm o.c.</li> <li>• 15.9 mm Type X gypsum board</li> </ul>	-	50	25
	F18b	<ul style="list-style-type: none"> <li>• F18 with</li> <li>• no absorptive material in cavity</li> <li>• steel furring channels spaced 600 mm o.c.</li> <li>• 15.9 mm Type X gypsum board</li> </ul>	-	52	25
	F18c	<ul style="list-style-type: none"> <li>• F18 with</li> <li>• absorptive material in cavity</li> <li>• steel furring channels spaced 400 mm o.c.</li> <li>• 15.9 mm Type X gypsum board</li> </ul>	-	53	28
	F18d	<ul style="list-style-type: none"> <li>• F18 with</li> <li>• absorptive material in cavity</li> <li>• steel furring channels spaced 600 mm o.c.</li> <li>• 15.9 mm Type X gypsum board</li> </ul>	-	55	28
	F18e	<ul style="list-style-type: none"> <li>• F18 with</li> <li>• no absorptive material in cavity</li> <li>• steel furring channels spaced 400 mm o.c.</li> <li>• 12.7 mm Type X gypsum board</li> </ul>	-	49	24
	F18f	<ul style="list-style-type: none"> <li>• F18 with</li> <li>• no absorptive material in cavity</li> <li>• steel furring channels spaced 600 mm o.c.</li> <li>• 12.7 mm Type X gypsum board</li> </ul>	-	51	24
	F18g	<ul style="list-style-type: none"> <li>• F18 with</li> <li>• absorptive material in cavity</li> <li>• steel furring channels spaced 400 mm o.c.</li> <li>• 12.7 mm Type X gypsum board</li> </ul>	-	52	27
	F18h	<ul style="list-style-type: none"> <li>• F18 with</li> <li>• absorptive material in cavity</li> <li>• steel furring channels spaced 600 mm o.c.</li> <li>• 12.7 mm Type X gypsum board</li> </ul>	-	54	27
	F18i	<ul style="list-style-type: none"> <li>• F18 with</li> <li>• no absorptive material in cavity</li> <li>• steel furring channels spaced 400 mm o.c.</li> <li>• 12.7 mm regular gypsum board</li> </ul>	-	48	24
	F18j	<ul style="list-style-type: none"> <li>• F18 with</li> <li>• no absorptive material in cavity</li> <li>• steel furring channels spaced 600 mm o.c.</li> <li>• 12.7 mm regular gypsum board</li> </ul>	-	50	24
	F18k	<ul style="list-style-type: none"> <li>• F18 with</li> <li>• absorptive material in cavity</li> <li>• steel furring channels spaced 400 mm o.c.</li> <li>• 12.7 mm regular gypsum board</li> </ul>	-	51	27

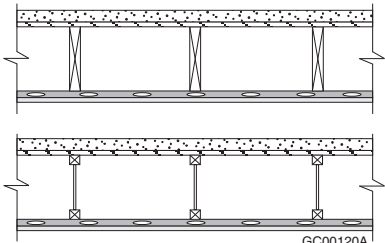
# Fire and Sound Resistance Tables

**Table 9.10.3.1.-B (Continued)**

Type of Assembly	Assembly Number	Description <sup>(2)(3)(4)</sup>	Fire-Resistance Rating <sup>(5)(6)(7)(8)</sup>	Typical Sound Transmission Class <sup>(5)(6)(9)(10)</sup> (STC)	Typical Impact Insulation Class <sup>(5)(9)(11)</sup> (IIC)
	F18l	F18 with <ul style="list-style-type: none"> <li>• absorptive material in cavity</li> <li>• steel furring channels spaced 600 mm o.c.</li> <li>• 12.7 mm regular gypsum board</li> </ul>	-	53	27
	F19 <sup>(13)</sup>	<ul style="list-style-type: none"> <li>• 38 mm concrete topping (at least 70 kg/m<sup>2</sup>)</li> <li>• subfloor of 15.5 mm plywood, OSB or waferboard, or 17 mm tongue and groove lumber</li> <li>• on wood joists or wood I-joists spaced not more than 600 mm o.c.</li> <li>• with or without absorptive material in cavity</li> <li>• steel furring channels spaced 400 mm or 600 mm o.c.</li> <li>• 2 layers of gypsum board on ceiling side</li> </ul>	 <p style="text-align: right; font-size: small;">GC00119A</p>		
	F19a <sup>(16)</sup>	F19 with <ul style="list-style-type: none"> <li>• no absorptive material in cavity</li> <li>• steel furring channels spaced 400 mm o.c.</li> <li>• 15.9 mm Type X gypsum board</li> </ul>	1 h	54	27
	F19b <sup>(16)</sup>	F19 with <ul style="list-style-type: none"> <li>• no absorptive material in cavity</li> <li>• steel furring channels spaced 600 mm o.c.</li> <li>• 15.9 mm Type X gypsum board</li> </ul>	1 h	56	27
	F19c <sup>(16)</sup>	F19 with <ul style="list-style-type: none"> <li>• absorptive material in cavity</li> <li>• steel furring channels spaced 400 mm o.c.</li> <li>• 15.9 mm Type X gypsum board</li> </ul>	1 h	57	30
	F19d <sup>(16)</sup>	F19 with <ul style="list-style-type: none"> <li>• absorptive material in cavity</li> <li>• steel furring channels spaced 600 mm o.c.</li> <li>• 15.9 mm Type X gypsum board</li> </ul>	1 h	59	30
	F19e <sup>(16)</sup>	F19 with <ul style="list-style-type: none"> <li>• no absorptive material in cavity</li> <li>• steel furring channels spaced 400 mm o.c.</li> <li>• 12.7 mm Type X gypsum board</li> </ul>	1 h	53	26
	F19f <sup>(16)</sup>	F19 with <ul style="list-style-type: none"> <li>• no absorptive material in cavity</li> <li>• steel furring channels spaced 600 mm o.c.</li> <li>• 12.7 mm Type X gypsum board</li> </ul>	1 h	55	26
	F19g <sup>(16)</sup>	F19 with <ul style="list-style-type: none"> <li>• absorptive material in cavity</li> <li>• steel furring channels spaced 400 mm o.c.</li> <li>• 12.7 mm Type X gypsum board</li> </ul>	1 h	56	29
	F19h <sup>(16)</sup>	F19 with <ul style="list-style-type: none"> <li>• absorptive material in cavity</li> <li>• steel furring channels spaced 600 mm o.c.</li> <li>• 12.7 mm Type X gypsum board</li> </ul>	1 h	58	29
	F19i	F19 with <ul style="list-style-type: none"> <li>• no absorptive material in cavity</li> <li>• steel furring channels spaced 400 mm o.c.</li> <li>• 12.7 mm regular gypsum board</li> </ul>	-	53	26
	F19j	F19 with <ul style="list-style-type: none"> <li>• no absorptive material in cavity</li> <li>• steel furring channels spaced 600 mm o.c.</li> <li>• 12.7 mm regular gypsum board</li> </ul>	-	55	26

# Fire and Sound Resistance Tables

Table 9.10.3.1.-B (Continued)

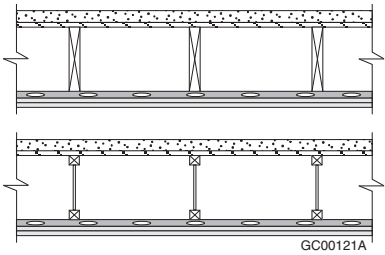
Type of Assembly	Assembly Number	Description <sup>(2)(3)(4)</sup>	Fire-Resistance Rating <sup>(5)(6)(7)(8)</sup>	Typical Sound Transmission Class <sup>(5)(6)(9)(10)</sup> (STC)	Typical Impact Insulation Class <sup>(5)(9)(11)</sup> (IIC)
	F19k	F19 with <ul style="list-style-type: none"> <li>absorptive material in cavity</li> <li>steel furring channels spaced 400 mm o.c.</li> <li>12.7 mm regular gypsum board</li> </ul>	-	56	29
	F19l	F19 with <ul style="list-style-type: none"> <li>absorptive material in cavity</li> <li>steel furring channels spaced 600 mm o.c.</li> <li>12.7 mm regular gypsum board</li> </ul>	-	58	29
	F20 <sup>(13)</sup>	<ul style="list-style-type: none"> <li>38 mm concrete topping (at least 70 kg/m<sup>2</sup>)</li> <li>subfloor of 15.5 mm plywood, OSB or waferboard, or 17 mm tongue and groove lumber</li> <li>on wood joists or wood I-joists spaced not more than 600 mm o.c.</li> <li>with or without absorptive material in cavity</li> <li>resilient metal channels spaced 300, 400 or 600 mm o.c.</li> <li>1 layer of gypsum board on ceiling side</li> </ul>	 <p style="text-align: right; font-size: small;">GC00120A</p>		
	F20a	F20 with <ul style="list-style-type: none"> <li>no absorptive material in cavity</li> <li>resilient metal channels spaced 400 mm o.c.</li> <li>15.9 mm Type X gypsum board</li> </ul>	45 min <sup>(22)</sup>	56	31
	F20b	F20 with <ul style="list-style-type: none"> <li>no absorptive material in cavity</li> <li>resilient metal channels spaced 600 mm o.c.</li> <li>15.9 mm Type X gypsum board</li> </ul>	-	58	31
	F20c	F20 with <ul style="list-style-type: none"> <li>absorptive material in cavity</li> <li>resilient metal channels spaced 400 mm o.c.</li> <li>15.9 mm Type X gypsum board</li> </ul>	30 min [45 min] <sup>(17)(22)</sup>	63	39
	F20d	F20 with <ul style="list-style-type: none"> <li>absorptive material in cavity</li> <li>resilient metal channels spaced 600 mm o.c.</li> <li>15.9 mm Type X gypsum board</li> </ul>	-	65	39
	F20e	F20 with <ul style="list-style-type: none"> <li>wood joists spaced 400 mm o.c.</li> <li>absorptive material in cavity</li> <li>resilient metal channels spaced 400 mm o.c.</li> <li>15.9 mm Type X gypsum board</li> </ul>	1 h <sup>(19)</sup>	64 <sup>(19)</sup>	40
	F20f <sup>(20)</sup>	F20 with <ul style="list-style-type: none"> <li>wood I-joists spaced 400 mm o.c.</li> <li>absorptive material in cavity</li> <li>resilient metal channels spaced 300 mm o.c.</li> <li>15.9 mm Type X gypsum board</li> </ul>	1 h <sup>(19)</sup>	65 <sup>(19)</sup>	40
	F20g	F20 with <ul style="list-style-type: none"> <li>no absorptive material in cavity</li> <li>resilient metal channels spaced 400 mm o.c.</li> <li>12.7 mm Type X gypsum board</li> </ul>	-	55	30
	F20h	F20 with <ul style="list-style-type: none"> <li>no absorptive material in cavity</li> <li>resilient metal channels spaced 600 mm o.c.</li> <li>12.7 mm Type X gypsum board</li> </ul>	-	57	30
	F20i	F20 with <ul style="list-style-type: none"> <li>absorptive material in cavity</li> <li>resilient metal channels spaced 400 mm o.c.</li> <li>12.7 mm Type X gypsum board</li> </ul>	-	62	38

Copyright © NRC 1941 - 2021 World Rights Reserved © CNRC 1941-2021 Droits réservés pour tous pays



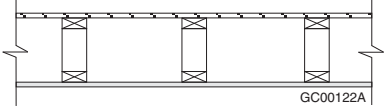
# Fire and Sound Resistance Tables

**Table 9.10.3.1.-B (Continued)**

Type of Assembly	Assembly Number	Description <sup>(2)(3)(4)</sup>	Fire-Resistance Rating <sup>(5)(6)(7)(8)</sup>	Typical Sound Transmission Class <sup>(5)(6)(9)(10)</sup> (STC)	Typical Impact Insulation Class <sup>(5)(9)(11)</sup> (IIC)
	F20j	F20 with <ul style="list-style-type: none"> <li>• absorptive material in cavity</li> <li>• resilient metal channels spaced 600 mm o.c.</li> <li>• 12.7 mm Type X gypsum board</li> </ul>	-	64	38
	F20k	F20 with <ul style="list-style-type: none"> <li>• no absorptive material in cavity</li> <li>• resilient metal channels spaced 400 mm o.c.</li> <li>• 12.7 mm regular gypsum board</li> </ul>	-	54	30
	F20l	F20 with <ul style="list-style-type: none"> <li>• no absorptive material in cavity</li> <li>• resilient metal channels spaced 600 mm o.c.</li> <li>• 12.7 mm regular gypsum board</li> </ul>	-	56	30
	F20m	F20 with <ul style="list-style-type: none"> <li>• absorptive material in cavity</li> <li>• resilient metal channels spaced 400 mm o.c.</li> <li>• 12.7 mm regular gypsum board</li> </ul>	-	61	38
	F20n	F20 with <ul style="list-style-type: none"> <li>• absorptive material in cavity</li> <li>• resilient metal channels spaced 600 mm o.c.</li> <li>• 12.7 mm regular gypsum board</li> </ul>	-	63	38
	<b>F21<sup>(13)</sup></b>	<ul style="list-style-type: none"> <li>• 38 mm concrete topping (at least 70 kg/m<sup>2</sup>)</li> <li>• subfloor of 15.5 mm plywood, OSB or waferboard, or 17 mm tongue and groove lumber</li> <li>• on wood joists or wood I-joists spaced not more than 600 mm o.c.</li> <li>• with or without absorptive material in cavity</li> <li>• resilient metal channels spaced 400 mm or 600 mm o.c.</li> <li>• 2 layers of gypsum board on ceiling side</li> </ul>	 <p style="text-align: right; font-size: small;">GC00121A</p>		
	F21a <sup>(16)</sup>	F21 with <ul style="list-style-type: none"> <li>• no absorptive material in cavity</li> <li>• resilient metal channels spaced 400 mm o.c.</li> <li>• 15.9 mm Type X gypsum board</li> </ul>	1 h	60	33
	F21b <sup>(16)</sup>	F21 with <ul style="list-style-type: none"> <li>• no absorptive material in cavity</li> <li>• resilient metal channels spaced 600 mm o.c.</li> <li>• 15.9 mm Type X gypsum board</li> </ul>	1 h	62	33
	F21c <sup>(16)</sup>	F21 with <ul style="list-style-type: none"> <li>• absorptive material in cavity</li> <li>• resilient metal channels spaced 400 mm o.c.</li> <li>• 15.9 mm Type X gypsum board</li> </ul>	1 h [1.5 h] <sup>(18)</sup>	67 [68] <sup>(18)</sup>	41 [42] <sup>(18)</sup>
	F21d <sup>(16)</sup>	F21 with <ul style="list-style-type: none"> <li>• absorptive material in cavity</li> <li>• resilient metal channels spaced 400 mm o.c.</li> <li>• 15.9 mm Type X gypsum board</li> </ul>	1 h [1.5 h] <sup>(18)</sup>	69 [70] <sup>(18)</sup>	41 [42] <sup>(18)</sup>
	F21e <sup>(16)</sup>	F21 with <ul style="list-style-type: none"> <li>• wood joists spaced 400 mm o.c.</li> <li>• absorptive material in cavity</li> <li>• resilient metal channels spaced 400 mm o.c.</li> <li>• 15.9 mm Type X gypsum board</li> </ul>	[1.5 h] <sup>(21)</sup>	68 <sup>(21)</sup>	42
	F21f <sup>(20)</sup>	F21 with <ul style="list-style-type: none"> <li>• wood I-joists spaced 400 mm o.c.</li> <li>• absorptive material in cavity</li> <li>• resilient metal channels spaced 300 mm o.c.</li> <li>• 15.9 mm Type X gypsum board</li> </ul>	[1.5 h] <sup>(21)</sup>	68 <sup>(21)</sup>	42

# Fire and Sound Resistance Tables

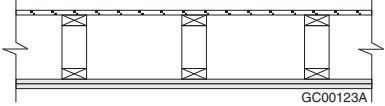
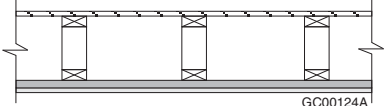
Table 9.10.3.1.-B (Continued)

Type of Assembly	Assembly Number	Description <sup>(2)(3)(4)</sup>	Fire-Resistance Rating <sup>(5)(6)(7)(8)</sup>	Typical Sound Transmission Class <sup>(5)(6)(9)(10)</sup> (STC)	Typical Impact Insulation Class <sup>(5)(9)(11)</sup> (IIC)
	F21g <sup>(16)</sup>	F21 with <ul style="list-style-type: none"> <li>no absorptive material in cavity</li> <li>resilient metal channels spaced 400 mm o.c.</li> <li>12.7 mm Type X gypsum board</li> </ul>	1 h	59	32
	F21h <sup>(16)</sup>	F21 with <ul style="list-style-type: none"> <li>no absorptive material in cavity</li> <li>resilient metal channels spaced 600 mm o.c.</li> <li>12.7 mm Type X gypsum board</li> </ul>	1 h	61	32
	F21i <sup>(16)</sup>	F21 with <ul style="list-style-type: none"> <li>absorptive material in cavity</li> <li>resilient metal channels spaced 400 mm o.c.</li> <li>12.7 mm Type X gypsum board</li> </ul>	1 h [1.5 h] <sup>(18)</sup>	66 [67] <sup>(18)</sup>	40
	F21j <sup>(16)</sup>	F21 with <ul style="list-style-type: none"> <li>absorptive material in cavity</li> <li>resilient metal channels spaced 600 mm o.c.</li> <li>12.7 mm Type X gypsum board</li> </ul>	1 h	68	40
	F21k	F21 with <ul style="list-style-type: none"> <li>no absorptive material in cavity</li> <li>resilient metal channels spaced 400 mm o.c.</li> <li>12.7 mm regular gypsum board</li> </ul>	-	59	32
	F21l	F21 with <ul style="list-style-type: none"> <li>no absorptive material in cavity</li> <li>resilient metal channels spaced 600 mm o.c.</li> <li>12.7 mm regular gypsum board</li> </ul>	-	61	32
	F21m	F21 with <ul style="list-style-type: none"> <li>absorptive material in cavity</li> <li>resilient metal channels spaced 400 mm o.c.</li> <li>12.7 mm regular gypsum board</li> </ul>	-	66	40
	F21n	F21 with <ul style="list-style-type: none"> <li>absorptive material in cavity</li> <li>resilient metal channels spaced 600 mm o.c.</li> <li>12.7 mm regular gypsum board</li> </ul>	-	68	40
Wood Floor Trusses <sup>(23)</sup>	<b>F22</b>	<ul style="list-style-type: none"> <li>subfloor of 15.5 mm plywood, OSB or waferboard, or 17 mm tongue and groove lumber</li> <li>on wood trusses spaced not more than 600 mm o.c.</li> <li>with or without absorptive material in cavity</li> <li>1 layer gypsum board on ceiling side</li> </ul>			
	F22a	F22 with <ul style="list-style-type: none"> <li>no absorptive material in cavity</li> <li>15.9 mm Type X gypsum board</li> </ul>	-	29	27
	F22b	F22 with <ul style="list-style-type: none"> <li>absorptive material in cavity</li> <li>15.9 mm Type X gypsum board</li> </ul>	-	31	30
	F22c	F22 with <ul style="list-style-type: none"> <li>no absorptive material in cavity</li> <li>12.7 mm Type X gypsum board</li> </ul>	-	28	26
	F22d	F22 with <ul style="list-style-type: none"> <li>absorptive material in cavity</li> <li>12.7 mm Type X gypsum board</li> </ul>	-	30	29
	F22e	F22 with <ul style="list-style-type: none"> <li>no absorptive material in cavity</li> <li>12.7 mm regular gypsum board</li> </ul>	-	27	25
	F22f	F22 with <ul style="list-style-type: none"> <li>absorptive material in cavity</li> <li>12.7 mm regular gypsum board</li> </ul>	-	31	28

Copyright © NRC 1941 - 2021 World Rights Reserved © CNRC 1941-2021 Droits réservés pour tous pays

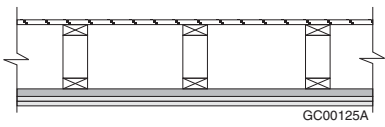
# Fire and Sound Resistance Tables

**Table 9.10.3.1.-B (Continued)**

Type of Assembly	Assembly Number	Description <sup>(2)(3)(4)</sup>	Fire-Resistance Rating <sup>(5)(6)(7)(8)</sup>	Typical Sound Transmission Class <sup>(5)(6)(9)(10)</sup> (STC)	Typical Impact Insulation Class <sup>(5)(9)(11)</sup> (IIC)
	<b>F23</b>	<ul style="list-style-type: none"> <li>• subfloor of 15.5 mm plywood, OSB or waferboard, or 17 mm tongue and groove lumber</li> <li>• on wood trusses spaced not more than 600 mm o.c.</li> <li>• with or without absorptive material in cavity</li> <li>• 2 layers of gypsum board on ceiling side</li> </ul>			
	F23a	<ul style="list-style-type: none"> <li>• F23 with</li> <li>• wood trusses spaced 400 mm o.c.</li> <li>• no absorptive material in cavity</li> <li>• 15.9 mm Type X gypsum board</li> </ul>	1 h	34	31
	F23b	<ul style="list-style-type: none"> <li>• F23 with</li> <li>• wood trusses spaced 600 mm o.c.</li> <li>• no absorptive material in cavity</li> <li>• 15.9 mm Type X gypsum board</li> </ul>	1 h	35	31
	F23c	<ul style="list-style-type: none"> <li>• F23 with</li> <li>• wood trusses spaced 400 mm o.c.</li> <li>• absorptive material in cavity</li> <li>• 15.9 mm Type X gypsum board</li> </ul>	45 min [1 h] <sup>(14)</sup>	36	34
	F23d	<ul style="list-style-type: none"> <li>• F23 with</li> <li>• wood trusses spaced 600 mm o.c.</li> <li>• absorptive material in cavity</li> <li>• 15.9 mm Type X gypsum board</li> </ul>	45 min	37	34
	F23e	<ul style="list-style-type: none"> <li>• F23 with</li> <li>• wood trusses spaced 400 mm o.c.</li> <li>• no absorptive material in cavity</li> <li>• 12.7 mm Type X gypsum board</li> </ul>	1 h	32	30
	F23f	<ul style="list-style-type: none"> <li>• F23 with</li> <li>• wood trusses spaced 600 mm o.c.</li> <li>• no absorptive material in cavity</li> <li>• 12.7 mm Type X gypsum board</li> </ul>	45 min	33	30
	F23g	<ul style="list-style-type: none"> <li>• F23 with</li> <li>• absorptive material in cavity</li> <li>• 12.7 mm Type X gypsum board</li> </ul>	-	34	33
	F23h	<ul style="list-style-type: none"> <li>• F23 with</li> <li>• no absorptive material in cavity</li> <li>• 12.7 mm regular gypsum board</li> </ul>	-	32	30
	F23i	<ul style="list-style-type: none"> <li>• F23 with</li> <li>• absorptive material in cavity</li> <li>• 12.7 mm regular gypsum board</li> </ul>	-	34	33
	<b>F24</b>	<ul style="list-style-type: none"> <li>• subfloor of 15.5 mm plywood, OSB or waferboard, or 17 mm tongue and groove lumber</li> <li>• on wood trusses spaced not more than 600 mm o.c.</li> <li>• with or without absorptive material in cavity</li> <li>• steel furring channels spaced 400 mm or 600 mm o.c.</li> <li>• 1 layer of gypsum board on ceiling side</li> </ul>			
	F24a	<ul style="list-style-type: none"> <li>• F24 with</li> <li>• no absorptive material in cavity</li> <li>• steel furring channels spaced 400 mm o.c.</li> <li>• 15.9 mm Type X gypsum board</li> </ul>	-	35	27
	F24b	<ul style="list-style-type: none"> <li>• F24 with</li> <li>• no absorptive material in cavity</li> <li>• steel furring channels spaced 600 mm o.c.</li> <li>• 15.9 mm Type X gypsum board</li> </ul>	-	37	30

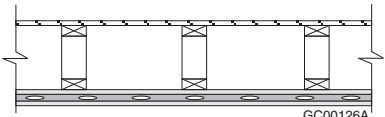
# Fire and Sound Resistance Tables

Table 9.10.3.1.-B (Continued)

Type of Assembly	Assembly Number	Description <sup>(2)(3)(4)</sup>	Fire-Resistance Rating <sup>(5)(6)(7)(8)</sup>	Typical Sound Transmission Class <sup>(5)(6)(9)(10)</sup> (STC)	Typical Impact Insulation Class <sup>(5)(9)(11)</sup> (IIC)
	F24c	F24 with <ul style="list-style-type: none"> <li>• absorptive material in cavity</li> <li>• steel furring channels spaced 400 mm o.c.</li> <li>• 15.9 mm Type X gypsum board</li> </ul>	-	38	30
	F24d	F24 with <ul style="list-style-type: none"> <li>• absorptive material in cavity</li> <li>• steel furring channels spaced 600 mm o.c.</li> <li>• 15.9 mm Type X gypsum board</li> </ul>	-	40	33
	F24e	F24 with <ul style="list-style-type: none"> <li>• no absorptive material in cavity</li> <li>• steel furring channels spaced 400 mm o.c.</li> <li>• 12.7 mm Type X gypsum board</li> </ul>	-	33	26
	F24f	F24 with <ul style="list-style-type: none"> <li>• no absorptive material in cavity</li> <li>• steel furring channels spaced 600 mm o.c.</li> <li>• 12.7 mm Type X gypsum board</li> </ul>	-	36	29
	F24g	F24 with <ul style="list-style-type: none"> <li>• absorptive material in cavity</li> <li>• steel furring channels spaced 400 mm o.c.</li> <li>• 12.7 mm Type X gypsum board</li> </ul>	-	37	29
	F24h	F24 with <ul style="list-style-type: none"> <li>• absorptive material in cavity</li> <li>• steel furring channels spaced 600 mm o.c.</li> <li>• 12.7 mm Type X gypsum board</li> </ul>	-	39	32
	F24i	F24 with <ul style="list-style-type: none"> <li>• no absorptive material in cavity</li> <li>• steel furring channels spaced 400 mm o.c.</li> <li>• 12.7 mm regular gypsum board</li> </ul>	-	33	25
	F24j	F24 with <ul style="list-style-type: none"> <li>• no absorptive material in cavity</li> <li>• steel furring channels spaced 600 mm o.c.</li> <li>• 12.7 mm regular gypsum board</li> </ul>	-	35	28
	F24k	F24 with <ul style="list-style-type: none"> <li>• absorptive material in cavity</li> <li>• steel furring channels spaced 400 mm o.c.</li> <li>• 12.7 mm regular gypsum board</li> </ul>	-	36	28
	F24l	F24 with <ul style="list-style-type: none"> <li>• absorptive material in cavity</li> <li>• steel furring channels spaced 600 mm o.c.</li> <li>• 12.7 mm regular gypsum board</li> </ul>	-	38	31
	F25	<ul style="list-style-type: none"> <li>• subfloor of 15.5 mm plywood, OSB or waferboard, or 17 mm tongue and groove lumber</li> <li>• on wood trusses spaced not more than 600 mm o.c.</li> <li>• with or without absorptive material in cavity</li> <li>• steel furring channels spaced 400 mm or 600 mm o.c.</li> <li>• 2 layers of gypsum board on ceiling side</li> </ul>			
	F25a	F25 with <ul style="list-style-type: none"> <li>• no absorptive material in cavity</li> <li>• steel furring channels spaced 400 mm o.c.</li> <li>• 15.9 mm Type X gypsum board</li> </ul>	1 h	40	32
	F25b	F25 with <ul style="list-style-type: none"> <li>• no absorptive material in cavity</li> <li>• steel furring channels spaced 600 mm o.c.</li> <li>• 15.9 mm Type X gypsum board</li> </ul>	1 h	42	34

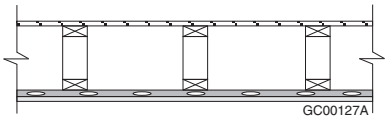
# Fire and Sound Resistance Tables

**Table 9.10.3.1.-B (Continued)**

Type of Assembly	Assembly Number	Description <sup>(2)(3)(4)</sup>	Fire-Resistance Rating <sup>(5)(6)(7)(8)</sup>	Typical Sound Transmission Class <sup>(5)(6)(9)(10)</sup> (STC)	Typical Impact Insulation Class <sup>(5)(9)(11)</sup> (IIC)
	F25c	F25 with <ul style="list-style-type: none"> <li>• absorptive material in cavity</li> <li>• steel furring channels spaced 400 mm o.c.</li> <li>• 15.9 mm Type X gypsum board</li> </ul>	1 h	43	35
	F25d	F25 with <ul style="list-style-type: none"> <li>• absorptive material in cavity</li> <li>• steel furring channels spaced 600 mm o.c.</li> <li>• 15.9 mm Type X gypsum board</li> </ul>	45 min [1 h] <sup>(17)</sup>	45	37
	F25e	F25 with <ul style="list-style-type: none"> <li>• no absorptive material in cavity</li> <li>• steel furring channels spaced 400 mm o.c.</li> <li>• 12.7 mm Type X gypsum board</li> </ul>	1 h	38	30
	F25f	F25 with <ul style="list-style-type: none"> <li>• no absorptive material in cavity</li> <li>• steel furring channels spaced 600 mm o.c.</li> <li>• 12.7 mm Type X gypsum board</li> </ul>	1 h	40	33
	F25g	F25 with <ul style="list-style-type: none"> <li>• absorptive material in cavity</li> <li>• steel furring channels spaced 400 mm o.c.</li> <li>• 12.7 mm Type X gypsum board</li> </ul>	1 h	41	33
	F25h	F25 with <ul style="list-style-type: none"> <li>• absorptive material in cavity</li> <li>• steel furring channels spaced 600 mm o.c.</li> <li>• 12.7 mm Type X gypsum board</li> </ul>	45 min [1 h] <sup>(17)</sup>	43	36
	F25i	F25 with <ul style="list-style-type: none"> <li>• no absorptive material in cavity</li> <li>• steel furring channels spaced 400 mm o.c.</li> <li>• 12.7 mm regular gypsum board</li> </ul>	-	38	30
	F25j	F25 with <ul style="list-style-type: none"> <li>• no absorptive material in cavity</li> <li>• steel furring channels spaced 600 mm o.c.</li> <li>• 12.7 mm regular gypsum board</li> </ul>	-	40	33
	F25k	F25 with <ul style="list-style-type: none"> <li>• absorptive material in cavity</li> <li>• steel furring channels spaced 400 mm o.c.</li> <li>• 12.7 mm regular gypsum board</li> </ul>	-	41	33
	F25l	F25 with <ul style="list-style-type: none"> <li>• absorptive material in cavity</li> <li>• steel furring channels spaced 600 mm o.c.</li> <li>• 12.7 mm regular gypsum board</li> </ul>	-	43	36
	<b>F26</b>	<ul style="list-style-type: none"> <li>• subfloor of 15.5 mm plywood, OSB or waferboard, or 17 mm tongue and groove lumber</li> <li>• on wood trusses spaced not more than 600 mm o.c.</li> <li>• with or without absorptive material in cavity</li> <li>• 1 layer of gypsum board attached directly to trusses on ceiling side</li> <li>• resilient metal channels spaced 400 mm or 600 mm o.c. attached to trusses through the gypsum board</li> <li>• 1 layer of gypsum board attached to resilient metal channels</li> </ul>	 <p style="text-align: right; font-size: small;">GC00126A</p>		
	F26a	F26 with <ul style="list-style-type: none"> <li>• no absorptive material in cavity</li> <li>• 15.9 mm Type X gypsum board</li> <li>• resilient metal channels</li> <li>• 15.9 mm Type X gypsum board</li> </ul>	-	35	27

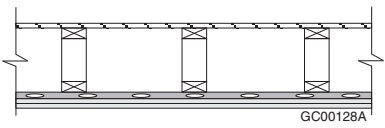
# Fire and Sound Resistance Tables

Table 9.10.3.1.-B (Continued)

Type of Assembly	Assembly Number	Description <sup>(2)(3)(4)</sup>	Fire-Resistance Rating <sup>(5)(6)(7)(8)</sup>	Typical Sound Transmission Class <sup>(5)(6)(9)(10)</sup> (STC)	Typical Impact Insulation Class <sup>(5)(9)(11)</sup> (IIC)
	F26b	F26 with <ul style="list-style-type: none"> <li>• absorptive material in cavity</li> <li>• 15.9 mm Type X gypsum board</li> <li>• resilient metal channels</li> <li>• 15.9 mm Type X gypsum board</li> </ul>	-	37	30
	F26c	F26 with <ul style="list-style-type: none"> <li>• no absorptive material in cavity</li> <li>• 12.7 mm Type X gypsum board</li> <li>• resilient metal channels</li> <li>• 12.7 mm Type X gypsum board</li> </ul>	-	35	27
	F26d	F26 with <ul style="list-style-type: none"> <li>• absorptive material in cavity</li> <li>• 12.7 mm Type X gypsum board</li> <li>• resilient metal channels</li> <li>• 12.7 mm Type X gypsum board</li> </ul>	-	37	30
	F26e	F26 with <ul style="list-style-type: none"> <li>• no absorptive material in cavity</li> <li>• 12.7 mm regular gypsum board</li> <li>• resilient metal channels</li> <li>• 12.7 mm regular gypsum board</li> </ul>	-	32	26
	F26f	F26 with <ul style="list-style-type: none"> <li>• absorptive material in cavity</li> <li>• 12.7 mm regular gypsum board</li> <li>• resilient metal channels</li> <li>• 12.7 mm regular gypsum board</li> </ul>	-	35	28
	<b>F27</b>	<ul style="list-style-type: none"> <li>• subfloor of 15.5 mm plywood, OSB or waferboard, or 17 mm tongue and groove lumber</li> <li>• on wood trusses spaced not more than 600 mm o.c.</li> <li>• with or without absorptive material in cavity</li> <li>• resilient metal channels spaced 400 mm or 600 mm o.c.</li> <li>• 1 layer of gypsum board on ceiling side</li> </ul>	 <p style="text-align: right; font-size: small;">GC00127A</p>		
	F27a	F27 with <ul style="list-style-type: none"> <li>• no absorptive material in cavity</li> <li>• resilient metal channels spaced 400 mm o.c.</li> <li>• 15.9 mm Type X gypsum board</li> </ul>	-	41	33
	F27b	F27 with <ul style="list-style-type: none"> <li>• no absorptive material in cavity</li> <li>• resilient metal channels spaced 600 mm o.c.</li> <li>• 15.9 mm Type X gypsum board</li> </ul>	-	43	36
	F27c	F27 with <ul style="list-style-type: none"> <li>• absorptive material in cavity</li> <li>• resilient metal channels spaced 400 mm o.c.</li> <li>• 15.9 mm Type X gypsum board</li> </ul>	30 min [45 min] <sup>(24)</sup>	48	41
	F27d	F27 with <ul style="list-style-type: none"> <li>• absorptive material in cavity</li> <li>• resilient metal channels spaced 600 mm o.c.</li> <li>• 15.9 mm Type X gypsum board</li> </ul>	-	50	44
	F27e	F27 with <ul style="list-style-type: none"> <li>• no absorptive material in cavity</li> <li>• resilient metal channels spaced 400 mm o.c.</li> <li>• 12.7 mm Type X gypsum board</li> </ul>	-	40	32
	F27f	F27 with <ul style="list-style-type: none"> <li>• no absorptive material in cavity</li> <li>• resilient metal channels spaced 600 mm o.c.</li> <li>• 12.7 mm Type X gypsum board</li> </ul>	-	42	35

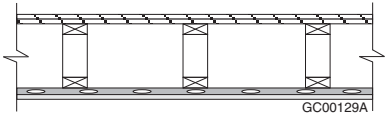
# Fire and Sound Resistance Tables

**Table 9.10.3.1.-B (Continued)**

Type of Assembly	Assembly Number	Description <sup>(2)(3)(4)</sup>	Fire-Resistance Rating <sup>(5)(6)(7)(8)</sup>	Typical Sound Transmission Class <sup>(5)(6)(9)(10)</sup> (STC)	Typical Impact Insulation Class <sup>(5)(9)(11)</sup> (IIC)
	F27g	F27 with <ul style="list-style-type: none"> <li>• absorptive material in cavity</li> <li>• resilient metal channels spaced 400 mm o.c.</li> <li>• 12.7 mm Type X gypsum board</li> </ul>	-	47	40
	F27h	F27 with <ul style="list-style-type: none"> <li>• absorptive material in cavity</li> <li>• resilient metal channels spaced 600 mm o.c.</li> <li>• 12.7 mm Type X gypsum board</li> </ul>	-	49	43
	F27i	F27 with <ul style="list-style-type: none"> <li>• no absorptive material in cavity</li> <li>• resilient metal channels spaced 400 mm o.c.</li> <li>• 12.7 mm regular gypsum board</li> </ul>	-	39	31
	F27j	F27 with <ul style="list-style-type: none"> <li>• no absorptive material in cavity</li> <li>• resilient metal channels spaced 600 mm o.c.</li> <li>• 12.7 mm regular gypsum board</li> </ul>	-	41	34
	F27k	F27 with <ul style="list-style-type: none"> <li>• absorptive material in cavity</li> <li>• resilient metal channels spaced 400 mm o.c.</li> <li>• 12.7 mm regular gypsum board</li> </ul>	-	46	39
	F27l	F27 with <ul style="list-style-type: none"> <li>• absorptive material in cavity</li> <li>• resilient metal channels spaced 600 mm o.c.</li> <li>• 12.7 mm regular gypsum board</li> </ul>	-	48	42
	<b>F28</b>	<ul style="list-style-type: none"> <li>• subfloor of 15.5 mm plywood, OSB or waferboard, or 17 mm tongue and groove lumber</li> <li>• on wood trusses spaced not more than 600 mm o.c.</li> <li>• with or without absorptive material in cavity</li> <li>• resilient metal channels spaced 400 mm or 600 mm o.c.</li> <li>• 2 layers of gypsum board on ceiling side</li> </ul>			
	F28a	F28 with <ul style="list-style-type: none"> <li>• no absorptive material in cavity</li> <li>• resilient metal channels spaced 400 mm o.c.</li> <li>• 15.9 mm Type X gypsum board</li> </ul>	1 h	46	38
	F28b	F28 with <ul style="list-style-type: none"> <li>• no absorptive material in cavity</li> <li>• resilient metal channels spaced 600 mm o.c.</li> <li>• 15.9 mm Type X gypsum board</li> </ul>	1 h	48	40
	F28c	F28 with <ul style="list-style-type: none"> <li>• absorptive material in cavity</li> <li>• resilient metal channels spaced 400 mm o.c.</li> <li>• 15.9 mm Type X gypsum board</li> </ul>	1 h	54	46
	F28d	F28 with <ul style="list-style-type: none"> <li>• absorptive material in cavity</li> <li>• resilient metal channels spaced 600 mm o.c.</li> <li>• 15.9 mm Type X gypsum board</li> </ul>	45 min [1 h] <sup>(17)</sup>	55	48
	F28e	F28 with <ul style="list-style-type: none"> <li>• no absorptive material in cavity</li> <li>• resilient metal channels spaced 400 mm o.c.</li> <li>• 12.7 mm Type X gypsum board</li> </ul>	1 h	44	36
	F28f	F28 with <ul style="list-style-type: none"> <li>• no absorptive material in cavity</li> <li>• resilient metal channels spaced 600 mm o.c.</li> <li>• 12.7 mm Type X gypsum board</li> </ul>	1 h	46	39

# Fire and Sound Resistance Tables

Table 9.10.3.1.-B (Continued)

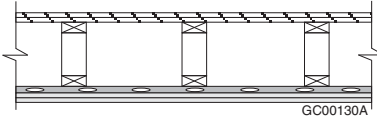
Type of Assembly	Assembly Number	Description <sup>(2)(3)(4)</sup>	Fire-Resistance Rating <sup>(5)(6)(7)(8)</sup>	Typical Sound Transmission Class <sup>(5)(6)(9)(10)</sup> (STC)	Typical Impact Insulation Class <sup>(5)(9)(11)</sup> (IIC)
	F28g	F28 with <ul style="list-style-type: none"> <li>• absorptive material in cavity</li> <li>• resilient metal channels spaced 400 mm o.c.</li> <li>• 12.7 mm Type X gypsum board</li> </ul>	1 h	51	44
	F28h	F28 with <ul style="list-style-type: none"> <li>• absorptive material in cavity</li> <li>• resilient metal channels spaced 600 mm o.c.</li> <li>• 12.7 mm Type X gypsum board</li> </ul>	45 min [1 h] <sup>(17)</sup>	53	47
	F28i	F28 with <ul style="list-style-type: none"> <li>• no absorptive material in cavity</li> <li>• resilient metal channels spaced 400 mm o.c.</li> <li>• 12.7 mm regular gypsum board</li> </ul>	-	44	36
	F28j	F28 with <ul style="list-style-type: none"> <li>• no absorptive material in cavity</li> <li>• resilient metal channels spaced 600 mm o.c.</li> <li>• 12.7 mm regular gypsum board</li> </ul>	-	46	39
	F28k	F28 with <ul style="list-style-type: none"> <li>• absorptive material in cavity</li> <li>• resilient metal channels spaced 400 mm o.c.</li> <li>• 12.7 mm regular gypsum board</li> </ul>	-	51	44
	F28l	F28 with <ul style="list-style-type: none"> <li>• absorptive material in cavity</li> <li>• resilient metal channels spaced 600 mm o.c.</li> <li>• 12.7 mm regular gypsum board</li> </ul>	-	53	47
	<b>F29</b>	<ul style="list-style-type: none"> <li>• one subfloor layer 11 mm sanded plywood, or OSB or waferboard</li> <li>• one subfloor layer of 15.5 mm plywood, OSB or waferboard, or 17 mm tongue and groove lumber</li> <li>• on wood trusses spaced not more than 600 mm o.c.</li> <li>• with or without absorptive material in cavity</li> <li>• resilient metal channels spaced 400 mm or 600 mm o.c.</li> <li>• 1 layer of gypsum board on ceiling side</li> </ul>			
	F29a	F29 with <ul style="list-style-type: none"> <li>• no absorptive material in cavity</li> <li>• resilient metal channels spaced 400 mm o.c.</li> <li>• 15.9 mm Type X gypsum board</li> </ul>	-	44	35
	F29b	F29 with <ul style="list-style-type: none"> <li>• no absorptive material in cavity</li> <li>• resilient metal channels spaced 600 mm o.c.</li> <li>• 15.9 mm Type X gypsum board</li> </ul>	-	46	37
	F29c	F29 with <ul style="list-style-type: none"> <li>• absorptive material in cavity</li> <li>• resilient metal channels spaced 400 mm o.c.</li> <li>• 15.9 mm Type X gypsum board</li> </ul>	30 min [45 min] <sup>(24)</sup>	51	43
	F29d	F29 with <ul style="list-style-type: none"> <li>• absorptive material in cavity</li> <li>• resilient metal channels spaced 600 mm o.c.</li> <li>• 15.9 mm Type X gypsum board</li> </ul>	-	53	45
	F29e	F29 with <ul style="list-style-type: none"> <li>• no absorptive material in cavity</li> <li>• resilient metal channels spaced 400 mm o.c.</li> <li>• 12.7 mm Type X gypsum board</li> </ul>	-	43	33
	F29f	F29 with <ul style="list-style-type: none"> <li>• no absorptive material in cavity</li> <li>• resilient metal channels spaced 600 mm o.c.</li> <li>• 12.7 mm Type X gypsum board</li> </ul>	-	45	36

Copyright © NRC 1941 - 2021 World Rights Reserved © CNRC 1941-2021 Droits réservés pour tous pays



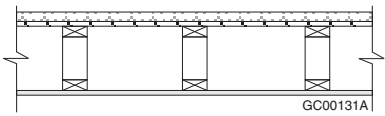
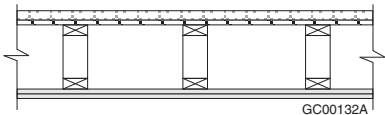
# Fire and Sound Resistance Tables

**Table 9.10.3.1.-B (Continued)**

Type of Assembly	Assembly Number	Description <sup>(2)(3)(4)</sup>	Fire-Resistance Rating <sup>(5)(6)(7)(8)</sup>	Typical Sound Transmission Class <sup>(5)(6)(9)(10)</sup> (STC)	Typical Impact Insulation Class <sup>(5)(9)(11)</sup> (IIC)
	F29g	F29 with <ul style="list-style-type: none"> <li>• absorptive material in cavity</li> <li>• resilient metal channels spaced 400 mm o.c.</li> <li>• 12.7 mm Type X gypsum board</li> </ul>	-	50	41
	F29h	F29 with <ul style="list-style-type: none"> <li>• absorptive material in cavity</li> <li>• resilient metal channels spaced 600 mm o.c.</li> <li>• 12.7 mm Type X gypsum board</li> </ul>	-	52	44
	F29i	F29 with <ul style="list-style-type: none"> <li>• no absorptive material in cavity</li> <li>• resilient metal channels spaced 400 mm o.c.</li> <li>• 12.7 mm regular gypsum board</li> </ul>	-	42	34
	F29j	F29 with <ul style="list-style-type: none"> <li>• no absorptive material in cavity</li> <li>• resilient metal channels spaced 600 mm o.c.</li> <li>• 12.7 mm regular gypsum board</li> </ul>	-	44	36
	F29k	F29 with <ul style="list-style-type: none"> <li>• absorptive material in cavity</li> <li>• resilient metal channels spaced 400 mm o.c.</li> <li>• 12.7 mm regular gypsum board</li> </ul>	-	49	41
	F29l	F29 with <ul style="list-style-type: none"> <li>• absorptive material in cavity</li> <li>• resilient metal channels spaced 600 mm o.c.</li> <li>• 12.7 mm regular gypsum board</li> </ul>	-	51	44
	<b>F30</b>	<ul style="list-style-type: none"> <li>• one subfloor layer 11 mm sanded plywood, or OSB or waferboard</li> <li>• one subfloor layer of 15.5 mm plywood, OSB or waferboard, or 17 mm tongue and groove lumber</li> <li>• on wood trusses spaced not more than 600 mm o.c.</li> <li>• with or without absorptive material in cavity</li> <li>• resilient metal channels spaced 400 mm or 600 mm o.c.</li> <li>• 2 layers of gypsum board on ceiling side</li> </ul>			
	F30a	F30 with <ul style="list-style-type: none"> <li>• no absorptive material in cavity</li> <li>• resilient metal channels spaced 400 mm o.c.</li> <li>• 15.9 mm Type X gypsum board</li> </ul>	1 h	49	39
	F30b	F30 with <ul style="list-style-type: none"> <li>• no absorptive material in cavity</li> <li>• resilient metal channels spaced 600 mm o.c.</li> <li>• 15.9 mm Type X gypsum board</li> </ul>	1 h	51	42
	F30c	F30 with <ul style="list-style-type: none"> <li>• absorptive material in cavity</li> <li>• resilient metal channels spaced 400 mm o.c.</li> <li>• 15.9 mm Type X gypsum board</li> </ul>	1 h [1.5 h] <sup>(25)</sup>	56 [58] <sup>(25)</sup>	47 [50] <sup>(25)</sup>
	F30d	F30 with <ul style="list-style-type: none"> <li>• absorptive material in cavity</li> <li>• resilient metal channels spaced 600 mm o.c.</li> <li>• 15.9 mm Type X gypsum board</li> </ul>	45 min [1 h] <sup>(17)</sup>	58	50
	F30e	F30 with <ul style="list-style-type: none"> <li>• no absorptive material in cavity</li> <li>• resilient metal channels spaced 400 mm o.c.</li> <li>• 12.7 mm Type X gypsum board</li> </ul>	1 h	47	38
	F30f	F30 with <ul style="list-style-type: none"> <li>• no absorptive material in cavity</li> <li>• resilient metal channels spaced 600 mm o.c.</li> <li>• 12.7 mm Type X gypsum board</li> </ul>	1 h	49	40

# Fire and Sound Resistance Tables

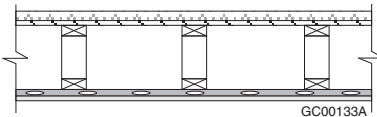
Table 9.10.3.1.-B (Continued)

Type of Assembly	Assembly Number	Description <sup>(2)(3)(4)</sup>	Fire-Resistance Rating <sup>(5)(6)(7)(8)</sup>	Typical Sound Transmission Class <sup>(5)(6)(9)(10)</sup> (STC)	Typical Impact Insulation Class <sup>(5)(9)(11)</sup> (IIC)
	F30g	F30 with <ul style="list-style-type: none"> <li>• absorptive material in cavity</li> <li>• resilient metal channels spaced 400 mm o.c.</li> <li>• 12.7 mm Type X gypsum board</li> </ul>	1 h	54	46
	F30h	F30 with <ul style="list-style-type: none"> <li>• absorptive material in cavity</li> <li>• resilient metal channels spaced 600 mm o.c.</li> <li>• 12.7 mm Type X gypsum board</li> </ul>	45 min [1 h] <sup>(17)</sup>	56	48
	F30i	F30 with <ul style="list-style-type: none"> <li>• no absorptive material in cavity</li> <li>• resilient metal channels spaced 400 mm o.c.</li> <li>• 12.7 mm regular gypsum board</li> </ul>	-	47	37
	F30j	F30 with <ul style="list-style-type: none"> <li>• no absorptive material in cavity</li> <li>• resilient metal channels spaced 600 mm o.c.</li> <li>• 12.7 mm regular gypsum board</li> </ul>	-	49	40
	F30k	F30 with <ul style="list-style-type: none"> <li>• absorptive material in cavity</li> <li>• resilient metal channels spaced 400 mm o.c.</li> <li>• 12.7 mm regular gypsum board</li> </ul>	-	54	45
	F30l	F30 with <ul style="list-style-type: none"> <li>• absorptive material in cavity</li> <li>• resilient metal channels spaced 600 mm o.c.</li> <li>• 12.7 mm regular gypsum board</li> </ul>	-	56	48
	<b>F31</b>	<ul style="list-style-type: none"> <li>• 25 mm gypsum-concrete topping (at least 44 kg/m<sup>2</sup>)</li> <li>• subfloor of 15.5 mm plywood, OSB or waferboard, or 17 mm tongue and groove lumber</li> <li>• on wood trusses spaced not more than 600 mm o.c.</li> <li>• with or without absorptive material in cavity</li> <li>• 1 layer of gypsum board on ceiling side</li> </ul>	 GC00131A		
	F31a	F31 with <ul style="list-style-type: none"> <li>• no absorptive material in cavity</li> <li>• 15.9 mm Type X gypsum board</li> </ul>	-	41	17
	F31b	F31 with <ul style="list-style-type: none"> <li>• absorptive material in cavity</li> <li>• 15.9 mm Type X gypsum board</li> </ul>	-	43	20
	F31c	F31 with <ul style="list-style-type: none"> <li>• no absorptive material in cavity</li> <li>• 12.7 mm Type X gypsum board</li> </ul>	-	40	17
	F31d	F31 with <ul style="list-style-type: none"> <li>• absorptive material in cavity</li> <li>• 12.7 mm Type X gypsum board</li> </ul>	-	42	20
	F31e	F31 with <ul style="list-style-type: none"> <li>• no absorptive material in cavity</li> <li>• 12.7 mm regular gypsum board</li> </ul>	-	39	16
	F31f	F31 with <ul style="list-style-type: none"> <li>• absorptive material in cavity</li> <li>• 12.7 mm regular gypsum board</li> </ul>	-	41	19
	<b>F32</b>	<ul style="list-style-type: none"> <li>• 25 mm gypsum-concrete topping (at least 44 kg/m<sup>2</sup>)</li> <li>• subfloor of 15.5 mm plywood, OSB or waferboard, or 17 mm tongue and groove lumber</li> <li>• on wood trusses spaced not more than 600 mm o.c.</li> <li>• with or without absorptive material in cavity</li> <li>• 2 layers of gypsum board on ceiling side</li> </ul>	 GC00132A		

Copyright © NRC 1941 - 2021 World Rights Reserved © CNRC 1941-2021 Droits réservés pour tous pays

# Fire and Sound Resistance Tables

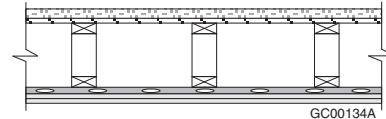
**Table 9.10.3.1.-B (Continued)**

Type of Assembly	Assembly Number	Description <sup>(2)(3)(4)</sup>	Fire-Resistance Rating <sup>(5)(6)(7)(8)</sup>	Typical Sound Transmission Class <sup>(5)(6)(9)(10)</sup> (STC)	Typical Impact Insulation Class <sup>(5)(9)(11)</sup> (IIC)
	F32a	F32 with <ul style="list-style-type: none"> <li>• wood trusses spaced 400 mm o.c.</li> <li>• no absorptive material in cavity</li> <li>• 15.9 mm Type X gypsum board</li> </ul>	1 h	46	20
	F32b	F32 with <ul style="list-style-type: none"> <li>• wood trusses spaced 600 mm o.c.</li> <li>• no absorptive material in cavity</li> <li>• 15.9 mm Type X gypsum board</li> </ul>	1 h	47	20
	F32c	F32 with <ul style="list-style-type: none"> <li>• wood trusses spaced 400 mm o.c.</li> <li>• absorptive material in cavity</li> <li>• 15.9 mm Type X gypsum board</li> </ul>	45 min [1 h] <sup>(14)</sup>	48	23
	F32d	F32 with <ul style="list-style-type: none"> <li>• wood trusses spaced 600 mm o.c.</li> <li>• absorptive material in cavity</li> <li>• 15.9 mm Type X gypsum board</li> </ul>	45 min	49	23
	F32e	F32 with <ul style="list-style-type: none"> <li>• wood trusses spaced 400 mm o.c.</li> <li>• no absorptive material in cavity</li> <li>• 12.7 mm Type X gypsum board</li> </ul>	1 h	44	19
	F32f	F32 with <ul style="list-style-type: none"> <li>• wood trusses spaced 600 mm o.c.</li> <li>• no absorptive material in cavity</li> <li>• 12.7 mm Type X gypsum board</li> </ul>	45 min	45	19
	F32g	F32 with <ul style="list-style-type: none"> <li>• absorptive material in cavity</li> <li>• 12.7 mm Type X gypsum board</li> </ul>	-	46	19
	F32h	F32 with <ul style="list-style-type: none"> <li>• no absorptive material in cavity</li> <li>• 12.7 mm regular gypsum board</li> </ul>	-	44	19
	F32i	F32 with <ul style="list-style-type: none"> <li>• absorptive material in cavity</li> <li>• 12.7 mm regular gypsum board</li> </ul>	-	46	22
	<b>F33</b>	<ul style="list-style-type: none"> <li>• 25 mm gypsum-concrete topping (at least 44 kg/m<sup>2</sup>)</li> <li>• subfloor of 15.5 mm plywood, OSB or waferboard, or 17 mm tongue and groove lumber</li> <li>• on wood trusses spaced not more than 600 mm o.c.</li> <li>• with or without absorptive material in cavity</li> <li>• resilient metal channels spaced 400 mm or 600 mm o.c.</li> <li>• 1 layer of gypsum board on ceiling side</li> </ul>	 <p style="text-align: right; font-size: small;">GC00133A</p>		
	F33a	F33 with <ul style="list-style-type: none"> <li>• no absorptive material in cavity</li> <li>• resilient metal channels spaced 400 mm o.c.</li> <li>• 15.9 mm Type X gypsum board</li> </ul>	-	53	26
	F33b	F33 with <ul style="list-style-type: none"> <li>• no absorptive material in cavity</li> <li>• resilient metal channels spaced 600 mm o.c.</li> <li>• 15.9 mm Type X gypsum board</li> </ul>	-	55	26
	F33c	F33 with <ul style="list-style-type: none"> <li>• absorptive material in cavity</li> <li>• resilient metal channels spaced 400 mm o.c.</li> <li>• 15.9 mm Type X gypsum board</li> </ul>	30 min [45 min] <sup>(24)</sup>	60	34

# Fire and Sound Resistance Tables

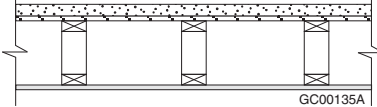
Table 9.10.3.1.-B (Continued)

Type of Assembly	Assembly Number	Description <sup>(2)(3)(4)</sup>	Fire-Resistance Rating <sup>(5)(6)(7)(8)</sup>	Typical Sound Transmission Class <sup>(5)(6)(9)(10)</sup> (STC)	Typical Impact Insulation Class <sup>(5)(9)(11)</sup> (IIC)
	F33d	F33 with <ul style="list-style-type: none"> <li>• absorptive material in cavity</li> <li>• resilient metal channels spaced 600 mm o.c.</li> <li>• 15.9 mm Type X gypsum board</li> </ul>	-	62	34
	F33e	F33 with <ul style="list-style-type: none"> <li>• no absorptive material in cavity</li> <li>• resilient metal channels spaced 400 mm o.c.</li> <li>• 12.7 mm Type X gypsum board</li> </ul>	-	52	26
	F33f	F33 with <ul style="list-style-type: none"> <li>• no absorptive material in cavity</li> <li>• resilient metal channels spaced 600 mm o.c.</li> <li>• 12.7 mm Type X gypsum board</li> </ul>	-	54	26
	F33g	F33 with <ul style="list-style-type: none"> <li>• absorptive material in cavity</li> <li>• resilient metal channels spaced 400 mm o.c.</li> <li>• 12.7 mm Type X gypsum board</li> </ul>	-	59	34
	F33h	F33 with <ul style="list-style-type: none"> <li>• absorptive material in cavity</li> <li>• resilient metal channels spaced 600 mm o.c.</li> <li>• 12.7 mm Type X gypsum board</li> </ul>	-	61	34
	F33i	F33 with <ul style="list-style-type: none"> <li>• no absorptive material in cavity</li> <li>• resilient metal channels spaced 400 mm o.c.</li> <li>• 12.7 mm regular gypsum board</li> </ul>	-	51	25
	F33j	F33 with <ul style="list-style-type: none"> <li>• no absorptive material in cavity</li> <li>• resilient metal channels spaced 600 mm o.c.</li> <li>• 12.7 mm regular gypsum board</li> </ul>	-	53	25
	F33k	F33 with <ul style="list-style-type: none"> <li>• absorptive material in cavity</li> <li>• resilient metal channels spaced 400 mm o.c.</li> <li>• 12.7 mm regular gypsum board</li> </ul>	-	58	33
	F33l	F33 with <ul style="list-style-type: none"> <li>• absorptive material in cavity</li> <li>• resilient metal channels spaced 600 mm o.c.</li> <li>• 12.7 mm regular gypsum board</li> </ul>	-	60	33
	<b>F34</b>	<ul style="list-style-type: none"> <li>• 25 mm gypsum-concrete topping (at least 44 kg/m<sup>2</sup>)</li> <li>• subfloor of 15.5 mm plywood, OSB or waferboard, or 17 mm tongue and groove lumber</li> <li>• on wood trusses spaced not more than 600 mm o.c.</li> <li>• with or without absorptive material in cavity</li> <li>• resilient metal channels spaced 400 mm or 600 mm o.c.</li> <li>• 2 layers of gypsum board on ceiling side</li> </ul>			
	F34a	F34 with <ul style="list-style-type: none"> <li>• no absorptive material in cavity</li> <li>• resilient metal channels spaced 400 mm o.c.</li> <li>• 15.9 mm Type X gypsum board</li> </ul>	1 h	57	29
	F34b	F34 with <ul style="list-style-type: none"> <li>• no absorptive material in cavity</li> <li>• resilient metal channels spaced 600 mm o.c.</li> <li>• 15.9 mm Type X gypsum board</li> </ul>	1 h	60	29
	F34c	F34 with <ul style="list-style-type: none"> <li>• absorptive material in cavity</li> <li>• resilient metal channels spaced 400 mm o.c.</li> <li>• 15.9 mm Type X gypsum board</li> </ul>	1 h [1.5 h] <sup>(25)</sup>	65 [67] <sup>(25)</sup>	37



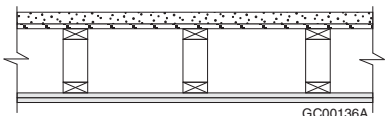
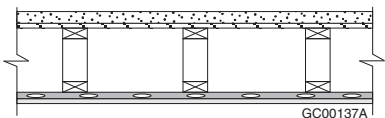
# Fire and Sound Resistance Tables

**Table 9.10.3.1.-B (Continued)**

Type of Assembly	Assembly Number	Description <sup>(2)(3)(4)</sup>	Fire-Resistance Rating <sup>(5)(6)(7)(8)</sup>	Typical Sound Transmission Class <sup>(5)(6)(9)(10)</sup> (STC)	Typical Impact Insulation Class <sup>(5)(9)(11)</sup> (IIC)
	F34d	F34 with <ul style="list-style-type: none"> <li>• absorptive material in cavity</li> <li>• resilient metal channels spaced 600 mm o.c.</li> <li>• 15.9 mm Type X gypsum board</li> </ul>	45 min [1 h] <sup>(17)</sup>	67	37
	F34e	F34 with <ul style="list-style-type: none"> <li>• no absorptive material in cavity</li> <li>• resilient metal channels spaced 400 mm o.c.</li> <li>• 12.7 mm Type X gypsum board</li> </ul>	1 h	56	28
	F34f	F34 with <ul style="list-style-type: none"> <li>• no absorptive material in cavity</li> <li>• resilient metal channels spaced 600 mm o.c.</li> <li>• 12.7 mm Type X gypsum board</li> </ul>	1 h	58	28
	F34g	F34 with <ul style="list-style-type: none"> <li>• absorptive material in cavity</li> <li>• resilient metal channels spaced 400 mm o.c.</li> <li>• 12.7 mm Type X gypsum board</li> </ul>	1 h	63	36
	F34h	F34 with <ul style="list-style-type: none"> <li>• absorptive material in cavity</li> <li>• resilient metal channels spaced 600 mm o.c.</li> <li>• 12.7 mm Type X gypsum board</li> </ul>	45 min [1 h] <sup>(17)</sup>	65	36
	F34i	F34 with <ul style="list-style-type: none"> <li>• no absorptive material in cavity</li> <li>• resilient metal channels spaced 400 mm o.c.</li> <li>• 12.7 mm regular gypsum board</li> </ul>	-	56	28
	F34j	F34 with <ul style="list-style-type: none"> <li>• no absorptive material in cavity</li> <li>• resilient metal channels spaced 600 mm o.c.</li> <li>• 12.7 mm regular gypsum board</li> </ul>	-	58	28
	F34k	F34 with <ul style="list-style-type: none"> <li>• absorptive material in cavity</li> <li>• resilient metal channels spaced 400 mm o.c.</li> <li>• 12.7 mm regular gypsum board</li> </ul>	-	63	36
	F34l	F34 with <ul style="list-style-type: none"> <li>• absorptive material in cavity</li> <li>• resilient metal channels spaced 600 mm o.c.</li> <li>• 12.7 mm regular gypsum board</li> </ul>	-	65	36
	<b>F35</b>	<ul style="list-style-type: none"> <li>• 38 mm concrete topping (at least 70 kg/m<sup>2</sup>)</li> <li>• subfloor of 15.5 mm plywood, OSB or waferboard, or 17 mm tongue and groove lumber</li> <li>• on wood trusses spaced not more than 600 mm o.c.</li> <li>• with or without absorptive material in cavity</li> <li>• 1 layer of gypsum board on ceiling side</li> </ul>	 <p style="text-align: right; font-size: small;">GC00135A</p>		
	F35a	F35 with <ul style="list-style-type: none"> <li>• no absorptive material in cavity</li> <li>• 15.9 mm Type X gypsum board</li> </ul>	-	45	26
	F35b	F35 with <ul style="list-style-type: none"> <li>• absorptive material in cavity</li> <li>• 15.9 mm Type X gypsum board</li> </ul>	-	47	29
	F35c	F35 with <ul style="list-style-type: none"> <li>• no absorptive material in cavity</li> <li>• 12.7 mm Type X gypsum board</li> </ul>	-	43	26
	F35d	F35 with <ul style="list-style-type: none"> <li>• absorptive material in cavity</li> <li>• 12.7 mm Type X gypsum board</li> </ul>	-	45	29

# Fire and Sound Resistance Tables

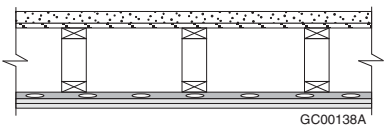
Table 9.10.3.1.-B (Continued)

Type of Assembly	Assembly Number	Description <sup>(2)(3)(4)</sup>	Fire-Resistance Rating <sup>(5)(6)(7)(8)</sup>	Typical Sound Transmission Class <sup>(5)(6)(9)(10)</sup> (STC)	Typical Impact Insulation Class <sup>(5)(9)(11)</sup> (IIC)
	F35e	F35 with <ul style="list-style-type: none"> <li>no absorptive material in cavity</li> <li>12.7 mm regular gypsum board</li> </ul>	-	43	26
	F35f	F35 with <ul style="list-style-type: none"> <li>absorptive material in cavity</li> <li>12.7 mm regular gypsum board</li> </ul>	-	45	29
	<b>F36</b>	<ul style="list-style-type: none"> <li>38 mm concrete topping (at least 70 kg/m<sup>2</sup>)</li> <li>subfloor of 15.5 mm plywood, OSB or waferboard, or 17 mm tongue and groove lumber</li> <li>on wood trusses spaced not more than 600 mm o.c.</li> <li>with or without absorptive material in cavity</li> <li>2 layers of gypsum board on ceiling side</li> </ul>	 <p style="text-align: right; font-size: small;">GC00136A</p>		
	F36a	F36 with <ul style="list-style-type: none"> <li>wood trusses spaced 400 mm o.c.</li> <li>no absorptive material in cavity</li> <li>15.9 mm Type X gypsum board</li> </ul>	1 h	49	28
	F36b	F36 with <ul style="list-style-type: none"> <li>wood trusses spaced 600 mm o.c.</li> <li>no absorptive material in cavity</li> <li>15.9 mm Type X gypsum board</li> </ul>	1 h	50	28
	F36c	F36 with <ul style="list-style-type: none"> <li>wood trusses spaced 400 mm o.c.</li> <li>absorptive material in cavity</li> <li>15.9 mm Type X gypsum board</li> </ul>	45 min [1 h] <sup>(14)</sup>	51	31
	F36d	F36 with <ul style="list-style-type: none"> <li>wood trusses spaced 600 mm o.c.</li> <li>absorptive material in cavity</li> <li>15.9 mm Type X gypsum board</li> </ul>	45 min	52	31
	F36e	F36 with <ul style="list-style-type: none"> <li>wood trusses spaced 400 mm o.c.</li> <li>no absorptive material in cavity</li> <li>12.7 mm Type X gypsum board</li> </ul>	1 h	48	27
	F36f	F36 with <ul style="list-style-type: none"> <li>wood trusses spaced 600 mm o.c.</li> <li>no absorptive material in cavity</li> <li>12.7 mm Type X gypsum board</li> </ul>	45 min	49	27
	F36g	F36 with <ul style="list-style-type: none"> <li>absorptive material in cavity</li> <li>12.7 mm Type X gypsum board</li> </ul>	-	50	30
	F36h	F36 with <ul style="list-style-type: none"> <li>no absorptive material in cavity</li> <li>12.7 mm regular gypsum board</li> </ul>	-	47	27
	F36i	F36 with <ul style="list-style-type: none"> <li>absorptive material in cavity</li> <li>12.7 mm regular gypsum board</li> </ul>	-	49	30
	<b>F37</b>	<ul style="list-style-type: none"> <li>38 mm concrete topping (at least 70 kg/m<sup>2</sup>)</li> <li>subfloor of 15.5 mm plywood, OSB or waferboard, or 17 mm tongue and groove lumber</li> <li>on wood trusses spaced not more than 600 mm o.c.</li> <li>with or without absorptive material in cavity</li> <li>resilient metal channels spaced 400 mm or 600 mm o.c.</li> <li>1 layer of gypsum board on ceiling side</li> </ul>	 <p style="text-align: right; font-size: small;">GC00137A</p>		

Copyright © NRC 1941 - 2021 World Rights Reserved © CNRC 1941-2021 Droits réservés pour tous pays

# Fire and Sound Resistance Tables

**Table 9.10.3.1.-B (Continued)**

Type of Assembly	Assembly Number	Description <sup>(2)(3)(4)</sup>	Fire-Resistance Rating <sup>(5)(6)(7)(8)</sup>	Typical Sound Transmission Class <sup>(5)(6)(9)(10)</sup> (STC)	Typical Impact Insulation Class <sup>(5)(9)(11)</sup> (IIC)
	F37a	F37 with <ul style="list-style-type: none"> <li>• no absorptive material in cavity</li> <li>• resilient metal channels spaced 400 mm o.c.</li> <li>• 15.9 mm Type X gypsum board</li> </ul>	45 min	56	35
	F37b	F37 with <ul style="list-style-type: none"> <li>• no absorptive material in cavity</li> <li>• resilient metal channels spaced 600 mm o.c.</li> <li>• 15.9 mm Type X gypsum board</li> </ul>	-	59	35
	F37c	F37 with <ul style="list-style-type: none"> <li>• absorptive material in cavity</li> <li>• resilient metal channels spaced 400 mm o.c.</li> <li>• 15.9 mm Type X gypsum board</li> </ul>	30 min [45 min] <sup>(24)</sup>	63	43
	F37d	F37 with <ul style="list-style-type: none"> <li>• absorptive material in cavity</li> <li>• resilient metal channels spaced 600 mm o.c.</li> <li>• 15.9 mm Type X gypsum board</li> </ul>	-	66	43
	F37e	F37 with <ul style="list-style-type: none"> <li>• no absorptive material in cavity</li> <li>• resilient metal channels spaced 400 mm o.c.</li> <li>• 12.7 mm Type X gypsum board</li> </ul>	-	55	35
	F37f	F37 with <ul style="list-style-type: none"> <li>• no absorptive material in cavity</li> <li>• resilient metal channels spaced 600 mm o.c.</li> <li>• 12.7 mm Type X gypsum board</li> </ul>	-	57	35
	F37g	F37 with <ul style="list-style-type: none"> <li>• absorptive material in cavity</li> <li>• resilient metal channels spaced 400 mm o.c.</li> <li>• 12.7 mm Type X gypsum board</li> </ul>	-	62	43
	F37h	F37 with <ul style="list-style-type: none"> <li>• absorptive material in cavity</li> <li>• resilient metal channels spaced 600 mm o.c.</li> <li>• 12.7 mm Type X gypsum board</li> </ul>	-	64	43
	F37i	F37 with <ul style="list-style-type: none"> <li>• no absorptive material in cavity</li> <li>• resilient metal channels spaced 400 mm o.c.</li> <li>• 12.7 mm regular gypsum board</li> </ul>	-	54	35
	F37j	F37 with <ul style="list-style-type: none"> <li>• no absorptive material in cavity</li> <li>• resilient metal channels spaced 600 mm o.c.</li> <li>• 12.7 mm regular gypsum board</li> </ul>	-	57	35
	F37k	F37 with <ul style="list-style-type: none"> <li>• absorptive material in cavity</li> <li>• resilient metal channels spaced 400 mm o.c.</li> <li>• 12.7 mm regular gypsum board</li> </ul>	-	61	43
	F37l	F37 with <ul style="list-style-type: none"> <li>• absorptive material in cavity</li> <li>• resilient metal channels spaced 600 mm o.c.</li> <li>• 12.7 mm regular gypsum board</li> </ul>	-	64	43
	<b>F38</b>	<ul style="list-style-type: none"> <li>• 38 mm concrete topping (at least 70 kg/m<sup>2</sup>)</li> <li>• subfloor of 15.5 mm plywood, OSB or waferboard, or 17 mm tongue and groove lumber</li> <li>• on wood trusses spaced not more than 600 mm o.c.</li> <li>• with or without absorptive material in cavity</li> <li>• resilient metal channels spaced 400 mm or 600 mm o.c.</li> <li>• 2 layers of gypsum board on ceiling side</li> </ul>	 <p style="text-align: right; font-size: small;">GC00138A</p>		

# Fire and Sound Resistance Tables

Table 9.10.3.1.-B (Continued)

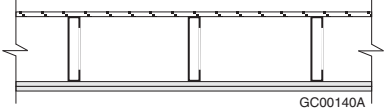
Type of Assembly	Assembly Number	Description <sup>(2)(3)(4)</sup>	Fire-Resistance Rating <sup>(5)(6)(7)(8)</sup>	Typical Sound Transmission Class <sup>(5)(6)(9)(10)</sup> (STC)	Typical Impact Insulation Class <sup>(5)(9)(11)</sup> (IIC)
	F38a	F38 with <ul style="list-style-type: none"> <li>• no absorptive material in cavity</li> <li>• resilient metal channels spaced 400 mm o.c.</li> <li>• 15.9 mm Type X gypsum board</li> </ul>	1 h	61	37
	F38b	F38 with <ul style="list-style-type: none"> <li>• no absorptive material in cavity</li> <li>• resilient metal channels spaced 600 mm o.c.</li> <li>• 15.9 mm Type X gypsum board</li> </ul>	1 h	63	37
	F38c	F38 with <ul style="list-style-type: none"> <li>• absorptive material in cavity</li> <li>• resilient metal channels spaced 400 mm o.c.</li> <li>• 15.9 mm Type X gypsum board</li> </ul>	1 h [1.5] <sup>(25)</sup>	68 [71] <sup>(25)</sup>	45
	F38d	F38 with <ul style="list-style-type: none"> <li>• absorptive material in cavity</li> <li>• resilient metal channels spaced 600 mm o.c.</li> <li>• 15.9 mm Type X gypsum board</li> </ul>	1 h	70	45
	F38e	F38 with <ul style="list-style-type: none"> <li>• no absorptive material in cavity</li> <li>• resilient metal channels spaced 400 mm o.c.</li> <li>• 12.7 mm Type X gypsum board</li> </ul>	1 h	60	36
	F38f	F38 with <ul style="list-style-type: none"> <li>• no absorptive material in cavity</li> <li>• resilient metal channels spaced 600 mm o.c.</li> <li>• 12.7 mm Type X gypsum board</li> </ul>	1 h	62	36
	F38g	F38 with <ul style="list-style-type: none"> <li>• absorptive material in cavity</li> <li>• resilient metal channels spaced 400 mm o.c.</li> <li>• 12.7 mm Type X gypsum board</li> </ul>	1 h	67	44
	F38h	F38 with <ul style="list-style-type: none"> <li>• absorptive material in cavity</li> <li>• resilient metal channels spaced 600 mm o.c.</li> <li>• 12.7 mm Type X gypsum board</li> </ul>	1 h	69	44
	F38i	F38 with <ul style="list-style-type: none"> <li>• no absorptive material in cavity</li> <li>• resilient metal channels spaced 400 mm o.c.</li> <li>• 12.7 mm regular gypsum board</li> </ul>	-	59	36
	F38j	F38 with <ul style="list-style-type: none"> <li>• no absorptive material in cavity</li> <li>• resilient metal channels spaced 600 mm o.c.</li> <li>• 12.7 mm regular gypsum board</li> </ul>	-	61	36
	F38k	F38 with <ul style="list-style-type: none"> <li>• absorptive material in cavity</li> <li>• resilient metal channels spaced 400 mm o.c.</li> <li>• 12.7 mm regular gypsum board</li> </ul>	-	66	44
	F38l	F38 with <ul style="list-style-type: none"> <li>• absorptive material in cavity</li> <li>• resilient metal channels spaced 600 mm o.c.</li> <li>• 12.7 mm regular gypsum board</li> </ul>	-	68	44
Cold-Formed-Steel Floor Joists <sup>(26)</sup>	<b>F39</b>	<ul style="list-style-type: none"> <li>• subfloor of 15.5 mm plywood, OSB or waferboard, or 17 mm tongue and groove lumber</li> <li>• on steel joists spaced not more than 600 mm o.c.</li> <li>• with or without absorptive material in cavity</li> <li>• 1 layer of gypsum board on ceiling side</li> </ul>			

Copyright © NRC 1941 - 2021 World Rights Reserved © CNRC 1941-2021 Droits réservés pour tous pays



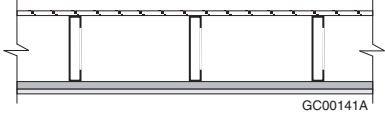
# Fire and Sound Resistance Tables

**Table 9.10.3.1.-B (Continued)**

Type of Assembly	Assembly Number	Description <sup>(2)(3)(4)</sup>	Fire-Resistance Rating <sup>(5)(6)(7)(8)</sup>	Typical Sound Transmission Class <sup>(5)(6)(9)(10)</sup> (STC)	Typical Impact Insulation Class <sup>(5)(9)(11)</sup> (IIC)
	F39a	F39 with • no absorptive material in cavity • 15.9 mm Type X gypsum board	-	29	27
	F39b	F39 with • absorptive material in cavity • 15.9 mm Type X gypsum board	-	31	30
	F39c	F39 with • no absorptive material in cavity • 12.7 mm Type X gypsum board	-	27	26
	F39d	F39 with • absorptive material in cavity • 12.7 mm Type X gypsum board	-	29	29
	F39e	F39 with • no absorptive material in cavity • 12.7 mm regular gypsum board	-	27	25
	F39f	F39 with • absorptive material in cavity • 12.7 mm regular gypsum board	-	29	28
	<b>F40</b>	<ul style="list-style-type: none"> <li>• subfloor of 15.5 mm plywood, OSB or waferboard, or 17 mm tongue and groove lumber</li> <li>• on steel joists spaced not more than 600 mm o.c.</li> <li>• with or without absorptive material in cavity</li> <li>• 2 layers of gypsum board on ceiling side</li> </ul>			
	F40a	F40 with • steel joists spaced 400 mm o.c. • no absorptive material in cavity • 15.9 mm Type X gypsum board	1 h	34	31
	F40b	F40 with • steel joists spaced 600 mm o.c. • no absorptive material in cavity • 15.9 mm Type X gypsum board	45 min	35	31
	F40c	F40 with • steel joists spaced 400 mm o.c. • absorptive material in cavity • 15.9 mm Type X gypsum board	45 min	36	34
	F40d	F40 with • steel joists spaced 600 mm o.c. • absorptive material in cavity • 15.9 mm Type X gypsum board	45 min	37	34
	F40e	F40 with • steel joists spaced 400 mm o.c. • no absorptive material in cavity • 12.7 mm Type X gypsum board	1 h	32	30
	F40f	F40 with • steel joists spaced 600 mm o.c. • no absorptive material in cavity • 12.7 mm Type X gypsum board	45 min	33	30
	F40g	F40 with • steel joists spaced 400 mm o.c. • absorptive material in cavity • 12.7 mm Type X gypsum board	45 min	34	33
	F40h	F40 with • steel joists spaced 600 mm o.c. • absorptive material in cavity • 12.7 mm Type X gypsum board	45 min	35	33

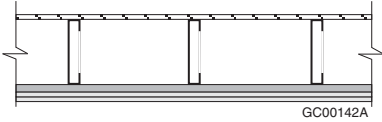
# Fire and Sound Resistance Tables

Table 9.10.3.1.-B (Continued)

Type of Assembly	Assembly Number	Description <sup>(2)(3)(4)</sup>	Fire-Resistance Rating <sup>(5)(6)(7)(8)</sup>	Typical Sound Transmission Class <sup>(5)(6)(9)(10)</sup> (STC)	Typical Impact Insulation Class <sup>(5)(9)(11)</sup> (IIC)
	F40i	F40 with <ul style="list-style-type: none"> <li>no absorptive material in cavity</li> <li>12.7 mm regular gypsum board</li> </ul>	-	31	30
	F40j	F40 with <ul style="list-style-type: none"> <li>absorptive material in cavity</li> <li>12.7 mm regular gypsum board</li> </ul>	-	33	33
	<b>F41</b>	<ul style="list-style-type: none"> <li>subfloor of 15.5 mm plywood, OSB or waferboard, or 17 mm tongue and groove lumber</li> <li>on steel joists spaced not more than 600 mm o.c.</li> <li>with or without absorptive material in cavity</li> <li>steel furring channels spaced 400 mm or 600 mm o.c.</li> <li>1 layer of gypsum board on ceiling side</li> </ul>			
	F41a	F41 with <ul style="list-style-type: none"> <li>no absorptive material in cavity</li> <li>steel furring channels spaced 400 mm o.c.</li> <li>15.9 mm Type X gypsum board</li> </ul>	-	34	27
	F41b	F41 with <ul style="list-style-type: none"> <li>no absorptive material in cavity</li> <li>steel furring channels spaced 600 mm o.c.</li> <li>15.9 mm Type X gypsum board</li> </ul>	-	37	30
	F41c	F41 with <ul style="list-style-type: none"> <li>absorptive material in cavity</li> <li>steel furring channels spaced 400 mm o.c.</li> <li>15.9 mm Type X gypsum board</li> </ul>	30 min [45 min] <sup>(24)</sup>	37	30
	F41d	F41 with <ul style="list-style-type: none"> <li>absorptive material in cavity</li> <li>steel furring channels spaced 600 mm o.c.</li> <li>15.9 mm Type X gypsum board</li> </ul>	30 min	40	33
	F41e	F41 with <ul style="list-style-type: none"> <li>no absorptive material in cavity</li> <li>steel furring channels spaced 400 mm o.c.</li> <li>12.7 mm Type X gypsum board</li> </ul>	-	33	26
	F41f	F41 with <ul style="list-style-type: none"> <li>no absorptive material in cavity</li> <li>steel furring channels spaced 600 mm o.c.</li> <li>12.7 mm Type X gypsum board</li> </ul>	-	35	29
	F41g	F41 with <ul style="list-style-type: none"> <li>absorptive material in cavity</li> <li>steel furring channels spaced 400 mm o.c.</li> <li>12.7 mm Type X gypsum board</li> </ul>	30 min [45 min] <sup>(24)</sup>	36	29
	F41h	F41 with <ul style="list-style-type: none"> <li>absorptive material in cavity</li> <li>steel furring channels spaced 600 mm o.c.</li> <li>12.7 mm Type X gypsum board</li> </ul>	30 min	38	32
	F41i	F41 with <ul style="list-style-type: none"> <li>no absorptive material in cavity</li> <li>steel furring channels spaced 400 mm o.c.</li> <li>12.7 mm regular gypsum board</li> </ul>	< 30 min	32	25
	F41j	F41 with <ul style="list-style-type: none"> <li>no absorptive material in cavity</li> <li>steel furring channels spaced 600 mm o.c.</li> <li>12.7 mm regular gypsum board</li> </ul>	< 30 min	35	28

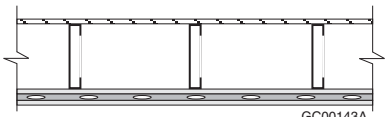
# Fire and Sound Resistance Tables

**Table 9.10.3.1.-B (Continued)**

Type of Assembly	Assembly Number	Description <sup>(2)(3)(4)</sup>	Fire-Resistance Rating <sup>(5)(6)(7)(8)</sup>	Typical Sound Transmission Class <sup>(5)(6)(9)(10)</sup> (STC)	Typical Impact Insulation Class <sup>(5)(9)(11)</sup> (IIC)
	F41k	F41 with <ul style="list-style-type: none"> <li>• absorptive material in cavity</li> <li>• steel furring channels spaced 400 mm o.c.</li> <li>• 12.7 mm regular gypsum board</li> </ul>	< 30 min	35	28
	F41l	F41 with <ul style="list-style-type: none"> <li>• absorptive material in cavity</li> <li>• steel furring channels spaced 600 mm o.c.</li> <li>• 12.7 mm regular gypsum board</li> </ul>	< 30 min	38	31
	<b>F42</b>	<ul style="list-style-type: none"> <li>• subfloor of 15.5 mm plywood, OSB or waferboard, or 17 mm tongue and groove lumber</li> <li>• on steel joists spaced not more than 600 mm o.c.</li> <li>• with or without absorptive material in cavity</li> <li>• steel furring channels spaced 400 mm or 600 mm o.c.</li> <li>• 2 layers of gypsum board on ceiling side</li> </ul>			
	F42a	F42 with <ul style="list-style-type: none"> <li>• no absorptive material in cavity</li> <li>• steel furring channels spaced 400 mm o.c.</li> <li>• 15.9 mm Type X gypsum board</li> </ul>	1 h	39	32
	F42b	F42 with <ul style="list-style-type: none"> <li>• steel joists spaced 400 mm o.c.</li> <li>• no absorptive material in cavity</li> <li>• steel furring channels spaced 600 mm o.c.</li> <li>• 15.9 mm Type X gypsum board</li> </ul>	45 min	42	34
	F42c	F42 with <ul style="list-style-type: none"> <li>• steel joists spaced 600 mm o.c.</li> <li>• no absorptive material in cavity</li> <li>• steel furring channels spaced 600 mm o.c.</li> <li>• 15.9 mm Type X gypsum board</li> </ul>	45 min	43	34
	F42d	F42 with <ul style="list-style-type: none"> <li>• absorptive material in cavity</li> <li>• steel furring channels spaced 400 mm o.c.</li> <li>• 15.9 mm Type X gypsum board</li> </ul>	1 h	42	35
	F42e	F42 with <ul style="list-style-type: none"> <li>• steel joists spaced 400 mm o.c.</li> <li>• absorptive material in cavity</li> <li>• steel furring channels spaced 600 mm o.c.</li> <li>• 15.9 mm Type X gypsum board</li> </ul>	45 min [1 h] <sup>(27)</sup>	45	37
	F42f	F42 with <ul style="list-style-type: none"> <li>• steel joists spaced 600 mm o.c.</li> <li>• absorptive material in cavity</li> <li>• steel furring channels spaced 600 mm o.c.</li> <li>• 15.9 mm Type X gypsum board</li> </ul>	45 min [1 h] <sup>(14)</sup>	46	37
	F42g	F42 with <ul style="list-style-type: none"> <li>• no absorptive material in cavity</li> <li>• steel furring channels spaced 400 mm o.c.</li> <li>• 12.7 mm Type X gypsum board</li> </ul>	1 h	38	30
	F42h	F42 with <ul style="list-style-type: none"> <li>• steel joists spaced 400 mm o.c.</li> <li>• no absorptive material in cavity</li> <li>• steel furring channels spaced 600 mm o.c.</li> <li>• 12.7 mm Type X gypsum board</li> </ul>	45 min	40	33
	F42i	F42 with <ul style="list-style-type: none"> <li>• steel joists spaced 600 mm o.c.</li> <li>• no absorptive material in cavity</li> <li>• steel furring channels spaced 600 mm o.c.</li> <li>• 12.7 mm Type X gypsum board</li> </ul>	45 min	41	33

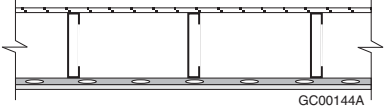
# Fire and Sound Resistance Tables

Table 9.10.3.1.-B (Continued)

Type of Assembly	Assembly Number	Description <sup>(2)(3)(4)</sup>	Fire-Resistance Rating <sup>(5)(6)(7)(8)</sup>	Typical Sound Transmission Class <sup>(5)(6)(9)(10)</sup> (STC)	Typical Impact Insulation Class <sup>(5)(9)(11)</sup> (IIC)
	F42j	F42 with <ul style="list-style-type: none"> <li>• absorptive material in cavity</li> <li>• steel furring channels spaced 400 mm o.c.</li> <li>• 12.7 mm Type X gypsum board</li> </ul>	1 h	41	33
	F42k	F42 with <ul style="list-style-type: none"> <li>• steel joists spaced 400 mm o.c.</li> <li>• absorptive material in cavity</li> <li>• steel furring channels spaced 600 mm o.c.</li> <li>• 12.7 mm Type X gypsum board</li> </ul>	45 min [1 h] <sup>(27)</sup>	43	36
	F42l	F42 with <ul style="list-style-type: none"> <li>• steel joists spaced 600 mm o.c.</li> <li>• absorptive material in cavity</li> <li>• steel furring channels spaced 600 mm o.c.</li> <li>• 12.7 mm Type X gypsum board</li> </ul>	45 min [1 h] <sup>(14)</sup>	44	36
	F42m	F42 with <ul style="list-style-type: none"> <li>• no absorptive material in cavity</li> <li>• steel furring channels spaced 400 mm o.c.</li> <li>• 12.7 mm regular gypsum board</li> </ul>	-	37	30
	F42n	F42 with <ul style="list-style-type: none"> <li>• no absorptive material in cavity</li> <li>• steel furring channels spaced 600 mm o.c.</li> <li>• 12.7 mm regular gypsum board</li> </ul>	-	39	33
	F42o	F42 with <ul style="list-style-type: none"> <li>• absorptive material in cavity</li> <li>• steel furring channels spaced 400 mm o.c.</li> <li>• 12.7 mm regular gypsum board</li> </ul>	-	40	33
	F42p	F42 with <ul style="list-style-type: none"> <li>• absorptive material in cavity</li> <li>• steel furring channels spaced 600 mm o.c.</li> <li>• 12.7 mm regular gypsum board</li> </ul>	-	42	36
	F43	<ul style="list-style-type: none"> <li>• subfloor of 15.5 mm plywood, OSB or waferboard, or 17 mm tongue and groove lumber</li> <li>• on steel joists spaced not more than 600 mm o.c.</li> <li>• with or without absorptive material in cavity</li> <li>• 1 layer of gypsum board attached directly to joists on ceiling side</li> <li>• resilient metal channels spaced 400 mm or 600 mm o.c. attached to joists through the gypsum board</li> <li>• 1 layer of gypsum board attached to resilient metal channels</li> </ul>	 <p style="text-align: right; font-size: small;">GC00143A</p>		
	F43a	F43 with <ul style="list-style-type: none"> <li>• no absorptive material in cavity</li> <li>• 15.9 mm Type X gypsum board</li> <li>• resilient metal channels</li> <li>• 15.9 mm Type X gypsum board</li> </ul>	1 h	35	27
	F43b	F43 with <ul style="list-style-type: none"> <li>• absorptive material in cavity</li> <li>• 15.9 mm Type X gypsum board</li> <li>• resilient metal channels</li> <li>• 15.9 mm Type X gypsum board</li> </ul>	1 h	37	30
	F43c	F43 with <ul style="list-style-type: none"> <li>• no absorptive material in cavity</li> <li>• 12.7 mm Type X gypsum board</li> <li>• resilient metal channels</li> <li>• 12.7 mm Type X gypsum board</li> </ul>	1 h	35	27

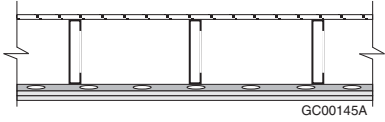
# Fire and Sound Resistance Tables

**Table 9.10.3.1.-B (Continued)**

Type of Assembly	Assembly Number	Description <sup>(2)(3)(4)</sup>	Fire-Resistance Rating <sup>(5)(6)(7)(8)</sup>	Typical Sound Transmission Class <sup>(5)(6)(9)(10)</sup> (STC)	Typical Impact Insulation Class <sup>(5)(9)(11)</sup> (IIC)
	F43d	F43 with <ul style="list-style-type: none"> <li>• absorptive material in cavity</li> <li>• 12.7 mm Type X gypsum board</li> <li>• resilient metal channels</li> <li>• 12.7 mm Type X gypsum board</li> </ul>	1 h	37	30
	F43e	F43 with <ul style="list-style-type: none"> <li>• no absorptive material in cavity</li> <li>• 12.7 mm regular gypsum board</li> <li>• resilient metal channels</li> <li>• 12.7 mm regular gypsum board</li> </ul>	-	32	26
	F43f	F43 with <ul style="list-style-type: none"> <li>• absorptive material in cavity</li> <li>• 12.7 mm regular gypsum board</li> <li>• resilient metal channels</li> <li>• 12.7 mm regular gypsum board</li> </ul>	-	35	28
	<b>F44</b>	<ul style="list-style-type: none"> <li>• subfloor of 15.5 mm plywood, OSB or waferboard, or 17 mm tongue and groove lumber</li> <li>• on steel joists spaced not more than 600 mm o.c.</li> <li>• with or without absorptive material in cavity</li> <li>• resilient metal channels spaced 400 mm or 600 mm o.c.</li> <li>• 1 layer of gypsum board on ceiling side</li> </ul>			
	F44a	F44 with <ul style="list-style-type: none"> <li>• no absorptive material in cavity</li> <li>• resilient metal channels spaced 400 mm o.c.</li> <li>• 15.9 mm Type X gypsum board</li> </ul>	-	40	33
	F44b	F44 with <ul style="list-style-type: none"> <li>• no absorptive material in cavity</li> <li>• resilient metal channels spaced 600 mm o.c.</li> <li>• 15.9 mm Type X gypsum board</li> </ul>	-	43	36
	F44c	F44 with <ul style="list-style-type: none"> <li>• absorptive material in cavity</li> <li>• resilient metal channels spaced 400 mm o.c.</li> <li>• 15.9 mm Type X gypsum board</li> </ul>	30 min [45 min] <sup>(24)</sup>	47	41
	F44d	F44 with <ul style="list-style-type: none"> <li>• absorptive material in cavity</li> <li>• resilient metal channels spaced 600 mm o.c.</li> <li>• 15.9 mm Type X gypsum board</li> </ul>	30 min	50	44
	F44e	F44 with <ul style="list-style-type: none"> <li>• no absorptive material in cavity</li> <li>• resilient metal channels spaced 400 mm o.c.</li> <li>• 12.7 mm Type X gypsum board</li> </ul>	-	39	32
	F44f	F44 with <ul style="list-style-type: none"> <li>• no absorptive material in cavity</li> <li>• resilient metal channels spaced 600 mm o.c.</li> <li>• 12.7 mm Type X gypsum board</li> </ul>	-	41	35
	F44g	F44 with <ul style="list-style-type: none"> <li>• absorptive material in cavity</li> <li>• resilient metal channels spaced 400 mm o.c.</li> <li>• 12.7 mm Type X gypsum board</li> </ul>	30 min [45 min] <sup>(24)</sup>	46	40
	F44h	F44 with <ul style="list-style-type: none"> <li>• absorptive material in cavity</li> <li>• resilient metal channels spaced 600 mm o.c.</li> <li>• 12.7 mm Type X gypsum board</li> </ul>	30 min	48	43

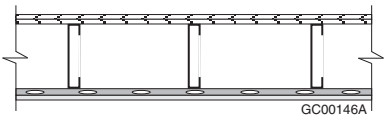
# Fire and Sound Resistance Tables

Table 9.10.3.1.-B (Continued)

Type of Assembly	Assembly Number	Description <sup>(2)(3)(4)</sup>	Fire-Resistance Rating <sup>(5)(6)(7)(8)</sup>	Typical Sound Transmission Class <sup>(5)(6)(9)(10)</sup> (STC)	Typical Impact Insulation Class <sup>(5)(9)(11)</sup> (IIC)
	F44i	F44 with <ul style="list-style-type: none"> <li>no absorptive material in cavity</li> <li>resilient metal channels spaced 400 mm o.c.</li> <li>12.7 mm regular gypsum board</li> </ul>	< 30 min	38	31
	F44j	F44 with <ul style="list-style-type: none"> <li>no absorptive material in cavity</li> <li>resilient metal channels spaced 600 mm o.c.</li> <li>12.7 mm regular gypsum board</li> </ul>	< 30 min	41	34
	F44k	F44 with <ul style="list-style-type: none"> <li>absorptive material in cavity</li> <li>resilient metal channels spaced 400 mm o.c.</li> <li>12.7 mm regular gypsum board</li> </ul>	< 30 min	45	39
	F44l	F44 with <ul style="list-style-type: none"> <li>absorptive material in cavity</li> <li>resilient metal channels spaced 600 mm o.c.</li> <li>12.7 mm regular gypsum board</li> </ul>	< 30 min	48	42
	F45	<ul style="list-style-type: none"> <li>subfloor of 15.5 mm plywood, OSB or waferboard, or 17 mm tongue and groove lumber</li> <li>on steel joists spaced not more than 600 mm o.c.</li> <li>with or without absorptive material in cavity</li> <li>resilient metal channels spaced 400 mm or 600 mm o.c.</li> <li>2 layers of gypsum board on ceiling side</li> </ul>	 <p style="text-align: right; font-size: small;">GC00145A</p>		
	F45a	F45 with <ul style="list-style-type: none"> <li>no absorptive material in cavity</li> <li>resilient metal channels spaced 400 mm o.c.</li> <li>15.9 mm Type X gypsum board</li> </ul>	1 h	45	38
	F45b	F45 with <ul style="list-style-type: none"> <li>steel joists spaced 400 mm o.c.</li> <li>no absorptive material in cavity</li> <li>resilient metal channels spaced 600 mm o.c.</li> <li>15.9 mm Type X gypsum board</li> </ul>	45 min	48	40
	F45c	F45 with <ul style="list-style-type: none"> <li>steel joists spaced 600 mm o.c.</li> <li>no absorptive material in cavity</li> <li>resilient metal channels spaced 600 mm o.c.</li> <li>15.9 mm Type X gypsum board</li> </ul>	45 min	49	40
	F45d	F45 with <ul style="list-style-type: none"> <li>absorptive material in cavity</li> <li>resilient metal channels spaced 400 mm o.c.</li> <li>15.9 mm Type X gypsum board</li> </ul>	1 h	52	46
	F45e	F45 with <ul style="list-style-type: none"> <li>steel joists spaced 400 mm o.c.</li> <li>absorptive material in cavity</li> <li>resilient metal channels spaced 600 mm o.c.</li> <li>15.9 mm Type X gypsum board</li> </ul>	45 min [1 h] <sup>(27)</sup>	55	48
	F45f	F45 with <ul style="list-style-type: none"> <li>steel joists spaced 600 mm o.c.</li> <li>absorptive material in cavity</li> <li>resilient metal channels spaced 600 mm o.c.</li> <li>15.9 mm Type X gypsum board</li> </ul>	45 min [1 h] <sup>(14)</sup>	56	48
	F45g	F45 with <ul style="list-style-type: none"> <li>no absorptive material in cavity</li> <li>resilient metal channels spaced 400 mm o.c.</li> <li>12.7 mm Type X gypsum board</li> </ul>	1 h	44	36

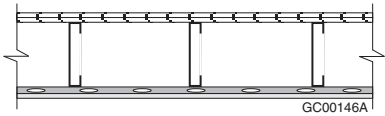
# Fire and Sound Resistance Tables

**Table 9.10.3.1.-B (Continued)**

Type of Assembly	Assembly Number	Description <sup>(2)(3)(4)</sup>	Fire-Resistance Rating <sup>(5)(6)(7)(8)</sup>	Typical Sound Transmission Class <sup>(5)(6)(9)(10)</sup> (STC)	Typical Impact Insulation Class <sup>(5)(9)(11)</sup> (IIC)
	F45h	F45 with <ul style="list-style-type: none"> <li>• steel joists spaced 400 mm o.c.</li> <li>• no absorptive material in cavity</li> <li>• resilient metal channels spaced 600 mm o.c.</li> <li>• 12.7 mm Type X gypsum board</li> </ul>	45 min	46	39
	F45i	F45 with <ul style="list-style-type: none"> <li>• steel joists spaced 600 mm o.c.</li> <li>• no absorptive material in cavity</li> <li>• resilient metal channels spaced 600 mm o.c.</li> <li>• 12.7 mm Type X gypsum board</li> </ul>	45 min	47	39
	F45j	F45 with <ul style="list-style-type: none"> <li>• absorptive material in cavity</li> <li>• resilient metal channels spaced 400 mm o.c.</li> <li>• 12.7 mm Type X gypsum board</li> </ul>	1 h	51	44
	F45k	F45 with <ul style="list-style-type: none"> <li>• steel joists spaced 400 mm o.c.</li> <li>• absorptive material in cavity</li> <li>• resilient metal channels spaced 600 mm o.c.</li> <li>• 12.7 mm Type X gypsum board</li> </ul>	45 min [1 h] <sup>(27)</sup>	53	47
	F45l	F45 with <ul style="list-style-type: none"> <li>• steel joists spaced 600 mm o.c.</li> <li>• absorptive material in cavity</li> <li>• resilient metal channels spaced 600 mm o.c.</li> <li>• 12.7 mm Type X gypsum board</li> </ul>	45 min [1 h] <sup>(14)</sup>	54	47
	F45m	F45 with <ul style="list-style-type: none"> <li>• no absorptive material in cavity</li> <li>• resilient metal channels spaced 400 mm o.c.</li> <li>• 12.7 mm regular gypsum board</li> </ul>	-	43	36
	F45n	F45 with <ul style="list-style-type: none"> <li>• no absorptive material in cavity</li> <li>• resilient metal channels spaced 600 mm o.c.</li> <li>• 12.7 mm regular gypsum board</li> </ul>	-	45	39
	F45o	F45 with <ul style="list-style-type: none"> <li>• absorptive material in cavity</li> <li>• resilient metal channels spaced 400 mm o.c.</li> <li>• 12.7 mm regular gypsum board</li> </ul>	-	50	44
	F45p	F45 with <ul style="list-style-type: none"> <li>• absorptive material in cavity</li> <li>• resilient metal channels spaced 600 mm o.c.</li> <li>• 12.7 mm regular gypsum board</li> </ul>	-	52	47
	<b>F46</b>	<ul style="list-style-type: none"> <li>• one subfloor layer of 11 mm sanded plywood, or OSB or waferboard</li> <li>• one subfloor layer of 15.5 mm plywood, OSB or waferboard, or 17 mm tongue and groove lumber</li> <li>• on steel joists spaced not more than 600 mm o.c.</li> <li>• with or without absorptive material in cavity</li> <li>• resilient metal channels spaced 400 mm or 600 mm o.c.</li> <li>• 1 layer of gypsum board on ceiling side</li> </ul>	 <p style="text-align: right; font-size: small;">GC00146A</p>		
	F46a	F46 with <ul style="list-style-type: none"> <li>• no absorptive material in cavity</li> <li>• resilient metal channels spaced 400 mm o.c.</li> <li>• 15.9 mm Type X gypsum board</li> </ul>	-	43	34
	F46b	F46 with <ul style="list-style-type: none"> <li>• no absorptive material in cavity</li> <li>• resilient metal channels spaced 600 mm o.c.</li> <li>• 15.9 mm Type X gypsum board</li> </ul>	-	46	37

# Fire and Sound Resistance Tables

Table 9.10.3.1.-B (Continued)

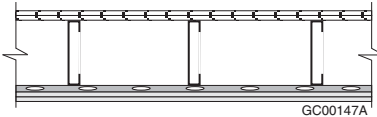
Type of Assembly	Assembly Number	Description <sup>(2)(3)(4)</sup>	Fire-Resistance Rating <sup>(5)(6)(7)(8)</sup>	Typical Sound Transmission Class <sup>(5)(6)(9)(10)</sup> (STC)	Typical Impact Insulation Class <sup>(5)(9)(11)</sup> (IIC)
	F46c	F46 with <ul style="list-style-type: none"> <li>• absorptive material in cavity</li> <li>• resilient metal channels spaced 400 mm o.c.</li> <li>• 15.9 mm Type X gypsum board</li> </ul>	-	50	42
	F46d	F46 with <ul style="list-style-type: none"> <li>• absorptive material in cavity</li> <li>• resilient metal channels spaced 600 mm o.c.</li> <li>• 15.9 mm Type X gypsum board</li> </ul>	-	53	45
	F46e	F46 with <ul style="list-style-type: none"> <li>• no absorptive material in cavity</li> <li>• resilient metal channels spaced 400 mm o.c.</li> <li>• 12.7 mm Type X gypsum board</li> </ul>	-	42	33
	F46f	F46 with <ul style="list-style-type: none"> <li>• no absorptive material in cavity</li> <li>• resilient metal channels spaced 600 mm o.c.</li> <li>• 12.7 mm Type X gypsum board</li> </ul>	-	44	36
	F46g	F46 with <ul style="list-style-type: none"> <li>• absorptive material in cavity</li> <li>• resilient metal channels spaced 400 mm o.c.</li> <li>• 12.7 mm Type X gypsum board</li> </ul>	-	49	41
	F46h	F46 with <ul style="list-style-type: none"> <li>• absorptive material in cavity</li> <li>• resilient metal channels spaced 600 mm o.c.</li> <li>• 12.7 mm Type X gypsum board</li> </ul>	-	51	44
	F46i	F46 with <ul style="list-style-type: none"> <li>• no absorptive material in cavity</li> <li>• resilient metal channels spaced 400 mm o.c.</li> <li>• 12.7 mm regular gypsum board</li> </ul>	-	41	33
	F46j	F46 with <ul style="list-style-type: none"> <li>• no absorptive material in cavity</li> <li>• resilient metal channels spaced 600 mm o.c.</li> <li>• 12.7 mm regular gypsum board</li> </ul>	-	44	36
	F46k	F46 with <ul style="list-style-type: none"> <li>• absorptive material in cavity</li> <li>• resilient metal channels spaced 400 mm o.c.</li> <li>• 12.7 mm regular gypsum board</li> </ul>	-	48	41
	F46l	F46 with <ul style="list-style-type: none"> <li>• absorptive material in cavity</li> <li>• resilient metal channels spaced 600 mm o.c.</li> <li>• 12.7 mm regular gypsum board</li> </ul>	-	51	44
	<b>F47</b>	<ul style="list-style-type: none"> <li>• one subfloor layer of 15.5 mm plywood, or OSB or waferboard</li> <li>• one subfloor layer of 15.5 mm plywood, OSB or waferboard, or 17 mm tongue and groove lumber</li> <li>• on steel joists spaced not more than 400 mm o.c.</li> <li>• with or without absorptive material in cavity</li> <li>• resilient metal channels spaced 400 mm or 600 mm o.c.</li> <li>• 1 layer of gypsum board on ceiling side</li> </ul>			
	F47a	F47 with <ul style="list-style-type: none"> <li>• no absorptive material in cavity</li> <li>• resilient metal channels spaced 400 mm o.c.</li> <li>• 15.9 mm Type X gypsum board</li> </ul>	30 min	45	35
	F47b	F47 with <ul style="list-style-type: none"> <li>• no absorptive material in cavity</li> <li>• resilient metal channels spaced 600 mm o.c.</li> <li>• 15.9 mm Type X gypsum board</li> </ul>	30 min	47	38

Copyright © NRC 1941 - 2021 World Rights Reserved © CNRC 1941-2021 Droits réservés pour tous pays



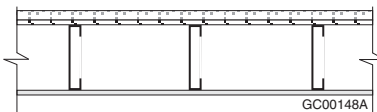
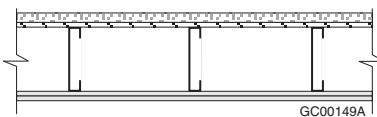
# Fire and Sound Resistance Tables

**Table 9.10.3.1.-B (Continued)**

Type of Assembly	Assembly Number	Description <sup>(2)(3)(4)</sup>	Fire-Resistance Rating <sup>(5)(6)(7)(8)</sup>	Typical Sound Transmission Class <sup>(5)(6)(9)(10)</sup> (STC)	Typical Impact Insulation Class <sup>(5)(9)(11)</sup> (IIC)
	F47c	F47 with <ul style="list-style-type: none"> <li>• absorptive material in cavity</li> <li>• resilient metal channels spaced 400 mm o.c.</li> <li>• 15.9 mm Type X gypsum board</li> </ul>	30 min [45 min] <sup>(17)</sup> [1 h] <sup>(27)</sup>	51	45
	F47d	F47 with <ul style="list-style-type: none"> <li>• absorptive material in cavity</li> <li>• resilient metal channels spaced 600 mm o.c.</li> <li>• 15.9 mm Type X gypsum board</li> </ul>	[30 min] <sup>(17)</sup> [45 min] <sup>(27)</sup>	53	47
	F47e	F47 with <ul style="list-style-type: none"> <li>• no absorptive material in cavity</li> <li>• resilient metal channels spaced 400 mm o.c.</li> <li>• 12.7 mm Type X gypsum board</li> </ul>	30 min	43	44
	F47f	F47 with <ul style="list-style-type: none"> <li>• no absorptive material in cavity</li> <li>• resilient metal channels spaced 600 mm o.c.</li> <li>• 12.7 mm Type X gypsum board</li> </ul>	-	45	47
	F47g	F47 with <ul style="list-style-type: none"> <li>• absorptive material in cavity</li> <li>• resilient metal channels spaced 400 mm o.c.</li> <li>• 12.7 mm Type X gypsum board</li> </ul>	[30 min] <sup>(17)</sup> [45 min] <sup>(27)</sup>	50	43
	F47h	F47 with <ul style="list-style-type: none"> <li>• absorptive material in cavity</li> <li>• resilient metal channels spaced 600 mm o.c.</li> <li>• 12.7 mm Type X gypsum board</li> </ul>	-	52	46
	<b>F48</b>	<ul style="list-style-type: none"> <li>• one subfloor layer of 11 mm sanded plywood, or OSB or waferboard</li> <li>• one subfloor layer of 15.5 mm plywood, OSB or waferboard, or 17 mm tongue and groove lumber</li> <li>• on steel joists spaced not more than 600 mm o.c.</li> <li>• with or without absorptive material in cavity</li> <li>• resilient metal channels spaced 400 mm or 600 mm o.c.</li> <li>• 2 layers of gypsum board on ceiling side</li> </ul>	 <p style="text-align: right; font-size: small;">GC00147A</p>		
	F48a	F48 with <ul style="list-style-type: none"> <li>• no absorptive material in cavity</li> <li>• resilient metal channels spaced 400 mm o.c.</li> <li>• 15.9 mm Type X gypsum board</li> </ul>	1 h	48	39
	F48b	F48 with <ul style="list-style-type: none"> <li>• no absorptive material in cavity</li> <li>• resilient metal channels spaced 600 mm o.c.</li> <li>• 15.9 mm Type X gypsum board</li> </ul>	1 h	50	42
	F48c	F48 with <ul style="list-style-type: none"> <li>• absorptive material in cavity</li> <li>• resilient metal channels spaced 400 mm o.c.</li> <li>• 15.9 mm Type X gypsum board</li> </ul>	1 h	56	47
	F48d	F48 with <ul style="list-style-type: none"> <li>• absorptive material in cavity</li> <li>• resilient metal channels spaced 600 mm o.c.</li> <li>• 15.9 mm Type X gypsum board</li> </ul>	1 h	57	50
	F48e	F48 with <ul style="list-style-type: none"> <li>• no absorptive material in cavity</li> <li>• resilient metal channels spaced 400 mm o.c.</li> <li>• 12.7 mm Type X gypsum board</li> </ul>	1 h	47	38
	F48f	F48 with <ul style="list-style-type: none"> <li>• no absorptive material in cavity</li> <li>• resilient metal channels spaced 600 mm o.c.</li> <li>• 12.7 mm Type X gypsum board</li> </ul>	-	49	40

# Fire and Sound Resistance Tables

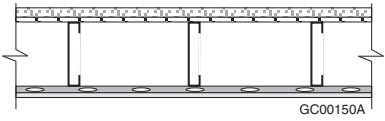
Table 9.10.3.1.-B (Continued)

Type of Assembly	Assembly Number	Description <sup>(2)(3)(4)</sup>	Fire-Resistance Rating <sup>(5)(6)(7)(8)</sup>	Typical Sound Transmission Class <sup>(5)(6)(9)(10)</sup> (STC)	Typical Impact Insulation Class <sup>(5)(9)(11)</sup> (IIC)
	F48g	F48 with <ul style="list-style-type: none"> <li>• absorptive material in cavity</li> <li>• resilient metal channels spaced 400 mm o.c.</li> <li>• 12.7 mm Type X gypsum board</li> </ul>	1 h	54	46
	F48h	F48 with <ul style="list-style-type: none"> <li>• absorptive material in cavity</li> <li>• resilient metal channels spaced 600 mm o.c.</li> <li>• 12.7 mm Type X gypsum board</li> </ul>	-	56	48
	F48i	F48 with <ul style="list-style-type: none"> <li>• no absorptive material in cavity</li> <li>• resilient metal channels spaced 400 mm o.c.</li> <li>• 12.7 mm regular gypsum board</li> </ul>	-	46	37
	F48j	F48 with <ul style="list-style-type: none"> <li>• no absorptive material in cavity</li> <li>• resilient metal channels spaced 600 mm o.c.</li> <li>• 12.7 mm regular gypsum board</li> </ul>	-	48	40
	F48k	F48 with <ul style="list-style-type: none"> <li>• absorptive material in cavity</li> <li>• resilient metal channels spaced 400 mm o.c.</li> <li>• 12.7 mm regular gypsum board</li> </ul>	-	53	45
	F48l	F48 with <ul style="list-style-type: none"> <li>• absorptive material in cavity</li> <li>• resilient metal channels spaced 600 mm o.c.</li> <li>• 12.7 mm regular gypsum board</li> </ul>	-	55	48
	<b>F49</b>	<ul style="list-style-type: none"> <li>• 25 mm gypsum-concrete topping (at least 44 kg/m<sup>2</sup>)</li> <li>• subfloor of 15.5 mm plywood, OSB or waferboard, or 17 mm tongue and groove lumber</li> <li>• on steel joists spaced not more than 600 mm o.c.</li> <li>• with or without absorptive material in cavity</li> <li>• 1 layer of gypsum board on ceiling side</li> </ul>			
	F49a	F49 with <ul style="list-style-type: none"> <li>• no absorptive material in cavity</li> <li>• 15.9 mm Type X gypsum board</li> </ul>	-	40	13
	F49b	F49 with <ul style="list-style-type: none"> <li>• absorptive material in cavity</li> <li>• 15.9 mm Type X gypsum board</li> </ul>	-	42	16
	F49c	F49 with <ul style="list-style-type: none"> <li>• no absorptive material in cavity</li> <li>• 12.7 mm Type X gypsum board</li> </ul>	-	39	12
	F49d	F49 with <ul style="list-style-type: none"> <li>• absorptive material in cavity</li> <li>• 12.7 mm Type X gypsum board</li> </ul>	-	41	15
	F49e	F49 with <ul style="list-style-type: none"> <li>• no absorptive material in cavity</li> <li>• 12.7 mm regular gypsum board</li> </ul>	-	38	12
	F49f	F49 with <ul style="list-style-type: none"> <li>• absorptive material in cavity</li> <li>• 12.7 mm regular gypsum board</li> </ul>	-	40	15
	<b>F50</b>	<ul style="list-style-type: none"> <li>• 25 mm gypsum-concrete topping (at least 44 kg/m<sup>2</sup>)</li> <li>• subfloor of 15.5 mm plywood, OSB or waferboard, or 17 mm tongue and groove lumber</li> <li>• on steel joists spaced not more than 600 mm o.c.</li> <li>• with or without absorptive material in cavity</li> <li>• 2 layers of gypsum board on ceiling side</li> </ul>			

Copyright © NRC 1941 - 2021 World Rights Reserved © CNRC 1941-2021 Droits réservés pour tous pays

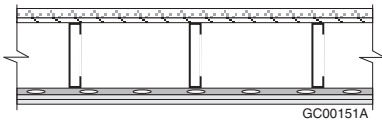
# Fire and Sound Resistance Tables

**Table 9.10.3.1.-B (Continued)**

Type of Assembly	Assembly Number	Description <sup>(2)(3)(4)</sup>	Fire-Resistance Rating <sup>(5)(6)(7)(8)</sup>	Typical Sound Transmission Class <sup>(5)(6)(9)(10)</sup> (STC)	Typical Impact Insulation Class <sup>(5)(9)(11)</sup> (IIC)
	F50a	F50 with <ul style="list-style-type: none"> <li>no absorptive material in cavity</li> <li>15.9 mm Type X gypsum board</li> </ul>	-	45	16
	F50b	F50 with <ul style="list-style-type: none"> <li>absorptive material in cavity</li> <li>15.9 mm Type X gypsum board</li> </ul>	-	47	19
	F50c	F50 with <ul style="list-style-type: none"> <li>no absorptive material in cavity</li> <li>12.7 mm Type X gypsum board</li> </ul>	-	44	15
	F50d	F50 with <ul style="list-style-type: none"> <li>absorptive material in cavity</li> <li>12.7 mm Type X gypsum board</li> </ul>	-	46	18
	F50e	F50 with <ul style="list-style-type: none"> <li>no absorptive material in cavity</li> <li>12.7 mm regular gypsum board</li> </ul>	-	43	14
	F50f	F50 with <ul style="list-style-type: none"> <li>absorptive material in cavity</li> <li>12.7 mm regular gypsum board</li> </ul>	-	45	17
	<b>F51</b>	<ul style="list-style-type: none"> <li>25 mm gypsum-concrete topping (at least 44 kg/m<sup>2</sup>)</li> <li>subfloor of 15.5 mm plywood, OSB or waferboard, or 17 mm tongue and groove lumber</li> <li>on steel joists spaced not more than 600 mm o.c.</li> <li>with or without absorptive material in cavity</li> <li>resilient metal channels spaced 400 mm or 600 mm o.c.</li> <li>1 layer of gypsum board on ceiling side</li> </ul>	 <p style="text-align: right; font-size: small;">GC00150A</p>		
	F51a	F51 with <ul style="list-style-type: none"> <li>no absorptive material in cavity</li> <li>resilient metal channels spaced 400 mm o.c.</li> <li>15.9 mm Type X gypsum board</li> </ul>	-	52	22
	F51b	F51 with <ul style="list-style-type: none"> <li>no absorptive material in cavity</li> <li>resilient metal channels spaced 600 mm o.c.</li> <li>15.9 mm Type X gypsum board</li> </ul>	-	54	22
	F51c	F51 with <ul style="list-style-type: none"> <li>absorptive material in cavity</li> <li>resilient metal channels spaced 400 mm o.c.</li> <li>15.9 mm Type X gypsum board</li> </ul>	-	59	30
	F51d	F51 with <ul style="list-style-type: none"> <li>absorptive material in cavity</li> <li>resilient metal channels spaced 600 mm o.c.</li> <li>15.9 mm Type X gypsum board</li> </ul>	-	61	30
	F51e	F51 with <ul style="list-style-type: none"> <li>no absorptive material in cavity</li> <li>resilient metal channels spaced 400 mm o.c.</li> <li>12.7 mm Type X gypsum board</li> </ul>	-	51	21
	F51f	F51 with <ul style="list-style-type: none"> <li>no absorptive material in cavity</li> <li>resilient metal channels spaced 600 mm o.c.</li> <li>12.7 mm Type X gypsum board</li> </ul>	-	53	21
	F51g	F51 with <ul style="list-style-type: none"> <li>absorptive material in cavity</li> <li>resilient metal channels spaced 400 mm o.c.</li> <li>12.7 mm Type X gypsum board</li> </ul>	-	58	29

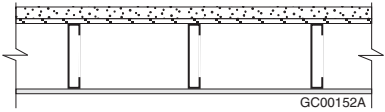
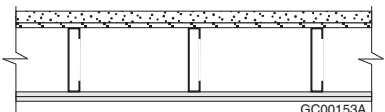
# Fire and Sound Resistance Tables

Table 9.10.3.1.-B (Continued)

Type of Assembly	Assembly Number	Description <sup>(2)(3)(4)</sup>	Fire-Resistance Rating <sup>(5)(6)(7)(8)</sup>	Typical Sound Transmission Class <sup>(5)(6)(9)(10)</sup> (STC)	Typical Impact Insulation Class <sup>(5)(9)(11)</sup> (IIC)
	F51h	F51 with <ul style="list-style-type: none"> <li>• absorptive material in cavity</li> <li>• resilient metal channels spaced 600 mm o.c.</li> <li>• 12.7 mm Type X gypsum board</li> </ul>	-	60	29
	F51i	F51 with <ul style="list-style-type: none"> <li>• no absorptive material in cavity</li> <li>• resilient metal channels spaced 400 mm o.c.</li> <li>• 12.7 mm regular gypsum board</li> </ul>	-	50	21
	F51j	F51 with <ul style="list-style-type: none"> <li>• no absorptive material in cavity</li> <li>• resilient metal channels spaced 600 mm o.c.</li> <li>• 12.7 mm regular gypsum board</li> </ul>	-	52	21
	F51k	F51 with <ul style="list-style-type: none"> <li>• absorptive material in cavity</li> <li>• resilient metal channels spaced 400 mm o.c.</li> <li>• 12.7 mm regular gypsum board</li> </ul>	-	57	29
	F51l	F51 with <ul style="list-style-type: none"> <li>• absorptive material in cavity</li> <li>• resilient metal channels spaced 600 mm o.c.</li> <li>• 12.7 mm regular gypsum board</li> </ul>	-	59	29
	<b>F52</b>	<ul style="list-style-type: none"> <li>• 25 mm gypsum-concrete topping (at least 44 kg/m<sup>2</sup>)</li> <li>• subfloor of 15.5 mm plywood, OSB or waferboard, or 17 mm tongue and groove lumber</li> <li>• on steel joists spaced not more than 600 mm o.c.</li> <li>• with or without absorptive material in cavity</li> <li>• resilient metal channels spaced 400 mm or 600 mm o.c.</li> <li>• 2 layers of gypsum board on ceiling side</li> </ul>			
	F52a	F52 with <ul style="list-style-type: none"> <li>• no absorptive material in cavity</li> <li>• resilient metal channels spaced 400 mm o.c.</li> <li>• 15.9 mm Type X gypsum board</li> </ul>	1 h	57	25
	F52b	F52 with <ul style="list-style-type: none"> <li>• no absorptive material in cavity</li> <li>• resilient metal channels spaced 600 mm o.c.</li> <li>• 15.9 mm Type X gypsum board</li> </ul>	1 h	59	25
	F52c	F52 with <ul style="list-style-type: none"> <li>• absorptive material in cavity</li> <li>• resilient metal channels spaced 400 mm o.c.</li> <li>• 15.9 mm Type X gypsum board</li> </ul>	1 h	64	33
	F52d	F52 with <ul style="list-style-type: none"> <li>• absorptive material in cavity</li> <li>• resilient metal channels spaced 600 mm o.c.</li> <li>• 15.9 mm Type X gypsum board</li> </ul>	45 min [1 h] <sup>(24)</sup>	66	33
	F52e	F52 with <ul style="list-style-type: none"> <li>• no absorptive material in cavity</li> <li>• resilient metal channels spaced 400 mm o.c.</li> <li>• 12.7 mm Type X gypsum board</li> </ul>	1 h	55	24
	F52f	F52 with <ul style="list-style-type: none"> <li>• no absorptive material in cavity</li> <li>• resilient metal channels spaced 600 mm o.c.</li> <li>• 12.7 mm Type X gypsum board</li> </ul>	1 h	58	24
	F52g	F52 with <ul style="list-style-type: none"> <li>• absorptive material in cavity</li> <li>• resilient metal channels spaced 400 mm o.c.</li> <li>• 12.7 mm Type X gypsum board</li> </ul>	1 h	62	32

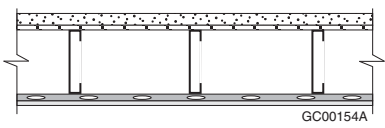
# Fire and Sound Resistance Tables

**Table 9.10.3.1.-B (Continued)**

Type of Assembly	Assembly Number	Description <sup>(2)(3)(4)</sup>	Fire-Resistance Rating <sup>(5)(6)(7)(8)</sup>	Typical Sound Transmission Class <sup>(5)(6)(9)(10)</sup> (STC)	Typical Impact Insulation Class <sup>(5)(9)(11)</sup> (IIC)
	F52h	F52 with <ul style="list-style-type: none"> <li>• absorptive material in cavity</li> <li>• resilient metal channels spaced 600 mm o.c.</li> <li>• 12.7 mm Type X gypsum board</li> </ul>	45 min [1 h] <sup>(24)</sup>	65	32
	F52i	F52 with <ul style="list-style-type: none"> <li>• no absorptive material in cavity</li> <li>• resilient metal channels spaced 400 mm o.c.</li> <li>• 12.7 mm regular gypsum board</li> </ul>	-	55	23
	F52j	F52 with <ul style="list-style-type: none"> <li>• no absorptive material in cavity</li> <li>• resilient metal channels spaced 600 mm o.c.</li> <li>• 12.7 mm regular gypsum board</li> </ul>	-	57	23
	F52k	F52 with <ul style="list-style-type: none"> <li>• absorptive material in cavity</li> <li>• resilient metal channels spaced 400 mm o.c.</li> <li>• 12.7 mm regular gypsum board</li> </ul>	-	62	31
	F52l	F52 with <ul style="list-style-type: none"> <li>• absorptive material in cavity</li> <li>• resilient metal channels spaced 600 mm o.c.</li> <li>• 12.7 mm regular gypsum board</li> </ul>	-	64	31
	<b>F53</b>	<ul style="list-style-type: none"> <li>• 38 mm concrete topping (at least 70 kg/m<sup>2</sup>)</li> <li>• subfloor of 15.5 mm plywood, OSB or waferboard, or 17 mm tongue and groove lumber</li> <li>• on steel joists spaced not more than 600 mm o.c.</li> <li>• 1 layer of gypsum board on ceiling side</li> </ul>	 <p style="text-align: right; font-size: small;">GC00152A</p>		
	F53a	F53 with <ul style="list-style-type: none"> <li>• no absorptive material in cavity</li> <li>• 15.9 mm Type X gypsum board</li> </ul>	-	44	22
	F53b	F53 with <ul style="list-style-type: none"> <li>• absorptive material in cavity</li> <li>• 15.9 mm Type X gypsum board</li> </ul>	-	46	25
	F53c	F53 with <ul style="list-style-type: none"> <li>• no absorptive material in cavity</li> <li>• 12.7 mm Type X gypsum board</li> </ul>	-	42	21
	F53d	F53 with <ul style="list-style-type: none"> <li>• absorptive material in cavity</li> <li>• 12.7 mm Type X gypsum board</li> </ul>	-	44	24
	F53e	F53 with <ul style="list-style-type: none"> <li>• no absorptive material in cavity</li> <li>• 12.7 mm regular gypsum board</li> </ul>	-	42	21
	F53f	F53 with <ul style="list-style-type: none"> <li>• absorptive material in cavity</li> <li>• 12.7 mm regular gypsum board</li> </ul>	-	44	24
	<b>F54</b>	<ul style="list-style-type: none"> <li>• 38 mm concrete topping (at least 70 kg/m<sup>2</sup>)</li> <li>• subfloor of 15.5 mm plywood, OSB or waferboard, or 17 mm tongue and groove lumber</li> <li>• on steel joists spaced not more than 600 mm o.c.</li> <li>• 2 layers of gypsum board on ceiling side</li> </ul>	 <p style="text-align: right; font-size: small;">GC00153A</p>		
	F54a	F54 with <ul style="list-style-type: none"> <li>• no absorptive material in cavity</li> <li>• 15.9 mm Type X gypsum board</li> </ul>	-	48	24
	F54b	F54 with <ul style="list-style-type: none"> <li>• absorptive material in cavity</li> <li>• 15.9 mm Type X gypsum board</li> </ul>	-	50	27

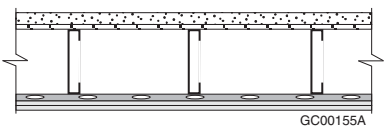
# Fire and Sound Resistance Tables

Table 9.10.3.1.-B (Continued)

Type of Assembly	Assembly Number	Description <sup>(2)(3)(4)</sup>	Fire-Resistance Rating <sup>(5)(6)(7)(8)</sup>	Typical Sound Transmission Class <sup>(5)(6)(9)(10)</sup> (STC)	Typical Impact Insulation Class <sup>(5)(9)(11)</sup> (IIC)
	F54c	F54 with <ul style="list-style-type: none"> <li>no absorptive material in cavity</li> <li>12.7 mm Type X gypsum board</li> </ul>	-	47	23
	F54d	F54 with <ul style="list-style-type: none"> <li>absorptive material in cavity</li> <li>12.7 mm Type X gypsum board</li> </ul>	-	49	26
	F54e	F54 with <ul style="list-style-type: none"> <li>no absorptive material in cavity</li> <li>12.7 mm regular gypsum board</li> </ul>	-	47	23
	F54f	F54 with <ul style="list-style-type: none"> <li>absorptive material in cavity</li> <li>12.7 mm regular gypsum board</li> </ul>	-	49	26
	<b>F55</b>	<ul style="list-style-type: none"> <li>38 mm concrete topping (at least 70 kg/m<sup>2</sup>)</li> <li>subfloor of 15.5 mm plywood, OSB or waferboard, or 17 mm tongue and groove lumber</li> <li>on steel joists spaced not more than 600 mm o.c.</li> <li>with or without absorptive material in cavity</li> <li>resilient metal channels spaced 400 mm or 600 mm o.c.</li> <li>1 layer of gypsum board on ceiling side</li> </ul>			
	F55a	F55 with <ul style="list-style-type: none"> <li>no absorptive material in cavity</li> <li>resilient metal channels spaced 400 mm o.c.</li> <li>15.9 mm Type X gypsum board</li> </ul>	-	56	31
	F55b	F55 with <ul style="list-style-type: none"> <li>no absorptive material in cavity</li> <li>resilient metal channels spaced 600 mm o.c.</li> <li>15.9 mm Type X gypsum board</li> </ul>	-	58	31
	F55c	F55 with <ul style="list-style-type: none"> <li>absorptive material in cavity</li> <li>resilient metal channels spaced 400 mm o.c.</li> <li>15.9 mm Type X gypsum board</li> </ul>	-	63	39
	F55d	F55 with <ul style="list-style-type: none"> <li>absorptive material in cavity</li> <li>resilient metal channels spaced 600 mm o.c.</li> <li>15.9 mm Type X gypsum board</li> </ul>	-	65	39
	F55e	F55 with <ul style="list-style-type: none"> <li>no absorptive material in cavity</li> <li>resilient metal channels spaced 400 mm o.c.</li> <li>12.7 mm Type X gypsum board</li> </ul>	-	54	30
	F55f	F55 with <ul style="list-style-type: none"> <li>no absorptive material in cavity</li> <li>resilient metal channels spaced 600 mm o.c.</li> <li>12.7 mm Type X gypsum board</li> </ul>	-	56	30
	F55g	F55 with <ul style="list-style-type: none"> <li>absorptive material in cavity</li> <li>resilient metal channels spaced 400 mm o.c.</li> <li>12.7 mm Type X gypsum board</li> </ul>	-	61	38
	F55h	F55 with <ul style="list-style-type: none"> <li>absorptive material in cavity</li> <li>resilient metal channels spaced 600 mm o.c.</li> <li>12.7 mm Type X gypsum board</li> </ul>	-	63	38
	F55i	F55 with <ul style="list-style-type: none"> <li>no absorptive material in cavity</li> <li>resilient metal channels spaced 400 mm o.c.</li> <li>12.7 mm regular gypsum board</li> </ul>	-	54	30

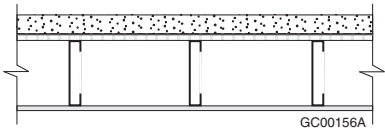
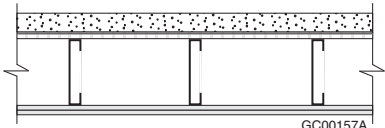
# Fire and Sound Resistance Tables

**Table 9.10.3.1.-B (Continued)**

Type of Assembly	Assembly Number	Description <sup>(2)(3)(4)</sup>	Fire-Resistance Rating <sup>(5)(6)(7)(8)</sup>	Typical Sound Transmission Class <sup>(5)(6)(9)(10)</sup> (STC)	Typical Impact Insulation Class <sup>(5)(9)(11)</sup> (IIC)
	F55j	F55 with <ul style="list-style-type: none"> <li>• no absorptive material in cavity</li> <li>• resilient metal channels spaced 600 mm o.c.</li> <li>• 12.7 mm regular gypsum board</li> </ul>	-	56	30
	F55k	F55 with <ul style="list-style-type: none"> <li>• absorptive material in cavity</li> <li>• resilient metal channels spaced 400 mm o.c.</li> <li>• 12.7 mm regular gypsum board</li> </ul>	-	61	38
	F55l	F55 with <ul style="list-style-type: none"> <li>• absorptive material in cavity</li> <li>• resilient metal channels spaced 600 mm o.c.</li> <li>• 12.7 mm regular gypsum board</li> </ul>	-	63	38
	<b>F56</b>	<ul style="list-style-type: none"> <li>• 38 mm concrete topping (at least 70 kg/m<sup>2</sup>)</li> <li>• subfloor of 15.5 mm plywood, OSB or waferboard, or 17 mm tongue and groove lumber</li> <li>• on steel joists spaced not more than 600 mm o.c.</li> <li>• with or without absorptive material in cavity</li> <li>• resilient metal channels spaced 400 mm or 600 mm o.c.</li> <li>• 2 layers of gypsum board on ceiling side</li> </ul>			
	F56a	F56 with <ul style="list-style-type: none"> <li>• no absorptive material in cavity</li> <li>• resilient metal channels spaced 400 mm o.c.</li> <li>• 15.9 mm Type X gypsum board</li> </ul>	1 h	60	33
	F56b	F56 with <ul style="list-style-type: none"> <li>• no absorptive material in cavity</li> <li>• resilient metal channels spaced 600 mm o.c.</li> <li>• 15.9 mm Type X gypsum board</li> </ul>	1 h	62	33
	F56c	F56 with <ul style="list-style-type: none"> <li>• absorptive material in cavity</li> <li>• resilient metal channels spaced 400 mm o.c.</li> <li>• 15.9 mm Type X gypsum board</li> </ul>	1 h	67	41
	F56d	F56 with <ul style="list-style-type: none"> <li>• absorptive material in cavity</li> <li>• resilient metal channels spaced 600 mm o.c.</li> <li>• 15.9 mm Type X gypsum board</li> </ul>	45 min [1 h] <sup>(24)</sup>	69	41
	F56e	F56 with <ul style="list-style-type: none"> <li>• no absorptive material in cavity</li> <li>• resilient metal channels spaced 400 mm o.c.</li> <li>• 12.7 mm Type X gypsum board</li> </ul>	1 h	59	32
	F56f	F56 with <ul style="list-style-type: none"> <li>• no absorptive material in cavity</li> <li>• resilient metal channels spaced 600 mm o.c.</li> <li>• 12.7 mm Type X gypsum board</li> </ul>	1 h	61	32
	F56g	F56 with <ul style="list-style-type: none"> <li>• absorptive material in cavity</li> <li>• resilient metal channels spaced 400 mm o.c.</li> <li>• 12.7 mm Type X gypsum board</li> </ul>	1 h	66	40
	F56h	F56 with <ul style="list-style-type: none"> <li>• absorptive material in cavity</li> <li>• resilient metal channels spaced 600 mm o.c.</li> <li>• 12.7 mm Type X gypsum board</li> </ul>	45 min [1 h] <sup>(24)</sup>	68	40
	F56i	F56 with <ul style="list-style-type: none"> <li>• no absorptive material in cavity</li> <li>• resilient metal channels spaced 400 mm o.c.</li> <li>• 12.7 mm regular gypsum board</li> </ul>	-	58	32

# Fire and Sound Resistance Tables

Table 9.10.3.1.-B (Continued)

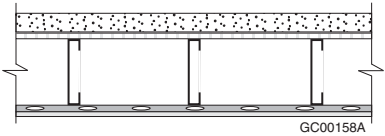
Type of Assembly	Assembly Number	Description <sup>(2)(3)(4)</sup>	Fire-Resistance Rating <sup>(5)(6)(7)(8)</sup>	Typical Sound Transmission Class <sup>(5)(6)(9)(10)</sup> (STC)	Typical Impact Insulation Class <sup>(5)(9)(11)</sup> (IIC)
	F56j	F56 with <ul style="list-style-type: none"> <li>no absorptive material in cavity</li> <li>resilient metal channels spaced 600 mm o.c.</li> <li>12.7 mm regular gypsum board</li> </ul>	-	61	32
	F56k	F56 with <ul style="list-style-type: none"> <li>absorptive material in cavity</li> <li>resilient metal channels spaced 400 mm o.c.</li> <li>12.7 mm regular gypsum board</li> </ul>	-	65	40
	F56l	F56 with <ul style="list-style-type: none"> <li>absorptive material in cavity</li> <li>resilient metal channels spaced 600 mm o.c.</li> <li>12.7 mm regular gypsum board</li> </ul>	-	68	40
	<b>F57</b>	<ul style="list-style-type: none"> <li>50 mm concrete</li> <li>0.46 mm metal pan with 19 mm rib</li> <li>on steel joists spaced not more than 600 mm o.c.</li> <li>1 layer of gypsum board on ceiling side</li> </ul>	 GC00156A		
	F57a	F57 with <ul style="list-style-type: none"> <li>no absorptive material in cavity</li> <li>15.9 mm Type X gypsum board</li> </ul>	-	45	26
	F57b	F57 with <ul style="list-style-type: none"> <li>absorptive material in cavity</li> <li>15.9 mm Type X gypsum board</li> </ul>	-	47	29
	F57c	F57 with <ul style="list-style-type: none"> <li>no absorptive material in cavity</li> <li>12.7 mm Type X gypsum board</li> </ul>	-	44	25
	F57d	F57 with <ul style="list-style-type: none"> <li>absorptive material in cavity</li> <li>12.7 mm Type X gypsum board</li> </ul>	-	46	28
	F57e	F57 with <ul style="list-style-type: none"> <li>no absorptive material in cavity</li> <li>12.7 mm regular gypsum board</li> </ul>	-	43	25
	F57f	F57 with <ul style="list-style-type: none"> <li>absorptive material in cavity</li> <li>12.7 mm regular gypsum board</li> </ul>	-	45	28
	<b>F58</b>	<ul style="list-style-type: none"> <li>50 mm concrete</li> <li>0.38 mm metal pan with 16 mm rib</li> <li>on steel joists spaced not more than 600 mm o.c.</li> <li>2 layers of gypsum board on ceiling side</li> </ul>	 GC00157A		
	F58a	F58 with <ul style="list-style-type: none"> <li>no absorptive material in cavity</li> <li>15.9 mm Type X gypsum board</li> </ul>	-	50	27
	F58b	F58 with <ul style="list-style-type: none"> <li>absorptive material in cavity</li> <li>15.9 mm Type X gypsum board</li> </ul>	-	52	30
	F58c	F58 with <ul style="list-style-type: none"> <li>no absorptive material in cavity</li> <li>12.7 mm Type X gypsum board</li> </ul>	-	48	27
	F58d	F58 with <ul style="list-style-type: none"> <li>absorptive material in cavity</li> <li>12.7 mm Type X gypsum board</li> </ul>	-	50	30

Copyright © NRC 1941 - 2021 World Rights Reserved © CNRC 1941-2021 Droits réservés pour tous pays



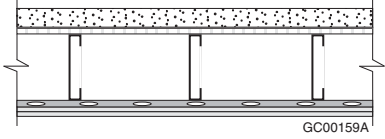
# Fire and Sound Resistance Tables

**Table 9.10.3.1.-B (Continued)**

Type of Assembly	Assembly Number	Description <sup>(2)(3)(4)</sup>	Fire-Resistance Rating <sup>(5)(6)(7)(8)</sup>	Typical Sound Transmission Class <sup>(5)(6)(9)(10)</sup> (STC)	Typical Impact Insulation Class <sup>(5)(9)(11)</sup> (IIC)
	F58e	F58 with <ul style="list-style-type: none"> <li>• no absorptive material in cavity</li> <li>• 12.7 mm regular gypsum board</li> </ul>	-	48	27
	F58f	F58 with <ul style="list-style-type: none"> <li>• absorptive material in cavity</li> <li>• 12.7 mm regular gypsum board</li> </ul>	-	50	30
	<b>F59</b>	<ul style="list-style-type: none"> <li>• 50 mm concrete</li> <li>• 0.38 mm metal pan with 16 mm rib</li> <li>• on steel joists spaced not more than 600 mm o.c.</li> <li>• with or without absorptive material in cavity</li> <li>• resilient metal channels spaced 400 mm or 600 mm o.c.</li> <li>• 1 layer of gypsum board on ceiling side</li> </ul>			
	F59a	F59 with <ul style="list-style-type: none"> <li>• no absorptive material in cavity</li> <li>• resilient metal channels spaced 400 mm o.c.</li> <li>• 15.9 mm Type X gypsum board</li> </ul>	-	57	35
	F59b	F59 with <ul style="list-style-type: none"> <li>• no absorptive material in cavity</li> <li>• resilient metal channels spaced 600 mm o.c.</li> <li>• 15.9 mm Type X gypsum board</li> </ul>	-	59	35
	F59c	F59 with <ul style="list-style-type: none"> <li>• absorptive material in cavity</li> <li>• resilient metal channels spaced 400 mm o.c.</li> <li>• 15.9 mm Type X gypsum board</li> </ul>	-	64	43
	F59d	F59 with <ul style="list-style-type: none"> <li>• absorptive material in cavity</li> <li>• resilient metal channels spaced 600 mm o.c.</li> <li>• 15.9 mm Type X gypsum board</li> </ul>	-	66	43
	F59e	F59 with <ul style="list-style-type: none"> <li>• no absorptive material in cavity</li> <li>• resilient metal channels spaced 400 mm o.c.</li> <li>• 12.7 mm Type X gypsum board</li> </ul>	-	56	34
	F59f	F59 with <ul style="list-style-type: none"> <li>• no absorptive material in cavity</li> <li>• resilient metal channels spaced 600 mm o.c.</li> <li>• 12.7 mm Type X gypsum board</li> </ul>	-	56	34
	F59g	F59 with <ul style="list-style-type: none"> <li>• absorptive material in cavity</li> <li>• resilient metal channels spaced 400 mm o.c.</li> <li>• 12.7 mm Type X gypsum board</li> </ul>	-	63	42
	F59h	F59 with <ul style="list-style-type: none"> <li>• absorptive material in cavity</li> <li>• resilient metal channels spaced 600 mm o.c.</li> <li>• 12.7 mm Type X gypsum board</li> </ul>	-	65	42
	F59i	F59 with <ul style="list-style-type: none"> <li>• no absorptive material in cavity</li> <li>• resilient metal channels spaced 400 mm o.c.</li> <li>• 12.7 mm regular gypsum board</li> </ul>	-	55	34
	F59j	F59 with <ul style="list-style-type: none"> <li>• no absorptive material in cavity</li> <li>• resilient metal channels spaced 600 mm o.c.</li> <li>• 12.7 mm regular gypsum board</li> </ul>	-	57	34

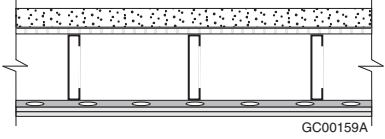
# Fire and Sound Resistance Tables

Table 9.10.3.1.-B (Continued)

Type of Assembly	Assembly Number	Description <sup>(2)(3)(4)</sup>	Fire-Resistance Rating <sup>(5)(6)(7)(8)</sup>	Typical Sound Transmission Class <sup>(5)(6)(9)(10)</sup> (STC)	Typical Impact Insulation Class <sup>(5)(9)(11)</sup> (IIC)
	F59k	F59 with <ul style="list-style-type: none"> <li>• absorptive material in cavity</li> <li>• resilient metal channels spaced 400 mm o.c.</li> <li>• 12.7 mm regular gypsum board</li> </ul>	-	62	42
	F59l	F59 with <ul style="list-style-type: none"> <li>• absorptive material in cavity</li> <li>• resilient metal channels spaced 600 mm o.c.</li> <li>• 12.7 mm regular gypsum board</li> </ul>	-	64	42
	F60	<ul style="list-style-type: none"> <li>• 50 mm concrete</li> <li>• 0.46 mm metal pan with a 19 mm rib</li> <li>• on steel joists spaced not more than 600 mm o.c.</li> <li>• with or without absorptive material in cavity</li> <li>• resilient metal channels spaced 400 mm or 600 mm o.c.</li> <li>• 2 layers of gypsum board on ceiling side</li> </ul>			
	F60a	F60 with <ul style="list-style-type: none"> <li>• no absorptive material in cavity</li> <li>• resilient metal channels spaced 400 mm o.c.</li> <li>• 15.9 mm Type X gypsum board</li> </ul>	1 h	62	36
	F60b	F60 with <ul style="list-style-type: none"> <li>• no absorptive material in cavity</li> <li>• resilient metal channels spaced 600 mm o.c.</li> <li>• 15.9 mm Type X gypsum board</li> </ul>	1 h	64	36
	F60c	F60 with <ul style="list-style-type: none"> <li>• absorptive material in cavity</li> <li>• resilient metal channels spaced 400 mm o.c.</li> <li>• 15.9 mm Type X gypsum board</li> </ul>	1 h	69	44
	F60d	F60 with <ul style="list-style-type: none"> <li>• absorptive material in cavity</li> <li>• resilient metal channels spaced 600 mm o.c.</li> <li>• 15.9 mm Type X gypsum board</li> </ul>	45 min [1 h] <sup>(24)</sup>	71	44
	F60e	F60 with <ul style="list-style-type: none"> <li>• no absorptive material in cavity</li> <li>• resilient metal channels spaced 400 mm o.c.</li> <li>• 12.7 mm Type X gypsum board</li> </ul>	1h	60	36
	F60f	F60 with <ul style="list-style-type: none"> <li>• no absorptive material in cavity</li> <li>• resilient metal channels spaced 600 mm o.c.</li> <li>• 12.7 mm Type X gypsum board</li> </ul>	1 h	62	36
	F60g	F60 with <ul style="list-style-type: none"> <li>• absorptive material in cavity</li> <li>• resilient metal channels spaced 400 mm o.c.</li> <li>• 12.7 mm Type X gypsum board</li> </ul>	1 h	67	44
	F60h	F60 with <ul style="list-style-type: none"> <li>• absorptive material in cavity</li> <li>• resilient metal channels spaced 600 mm o.c.</li> <li>• 12.7 mm Type X gypsum board</li> </ul>	45 min [1 h] <sup>(24)</sup>	69	44
	F60i	F60 with <ul style="list-style-type: none"> <li>• no absorptive material in cavity</li> <li>• resilient metal channels spaced 400 mm o.c.</li> <li>• 12.7 mm regular gypsum board</li> </ul>	-	60	36
	F60j	F60 with <ul style="list-style-type: none"> <li>• no absorptive material in cavity</li> <li>• resilient metal channels spaced 600 mm o.c.</li> <li>• 12.7 mm regular gypsum board</li> </ul>	-	62	36

# Fire and Sound Resistance Tables

**Table 9.10.3.1.-B (Continued)**

Type of Assembly	Assembly Number	Description <sup>(2)(3)(4)</sup>	Fire-Resistance Rating <sup>(5)(6)(7)(8)</sup>	Typical Sound Transmission Class <sup>(5)(6)(9)(10)</sup> (STC)	Typical Impact Insulation Class <sup>(5)(9)(11)</sup> (IIC)
	F60k	F60 with <ul style="list-style-type: none"> <li>• absorptive material in cavity</li> <li>• resilient metal channels spaced 400 mm o.c.</li> <li>• 12.7 mm regular gypsum board</li> </ul>	-	67	44
	F60l	F60 with <ul style="list-style-type: none"> <li>• absorptive material in cavity</li> <li>• resilient metal channels spaced 600 mm o.c.</li> <li>• 12.7 mm regular gypsum board</li> </ul>	-	69	44
	<b>F61</b>	<ul style="list-style-type: none"> <li>• 50 mm concrete</li> <li>• 0.38 mm metal pan with 16 mm rib</li> <li>• on steel joists spaced not more than 600 mm o.c.</li> <li>• with or without absorptive material in cavity</li> <li>• resilient metal channels spaced 400 mm or 600 mm o.c.</li> <li>• 2 layers of gypsum board on ceiling side</li> </ul>			
	F61a	F61 with <ul style="list-style-type: none"> <li>• no absorptive material in cavity</li> <li>• resilient metal channels spaced 400 mm o.c.</li> <li>• 15.9 mm Type X gypsum board</li> </ul>	1 h	62	32
	F61b	F61 with <ul style="list-style-type: none"> <li>• steel joists spaced 400 mm o.c.</li> <li>• no absorptive material in cavity</li> <li>• resilient metal channels spaced 600 mm o.c.</li> <li>• 15.9 mm Type X gypsum board</li> </ul>	1 h	64	32
	F61c	F61 with <ul style="list-style-type: none"> <li>• steel joists spaced 600 mm o.c.</li> <li>• no absorptive material in cavity</li> <li>• resilient metal channels spaced 600 mm o.c.</li> <li>• 15.9 mm Type X gypsum board</li> </ul>	-	65	29
	F61d	F61 with <ul style="list-style-type: none"> <li>• absorptive material in cavity</li> <li>• resilient metal channels spaced 400 mm o.c.</li> <li>• 15.9 mm Type X gypsum board</li> </ul>	1 h	68	37
	F61e	F61 with <ul style="list-style-type: none"> <li>• steel joists spaced 400 mm o.c.</li> <li>• absorptive material in cavity</li> <li>• resilient metal channels spaced 600 mm o.c.</li> <li>• 15.9 mm Type X gypsum board</li> </ul>	1h	66	34
	F61f	F61 with <ul style="list-style-type: none"> <li>• steel joists spaced 600 mm o.c.</li> <li>• absorptive material in cavity</li> <li>• resilient metal channels spaced 600 mm o.c.</li> <li>• 15.9 mm Type X gypsum board</li> </ul>	-	71	34
	F61g	F61 with <ul style="list-style-type: none"> <li>• no absorptive material in cavity</li> <li>• resilient metal channels spaced 400 mm o.c.</li> <li>• 12.7 mm Type X gypsum board</li> </ul>	1 h	62	32
	F61h	F61 with <ul style="list-style-type: none"> <li>• steel joists spaced 400 mm o.c.</li> <li>• no absorptive material in cavity</li> <li>• resilient metal channels spaced 600 mm o.c.</li> <li>• 12.7 mm Type X gypsum board</li> </ul>	1 h	64	32
	F61i	F61 with <ul style="list-style-type: none"> <li>• steel joists spaced 600 mm o.c.</li> <li>• no absorptive material in cavity</li> <li>• resilient metal channels spaced 600 mm o.c.</li> <li>• 12.7 mm Type X gypsum board</li> </ul>	-	64	28

# Fire and Sound Resistance Tables

Table 9.10.3.1.-B (Continued)

Type of Assembly	Assembly Number	Description <sup>(2)(3)(4)</sup>	Fire-Resistance Rating <sup>(5)(6)(7)(8)</sup>	Typical Sound Transmission Class <sup>(5)(6)(9)(10)</sup> (STC)	Typical Impact Insulation Class <sup>(5)(9)(11)</sup> (IIC)
	F61j	F61 with <ul style="list-style-type: none"> <li>• absorptive material in cavity</li> <li>• resilient metal channels spaced 400 mm o.c.</li> <li>• 12.7 mm Type X gypsum board</li> </ul>	1 h	68	36
	F61k	F61 with <ul style="list-style-type: none"> <li>• steel joists spaced 400 mm o.c.</li> <li>• absorptive material in cavity</li> <li>• resilient metal channels spaced 600 mm o.c.</li> <li>• 12.7 mm Type X gypsum board</li> </ul>	1 h	64	32
	F61l	F61 with <ul style="list-style-type: none"> <li>• steel joists spaced 600 mm o.c.</li> <li>• no absorptive material in cavity</li> <li>• resilient metal channels spaced 600 mm o.c.</li> <li>• 12.7 mm Type X gypsum board</li> </ul>	-	70	34
<b>Roofs</b>					
Wood Roof Trusses	R1	<ul style="list-style-type: none"> <li>• wood trusses spaced not more than 600 mm o.c.</li> <li>• 1 layer 15.9 mm Type X gypsum board</li> </ul>	45 min	-	-
<b>Rating Provided by Membrane Only</b>					
	M1	<ul style="list-style-type: none"> <li>• supporting members spaced not more than 600 mm o.c.</li> <li>• 1 layer 15.9 mm Type X gypsum board</li> </ul>	30 min	-	-
	M2	<ul style="list-style-type: none"> <li>• supporting members spaced not more than 600 mm o.c.</li> <li>• 2 layers 15.9 mm Type X gypsum board</li> </ul>	1 h	-	-

## Notes to Table 9.10.3.1.-B:

- (1) See Note A-9.10.3.1.
- (2) For assemblies with a ceiling consisting of a single layer of gypsum board on resilient metal channels to obtain the listed ratings, the resilient metal channel arrangement at the gypsum board butt end joints should be as shown in Figure A-9.10.3.1.-A.
- (3) For assemblies with a ceiling consisting of 2 layers of gypsum board on resilient metal channels to obtain the listed ratings, the fastener and resilient metal channel arrangement at the gypsum board butt end joints should be as shown in Figure A-9.10.3.1.-B.
- (4) The *fire-resistance rating* and *sound transmission class* values given are for a minimum thickness of subfloor or deck as shown. Minimum subfloor thickness required is determined by structural member spacing (see Table 9.23.15.5.-A). Thicker subflooring or decking is also acceptable.
- (5) Sound absorptive material includes
  - (i) fibre processed from rock, slag, or glass, and
  - (ii) loose-fill or spray-applied cellulose fibre.

To obtain the listed *sound transmission class* rating, the nominal insulation thickness is 150 mm for rock, slag, or glass fibres or loose-fill cellulose fibre, and 90 mm for spray-applied cellulose fibre, unless otherwise specified. Absorptive material will affect the *sound transmission class* by approximately adding or subtracting 1 per 50 mm change of thickness. However, no additional *sound transmission class* value is achieved by adding a greater thickness of insulation than the depth of the assembly.
- (6) The *fire-resistance rating* and *sound transmission class* values are based on the spacing of ceiling supports as noted. (See also Table Note (10).) A narrower spacing will be detrimental to the *sound transmission class* rating, but not to the *fire-resistance rating*.
- (7) To obtain the listed rating, the type and spacing of fasteners are as described in and installed in accordance with Subsection 9.29.5. or CSA A82.31-M:
  - (i) fastener distance to board edges and butt ends should be not less than 38 mm, except for fasteners on the butt ends of the base layer in ceilings with two layers (see Figure A-9.10.3.1.-B); and
  - (ii) fasteners are spaced not more than 300 mm o.c.
- (8) See D-1.2.1.(2) in Appendix D for the significance of *fire-resistance ratings*.
- (9) The *sound transmission class* values given in the Table are for the minimum depth of structural member noted in the description and applicable table notes. To obtain *sound transmission class* values for structural members deeper than that minimum, add 1 to the *sound transmission class* value in the Table for each 170 mm increase in structural member depth.
- (10) The *sound transmission class* values given in the Table are for structural member spacing of 300 mm o.c., unless otherwise noted in the description and applicable table notes. To obtain *sound transmission class* values for assemblies with structural members spaced more than 500 mm o.c., add 1 to the *sound transmission class* value in the Table.
- (11) The impact insulation class values given are for floor assemblies tested with no finished flooring.
- (12) Wood floor joists are:

# Fire and Sound Resistance Tables

Table 9.10.3.1.-B (Continued)

- (i) wood joists with a minimum member size of 38 mm (width) x 235 mm (depth), except as otherwise noted (see Table Note (15)); or
  - (ii) wood I-joists with a minimum flange size of 38 mm x 38 mm, a minimum OSB or plywood web thickness of 9.5 mm, and a minimum joist depth of 241 mm.
- (13) Except where assemblies with wood I-joists are tested according to CAN/ULC-S101 the *fire-resistance rating* values apply only to I-joists that have been fabricated with a phenolic-based structural wood adhesive complying with CSA O112.10. For I-joists with flanges made of laminated veneer lumber (LVL), the *fire-resistance rating* values apply only where the adhesive used in the LVL fabrication is a phenolic-based structural wood adhesive complying with CSA O112.9.
- (14) The *fire-resistance rating* value within square brackets is achieved only where absorptive material includes spray-applied cellulose fibre with
- (i) adhesive that is capable of providing a minimum cohesive/adhesive bond strength per unit area of 5 times the weight of the material under the test plate when tested in accordance with ASTM E 736,
  - (ii) a minimum density of 35 kg/m<sup>3</sup>, and
  - (iii) a minimum thickness of 90 mm on the underside of the subfloor or deck, of 90 mm on the sides of the structural members, and for cold-formed steel joists, of 13 mm on the underside of the bottom flange other than at resilient metal channel locations.
- (15) The *fire-resistance rating* value within square brackets only applies to assemblies with solid wood joists and is achieved only where absorptive material includes:
- (i) fibre processed from rock or slag with a minimum thickness of 90 mm and a minimum surface area mass of 2.8 kg/m<sup>2</sup>; or
  - (ii) spray-applied cellulose fibre with a minimum density of 50 kg/m<sup>3</sup> and a minimum depth of 90 mm on the underside of the subfloor and of 90 mm on the sides of the floor joists.
- (16) The *fire-resistance rating*, *sound transmission class* and impact insulation class values given are also applicable to assemblies with 38 mm (width) x 184 mm (depth) solid wood joists.
- (17) The *fire-resistance rating* value within square brackets is achieved only where absorptive material includes:
- (i) fibre processed from rock or slag with a minimum thickness of 90 mm and a minimum surface area mass of 2.8 kg/m<sup>2</sup>; or
  - (ii) spray-applied cellulose fibre with a minimum density of 50 kg/m<sup>3</sup> and a minimum depth of 90 mm on the underside of the subfloor and of 90 mm on the webs or the sides of the structural members.
- (18) The *fire-resistance rating*, *sound transmission class* and impact insulation class values within the square brackets only apply to assemblies with solid wood joists and are achieved only where absorptive material includes dry-blown cellulose fibre with a minimum density of 40 kg/m<sup>3</sup> filling the entire cavity; the cellulose fibre is supported on zinc-coated (galvanized) steel poultry fence fabric conforming to ASTM A 390, which has 25-mm-wide hexagonal mesh openings and 0.81-mm-thick (20-gauge) wire and is attached to wood joists with metal staples having legs that are 50 mm long.
- (19) The *fire-resistance rating* and *sound transmission class* values are achieved only where absorptive material includes:
- (i) fibre processed from rock or slag that fills the joist cavity and has a minimum surface area mass of 2.8 kg/m<sup>2</sup>, and for structural members at least 270 mm in depth, the fibre includes three layers each of which has a minimum thickness of 90 mm; or
  - (ii) dry-blown cellulose fibre with a minimum density of 40 kg/m<sup>3</sup> filling the entire cavity; the cellulose fibre is supported on zinc-coated (galvanized) steel poultry fence fabric conforming to ASTM A 390, which has 25-mm-wide hexagonal mesh openings and 0.81-mm-thick (20-gauge) wire and is attached to wood joists or wood I-joists with metal staples having legs that are 50 mm or 30 mm long, respectively.
- (20) The *fire-resistance rating* value only applies to assemblies with wood I-joists with flanges with a minimum thickness of 38 mm and a minimum width of 63 mm.
- (21) The *fire-resistance rating* and *sound transmission class* values are achieved only where absorptive material includes:
- (i) fibre processed from rock or slag that fills the joist cavity and has a minimum surface area mass of 2.8 kg/m<sup>2</sup>, and for structural members at least 270 mm in depth, the fibre includes three layers each of which has a minimum thickness of 90 mm; or
  - (ii) dry-blown cellulose fibre with a minimum density of 40 kg/m<sup>3</sup> filling the entire cavity; the cellulose fibre is supported on zinc-coated (galvanized) steel poultry fence fabric conforming to ASTM A 390, which has 25-mm-wide hexagonal mesh openings and 0.81-mm-thick (20-gauge) wire and is attached to wood joists with metal staples having legs that are 50 mm long.
- (22) The *fire-resistance rating* values given only apply to assemblies with solid wood joists spaced not more than 400 mm o.c. No information is available for assemblies constructed with wood I-joists.
- (23) Wood floor trusses are:
- (i) metal-plate-connected wood trusses with wood framing members not less than 38 mm x 64 mm, metal connector plates not less than 1 mm (nominal) thick with teeth not less than 8 mm long, and a minimum truss depth of 305 mm;
  - (ii) metal-web wood trusses with wood chords not less than 38 mm x 64 mm, V-shaped webs made from galvanized steel of 1 mm (nominal) thickness with plate areas having teeth not less than 8 mm long, and a minimum truss depth of 286 mm; or
  - (iii) fingerjoined wood trusses with glued fingerjoined connections, chord members not less than 38 mm x 64 mm, web members not less than 38 mm x 38 mm and a minimum truss depth of 330 mm, all of which is glued together with an R-14 phenol-resorcinol resin conforming to CSA O112.10.
- (24) The *fire-resistance rating* value within square brackets is achieved only where absorptive material includes fibre processed from rock or slag with a minimum thickness of 90 mm and a minimum surface area mass of 2.8 kg/m<sup>2</sup>.
- (25) The *fire-resistance rating* and *sound transmission class* values within square brackets are achieved only where absorptive material includes dry-blown cellulose fibre with a minimum density of 40 kg/m<sup>3</sup> filling the entire cavity; the cellulose fibre is supported on zinc-coated (galvanized) steel poultry fence fabric conforming to ASTM A 390, which has 25-mm-wide hexagonal mesh openings and 0.81-mm-thick (20-gauge) wire and is attached to wood trusses with metal staples having legs that are 38 mm long.

---

## **Fire and Sound Resistance Tables**

**Table 9.10.3.1.-B (Continued)**

- <sup>(26)</sup> Cold-formed steel floor joists (C-shaped joists) are members with a minimum size of 41 mm (width) x 203 mm (depth) x 1.22 mm (material thickness).
- <sup>(27)</sup> The *fire-resistance rating* value within square brackets is achieved only where absorptive material includes spray-applied cellulose fibre with a minimum density of 50 kg/m<sup>3</sup> and a minimum thickness of 90 mm on the underside of the subfloor, of 90 mm on the sides of the cold-formed steel floor joists, and of 13 mm on the underside of the bottom flange other than at resilient metal channel locations.



# Span Tables

## Span Tables

**Table 9.20.17.4.-A**  
**Maximum Allowable Clear Spans for Lintels in Flat Loadbearing Insulating Concrete Form (ICF) Walls<sup>(1)(2)(3)</sup> (1-10M Bottom Bar)**  
 Forming Part of Sentences 9.3.2.8.(1) and 9.20.17.4.(3)

Minimum Lintel Thickness, mm	Minimum Lintel Depth, mm	Maximum Clear Span, m			
		Supporting Light-Frame Roof Only		Supporting ICF Second Storey and Light-Frame Roof	
		Maximum Ground Snow Load, kN/m <sup>2</sup>			
		1.50	3.33	1.50	3.33
140	200	1.41	1.18	1.03	0.93
	300	1.78	1.50	1.30	1.18
	400	2.08	1.75	1.53	1.38
	500	2.33	1.97	1.72	1.56
	600	2.55	2.16	1.89	1.71
150	200	1.41	1.18	1.02	0.92
	300	1.78	1.50	1.29	1.17
	400	2.08	1.75	1.51	1.37
	500	2.33	1.97	1.70	1.54
	600	2.54	2.15	1.87	1.70
160	200	1.41	1.18	1.01	0.91
	300	1.78	1.50	1.28	1.16
	400	2.07	1.75	1.50	1.36
	500	2.32	1.96	1.68	1.53
	600	2.53	2.15	1.85	1.68
190	200	1.41	1.19	0.98	0.89
	300	1.78	1.50	1.24	1.13
	400	2.06	1.74	1.45	1.32
	500	2.30	1.95	1.63	1.49
	600	2.51	2.13	1.78	1.63
200	200	1.41	1.19	0.97	0.89
	300	1.77	1.49	1.23	1.12
	400	2.06	1.74	1.43	1.31
	500	2.30	1.95	1.61	1.48
	600	2.50	2.13	1.77	1.62
240	200	1.41	1.19	0.94	0.86
	300	1.76	1.49	1.18	1.09
	400	2.04	1.73	1.38	1.27
	500	2.27	1.93	1.55	1.43
	600	2.47	2.11	1.70	1.56

### Notes to Table 9.20.17.4.-A:

- (1) Deflection criterion is  $L/240$ , where "L" is the clear span of the lintel.
- (2) Linear interpolation is permitted between ground snow loads and between lintel depths.
- (3) 10M stirrups are required at a maximum  $d/2$  spacing for spans greater than 1 200 mm, where "d" is the distance from the top of the lintel to the level of the bottom reinforcing bar in the lintel.



**Table 9.20.17.4.-B**  
**Maximum Allowable Clear Spans for Lintels in Flat Loadbearing Insulating Concrete Form (ICF) Walls<sup>(1)(2)(3)</sup> (1-15M Bottom Bar)**  
 Forming Part of Sentences 9.3.2.8.(1) and 9.20.17.4.(3)

Minimum Lintel Thickness, mm	Minimum Lintel Depth, mm	Maximum Clear Span, m			
		Supporting Light-Frame Roof Only		Supporting ICF Second Storey and Light-Frame Roof	
		Maximum Ground Snow Load, kN/m <sup>2</sup>			
		1.50	3.33	1.50	3.33
140	200	1.63	1.46	1.31	1.23
	300	2.43	2.08	1.81	1.64
	400	2.90	2.44	2.13	1.93
	500	3.26	2.75	2.41	2.18
	600	3.58	3.03	2.65	2.4
150	200	1.67	1.49	1.33	1.25
	300	2.48	2.08	1.79	1.62
	400	2.90	2.44	2.11	1.91
	500	3.26	2.75	2.38	2.16
	600	3.57	3.02	2.62	2.38
160	200	1.70	1.53	1.35	1.26
	300	2.48	2.08	1.78	1.61
	400	2.90	2.44	2.09	1.90
	500	3.25	2.75	2.36	2.14
	600	3.56	3.02	2.59	2.36
190	200	1.80	1.61	1.36	1.24
	300	2.48	2.09	1.73	1.58
	400	2.89	2.44	2.03	1.85
	500	3.23	2.74	2.29	2.09
	600	3.53	3.00	2.51	2.30
200	200	1.83	1.64	1.35	1.23
	300	2.48	2.09	1.71	1.57
	400	2.88	2.44	2.01	1.84
	500	3.22	2.74	2.26	2.07
	600	3.52	2.99	2.48	2.28
240	200	1.93	1.65	1.30	1.20
	300	2.47	2.08	1.66	1.52
	400	2.86	2.43	1.94	1.78
	500	3.19	2.72	2.18	2.01
	600	3.47	2.97	2.39	2.20

**Notes to Table 9.20.17.4.-B:**

- (1) Deflection criterion is  $L/240$ , where "L" is the clear span of the lintel.
- (2) Linear interpolation is permitted between ground snow loads and between lintel depths.
- (3) 10M stirrups are required at a maximum  $d/2$  spacing for spans greater than 1 200 mm, where "d" is the distance from the top of the lintel to the level of the bottom reinforcing bar in the lintel.

# Span Tables

**Table 9.20.17.4.-C**

**Maximum Allowable Clear Spans for Lintels in Flat Loadbearing Insulating Concrete Form (ICF) Walls<sup>(1)(2)(3)</sup> (2-15M Bottom Bar)**  
Forming Part of Sentences 9.3.2.8.(1) and 9.20.17.4.(3)

Minimum Lintel Thickness, mm	Minimum Lintel Depth, mm	Maximum Clear Span, m			
		Supporting Light-Frame Roof Only		Supporting ICF Second Storey and Light-Frame Roof	
		Maximum Ground Snow Load, kN/m <sup>2</sup>			
		1.50	3.33	1.50	3.33
140	200	1.63	1.46	1.31	1.23
	300	2.43	2.18	1.96	1.84
	400	3.22	2.90	2.60	2.42
	500	4.00	3.60	3.25	2.70
	600	4.71	4.20	3.61	2.97
150	200	1.67	1.49	1.33	1.25
	300	2.48	2.23	1.99	1.87
	400	3.29	2.96	2.64	2.45
	500	4.80	3.68	3.29	2.74
	600	4.87	4.20	3.64	3.02
160	200	1.70	1.53	1.35	1.27
	300	2.53	2.28	2.02	1.90
	400	3.36	3.02	2.68	2.48
	500	4.16	3.76	3.27	2.78
	600	4.95	4.20	3.61	3.08
190	200	1.80	1.61	1.39	1.32
	300	2.67	2.40	2.09	1.97
	400	3.53	3.19	2.77	2.56
	500	4.38	3.81	3.18	2.90
	600	4.92	4.19	3.50	3.21
200	200	1.83	1.64	1.41	1.33
	300	2.87	2.44	2.11	2.00
	400	3.78	3.24	2.79	2.55
	500	4.46	3.81	3.15	2.89
	600	4.86	4.18	3.47	3.18
240	200	2.07	1.74	1.46	1.38
	300	3.07	2.59	2.18	2.07
	400	3.95	3.38	2.70	2.48
	500	4.40	3.80	3.04	2.80
	600	4.78	4.16	3.34	3.08

**Notes to Table 9.20.17.4.-C:**

- (1) Deflection criterion is L/240, where "L" is the clear span of the lintel.
- (2) Linear interpolation is permitted between ground snow loads and between lintel depths.
- (3) 10M stirrups are required at a maximum d/2 spacing for spans greater than 1 200 mm, where "d" is the distance from the top of the lintel to the level of the bottom reinforcing bar in the lintel.

**Table 9.23.4.2.-A**  
**Maximum Spans for Floor Joists – General Cases<sup>(1)</sup>**  
 Forming Part of Sentences 9.3.2.8.(1), 9.23.4.2.(1) and (2), 9.23.4.4.(1) and 9.23.9.4.(1) to (3)

Commercial Designation	Grade	Joist Size, mm	Maximum Span, m									
			With Strapping <sup>(2)</sup>			With Bridging			With Strapping <sup>(2)</sup> and Bridging			
			Joist Spacing, mm			Joist Spacing, mm			Joist Spacing, mm			
			300	400	600	300	400	600	300	400	600	
Douglas Fir – Larch (includes Douglas Fir and Western Larch)	Select Structural	38 x 89	2.13	1.97	1.73	2.19	1.99	1.73	2.19	1.99	1.73	
		38 x 140	3.23	3.07	2.73	3.44	3.12	2.73	3.44	3.12	2.73	
		38 x 184	3.88	3.69	3.51	4.18	3.92	3.59	4.37	4.07	3.59	
		38 x 235	4.57	4.34	4.13	4.86	4.57	4.29	5.05	4.70	4.39	
		38 x 286	5.21	4.95	4.71	5.49	5.16	4.85	5.66	5.28	4.92	
	No. 1 and No. 2	38 x 89	2.00	1.85	1.66	2.09	1.90	1.66	2.09	1.90	1.66	
		38 x 140	3.09	2.91	2.62	3.29	2.99	2.62	3.29	2.99	2.62	
		38 x 184	3.71	3.53	3.36	4.00	3.76	3.44	4.19	3.90	3.44	
		38 x 235	4.38	4.16	3.96	4.66	4.38	4.11	4.84	4.51	4.20	
		38 x 286	4.99	4.75	4.52	5.26	4.94	4.65	5.43	5.06	4.72	
	No. 3	38 x 89	1.90	1.69	1.38	1.95	1.69	1.38	1.95	1.69	1.38	
		38 x 140	2.78	2.41	1.97	2.78	2.41	1.97	2.78	2.41	1.97	
		38 x 184	3.38	2.93	2.39	3.38	2.93	2.39	3.38	2.93	2.39	
		38 x 235	4.14	3.58	2.93	4.14	3.58	2.93	4.14	3.58	2.93	
		38 x 286	4.80	4.16	3.39	4.80	4.16	3.39	4.80	4.16	3.39	
	Construction	38 x 89	1.90	1.77	1.61	2.03	1.84	1.61	2.03	1.84	1.61	
	Standard	38 x 89	1.81	1.63	1.33	1.88	1.63	1.33	1.88	1.63	1.33	
	Hem – Fir (includes Western Hemlock and Amabilis Fir)	Select Structural	38 x 89	2.08	1.93	1.71	2.16	1.96	1.71	2.16	1.96	1.71
			38 x 140	3.18	3.03	2.69	3.39	3.08	2.69	3.39	3.08	2.69
			38 x 184	3.82	3.64	3.46	4.12	3.87	3.54	4.31	4.02	3.54
38 x 235			4.50	4.28	4.08	4.80	4.51	4.23	4.98	4.64	4.33	
38 x 286			5.14	4.89	4.65	5.42	5.09	4.78	5.59	5.21	4.86	
No. 1 and No. 2		38 x 89	2.00	1.85	1.66	2.09	1.90	1.66	2.09	1.90	1.66	
		38 x 140	3.09	2.91	2.62	3.29	2.99	2.62	3.29	2.99	2.62	
		38 x 184	3.71	3.53	3.36	4.00	3.76	3.44	4.19	3.90	3.44	
		38 x 235	4.38	4.16	3.96	4.66	4.38	4.11	4.84	4.51	4.20	
		38 x 286	4.99	4.75	4.52	5.26	4.94	4.65	5.43	5.06	4.72	
No. 3		38 x 89	1.90	1.77	1.61	2.03	1.84	1.61	2.03	1.84	1.61	
		38 x 140	2.99	2.78	2.43	3.19	2.90	2.43	3.19	2.90	2.43	
		38 x 184	3.60	3.42	2.95	3.88	3.61	2.95	4.06	3.61	2.95	
		38 x 235	4.24	4.03	3.61	4.51	4.24	3.61	4.68	4.37	3.61	
		38 x 286	4.84	4.60	4.19	5.10	4.79	4.19	5.26	4.90	4.19	
Construction		38 x 89	1.90	1.77	1.61	2.03	1.84	1.61	2.03	1.84	1.61	
Standard		38 x 89	1.81	1.68	1.39	1.96	1.71	1.39	1.96	1.71	1.39	

# Span Tables

Table 9.23.4.2.-A (Continued)

Commercial Designation	Grade	Joist Size, mm	Maximum Span, m								
			With Strapping <sup>(2)</sup>			With Bridging			With Strapping <sup>(2)</sup> and Bridging		
			Joist Spacing, mm			Joist Spacing, mm			Joist Spacing, mm		
			300	400	600	300	400	600	300	400	600
Spruce – Pine – Fir (includes Spruce (all species except Coast Sitka Spruce), Jack Pine, Lodgepole Pine, Balsam Fir and Alpine Fir)	Select Structural	38 x 89	1.95	1.81	1.64	2.06	1.87	1.64	2.06	1.87	1.64
		38 x 140	3.05	2.85	2.57	3.24	2.95	2.57	3.24	2.95	2.57
		38 x 184	3.66	3.48	3.31	3.94	3.70	3.38	4.12	3.84	3.38
		38 x 235	4.31	4.10	3.90	4.59	4.31	4.05	4.76	4.44	4.14
		38 x 286	4.91	4.67	4.45	5.18	4.87	4.57	5.34	4.98	4.64
	No. 1 and No. 2	38 x 89	1.86	1.72	1.58	1.99	1.81	1.58	1.99	1.81	1.58
		38 x 140	2.92	2.71	2.49	3.14	2.85	2.49	3.14	2.85	2.49
		38 x 184	3.54	3.36	3.20	3.81	3.58	3.27	3.99	3.72	3.27
		38 x 235	4.17	3.96	3.77	4.44	4.17	3.92	4.60	4.29	4.00
		38 x 286	4.75	4.52	4.30	5.01	4.71	4.42	5.17	4.82	4.49
	No. 3	38 x 89	1.81	1.68	1.55	1.96	1.78	1.55	1.96	1.78	1.55
		38 x 140	2.84	2.64	2.43	3.08	2.80	2.43	3.08	2.80	2.43
		38 x 184	3.47	3.30	2.95	3.74	3.52	2.95	3.92	3.61	2.95
		38 x 235	4.09	3.89	3.61	4.36	4.09	3.61	4.52	4.22	3.61
		38 x 286	4.67	4.44	4.19	4.92	4.62	4.19	5.08	4.73	4.19
	Construction	38 x 89	1.81	1.68	1.55	1.96	1.78	1.55	1.96	1.78	1.55
	Standard	38 x 89	1.70	1.58	1.44	1.88	1.71	1.44	1.88	1.71	1.44
	Northern Species (includes any Canadian species covered by the NLGA Standard Grading Rules)	Select Structural	38 x 89	1.65	1.53	1.42	1.84	1.68	1.46	1.84	1.68
38 x 140			2.59	2.41	2.24	2.90	2.63	2.30	2.90	2.63	2.30
38 x 184			3.27	3.11	2.94	3.52	3.31	3.03	3.69	3.44	3.03
38 x 235			3.85	3.66	3.48	4.10	3.85	3.62	4.26	3.97	3.70
38 x 286			4.39	4.18	3.97	4.63	4.35	4.09	4.78	4.45	4.15
No. 1 and No. 2		38 x 89	1.59	1.48	1.37	1.80	1.64	1.43	1.80	1.64	1.43
		38 x 140	2.51	2.33	2.16	2.83	2.57	2.25	2.83	2.57	2.25
		38 x 184	3.19	3.04	2.84	3.44	3.23	2.96	3.60	3.36	2.96
		38 x 235	3.76	3.58	3.41	4.01	3.77	3.54	4.16	3.88	3.62
		38 x 286	4.29	4.08	3.88	4.53	4.25	4.00	4.67	4.35	4.06
No. 3		38 x 89	1.54	1.43	1.32	1.74	1.57	1.36	1.76	1.60	1.36
		38 x 140	2.42	2.24	1.94	2.74	2.38	1.94	2.75	2.38	1.94
		38 x 184	3.12	2.90	2.37	3.35	2.90	2.37	3.35	2.90	2.37
		38 x 235	3.67	3.49	2.89	3.91	3.54	2.89	4.06	3.54	2.89
		38 x 286	4.19	3.98	3.36	4.42	4.11	3.36	4.55	4.11	3.36
Construction		38 x 89	1.54	1.43	1.32	1.74	1.57	1.40	1.76	1.60	1.40
Standard		38 x 89	1.48	1.37	1.15	1.63	1.41	1.15	1.63	1.41	1.15

**Notes to Table 9.23.4.2.-A:**

- (1) Spans apply only where the floors serve residential areas as described in Table 4.1.5.3., or the uniformly distributed *live load* on the floors does not exceed that specified for residential areas as described in Table 4.1.5.3.
- (2) See Sentence 9.23.9.4.(5) for alternatives to strapping.

**Table 9.23.4.2.-B**  
**Maximum Spans for Floor Joists – Special Cases<sup>(1)</sup>**  
 Forming Part of Sentences 9.3.2.8.(1), 9.23.4.2.(1) and (2), 9.23.4.4.(2) and 9.23.9.4.(4) and (6)

Commercial Designation	Grade	Joist Size, mm	Maximum Span, m									
			Joists with Ceilings Attached to Wood Furring						Joists with Concrete Topping			
			Without Bridging			With Bridging			With or Without Bridging <sup>(2)</sup>			
			Joist Spacing, mm			Joist Spacing, mm			Joist Spacing, mm			
			300	400	600	300	400	600	300	400	600	
Douglas Fir – Larch (includes Douglas Fir and Western Larch)	Select Structural	38 x 89	2.19	1.99	1.73	2.19	1.99	1.73	2.19	1.99	1.73	
		38 x 140	3.44	3.12	2.73	3.44	3.12	2.73	3.44	3.12	2.73	
		38 x 184	4.24	3.99	3.59	4.52	4.11	3.59	4.52	4.11	3.59	
		38 x 235	4.98	4.69	4.29	5.47	5.20	4.58	5.77	5.24	4.58	
		38 x 286	5.67	5.34	4.88	6.19	5.89	5.54	6.83	6.37	5.58	
	No. 1 and No. 2	38 x 89	2.09	1.90	1.66	2.09	1.90	1.66	2.09	1.90	1.66	
		38 x 140	3.29	2.99	2.62	3.29	2.99	2.62	3.29	2.99	2.55	
		38 x 184	4.06	3.83	3.44	4.33	3.93	3.44	4.33	3.81	3.11	
		38 x 235	4.78	4.50	4.11	5.24	4.98	4.31	5.37	4.65	3.80	
		38 x 286	5.44	5.12	4.68	5.93	5.64	5.00	6.24	5.40	4.41	
	No. 3	38 x 89	1.95	1.69	1.38	1.95	1.69	1.38	1.72	1.49	1.21	
		38 x 140	2.78	2.41	1.97	2.78	2.41	1.97	2.45	2.12	1.73	
		38 x 184	3.38	2.93	2.39	3.38	2.93	2.39	2.98	2.58	2.11	
		38 x 235	4.14	3.58	2.93	4.14	3.58	2.93	3.65	3.16	2.58	
		38 x 286	4.80	4.16	3.39	4.80	4.16	3.39	4.23	3.66	2.99	
	Construction	38 x 89	2.03	1.84	1.61	2.03	1.84	1.61	2.03	1.84	1.61	
	Standard	38 x 89	1.88	1.63	1.33	1.88	1.63	1.33	1.66	1.44	1.17	
	Hem – Fir (includes Western Hemlock and Amabilis Fir)	Select Structural	38 x 89	2.16	1.96	1.71	2.16	1.96	1.71	2.16	1.96	1.71
			38 x 140	3.39	3.08	2.69	3.39	3.08	2.69	3.39	3.08	2.69
			38 x 184	4.18	3.94	3.54	4.46	4.05	3.54	4.46	4.05	3.54
38 x 235			4.92	4.63	4.23	5.39	5.13	4.52	5.69	5.17	4.52	
38 x 286			5.60	5.27	4.82	6.10	5.81	5.47	6.74	6.28	5.50	
No. 1 and No. 2		38 x 89	2.09	1.90	1.66	2.09	1.90	1.66	2.09	1.90	1.66	
		38 x 140	3.29	2.99	2.62	3.29	2.99	2.62	3.29	2.99	2.62	
		38 x 184	4.06	3.83	3.44	4.33	3.93	3.44	4.33	3.93	3.26	
		38 x 235	4.78	4.50	4.11	5.24	4.98	4.39	5.53	4.88	3.99	
		38 x 286	5.44	5.12	4.68	5.93	5.64	5.25	6.54	5.66	4.63	
No. 3		38 x 89	2.03	1.84	1.61	2.03	1.84	1.61	2.03	1.83	1.50	
		38 x 140	3.19	2.90	2.43	3.19	2.90	2.43	3.02	2.62	2.14	
		38 x 184	3.94	3.61	2.95	4.17	3.61	2.95	3.68	3.18	2.60	
		38 x 235	4.63	4.36	3.61	5.08	4.42	3.61	4.50	3.89	3.18	
		38 x 286	5.27	4.96	4.19	5.74	5.13	4.19	5.22	4.52	3.69	
Construction		38 x 89	2.03	1.84	1.61	2.03	1.84	1.61	2.03	1.84	1.61	
Standard		38 x 89	1.96	1.71	1.39	1.96	1.71	1.39	1.74	1.50	1.23	

# Span Tables

Table 9.23.4.2.-B (Continued)

Commercial Designation	Grade	Joist Size, mm	Maximum Span, m								
			Joists with Ceilings Attached to Wood Furring						Joists with Concrete Topping		
			Without Bridging			With Bridging			With or Without Bridging <sup>(2)</sup>		
			Joist Spacing, mm			Joist Spacing, mm			Joist Spacing, mm		
			300	400	600	300	400	600	300	400	600
Spruce – Pine – Fir (includes Spruce (all species except Coast Sitka Spruce), Jack Pine, Lodgepole Pine, Balsam Fir and Alpine Fir)	Select Structural	38 x 89	2.06	1.87	1.64	2.06	1.87	1.64	2.06	1.87	1.64
		38 x 140	3.24	2.95	2.57	3.24	2.95	2.57	3.24	2.95	2.57
		38 x 184	4.00	3.77	3.38	4.26	3.87	3.38	4.26	3.87	3.38
		38 x 235	4.70	4.43	4.05	5.16	4.91	4.32	5.45	4.95	4.32
		38 x 286	5.35	5.04	4.61	5.84	5.55	5.23	6.45	6.01	5.26
	No. 1 and No. 2	38 x 89	1.99	1.81	1.58	1.99	1.81	1.58	1.99	1.81	1.58
		38 x 140	3.14	2.85	2.49	3.14	2.85	2.49	3.14	2.85	2.49
		38 x 184	3.87	3.64	3.27	4.12	3.75	3.27	4.12	3.75	3.27
		38 x 235	4.55	4.28	3.91	4.99	4.75	4.18	5.27	4.79	4.13
		38 x 286	5.18	4.88	4.46	5.65	5.37	5.06	6.23	5.81	4.79
	No. 3	38 x 89	1.96	1.78	1.55	1.96	1.78	1.55	1.96	1.78	1.50
		38 x 140	3.08	2.80	2.43	3.08	2.80	2.43	3.02	2.62	2.14
		38 x 184	3.80	3.58	2.95	4.05	3.61	2.95	3.68	3.18	2.60
		38 x 235	4.47	4.21	3.61	4.90	4.42	3.61	4.50	3.89	3.18
		38 x 286	5.09	4.79	4.19	5.55	5.13	4.19	5.22	4.52	3.69
	Construction	38 x 89	1.96	1.78	1.55	1.96	1.78	1.55	1.96	1.78	1.55
	Standard	38 x 89	1.88	1.71	1.44	1.88	1.71	1.44	1.80	1.56	1.27
	Northern Species (includes any Canadian species covered by the NLGA Standard Grading Rules)	Select Structural	38 x 89	1.84	1.68	1.46	1.84	1.68	1.46	1.84	1.68
38 x 140			2.90	2.63	2.30	2.90	2.63	2.30	2.90	2.63	2.30
38 x 184			3.58	3.37	3.03	3.81	3.46	3.03	3.81	3.46	3.03
38 x 235			4.20	3.96	3.62	4.61	4.39	3.86	4.87	4.42	3.86
38 x 286			4.79	4.51	4.12	5.22	4.96	4.68	5.76	5.37	4.54
No. 1 and No. 2		38 x 89	1.80	1.64	1.43	1.80	1.64	1.43	1.80	1.64	1.43
		38 x 140	2.83	2.57	2.25	2.83	2.57	2.25	2.83	2.57	2.23
		38 x 184	3.50	3.29	2.96	3.72	3.38	2.96	3.72	3.32	2.71
		38 x 235	4.11	3.87	3.54	4.51	4.29	3.76	4.69	4.06	3.31
		38 x 286	4.68	4.40	4.03	5.10	4.85	4.36	5.44	4.71	3.84
No. 3		38 x 89	1.76	1.60	1.36	1.76	1.60	1.36	1.70	1.47	1.20
		38 x 140	2.75	2.38	1.94	2.75	2.38	1.94	2.42	2.10	1.71
		38 x 184	3.35	2.90	2.37	3.35	2.90	2.37	2.95	2.55	2.08
		38 x 235	4.01	3.54	2.89	4.09	3.54	2.89	3.61	3.12	2.55
		38 x 286	4.56	4.11	3.36	4.75	4.11	3.36	4.18	3.62	2.96
Construction		38 x 89	1.76	1.60	1.40	1.76	1.60	1.40	1.76	1.60	1.37
Standard		38 x 89	1.63	1.41	1.15	1.63	1.41	1.15	1.44	1.25	1.02

**Notes to Table 9.23.4.2.-B:**

- (1) Spans apply only where the floors serve residential areas as described in Table 4.1.5.3., or the uniformly distributed *live load* on the floors does not exceed that specified for residential areas as described in Table 4.1.5.3.
- (2) No bridging is assumed for spans for floor joists with concrete topping.

**Table 9.23.4.2.-C**  
**Maximum Spans for Ceiling Joists – Attic not Accessible by a Stairway**  
 Forming Part of Sentences 9.3.2.8.(1), 9.23.4.2.(1) and 9.23.14.10.(2)

Commercial Designation	Grade	Joist Size, mm	Maximum Span, m		
			Joist Spacing, mm		
			300	400	600
Douglas Fir – Larch (includes Douglas Fir and Western Larch)	Select Structural	38 x 89	3.41	3.10	2.71
		38 x 140	5.37	4.88	4.26
		38 x 184	7.05	6.41	5.60
		38 x 235	9.01	8.18	7.15
		38 x 286	10.96	9.96	8.70
	No. 1 and No. 2	38 x 89	3.27	2.97	2.59
		38 x 140	5.14	4.67	4.08
		38 x 184	6.76	6.14	5.36
		38 x 235	8.63	7.84	6.85
		38 x 286	10.50	9.54	8.34
	No. 3	38 x 89	3.17	2.88	2.42
		38 x 140	4.89	4.23	3.46
		38 x 184	5.95	5.15	4.20
		38 x 235	7.27	6.30	5.14
		38 x 286	8.44	7.31	5.97
	Construction	38 x 89	3.17	2.88	2.51
	Standard	38 x 89	3.06	2.78	2.34
	Hem – Fir (includes Western Hemlock and Amabilis Fir)	Select Structural	38 x 89	3.36	3.06
38 x 140			5.29	4.81	4.20
38 x 184			6.96	6.32	5.52
38 x 235			8.88	8.07	7.05
38 x 286			10.81	9.82	8.58
No. 1 and No. 2		38 x 89	3.27	2.97	2.59
		38 x 140	5.14	4.67	4.08
		38 x 184	6.76	6.14	5.36
		38 x 235	8.63	7.84	6.85
		38 x 286	10.50	9.54	8.34
No. 3		38 x 89	3.17	2.88	2.51
		38 x 140	4.98	4.53	3.95
		38 x 184	6.55	5.95	5.19
		38 x 235	8.36	7.60	6.34
		38 x 286	10.18	9.01	7.36
Construction		38 x 89	3.17	2.88	2.50
Standard		38 x 89	3.06	2.78	2.43

# Span Tables

Table 9.23.4.2.-C (Continued)

Commercial Designation	Grade	Joist Size, mm	Maximum Span, m			
			Joist Spacing, mm			
			300	400	600	
Spruce – Pine – Fir (includes Spruce (all species except Coast Sitka Spruce), Jack Pine, Lodgepole Pine, Balsam Fir and Alpine Fir)	Select Structural	38 x 89	3.22	2.92	2.55	
		38 x 140	5.06	4.60	4.02	
		38 x 184	6.65	6.05	5.28	
		38 x 235	8.50	7.72	6.74	
		38 x 286	10.34	9.40	8.21	
	No. 1 and No. 2	38 x 89	3.11	2.83	2.47	
		38 x 140	4.90	4.45	3.89	
		38 x 184	6.44	5.85	5.11	
		38 x 235	8.22	7.47	6.52	
		38 x 286	10.00	9.09	7.94	
	No. 3	38 x 89	3.06	2.78	2.43	
		38 x 140	4.81	4.37	3.82	
		38 x 184	6.32	5.74	5.02	
		38 x 235	8.07	7.33	6.34	
		38 x 286	9.82	8.93	7.36	
	Construction	38 x 89	3.06	2.78	2.43	
	Standard	38 x 89	2.94	2.67	2.33	
	Northern Species (includes any Canadian species covered by the NLGA Standard Grading Rules)	Select Structural	38 x 89	2.88	2.61	2.28
			38 x 140	4.53	4.11	3.59
			38 x 184	5.95	5.40	4.72
			38 x 235	7.60	6.90	6.03
38 x 286			9.25	8.40	7.34	
No. 1 and No. 2		38 x 89	2.81	2.55	2.23	
		38 x 140	4.42	4.02	3.51	
		38 x 184	5.81	5.28	4.61	
		38 x 235	7.42	6.74	5.89	
		38 x 286	9.03	8.21	7.17	
No. 3		38 x 89	2.74	2.49	2.18	
		38 x 140	4.31	3.92	3.42	
		38 x 184	5.67	5.09	4.16	
		38 x 235	7.19	6.23	5.08	
		38 x 286	8.34	7.23	5.90	
Construction		38 x 89	2.74	2.49	2.18	
Standard		38 x 89	2.67	2.43	2.03	



**Table 9.23.4.2.-D**  
**Maximum Spans for Roof Joists – Specified Roof Snow Loads 1.0 to 2.0 kPa**  
 Forming Part of Sentences 9.3.2.8.(1), 9.23.4.2.(1), 9.23.4.5.(1) and 9.23.14.10.(2)

Commercial Designation	Grade	Joist Size, mm	Maximum Span, m									
			Specified Snow Load, kPa									
			1.0			1.5			2.0			
			Joist Spacing, mm			Joist Spacing, mm			Joist Spacing, mm			
			300	400	600	300	400	600	300	400	600	
Douglas Fir – Larch (includes Douglas Fir and Western Larch)	Select Structural	38 x 89	2.71	2.46	2.15	2.37	2.15	1.88	2.15	1.95	1.71	
		38 x 140	4.26	3.87	3.38	3.72	3.38	2.95	3.38	3.07	2.68	
		38 x 184	5.60	5.09	4.44	4.89	4.44	3.88	4.44	4.04	3.53	
		38 x 235	7.15	6.49	5.67	6.24	5.67	4.96	5.67	5.15	4.50	
		38 x 286	8.70	7.90	6.91	7.60	6.91	6.03	6.91	6.27	5.48	
	No. 1 and No. 2	38 x 89	2.59	2.36	2.06	2.27	2.06	1.80	2.06	1.87	1.63	
		38 x 140	4.08	3.71	3.24	3.57	3.24	2.83	3.24	2.94	2.57	
		38 x 184	5.36	4.87	4.26	4.69	4.26	3.72	4.26	3.87	3.38	
		38 x 235	6.85	6.22	5.44	5.98	5.44	4.74	5.44	4.94	4.22	
		38 x 286	8.34	7.57	6.40	7.28	6.62	5.50	6.62	6.00	4.90	
	No. 3	38 x 89	2.49	2.16	1.76	2.14	1.85	1.51	1.91	1.65	1.35	
		38 x 140	3.56	3.08	2.51	3.06	2.65	2.16	2.72	2.36	1.92	
		38 x 184	4.33	3.75	3.06	3.72	3.22	2.63	3.31	2.87	2.34	
		38 x 235	5.29	4.58	3.74	4.55	3.94	3.22	4.05	3.51	2.86	
		38 x 286	6.14	5.32	4.34	5.28	4.57	3.73	4.70	4.07	3.32	
	Construction	38 x 89	2.51	2.28	1.99	2.20	1.99	1.74	1.99	1.81	1.58	
	Standard	38 x 89	2.41	2.08	1.70	2.07	1.79	1.46	1.84	1.60	1.30	
	Hem – Fir (includes Western Hemlock and Amabilis Fir)	Select Structural	38 x 89	2.67	2.43	2.12	2.33	2.12	1.85	2.12	1.93	1.68
			38 x 140	4.20	3.82	3.33	3.67	3.33	2.91	3.33	3.03	2.65
			38 x 184	5.52	5.02	4.38	4.82	4.38	3.83	4.38	3.98	3.48
38 x 235			7.05	6.41	5.60	6.16	5.60	4.89	5.60	5.09	4.44	
38 x 286			8.58	7.80	6.81	7.50	6.81	5.95	6.81	6.19	5.41	
No. 1 and No. 2		38 x 89	2.59	2.36	2.06	2.27	2.06	1.80	2.06	1.87	1.63	
		38 x 140	4.08	3.71	3.24	3.57	3.24	2.83	3.24	2.94	2.57	
		38 x 184	5.36	4.87	4.26	4.69	4.26	3.72	4.26	3.87	3.38	
		38 x 235	6.85	6.22	5.44	5.98	5.44	4.75	5.44	4.94	4.32	
		38 x 286	8.34	7.57	6.62	7.28	6.62	5.77	6.62	6.01	5.25	
No. 3		38 x 89	2.51	2.28	1.99	2.20	1.99	1.74	1.99	1.81	1.58	
		38 x 140	3.95	3.59	3.10	3.45	3.14	2.67	3.14	2.85	2.37	
		38 x 184	5.20	4.62	3.77	4.54	3.97	3.24	4.09	3.54	2.89	
		38 x 235	6.53	5.65	4.61	5.61	4.86	3.97	5.00	4.33	3.53	
		38 x 286	7.57	6.56	5.35	6.51	5.64	4.60	5.80	5.02	4.10	
Construction		38 x 89	2.51	2.28	1.99	2.20	1.99	1.74	1.99	1.81	1.58	
Standard		38 x 89	2.43	2.18	1.78	2.12	1.88	1.53	1.93	1.67	1.36	

Copyright © NRC 1941 - 2021 World Rights Reserved © CNRC 1941-2021 Droits réservés pour tous pays

# Span Tables

Table 9.23.4.2.-D (Continued)

Commercial Designation	Grade	Joist Size, mm	Maximum Span, m									
			Specified Snow Load, kPa									
			1.0			1.5			2.0			
			Joist Spacing, mm			Joist Spacing, mm			Joist Spacing, mm			
			300	400	600	300	400	600	300	400	600	
Spruce – Pine – Fir (includes Spruce (all species except Coast Sitka Spruce), Jack Pine, Lodgepole Pine, Balsam Fir and Alpine Fir)	Select Structural	38 x 89	2.55	2.32	2.03	2.23	2.03	1.77	2.03	1.84	1.61	
		38 x 140	4.02	3.65	3.19	3.51	3.19	2.79	3.19	2.90	2.53	
		38 x 184	5.28	4.80	4.19	4.61	4.19	3.66	4.19	3.81	3.33	
		38 x 235	6.74	6.13	5.35	5.89	5.35	4.68	5.35	4.86	4.25	
		38 x 286	8.21	7.46	6.52	7.17	6.52	5.69	6.52	5.92	5.17	
	No. 1 and No. 2	38 x 89	2.47	2.24	1.96	2.16	1.96	1.71	1.96	1.78	1.56	
		38 x 140	3.89	3.53	3.08	3.40	3.08	2.69	3.08	2.80	2.45	
		38 x 184	5.11	4.64	4.05	4.46	4.05	3.54	4.05	3.68	3.22	
		38 x 235	6.52	5.93	5.18	5.70	5.18	4.52	5.18	4.70	4.11	
		38 x 286	7.94	7.21	6.30	6.94	6.30	5.50	6.30	5.73	5.00	
	No. 3	38 x 89	2.43	2.20	1.93	2.12	1.93	1.68	1.93	1.75	1.53	
		38 x 140	3.82	3.47	3.03	3.33	3.03	2.65	3.03	2.75	2.37	
		38 x 184	5.02	4.56	3.77	4.38	3.97	3.24	3.98	3.54	2.89	
		38 x 235	6.41	5.65	4.61	5.60	4.86	3.97	5.00	4.33	3.53	
		38 x 286	7.57	6.56	5.35	6.51	5.64	4.60	5.80	5.02	4.10	
	Construction	38 x 89	2.43	2.20	1.93	2.12	1.93	1.68	1.93	1.75	1.53	
	Standard	38 x 89	2.33	2.12	1.85	2.04	1.85	1.59	1.85	1.68	1.41	
	Northern Species (includes any Canadian species covered by the NLGA Standard Grading Rules)	Select Structural	38 x 89	2.28	2.07	1.81	1.99	1.81	1.58	1.81	1.65	1.44
			38 x 140	3.59	3.26	2.85	3.14	2.85	2.49	2.85	2.59	2.26
			38 x 184	4.72	4.29	3.75	4.12	3.75	3.27	3.75	3.40	2.97
38 x 235			6.03	5.48	4.79	5.27	4.79	4.18	4.79	4.35	3.80	
38 x 286			7.34	6.67	5.82	6.41	5.82	5.09	5.82	5.29	4.62	
No. 1 and No. 2		38 x 89	2.23	2.03	1.77	1.95	1.77	1.55	1.77	1.61	1.41	
		38 x 140	3.51	3.19	2.79	3.07	2.79	2.43	2.79	2.53	2.21	
		38 x 184	4.61	4.19	3.66	4.03	3.66	3.20	3.66	3.33	2.91	
		38 x 235	5.89	5.35	4.68	5.15	4.68	4.09	4.68	4.25	3.68	
		38 x 286	7.17	6.52	5.58	6.26	5.69	4.80	5.69	5.17	4.27	
No. 3		38 x 89	2.18	1.98	1.73	1.90	1.73	1.50	1.73	1.57	1.33	
		38 x 140	3.42	3.05	2.49	2.99	2.62	2.14	2.69	2.33	1.90	
		38 x 184	4.28	3.71	3.03	3.68	3.19	2.60	3.28	2.84	2.32	
		38 x 235	5.23	4.53	3.70	4.50	3.90	3.18	4.01	3.47	2.83	
		38 x 286	6.07	5.26	4.29	5.22	4.52	3.69	4.65	4.03	3.29	
Construction		38 x 89	2.18	1.98	1.73	1.90	1.73	1.51	1.73	1.57	1.37	
Standard		38 x 89	2.09	1.81	1.48	1.80	1.56	1.27	1.60	1.38	1.13	

Copyright © NRC 1941 - 2021 World Rights Reserved © CNRC 1941-2021 Droits réservés pour tous pays

**Table 9.23.4.2.-E**  
**Maximum Spans for Roof Joists – Specified Roof Snow Loads 2.5 and 3.0 kPa**  
 Forming Part of Sentences 9.3.2.8.(1), 9.23.4.2.(1), 9.23.4.5.(1) and 9.23.14.10.(2)

Commercial Designation	Grade	Joist Size, mm	Maximum Span, m						
			Specified Snow Load, kPa						
			2.5			3.0			
			Joist Spacing, mm			Joist Spacing, mm			
			300	400	600	300	400	600	
Douglas Fir – Larch (includes Douglas Fir and Western Larch)	Select Structural	38 x 89	1.99	1.81	1.58	1.88	1.71	1.49	
		38 x 140	3.14	2.85	2.49	2.95	2.68	2.34	
		38 x 184	4.12	3.75	3.27	3.88	3.53	3.08	
		38 x 235	5.27	4.79	4.18	4.96	4.50	3.93	
		38 x 286	6.41	5.82	5.09	6.03	5.48	4.79	
	No. 1 and No. 2	38 x 89	1.91	1.74	1.52	1.80	1.63	1.43	
		38 x 140	3.01	2.73	2.39	2.83	2.57	2.25	
		38 x 184	3.95	3.59	3.14	3.72	3.38	2.90	
		38 x 235	5.05	4.59	3.84	4.75	4.32	3.55	
		38 x 286	6.14	5.46	4.46	5.78	5.05	4.12	
	No. 3	38 x 89	1.74	1.50	1.23	1.60	1.39	1.13	
		38 x 140	2.48	2.15	1.75	2.29	1.98	1.62	
		38 x 184	3.01	2.61	2.13	2.79	2.41	1.97	
		38 x 235	3.69	3.19	2.61	3.41	2.95	2.41	
	Construction	38 x 89	1.85	1.68	1.47	1.74	1.58	1.38	
		Standard	38 x 89	1.68	1.45	1.19	1.55	1.34	1.10
	Hem – Fir (includes Western Hemlock and Amabilis Fir)	Select Structural	38 x 89	1.97	1.79	1.56	1.85	1.68	1.47
			38 x 140	3.10	2.81	2.46	2.91	2.65	2.31
			38 x 184	4.07	3.70	3.23	3.83	3.48	3.04
			38 x 235	5.20	4.72	4.12	4.89	4.44	3.88
38 x 286			6.32	5.75	5.02	5.95	5.41	4.72	
No. 1 and No. 2		38 x 89	1.91	1.74	1.52	1.80	1.63	1.43	
		38 x 140	3.01	2.73	2.39	2.83	2.57	2.25	
		38 x 184	3.95	3.59	3.14	3.72	3.38	2.95	
		38 x 235	5.05	4.59	4.01	4.75	4.32	3.72	
		38 x 286	6.14	5.58	4.68	5.78	5.25	4.32	
No. 3		38 x 89	1.85	1.68	1.47	1.74	1.58	1.38	
		38 x 140	2.91	2.65	2.16	2.74	2.45	2.00	
		38 x 184	3.72	3.22	2.63	3.44	2.98	2.43	
		38 x 235	4.55	3.94	3.22	4.20	3.64	2.97	
Construction		38 x 89	1.85	1.68	1.47	1.74	1.58	1.38	
		Standard	38 x 89	1.76	1.52	1.24	1.62	1.40	1.15

# Span Tables

Table 9.23.4.2.-E (Continued)

Commercial Designation	Grade	Joist Size, mm	Maximum Span, m					
			Specified Snow Load, kPa					
			2.5			3.0		
			Joist Spacing, mm			Joist Spacing, mm		
			300	400	600	300	400	600
Spruce – Pine – Fir (includes Spruce (all species except Coast Sitka Spruce), Jack Pine, Lodgepole Pine, Balsam Fir and Alpine Fir)	Select Structural	38 x 89	1.88	1.71	1.49	1.77	1.61	1.41
		38 x 140	2.96	2.69	2.35	2.79	2.53	2.21
		38 x 184	3.89	3.54	3.09	3.66	3.33	2.91
		38 x 235	4.97	4.52	3.94	4.68	4.25	3.71
		38 x 286	6.05	5.50	4.80	5.69	5.17	4.52
	No. 1 and No. 2	38 x 89	1.82	1.65	1.44	1.71	1.56	1.36
		38 x 140	2.86	2.60	2.27	2.69	2.45	2.14
		38 x 184	3.76	3.42	2.99	3.54	3.22	2.81
		38 x 235	4.81	4.37	3.82	4.52	4.11	3.59
		38 x 286	5.85	5.31	4.64	5.50	5.00	4.37
	No. 3	38 x 89	1.79	1.62	1.42	1.68	1.53	1.34
		38 x 140	2.81	2.56	2.16	2.65	2.40	2.00
		38 x 184	3.70	3.22	2.63	3.44	2.98	2.43
		38 x 235	4.55	3.94	3.22	4.20	3.64	2.97
		38 x 286	5.28	4.57	3.73	4.88	4.22	3.45
	Construction	38 x 89	1.79	1.62	1.42	1.68	1.53	1.34
	Standard	38 x 89	1.72	1.56	1.29	1.62	1.46	1.19
	Northern Species (includes any Canadian species covered by the NLGA Standard Grading Rules)	Select Structural	38 x 89	1.68	1.53	1.34	1.58	1.44
38 x 140			2.65	2.40	2.10	2.49	2.26	1.98
38 x 184			3.48	3.16	2.76	3.27	2.97	2.60
38 x 235			4.44	4.04	3.53	4.18	3.80	3.32
38 x 286			5.41	4.91	4.29	5.09	4.62	4.04
No. 1 and No. 2		38 x 89	1.64	1.49	1.31	1.55	1.41	1.23
		38 x 140	2.59	2.35	2.05	2.43	2.21	1.93
		38 x 184	3.40	3.09	2.70	3.20	2.91	2.53
		38 x 235	4.34	3.94	3.35	4.09	3.71	3.10
		38 x 286	5.28	4.76	3.89	4.97	4.40	3.59
No. 3		38 x 89	1.60	1.46	1.21	1.51	1.37	1.12
		38 x 140	2.45	2.12	1.73	2.26	1.96	1.60
		38 x 184	2.98	2.58	2.11	2.76	2.39	1.95
		38 x 235	3.65	3.16	2.58	3.37	2.92	2.38
		38 x 286	4.23	3.66	2.99	3.91	3.39	2.76
Construction		38 x 89	1.60	1.46	1.27	1.51	1.37	1.20
Standard		38 x 89	1.46	1.26	1.03	1.34	1.16	0.95

**Table 9.23.4.2.-F**  
**Maximum Spans for Roof Rafters – Specified Roof Snow Loads 1.0 to 2.0 kPa**  
 Forming Part of Sentences 9.3.2.8.(1), 9.23.4.2.(1), 9.23.4.5.(1) and 9.23.14.10.(2)

Commercial Designation	Grade	Rafter Size, mm	Maximum Span, m									
			Specified Snow Load, kPa									
			1.0			1.5			2.0			
			Rafter Spacing, mm			Rafter Spacing, mm			Rafter Spacing, mm			
			300	400	600	300	400	600	300	400	600	
Douglas Fir – Larch (includes Douglas Fir and Western Larch)	Select Structural	38 x 89	3.41	3.10	2.71	2.98	2.71	2.37	2.71	2.46	2.15	
		38 x 140	5.37	4.88	4.26	4.69	4.26	3.72	4.26	3.87	3.38	
		38 x 184	7.05	6.41	5.60	6.16	5.60	4.89	5.60	5.09	4.44	
		38 x 235	9.01	8.18	7.15	7.87	7.15	6.24	7.15	6.49	5.62	
		38 x 286	10.96	9.96	8.70	9.58	8.70	7.40	8.70	7.90	6.52	
	No. 1 and No. 2	38 x 89	3.27	2.97	2.59	2.86	2.59	2.27	2.59	2.36	2.06	
		38 x 140	5.14	4.67	3.95	4.49	4.08	3.34	4.08	3.60	2.94	
		38 x 184	6.76	5.88	4.80	5.74	4.97	4.06	5.06	4.38	3.58	
		38 x 235	8.30	7.19	5.87	7.02	6.08	4.96	6.19	5.36	4.38	
		38 x 286	9.63	8.34	6.81	8.14	7.05	5.76	7.18	6.22	5.08	
	No. 3	38 x 89	2.65	2.30	1.87	2.24	1.94	1.58	1.98	1.71	1.40	
		38 x 140	3.78	3.28	2.68	3.20	2.77	2.26	2.82	2.44	1.99	
		38 x 184	4.61	3.99	3.26	3.89	3.37	2.75	3.43	2.97	2.43	
		38 x 235	5.63	4.88	3.98	4.76	4.12	3.37	4.20	3.64	2.97	
		38 x 286	6.53	5.66	4.62	5.52	4.78	3.91	4.87	4.22	3.44	
	Construction	38 x 89	3.17	2.88	2.42	2.77	2.50	2.04	2.51	2.21	1.80	
	Standard	38 x 89	2.56	2.22	1.81	2.17	1.88	1.53	1.91	1.65	1.35	
	Hem – Fir (includes Western Hemlock and Amabilis Fir)	Select Structural	38 x 89	3.36	3.06	2.67	2.94	2.67	2.33	2.67	2.43	2.12
			38 x 140	5.29	4.81	4.20	4.62	4.20	3.67	4.20	3.82	3.33
			38 x 184	6.96	6.32	5.52	6.08	5.52	4.82	5.52	5.02	4.38
38 x 235			8.88	8.07	7.05	7.76	7.05	6.16	7.05	6.41	5.54	
38 x 286			10.81	9.82	8.58	9.45	8.58	7.28	8.58	7.80	6.42	
No. 1 and No. 2		38 x 89	3.27	2.97	2.59	2.86	2.59	2.27	2.59	2.36	2.06	
		38 x 140	5.14	4.67	4.08	4.49	4.08	3.50	4.08	3.71	3.08	
		38 x 184	6.76	6.14	5.04	5.90	5.21	4.26	5.31	4.60	3.75	
		38 x 235	8.63	7.54	6.16	7.36	6.37	5.20	6.49	5.62	4.59	
		38 x 286	10.11	8.75	7.15	8.54	7.40	6.04	7.53	6.52	5.33	
No. 3		38 x 89	3.17	2.83	2.31	2.76	2.39	1.95	2.44	2.11	1.72	
		38 x 140	4.67	4.04	3.30	3.95	3.42	2.79	3.48	3.01	2.46	
		38 x 184	5.68	4.92	4.02	4.80	4.16	3.40	4.23	3.67	2.99	
		38 x 235	6.95	6.02	4.91	5.87	5.08	4.15	5.18	4.48	3.66	
		38 x 286	8.06	6.98	5.70	6.81	5.90	4.82	6.01	5.20	4.25	
Construction		38 x 89	3.17	2.88	2.51	2.77	2.51	2.14	2.51	2.28	1.89	
Standard		38 x 89	2.68	2.32	1.90	2.27	1.96	1.60	2.00	1.73	1.41	

# Span Tables

Table 9.23.4.2.-F (Continued)

Commercial Designation	Grade	Rafter Size, mm	Maximum Span, m									
			Specified Snow Load, kPa									
			1.0			1.5			2.0			
			Rafter Spacing, mm			Rafter Spacing, mm			Rafter Spacing, mm			
			300	400	600	300	400	600	300	400	600	
Spruce – Pine – Fir (includes Spruce (all species except Coast Sitka Spruce), Jack Pine, Lodgepole Pine, Balsam Fir and Alpine Fir)	Select Structural	38 x 89	3.22	2.92	2.55	2.81	2.55	2.23	2.55	2.32	2.03	
		38 x 140	5.06	4.60	4.02	4.42	4.02	3.51	4.02	3.65	3.19	
		38 x 184	6.65	6.05	5.28	5.81	5.28	4.61	5.28	4.80	4.19	
		38 x 235	8.50	7.72	6.74	7.42	6.74	5.89	6.74	6.13	5.35	
		38 x 286	10.34	9.40	8.21	9.03	8.21	7.17	8.21	7.46	6.52	
	No. 1 and No. 2	38 x 89	3.11	2.83	2.47	2.72	2.47	2.16	2.47	2.24	1.96	
		38 x 140	4.90	4.45	3.89	4.28	3.89	3.40	3.89	3.53	3.08	
		38 x 184	6.44	5.85	5.11	5.62	5.11	4.41	5.11	4.64	3.89	
		38 x 235	8.22	7.47	6.38	7.18	6.52	5.39	6.52	5.82	4.75	
		38 x 286	10.00	9.06	7.40	8.74	7.66	6.25	7.80	6.76	5.52	
	No. 3	38 x 89	3.06	2.78	2.31	2.67	2.39	1.95	2.43	2.11	1.72	
		38 x 140	4.67	4.04	3.30	3.95	3.42	2.79	3.48	3.01	2.46	
		38 x 184	5.68	4.92	4.02	4.80	4.16	3.40	4.23	3.67	2.99	
		38 x 235	6.95	6.02	4.91	5.87	5.08	4.15	5.18	4.48	3.66	
		38 x 286	8.06	6.98	5.70	6.81	5.90	4.82	6.01	5.20	4.25	
	Construction	38 x 89	3.06	2.78	2.43	2.67	2.43	2.12	2.43	2.20	1.93	
	Standard	38 x 89	2.78	2.41	1.97	2.35	2.04	1.66	2.07	1.79	1.47	
	Northern Species (includes any Canadian species covered by the NLGA Standard Grading Rules)	Select Structural	38 x 89	2.88	2.61	2.28	2.51	2.28	1.99	2.28	2.07	1.81
			38 x 140	4.53	4.11	3.59	3.95	3.59	3.14	3.59	3.26	2.85
			38 x 184	5.95	5.40	4.72	5.20	4.72	4.12	4.72	4.29	3.68
38 x 235			7.60	6.90	6.03	6.64	6.03	5.11	6.03	5.48	4.51	
38 x 286			9.25	8.40	7.01	8.08	7.26	5.93	7.34	6.40	5.23	
No. 1 and No. 2		38 x 89	2.81	2.55	2.23	2.46	2.23	1.95	2.23	2.03	1.77	
		38 x 140	4.42	4.02	3.44	3.86	3.51	2.91	3.51	3.14	2.56	
		38 x 184	5.81	5.13	4.19	5.00	4.33	3.54	4.41	3.82	3.12	
		38 x 235	7.24	6.27	5.12	6.12	5.30	4.33	5.40	4.67	3.82	
		38 x 286	8.40	7.27	5.94	7.10	6.15	5.02	6.26	5.42	4.43	
No. 3		38 x 89	2.62	2.27	1.85	2.22	1.92	1.57	1.95	1.69	1.38	
		38 x 140	3.74	3.24	2.65	3.16	2.74	2.24	2.79	2.42	1.97	
		38 x 184	4.56	3.94	3.22	3.85	3.33	2.72	3.40	2.94	2.40	
		38 x 235	5.57	4.82	3.94	4.71	4.08	3.33	4.15	3.60	2.94	
		38 x 286	6.46	5.60	4.57	5.46	4.73	3.86	4.82	4.17	3.41	
Construction		38 x 89	2.74	2.49	2.11	2.40	2.18	1.90	2.18	1.93	1.57	
Standard		38 x 89	2.22	1.93	1.57	1.88	1.63	1.33	1.66	1.44	1.17	

Copyright © NRC 1941 - 2021 World Rights Reserved © CNRC 1941-2021 Droits réservés pour tous pays

**Table 9.23.4.2.-G**  
**Maximum Spans for Roof Rafters – Specified Roof Snow Loads 2.5 and 3.0 kPa**  
 Forming Part of Sentences 9.3.2.8.(1), 9.23.4.2.(1) and 9.23.4.5.(1)

Commercial Designation	Grade	Rafter Size, mm	Maximum Span, m						
			Specified Snow Load, kPa						
			2.5			3.0			
			Rafter Spacing, mm			Rafter Spacing, mm			
			300	400	600	300	400	600	
Douglas Fir – Larch (includes Douglas Fir and Western Larch)	Select Structural	38 x 89	2.51	2.28	1.99	2.37	2.15	1.88	
		38 x 140	3.95	3.59	3.14	3.72	3.38	2.95	
		38 x 184	5.20	4.72	4.12	4.89	4.44	3.83	
		38 x 235	6.64	6.03	5.08	6.24	5.67	4.68	
		38 x 286	8.08	7.23	5.90	7.60	6.65	5.43	
	No. 1 and No. 2	38 x 89	2.41	2.19	1.86	2.27	2.06	1.71	
		38 x 140	3.76	3.26	2.66	3.46	3.00	2.45	
		38 x 184	4.58	3.96	3.24	4.21	3.65	2.98	
		38 x 235	5.60	4.85	3.96	5.15	4.46	3.64	
		38 x 286	6.50	5.63	4.59	5.98	5.17	4.23	
	No. 3	38 x 89	1.79	1.55	1.26	1.64	1.42	1.16	
		38 x 140	2.55	2.21	1.80	2.35	2.03	1.66	
		38 x 184	3.10	2.69	2.20	2.86	2.47	2.02	
		38 x 235	3.80	3.29	2.68	3.49	3.02	2.47	
	Construction	38 x 89	2.30	2.00	1.63	2.12	1.84	1.50	
		Standard	38 x 89	1.73	1.50	1.22	1.59	1.38	1.12
	Hem – Fir (includes Western Hemlock and Amabilis Fir)	Select Structural	38 x 89	2.48	2.25	1.97	2.33	2.12	1.85
			38 x 140	3.90	3.54	3.10	3.67	3.33	2.91
			38 x 184	5.13	4.66	4.07	4.82	4.38	3.77
			38 x 235	6.55	5.95	5.01	6.16	5.60	4.61
38 x 286			7.97	7.12	5.81	7.50	6.55	5.34	
No. 1 and No. 2		38 x 89	2.41	2.19	1.91	2.27	2.06	1.80	
		38 x 140	3.79	3.42	2.79	3.57	3.14	2.57	
		38 x 184	4.80	4.16	3.40	4.42	3.83	3.12	
		38 x 235	5.87	5.08	4.15	5.40	4.68	3.82	
		38 x 286	6.81	5.90	4.82	6.27	5.43	4.43	
No. 3		38 x 89	2.21	1.91	1.56	2.03	1.76	1.43	
		38 x 140	3.15	2.73	2.23	2.90	2.51	2.05	
		38 x 184	3.83	3.32	2.71	3.52	3.05	2.49	
		38 x 235	4.68	4.06	3.31	4.31	3.73	3.05	
Construction		38 x 89	2.33	2.09	1.71	2.20	1.93	1.57	
		Standard	38 x 89	1.81	1.57	1.28	1.66	1.44	1.18

# Span Tables

Table 9.23.4.2.-G (Continued)

Commercial Designation	Grade	Rafter Size, mm	Maximum Span, m					
			Specified Snow Load, kPa					
			2.5			3.0		
			Rafter Spacing, mm			Rafter Spacing, mm		
300	400	600	300	400	600			
Spruce – Pine – Fir (includes Spruce (all species except Coast Sitka Spruce), Jack Pine, Lodgepole Pine, Balsam Fir and Alpine Fir)	Select Structural	38 x 89	2.37	2.15	1.88	2.23	2.03	1.77
		38 x 140	3.73	3.39	2.96	3.51	3.19	2.79
		38 x 184	4.90	4.45	3.89	4.61	4.19	3.66
		38 x 235	6.26	5.69	4.97	5.89	5.35	4.68
		38 x 286	7.62	6.92	5.90	7.17	6.52	5.43
	No. 1 and No. 2	38 x 89	2.29	2.08	1.82	2.16	1.96	1.71
		38 x 140	3.61	3.28	2.86	3.40	3.08	2.66
		38 x 184	4.74	4.31	3.52	4.46	3.96	3.23
		38 x 235	6.06	5.27	4.30	5.59	4.84	3.96
		38 x 286	7.06	6.11	4.99	6.49	5.62	4.59
	No. 3	38 x 89	2.21	1.91	1.56	2.03	1.76	1.43
		38 x 140	3.15	2.73	2.23	2.90	2.51	2.05
		38 x 184	3.83	3.32	2.71	3.52	3.05	2.49
		38 x 235	4.68	4.06	3.31	4.31	3.73	3.05
		38 x 286	5.43	4.71	3.84	5.00	4.33	3.54
	Construction	38 x 89	2.25	2.05	1.77	2.12	1.93	1.63
	Standard	38 x 89	1.87	1.62	1.33	1.72	1.49	1.22
	Northern Species (includes any Canadian species covered by the NLGA Standard Grading Rules)	Select Structural	38 x 89	2.12	1.93	1.68	1.99	1.81
38 x 140			3.33	3.03	2.65	3.14	2.85	2.49
38 x 184			4.38	3.98	3.33	4.12	3.75	3.07
38 x 235			5.60	4.99	4.08	5.27	4.59	3.75
38 x 286			6.69	5.79	4.73	6.15	5.33	4.35
No. 1 and No. 2		38 x 89	2.07	1.88	1.62	1.95	1.77	1.49
		38 x 140	3.26	2.84	2.32	3.02	2.61	2.13
		38 x 184	3.99	3.46	2.82	3.67	3.18	2.60
		38 x 235	4.88	4.23	3.45	4.49	3.89	3.17
		38 x 286	5.66	4.90	4.00	5.21	4.51	3.68
No. 3		38 x 89	1.77	1.53	1.25	1.63	1.41	1.15
		38 x 140	2.52	2.19	1.78	2.32	2.01	1.64
		38 x 184	3.07	2.66	2.17	2.82	2.45	2.00
		38 x 235	3.76	3.25	2.66	3.45	2.99	2.44
		38 x 286	4.36	3.77	3.08	4.01	3.47	2.83
Construction		38 x 89	2.01	1.74	1.42	1.85	1.60	1.31
Standard		38 x 89	1.50	1.30	1.06	1.38	1.19	0.98

Copyright © NRC 1941 - 2021 World Rights Reserved © CNRC 1941-2021 Droits réservés pour tous pays



**Table 9.23.4.2.-H**  
**Maximum Spans for Built-up Floor Beams Supporting not more than One Floor<sup>(1)(2)</sup>**  
 Forming Part of Sentences 9.3.2.8.(1), 9.23.4.2.(3), 9.23.4.4.(3) and 9.23.8.1.(1)

Commercial Designation	Grade	Supported Length, m <sup>(3)(4)</sup>	Maximum Span, m <sup>(5)(6)</sup>								
			Size of Built-up Beam, mm								
			3-38x184	4-38x184	5-38x184	3-38x235	4-38x235	5-38x235	3-38x286	4-38x286	5-38x286
Douglas Fir – Larch (includes Douglas Fir and Western Larch)	Select Structural	2.4	3.36	3.70	3.99	4.30	4.73	5.09	5.23	5.66	5.99
		3.0	3.12	3.44	3.70	3.99	4.39	4.73	4.84	5.34	5.66
		3.6	2.94	3.23	3.48	3.75	4.13	4.45	4.41	5.03	5.41
		4.2	2.79	3.07	3.31	3.52	3.92	4.23	4.09	4.72	5.14
		4.8	2.67	2.94	3.17	3.29	3.75	4.04	3.82	4.41	4.92
		5.4	2.54	2.83	3.04	3.11	3.59	3.89	3.60	4.16	4.65
		6.0	2.41	2.73	2.94	2.95	3.40	3.75	3.42	3.95	4.41
	No. 1 and No. 2	2.4	2.97	3.42	3.82	3.63	4.19	4.68	4.21	4.86	5.43
		3.0	2.65	3.06	3.42	3.24	3.75	4.19	3.76	4.35	4.86
		3.6	2.42	2.80	3.13	2.96	3.42	3.82	3.44	3.97	4.44
		4.2	2.24	2.59	2.89	2.74	3.17	3.54	3.18	3.67	4.11
		4.8	2.10	2.42	2.71	2.56	2.96	3.31	2.98	3.44	3.84
		5.4	1.98	2.28	2.55	2.42	2.79	3.12	2.81	3.24	3.62
		6.0	1.88	2.17	2.42	2.29	2.65	2.96	2.66	3.07	3.44
Hem – Fir (includes Western Hemlock and Amabilis Fir)	Select Structural	2.4	3.32	3.65	3.93	4.24	4.66	5.03	5.16	5.61	5.93
		3.0	3.08	3.39	3.65	3.93	4.33	4.66	4.76	5.27	5.61
		3.6	2.90	3.19	3.44	3.70	4.08	4.39	4.35	4.96	5.34
		4.2	2.75	3.03	3.27	3.47	3.87	4.17	4.02	4.65	5.07
		4.8	2.63	2.90	3.12	3.24	3.70	3.99	3.66	4.35	4.85
		5.4	2.49	2.79	3.00	2.95	3.53	3.83	3.32	4.10	4.58
		6.0	2.28	2.69	2.90	2.70	3.35	3.70	3.04	3.87	4.35
	No. 1 and No. 2	2.4	3.11	3.55	3.82	3.80	4.39	4.88	4.41	5.10	5.70
		3.0	2.78	3.21	3.55	3.40	3.93	4.39	3.95	4.56	5.10
		3.6	2.54	2.93	3.28	3.11	3.59	4.01	3.60	4.16	4.65
		4.2	2.35	2.72	3.04	2.88	3.32	3.71	3.34	3.85	4.31
		4.8	2.20	2.54	2.84	2.69	3.11	3.47	3.12	3.60	4.03
		5.4	2.07	2.39	2.68	2.54	2.93	3.27	2.94	3.40	3.80
		6.0	1.97	2.27	2.54	2.41	2.78	3.11	2.79	3.22	3.60

Copyright © NRC 1941 - 2021 World Rights Reserved © CNRC 1941-2021 Droits réservés pour tous pays

# Span Tables

Table 9.23.4.2.-H (Continued)

Commercial Designation	Grade	Supported Length, m <sup>(3)(4)</sup>	Maximum Span, m <sup>(5)(6)</sup>								
			Size of Built-up Beam, mm								
			3-38x184	4-38x184	5-38x184	3-38x235	4-38x235	5-38x235	3-38x286	4-38x286	5-38x286
Spruce – Pine – Fir (includes Spruce (all species except Coast Sitka Spruce), Jack Pine, Lodgepole Pine, Balsam Fir and Alpine Fir)	Select Structural	2.4	3.17	3.49	3.76	4.05	4.46	4.81	4.93	5.42	5.73
		3.0	2.95	3.24	3.49	3.76	4.14	4.46	4.58	5.04	5.42
		3.6	2.77	3.05	3.29	3.54	3.90	4.20	4.31	4.74	5.11
		4.2	2.63	2.90	3.12	3.36	3.70	3.99	4.09	4.51	4.85
		4.8	2.52	2.77	2.99	3.22	3.54	3.81	3.82	4.31	4.64
		5.4	2.42	2.67	2.87	3.09	3.41	3.67	3.60	4.14	4.46
	6.0	2.34	2.57	2.77	2.95	3.29	3.54	3.32	3.95	4.31	
	No. 1 and No. 2	2.4	3.07	3.38	3.64	3.92	4.32	4.65	4.57	5.25	5.59
		3.0	2.85	3.14	3.38	3.52	4.01	4.32	4.09	4.72	5.25
		3.6	2.63	2.95	3.18	3.22	3.71	4.06	3.73	4.31	4.82
		4.2	2.44	2.80	3.02	2.98	3.44	3.84	3.46	3.99	4.46
		4.8	2.28	2.63	2.89	2.79	3.22	3.60	3.23	3.73	4.17
		5.4	2.15	2.48	2.77	2.63	3.03	3.39	3.05	3.52	3.93
	6.0	2.04	2.35	2.63	2.49	2.88	3.22	2.89	3.34	3.73	
Northern Species (includes any Canadian species covered by the NLGA Standard Grading Rules)	Select Structural	2.4	2.84	3.12	3.36	3.62	3.99	4.30	4.33	4.85	5.23
		3.0	2.63	2.90	3.12	3.34	3.70	3.99	3.88	4.47	4.85
		3.6	2.48	2.73	2.94	3.05	3.48	3.75	3.54	4.08	4.57
		4.2	2.31	2.59	2.79	2.82	3.26	3.57	3.28	3.78	4.23
		4.8	2.16	2.48	2.67	2.64	3.05	3.41	3.06	3.54	3.96
		5.4	2.04	2.35	2.57	2.49	2.87	3.21	2.89	3.34	3.73
	6.0	1.93	2.23	2.48	2.36	2.73	3.05	2.74	3.16	3.54	
	No. 1 and No. 2	2.4	2.59	2.99	3.29	3.16	3.65	4.08	3.67	4.24	4.74
		3.0	2.31	2.67	2.99	2.83	3.27	3.65	3.28	3.79	4.24
		3.6	2.11	2.44	2.73	2.58	2.98	3.33	3.00	3.46	3.87
		4.2	1.95	2.26	2.52	2.39	2.76	3.09	2.77	3.20	3.58
		4.8	1.83	2.11	2.36	2.24	2.58	2.89	2.59	3.00	3.35
		5.4	1.72	1.99	2.23	2.11	2.43	2.72	2.45	2.82	3.16
	6.0	1.64	1.89	2.11	2.00	2.31	2.58	2.32	2.68	3.00	

**Notes to Table 9.23.4.2.-H:**

- (1) Beam spans apply only where the floors serve residential areas as described in Table 4.1.5.3., or the uniformly distributed *live load* on the floors does not exceed that specified for residential areas as described in Table 4.1.5.3.
- (2) When the floors have a concrete topping of not more than 51 mm, the spans must be multiplied by 0.8.
- (3) Supported length means half the sum of the joist spans on both sides of the beam.
- (4) Straight interpolation may be used for other supported lengths.
- (5) Spans are clear spans between supports. For total span, add two bearing lengths.
- (6) 3-ply beams with supported lengths greater than 4.2 m require 114 mm bearing. All other beams require 76 mm bearing.

**Table 9.23.4.2.-1**  
**Maximum Spans for Built-up Floor Beams Supporting not more than Two Floors<sup>(1)(2)</sup>**  
 Forming Part of Sentences 9.3.2.8.(1), 9.23.4.2.(3), 9.23.4.4.(3) and 9.23.8.1.(1)

Commercial Designation	Grade	Supported Length, m <sup>(3)(4)</sup>	Maximum Span, m <sup>(5)(6)</sup>								
			Size of Built-up Beam, mm								
			3-38x184	4-38x184	5-38x184	3-38x235	4-38x235	5-38x235	3-38x286	4-38x286	5-38x286
Douglas Fir – Larch (includes Douglas Fir and Western Larch)	Select Structural	2.4	2.80	3.08	3.32	3.49	3.93	4.24	4.05	4.67	5.16
		3.0	2.55	2.86	3.08	3.12	3.60	3.93	3.62	4.18	4.67
		3.6	2.33	2.69	2.90	2.85	3.29	3.68	3.30	3.82	4.27
		4.2	2.16	2.49	2.75	2.64	3.04	3.40	2.99	3.53	3.95
		4.8	2.00	2.33	2.60	2.38	2.85	3.18	2.69	3.30	3.69
		5.4	1.82	2.20	2.45	2.17	2.68	3.00	2.45	3.08	3.48
		6.0	1.67	2.08	2.33	2.00	2.51	2.85	2.26	2.83	3.30
	No. 1 and No. 2	2.4	2.22	2.56	2.87	2.72	3.14	3.51	3.15	3.64	4.07
		3.0	1.99	2.29	2.56	2.43	2.80	3.14	2.82	3.25	3.64
		3.6	1.81	2.09	2.34	2.22	2.56	2.86	2.57	2.97	3.32
		4.2	1.68	1.94	2.17	2.05	2.37	2.65	2.38	2.75	3.07
		4.8	1.57	1.81	2.03	1.92	2.22	2.48	2.23	2.57	2.88
		5.4	1.48	1.71	1.91	1.81	2.09	2.34	2.10	2.43	2.71
		6.0	1.40	1.62	1.81	1.72	1.98	2.22	1.99	2.30	2.57
Hem – Fir (includes Western Hemlock and Amabilis Fir)	Select Structural	2.4	2.76	3.04	3.27	3.43	3.88	4.18	3.99	4.60	5.09
		3.0	2.51	2.82	3.04	2.97	3.55	3.88	3.34	4.12	4.60
		3.6	2.15	2.65	2.86	2.56	3.24	3.62	2.88	3.65	4.20
		4.2	1.90	2.40	2.72	2.26	2.85	3.35	2.55	3.21	3.87
		4.8	1.70	2.15	2.56	2.03	2.56	3.08	2.30	2.88	3.46
		5.4	1.56	1.95	2.35	1.86	2.32	2.79	2.11	2.62	3.14
		6.0	1.44	1.79	2.15	1.72	2.14	2.56	1.96	2.42	2.88
	No. 1 and No. 2	2.4	2.33	2.69	3.01	2.85	3.29	3.68	3.30	3.82	4.27
		3.0	2.08	2.41	2.69	2.55	2.94	3.29	2.96	3.41	3.82
		3.6	1.90	2.20	2.45	2.33	2.68	3.00	2.70	3.12	3.48
		4.2	1.76	2.03	2.27	2.15	2.49	2.78	2.50	2.88	3.22
		4.8	1.65	1.90	2.13	2.01	2.33	2.60	2.30	2.70	3.02
		5.4	1.55	1.79	2.00	1.86	2.19	2.45	2.11	2.54	2.84
		6.0	1.44	1.70	1.90	1.72	2.08	2.33	1.96	2.41	2.70

Copyright © NRC 1941 - 2021 World Rights Reserved © CNRC 1941-2021 Droits réservés pour tous pays

# Span Tables

Table 9.23.4.2.-I (Continued)

Commercial Designation	Grade	Supported Length, m <sup>(3)(4)</sup>	Maximum Span, m <sup>(5)(6)</sup>								
			Size of Built-up Beam, mm								
			3-38x184	4-38x184	5-38x184	3-38x235	4-38x235	5-38x235	3-38x286	4-38x286	5-38x286
Spruce – Pine – Fir (includes Spruce (all species except Coast Sitka Spruce), Jack Pine, Lodgepole Pine, Balsam Fir and Alpine Fir)	Select Structural	2.4	2.64	2.91	3.13	3.37	3.71	4.00	4.05	4.52	4.87
		3.0	2.45	2.70	2.91	3.12	3.45	3.71	3.62	4.18	4.52
		3.6	2.31	2.54	2.73	2.79	3.24	3.49	3.14	3.82	4.25
		4.2	2.07	2.41	2.60	2.46	3.04	3.32	2.77	3.50	3.95
		4.8	1.85	2.31	2.48	2.21	2.79	3.17	2.50	3.14	3.69
		5.4	1.69	2.13	2.39	2.02	2.53	3.00	2.28	2.85	3.42
	6.0	1.56	1.95	2.31	1.86	2.32	2.79	2.11	2.62	3.14	
	No. 1 and No. 2	2.4	2.41	2.79	3.03	2.95	3.41	3.81	3.42	3.95	4.42
		3.0	2.16	2.49	2.79	2.64	3.05	3.41	3.06	3.53	3.95
		3.6	1.97	2.27	2.54	2.41	2.78	3.11	2.79	3.23	3.61
		4.2	1.82	2.11	2.35	2.23	2.57	2.88	2.59	2.99	3.34
		4.8	1.71	1.97	2.20	2.09	2.41	2.69	2.42	2.79	3.12
		5.4	1.61	1.86	2.08	1.97	2.27	2.54	2.28	2.63	2.95
		6.0	1.53	1.76	1.97	1.86	2.15	2.41	2.11	2.50	2.79
Northern Species (includes any Canadian species covered by the NLGA Standard Grading Rules)		Select Structural	2.4	2.29	2.60	2.80	2.80	3.23	3.57	3.24	3.75
	3.0		2.04	2.36	2.60	2.50	2.89	3.23	2.90	3.35	3.75
	3.6		1.87	2.16	2.41	2.28	2.64	2.95	2.65	3.06	3.42
	4.2		1.73	2.00	2.23	2.11	2.44	2.73	2.45	2.83	3.17
	4.8		1.62	1.87	2.09	1.98	2.28	2.55	2.29	2.65	2.96
	5.4		1.52	1.76	1.97	1.86	2.15	2.41	2.11	2.50	2.79
	6.0	1.44	1.67	1.87	1.72	2.04	2.28	1.96	2.37	2.65	
	No. 1 and No. 2	2.4	1.94	2.24	2.50	2.37	2.73	3.06	2.75	3.17	3.55
		3.0	1.73	2.00	2.24	2.12	2.44	2.73	2.46	2.84	3.17
		3.6	1.58	1.83	2.04	1.93	2.23	2.50	2.24	2.59	2.90
		4.2	1.46	1.69	1.89	1.79	2.07	2.31	2.08	2.40	2.68
		4.8	1.37	1.58	1.77	1.67	1.93	2.16	1.94	2.24	2.51
		5.4	1.29	1.49	1.67	1.58	1.82	2.04	1.83	2.11	2.36
		6.0	1.22	1.41	1.58	1.50	1.73	1.93	1.74	2.01	2.24

**Notes to Table 9.23.4.2.-I:**

- (1) Beam spans apply only where the floors serve residential areas as described in Table 4.1.5.3., or the uniformly distributed *live load* on the floors does not exceed that specified for residential areas as described in Table 4.1.5.3.
- (2) When the floors have a concrete topping of not more than 51 mm, the spans must be multiplied by 0.8.
- (3) Supported length means half the sum of the joist spans on both sides of the beam.
- (4) Straight interpolation may be used for other supported lengths.
- (5) Spans are clear spans between supports. For total span, add two bearing lengths.
- (6) 3-ply beams require 114 mm bearing. 4-ply and 5-ply beams with supported lengths greater than 3 m require 114 mm bearing. All other beams require 76 mm bearing.

**Table 9.23.4.2.-J**  
**Maximum Spans for Built-up Floor Beams Supporting not more than Three Floors<sup>(1)(2)</sup>**  
 Forming Part of Sentences 9.3.2.8.(1), 9.23.4.2.(3), 9.23.4.4.(3) and 9.23.8.1.(1)

Commercial Designation	Grade	Supported Length, m <sup>(3)(4)</sup>	Maximum Span, m <sup>(5)(6)</sup>								
			Size of Built-up Beam, mm								
			3-38x184	4-38x184	5-38x184	3-38x235	4-38x235	5-38x235	3-38x286	4-38x286	5-38x286
Douglas Fir – Larch (includes Douglas Fir and Western Larch)	Select Structural	2.4	2.38	2.74	2.95	2.91	3.36	3.75	3.37	3.89	4.35
		3.0	2.13	2.46	2.74	2.60	3.00	3.36	2.92	3.48	3.89
		3.6	1.88	2.24	2.51	2.24	2.74	3.06	2.53	3.18	3.56
		4.2	1.66	2.08	2.32	1.99	2.49	2.84	2.25	2.81	3.29
		4.8	1.50	1.88	2.17	1.80	2.24	2.65	2.04	2.53	3.02
		5.4	1.38	1.71	2.05	1.65	2.04	2.44	1.88	2.31	2.75
	No. 1 and No. 2	6.0	1.28	1.58	1.88	1.53	1.89	2.24	1.75	2.14	2.53
		2.4	1.85	2.14	2.39	2.26	2.61	2.92	2.63	3.03	3.39
		3.0	1.66	1.91	2.14	2.02	2.34	2.61	2.35	2.71	3.03
		3.6	1.51	1.74	1.95	1.85	2.13	2.39	2.14	2.48	2.77
		4.2	1.40	1.62	1.81	1.71	1.98	2.21	1.99	2.29	2.56
		4.8	1.31	1.51	1.69	1.60	1.85	2.07	1.86	2.14	2.40
Hem – Fir (includes Western Hemlock and Amabilis Fir)	Select Structural	5.4	1.23	1.42	1.59	1.51	1.74	1.95	1.75	2.02	2.26
		6.0	1.17	1.35	1.51	1.43	1.65	1.85	1.66	1.92	2.14
		2.4	2.22	2.70	2.91	2.64	3.31	3.70	2.98	3.78	4.29
		3.0	1.85	2.35	2.70	2.21	2.79	3.31	2.50	3.14	3.78
		3.6	1.61	2.02	2.43	1.92	2.40	2.89	2.18	2.71	3.24
		4.2	1.43	1.78	2.14	1.71	2.13	2.54	1.95	2.40	2.86
	No. 1 and No. 2	4.8	1.30	1.61	1.92	1.56	1.92	2.28	1.77	2.18	2.58
		5.4	1.19	1.47	1.74	1.44	1.76	2.08	1.64	2.00	2.35
		6.0	1.11	1.36	1.61	1.34	1.63	1.92	1.53	1.85	2.18
		2.4	1.94	2.24	2.51	2.37	2.74	3.06	2.75	3.18	3.56
		3.0	1.74	2.00	2.24	2.12	2.45	2.74	2.46	2.84	3.18
		3.6	1.58	1.83	2.05	1.92	2.24	2.50	2.18	2.60	2.90
No. 1 and No. 2	4.2	1.43	1.69	1.89	1.71	2.07	2.32	1.95	2.40	2.69	
	4.8	1.30	1.58	1.77	1.56	1.92	2.17	1.77	2.18	2.51	
	5.4	1.19	1.47	1.67	1.44	1.76	2.04	1.64	2.00	2.35	
	6.0	1.11	1.36	1.58	1.34	1.63	1.92	1.53	1.85	2.18	

# Span Tables

Table 9.23.4.2.-J (Continued)

Commercial Designation	Grade	Supported Length, m <sup>(3)(4)</sup>	Maximum Span, m <sup>(5)(6)</sup>								
			Size of Built-up Beam, mm								
			3-38x184	4-38x184	5-38x184	3-38x235	4-38x235	5-38x235	3-38x286	4-38x286	5-38x286
Spruce – Pine – Fir (includes Spruce (all species except Coast Sitka Spruce), Jack Pine, Lodgepole Pine, Balsam Fir and Alpine Fir)	Select Structural	2.4	2.35	2.58	2.78	2.89	3.30	3.55	3.24	3.89	4.33
		3.0	2.02	2.40	2.58	2.40	3.00	3.30	2.71	3.42	3.89
		3.6	1.74	2.20	2.43	2.08	2.62	3.06	2.35	2.95	3.54
		4.2	1.55	1.94	2.31	1.85	2.31	2.77	2.10	2.61	3.12
		4.8	1.40	1.74	2.09	1.68	2.08	2.48	1.91	2.35	2.80
		5.4	1.28	1.59	1.90	1.54	1.90	2.26	1.76	2.16	2.55
	6.0	1.19	1.47	1.74	1.44	1.76	2.08	1.64	2.00	2.35	
	No. 1 and No. 2	2.4	2.01	2.32	2.60	2.46	2.84	3.17	2.85	3.29	3.68
		3.0	1.80	2.08	2.32	2.20	2.54	2.84	2.55	2.95	3.29
		3.6	1.64	1.90	2.12	2.01	2.32	2.59	2.33	2.69	3.01
		4.2	1.52	1.75	1.96	1.85	2.15	2.40	2.10	2.49	2.78
		4.8	1.40	1.64	1.84	1.68	2.01	2.24	1.91	2.33	2.60
5.4		1.28	1.55	1.73	1.54	1.89	2.12	1.76	2.16	2.46	
6.0	1.19	1.47	1.64	1.44	1.76	2.01	1.64	2.00	2.33		
Northern Species (includes any Canadian species covered by the NLGA Standard Grading Rules)	Select Structural	2.4	1.91	2.20	2.46	2.33	2.69	3.01	2.70	3.12	3.49
		3.0	1.70	1.97	2.20	2.08	2.41	2.69	2.42	2.79	3.12
		3.6	1.56	1.80	2.01	1.90	2.20	2.46	2.18	2.55	2.85
		4.2	1.43	1.66	1.86	1.71	2.03	2.27	1.95	2.36	2.64
		4.8	1.30	1.56	1.74	1.56	1.90	2.13	1.77	2.18	2.47
		5.4	1.19	1.47	1.64	1.44	1.76	2.01	1.64	2.00	2.33
	6.0	1.11	1.36	1.56	1.34	1.63	1.90	1.53	1.85	2.18	
	No. 1 and No. 2	2.4	1.61	1.86	2.08	1.97	2.28	2.55	2.29	2.64	2.96
		3.0	1.44	1.67	1.86	1.76	2.04	2.28	2.05	2.36	2.64
		3.6	1.32	1.52	1.70	1.61	1.86	2.08	1.87	2.16	2.41
		4.2	1.22	1.41	1.57	1.49	1.72	1.93	1.73	2.00	2.23
		4.8	1.14	1.32	1.47	1.40	1.61	1.80	1.62	1.87	2.09
5.4		1.08	1.24	1.39	1.32	1.52	1.70	1.53	1.76	1.97	
6.0	1.02	1.18	1.32	1.25	1.44	1.61	1.45	1.67	1.87		

**Notes to Table 9.23.4.2.-J:**

- (1) Beam spans apply only where the floors serve residential areas as described in Table 4.1.5.3., or the uniformly distributed *live load* on the floors does not exceed that specified for residential areas as described in Table 4.1.5.3.
- (2) When the floors have a concrete topping of not more than 51 mm, the spans must be multiplied by 0.8.
- (3) Supported length means half the sum of the joist spans on both sides of the beam.
- (4) Straight interpolation may be used for other supported lengths.
- (5) Spans are clear spans between supports. For total span, add two bearing lengths.
- (6) 3-ply beams with supported lengths greater than 4.2 m require 152 mm bearing. All other beams require 114 mm bearing.

**Table 9.23.4.2.-K**  
**Maximum Spans for Glued-Laminated Floor Beams – 20f-E Grade<sup>(1)</sup>**  
 Forming Part of Sentences 9.3.2.8.(1), 9.23.4.2.(3), 9.23.4.4.(3) and 9.23.8.1.(1)

Number of Storeys Supported	Beam Width, mm	Supported Length, m <sup>(2)(3)</sup>	Maximum Span, m <sup>(4)(5)(6)(7)</sup>						
			Beam Depth, mm						
			228	266	304	342	380	418	456
1	80	2.4	4.32	5.04	5.76	6.48	7.20	7.92	8.64
		3.0	3.87	4.51	5.15	5.80	6.44	7.09	7.73
		3.6	3.53	4.12	4.70	5.29	5.88	6.47	7.06
		4.2	3.27	3.81	4.36	4.90	5.44	5.99	6.53
		4.8	3.06	3.57	4.07	4.58	5.09	5.60	6.11
		5.4	2.88	3.36	3.84	4.32	4.80	5.28	5.76
		6.0	2.73	3.19	3.64	4.10	4.56	5.01	5.47
	130	2.4	5.51	6.43	7.35	8.26	9.18	10.10	11.02
		3.0	4.93	5.75	6.57	7.39	8.21	9.03	9.86
		3.6	4.50	5.25	6.00	6.75	7.50	8.25	9.00
		4.2	4.16	4.86	5.55	6.25	6.94	7.64	8.33
		4.8	3.90	4.54	5.19	5.84	6.49	7.14	7.79
		5.4	3.67	4.28	4.90	5.51	6.12	6.73	7.35
		6.0	3.48	4.07	4.65	5.23	5.81	6.39	6.97
2	80	2.4	3.28	3.83	4.37	4.92	5.47	6.01	6.56
		3.0	2.93	3.42	3.91	4.40	4.89	5.38	5.87
		3.6	2.68	3.12	3.57	4.02	4.46	4.91	5.36
		4.2	2.48	2.89	3.31	3.72	4.13	4.54	4.96
		4.8	2.32	2.71	3.09	3.48	3.86	4.25	4.64
		5.4	2.19	2.55	2.91	3.28	3.64	4.01	4.37
		6.0	2.07	2.42	2.77	3.11	3.46	3.80	4.15
	130	2.4	4.18	4.88	5.57	6.27	6.97	7.66	8.36
		3.0	3.74	4.36	4.99	5.61	6.23	6.85	7.48
		3.6	3.41	3.98	4.55	5.12	5.69	6.26	6.83
		4.2	3.16	3.69	4.21	4.74	5.27	5.79	6.32
		4.8	2.96	3.45	3.94	4.43	4.93	5.42	5.91
		5.4	2.79	3.25	3.72	4.18	4.64	5.11	5.57
		6.0	2.64	3.08	3.53	3.97	4.41	4.85	5.29

# Span Tables

Table 9.23.4.2.-K (Continued)

Number of Storeys Supported	Beam Width, mm	Supported Length, m <sup>(2)(3)</sup>	Maximum Span, m <sup>(4)(5)(6)(7)</sup>						
			Beam Depth, mm						
			228	266	304	342	380	418	456
3	80	2.4	2.75	3.21	3.66	4.12	4.58	5.04	5.50
		3.0	2.46	2.87	3.28	3.69	4.10	4.51	4.92
		3.6	2.24	2.62	2.99	3.37	3.74	4.11	4.49
		4.2	2.08	2.42	2.77	3.12	3.46	3.81	4.15
		4.8	1.94	2.27	2.59	2.91	3.24	3.56	3.89
		5.4	1.83	2.14	2.44	2.75	3.05	3.36	3.66
		6.0	1.74	2.03	2.32	2.61	2.90	3.19	3.48
	130	2.4	3.50	4.09	4.67	5.25	5.84	6.42	7.01
		3.0	3.13	3.66	4.18	4.70	5.22	5.74	6.27
		3.6	2.86	3.34	3.81	4.29	4.77	5.24	5.72
		4.2	2.65	3.09	3.53	3.97	4.41	4.85	5.30
		4.8	2.48	2.89	3.30	3.72	4.13	4.54	4.95
		5.4	2.34	2.72	3.11	3.50	3.89	4.28	4.67
		6.0	2.22	2.58	2.95	3.32	3.69	4.06	4.43

**Notes to Table 9.23.4.2.-K:**

- (1) Spans apply only where the floors serve residential areas as described in Table 4.1.5.3., or the uniformly distributed *live load* on the floors does not exceed that specified for residential areas as described in Table 4.1.5.3.
- (2) Supported length means half the sum of the joist spans on both sides of the beam.
- (3) Straight interpolation may be used for other supported lengths.
- (4) Spans are valid for glued-laminated timber conforming to CAN/CSA-O122 and CSA O177.
- (5) Spans are clear spans between supports. For total span, add two bearing lengths.
- (6) Provide a minimum bearing length of 89 mm. (Alternatively, the bearing length may be designed in accordance with Part 4.)
- (7) Top edge of beam assumed to be fully laterally supported by joists.



**Table 9.23.4.2.-L**  
**Maximum Spans for Built-up Ridge Beams and Lintels Supporting the Roof and Ceiling Only, No. 1 or No. 2 Grade**  
 Forming Part of Sentences 9.3.2.8.(1), 9.23.4.2.(4), 9.23.4.5.(1), 9.23.12.3.(1) and (3), and 9.23.14.10.(2)

Commercial Designation	Beam or Lintel Size, mm	Maximum Span, m <sup>(1)(2)(3)</sup>				
		Specified Snow Load, kPa				
		1.0	1.5	2.0	2.5	3.0
Douglas Fir – Larch (includes Douglas Fir and Western Larch)	3-38x184	2.65	2.28	2.03	1.85	1.71
	4-38x184	3.06	2.64	2.35	2.14	1.97
	5-38x184	3.43	2.95	2.62	2.39	2.21
	3-38x235	3.25	2.79	2.49	2.26	2.09
	4-38x235	3.75	3.22	2.87	2.61	2.41
	5-38x235	4.19	3.60	3.21	2.92	2.70
	3-38x286	3.77	3.24	2.88	2.62	2.43
	4-38x286	4.35	3.74	3.33	3.03	2.80
	5-38x286	4.86	4.18	3.72	3.39	3.13
Hem – Fir (includes Western Hemlock and Amabilis Fir)	3-38x184	2.78	2.39	2.13	1.94	1.79
	4-38x184	3.21	2.76	2.46	2.24	2.07
	5-38x184	3.59	3.09	2.75	2.50	2.31
	3-38x235	3.40	2.93	2.61	2.37	2.19
	4-38x235	3.93	3.38	3.01	2.74	2.53
	5-38x235	4.39	3.78	3.36	3.06	2.83
	3-38x286	3.95	3.40	3.02	2.75	2.54
	4-38x286	4.56	3.92	3.49	3.18	2.94
	5-38x286	5.10	4.38	3.90	3.55	3.28
Spruce – Pine – Fir (includes Spruce (all species except Coast Sitka Spruce) Jack Pine, Lodgepole Pine, Balsam Fir and Alpine Fir)	3-38x184	2.88	2.48	2.21	2.01	1.86
	4-38x184	3.30	2.86	2.55	2.32	2.14
	5-38x184	3.55	3.10	2.82	2.59	2.40
	3-38x235	3.53	3.03	2.70	2.46	2.27
	4-38x235	4.07	3.50	3.12	2.84	2.62
	5-38x235	4.54	3.91	3.49	3.17	2.93
	3-38x286	4.09	3.52	3.13	2.85	2.63
	4-38x286	4.72	4.06	3.62	3.29	3.04
	5-38x286	5.28	4.54	4.04	3.68	3.40

**Notes to Table 9.23.4.2.-L:**

- (1) Beam and lintel spans are calculated based on a maximum supported length of 4.9 m. Spans may be increased by 5% for supported lengths of not more than 4.3 m, by 10% for supported lengths of not more than 3.7 m, and by 25% for supported lengths of not more than 2.4 m.
- (2) For ridge beams, supported length means half the sum of the rafter, joist or truss spans on both sides of the beam. For lintels, supported length means half the sum of truss, roof joist or rafter spans supported by the lintel plus the length of the overhang beyond the lintel.
- (3) Provide minimum 76 mm bearing.

# Span Tables

**Table 9.23.12.3.-A**  
**Maximum Spans for Douglas Fir – Larch Lintels – No. 1 or No. 2 Grade – Non-structural Sheathing<sup>(1)</sup>**  
 Forming Part of Sentences 9.3.2.8.(1), 9.23.4.5.(1) and 9.23.12.3.(1) and (3)

Lintel Supporting	Lintel Size, <sup>(2)</sup> mm	Maximum Span, m <sup>(3)(4)</sup>						Interior Walls
		Exterior Walls						
		Specified Snow Load, kPa						
		1.0	1.5	2.0	2.5	3.0		
Limited attic storage and ceiling	2-38x89	This Area Intentionally Left Blank					1.25	
	2-38x140						1.78	
	2-38x184						2.17	
	2-38x235						2.65	
	2-38x286						3.08	
Roof and ceiling only (tributary width of 0.6 m maximum) <sup>(5)</sup>	2-38x89	2.68	2.34	2.13	1.97	1.86	1.97	
	2-38x140	4.21	3.68	3.34	3.10	2.92	3.10	
	2-38x184	5.50	4.84	4.39	4.08	3.84	4.08	
	2-38x235	6.61	5.97	5.56	5.21	4.88	5.21	
	2-38x286	7.66	6.92	6.44	6.09	5.66	6.09	
Roof and ceiling only (tributary width of 4.9 m maximum) <sup>(6)</sup>	2-38x89	1.25	1.07	0.96	0.87	0.80	0.87	
	2-38x140	1.78	1.53	1.36	1.24	1.15	1.24	
	2-38x184	2.17	1.86	1.66	1.51	1.40	1.51	
	2-38x235	2.65	2.28	2.03	1.85	1.71	1.85	
	2-38x286	3.08	2.64	2.35	2.14	1.98	2.14	
Roof, ceiling and 1 storey <sup>(3)(6)(7)</sup>	2-38x89	0.96	0.88	0.82	0.77	0.73	0.68	
	2-38x140	1.37	1.26	1.17	1.10	1.04	0.97	
	2-38x184	1.67	1.53	1.42	1.34	1.26	1.18	
	2-38x235	2.04	1.88	1.74	1.63	1.54	1.44	
	2-38x286	2.37	2.18	2.02	1.90	1.79	1.67	
Roof, ceiling and 2 storeys <sup>(3)(6)(7)</sup>	2-38x89	0.86	0.81	0.77	0.73	0.70	0.61	
	2-38x140	1.23	1.16	1.09	1.04	0.99	0.87	
	2-38x184	1.50	1.41	1.33	1.27	1.21	1.06	
	2-38x235	1.84	1.72	1.63	1.55	1.48	1.30	
	2-38x286	2.13	2.00	1.89	1.80	1.72	1.51	
Roof, ceiling and 3 storeys <sup>(3)(6)(7)</sup>	2-38x89	0.81	0.77	0.73	0.71	0.68	0.57	
	2-38x140	1.15	1.10	1.05	1.01	0.97	0.82	
	2-38x184	1.40	1.33	1.28	1.22	1.18	1.00	
	2-38x235	1.71	1.63	1.56	1.50	1.44	1.22	
	2-38x286	1.99	1.89	1.81	1.74	1.67	1.41	

**Notes to Table 9.23.12.3.-A:**

- (1) Where structural sheathing is used, lintel spans may be increased by 15%. Structural sheathing consists of a minimum 9.5 mm thick structural panel conforming to CSA O121, CSA O151, CSA O325 or CSA O437.0 fastened with at least two rows of fasteners to the exterior face of the lintel, and a single row to the top plates and studs. Fasteners shall conform to Table 9.23.3.5.-A.
- (2) A single piece of 89 mm thick lumber may be used in lieu of 2 pieces of 38 mm thick lumber on edge.
- (3) If floor joists span the full width of the *building* without support, lintel spans shall be reduced by 15% for “roof, ceiling and 1 storey,” by 20% for “roof, ceiling and 2 storeys,” and by 25% for “roof, ceiling and 3 storeys.”
- (4) For ends of lintels fully supported by walls, provide minimum 38 mm bearing for lintel spans up to 3 m, or minimum 76 mm bearing for lintel spans greater than 3 m.
- (5) Spans for 0.6 m tributary width are calculated for lintels in end walls that support only a 0.6 m width of roof and ceiling, but do not support roof joists, roof rafters or roof trusses.

**Table 9.23.12.3.-A (Continued)**

- (6) Lintel spans are calculated based on a maximum floor joist, roof joist or rafter span of 4.9 m and a maximum roof truss span of 9.8 m. Lintel spans may be increased by 5% if rafter and joist spans are no greater than 4.3 m and roof truss spans are no greater than 8.6 m. Spans may be increased by 10% if rafter and joist spans are no greater than 3.7 m and roof truss spans are no greater than 7.4 m.
- (7) Spans apply only where the floors serve residential areas as described in Table 4.1.5.3., or the uniformly distributed *live load* does not exceed that specified for residential areas as described in Table 4.1.5.3.

# Span Tables

**Table 9.23.12.3.-B**  
**Maximum Spans for Hem – Fir Lintels – No. 1 or No. 2 Grade – Non-structural Sheathing<sup>(1)</sup>**  
 Forming Part of Sentences 9.3.2.8.(1), 9.23.4.5.(1) and 9.23.12.3.(1) and (3)

Lintel Supporting	Lintel Size, <sup>(2)</sup> mm	Maximum Span, m <sup>(3)(4)</sup>						Interior Walls
		Exterior Walls						
		Specified Snow Load, kPa						
		1.0	1.5	2.0	2.5	3.0		
Limited attic storage and ceiling	2-38x89	This Area Intentionally Left Blank					1.31	
	2-38x140						1.87	
	2-38x184						2.27	
	2-38x235						2.78	
	2-38x286						3.23	
Roof and ceiling only (tributary width of 0.6 m maximum) <sup>(5)</sup>	2-38x89	2.68	2.34	2.13	1.97	1.86	1.97	
	2-38x140	4.21	3.68	3.34	3.10	2.92	3.10	
	2-38x184	5.50	4.84	4.39	4.08	3.84	4.08	
	2-38x235	6.61	5.97	5.56	5.21	4.90	5.21	
	2-38x286	7.66	6.92	6.44	6.09	5.82	6.09	
Roof and ceiling only (tributary width of 4.9 m maximum) <sup>(6)</sup>	2-38x89	1.31	1.13	1.00	0.91	0.84	0.91	
	2-38x140	1.87	1.61	1.43	1.30	1.20	1.30	
	2-38x184	2.27	1.95	1.74	1.58	1.42	1.58	
	2-38x235	2.78	2.39	2.13	1.92	1.71	1.92	
	2-38x286	3.23	2.77	2.47	2.17	1.94	2.17	
Roof, ceiling and 1 storey <sup>(3)(6)(7)</sup>	2-38x89	1.01	0.93	0.86	0.81	0.76	0.69	
	2-38x140	1.44	1.32	1.23	1.14	1.05	0.95	
	2-38x184	1.75	1.61	1.47	1.34	1.23	1.12	
	2-38x235	2.14	1.96	1.76	1.60	1.48	1.35	
	2-38x286	2.49	2.22	2.00	1.82	1.69	1.55	
Roof, ceiling and 2 storeys <sup>(3)(6)(7)</sup>	2-38x89	0.91	0.85	0.80	0.76	0.72	0.60	
	2-38x140	1.29	1.21	1.13	1.05	0.98	0.82	
	2-38x184	1.57	1.44	1.33	1.24	1.16	0.98	
	2-38x235	1.90	1.73	1.60	1.49	1.40	1.19	
	2-38x286	2.15	1.97	1.82	1.70	1.60	1.37	
Roof, ceiling and 3 storeys <sup>(3)(6)(7)</sup>	2-38x89	0.85	0.81	0.77	0.74	0.69	0.55	
	2-38x140	1.21	1.14	1.06	1.00	0.95	0.76	
	2-38x184	1.43	1.33	1.25	1.18	1.12	0.91	
	2-38x235	1.72	1.60	1.50	1.42	1.35	1.10	
	2-38x286	1.95	1.82	1.72	1.63	1.55	1.27	

**Notes to Table 9.23.12.3.-B:**

- (1) Where structural sheathing is used, lintel spans may be increased by 15%. Structural sheathing consists of a minimum 9.5 mm thick structural panel conforming to CSA O121, CSA O151, CSA O325 or CSA O437.0 fastened with at least two rows of fasteners to the exterior face of the lintel, and a single row to the top plates and studs. Fasteners shall conform to Table 9.23.3.5.-A.
- (2) A single piece of 89 mm thick lumber may be used in lieu of 2 pieces of 38 mm thick lumber on edge.
- (3) If floor joists span the full width of the *building* without support, lintel spans shall be reduced by 15% for “roof, ceiling and 1 storey,” by 20% for “roof, ceiling and 2 storeys,” and by 25% for “roof, ceiling and 3 storeys.”
- (4) For ends of lintels fully supported by walls, provide minimum 38 mm bearing for lintel spans up to 3 m, or minimum 76 mm bearing for lintel spans greater than 3 m.
- (5) Spans for 0.6 m tributary width are calculated for lintels in end walls that support only a 0.6 m width of roof and ceiling, but do not support roof joists, roof rafters or roof trusses.

**Table 9.23.12.3.-B (Continued)**

- (6) Lintel spans are calculated based on a maximum floor joist, roof joist or rafter span of 4.9 m and a maximum roof truss span of 9.8 m. Lintel spans may be increased by 5% if rafter and joist spans are no greater than 4.3 m and roof truss spans are no greater than 8.6 m. Spans may be increased by 10% if rafter and joist spans are no greater than 3.7 m and roof truss spans are no greater than 7.4 m.
- (7) Spans apply only where the floors serve residential areas as described in Table 4.1.5.3., or the uniformly distributed *live load* does not exceed that specified for residential areas as described in Table 4.1.5.3.

# Span Tables

**Table 9.23.12.3.-C**  
**Maximum Spans for Spruce – Pine – Fir Lintels – No. 1 or No. 2 Grade – Non-structural Sheathing<sup>(1)</sup>**  
 Forming Part of Sentences 9.3.2.8.(1), 9.23.4.5.(1) and 9.23.12.3.(1) and (3)

Lintel Supporting	Lintel Size, <sup>(2)</sup> mm	Maximum Span, m <sup>(3)(4)</sup>						Interior Walls
		Exterior Walls						
		Specified Snow Load, kPa						
		1.0	1.5	2.0	2.5	3.0		
Limited attic storage and ceiling	2-38x89	This Area Intentionally Left Blank					1.27	
	2-38x140						1.93	
	2-38x184						2.35	
	2-38x235						2.88	
	2-38x286						3.34	
Roof and ceiling only (tributary width of 0.6 m maximum) <sup>(5)</sup>	2-38x89	2.55	2.23	2.02	1.88	1.77	1.88	
	2-38x140	4.01	3.50	3.18	2.96	2.78	2.96	
	2-38x184	5.27	4.61	4.18	3.88	3.66	3.88	
	2-38x235	6.37	5.76	5.34	4.96	4.67	4.96	
	2-38x286	7.38	6.67	6.21	5.87	5.61	5.87	
Roof and ceiling only (tributary width of 4.9 m maximum) <sup>(6)</sup>	2-38x89	1.27	1.11	1.01	0.93	0.87	0.93	
	2-38x140	1.93	1.66	1.48	1.35	1.25	1.35	
	2-38x184	2.35	2.02	1.80	1.64	1.52	1.64	
	2-38x235	2.88	2.47	2.20	2.01	1.84	2.01	
	2-38x286	3.34	2.87	2.56	2.33	2.09	2.33	
Roof, ceiling and 1 storey <sup>(3)(6)(7)</sup>	2-38x89	1.05	0.96	0.89	0.84	0.79	0.74	
	2-38x140	1.49	1.37	1.27	1.19	1.13	1.02	
	2-38x184	1.82	1.67	1.55	1.44	1.33	1.20	
	2-38x235	2.22	2.04	1.89	1.73	1.59	1.45	
	2-38x286	2.58	2.36	2.15	1.96	1.81	1.66	
Roof, ceiling and 2 storeys <sup>(3)(6)(7)</sup>	2-38x89	0.94	0.88	0.83	0.79	0.76	0.64	
	2-38x140	1.34	1.26	1.19	1.13	1.06	0.88	
	2-38x184	1.63	1.53	1.44	1.33	1.25	1.05	
	2-38x235	1.99	1.87	1.72	1.60	1.50	1.27	
	2-38x286	2.31	2.12	1.96	1.82	1.71	1.45	
Roof, ceiling and 3 storeys <sup>(3)(6)(7)</sup>	2-38x89	0.88	0.83	0.80	0.77	0.74	0.59	
	2-38x140	1.25	1.19	1.14	1.08	1.02	0.81	
	2-38x184	1.52	1.44	1.35	1.27	1.21	0.97	
	2-38x235	1.86	1.73	1.62	1.53	1.45	1.17	
	2-38x286	2.11	1.96	1.84	1.74	1.66	1.35	

**Notes to Table 9.23.12.3.-C:**

- (1) Where structural sheathing is used, lintel spans may be increased by 15%. Structural sheathing consists of a minimum 9.5 mm thick structural panel conforming to CSA O121, CSA O151, CSA O325 or CSA O437.0 fastened with at least two rows of fasteners to the exterior face of the lintel, and a single row to the top plates and studs. Fasteners shall conform to Table 9.23.3.5.-A.
- (2) A single piece of 89 mm thick lumber may be used in lieu of 2 pieces of 38 mm thick lumber on edge.
- (3) If floor joists span the full width of the *building* without support, lintel spans shall be reduced by 15% for “roof, ceiling and 1 storey,” by 20% for “roof, ceiling and 2 storeys,” and by 25% for “roof, ceiling and 3 storeys.”
- (4) For ends of lintels fully supported by walls, provide minimum 38 mm bearing for lintel spans up to 3 m, or minimum 76 mm bearing for lintel spans greater than 3 m.
- (5) Spans for 0.6 m tributary width are calculated for lintels in end walls that support only a 0.6 m width of roof and ceiling, but do not support roof joists, roof rafters or roof trusses.

**Table 9.23.12.3.-C (Continued)**

- (6) Lintel spans are calculated based on a maximum floor joist, roof joist or rafter span of 4.9 m and a maximum roof truss span of 9.8 m. Lintel spans may be increased by 5% if rafter and joist spans are no greater than 4.3 m and roof truss spans are no greater than 8.6 m. Spans may be increased by 10% if rafter and joist spans are no greater than 3.7 m and roof truss spans are no greater than 7.4 m.
- (7) Spans apply only where the floors serve residential areas as described in Table 4.1.5.3., or the uniformly distributed *live load* does not exceed that specified for residential areas as described in Table 4.1.5.3.

## Span Tables

**Table 9.23.12.3-D**  
**Maximum Spans for Glued-Laminated Timber Lintels – 20f-E Stress Grade – Exterior Walls – Roof and Ceiling Load Only**  
 Forming Part of Sentences 9.3.2.8.(1), 9.23.4.5.(1) and 9.23.12.3.(1) and (3)

Lintel Size, mm	Maximum Span, m <sup>(1)(2)(3)</sup>														
	Specified Snow Load, kPa														
	1.0			1.5			2.0			2.5			3.0		
	Supported length, m <sup>(4)(5)</sup>			Supported length, m <sup>(4)(5)</sup>			Supported length, m <sup>(4)(5)</sup>			Supported length, m <sup>(4)(5)</sup>			Supported length, m <sup>(4)(5)</sup>		
	2.4	3.6	4.8	2.4	3.6	4.8	2.4	3.6	4.8	2.4	3.6	4.8	2.4	3.6	4.8
130 x 304	6.23	5.63	5.24	5.63	5.09	4.73	5.24	4.73	4.40	4.95	4.48	4.17	4.73	4.28	3.87
80 x 380	6.52	5.89	5.48	5.89	5.32	4.96	5.48	4.96	4.52	5.19	4.69	4.11	4.96	4.39	3.80
130 x 342	6.80	6.15	5.72	6.15	5.56	5.17	5.72	5.17	4.81	5.41	4.89	4.55	5.17	4.67	4.35
80 x 418	7.00	6.33	5.89	6.33	5.72	5.32	5.89	5.32	4.96	5.57	5.03	4.52	5.32	4.81	4.18
130 x 380	7.36	6.65	6.19	6.65	6.01	5.59	6.19	5.59	5.21	5.86	5.29	4.92	5.59	5.06	4.70
80 x 456	7.48	6.76	6.29	6.76	6.10	5.68	6.29	5.68	5.29	5.95	5.37	4.93	5.68	5.13	4.56
130 x 418	7.91	7.15	6.65	7.15	6.46	6.01	6.65	6.01	5.59	6.29	5.68	5.29	6.01	5.43	5.05
80 x 494	7.94	7.17	6.68	7.17	6.48	6.03	6.68	6.03	5.61	6.31	5.71	5.31	6.03	5.45	4.94
80 x 532	8.39	7.58	7.06	7.58	6.85	6.38	7.06	6.38	5.93	6.67	6.03	5.61	6.38	5.76	5.32
130 x 456	8.44	7.63	7.10	7.63	6.89	6.41	7.10	6.41	5.97	6.71	6.07	5.65	6.41	5.80	5.39

### Notes to Table 9.23.12.3.-D:

- (1) Spans are valid for glued-laminated timber conforming to CAN/CSA-O122 and CSA O177.
- (2) Provide minimum 89 mm bearing. (Alternatively, the bearing length may be calculated in accordance with Part 4.)
- (3) Top edge of lintel assumed to be fully laterally supported.
- (4) Supported length means half the length of trusses or rafters, plus the length of the overhang beyond the wall.
- (5) For intermediate supported lengths, straight interpolation may be used.



# Notes to Part 9

## Housing and Small Buildings

### **A-9.1.1.1.(1) Application of Part 9 to Seasonally and Intermittently Occupied Buildings.**

The National Building Code does not provide separate requirements which would apply to seasonally or intermittently occupied buildings. Without compromising the basic health and safety provisions, however, various requirements in Part 9 recognize that leniency may be appropriate in some circumstances. With greater use of "cottages" through the winter months, the proliferation of seasonally occupied multiple-dwelling buildings and the increasing installation of modern conveniences in these buildings, the number and extent of possible exceptions is reduced.

#### **Thermal Insulation**

Article 9.25.2.1. specifies that insulation is to be installed in walls, ceilings and floors which separate heated space from unheated space. Cottages intended for use only in the summer and which, therefore, have no space heating appliances, would not be required to be insulated. Should a heating system be installed at some later date, insulation should also be installed at that time. In the case of row units intended for intermittent winter use, the walls between the dwelling units may at times separate heated space from unheated space. In this case, the installation of insulation might be considered.

#### **Air Barrier Systems and Vapour Barriers**

Articles 9.25.3.1. and 9.25.4.1. require the installation of air barrier systems and vapour barriers only where insulation is installed. Dwellings with no heating system would thus be exempt from these requirements.

#### **Interior Wall and Ceiling Finishes**

The choice of interior wall and ceiling finishes has implications for fire safety. Where a dwelling is a detached building, there are no fire resistance requirements for the walls or ceilings within the dwelling. The exposed surfaces of walls and ceilings are required to have a flame-spread rating not greater than 150 (Subsection 9.10.17.). There is, therefore, considerable flexibility, even in continuously occupied dwellings, with respect to the materials used to finish these walls. Except where waterproof finishes are required (Subsection 9.29.2.), ceilings and walls may be left unfinished. Where two units adjoin, however, additional fire resistance requirements may apply to interior loadbearing walls, floors and the shared wall (Article 9.10.8.3., and Subsections 9.10.9. and 9.10.11.).

#### **Plumbing and Electrical Facilities**

Plumbing fixtures are required only where a piped water supply is available (Subsection 9.31.4.), and electrical facilities only where electrical services are available (Article 9.34.1.2.).

**A-9.3.1.7. Ratio of Water to Cementing Material.** While adding water to concrete on site may facilitate its distribution through formwork, this practice can have several undesirable results, such as reduced strength, greater porosity, and more propensity to shrinkage cracking. The ratio of water to cementing material is determined according to weight. For example, using Table 9.3.1.7., the maximum water-cement ratio of 0.45 for a 20 mm coarse aggregate would require 18 kg (or 18 L) of water (1 L of water weighs 1 kg).

---

These Notes are included for explanatory purposes only and do not form part of the requirements. The number that introduces each Note corresponds to the applicable requirement in this Part.

**A-9.3.2.1.(1) Grade Marking of Lumber.** Lumber is generally grouped for marketing into the species combinations contained in Table A-9.3.2.1.(1)-A. The maximum allowable spans for those combinations are listed in the span tables for joists, rafters and beams. Some species of lumber are also marketed individually. Since the allowable span for the northern species combination is based on the weakest species in the combination, the use of the span for this combination is permitted for any individual species not included in the Spruce-Pine-Fir, Douglas Fir-Larch and Hemlock-Fir combinations.

Facsimiles of typical grade marks of lumber associations and grading agencies accredited by the Canadian Lumber Standards (CLS) Accreditation Board to grade mark lumber in Canada are shown in Table A-9.3.2.1.(1)-B. Accreditation by the CLS Accreditation Board applies to the inspection, grading and grade marking of lumber, including mill supervisory service, in accordance with CSA O141, "Softwood Lumber."

The grade mark of a CLS accredited agency on a piece of lumber indicates its assigned grade, species or species combination, moisture condition at the time of surfacing, the responsible grader or mill of origin and the CLS accredited agency under whose supervision the grading and marking was done.

**Table A-9.3.2.1.(1)-A**  
**Species Designations and Abbreviations**  
 Forming Part of Note A-9.3.2.1.(1)

Commercial Designation of Species or Species Combination	Abbreviation Permitted on Grade Stamps	Species Included
Douglas Fir – Larch	D Fir – L (N)	Douglas Fir, Western Larch
Hemlock – Fir	Hem – Fir (N)	Western Hemlock, Amabilis Fir
Spruce – Pine – Fir	S – P – F or Spruce – Pine – Fir	White Spruce, Engelmann Spruce, Black Spruce, Red Spruce, Lodgepole Pine, Jack Pine, Alpine Fir, Balsam Fir
Northern Species	North Species	Any Canadian softwood covered by the "Standard Grading Rules for Canadian Lumber"

Canadian lumber is graded to the "Standard Grading Rules for Canadian Lumber," published by the National Lumber Grades Authority. These rules specify standard grade names and grade name abbreviations for use in grade marks to provide positive identification of lumber grades. In a similar fashion, standard species names or standard species abbreviations, symbols or marks are provided in the rules for use in grade marks.




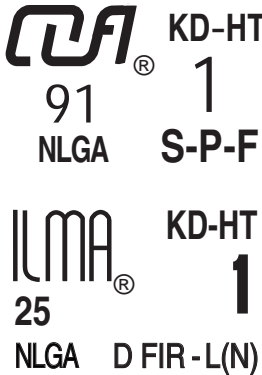

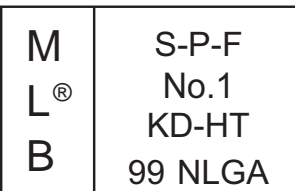
Grade marks denote the moisture content of lumber at the time of surfacing. "S-Dry" in the mark indicates the lumber was surfaced at a moisture content not exceeding 19%. "MC 15" indicates a moisture content not exceeding 15%. "S-GRN" in the grade mark signifies that the lumber was surfaced at a moisture content higher than 19% at a size to allow for natural shrinkage during seasoning.

Each mill or grader is assigned a permanent number. The point of origin of lumber is identified in the grade mark by use of a mill or grader number or by the mill name or abbreviation. The CLS certified agency under whose supervision the lumber was grade marked is identified in the mark by the registered symbol of the agency.


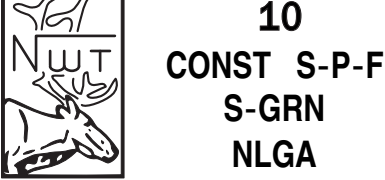

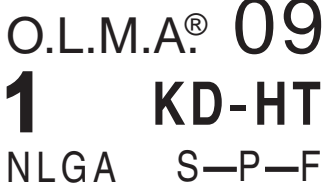

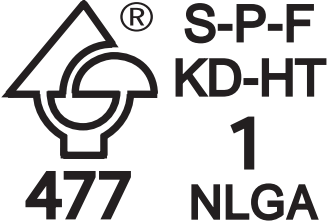
**Table A-9.3.2.1.(1)-B**  
**Facsimiles of Grade Marks Used by Canadian Lumber Manufacturing Associations and Agencies Authorized to Grade Mark Lumber in Canada**  
 Forming Part of Note A-9.3.2.1.(1)

Facsimiles of Grade Mark	Association or Agency
<p style="text-align: center;"> <b>A.F.P.A.<sup>®</sup> 00</b>  <b>S-P-F NLGA</b>  <b>KD-HT</b>  <span style="font-size: 2em; vertical-align: middle;">1</span>  <small>GG00056B</small> </p>	<p>Alberta Forest Products Association  <a href="http://www.albertaforestproducts.ca">www.albertaforestproducts.ca</a></p>

Table A-9.3.2.1(1)-B (Continued)

Facsimiles of Grade Mark	Association or Agency
 <p>GG00062B</p>	<p>Canadian Mill Services Association www.canserve.org</p>
 <p>GG00098A</p>	<p>Canadian Softwood Inspection Agency Inc. www.canadiansoftwood.com</p>
 <p>GG00058B</p>	<p>Central Forest Products Association Inc. c/o Alberta Forest Products Association www.albertaforestproducts.ca</p>
 <p>GG00057B</p>	<p>Council of Forest Industries www.cofi.org</p>
 <p>GG00064B</p>	<p>Macdonald Inspection Services Ltd. www.gradestamp.com</p>
 <p>GG00065B</p>	<p>Maritime Lumber Bureau www.mlb.ca</p>

**Table A-9.3.2.1(1)-B (Continued)**

Facsimiles of Grade Mark	Association or Agency
 <p style="text-align: center;">GG00066B</p>	<p>Newfoundland &amp; Labrador Lumber Producers' Association  <a href="http://www3.nf.sympatico.ca/nllpa">www3.nf.sympatico.ca/nllpa</a></p>
 <p style="text-align: center;">GG00067B</p>	<p>Northwest Territories Forest Industries Association</p>
 <p style="text-align: center;">GG00059B</p>	<p>Ontario Forest Industries Association  <a href="http://www.ofia.com">www.ofia.com</a></p>
 <p style="text-align: center;">GG00068B</p>	<p>Ontario Lumber Manufacturers' Association          (Home of CLA Grading and Inspection)  <a href="http://www.olma.ca">www.olma.ca</a></p>
 <p style="text-align: center;">GG00069B</p>	<p>Pacific Lumber Inspection Bureau  <a href="http://www.plib.org">www.plib.org</a></p>
 <p style="text-align: center;">GG00070B</p>	<p>Quebec Forest Industry Council          (Conseil de l'industrie forestière du Québec)  <a href="http://www.qfic.gc.ca">www.qfic.gc.ca</a></p>

Copyright © NRC 1941 - 2021 World Rights Reserved © CNRC 1941-2021 Droits réservés pour tous pays

**A-Table 9.3.2.1. Lumber Grading.** To identify board grades, the paragraph number of the NLGA “Standard Grading Rules for Canadian Lumber” under which the lumber is graded must be shown in the grade mark. Paragraph 113 is equivalent to the WWPA “Western Lumber Grading Rules” and paragraph 114 is equivalent to the WCLIB “Standard Grading Rules.” When graded in accordance with WWPA or WCLIB rules, the grade mark will not contain a paragraph number.

**A-9.3.2.8.(1) Non-Standard Lumber.** NLGA 2014, “Standard Grading Rules for Canadian Lumber,” permits lumber to be dressed to sizes below the standard sizes (38 × 89, 38 × 140, 38 × 184, etc.) provided the grade stamp shows the reduced size. This Sentence permits the use of the span tables for such lumber, provided the size indicated on the stamp is not less than 95% of the corresponding standard size. Allowable spans in the tables must be reduced a full 5% even if the undersize is less than the 5% permitted.

**A-9.3.2.9.(1) Protection from Termites.**

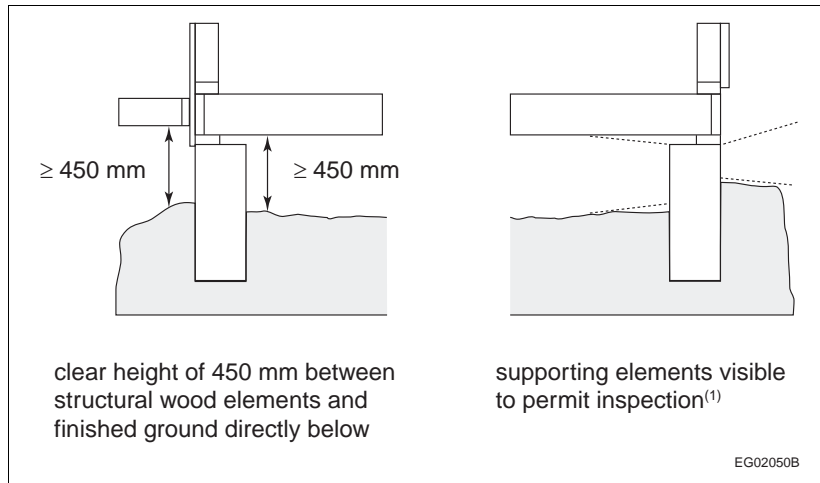


**Figure A-9.3.2.9.(1)-A**

**Known termite locations**

**Note to Figure A-9.3.2.9.(1)-A:**

(1) Reference: J.K. Mauldin (1982), N.Y. Su (1995), T. Myles (1997).



**Figure A-9.3.2.9.(1)-B**

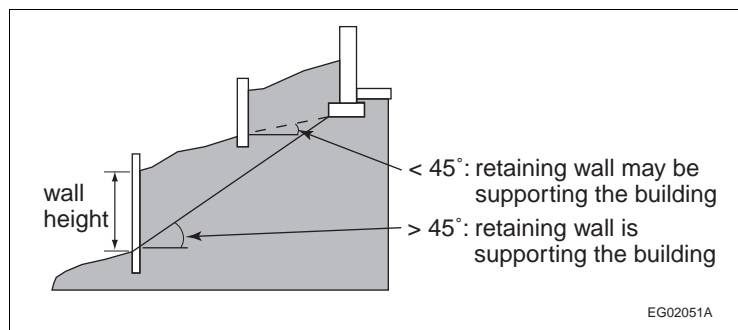
**Clearances under structural wood elements and visibility of supporting elements where required to permit inspection for termite infestation**

**Note to Figure A-9.3.2.9.(1)-B:**

(1) For the height of structural wood elements not directly above finished ground, see Article 9.23.2.3.

**A-9.3.2.9.(3) Protection of Structural Wood Elements from Moisture and Decay.** There are many above-ground, structural wood systems where precipitation is readily trapped or drying is slow, creating conditions conducive to decay. Beams extending beyond roof decks, junctions between deck members, and connections between balcony guards and walls are three examples of elements that can accumulate water when exposed to precipitation if they are not detailed to allow drainage.

**A-9.3.2.9.(4) Protection of Retaining Walls and Cribbing from Decay.** Retaining walls supporting soil are considered to be structural elements of the building if a line drawn from the outer edge of the footing to the bottom of the exposed face of the retaining wall is greater than 45° to the horizontal. Retaining walls supporting soil may be structural elements of the building if the line described above has a lower slope.



**Figure A-9.3.2.9.(4)**

**Identifying retaining walls that require preservative treatment**

Retaining walls that are not critical to the support of building foundations but are greater than 1.2 m in height may pose a danger of sudden collapse to persons adjacent to the wall if the wood is not adequately protected from decay. The height of the retaining wall or cribbing is measured as the vertical difference between the ground levels on each side of the wall.

**A-9.4.1.1. Structural Design.** Article 9.4.1.1. establishes the principle that the structural members of Part 9 buildings must

- comply with the prescriptive requirements provided in Part 9,
- be designed in accordance with accepted good practice, or
- be designed in accordance with Part 4 using the loads and limits on deflection and vibration specified in Part 9 or Part 4.

Usually a combination of approaches is used. For example, even if the snow load calculation on a wood roof truss is based on Subsection 9.4.2., the joints must be designed in accordance with Part 4. Wall framing may comply with the prescriptive requirements in Subsections 9.23.3., 9.23.10., 9.23.11. and 9.23.12., while the floor framing may be engineered.

Design according to Part 4 or accepted good engineering practice, such as that described in CWC 2014, “Engineering Guide for Wood Frame Construction,” requires engineering expertise. The CWC Guide contains alternative solutions and provides information on the applicability of the Part 9 prescriptive structural requirements to further assist designers and building officials to identify the appropriate design approach. The need for professional involvement in the structural design of a building, whether to Part 4 or Part 9 requirements or accepted good practice, is defined by provincial and territorial legislation.

**A-9.4.2.1.(1) Soft Conversion from Imperial Units.** The conversion table at the end of the Code provides factors for the conversion of millimeters to inches. However, not all metric measurements stated in the Code are exact conversions. For example, while the dimensions given for wood framing members are the exact dimensions of the milled product—i.e., what is commonly referred to as a “2 x 4” is actually 1.5 in. x 3.5 in., which, in mm, is 38 x 89—the metric dimensions given for spacing between framing elements are actually soft conversions:

**Table A-9.4.2.1.(1)**

Imperial Unit	Exact Metric Conversion	Soft Metric Conversion Used in Code
12 in.	305 mm	300 mm
16 in.	406 mm	400 mm
24 in.	610 mm	600 mm

It remains common construction practice to arrange joists, rafters and studs in 12, 16 or 24 in. increments so as to properly align them with the edges of sheathing materials. It is therefore assumed that structural elements will be spaced according to the actual metric equivalents.

**A-9.4.2.2. Application of Simplified Part 9 Snow Loads.** The simplified specified snow loads described in Article 9.4.2.2. may be used where the structure is of the configuration that is typical of traditional wood-frame residential construction and its performance. This places limits on the spacing of joists, rafters and trusses, the spans of these members and supporting members, deflection under load, overall dimensions of the roof and the configuration of the roof. It assumes considerable redundancy in the structure.

Because very large buildings may be constructed under Part 9 by constructing firewalls to break up the building area, it is possible to have Part 9 buildings with very large roofs. The simplified specified snow loads may not be used when the total roof area of the overall structure exceeds 4 550 m<sup>2</sup>. Thus, the simplified specified snow load calculation may be used for typical townhouse construction but would not be appropriate for much larger commercial or industrial buildings, for example.

The simplified specified snow loads are also not designed to take into account roof configurations that seriously exacerbate snow accumulation. This does not pertain to typical projections above a sloped roof, such as dormers, nor does it pertain to buildings with higher and lower roofs. Although two-level roofs generally lead to drift loading, smaller light-frame buildings constructed according to Part 9 have not failed under these loads. Consequently, the simplified calculation may be used in these cases. Rather, this limitation on application of the simplified calculation pertains to roofs with high parapets or significant other projections above the roof, such as elevator penthouses, mechanical rooms or larger equipment that would effectively collect snow and preclude its blowing off the roof.

The reference to Article 9.4.3.1. invokes, for roof assemblies other than common lumber trusses, the same performance criteria for deflection.

The specific weight of snow on roofs,  $\gamma$ , obtained from measurements at a number of weather stations across Canada varied from about 1.0 to 4.5 kN/m<sup>3</sup>. An average value for use in design in lieu of better local data is  $\gamma = 3.0$  kN/m<sup>3</sup>. In some locations the specific weight of snow may be considerably greater than 3.0 kN/m<sup>3</sup>. Such locations include regions where the maximum snow load on the roof is reached only after contributions from many snowstorms, coastal regions, and regions where winter rains are considerable and where a unit weight as high as 4.0 kN/m<sup>3</sup> may be appropriate.

**A-9.4.2.3.(1) Accessible Platforms Subject to Snow and Occupancy Loads.** Many platforms are subject to both occupancy loads and snow loads. These include balconies, decks, verandas, flat roofs over garages and carports. Where such a platform, or a segregated area of such a platform, serves a single dwelling unit, it must be designed for the greater of either the specified snow load or an occupancy load of 1.9 kPa. Where the platform serves more than one single dwelling unit or an occupancy other than a residential occupancy, higher occupancy loads will apply as specified in Table 4.1.5.3.

**A-9.4.2.4.(1) Specified Loads for Attics or Roof Spaces with Limited Accessibility.** Typical residential roofs are framed with roof trusses and the ceiling is insulated.

Residential trusses are placed at 600 mm on centre with web members joining top and bottom chords. Lateral web bracing is installed perpendicular to the span of the trusses. As a result, there is limited room for movement inside the attic or roof space or for storage of material. Access hatches are generally built to the minimum acceptable dimensions, further limiting the size of material that can be moved into the attic or roof space.

With exposed insulation in the attic or roof space, access is not recommended unless protective clothing and breathing apparatus are worn.

Thus the attic or roof space is recognized as uninhabitable and loading can be based on actual dead load. In emergency situations or for the purpose of inspection, it is possible for a person to access the attic or roof space without over-stressing the truss or causing damaging deflections.

**A-Table 9.4.4.1. Classification of Soils.** Sand or gravel may be classified by means of a picket test in which a 38 mm by 38 mm picket beveled at the end at 45° to a point is pushed into the soil. Such material is classified as “dense or compact” if a man of average weight cannot push the picket more than 200 mm into the soil and “loose” if the picket penetrates 200 mm or more.

Clay and silt may be classified as “stiff” if it is difficult to indent by thumb pressure, “firm” if it can be indented by moderate thumb pressure, “soft” if it can be easily penetrated by thumb pressure, where this test is carried out on undisturbed soil in the wall of a test pit.

**A-9.4.4.4.(1) Soil Movement.** In susceptible soils, changes in temperature or moisture content can cause significant expansion and contraction. Soils containing pyrites can expand simply on exposure to air.

#### **Expansion and Contraction due to Moisture**

Clay soils are most prone to expansion and contraction due to moisture. Particularly wet seasons can sufficiently increase the volume of the soil under and around the structure to cause heaving of foundations and floors-on-ground, or cracking of foundation walls. Particularly dry seasons or draw-down of water by fast-growing trees can decrease the volume of the soil supporting foundations and floors-on-ground, thus causing settling.

#### **Frost Heave**

Frost heave is probably the most commonly recognized phenomenon related to freezing soil. Frost heave results when moisture in frost-susceptible soil (clay and silt) under the footings freezes and expands. This mechanism is addressed by requirements in Section 9.12. regarding the depth of excavations.

#### **Ice Lenses**

When moisture in frost-susceptible soils freezes, it forms an ice lens and reduces the vapour pressure in the soil in the area immediately around the lens. Moisture in the ground redistributes to rebalance the vapour pressures providing more moisture in the area of the ice lens. This moisture freezes to the lens and the cycle repeats itself. As the ice lens grows, it exerts pressure in the direction of heat flow. When lenses form close to foundations and heat flow is toward the foundation—as may be the case with unheated crawl spaces or open concrete block foundations insulated on the interior—the forces may be sufficient to crack the foundation.

#### **Adfreezing**

Ice lenses can adhere themselves to cold foundations. Where heat flow is essentially upward, parallel to the foundation, the pressures exerted will tend to lift the foundation. This may cause differential movement or cracking of the foundation. Heat loss through basement foundations of cast-in-place concrete or concrete block insulated on the exterior appears to be sufficient to prevent adfreezing. Care must be taken where the



foundation does not enclose heated space or where open block foundations are insulated on the interior. The installation of semi-rigid glass fibre insulation has demonstrated some effectiveness as a separation layer to absorb the adfreezing forces.

### Pyrites

Pyrite is the most common iron disulphide mineral in rock and has been identified in rock of all types and ages. It is most commonly found in metamorphic and sedimentary rock, and especially in coal and shale deposits.

Weathering of pyritic shale is a chemical-microbiological oxidation process that results in volume increases that can heave foundations and floors-on-ground. Concentrations of as little as 0.1% by weight have caused heaving. Weathering can be initiated simply by exposing the pyritic material to air. Thus, building on soils that contain pyrites in concentrations that will cause damage to the building should be avoided, or measures should be taken to remove the material or seal it. Material containing pyrites should not be used for backfill at foundations or for supporting foundations or floors-on-ground.

Where it is not known if the soil or backfill contains pyritic material in a deleterious concentration, a test is available to identify its presence and concentration.

### References:

- (1) Legget, R.F. and Crawford, C.B. Trees and Buildings. Canadian Building Digest 62, Division of Building Research, National Research Council Canada, Ottawa, 1965.
- (2) Hamilton, J.J. Swelling and Shrinking Subsoils. Canadian Building Digest 84, Division of Building Research, National Research Council Canada, Ottawa, 1966.
- (3) Hamilton, J.J. Foundations on Swelling and Shrinking Subsoils. Canadian Building Digest 184, Division of Building Research, National Research Council Canada, Ottawa, 1977.
- (4) Penner, W., Eden, W.J., and Gratten-Bellew, P.E. Expansion of Pyritic Shales. Canadian Building Digest 152, Division of Building Research, National Research Council Canada, Ottawa, 1975.
- (5) Swinton, M.C., Brown, W.C., and Chown, G.A. Controlling the Transfer of Heat, Air and Moisture through the Building Envelope. Small Buildings - Technology in Transition, Building Science Insight '90, Institute for Research in Construction, National Research Council Canada, Ottawa, 1990.

**A-9.4.4.6. and 9.15.1.1. Loads on Foundations.** The prescriptive solutions provided in Part 9 relating to footings and foundation walls only account for the loads imposed by drained earth. Drained earth is assumed to exert a load equivalent to the load that would be exerted by a fluid with a density of 480 kg/m<sup>3</sup>. The prescriptive solutions do not account for surcharges from saturated soil or additional loads from heavy objects located adjacent to the building. Where such surcharges are expected, the footings and foundation walls must be designed and constructed according to Part 4.

**A-9.5.1.2. Combination Rooms.** If a room draws natural light and natural ventilation from another area, the opening between the two areas must be large enough to effectively provide sufficient light and air. This is why a minimum opening of 3 m<sup>2</sup> is required, or the equivalent of a set of double doors. The effectiveness of the transfer of light and air also depends on the size of the transfer opening in relation to the size of the dependent room; in measuring the area of the wall separating the two areas, the whole wall on the side of the dependent room should be considered, not taking into account offsets that may be in the surface of the wall.

The opening does not necessarily have to be in the form of a doorway; it may be an opening at eye level. However, if the dependent area is a bedroom, provision must be made for the escape window required by Article 9.9.10.1. to fulfill its safety function. This is why a direct passage is required between the bedroom and the other area; the equivalent of at least a doorway is therefore required for direct passage between the two areas.

**A-9.5.5.3. Doorways to Rooms with a Bathtub, Shower or Water Closet.** The intent of Article 9.5.5.3. is to ensure a certain degree of barrier-free access to rooms that provide some or all of the facilities found in a typical residential bathroom.

If the minimum 860 mm hallway serves more than one room with identical facilities, only one of the rooms is required to have a door not less than 760 mm wide.

If a number of rooms have different facilities, for example, one room has a shower, lavatory and water closet, and another room has a lavatory and water closet, the room with the shower, lavatory and water closet must have the minimum 760 mm wide door. Where multiple rooms provide the same or similar facilities, one of these rooms must comply with the requirement to have at least one bathtub or shower, one lavatory and one

water closet. Where the fixtures are located in two separate rooms served by the same hallway, the requirement for the minimum doorway width would apply to both rooms.

If the minimum 860 mm hallway does not serve any room containing a bathtub, shower and water closet, additional fixtures do not need to be installed.

**A-9.6.1.2.(2) Mirrored Glass Doors.** CAN/CGSB-82.6-M, “Doors, Mirrored Glass, Sliding or Folding, Wardrobe,” covers mirrored glass doors for use on reach-in closets. It specifies that such doors are not to be used for walk-in closets.

**A-9.6.1.3.(2) Maximum Glass Area.** Tables 9.6.1.3.-A to 9.6.1.3.-F are based on CAN/CGSB-12.20-M, “Structural Design of Glass for Buildings,” and the wind load provisions in Article 4.1.7.3. The maximum glass area values given in these Tables are intended to be equal to or smaller than those that would be determined using the standard and wind load provisions directly to design for each individual case.

**A-Table 9.6.1.3. Glass in Doors.** Maximum areas in Table 9.6.1.3.-G for other than fully tempered glazing are cut off at 1.50 m<sup>2</sup>, as this would be the practical limit after which safety glass would be required by Sentence 9.6.1.4.(2).

**A-9.7.3.2.(1)(a) Minimizing Condensation.** The total prevention of condensation on the surfaces of fenestration products is difficult to achieve and, depending on the design and construction of the window or door, may not be absolutely necessary. Clause 9.7.3.2.(1)(a) therefore requires that condensation be minimized, which means that the amount of moisture that condenses on the inside surface of a window, door or skylight, and the frequency at which this occurs, must be limited. The occurrence of such condensation must be sufficiently rare, the accumulation of any water must be sufficiently small, and drying must be sufficiently rapid to prevent the deterioration of moisture-susceptible materials and the growth of fungi.

#### **A-9.7.4.2.(1) Standards Referenced for Windows, Doors and Skylights.**

##### **Canadian Requirements in the Harmonized Standard**

In addition to referencing the Canadian Supplement, CSA A440S1, “Canadian Supplement to AAMA/WDMA/CSA 101/I.S.2/A440, NAFS – North American Fenestration Standard/Specification for Windows, Doors, and Skylights,” the Harmonized Standard, AAMA/WDMA/CSA 101/I.S.2/A440, “NAFS – North American Fenestration Standard/Specification for Windows, Doors, and Skylights,” contains some Canada-specific test criteria.

##### **Standards Referenced for Excluded Products**

Clause 1.1, General, of the Harmonized Standard defines the limits to the application of the standard with respect to various types of fenestration products. A list of exceptions to the application statement identifies a number of standards that apply to excluded products. Compliance with those standards is not required by the Code; the references are provided for information purposes only.

##### **Label Indicating Performance and Compliance with Standard**

The Canadian Supplement requires that a product’s performance ratings be indicated on a label according to the designation requirements in the Harmonized Standard and that the label include

- design pressure, where applicable,
- negative design pressure, where applicable,
- water penetration test pressure, and
- the Canadian air infiltration and exfiltration levels.

It should be noted that, for a product to carry a label in Canada, it must meet all of the applicable requirements of both the Harmonized Standard and the Canadian Supplement, including the forced entry requirements.

##### **Water Penetration Resistance**

For the various performance grades listed in the Harmonized Standard, the corresponding water penetration resistance test pressures are a percentage of the design pressure. For R-class products, water penetration resistance test pressures are 15% of design pressure. In Canada, driving rain wind pressures (DRWP) have been determined for the locations listed in Appendix C.

To achieve equivalent levels of water penetration resistance for all locations, the Canadian Supplement includes a provision for calculating specified DRWP at the building site considering building exposure. Specified DRWP values are, in some cases, greater than 15% of design pressure and, in other cases, less than 15% of design pressure. For a fenestration product to comply with the Code, it must be able to resist the structural and water penetration loads at the building site. Reliance on a percentage of design pressure for water penetration resistance in the selection of an acceptable fenestration product will not always be adequate. Design pressure values are reported on a secondary designator, which is required by the Canadian Supplement to be affixed to the window. The DRWP given in the Canadian Supplement should be used for all products covered in the scope of the Harmonized Standard.

### Uniform Load Structural Test

The Harmonized Standard specifies that fenestration products be tested at 150% of design pressure for wind (specified wind load) and that skylights and roof windows be tested at 200% of design pressure for snow (specified snow load). With the change in the NBC 2005 to a 1-in-50 return period for wind load, a factor of 1.4 rather than 1.5 is now applied for wind. The NBC has traditionally applied a factor of 1.5 rather than 2.0 for snow. Incorporating these lower load factors into the Code requirements for fenestration would better reflect acceptable minimum performance levels; however, this has not been done in order to avoid adding complexity to the Code, to recognize the benefits of Canada-US harmonization, and to recognize that differentiation of products that meet the Canadian versus the US requirements would add complexity for manufacturers, designers, specifiers and regulatory officials.

### Condensation Resistance

The Harmonized Standard identifies three test procedures that can be used to determine the condensation resistance of windows and doors. Only the physical test procedure given in CSA A440.2, "Fenestration Energy Performance," which is referenced in Table 9.7.3.3., can be used to establish Temperature Index (I) values. Computer simulation tools can also be used to estimate the relative condensation resistance of windows, but these methods employ different expressions of performance known as Condensation Resistance Factors (CR). I and CR values are not interchangeable.

Where removable multiple glazing panels (RMGP) are installed on the inside of a window, care should be taken to hermetically seal the RMGP against the leakage of moisture-laden air from the interior into the cavity on the exterior of the RMGP because the moisture transported by the air could lead to significant condensation on the interior surface of the outside glazing.

### Basement Windows

Clause 12.4.2, Basement Windows, of the Harmonized Standard refers to products that are intended to meet Code requirements for ventilation and emergency egress. The minimum test size of 800 mm x 360 mm (total area of 0.288 m<sup>2</sup>) specified in the standard will not provide the minimum openable area required by the Code for bedrooms (i.e. 0.35 m<sup>2</sup> with no dimension less than 380 mm) and the means to provide minimum open area identified in the standard is inconsistent with the requirements of the Code (see Subsection 9.9.10. for bedroom windows). The minimum test size specified in the standard will also not provide the minimum ventilation area of 0.28 m<sup>2</sup> required for non-heating-season natural ventilation (see Article 9.32.2.2.).

### Greenhouse Windows

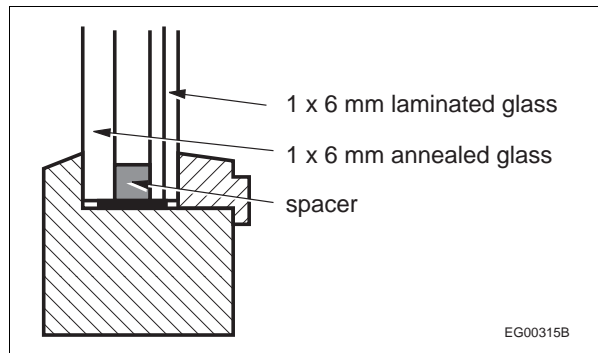
Greenhouse-type windows feature a sloped, roof-like top portion, which is subjected to the same snow loads as roofs. The Canadian Supplement only applies the snow load calculation to skylights, which do not include greenhouse windows according to the definition for skylights given in the Canadian Supplement and the Harmonized Standard. Where such windows are used, it is recommended that snow loads on the top portion of the window be taken into account.

### Performance of Doors: Limited Water Ingress Control

While the control of precipitation ingress is a performance requirement for exterior doors, side-hinged doors can comply with the referenced standard, AAMA/WDMA/CSA 101/I.S.2/A440, "NAFS – North American Fenestration Standard/Specification for Windows, Doors, and Skylights," when tested at a pressure differential of 0 Pa (0.0 psf) or higher, but less than the minimum test pressure required for the indicated performance class and performance grade. Such doors are identified with a "Limited Water" (LW) rating on the product label.

There is no restriction on the use of side-hinged doors having a limited water designation when the tested water penetration resistance of such doors is equal to or greater than the specified Driving Rain Wind Pressure for the building location, as stated in Clause A.4.4 of CSA A440S1, "Canadian Supplement to AAMA/WDMA/CSA 101/I.S.2/A440, NAFS – North American Fenestration Standard/Specification for Windows, Doors, and Skylights." When an LW door does not have sufficient water penetration resistance for the building location, Clause B.5.3.3 of CSA A440S1 states that these doors should only be used and installed in a protected location, such as under a porch roof. Other protected locations would be behind a storm door, or a door separating conditioned space from unconditioned space, such as in cold storage rooms. The Exposure Nomograph in Annex A of CAN/CSA-A440.4, "Window, Door, and Skylight Installation," provides an acceptable method to determine whether a door is considered protected, which depends on overhang ratio, and the terrain and moisture index of the building location. A door with an LW rating and a low exposure could provide acceptable water penetration resistance. However, given that the Exposure Nomograph in Annex A of CAN/CSA-A440.4 does not account for the intensity of wind driven rain, a door with an LW rating may not provide appropriate protection in some locations. In such cases, the risk of water penetration may remain the same as if the overhead protection were not provided.

**A-9.7.5.2.(1) Forced Entry Via Glazing in Doors and Sidelights.** There is no mandatory requirement that special glass be used in doors or sidelights, primarily because of cost. It is, however, a common method of forced entry to break glass in doors and sidelights to gain access to door hardware and unlock the door from the inside. Although insulated glass provides increased resistance over single glazing, the highest resistance is provided by laminated glass. Tempered glass, while stronger against static loads, is prone to shattering under high, concentrated impact loads.



**Figure A-9.7.5.2.(1)**  
**Combined laminated/annealed glazing**

Laminated glass is more expensive than annealed glass and must be used in greater thicknesses. Figure A-9.7.5.2.(1) shows an insulated sidelight made of one pane of laminated glass and one pane of annealed glass. This method reduces the cost premium that would result if both panes were laminated.

Consideration should be given to using laminated glazing in doors and accompanying sidelights regulated by Article 9.6.1.3., in windows located within 900 mm of locks in such doors, and in basement windows.

Underwriters' Laboratories of Canada have produced ULC-S332, "Burglary Resisting Glazing Material," which provides a test procedure to evaluate the resistance of glazing to attacks by thieves. While it is principally intended for plate glass show windows, it may be of value for residential purposes.

**A-9.7.5.2.(2) Resistance of Doors To Forced Entry.** This Sentence designates standard ASTM F 476, "Security of Swinging Door Assemblies," as an alternative to compliance with the prescriptive requirements for doors and hardware. The annex to the standard provides four security classifications, with acceptance criteria, depending on the type of building and the crime rate of the area in which it is located. The NBC only specifies Grade 10, the minimum level. The annex suggests the following guidelines be followed when selecting security levels for door assemblies:

**Grade 10:** This is the minimum security level and is quite adequate for single-family residential buildings located in stable, low-crime areas.

**Grade 20:** This is the low-medium security level and is designed to provide security for residential buildings located in average crime-rate areas and for apartments in both low and average crime-rate areas.

Grade 30: This is the medium-high security level and is designed to provide security for residential buildings located in higher than average crime-rate areas or for small commercial buildings in average or low crime-rate areas.

Grade 40: This is the high security level and is designed for small commercial buildings located in high crime-rate areas. This level could also be used for residential buildings having an exceptionally high incidence of semi-skilled burglary attacks.

All these grades satisfy the Code and can be considered for use where a higher level of security is desired or warranted.

**A-9.7.5.2.(6) Door Fasteners.** The purpose of the requirement for 30 mm screw penetration into solid wood is to prevent the door from being dislodged from the jamb due to impact forces. It is not the intent to prohibit other types of hinges or strikeplates that are specially designed to provide equal or greater protection.

**A-9.7.5.2.(8) Hinged Doors.** Methods of satisfying this Sentence include either using non-removable pin hinges or modifying standard hinges by screw fastening a metal pin in a screw hole in one half of the top and bottom hinges. When the door is closed, the projecting portion of the pin engages in the corresponding screw hole in the other half of the hinge and then, even if the hinge pin is taken out, the door cannot be removed.

**A-9.7.5.3.(1) Resistance of Windows to Forced Entry.** Although this Sentence only applies to windows within 2 m of adjacent ground level, certain house and site features, such as balconies or canopy roofs, allow for easy access to windows at higher elevations. Consideration should be given to specifying break-in resistant windows in such locations.

This Sentence does not apply to windows that do not serve the interior of the dwelling unit, such as windows to garages, sun rooms or greenhouses, provided connections between these spaces and the dwelling unit are secure.

One method that is often used to improve the resistance of windows to forced entry is the installation of metal “security bars.” However, while many such installations are effective in increasing resistance to forced entry, they may also reduce or eliminate the usefulness of the window as an exit in case of fire or other emergency that prevents use of the normal building exits. Indeed, unless such devices are easily openable from the inside, their installation in some cases would contravene the requirements of Article 9.9.10.1., which requires every bedroom that does not have an exterior door to have at least one window that is large enough and easy enough to open that it can be used as an exit in case of emergency. Thus an acceptable security bar system should be easy to open from the inside while still providing increased resistance to entry from the outside.

**A-9.8.3.1. Permitted Stair Configurations.**

**Table A-9.8.3.1.  
Permitted Stair Configurations**

Location/Use of Stairs	Configuration of Stair Treads				
	Straight Flight with Rectangular Treads	Curved Flight with Tapered Treads	Winders	Flight with a mix of Rectangular Treads and Tapered Treads	Spiral Stairs
Stairs within dwelling units	Permitted <sup>(1)</sup>	Permitted <sup>(2)</sup>	Permitted <sup>(3)</sup>	Permitted <sup>(4)</sup>	Permitted <sup>(5)</sup>
Public stairs			Not permitted	Not permitted	
Exit stairs		Permitted <sup>(6)</sup>			Not permitted

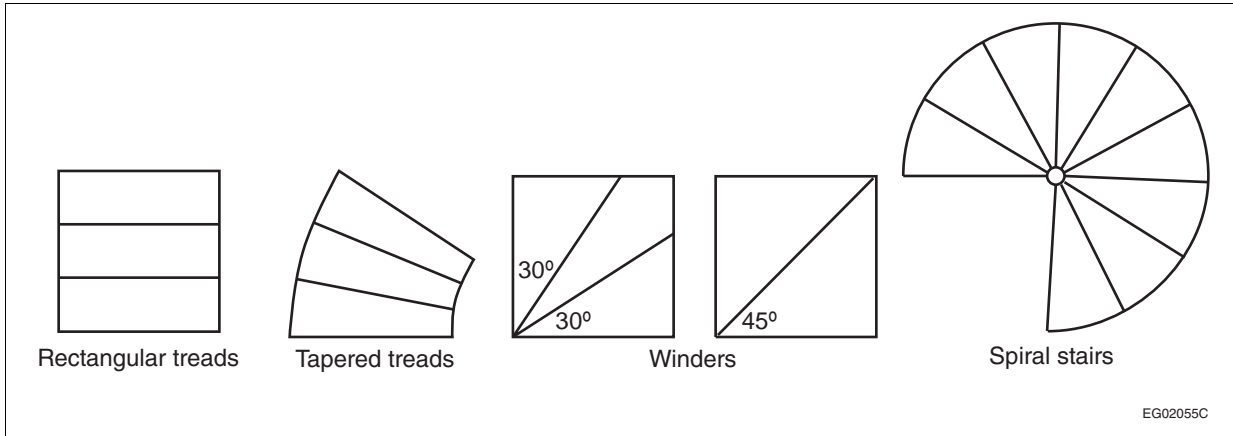
**Notes to Table A-9.8.3.1.:**

- (1) See Articles 9.8.4.1. and 9.8.4.2.
- (2) See Articles 9.8.4.1. and 9.8.4.3.
- (3) See Article 9.8.4.6.
- (4) See Article 9.8.4.5.
- (5) See Article 9.8.4.7.
- (6) See Articles 3.4.6.9. and 9.8.4.3.

**A-9.8.4. Tread Configurations.** The Code distinguishes four principal types of stair treads :

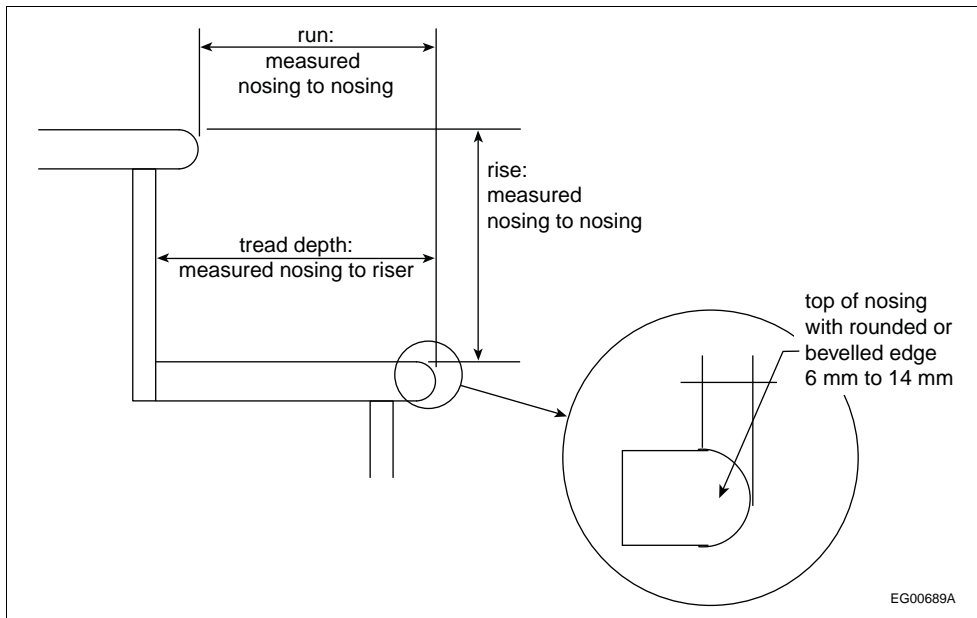
- rectangular treads, which are found in straight flights;
- tapered treads, which are found in curved flights;
- winders are described in Note A-9.8.4.6.; and
- spiral stairs, which are described in Note A-9.8.4.7.

See Figure A-9.8.4.-A.



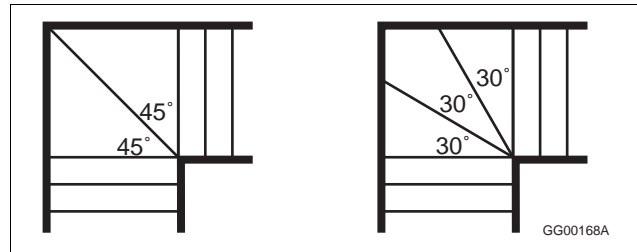
**Figure A-9.8.4.-A**  
**Types of treads**

Articles 9.8.4.1. to 9.8.4.8. specify various dimensional limits for steps. Figure A-9.8.4.-B illustrates the elements of a step and how these are to be measured.



**Figure A-9.8.4.-B**  
**Elements of steps and their measurement**

**A-9.8.4.6. Winders.** Where a stair must turn, the safest method of incorporating the turn is to use a landing. Within a dwelling unit, however, where occupants are familiar with their environment, winders are an acceptable method of reducing the amount of floor area devoted to the stair and have not been shown to be more hazardous than a straight run of steps. Nevertheless, care is required to ensure that winders are as safe as possible. Experience has shown that 30° winders are the best compromise and require the least change in the natural gait of the stair user; 45° winders are also acceptable, as they are wider. The Code permits only these two angles. Although it is normal Code practice to specify upper and lower limits, in this case it is necessary to limit the winders to specific angles with no tolerance above or below these angles other than normal construction tolerances. One result of this requirement is that winder-type turns in stairs are limited to 30° or 45° (1 winder), 60° (2 winders), or 90° (2 or 3 winders). See Figure A-9.8.4.6.

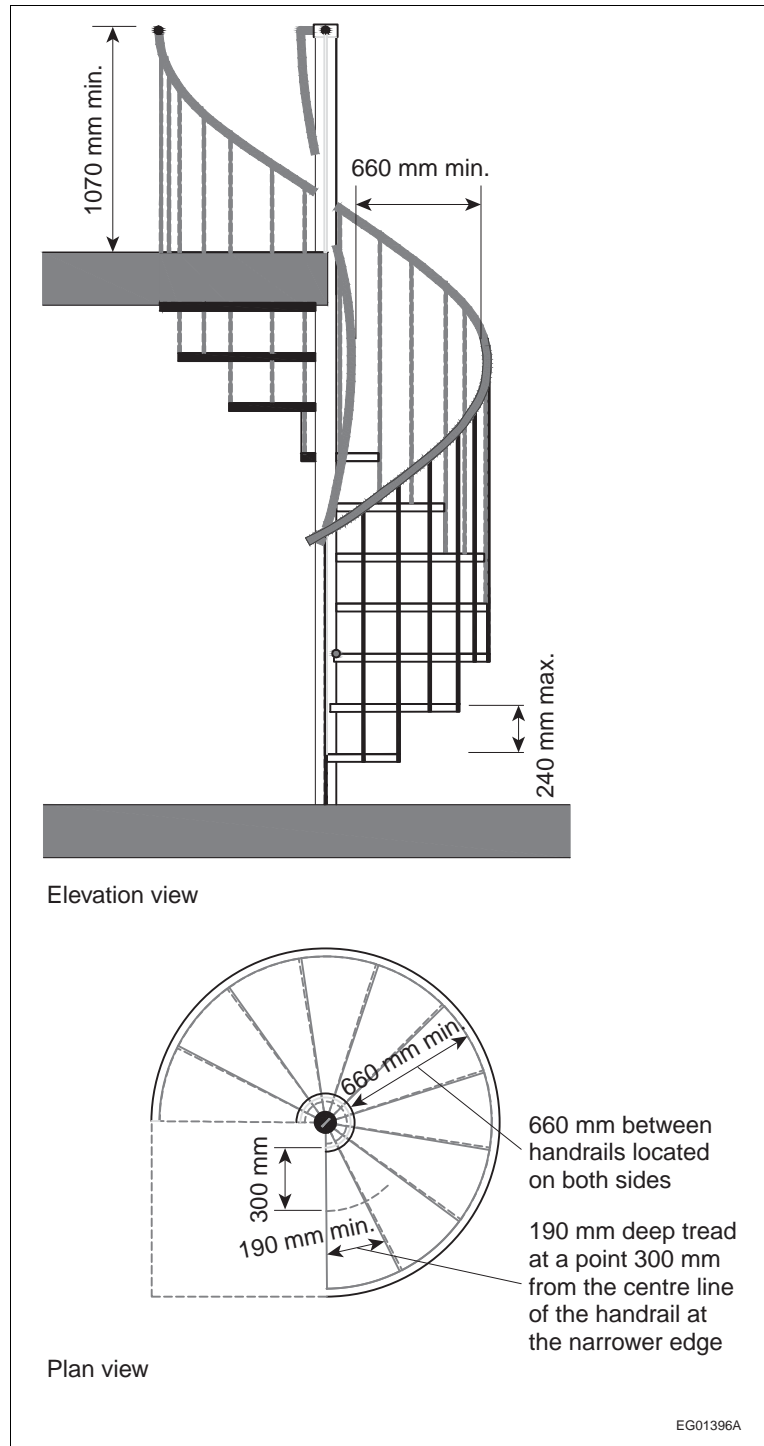


**Figure A-9.8.4.6.**  
**Winders**

**A-9.8.4.7. Spiral Stairs.** A spiral stair is typically described as a stair with a circular plan having uniform treads that radiate from and wind around a common central post or supporting column.

In the context of the Code, the term “spiral stair” is used to describe any stair where:

- (a) the plan of the treads forms part or all of a circle,
- (b) the minimum stair width and tread depth are less than those required for curved stairs, and
- (c) the maximum riser height is greater than that permitted in all other stair configurations.



**Figure A-9.8.4.7.**  
Spiral stairs

**A-9.8.4.8. Tread Nosings.** A sloped or beveled edge on tread nosings will make the tread more visible through light modeling. The sloped portion of the nosing must not be too wide so as to reduce the risk of slipping of the foot. See Figure A-9.8.4.-B.

**A-9.8.7.1.(2) Wider Stairs than Required.** The intent of Sentence 9.8.7.1.(2) is that handrails be installed in relation to the required exit width only, regardless of the actual width of the stair and ramp. The required handrails are provided along the assumed natural path of travel to and from the building.

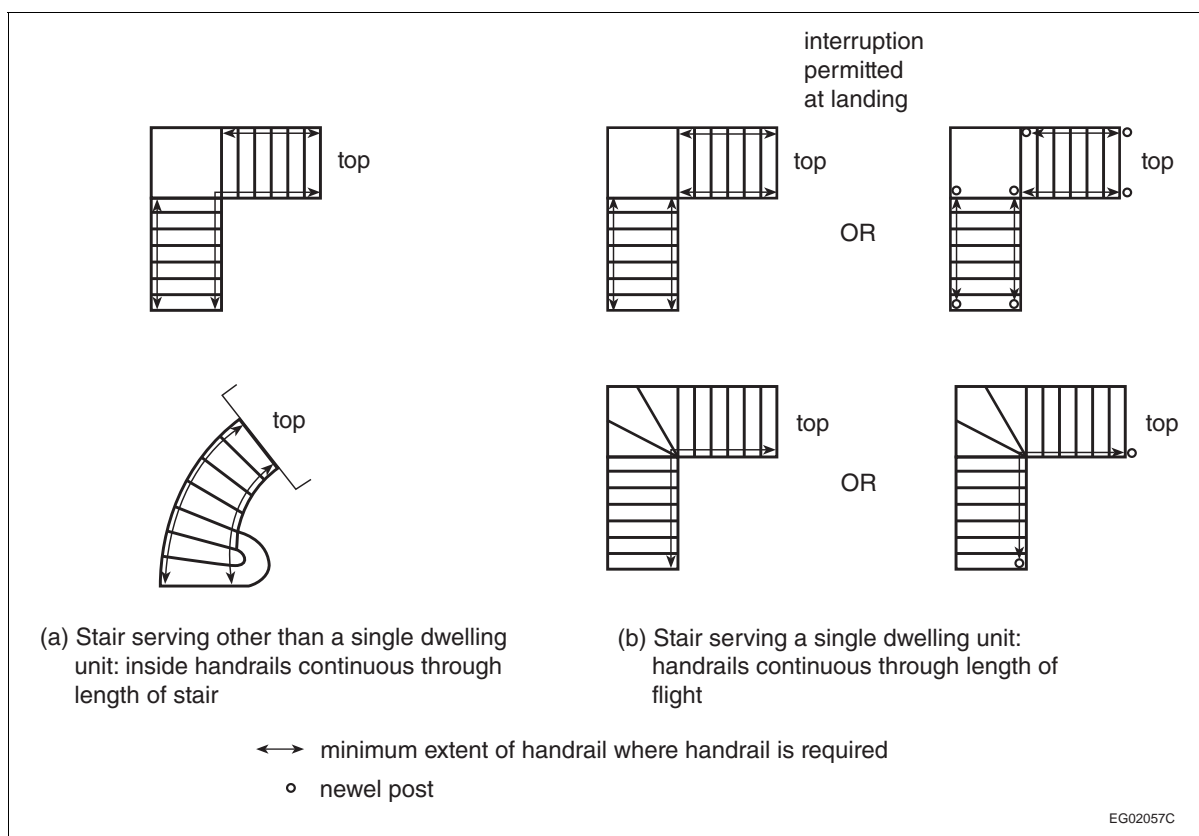


**A-9.8.7.2. Continuity of Handrails.** The guidance and support provided by handrails is particularly important at the beginning and end of ramps and flights of stairs and at changes in direction such as at landings and winders.

The intent of the requirement in Sentence (2) for handrails to be continuous throughout the length of the stair is that the handrail be continuous from the bottom riser to the top riser of the stair. (See Figure A-9.8.7.2.)

For stairs or ramps serving a single dwelling unit, the intent of the requirement for handrails to be continuous throughout the length of the flight is that the handrail be continuous from the bottom riser to the top riser of the flight. The required handrail may start back from the bottom riser only if it is supported by a newel post or volute installed on the bottom tread. (See Figure A-9.8.7.2.) With regard to stairs serving a single dwelling unit, the handrail may terminate at landings.

In the case of stairs within dwelling units that incorporate winders, the handrail should be configured so that it will in fact provide guidance and support to the stair user throughout the turn through the winder.



**Figure A-9.8.7.2.**  
**Continuity of handrails at the top and bottom of stairs and flights**

**Note to Figure A-9.8.7.2.:**

(1) See Article 9.8.7.1. to determine the number of handrails required. Some stairs will require only one, while some will require two or more.

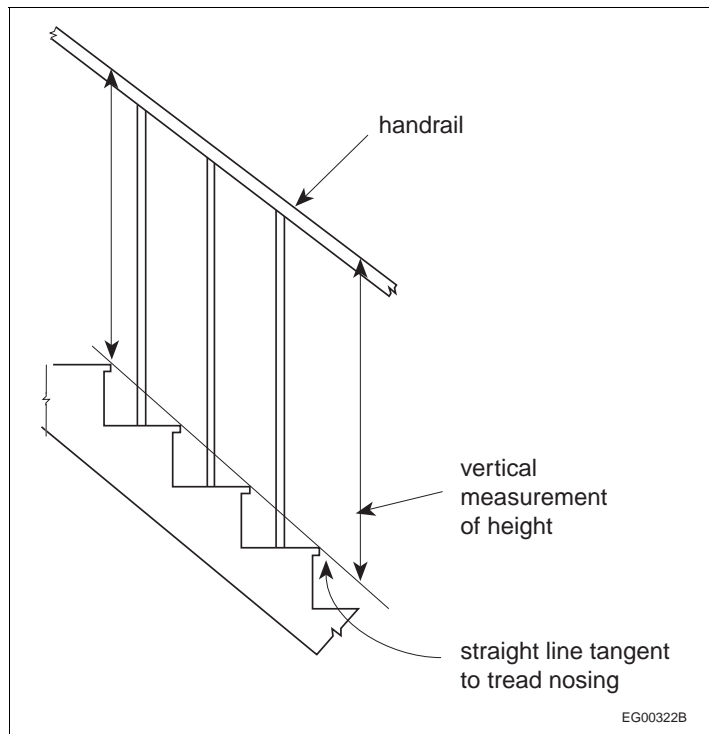
**A-9.8.7.3.(1) Termination of Handrails.** Handrails are required to be installed so as not to obstruct pedestrian travel. To achieve this end, the rail should not extend so far into a hallway as to reduce the clear width of the hallway to less than the required width. Where the stair terminates in a room or other space, likely paths of travel through that room or space should be assessed to ensure that any projection of the handrail beyond the end of the stair will not interfere with pedestrian travel. As extensions of handrails beyond the first and last riser are not required in dwelling units (see Sentence 9.8.7.3.(2)) and as occupants of dwellings are generally familiar with their surroundings, the design of dwellings would not generally be affected by this requirement.

Handrails are also required to terminate in a manner that will not create a safety hazard to blind or visually impaired persons, children whose heads may be at the same height as the end of the rail, or persons wearing loose clothing or carrying items that might catch on the end of the rail. One approach to reducing potential hazards is returning the handrail to a wall, floor or post. Again, within dwelling units, where occupants are

generally familiar with their surroundings, returning the handrail to a wall, floor or post may not be necessary. For example, where the handrail is fastened to a wall and does not project past the wall into a hallway or other space, a reasonable degree of safety is assumed to be provided; other alternatives may provide an equivalent level of protection.

**A-9.8.7.3.(2) Handrail Extensions.** As noted in Note A-9.8.7.2., the guidance and support provided by handrails is particularly important at the beginning and end of ramps and flights of stairs and at changes in direction. The extended handrail provides guidance and allows users to steady themselves upon entering or leaving a ramp or flight of stairs. Such extensions are particularly useful to visually-impaired persons, and persons with physical disabilities or who are encumbered in their use of the stairs or ramp.

**A-9.8.7.4. Height of Handrails.** Figure A-9.8.7.4. illustrates how to measure handrail height.



**Figure A-9.8.7.4.**  
Measuring handrail height

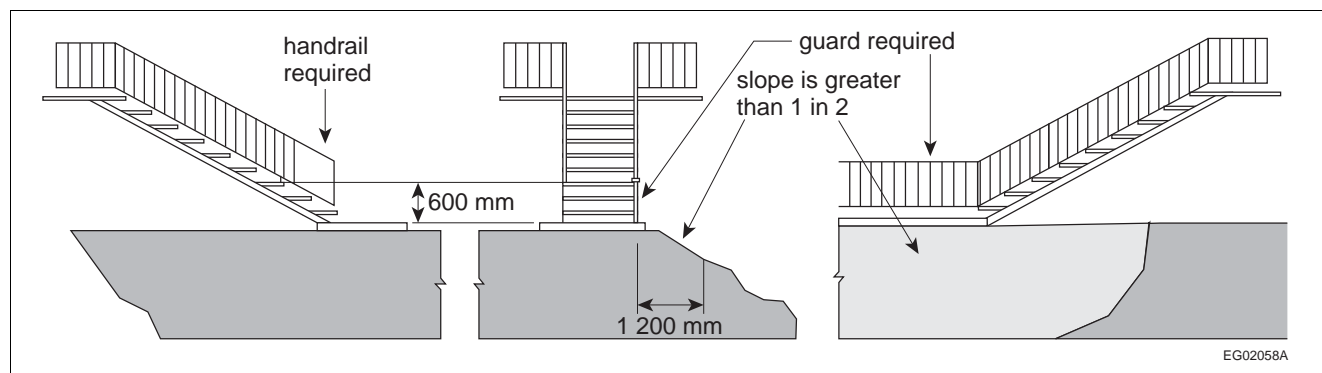
**A-9.8.7.5.(2) Handrail Sections.** Handrails are intended to provide guidance and support to stair users. To fulfil this intent, handrails must be “graspable.”

The graspable portion of a handrail should allow a person to comfortably and firmly grab hold by allowing their fingers and thumb to curl under part or all of the handrail. Where the configuration or dimensions of the handrail do not allow a person’s fingers and thumb to reach the bottom of it, recesses that are sufficiently wide and deep to accommodate a person’s fingers and thumb must be provided on both sides of the handrail, at the bottom of the graspable portion, which must not have any sharp edges.

**A-9.8.7.7. Attachment of Handrails.** Handrails are intended to provide guidance and support to the stair user and to arrest falls. The loads on handrails may therefore be considerable. The attachment of handrails serving a single dwelling unit may be accepted on the basis of experience or structural design.

**A-9.8.8.1. Required Guards.** The requirements relating to guards stated in Part 9 are based on the premise that, wherever there is a difference in elevation of 600 mm or more between two floors, or between a floor or other surface to which access is provided for other than maintenance purposes and the next lower surface, the risk of injury in a fall from the higher surface is sufficient to warrant the installation of some kind of barrier to reduce the chances of such a fall. A wall along the edge of the higher surface will obviously prevent such a fall, provided the wall is sufficiently strong that a person cannot fall through it. Where there is no wall, a guard must be installed. Because guards clearly provide less protection than walls, additional requirements apply to guards to ensure that a minimum level of protection is provided. These relate to the characteristics described in Notes A-9.8.8.3., A-9.8.8.5.(1) and (2), A-9.8.8.5.(3) and A-9.8.8.6.(1).

Examples of such surfaces where the difference in elevation could exceed 600 mm and consequently where guards would be required include, but are not limited to, landings, porches, balconies, mezzanines, galleries, and raised walkways. Especially in exterior settings, surfaces adjacent to walking surfaces, stairs or ramps often are not parallel to the walking surface or the surface of the treads or ramps. Consequently, the walking surface, stair or ramp may need protection in some locations but not in others. (See Figure A-9.8.8.1.) In some instances, grades are artificially raised close to walking surfaces, stairs or ramps to avoid installing guards. This provides little or no protection for the users. That is why the requirements specify differences in elevation not only immediately adjacent to the construction but also for a distance of 1 200 mm from it by requiring that the slope of the ground be within certain limits. (See Figure A-9.8.8.1.)



**Figure A-9.8.8.1.**  
Required locations of guards

**A-9.8.8.1.(4) Height of Window Sills above Floors or Ground.** The primary intent of the requirement is to minimize the likelihood of small children falling significant heights from open windows. Reflecting reported cases, the requirement applies only to dwelling units and generally those located on the second floor or higher of residential or mixed use buildings where the windows are essentially free-swinging or free-sliding.

Free-swinging or free-sliding means that a window that has been cracked open can be opened further by simply pushing on the operable part of the window. Care must be taken in selecting windows, as some with special operating hardware can still be opened further by simply pushing on the window.

Casement windows with crank operators would be considered to conform to Clause (4)(b). To provide additional safety, where slightly older children are involved, occupants can easily remove the crank handles from these windows. Awning windows with scissor hardware, however, may not keep the window from swinging open once it is unlatched. Hopper windows would be affected only if an opening is created at the bottom as well as at the top of the window. The requirement will impact primarily on the use of sliding windows which do not incorporate devices in their construction that can be used to limit the openable area of the window.

The 100 mm opening limit is consistent with widths of openings that small children can fall through. It is only invoked, however, where the other dimension of the opening is more than 380 mm. Again, care must be taken in selecting a window. At some position, scissor hardware on an awning window may break up the open area such that there is no unobstructed opening with dimensions greater than 380 mm and 100 mm. At another position, however, though the window is not open much more, the hardware may not adequately break up the opening. The 450 mm height off the floor recognizes that furniture is often placed under windows and small children are often good climbers.

**A-9.8.8.2. Loads on Guards.** Guards must be constructed so as to be strong enough to protect persons from falling under normal use. Many guards installed in dwelling units or on exterior stairs serving one or two dwelling units have demonstrated acceptable performance over time. The loading described in the first row of Table 9.8.8.2. is intended to be consistent with the performance provided by these guards. Examples of guard construction presented in the “2012 Building Code Compendium, Volume 2, Supplementary Standard SB-7, Guards for Housing and Small Buildings” meet the criteria set in the National Building Code for loads on guards, including the more stringent requirements of Sentences 9.8.8.2.(1) and (2).

The load on guards within dwelling units, or on exterior guards serving not more than two dwelling units, is to be imposed over an area of the guard such that, where standard balusters are used and installed at the maximum 100 mm spacing permitted for required guards, 3 balusters will be engaged. Where the balusters are wider, only two may be engaged unless they are spaced closer together. Where the guard is not required, and balusters are installed more than 100 mm apart, fewer balusters may be required to carry the imposed load.

**A-9.8.8.3. Minimum Heights.** Guard heights are generally based on the waist heights of average persons. Generally, lower heights are permitted in dwelling units because the occupants become familiar with the potential hazards, and situations which lead to pushing and jostling under crowded conditions are less likely to arise.

**A-9.8.8.5.(1) and (2) Risk of Falling through Guards.** The risk of falling through a guard is especially prevalent for children. Therefore the requirements are stringent for guards in all buildings except industrial buildings, where children are unlikely to be present except under strict supervision.

**A-9.8.8.5.(3) Risk of Children Getting Their Head Stuck between Balusters.** The requirements to prevent children falling through guards also serve to provide adequate protection against this problem. However, guards are often installed where they are not required by the Code; i.e., in places where the difference in elevation is less than 600 mm. In these cases, there is no need to require the openings between balusters to be less than 100 mm. However, there is a range of openings between 100 mm and 200 mm in which children can get their head stuck. Therefore, openings in this range are not permitted except in buildings of industrial occupancy, where children are unlikely to be present except under strict supervision.

**A-9.8.8.6.(1) Configuration of Members, Attachments or Openings in Guards so as to not Facilitate Climbing.** Some configurations of members, attachments or openings may be part of a guard design and still comply with Sentence 9.8.8.6.(1). Figures A-9.8.8.6.(1)-A to A-9.8.8.6.(1)-D present a few examples of designs that are considered to not facilitate climbing.

Protrusions that are greater than 450 mm apart horizontally and vertically are considered sufficiently far apart to reduce the likelihood that young children will be able to get a handhold or toehold on the protrusions and climb the guard.

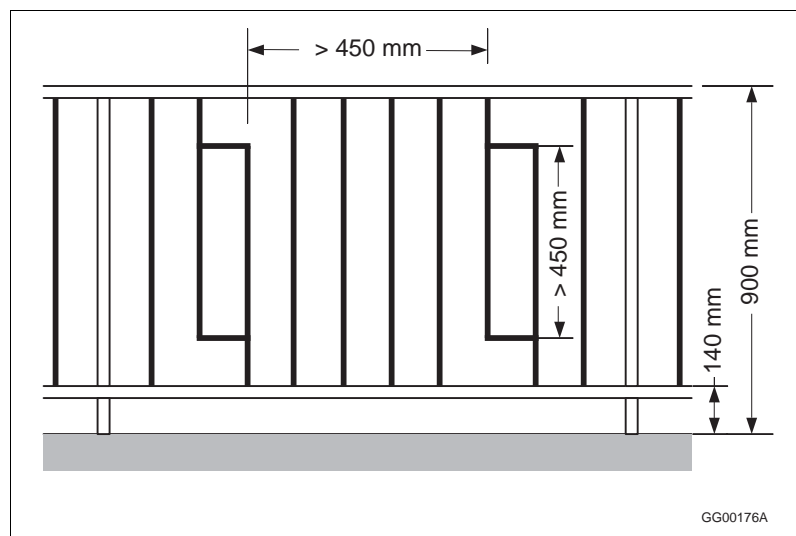
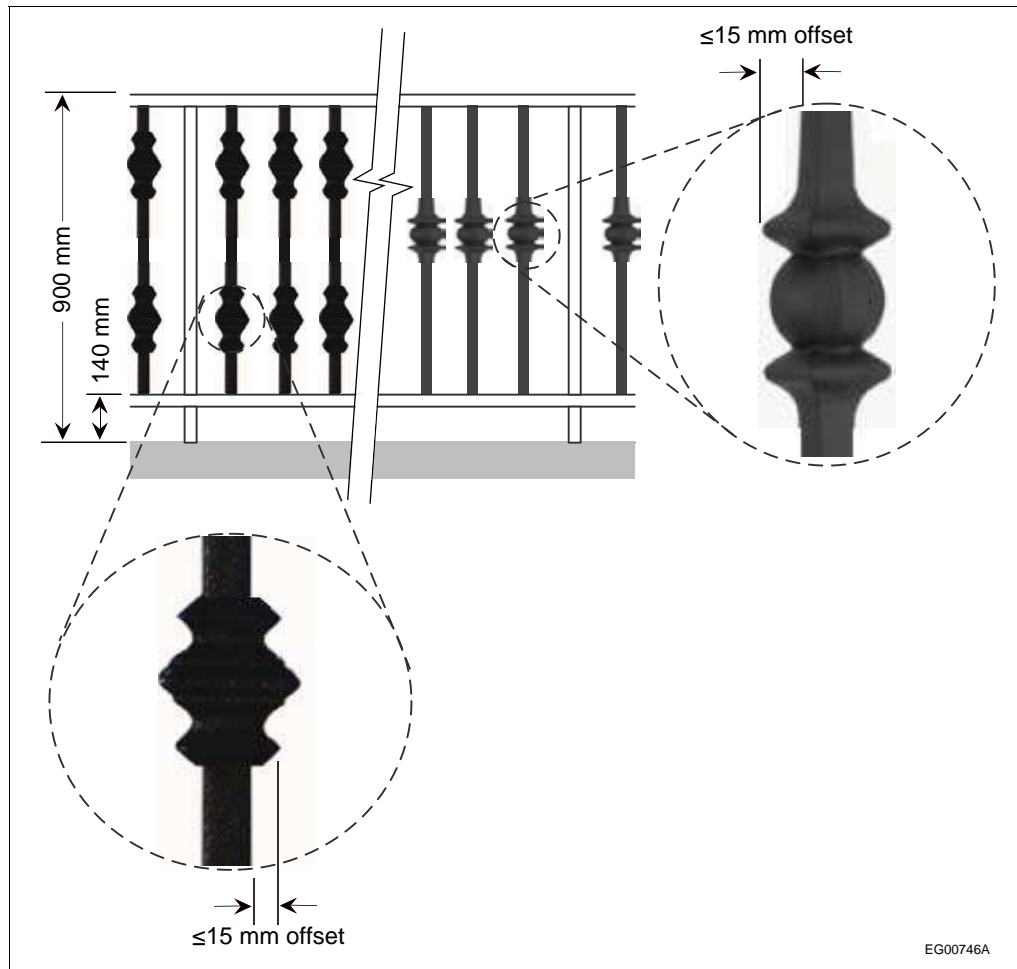


Figure A-9.8.8.6.(1)-A

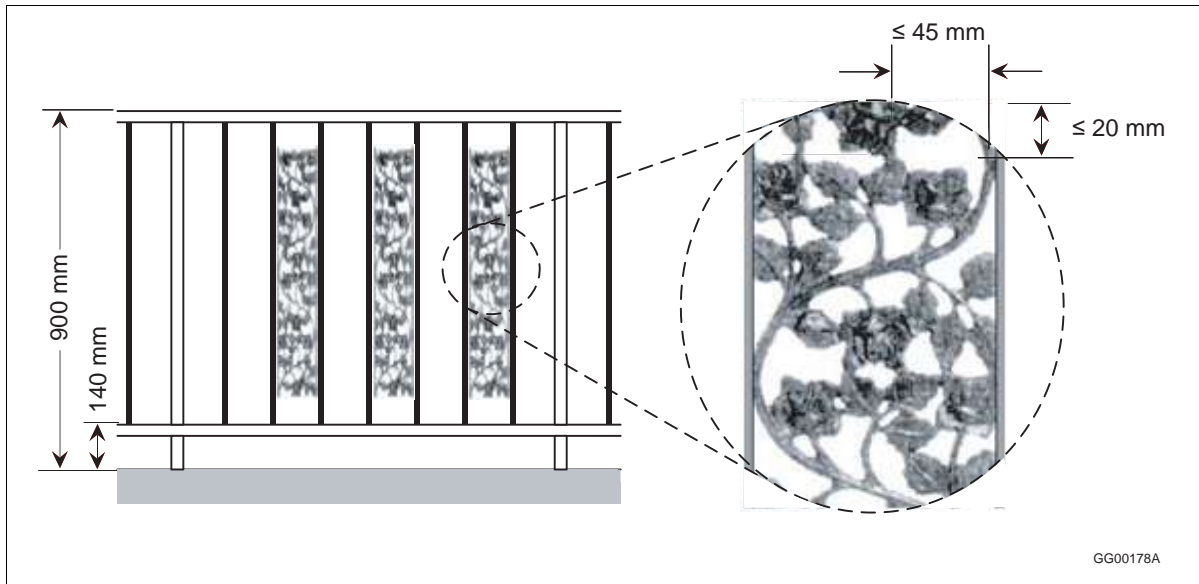
Example of minimum horizontal and vertical clearances between protrusions in guards

Protrusions that present a horizontal offset of 15 mm or less are considered to not provide a sufficient foot purchase to facilitate climbing.



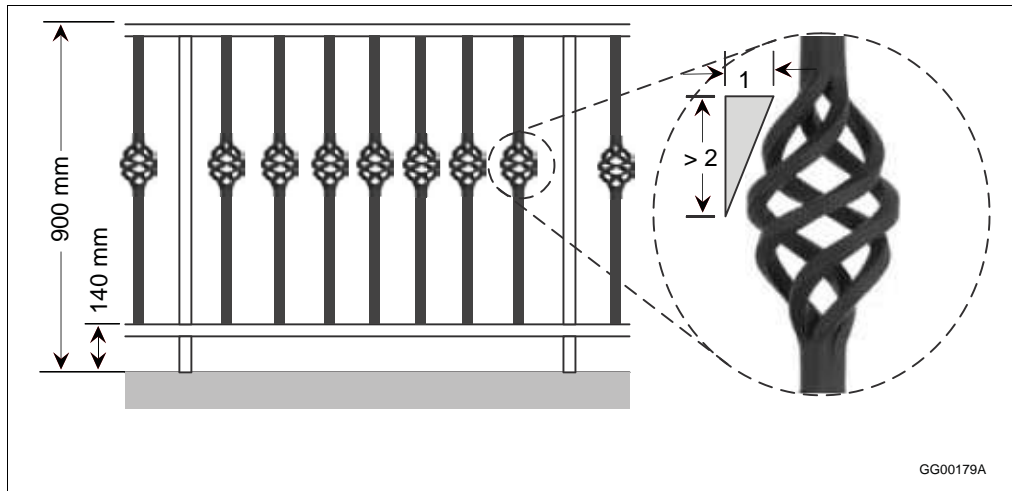
**Figure A-9.8.8.6.(1)-B**  
**Examples of maximum horizontal offset of protrusions in guards**

A guard incorporating spaces that are not more than 45 mm wide by 20 mm high is considered to not facilitate climbing because the spaces are too small to provide a toehold.



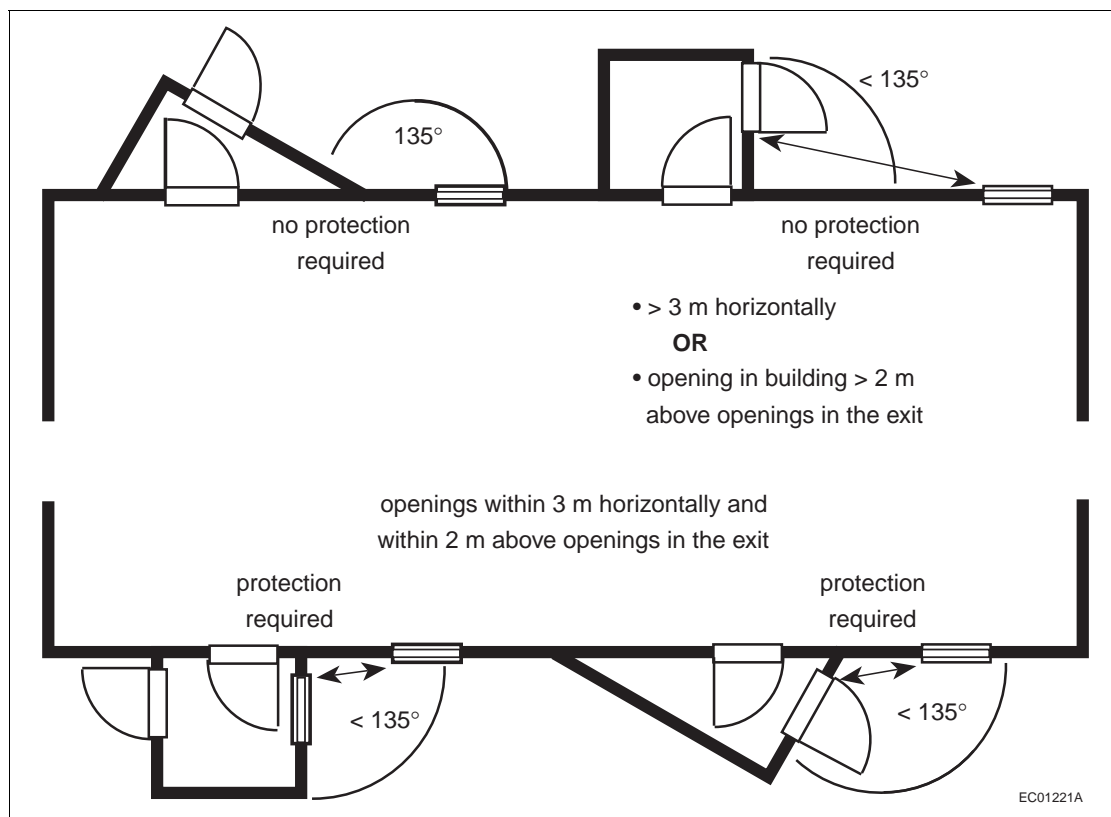
**Figure A-9.8.8.6.(1)-C**  
Example of a guard with spaces created by the protruding elements that are not more than 45 mm wide and 20 mm high

Protrusions that present more than a 2-in-1 slope on the offset are considered to not facilitate climbing because such a slope is considered too steep to provide adequate footing.



**Figure A-9.8.8.6.(1)-D**  
Example of guard protrusions with a slope greater than 2 in 1

**A-9.9.4.5.(1) Openings in Exterior Walls of Exits.**



**Figure A-9.9.4.5.(1)**  
Protection of openings in exterior walls of exits

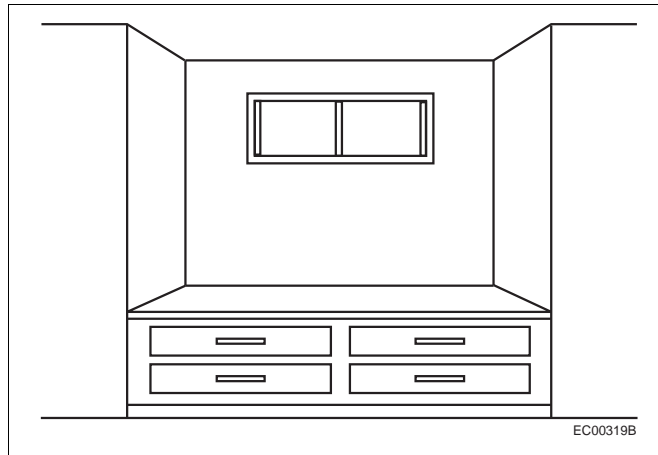
**A-9.9.8.4.(1) Independent and Remote Exits.** Subsection 9.9.8. requires that some floor areas have more than one exit. The intent is to ensure that, if one exit is made untenable or inaccessible by a fire, or its exterior door is blocked by an exterior incident, one or more other exits will be available to permit the occupants to escape. However, if the exits are close together, all exits might be made untenable or inaccessible by the same fire. Sentence 9.9.8.4.(1) therefore requires at least two of the exits to be located remotely from each other. This is not a problem in many buildings falling under Part 9. For instance, apartment buildings usually have exits located at either end of long corridors. However, in other types of buildings (e.g. dormitory and college residence buildings) this is often difficult to accomplish and problems arise in interpreting the meaning of the word “remote.” Article 3.4.2.3. is more specific, generally requiring the distance between exits to be one half the diagonal dimension of the floor area or at least 9 m. However, it is felt that such criteria would be too restrictive to impose on the design of all the smaller buildings which come under Part 9. Nevertheless, the exits should be placed as far apart as possible and the Part 3 criteria should be used as a target. Designs in which the exits are so close together that they will obviously both become contaminated in the event of a fire are not acceptable.

**A-9.9.10.1.(1) Escape Windows from Bedrooms.** Sentence 9.9.10.1.(1) generally requires every bedroom in an unsprinklered suite to have at least one window or door opening to the outside that is large enough and easy enough to open so that it can be used as an exit in the event that a fire prevents use of the building’s normal exits. The minimum unobstructed opening specified for escape windows must be achievable using only the normal window operating procedure. The escape path must not go through nor open onto another room, floor or space.

Where a bedroom is located in an unsprinklered suite in a basement, an escape window or door must be located in the bedroom. It is not sufficient to rely on egress through other basement space to another escape window or door.

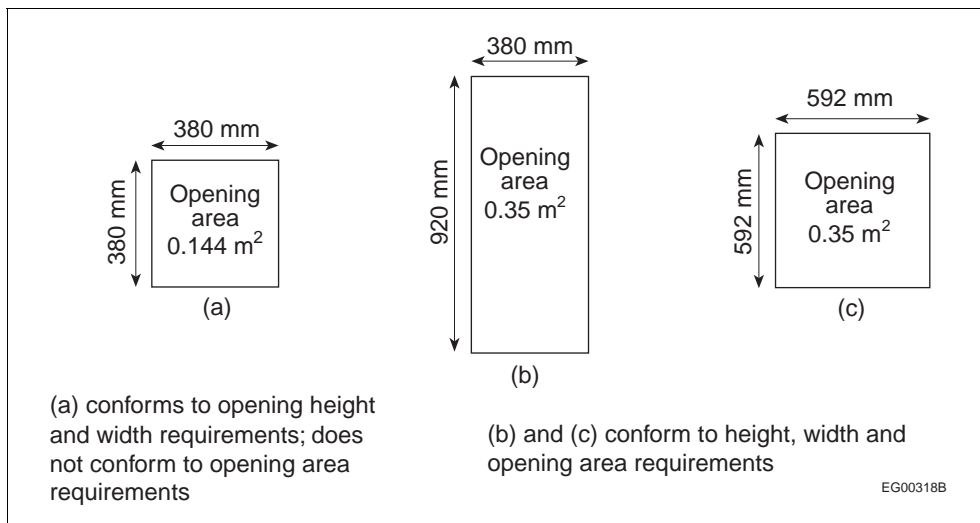
**Window Height**

The Article does not set a maximum sill height for escape windows; it is therefore possible to install a window or skylight that satisfies the requirements of the Article but defeats the Article’s intent by virtue of being so high that it cannot be reached for exit purposes. It is recommended that the sills of windows intended for use as emergency exits be not higher than 1.5 m above the floor. However, it is sometimes difficult to avoid having a higher sill: on skylights and windows in basement bedrooms for example. In these cases, it is recommended that access to the window be improved by some means such as built-in furniture installed below the window.



**Figure A-9.9.10.1.(1)**  
**Built-in furniture to improve access to a window**

**A-9.9.10.1.(2) Bedroom Window Opening Areas and Dimensions.** Although the minimum opening dimensions required for height and width are 380 mm, a window opening that is 380 mm by 380 mm would not comply with the minimum area requirements. (See Figure A-9.9.10.1.(2))



**Figure A-9.9.10.1.(2)**  
**Window opening areas and dimensions**

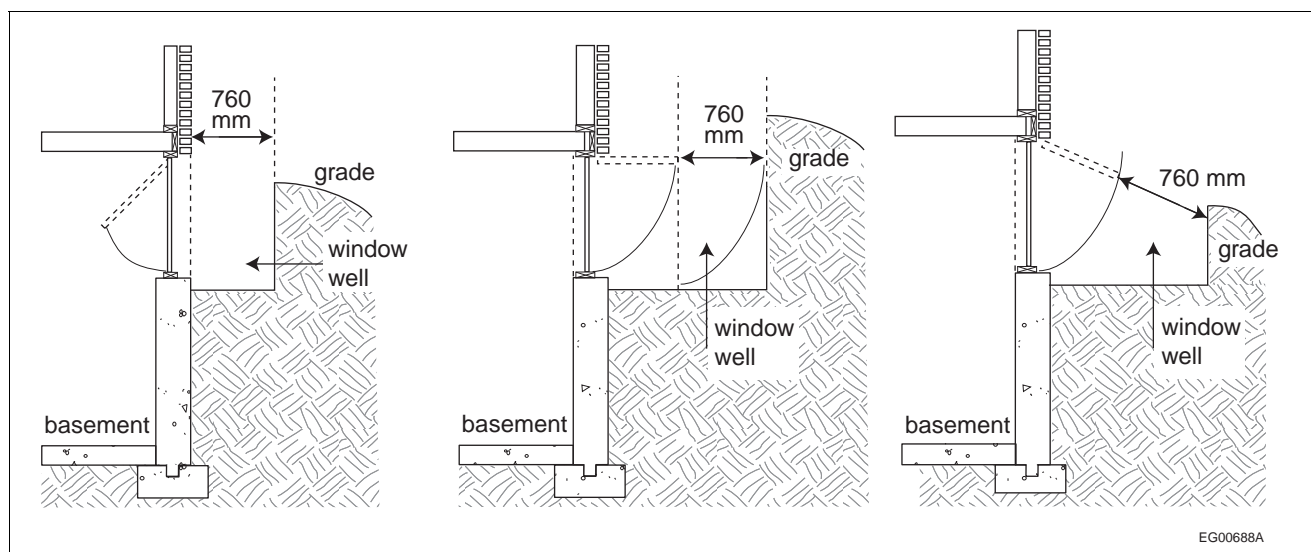


**A-9.9.10.1.(3) Window Opening into a Window Well.** Sentence 9.9.10.1.(3) specifies that there must be a minimum clearance of 760 mm in front of designated escape windows to allow persons to escape a basement bedroom in an emergency. This specified minimum clearance is consistent with the minimum required width for means of egress from a floor area (see Article 9.9.5.5.) and the minimum required width for path of travel on exit stairs (see Article 9.9.6.1.). It is considered the smallest acceptable clearance between the escape window and the facing wall of the window well that can accommodate persons trying to escape a bedroom in an emergency given that they are not moving straight through the window but must move outward and up, and must have sufficient space to change body orientation.

Once this clearance is provided, no additional clearance is needed for windows with sliders, casements, or inward-opening awnings. However, for windows with outward-opening awnings, additional clearance is needed to provide the required 760 mm beyond the outer edge of the sash. (See Figure A-9.9.10.1.(3).)

Depending on the likelihood of snow accumulation in the window well, it could be difficult—if not impossible—to escape in an emergency. The window well should be designed to provide sufficient clear space for a person to get out the window and then out the well, taking into account potential snow accumulation.

Hopper windows (bottom-hinged operators) should not be used as escape windows in cases where the occupants would be required to climb over the glass.



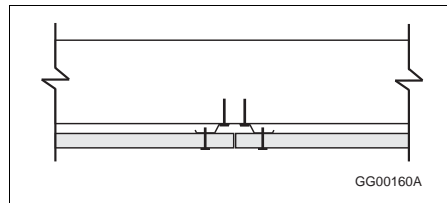
**Figure A-9.9.10.1.(3)**  
Windows providing a means of escape that open into a window well

**A-9.10.1.4.(1) Commercial Cooking Equipment.** Part 6 refers to NFPA 96, “Ventilation Control and Fire Protection of Commercial Cooking Operations,” which in turn references “Commercial Cooking Equipment.” However, the deciding factor as to whether or not NFPA 96 applies is the potential for production of grease-laden vapours and smoke, rather than the type of equipment used. While NFPA 96 does not apply to domestic equipment for normal residential family use, it should apply to domestic equipment used in commercial, industrial, institutional and similar cooking applications where the potential for the production of smoke and grease-laden vapours exceeds that for normal residential family use.

**A-9.10.3.1. Fire and Sound Resistance of Building Assemblies.** Tables 9.10.3.1.-A and 9.10.3.1.-B have been developed from information gathered from tests. While a large number of the assemblies listed were tested, the fire-resistance and acoustical ratings for others were assigned on the basis of extrapolation of information from tests of similar assemblies. Where there was enough confidence relative to the fire performance of an assembly, the fire-resistance ratings were assigned relative to the commonly used minimum ratings of 30 min, 45 min and 1 h, including a designation of “< 30 min” for assemblies that are known not to meet the minimum 30-minute rating. Where there was not enough comparative information on an assembly to assign to it a rating with confidence, its value in the tables has been left blank (hyphen), indicating that its rating remains to be assessed through another means. Future work is planned to develop much of this additional information.

These tables are provided only for the convenience of Code users and do not limit the number of assemblies permitted to those in the tables. Assemblies not listed or not given a rating in these tables are equally acceptable provided their fire and sound resistance can be demonstrated to meet the above-noted requirements either on the basis of tests referred to in Article 9.10.3.1. and Subsection 9.11.1. or by using the data in Appendix D, Fire-Performance Ratings. It should be noted, however, that Tables 9.10.3.1.-A and 9.10.3.1.-B are not based on the same assumptions as those used in Appendix D. Assemblies in Tables 9.10.3.1.-A and 9.10.3.1.-B are described through their generic descriptions and variants and include details given in the notes to the tables. Assumptions for Appendix D include different construction details that must be followed rigorously for the calculated ratings to be expected. These are two different methods of choosing assemblies that meet required fire ratings.

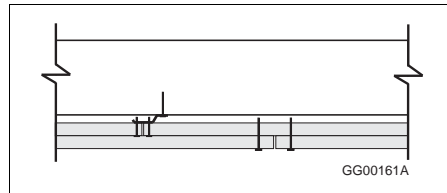
Table 9.10.3.1.-B presents fire-resistance and acoustical ratings for floor, ceiling and roof assemblies. The fire-resistance ratings are appropriate for all assemblies conforming to the construction specifications given in Table 9.10.3.1.-B, including applicable table notes. Acoustical ratings for assemblies decrease with decreasing depth and decreasing separation of the structural members; the values listed for sound transmission class and impact insulation class are suitable for the minimum depth of structural members identified in the description, including applicable table notes, and for structural member spacing of 305 mm o.c., unless other values are explicitly listed for the assembly. Adjustments to the acoustical ratings to allow for the benefit of deeper or more widely spaced structural members are given in Table Notes (9) and (10).



**Figure A-9.10.3.1.-A**  
**Single layer butt joint details**

**Notes to Figure A-9.10.3.1.-A:**

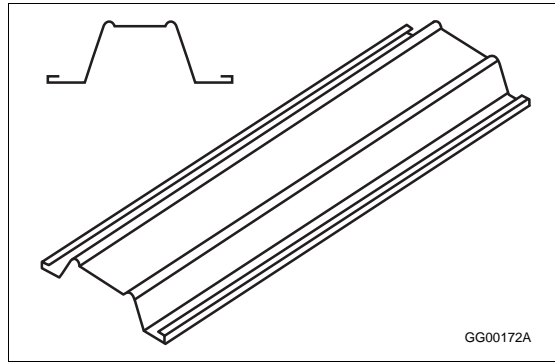
- (1) Figure is for illustrative purposes only and is not to scale.
- (2) The structural member can be any one of the types described in the Table.
- (3) Adjacent gypsum board butt ends are attached to separate resilient channels using regular Type S screws, located a minimum of 38 mm from the butt end.



**Figure A-9.10.3.1.-B**  
**Double layer butt joint details**

**Notes to Figure A-9.10.3.1.-B:**

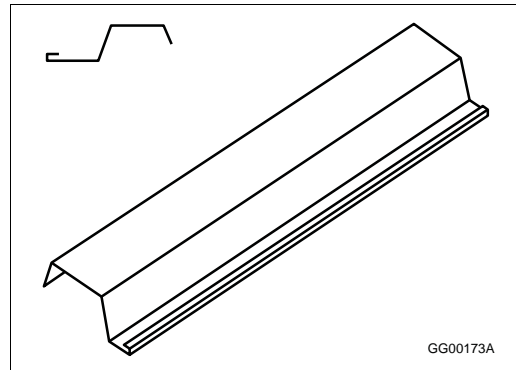
- (1) Figure is for illustrative purposes only and is not to scale.
- (2) The structural member can be any one of the types described in the Table.
- (3) Base layer butt ends can be attached to a single resilient channel using regular Type S screws.
- (4) Type G screws measuring a minimum of 32 mm in length and located a minimum of 38 mm from the butt end are used to fasten the butt ends of the face layer to the base layer.



**Figure A-9.10.3.1.-C**  
**Example of steel furring channel**

**Note to Figure A-9.10.3.1.-C:**

(1) Figure is for illustrative purposes only and is not to scale.



**Figure A-9.10.3.1.-D**  
**Example of resilient metal channel**

**Note to Figure A-9.10.3.1.-D:**

(1) Figure is for illustrative purposes only and is not to scale.

**A-9.10.4.1.(4) Mezzanines Not Considered as Storeys.** Mezzanines increase the occupant load and the fire load of the storey of which they are part. To take the added occupant load into account for the purpose of evaluating other requirements that are dependent on this criteria, their floor area is added to the floor area of the storey.

**A-9.10.8.3.(2) Light-frame Construction.** Light-frame walls, columns, arches and beams do not include heavy timber elements or masonry or concrete construction.

**A-9.10.9.2.(3) Continuity of Smoke-Tight Barrier.** The continuity of a smoke-tight barrier where it abuts another smoke-tight barrier, a floor, a ceiling or a wall assembly, is maintained by filling all openings at the juncture of the assemblies with a material that will ensure the integrity of the smoke-tight barrier at that location.

**A-9.10.9.3.(2) Openings in Smoke-Tight Barriers to be Protected with Closures.** Doors described in Sentence 9.10.9.3.(2) are deemed to provide a minimum 20 min fire-protection rating, which is considered an acceptable level of protection against the spread of fire in a house with a secondary suite. They are not required to be marked to identify conformance to CAN/ULC-S113, "Wood Core Doors Meeting the Performance Required by CAN/ULC-S104 for Twenty Minute Fire Rated Closure Assemblies," as is the case for solid-core doors installed in fire separations.

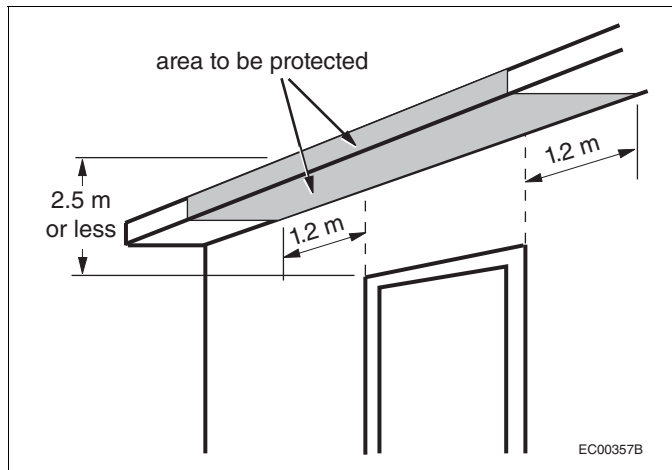
**A-9.10.9.6.(1) Penetration of Fire-Rated Assemblies by Service Equipment.** This Sentence, together with Article 3.1.9.1., is intended to ensure that the integrity of fire-rated assemblies is maintained where they are penetrated by various types of service equipment.

For buildings regulated by the requirements in Part 3, fire stop materials used to seal openings around building services, such as pipes, ducts and electrical outlet boxes, must meet a minimum level of performance demonstrated by standard test criteria.

This is different from the approach in Part 9. Because of the type of construction normally used for buildings regulated by the requirements in Part 9, it is assumed that this requirement is satisfied by the use of generic fire stop materials such as mineral wool, gypsum plaster or Portland cement mortar.

**A-9.10.9.16.(4) Separation between Dwelling Units and Storage or Repair Garages.** The gas-tight barrier between a dwelling unit and an attached garage is intended to provide protection against the entry of carbon monoxide and gasoline fumes into the dwelling unit. Building assemblies incorporating an air barrier system will perform adequately with respect to gas tightness, provided all joints in the airtight material are sealed and reasonable care is exercised where the wall or ceiling is pierced by building services. Where a garage is open to the adjacent attic space above the dwelling unit it serves, a gas-tight barrier in the ceiling of the dwelling unit will also provide protection. Unit masonry walls forming the separation between a dwelling unit and an adjacent garage should be provided with two coats of sealer or plaster, or covered with gypsum board on the side of the wall exposed to the garage. All joints must be sealed to ensure continuity of the barrier. (See also Sentences 9.25.3.3.(3) to (8).)

**A-9.10.12.4.(1) Protection of Overhang of Common Roof Space.**



**Figure A-9.10.12.4.(1)**  
Protection of overhang of common roof space

**A-9.10.12.4.(3) Protection at Soffits.** The materials required by this Sentence to be used as protection for soffit spaces in certain locations do not necessarily have to be the finish materials. They can be installed either behind the finishes chosen for the soffits or in lieu of these.

**A-9.10.13.2.(1) Wood Doors in Fire Separations.** CAN/ULC-S113, “Wood Core Doors Meeting the Performance Required by CAN/ULC-S104 for Twenty Minute Fire Rated Closure Assemblies,” provides construction details to enable manufacturers to build wood core doors that will provide a 20 min fire-protection rating without the need for testing. The standard requires each door to be marked with

- (1) the manufacturer’s or vendor’s name or identifying symbol,
- (2) the words “Fire Door,” and
- (3) a reference to the fire-protection rating of 20 min.

**A-9.10.14.5.(1) Minor Combustible Cladding Elements.** Minor elements of cladding that is required to be noncombustible are permitted to be of combustible material, provided they are distributed over the building face and not concentrated in one area. Examples of minor combustible cladding elements include door and window trim and some decorative elements.

**A-9.10.14.5.(7) Permitted Projections.** The definition of exposing building face provided in Sentence 1.4.1.2.(1) of Division A refers to “that part of the exterior wall of a building ... or, where a building is divided into fire compartments, the exterior wall of a fire compartment ...” Because the exposing building face is defined with respect to the exterior wall, projections from exposing building faces are elements that do not incorporate exterior walls. Depending on their specific configurations, examples of constructions that would normally be permitted by Sentence 9.10.14.5.(7) are balconies, platforms, canopies, eave projections and stairs. However, if a balcony, platform or stair is enclosed, its exterior wall would become part of an exposing building face and the construction could not be considered to be a projection from the exposing building face.

**A-9.10.14.5.(8) Protection at Projections.** Sentence 9.10.14.5.(7) permits certain projections from exposing building faces where the projections do not have exterior walls and thus clearly do not constitute part of the exposing building face. Sentence 9.10.14.5.(8) refers to other types of projections from the exposing building face, such as those for fireplaces and chimneys. It is recognized that these types present more vertical surface area compared to platforms, canopies and eave projections, and may be enclosed by constructions that are essentially the same as exterior walls. These constructions, however, do not enclose habitable space, are of limited width and may not extend a full storey in height. Consequently, Sentence (8) allows these projections beyond the exposing building face of buildings identified in Sentence (6), provided additional fire protection is installed on the projection.

Figure A-9.10.14.5.(8) illustrates projections that extend within 1.2 m of the property line where additional protection must be provided. Where a projection extends within 0.6 m of the property line, it must be protected to the same degree as an exposing building face that has a limiting distance of less than 0.6 m. Where a projection extends to less than 1.2 m but not less than 0.6 m of the property line, it must be protected to the same degree as an exposing building face that has a limiting distance of less than 1.2 m.

Protection is also required on the underside of the projection where the projection is more than 0.6 m above finished ground level, measured at the exposing building face.

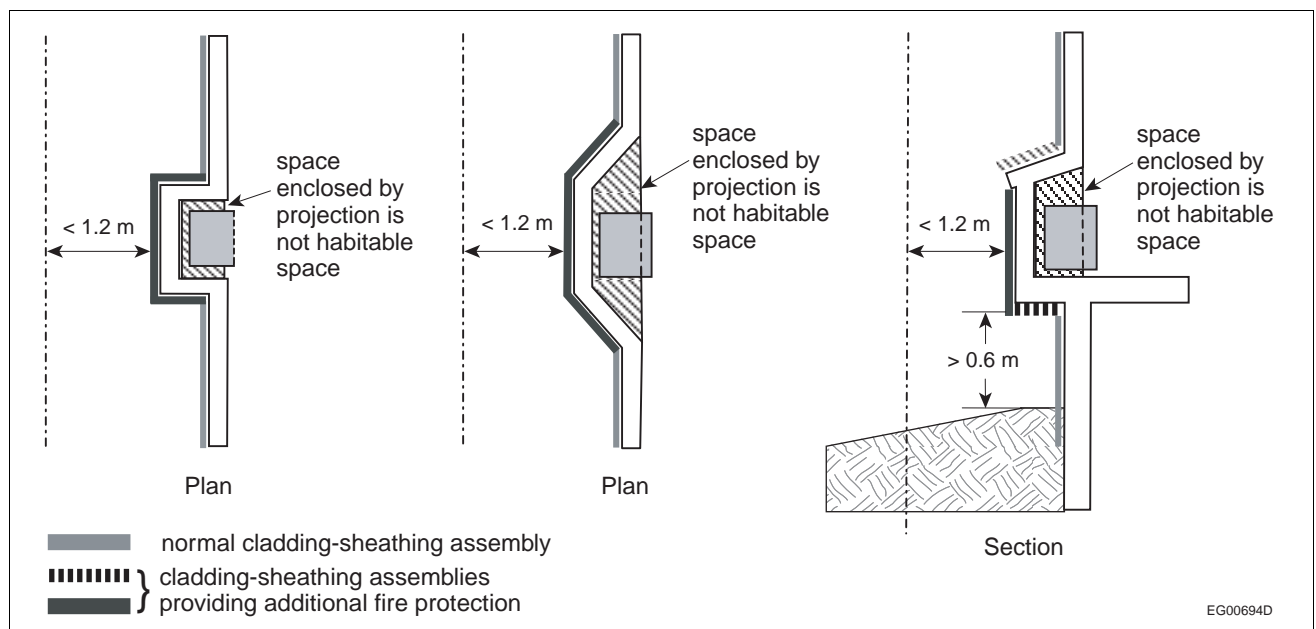
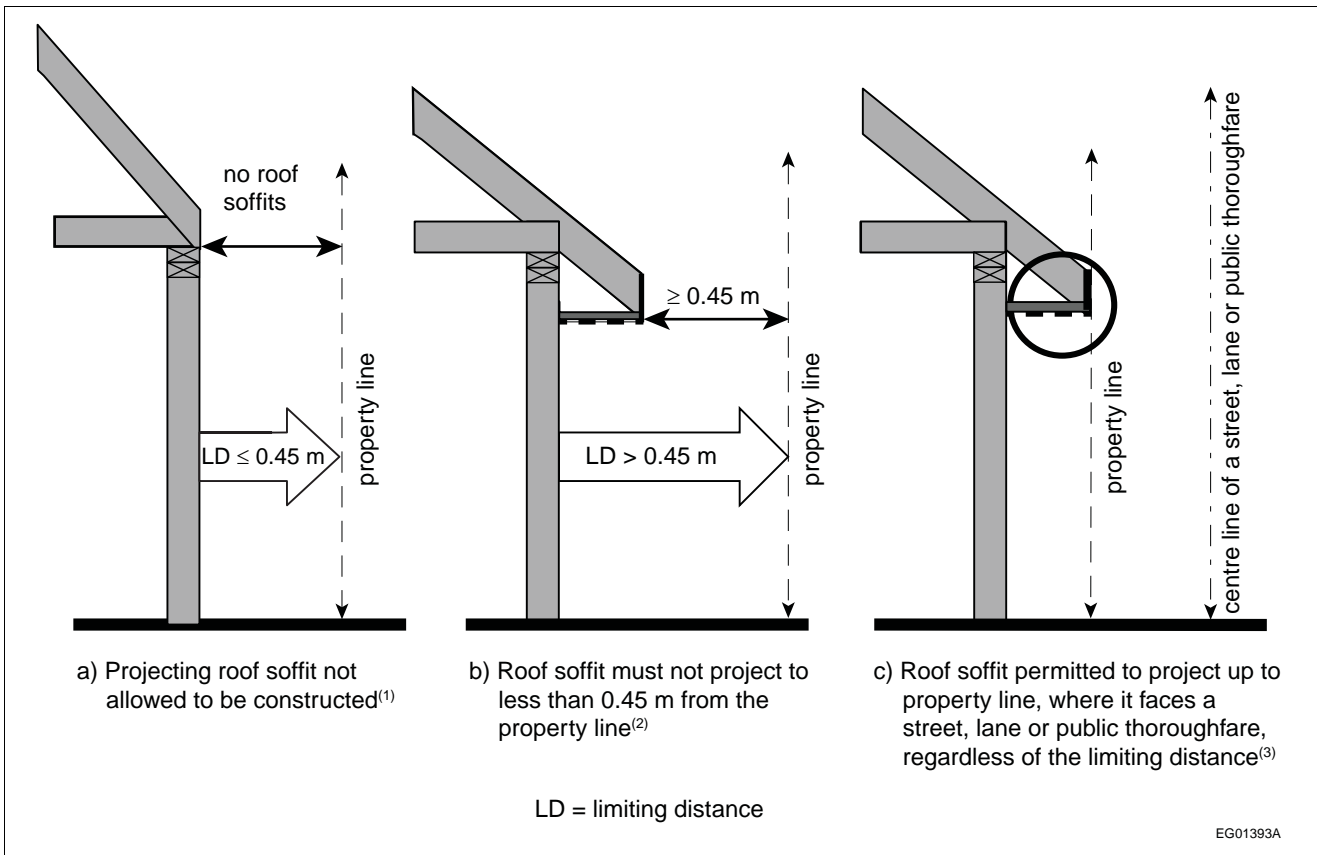


Figure A-9.10.14.5.(8)  
Protection at projections

**A-9.10.14.5.(11) and 9.10.15.5.(10) Roof Soffit Projections.**



EG01393A

**Figure A-9.10.14.5.(11) and 9.10.15.5.(10)**

**Roof soffit projections**

**Notes to Figure A-9.10.14.5.(11) and 9.10.15.5.(10):**

- (1) See Sentences 3.2.3.6.(2), 9.10.14.5.(9) and 9.10.15.5.(8).
- (2) See Sentences 3.2.3.6.(3), 9.10.14.5.(10) and 9.10.15.5.(9).
- (3) See Sentences 3.2.3.6.(4), 9.10.14.5.(11) and 9.10.15.5.(10).

**A-9.10.15.1.(1) Application of Subsection 9.10.15.** The buildings to which Subsection 9.10.15. applies include:

- traditional individual detached houses with or without a secondary suite,
- semi-detached houses (doubles) where each house may contain a secondary suite,
- row houses, where any house may contain a secondary suite (see Sentence 9.10.11.2.(1)), and
- stacked dwelling units where one of them is a secondary suite.

Subsection 9.10.15. does not apply to stacked townhouses, stacked duplexes or stacked dwelling units that are not within a house with a secondary suite.

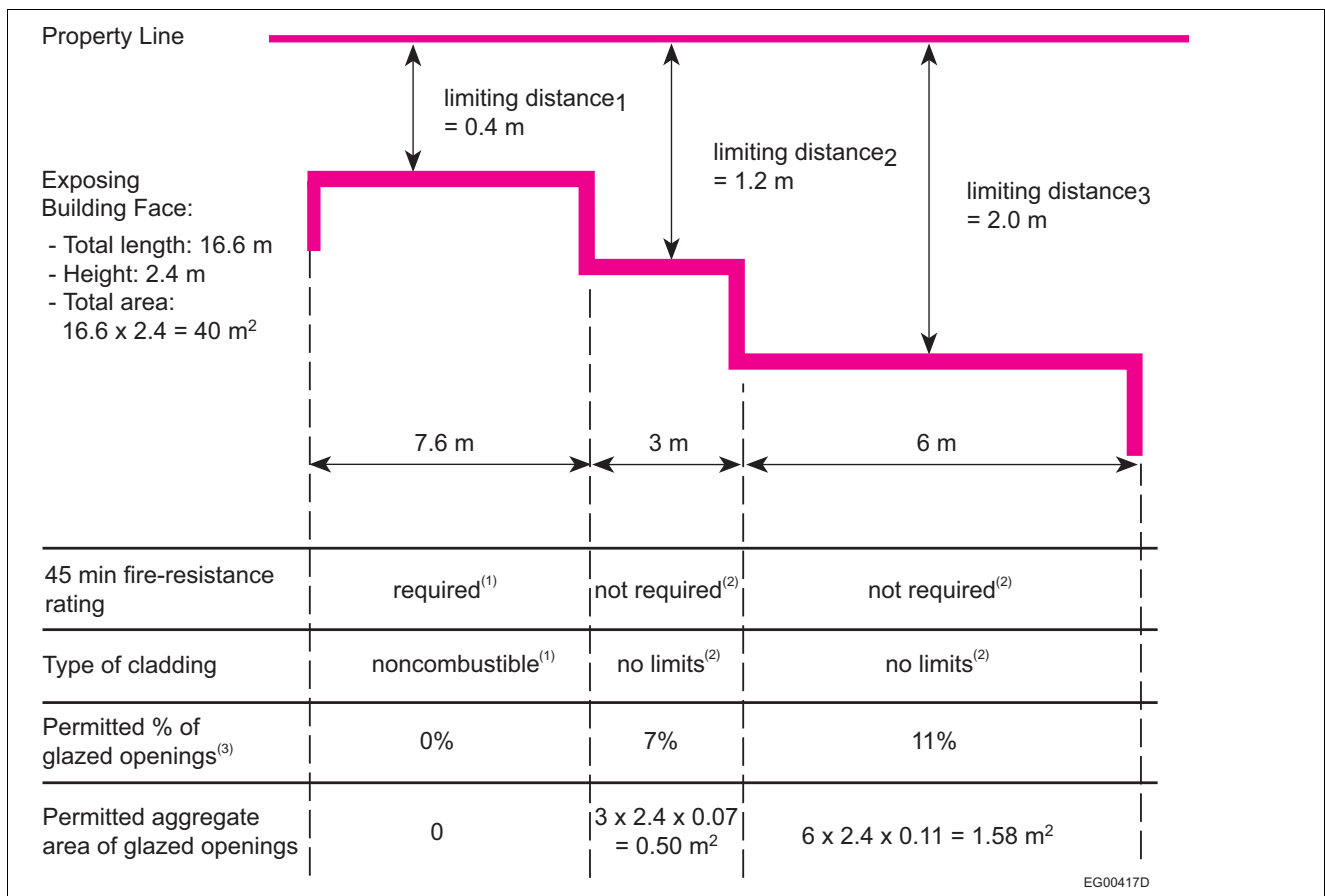
**A-9.10.15.4.(2) Staggered or Skewed Exposing Building Faces of Houses.** Studies at the National Fire Laboratory of the National Research Council have shown that, where an exposing building face is stepped back from the property line or is at an angle to the property line, it is possible to increase the percentage of glazing in those portions of the exposing building face further from the property line without increasing the amount of radiated energy that would reach the property line in the event of a fire in such a building. Figures A-9.10.15.4.(2)-A, A-9.10.15.4.(2)-B and A-9.10.15.4.(2)-C show how Sentences 9.10.15.4.(1) and (2), and 9.10.15.5.(2) and (3) can be applied to exposing building faces that are stepped back from or not parallel to the property line. The following procedure can be used to establish the maximum permitted area of glazed openings for such facades:

1. Calculate the total area of the exposing building face, i.e. facade of the fire compartment, as described in the definition of exposing building face.

2. Identify the portions into which the exposing building face is to be divided. It can be divided in any number of portions, not necessarily of equal size.
3. Measure the limiting distance for each portion. The limiting distance is measured along a line perpendicular to the wall surface from the point closest to the property line.
4. Establish the line in Table 9.10.15.4. from which the maximum permitted percentage area of glazed openings will be read. The selection of the line depends on the maximum area of exposing building face for the whole fire compartment, including all portions, as determined in Step 1.
5. On that line, read the maximum percentage area of glazed openings permitted in each portion of the exposing building face according to the limiting distance for that portion.
6. Calculate the maximum area of glazed openings permitted in each portion. The area is calculated from the percentage found applied to the area of that portion.

Table 9.10.15.4. is used to read the maximum area of glazed openings: this means that the opaque portion of doors does not have to be counted as for other types of buildings.

Note that this Note and the Figures do not describe or illustrate maximum permitted concentrated area or spacing of individual glazed openings, or limits on the location of dividing lines between portions of the exposing building face depending on the location of these openings with respect to interior rooms or spaces. See Sentences 9.10.15.2.(2) and 9.10.15.4.(2) to (4) for the applicable requirements.

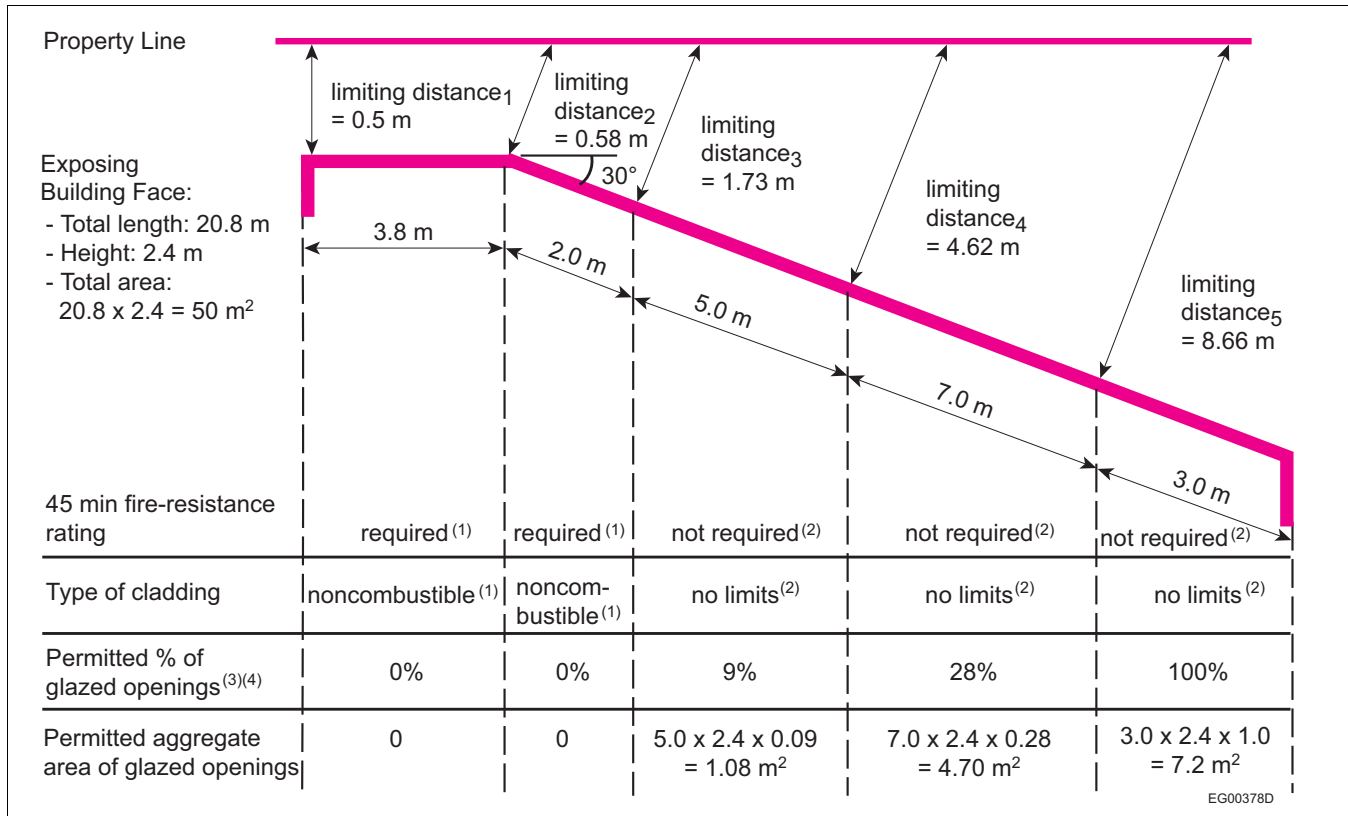


**Figure A-9.10.15.4.(2)-A**

**Example of determination of criteria for the exposing building face of a staggered wall of a house**

**Notes to Figure A-9.10.15.4.(2)-A:**

- (1) See Sentence 9.10.15.5.(2).
- (2) See Sentence 9.10.15.5.(3).
- (3) See Table 9.10.15.4., Subclause 9.10.15.2.(1)(b)(iii) and Sentence 9.10.15.4.(2).



**Figure A-9.10.15.4.(2)-B**

**Example of determination of criteria for the exposing building face of a skewed wall of a house with some arbitrary division of the wall**

**Notes to Figure A-9.10.15.4.(2)-B:**

- (1) See Sentence 9.10.15.5.(2).
- (2) See Sentence 9.10.15.5.(3).
- (3) See Table 9.10.15.4., Subclause 9.10.15.2.(1)(b)(iii) and Sentence 9.10.15.4.(2).
- (4) To simplify the calculations, choose the column for the lesser limiting distance nearest to the actual limiting distance. Interpolation for limiting distance is also acceptable and may result in a slightly larger permitted area of glazed openings. Interpolation can only be used for limiting distances greater than 1.2 m.



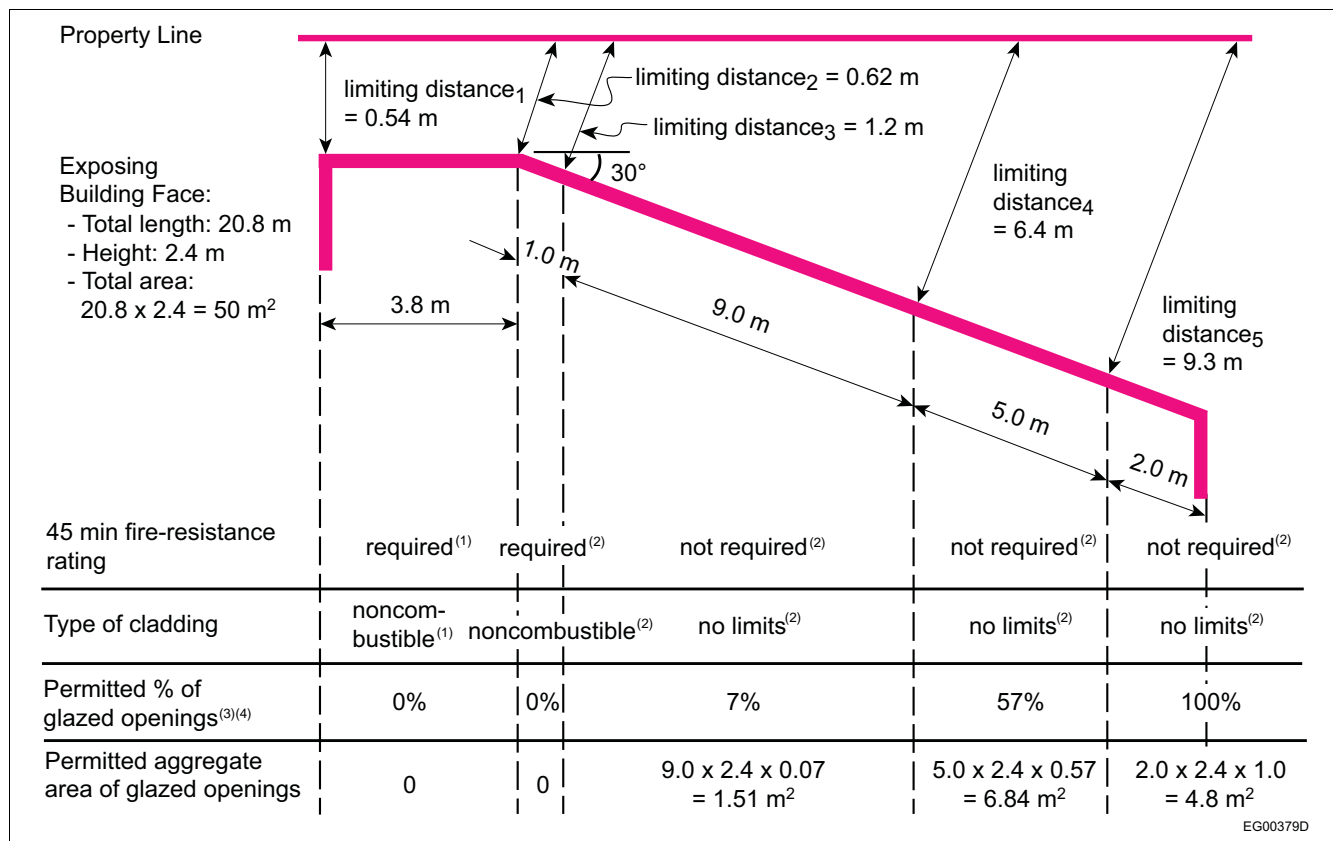


Figure A-9.10.15.4.(2)-C

Example of determination of criteria for the exposing building face of a skewed wall of a house with a different arbitrary division of the wall

Notes to Figure A-9.10.15.4.(2)-C:

- (1) See Sentence 9.10.15.5.(2).
- (2) See Sentence 9.10.15.5.(3).
- (3) See Table 9.10.15.4., Subclause 9.10.15.2.(1)(b)(iii) and Sentence 9.10.15.4.(2).
- (4) To simplify the calculations, choose the column for the lesser limiting distance nearest to the actual limiting distance. Interpolation for limiting distance is also acceptable and may result in a slightly larger permitted area of glazed openings. Interpolation can only be used for limiting distances greater than 1.2 m.

**A-9.10.19.3.(1) Location of Smoke Alarms.** There are two important points to bear in mind when considering where to locate smoke alarms in dwelling units:

- The most frequent point of origin for fires in dwelling units is the living area.
- The main concern in locating smoke alarms is to provide warning to people asleep in bedrooms.

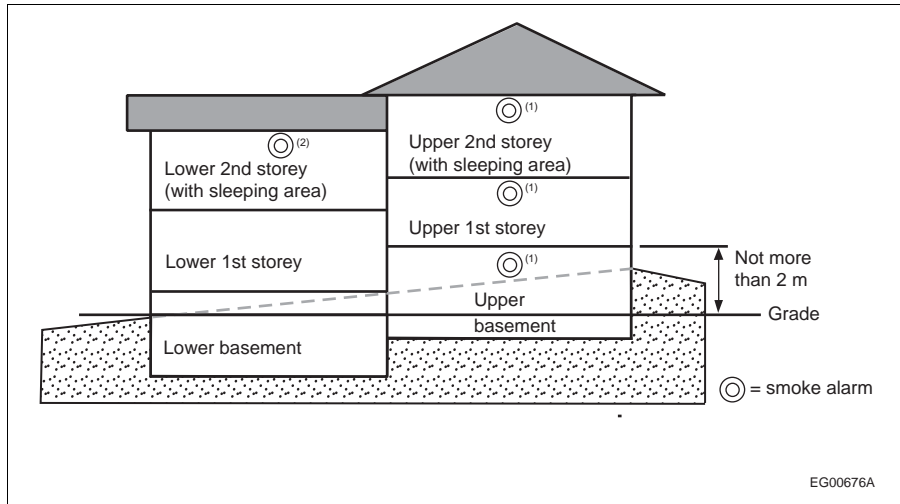
A smoke alarm located in the living area and wired so as to sound another smoke alarm located near the bedrooms is the ideal solution. However, it is difficult to define exactly what is meant by “living area.” It is felt to be too stringent to require a smoke alarm in every part of a dwelling unit that could conceivably be considered a “living area” (living room, family room, study, etc.). Sentence 9.10.19.3.(1) addresses these issues by requiring at least one smoke alarm on every storey containing a sleeping room. Thus, in a dwelling unit complying with Sentence 9.10.19.3.(1), every living area will probably be located within a reasonable distance of a smoke alarm. Nevertheless, where a choice arises as to where on a storey to locate the required smoke alarm or alarms, one should be located as close as possible to a living area, provided the requirements related to proximity to bedrooms are also satisfied.

A smoke alarm is not required on each level in a split-level dwelling unit as each level does not count as a separate storey. Determine the number of storeys in a split-level dwelling unit and which levels are part of which storey as follows:

1. establish grade, which is the lowest of the average levels of finished ground adjoining each exterior wall of a building;
2. identify the first storey, which is the uppermost storey having its floor level not more than 2 m above grade;
3. identify the basement, which is the storey or storeys located below the first storey;

4. identify the second storey and, where applicable, the third storey.

As a minimum, one smoke alarm is required to be installed in each storey, preferably on the upper level of each one. As noted above, however, when the dwelling unit contains more than one sleeping area, an alarm must be installed to serve each area. Where the sleeping areas are on two levels of a single storey in a split-level dwelling unit, an additional smoke alarm must be installed so that both areas are protected. See Figure A-9.10.19.3.(1).



**Figure A-9.10.19.3.(1)**  
**Two-storey split-level building**

**Notes to Figure A-9.10.19.3.(1):**

- (1) One smoke alarm required for each of the basement, first storey and second storey.
- (2) An additional smoke alarm is required on the lower level of the second storey outside the sleeping rooms.

**A-9.10.20.3.(1) Fire Department Access Route Modification.** In addition to other considerations taken into account in the planning of fire department access routes, special variations could be permitted for a house or residential building that is protected with an automatic sprinkler system. The sprinkler system must be designed in accordance with the appropriate NFPA standard and there must be assurance that water supply pressure and quantity are unlikely to fail. These considerations could apply to buildings that are located on the sides of hills and are not conveniently accessible by roads designed for firefighting equipment and also to infill housing units that are located behind other buildings on a given property.

**A-9.10.22. Clearances from Gas, Propane and Electric Cooktops.** CSA C22.1, “Canadian Electrical Code, Part I,” referenced in Article 9.34.1.1., and CSA B149.1, “Natural Gas and Propane Installation Code,” referenced in Article 9.10.22.1., address clearances directly above, in front of, behind and beside the appliance. Where side clearances are zero, the standards do not address clearances to building elements located both above the level of the cooktop elements or burners and to the side of the appliance. Through reference to the “Canadian Electrical Code, Part I” and the “Natural Gas and Propane Installation Code” and the requirements in Articles 9.10.22.2. and 9.10.22.3., the NBC addresses all clearances. Where clearances are addressed by the NBC and the “Canadian Electrical Code, Part I” or “Natural Gas and Propane Installation Code,” conformance with all relevant criteria is achieved by compliance with the most stringent criteria.

**Installation of Microwave Ovens Over Cooktops**

The minimum vertical clearances stated in Article 9.10.22.2. apply only to combustible framing, finishes and cabinets. They do not apply to microwave ovens installed over cooktops nor to range hoods. The “Canadian Electrical Code, Part I” requires that microwave ovens comply with CAN/CSA-C22.2 No. 150, “Microwave Ovens.” This standard includes tests to confirm that the appliance will not present a hazard when installed according to the manufacturer’s instructions.

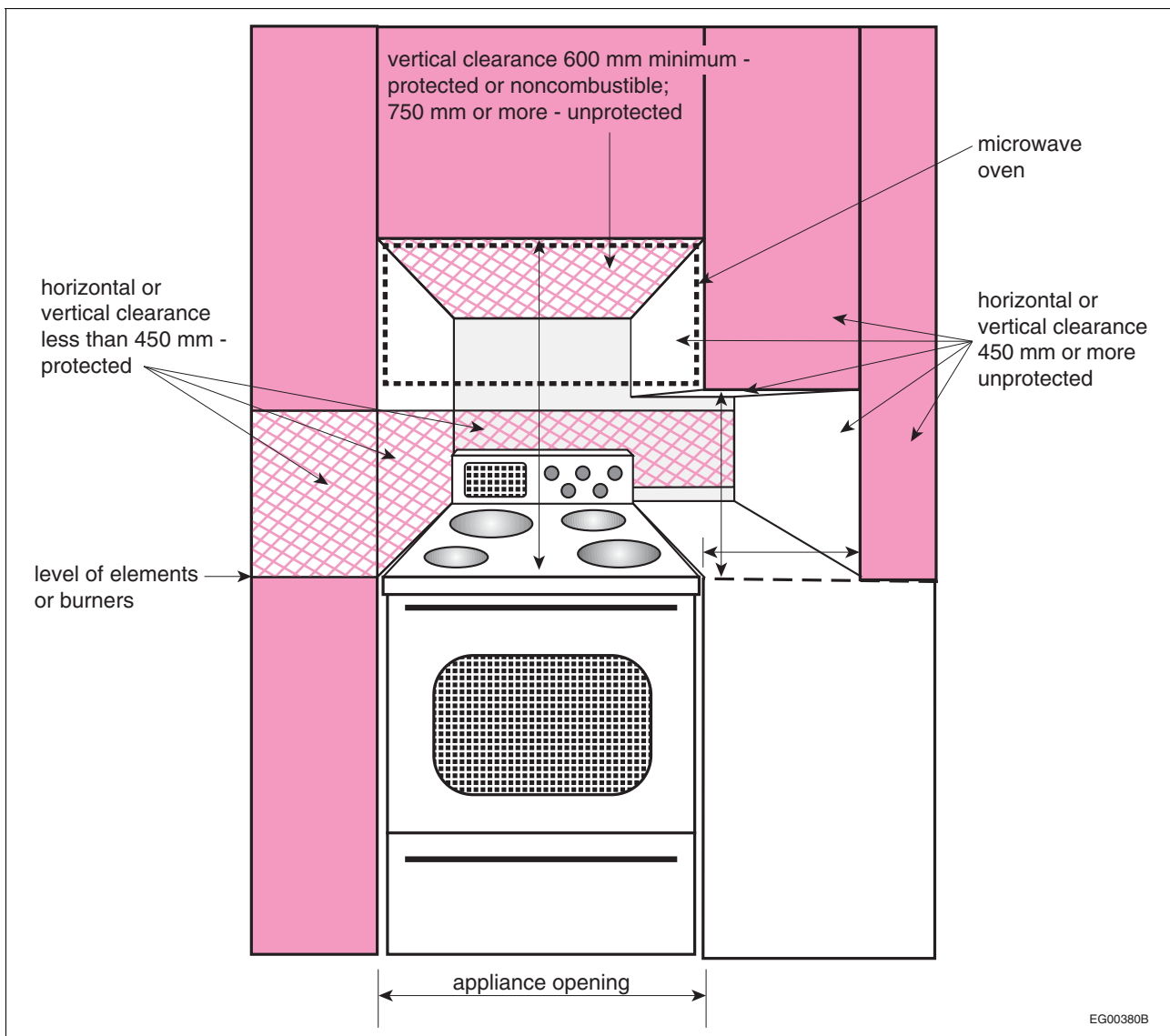


Figure A-9.10.22.  
Clearances from cooktops to walls and cabinetry

**A-9.11. Sound Transmission.**

**Airborne Sound**

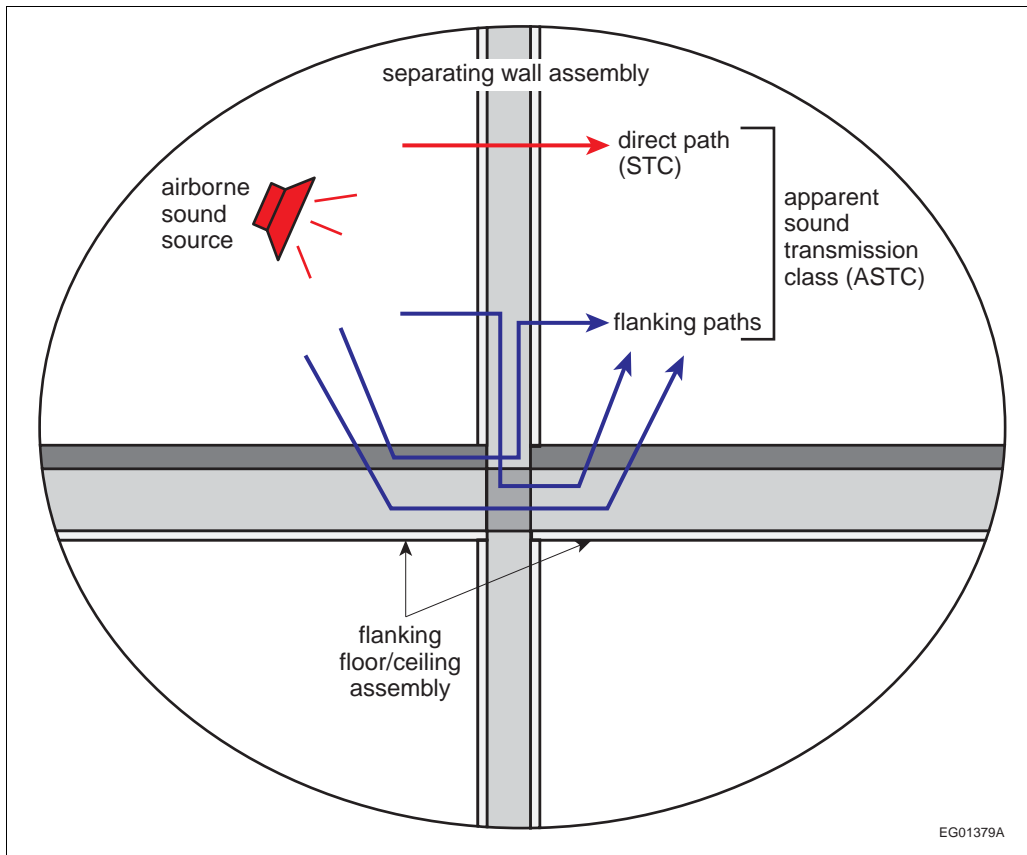
Airborne sound is transmitted between adjoining spaces directly through the separating wall, floor and ceiling assemblies and via the junctions between these separating assemblies and the flanking assemblies.

The Sound Transmission Class (STC) rating describes the performance of the separating wall or floor/ceiling assembly, whereas the Apparent Sound Transmission Class (ASTC) takes into consideration the performance of the separating element as well as the flanking transmission paths. Therefore, from the occupants' point of view, the best indicator of noise protection between two spaces is the ASTC rating.

As a key principle, it is important to follow a "whole-system" approach when designing or constructing assemblies that separate dwelling units because the overall sound performance of walls and floors is also influenced by fire protection measures and the structural design of the assemblies. Likewise, changes to the construction of assemblies to meet sound transmission requirements may have fire and structural implications. Another key principle is that enhancing the performance of the separating element does not automatically enhance the system's performance.

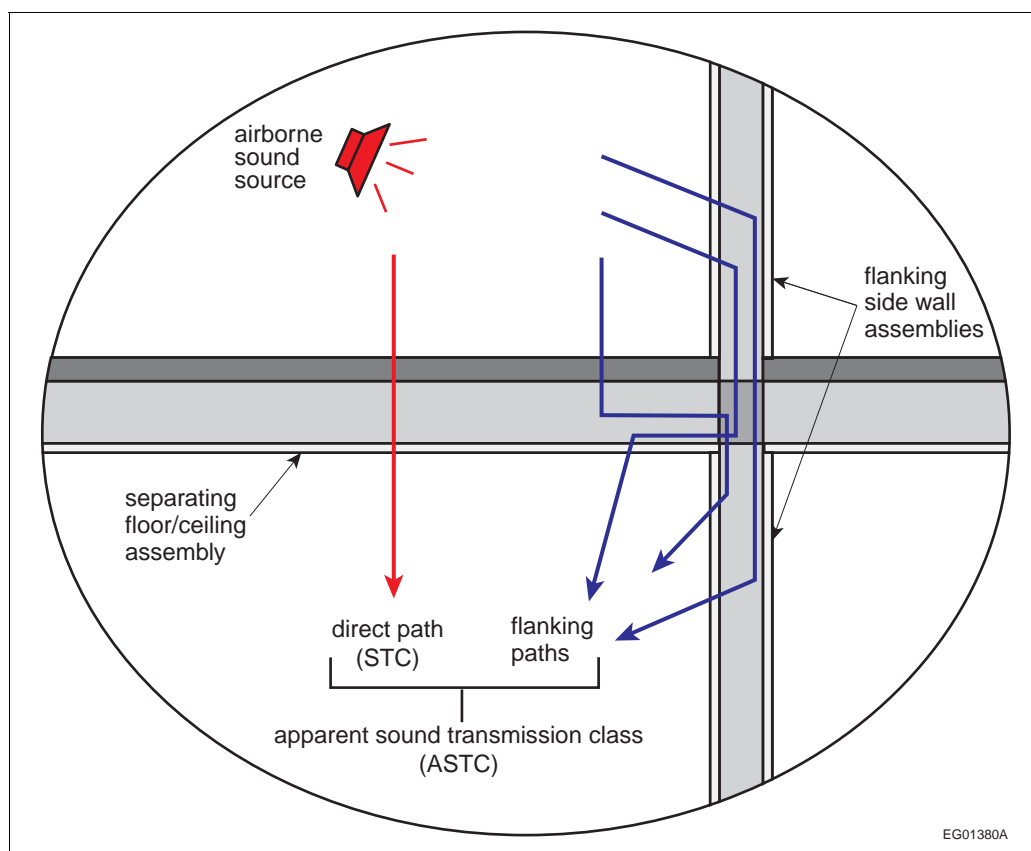
For horizontally adjoining spaces, the separating assembly is the intervening wall and the pertinent flanking surfaces include those of the floor, ceiling, and side wall assemblies that have junctions with the

separating wall assembly, normally at its four edges. For each of these junctions, there is a set of sound transmission paths. Figure A-9.11.-A illustrates the horizontal sound transmission paths at the junction of a separating wall with flanking floor assemblies.



**Figure A-9.11.-A**  
**Horizontal sound transmission paths at floor/wall junction**

For vertically adjoining spaces, the separating assembly is the intervening floor/ceiling and the pertinent flanking surfaces include those of the side wall assemblies in the upper and lower rooms that have junctions with the separating floor/ceiling assembly at its edges, of which there are normally four. For each of these junctions, there is a set of sound transmission paths. Figure A-9.11.-B illustrates the vertical sound transmission paths at the junction of a separating floor/ceiling assembly with two flanking wall assemblies.



**Figure A-9.11.-B**  
**Vertical sound transmission paths at wall/floor junction**

**Control of Sound Leaks**

The metrics used to characterize the sound transmission performance of assemblies separating dwelling units do not account for the adverse effects of air leaks in those assemblies, which can transfer sound. Sound leaks can occur where a wall meets another wall, the floor, or the ceiling. They can also occur where wall finishes are cut to allow the installation of equipment or services. The following are examples of measures for controlling sound leaks:

- avoid back-to-back electrical outlets or medicine cabinets;
- carefully seal cracks or openings so structures are effectively airtight;
- apply sealant below the plates in stud walls, between the bottom of gypsum board and the structure behind, around all penetrations for services and, in general, wherever there is a crack, a hole or the possibility of one developing;
- include sound-absorbing material inside the wall if not already required

The reduction of air leakage is also addressed to some extent by the smoke tightness requirements in the Code.

The calculation of and laboratory testing for STC and ASTC ratings are performed on intact assemblies having no penetrations or doors. When measuring ASTC ratings in the field, openings can be blocked with insulation and drywall.

To verify that the required acoustical performance is being achieved, a field test can be done at an early stage of construction. ASTM E 336, "Measurement of Airborne Sound Attenuation between Rooms in Buildings," gives a complete measurement. A simpler and less expensive method is presented in ASTM E 597, "Determining a Single Number Rating of Airborne Sound Insulation for Use in Multi-Unit Building Specifications." The rating derived from this test is usually within 2 points of the STC obtained from ASTM E 336. It is useful for verifying performance and finding problems during construction. Alterations can then be made prior to project completion.

**Impact Noise**

Section 9.11. has no requirements for the control of impact noise transmission. However, footsteps and other impacts can cause severe annoyance in multifamily residences. Builders concerned about quality and reducing occupant complaints will ensure that floors are designed to minimize impact transmission. A recommended criterion is that bare floors (tested without a carpet) should achieve an impact insulation class (IIC) of 55. Some lightweight floors that satisfy this requirement may still elicit complaints about low frequency impact noise transmission. Adding carpet to a floor will always increase the IIC rating but will not necessarily reduce low frequency noise transmission. Good footstep noise rejection requires fairly heavy floor slabs or floating floors. Impact noise requirements are being considered for inclusion in future editions of the NBC.

The most frequently used test methods for impact noise are ASTM E 492, "Laboratory Measurement of Impact Sound Transmission Through Floor-Ceiling Assemblies Using the Tapping Machine," and ASTM E 1007, "Field Measurement of Tapping Machine Impact Sound Transmission Through Floor-Ceiling Assemblies and Associated Support Structures."

**Machinery Noise**

Elevators, garbage chutes, plumbing, fans, and heat pumps are common sources of noise in buildings. To reduce annoyance from these, they should be placed as far as possible from sensitive areas. Vibrating parts should be isolated from the building structure using resilient materials such as neoprene or rubber.

**A-9.11.1.1.(2) Sound Transmission in Houses with a Secondary Suite.** Controlling sound transmission between dwelling units is important to the occupants' health and well-being. Although this may be difficult to achieve in an existing building, it is nevertheless necessary that a minimum level of sound transmission protection be provided between the dwelling units in a house with a secondary suite. A somewhat reduced level of performance is acceptable in the case of secondary suites because the occupants of the house containing a secondary suite are only affected by the sound of one other unit and, in many cases, it is the owner of the house who will decide on the desired level of protection.

**A-9.11.1.3.(2)(b) Control of Airborne Noise in Buildings.** Tables 9.10.3.1.-A and 9.10.3.1.-B present separating assemblies that comply with Section 9.11. However, selecting an appropriate separating assembly is only one part of the solution for reducing airborne sound transmission between adjoining spaces: to fully address the sound performance of the whole system, flanking assemblies must be connected to the separating assembly in accordance with Article 9.11.1.4.

**A-9.11.1.4. Adjoining Constructions.** Tables A-9.11.1.4.-A to A-9.11.1.4.-D present generic options for the design and construction of junctions between separating and flanking assemblies. Constructing according to these options is likely to meet or exceed an ASTC rating of 47. Other designs may be equally acceptable if their sound resistance can be demonstrated to meet the minimum ASTC rating or better on the basis of tests referred to in Article 9.11.1.2., or if they comply with Subsection 5.8.1. However, some caution should be applied when designing solutions that go beyond the options provided in these Tables: for example, adding more material to a wall could negatively impact its sound performance or have no effect at all.

Table A-9.11.1.4.-A presents compliance options for the construction of separating wall assemblies with flanking floor, ceiling and wall assemblies in horizontally adjoining spaces.

**Table A-9.11.1.4.-A**  
**Options for the Design and Construction of Junctions and Flanking Surfaces Between Separating Wall Assemblies in Horizontally Adjoining Spaces for Compliance with Clause 9.11.1.1.(1)(b)**

Type of Separating Wall Assembly with $STC \geq 50$ from Table 9.10.3.1.-A	Options for Design and Construction of Junctions and Flanking Surfaces <sup>(1)</sup> to Address Horizontal Sound Transmission Paths		
	Bottom Junction (between separating wall and flanking floors)	Top Junction (between separating wall and flanking ceiling)	Side Junctions (between separating wall and flanking walls)
W4, W5, W6 (single stud) W8, W9, W10, W11, W12 (staggered studs)	<ul style="list-style-type: none"> <li>for additional material layer and finished flooring, see Table 9.11.1.4.</li> <li>subfloor on both sides of wall is plywood, OSB, waferboard (15.5 mm thick) or tongue and groove lumber (<math>\geq 17</math> mm thick)</li> <li>floor is framed with wood joists, wood I-joists or wood trusses spaced <math>\geq 400</math> mm o.c., with or without absorptive material<sup>(2)</sup> in cavities</li> <li>floor joists or trusses are oriented parallel to separating wall (non-loadbearing case) or perpendicular to separating wall but are not continuous across junction (loadbearing case)</li> </ul>	<ul style="list-style-type: none"> <li>ceiling is framed with wood joists, wood I-joists, or wood trusses, with or without absorptive material<sup>(2)</sup> in cavities</li> <li>ceiling joists or trusses are oriented perpendicular to separating wall but are not continuous across junction (loadbearing case) or parallel to junction (non-loadbearing case)</li> <li>gypsum board ceiling is fastened directly to bottom of ceiling framing or on resilient metal channels<sup>(3)</sup></li> </ul>	<ul style="list-style-type: none"> <li>gypsum board on flanking walls ends or is cut at separating wall and is fastened directly to framing or on resilient metal channels<sup>(3)</sup></li> <li>flanking wall is framed with single row of wood studs, staggered studs on a single 38 mm x 140 mm plate, or 2 rows of 38 mm x 89 mm wood studs on separate 38 mm x 89 mm plates, with or without absorptive material<sup>(2)</sup> in cavities</li> <li>flanking wall framing is structurally connected to separating wall and terminates where it butts against framing of separating wall or is continuous across junction</li> </ul>
	<p>Example Showing Side View of Bottom and Top Junctions</p> <p>EG01399A</p>	<p>Example Showing Plan View of Side Junctions</p> <p>EG02084A</p>	

**Table A-9.11.1.4-A (Continued)**

Type of Separating Wall Assembly with STC ≥ 50 from Table 9.10.3.1.-A	Options for Design and Construction of Junctions and Flanking Surfaces <sup>(1)</sup> to Address Horizontal Sound Transmission Paths		
	Bottom Junction (between separating wall and flanking floors)	Top Junction (between separating wall and flanking ceiling)	Side Junctions (between separating wall and flanking walls)
	<p>Example Showing Side View of Bottom and Top Junctions</p> <p style="text-align: right;">EG02087A</p>		<p>Example Showing Plan View of Side Junctions</p> <p style="text-align: right;">EG02086A</p>
W13, W14, W15	<ul style="list-style-type: none"> <li>• for additional material layer and finished flooring, see Table 9.11.1.4.</li> <li>• subfloor on both sides of wall is plywood, OSB, waferboard (15.5 mm thick) or tongue and groove lumber (≥ 17 mm thick)</li> <li>• floor is framed with wood joists, wood I-joists or wood trusses spaced ≥ 400 mm o.c., with or without absorptive material<sup>(2)</sup> in cavities</li> <li>• floor joists or trusses are oriented parallel to separating wall (non-loadbearing case) or perpendicular to separating wall but are not continuous across junction (loadbearing case)</li> <li>• near leaf of separating wall is supported on "designated" joist</li> </ul>	<ul style="list-style-type: none"> <li>• wood joists, wood I-joists or wood trusses are oriented perpendicular or parallel to separating wall, with or without absorptive material<sup>(2)</sup> in cavities</li> <li>• joist framing at junction is supported on near leaf of separating wall</li> <li>• gypsum board ceiling panels end at wall framing and are fastened directly to bottom of ceiling framing or on resilient metal channels<sup>(3)</sup></li> </ul>	<ul style="list-style-type: none"> <li>• flanking wall framing is fastened to adjacent leaf of separating wall</li> <li>• flanking wall is framed with single row of wood studs, staggered studs on a single 38 mm x 140 mm plate, or 2 rows of 38 mm x 89 mm wood studs on separate 38 mm x 89 mm plates, with or without absorptive material<sup>(2)</sup> in cavities</li> <li>• gypsum board panels on flanking walls ends or is cut at framing of separating wall and is fastened on resilient metal channels<sup>(3)</sup> or directly to framing of flanking wall if that framing and any sheathing are not continuous across the junction</li> </ul>

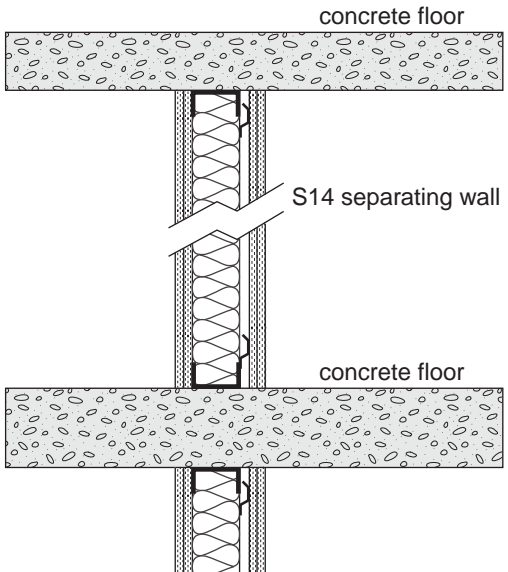
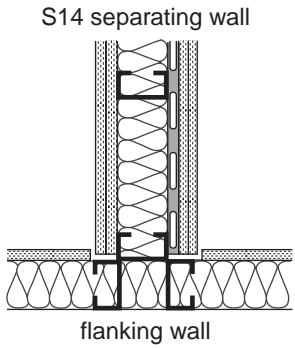
Copyright © NRC 1941 - 2021 World Rights Reserved © CNRC 1941-2021 Droits réservés pour tous pays



**Table A-9.11.1.4-A (Continued)**

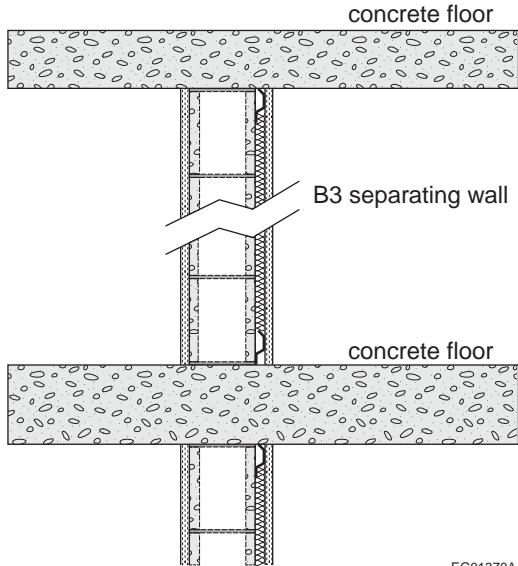
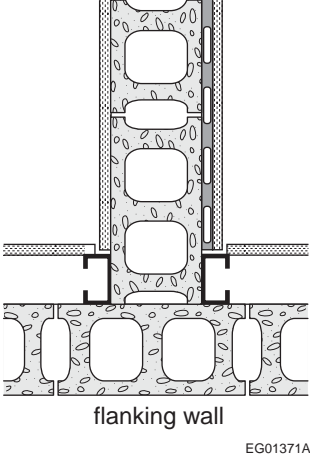
Type of Separating Wall Assembly with $STC \geq 50$ from Table 9.10.3.1.-A	Options for Design and Construction of Junctions and Flanking Surfaces <sup>(1)</sup> to Address Horizontal Sound Transmission Paths		
	Bottom Junction (between separating wall and flanking floors)	Top Junction (between separating wall and flanking ceiling)	Side Junctions (between separating wall and flanking walls)
	<p>Example Showing Side View of Bottom and Top Junctions</p> <p>ceiling</p> <p>W13 separating wall</p> <p>additional material layer over subfloor plus finished flooring with mass per area <math>&gt; 8 \text{ kg/m}^2</math></p> <p>EG01366A</p>		<p>Example Showing Plan View of Side Junctions</p> <p>W13 separating wall</p> <p>flanking wall</p> <p>EG01365A</p>

**Table A-9.11.1.4-A (Continued)**

Type of Separating Wall Assembly with $STC \geq 50$ from Table 9.10.3.1.-A	Options for Design and Construction of Junctions and Flanking Surfaces <sup>(1)</sup> to Address Horizontal Sound Transmission Paths		
	Bottom Junction (between separating wall and flanking floors)	Top Junction (between separating wall and flanking ceiling)	Side Junctions (between separating wall and flanking walls)
S1 to S15	<ul style="list-style-type: none"> <li>F1 concrete floor assembly from Table 9.10.3.1.-B with mass per area not less than <math>300 \text{ kg/m}^2</math> (e.g. normal-weight concrete with average thickness of 130 mm)</li> <li>with or without an additional material layer or finished flooring</li> </ul>	<ul style="list-style-type: none"> <li>F1 concrete floor assembly from Table 9.10.3.1.-B with mass per area not less than <math>300 \text{ kg/m}^2</math> (e.g. normal-weight concrete with average thickness of 130 mm)</li> <li>with or without gypsum board ceiling suspended below concrete floor</li> </ul>	<ul style="list-style-type: none"> <li>flanking wall framing is structurally connected to separating wall and terminates where it butts against framing of separating wall or is continuous across junction</li> <li>gypsum board on flanking walls ends or is cut at separating wall and is fastened directly to framing or on resilient metal channels<sup>(3)</sup></li> <li>flanking wall consists of steel framing (loadbearing or non-loadbearing steel studs) or concrete blocks with mass per area not less than <math>200 \text{ kg/m}^2</math> (e.g. normal-weight hollow core concrete block units<sup>(4)</sup>) with a gypsum board lining supported on framing providing a cavity not less than 50 mm deep)</li> <li>with or without absorptive material<sup>(2)</sup> in cavities behind gypsum board of flanking walls</li> </ul>
	<p>Example Showing Side View of Bottom and Top Junctions</p>  <p>EG01368A</p>	<p>Example Showing Plan View of Side Junctions</p>  <p>EG01369A</p>	

Copyright © NRC 1941 - 2021 World Rights Reserved © CNRC 1941-2021 Droits réservés pour tous pays

Table A-9.11.1.4-A (Continued)

Type of Separating Wall Assembly with STC ≥ 50 from Table 9.10.3.1.-A	Options for Design and Construction of Junctions and Flanking Surfaces <sup>(1)</sup> to Address Horizontal Sound Transmission Paths		
	Bottom Junction (between separating wall and flanking floors)	Top Junction (between separating wall and flanking ceiling)	Side Junctions (between separating wall and flanking walls)
B1 to B10	<ul style="list-style-type: none"> <li>same options as stated above for walls S1 to S15</li> </ul>	<ul style="list-style-type: none"> <li>same options as stated above for walls S1 to S15</li> <li>junction at top of concrete block assembly is loadbearing or non-loadbearing resilient joint</li> </ul>	<ul style="list-style-type: none"> <li>same options as stated above for walls S1 to S15</li> </ul>
	<p>Example Showing Side View of Bottom and Top Junctions</p>  <p style="text-align: right;">EG01370A</p>		<p>Examples Showing Plan View of Side Junctions</p>  <p style="text-align: right;">EG01371A</p>

**Notes to Table A-9.11.1.4.-A:**

- See also Table A-9.11.1.4.-B.
- Sound absorptive material is porous (closed-cell foam was not tested) and includes fibre processed from rock, slag, glass or cellulose fibre with a maximum density of 32 kg/m<sup>3</sup>. See Notes (5) and (8) of Table 9.10.3.1.-A and Note (5) of Table 9.10.3.1.-B for additional information.
- Resilient metal channels are formed from steel having a maximum thickness of 0.46 mm (25 gauge) with slits or holes in the single “leg” between the faces fastened to the framing and to the gypsum board (see Figure A-9.10.3.1.-D). ASTM C 754, “Installation of Steel Framing Members to Receive Screw-Attached Gypsum Panel Products,” describes the installation of resilient metal channels.
- Normal-weight concrete block units conforming to CSA A165.1, “Concrete Block Masonry Units,” have aggregate with a density not less than 2 000 kg/m<sup>3</sup>; 190 mm hollow core units are 53% solid, providing a wall mass per area over 200 kg/m<sup>2</sup>; 140 mm hollow core units are 75% solid, providing a wall mass per area over 200 kg/m<sup>2</sup>.

Table A-9.11.1.4.-B presents options for improving the sound performance of separating wall systems beyond that achieved by implementing the options presented in Table A-9.11.1.4.-A. The suggested performance improvement options are listed in order of approximate acoustic priority and are interdependent, i.e., if options at the top of the list are not implemented, then options at the bottom of the list will have much lesser effect.

**Table A-9.11.1.4-B**

**Options for the Construction of a Separating Wall System to Further Improve the Sound Insulation Performance Achieved with the Options in Table A-9.11.1.4-A**

Type of Separating Wall Assembly with $STC \geq 50$ from Table 9.10.3.1.-A	Performance Improvement Options for Junctions Between Separating Walls and Flanking Floor/Ceiling Assemblies
W4, W5, W6, W8, W9, W10, W11, W12	<ul style="list-style-type: none"> <li>• Increase mass per area of additional material layer and finished flooring over subfloor (e.g. concrete or gypsum concrete topping)</li> <li>• Choose separating wall assembly with higher STC rating</li> <li>• Orient floor and ceiling joists parallel to separating wall (non-loadbearing case)</li> <li>• Add resilient layer under additional material layer over subfloor or between additional material layer and finished flooring</li> <li>• Support gypsum board panels of ceiling on resilient metal channels<sup>(1)</sup></li> <li>• Support gypsum board panels of flanking walls on resilient metal channels<sup>(1)</sup></li> </ul>
W13, W14, W15	<ul style="list-style-type: none"> <li>• If seismic or other structural requirements permit, choose a fire block detail at floor/wall junction in accordance with Subsection 9.10.16. that does not provide a rigid connection between the two rows of framing of the separating wall (e.g. subfloor not continuous across junction and semi-rigid fibre insulation board filling the gap in accordance with Article 9.10.16.3.). In this case, an additional material layer would not be necessary. Also, choose separating wall assembly with higher STC rating (e.g. more absorptive material<sup>(2)</sup> in cavities and/or more gypsum board).</li> <li>• If having a rigid structural connection at the floor/wall junction (such as subfloor continuous across the junction) is required for seismic or other structural reasons, obtain a higher ASTC rating as follows:             <ul style="list-style-type: none"> <li>• Increase combined mass per area of additional material layer over subfloor and finished flooring (e.g. concrete or gypsum concrete topping)</li> <li>• Choose separating wall assembly with higher STC rating (e.g. more absorptive material<sup>(2)</sup> and/or more gypsum board)</li> <li>• Support gypsum board panels of ceiling on resilient metal channels<sup>(1)</sup></li> <li>• Support gypsum board panels of flanking walls on resilient metal channels<sup>(1)</sup></li> <li>• Add resilient layer under additional material layer over subfloor or between additional material layer and finished flooring</li> </ul> </li> </ul>
S1 to S15	<ul style="list-style-type: none"> <li>• Choose separating wall assembly with higher STC rating</li> <li>• Increase thickness of concrete floor slab and/or add material layer and finished flooring over subfloor</li> <li>• Add gypsum board ceiling on framing supported under the floor above, with cavity not less than 100 mm deep</li> <li>• Add resilient layer under additional material layer over subfloor or between additional material layer and finished flooring</li> <li>• Support gypsum board panels of flanking walls on resilient metal channels<sup>(1)</sup> if steel studs are loadbearing type</li> </ul>
B1 to B10	<ul style="list-style-type: none"> <li>• Choose separating wall assembly with higher STC rating</li> <li>• Add gypsum board ceiling supported below concrete floor with cavity not less than 100 mm deep and sound absorptive material<sup>(2)</sup> in cavity</li> <li>• Increase thickness of concrete floor slab and/or add material layer and finished flooring over subfloor</li> <li>• Add resilient layer under additional material layer over subfloor or between additional material layer and finished flooring and increase mass per area of additional material layer and finished flooring (e.g. floating concrete or gypsum concrete topping)</li> <li>• Support gypsum board panels of flanking walls on resilient metal channels<sup>(1)</sup> if steel studs are loadbearing type</li> </ul>

**Notes to Table A-9.11.1.4-B:**

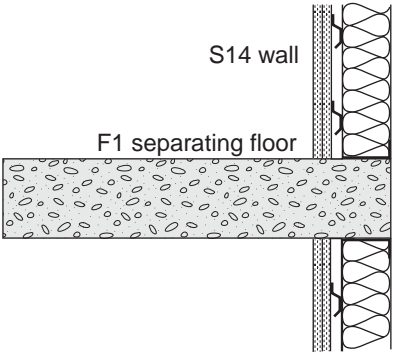
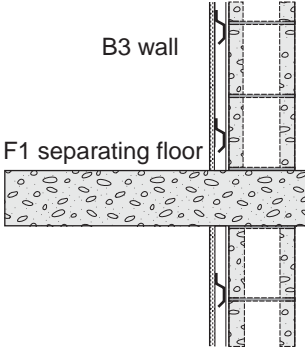
(1) Resilient metal channels are formed from steel having a maximum thickness of 0.46 mm (25 gauge) with slits or holes in the single “leg” between the faces fastened to the framing and to the gypsum board (see Figure A-9.10.3.1.-D). ASTM C 754, “Installation of Steel Framing Members to Receive Screw-Attached Gypsum Panel Products,” describes the installation of resilient metal channels.

(2) Sound absorptive material is porous (closed-cell foam was not tested) and includes fibre processed from rock, slag, glass or cellulose fibre with a maximum density of 32 kg/m<sup>3</sup>. See Notes (5) and (8) of Table 9.10.3.1.-A and Note (5) of Table 9.10.3.1.-B for additional information.

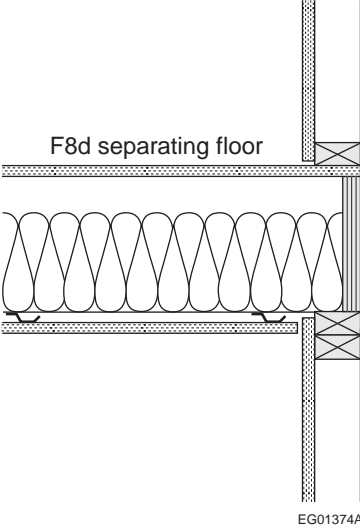
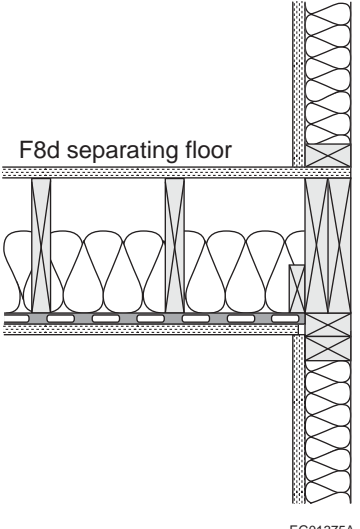
Table A-9.11.1.4.-C presents compliance options for the construction of separating floor/ceiling assemblies with flanking wall assemblies in vertically adjoining spaces.

**Table A-9.11.1.4.-C**

**Options for the Design and Construction of Junctions and Flanking Surfaces Between Separating Floor/Ceiling Assemblies in Vertically Adjoining Spaces for Compliance with Clause 9.11.1.1.(1)(b)**

Type of Separating Floor/Ceiling Assembly with $STC \geq 50$ from Table 9.10.3.1.-B	Options for Design and Construction of Junctions and Flanking Surfaces <sup>(1)</sup> to Address Vertical Sound Transmission Paths	
F1 (with or without gypsum board ceiling)	<p><b>Junctions with Flanking Steel-Framed Walls</b></p> <ul style="list-style-type: none"> <li>• floor ends at flanking wall assembly (T-junction) or extends beyond it (cross-junction)</li> <li>• steel framing of flanking walls is loadbearing or non-loadbearing, with a single row of steel studs, staggered studs, or 2 rows of studs, with studs spaced not less than 400 mm o.c., with or without absorptive material<sup>(2)</sup> in cavities</li> <li>• flanking wall structure is fastened to separating concrete floor but is not continuous across junction</li> <li>• gypsum board on flanking walls is not continuous across junction and is fastened directly to wall framing or on resilient metal channels<sup>(3)</sup></li> </ul>	<p><b>Junctions with Flanking Concrete Walls</b></p> <ul style="list-style-type: none"> <li>• floor ends at flanking wall assembly (T-junction) or extends beyond it (cross-junction)</li> <li>• one wythe of concrete blocks with mass per area not less than 200 kg/m<sup>2</sup> (e.g. normal-weight hollow core concrete block units<sup>(4)</sup>)</li> <li>• loadbearing (solid) or non-loadbearing (resilient) junction between top of flanking concrete block wall and floor structure</li> <li>• gypsum board lining is supported on wood or steel framing providing a cavity not less than 50 mm deep, with or without absorptive material<sup>(2)</sup> in cavities</li> <li>• gypsum board on flanking walls is not continuous across junction and is fastened directly to wall framing or on resilient metal channels<sup>(3)</sup></li> </ul>
	<p style="text-align: center;">Examples Showing Side View of Junctions</p> <div style="display: flex; justify-content: space-around; align-items: center;"> <div style="text-align: center;">  <p>S14 wall</p> <p>F1 separating floor</p> <p>EG01372A</p> </div> <div style="text-align: center;">  <p>B3 wall</p> <p>F1 separating floor</p> <p>EG01373A</p> </div> </div>	
F8 to F38	<p><b>Junctions with Flanking Loadbearing or Non-Loadbearing Walls</b></p>	
	<ul style="list-style-type: none"> <li>• wood studs of flanking wall are 38 mm x 89 mm or 38 mm x 140 mm and spaced 400 mm or 600 mm o.c.</li> <li>• flanking wall framing consists of single row of wood studs, staggered studs on a single 38 mm x 140 mm plate, or 2 rows of 38 mm x 89 mm wood studs on separate 38 mm x 89 mm plates, with or without absorptive material<sup>(2)</sup> in wall cavities</li> <li>• gypsum board on flanking walls ends or is cut near floor framing and is fastened directly to wall framing or supported on resilient metal channels<sup>(3)</sup></li> </ul>	

**Table A-9.11.1.4.-C (Continued)**

Type of Separating Floor/Ceiling Assembly with $STC \geq 50$ from Table 9.10.3.1.-B	Options for Design and Construction of Junctions and Flanking Surfaces <sup>(1)</sup> to Address Vertical Sound Transmission Paths	
	<p>Example Showing Side View of Junctions in Flanking Loadbearing Wall</p>  <p>EG01374A</p>	<p>Example Showing Side View of Junctions in Flanking Non-Loadbearing Wall</p>  <p>EG01375A</p>

**Notes to Table A-9.11.1.4.-C:**

- (1) See also Table A-9.11.1.4.-D.
- (2) Sound absorptive material is porous (closed-cell foam was not tested) and includes fibre processed from rock, slag, glass or cellulose fibre with a maximum density of 32 kg/m<sup>3</sup>. See Notes (5) and (8) of Table 9.10.3.1.-A and Note (5) of Table 9.10.3.1.-B for additional information.
- (3) Resilient metal channels are formed from steel having a maximum thickness of 0.46 mm (25 gauge) with slits or holes in the single “leg” between the faces fastened to the framing and to the gypsum board (see Figure A-9.10.3.1.-D). ASTM C 754, “Installation of Steel Framing Members to Receive Screw-Attached Gypsum Panel Products,” describes the installation of resilient metal channels.
- (4) Normal-weight concrete block units conforming to CSA A165.1, “Concrete Block Masonry Units,” have aggregate with a density not less than 2 000 kg/m<sup>3</sup>; 190 mm hollow core units are 53% solid, providing a wall mass per area over 200 kg/m<sup>2</sup>; 140 mm hollow core units are 75% solid, providing a wall mass per area over 200 kg/m<sup>2</sup>.

Table A-9.11.1.4.-D presents options for improving the sound performance of separating floor/ceiling assemblies beyond that achieved by implementing the options presented in Table A-9.11.1.4.-C. The suggested performance improvement options are listed in order of approximate acoustic priority and are interdependent, i.e., if options at the top of the list are not implemented, then options at the bottom of the list will have much lesser effect.

Copyright © NRC 1941 - 2021 World Rights Reserved © CNRC 1941-2021 Droits réservés pour tous pays

**Table A-9.11.1.4.-D**  
**Options for the Construction of a Separating Floor System to Further Improve the Sound Insulation Performance Achieved with the Options in Table A-9.11.1.4.C.**

Type of Separating Floor Assembly with STC ≥ 50 from Table 9.10.3.1.-B	Performance Improvement Options for Junctions Between Separating Floors and Flanking Wall Assemblies
F1 (with or without gypsum board ceiling)	<ul style="list-style-type: none"> <li>• Add heavier additional material layer over subfloor and/or resilient layer under additional material layer or between additional material layer and finished flooring</li> <li>• Add gypsum board ceiling supported at least 100 mm below concrete floor with minimal structural connection (e.g. ceiling framing supported resiliently) and sound absorptive material<sup>(1)</sup> in cavity</li> <li>• Support gypsum board of flanking walls of lower room on resilient metal channels<sup>(2)</sup> (if framed with loadbearing studs)</li> </ul>
F8 to F38	<ul style="list-style-type: none"> <li>• Add heavier additional material layer over subfloor and/or resilient layer under additional material layer or between additional material layer and finished flooring</li> <li>• Add more/heavier gypsum board to ceiling and increase spacing of resilient metal channels<sup>(2)</sup> to 600 mm o.c.</li> <li>• Support gypsum board of flanking loadbearing walls of lower room on resilient metal channels<sup>(2)</sup></li> <li>• Support gypsum board on flanking non-loadbearing walls of lower room on resilient metal channels<sup>(2)</sup></li> </ul>

**Notes to Table A-9.11.1.4.-D:**

- (1) Sound absorptive material is porous (closed-cell foam was not tested) and includes fibre processed from rock, slag, glass or cellulose fibre with a maximum density of 32 kg/m<sup>3</sup>. See Notes (5) and (8) of Table 9.10.3.1.-A and Note (5) of Table 9.10.3.1.-B for additional information.
- (2) Resilient metal channels are formed from steel having a maximum thickness of 0.46 mm (25 gauge) with slits or holes in the single “leg” between the faces fastened to the framing and to the gypsum board (see Figure A-9.10.3.1.-D). ASTM C 754, “Installation of Steel Framing Members to Receive Screw-Attached Gypsum Panel Products,” describes the installation of resilient metal channels.

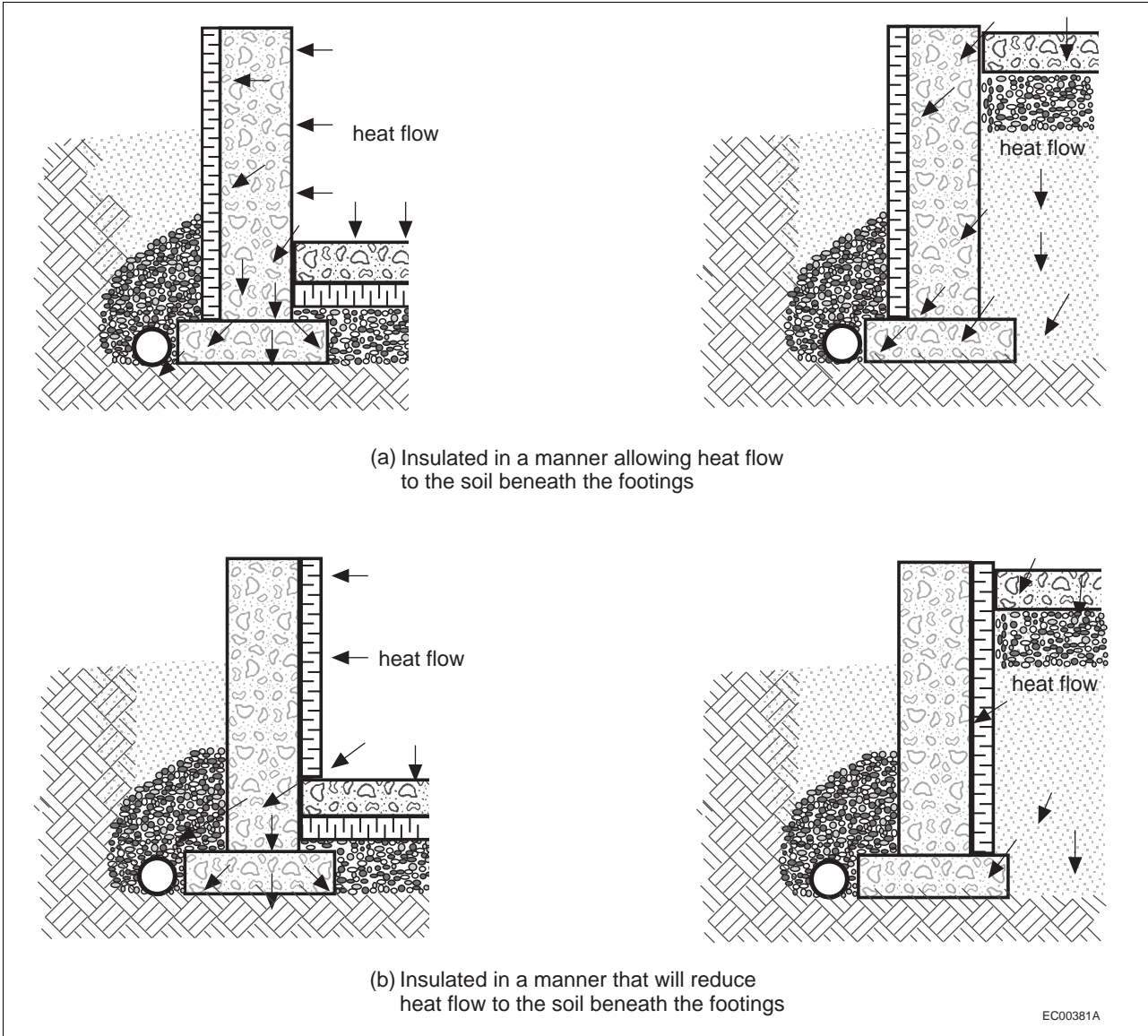
**A-Table 9.11.1.4. Floor Treatments.** The sound insulation performance of lightweight framed floors can be improved by adding floor treatments, i.e., additional layers of material over the subfloor (e.g. concrete topping, OSB or plywood) and finished flooring or coverings (e.g., carpet, engineered wood). Table A-Table 9.11.1.4. presents the mass per area values based on thickness and density of a number of generic floor treatment materials (the values for proprietary products may be different; consult the manufacturer’s current data sheets for their products’ values).

**Table A-Table 9.11.1.4.**  
**Mass per Area of Floor Treatment Materials**

Floor Treatment Material	Thickness, mm	Density, kg/m <sup>3</sup>	Mass per Area, kg/m <sup>2</sup>
<b>Materials Typically Having a Mass per Area Less Than 8 kg/m<sup>2</sup></b>			
Medium-density fibreboard (MDF)	2.9–6.1	790–810	2.3–5.0
Plywood – generic softwood	12.5–13.3	450–500	5.6–6.6
	15.5–16.3		7.0–8.1
Ceramic tile	8.4	700–1 000	5.9–8.4
<b>Materials Typically Having a Mass per Area Greater Than 8 kg/m<sup>2</sup> but Less Than 16 kg/m<sup>2</sup></b>			
Particleboard	11.3–19.2	710–755	8.1–14.5
Medium-density fibreboard (MDF)	13.9–21.1	640–755	8.9–15.9
Oriented strandboard (OSB)	14.3–15.8	600–680	8.6–10.7
	17.3–18.8		10.4–12.8
Plywood – generic softwood	25.5	450–500	11.5–13.1
<b>Materials Typically Having a Mass per Area Greater Than 16 kg/m<sup>2</sup> but Less Than 32 kg/m<sup>2</sup></b>			
Medium-density fibreboard (MDF)	25.0–32.1	640–740	16.0–23.7
<b>Materials Typically Having a Mass per Area Greater Than 32 kg/m<sup>2</sup></b>			
Concrete	40.0–50.0	2 015–2 380	80.6–119.0
Gypsum concrete	25.0	1 840–1 870	46.1–46.7

**A-Table 9.12.2.2. Minimum Depths of Foundations.** The requirements for clay soils or soils not clearly defined are intended to apply to those soils that are subject to significant volume changes with changes in moisture content.

**A-9.12.2.2.(2) Depth and Insulation of Foundations.**



**Figure A-9.12.2.2(2)**  
**Foundation insulation and heat flow to footings**

Copyright © NRC 1941 - 2021 World Rights Reserved © CNRC 1941-2021 Droits réservés pour tous pays



**A-9.12.3.3.(1) Deleterious Material in Backfill.** The deleterious debris referred to in this provision includes, but is not limited to:

- organic material and other material subject to decomposition and compaction, which could have an adverse effect on grading around the building,
- materials that will off-gas and have the potential to pose a health hazard, and
- materials that are incompatible with materials used in the foundations, footings, drainage materials or components, or other elements of the building whose required performance would be adversely affected.

**A-9.13.2.5. Protection of Interior Finishes against Moisture.** Excess water from cast-in-place concrete and ground moisture tends to migrate toward interior spaces, particularly in the spring and summer. Where moisture-susceptible materials, such as finishes or wood members, are in contact with the foundation wall, the moisture needs to be controlled by installing a moisture barrier on the interior surface of the foundation wall that extends from the underside of the interior finish up the face of the wall to a point just above the level of the ground outside.

The reason the moisture barrier on the interior surface of the foundation wall must be stopped near ground level is to allow any moisture that finds its way into the finished wall cavity from the interior space (through leaks in the air or vapour barrier) to diffuse to the exterior. If the vapour permeance of dampproofing membranes or coatings exceeds  $170 \text{ ng}/(\text{Pa}\cdot\text{s}\cdot\text{m}^2)$ , such moisture barriers may be carried full height; if their vapour permeance is less than that, this moisture risks being trapped on the interior surface of the moisture barriers. The permeance limit corresponds to the lower limit for breather-type membranes, such as asphalt-impregnated sheathing paper.

Some insulation products can also be used to protect interior finishes from the effects of moisture. They have shown acceptable performance when applied over the entire foundation wall because, in this case, they also provide vapour barrier and moisture barrier functions and possibly also the air barrier function. Where a single product provides all these functions, there is no risk of trapping moisture between two functional barriers with low water vapour permeance.

**A-9.13.4. Soil Gas Control.** Outdoor air entering a dwelling through above-grade leaks in the building envelope normally improves the indoor air quality in the dwelling by reducing the concentrations of pollutants and water vapour. It is only undesirable because it cannot be controlled. On the other hand, air entering a dwelling through below-grade leaks in the envelope may increase the water vapour content of the indoor air and may also bring in a number of pollutants picked up from the soil. This mixture of air, water vapour and pollutants is sometimes referred to as “soil gas.” One pollutant often found in soil gas is radon.

Sentence 9.13.4.2.(1), which requires the installation of an air barrier system, addresses the protection from all soil gases, while the remainder of Article 9.13.4.2. along with Article 9.13.4.3., which require the provision of the means to depressurize the space between the air barrier and the ground, specifically address the capability to mitigate high radon concentrations in the future, should this become necessary.

Radon is a colourless, odourless, radioactive gas that occurs naturally as a result of the decay of radium. It is found to varying degrees as a component of soil gas in all regions of Canada and is known to enter dwelling units by infiltration into basements and crawl spaces. The presence of radon in sufficient quantity can lead to an increased risk of lung cancer.

The potential for high levels of radon infiltration is very difficult to evaluate prior to construction and thus a radon problem may only become apparent once the building is completed and occupied. Therefore various sections of Part 9 require the application of certain radon exclusion measures in all dwellings. These measures are

- low in cost,
- difficult to retrofit, and
- desirable for other benefits they provide.

The principal method of resisting the ingress of all soil gases, a resistance which is required for all buildings (see Sentence 9.13.4.2.(1)), is to seal the interface between the soil and the occupied space, so far as is reasonably practicable. Sections 9.18. and 9.25. contain requirements for air and soil gas barriers in assemblies in contact with ground, including those in crawl spaces. Providing control joints to reduce cracking of foundation walls and airtight covers for sump pits (see Section 9.14.) are other measures that can help achieve this objective. The requirements provided in Subsection 9.25.3. are explained in Notes A-9.25.3.4. and 9.25.3.6. and A-9.25.3.6.(2) and (3).

The principal method of excluding radon is to ensure that the pressure difference across the ground/space interface is positive (i.e., towards the outside) so that the inward flow of radon through any remaining leaks will be minimized. The requirements provided in Article 9.13.4.3. are explained in Note A-9.13.4.3.

**A-9.13.4.2.(3) Exception for Buildings Occupied for a Few Hours a Day.** The criterion used by Health Canada to establish the guideline for acceptable radon concentration is the time that occupants spend inside buildings. Health Canada recommends installing a means for the future removal of radon in buildings that are occupied by persons for more than 4 hours per day. Sentence 9.13.4.2.(3) may therefore not apply to buildings or portions of buildings that are intended to be occupied for less than 4 hours a day. Addressing a radon problem in such buildings in the future, should that become necessary, can also be achieved by providing a means for increased ventilation at times when these buildings are occupied.

**A-9.13.4.3.****Providing Performance Criteria for the Depressurization of the Space Between the Air Barrier and the Ground**

Article 9.13.4.3. contains two sets of requirements: Sentence (2) describes the criteria for subfloor depressurization systems using performance-oriented language, while Sentence (3) describes one particular acceptable solution using more prescriptive language.

In some cases, subfloor depressurization requires a solution other than the one described in Sentence (3), for example, where compactable fill is installed under slab-on-grade construction.

**Completion of a Subfloor Depressurization System**

The completion of a subfloor depressurization system may be necessary to reduce the radon concentration to a level below the guideline specified by Health Canada.

Further information on protection from radon ingress can be found in the following Health Canada publications:

- “Radon: A Guide for Canadian Homeowners” (CMHC/HC), and
- “Guide for Radon Measurements in Residential Dwellings (Homes).”

**A-9.13.4.3.(2)(b) and (3)(b)(i) Effective Depressurization.** To allow effective depressurization of the space between the air barrier and the ground, the extraction opening (the pipe) should not be blocked and should be arranged such that air can be extracted from the entire space between the air barrier and the ground. This will ensure that the extraction system can maintain negative pressure underneath the entire floor (or in heated crawl spaces underneath the air barrier). The arrangement and location of the extraction system inlet(s) may have design implications where the footing layout separates part of the space underneath the floor.

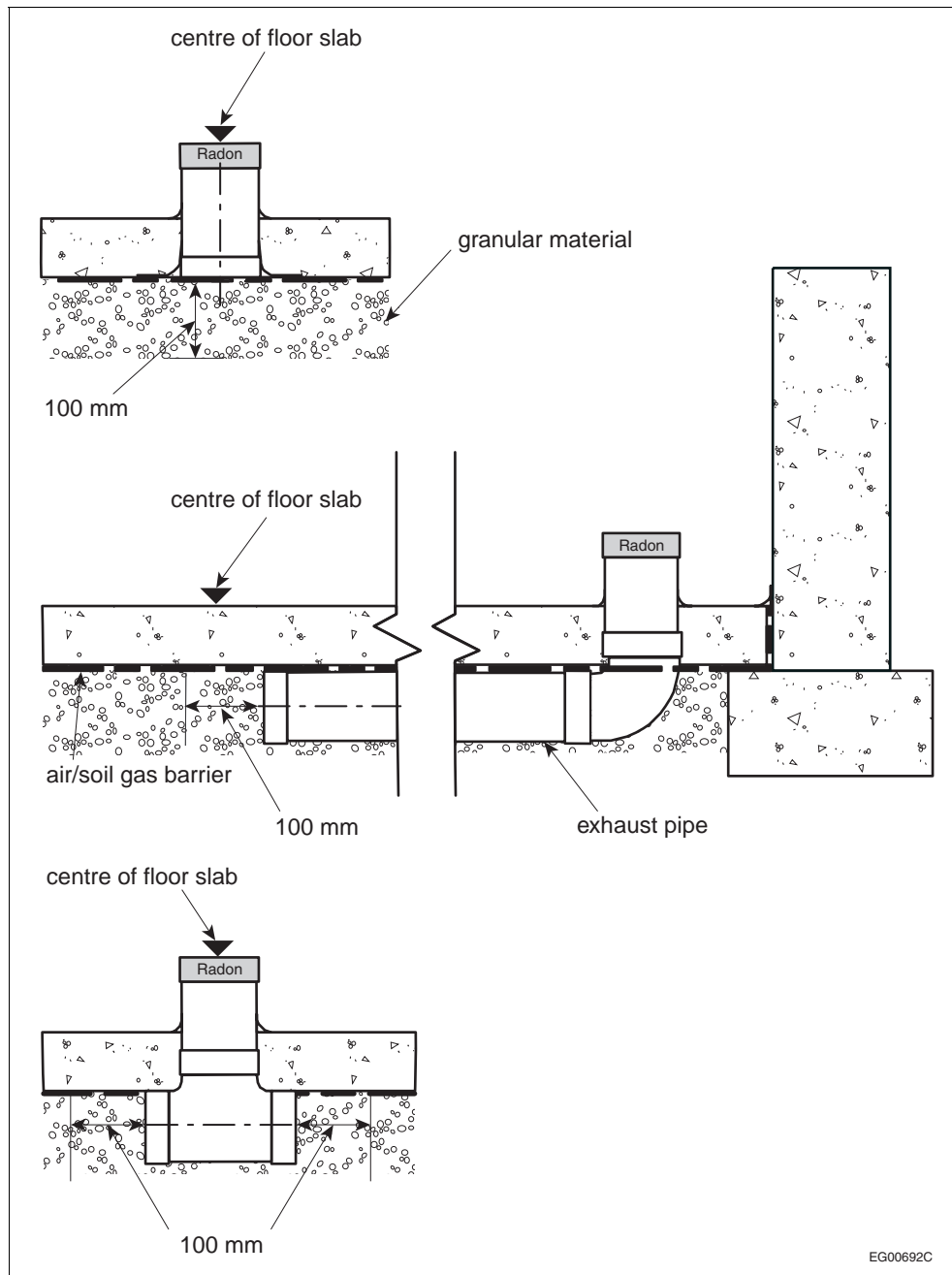


Figure A-9.13.4.3.(2)(b) and (3)(b)(i)  
 Acceptable configurations for the extraction opening in a depressurization system

**A-9.14.2.1.(2)(a) Insulation Applied to the Exterior of Foundation Walls.** In addition to the prevention of heat loss, some types of mineral fibre insulation, such as rigid glass fibre, are installed on the exterior of basement walls for the purpose of moisture control. This is sometimes used instead of crushed rock as a drainage layer between the basement wall and the surrounding soil in order to facilitate the drainage of soil moisture. Water drained by this drainage layer must be carried away from the foundation by the footing drains or the granular drainage layer in order to prevent it from developing hydro-static pressure against the wall. Provision must be made to permit the drainage of this water either by extending the insulation or crushed rock to the drain or by the installation of granular material connecting the two. The installation of such drainage layer does not eliminate the need for normal waterproofing or dampproofing of walls as specified in Section 9.13.

**A-9.15.1.1. Application of Footing and Foundation Requirements to Decks and Similar Constructions.** Because decks, balconies, verandas and similar platforms support occupancies, they are, by definition, considered as buildings or parts of buildings. Consequently, the requirements in Section 9.15. regarding footings and foundations apply to these constructions.

**A-9.15.1.1.(1)(c) and 9.20.1.1.(1)(b) Flat Insulating Concrete Form Walls.** Insulating concrete form (ICF) walls are concrete walls that are cast into polystyrene forms, which remain in place after the concrete has cured. Flat ICF walls are solid ICF walls where the concrete is of uniform thickness over the height and width of the wall.

**A-9.15.2.4.(1) Preserved Wood Foundations – Design Assumptions.** Tabular data and figures in CSA S406, “Permanent Wood Foundations for Housing and Small Buildings,” are based upon the general principles provided in CSA O86, “Engineering Design in Wood,” with the following assumptions:

- soil bearing capacity: 75 kPa or more,
- clear spans for floors: 5 000 mm or less,
- floor loadings: 1.9 kPa for first floor and suspended floor, and 1.4 kPa for second storey floor,
- foundation wall heights: 2 400 mm for slab floor, 3 000 mm for suspended wood floor,
- top of granular layer to top of suspended wood floor: 600 mm,
- lateral load from soil pressure: equivalent to fluid pressure of 4.7 kPa per metre of depth,
- ground snow load: 3 kPa,
- basic snow load coefficient: 0.6,
- roof loads are carried to the exterior wall,
- dead loads:

roof	0.50 kPa
floor	0.47 kPa
wall (with siding)	0.32 kPa
wall (with masonry veneer)	1.94 kPa
foundation wall	0.27 kPa
partitions	0.20 kPa

**A-9.15.3.4.(2) Footing Sizes.** The footing sizes in Table 9.15.3.4. are based on typical construction consisting of a roof, not more than 3 storeys, and centre bearing walls or beams. For this reason, Clause 9.15.3.3.(1)(b) stipulates a maximum supported joist span of 4.9 m.

It has become common to use flat wood trusses or wood I-joists to span greater distances in floors of small buildings. Where these spans exceed 4.9 m, minimum footing sizes may be based on the following method:

- (a) Determine for each storey the span of joists that will be supported on a given footing. Sum these lengths ( $sum_1$ ).
- (b) Determine the product of the number of storeys times 4.9 m ( $sum_2$ ).
- (c) Determine the ratio of  $sum_1$  to  $sum_2$ .
- (d) Multiply this ratio by the minimum footing sizes in Table 9.15.3.4. to get the required minimum footing size.

Example: A 2-storey house is built using wood I-joists spanning 6 m.

- (a)  $sum_1 = 6 + 6 = 12$  m
- (b)  $sum_2 = 4.9 \times 2 = 9.8$  m
- (c) ratio  $sum_1/sum_2 = 12/9.8 = 1.22$
- (d) required minimum footing size =  $1.22 \times 350$  mm (minimum footing size provided in Table 9.15.3.4.) = 427 mm.

**A-9.17.2.2.(2) Lateral Support of Columns.** Because the NBC does not provide prescriptive criteria to describe the minimum required lateral support, constructions are limited to those that have demonstrated effective performance over time and those that are designed according to Part 4. Verandas on early 20th century homes provide one example of constructions whose floor and roof are typically tied to the rest of the building to provide effective lateral support. Large decks set on tall columns, however, are likely to require additional lateral support even where they are connected to the building on one side.

**A-9.17.3.4. Design of Steel Columns.** The permitted live floor loads of 2.4 kPa and the spans described for steel beams, wood beams and floor joists are such that the load on columns could exceed 36 kN, the maximum allowable load on columns prescribed in CAN/CGSB-7.2, "Adjustable Steel Columns." In the context of Part 9, loads on columns are calculated from the supported area times the live load per unit area, using the supported length of joists and beams. The supported length is half of the joist spans on each side of the beam and half the beam span on each side of the column.

Dead load is not included based on the assumption that the maximum live load will not be applied over the whole floor. Designs according to Part 4 must consider all applied loads.

**A-9.18.7.1.(4) Protection of Ground Cover in Warm Air Plenums.** The purpose of the requirement is to protect combustible ground cover from smouldering cigarette butts that may drop through air registers. The protective material should extend beyond the opening of the register and have up-turned edges, as a butt may be deflected sideways as it falls.

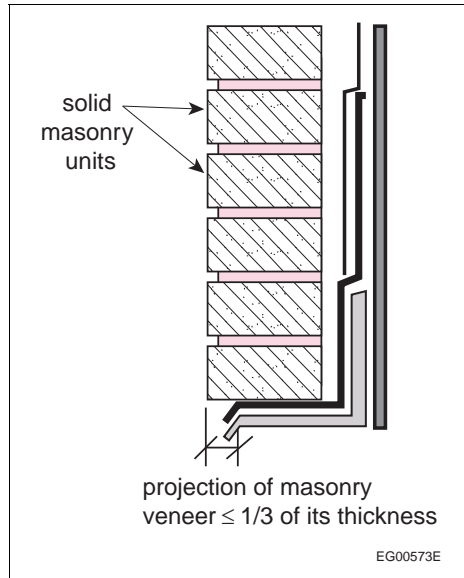
**A-9.19.1.1.(1) Venting of Attic or Roof Spaces.** Controlling the flow of moisture by air leakage and vapour diffusion into attic or roof spaces is necessary to limit moisture-induced deterioration. Given that imperfections normally exist in the vapour barriers and air barrier systems, recent research indicates that venting of attic or roof spaces is generally still required. The exception provided in Article 9.19.1.1. recognizes that some specialized ceiling-roof assemblies, such as those used in some factory-built buildings, have, over time, demonstrated that their construction is sufficiently tight to prevent excessive moisture accumulation. In these cases, ventilation would not be required.

**A-9.19.2.1.(1) Access to Attic or Roof Space.** The term "open space" refers to the space between the insulation and the roof sheathing. Sentence 9.19.2.1.(1) requires the installation of an access hatch where the open space in the attic or roof is large enough to allow visual inspection. Although the dimensions of an uninsulated attic or roof space may meet the size that triggers the requirement for an access hatch to be installed, most of that space will actually be filled with insulation and may therefore not be easily inspected, particularly in smaller buildings or under low-sloped roofs. See also Article 9.36.2.6.

**A-9.20.1.2. Seismic Information.** Information on spectral response acceleration values for various locations can be found in Appendix C.

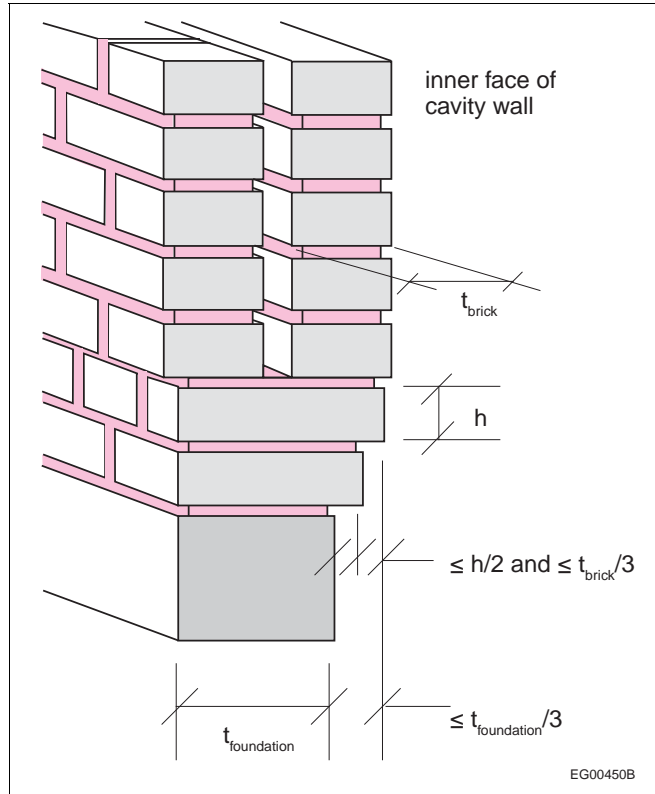
**A-9.20.5.1.(1) Masonry Support.** Masonry veneer must be supported on a stable structure in order to avoid cracking of the masonry due to differential movement relative to parts of the support. Wood framing is not normally used as a support for the weight of masonry veneer because of its shrinkage characteristics. Where the weight of masonry veneer is supported on a wood structure, as is the case for the preserved wood foundations referred to in Sentence 9.20.5.1.(1) for example, measures must be taken to ensure that any differential movement that may be harmful to the performance of masonry is minimized or accommodated. The general principle stated in Article 9.4.1.1., however, makes it possible to support the weight of masonry veneer on wood framing, provided that engineering design principles prescribed in Part 4 are followed to ensure that the rigidity of the support is compatible with the stiffness of the masonry being supported and that differential movements between the support and masonry are accommodated.

**A-9.20.8.5.(1) Projection of Masonry Beyond Supporting Members.**



**Figure A-9.20.8.5.(1)**  
Maximum projection of masonry veneer beyond its support

**A-9.20.12.2.(2) Corbelling of Masonry Foundation Walls.**

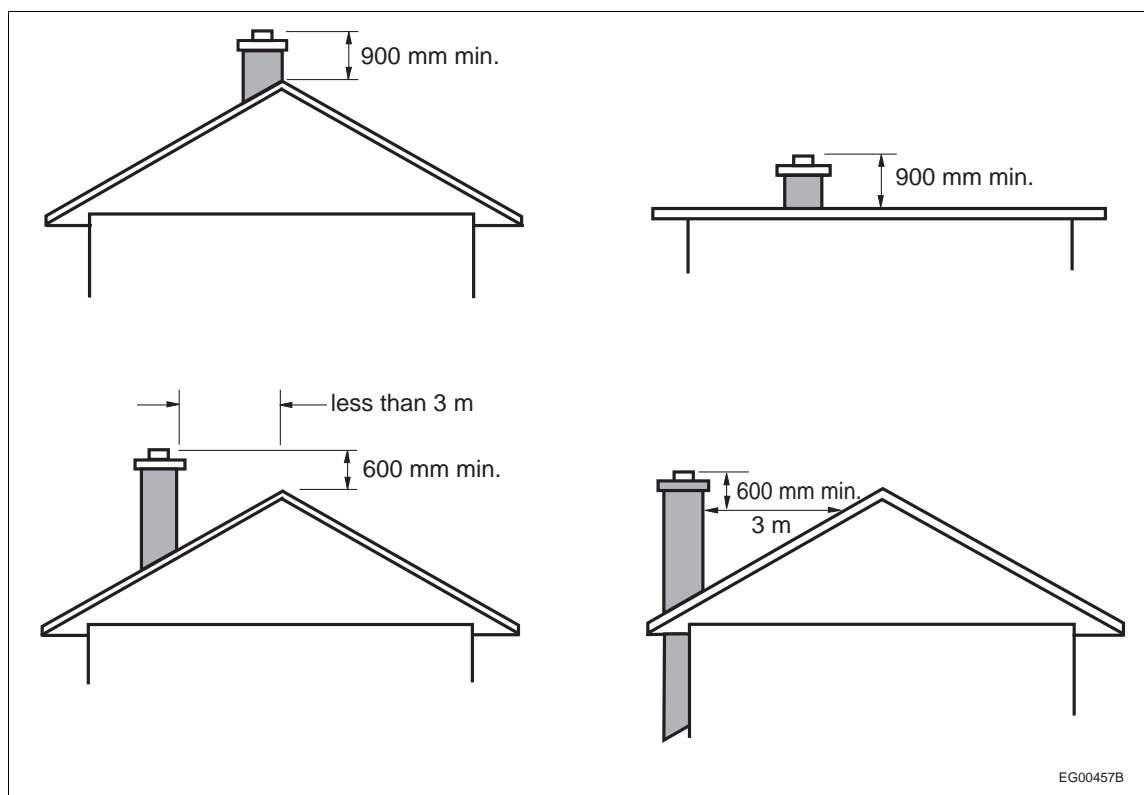


**Figure A-9.20.12.2.(2)**  
Maximum corbel dimensions

**A-9.20.13.9.(3) Dampproofing of Masonry Walls.** The reason for installing a sheathing membrane behind masonry walls is to prevent rainwater from reaching the interior finish if it should leak past the masonry. The sheathing membrane intercepts the rainwater and leads it to the bottom of the wall where the flashing directs it to the exterior via weep holes. If the insulation is a type that effectively resists the penetration of water, and is installed so that water will not collect behind it, then there is no need for a sheathing membrane. If water that runs down between the masonry and the insulation is able to leak out at the joints in the insulation, such insulation will not act as a substitute for a sheathing membrane. If water cannot leak through the joints in the insulation but collects in cavities between the masonry and insulation, subsequent freezing could damage the wall. Where a sheathing membrane is not used, the adhesive or mortar should therefore be applied to form a continuous bond between the masonry and the insulation. If this is not practicable because of an irregular masonry surface, then a sheathing membrane is necessary.

**A-9.21.3.6.(2) Metal Chimney Liners.** Under the provisions of Article 1.2.1.1. of Division A, masonry chimneys with metal liners may be permitted to serve solid-fuel-burning appliances if tests show that such liners will provide an equivalent level of safety.

**A-9.21.4.4.(1) Location of Chimney Top.**



**Figure A-9.21.4.4.(1)**  
Vertical and horizontal distances from chimney top to roof

**A-9.21.4.5.(2) Lateral Support for Chimneys.** Where a chimney is fastened to the house framing with metal anchors, in accordance with CSA A370, "Connectors for Masonry," it is considered to have adequate lateral support. The portion of the chimney stack above the roof is considered as free standing and may require additional lateral support.

**A-9.21.5.1.(1) Clearance from Combustible Materials.** For purposes of this Sentence, an exterior chimney can be considered to be one which has at least one surface exposed to the outside atmosphere or unheated space over the majority of its height. All other chimneys should be considered to be interior.

**A-9.23.1.1. Constructions Other than Light Wood-Frame Constructions.** The prescriptive requirements in Section 9.23. apply only to standard light wood-frame construction. Other constructions, such as post, beam and plank construction, plank frame wall construction, and log construction must be designed in accordance with Part 4.

**A-9.23.1.1.(1) Application of Section 9.23.** In previous editions of the Code, Sentence 9.23.1.1.(1) referred to “conventional” wood-frame construction. Over time, conventions have changed and the application of Part 9 has expanded.

The prescriptive requirements provided in Section 9.23. still focus on lumber beams, joists, studs and rafters as the main structural elements of “wood-frame construction.” The requirements recognize—and have recognized for some time—that walls and floors may be supported by components made of material other than lumber; for example, by foundations described in Section 9.15. or by steel beams described in Article 9.23.4.3. These constructions still fall within the general category of wood-frame construction.

With more recent innovations, alternative structural components are being incorporated into wood-frame buildings. Wood I-joists, for example, are very common. Where these components are used in lieu of lumber, the requirements in Section 9.23. that specifically apply to lumber joists do not apply to these components: for example, limits on spans and acceptable locations for notches and holes. However, requirements regarding the fastening of floor sheathing to floor joists still apply, and the use of wood I-joists does not affect the requirements for wall or roof framing.

Similarly, if steel floor joists are used in lieu of lumber joists, the requirements regarding wall or roof framing are not affected.

Conversely, Sentence 9.23.1.1.(1) precludes the installation of precast concrete floors on wood-frame walls since these are not “generally comprised of ... small repetitive structural members ... spaced not more than 600 mm o.c.”

Thus, the reference to “engineered components” in Sentence 9.23.1.1.(1) is intended to indicate that, where an engineered product is used in lieu of lumber for one part of the building, this does not preclude the application of the remainder of Section 9.23. to the structure, provided the limits to application with respect to cladding, sheathing or bracing, spacing of framing members, supported loads and maximum spans are respected.

**A-9.23.3.1.(2) Alternative Nail Sizes.** Where power nails or nails with smaller diameters than that required by Table 9.23.3.4. are used to connect framing, the following equations can be used to determine the required spacing or required number of nails.

The maximum spacing can be reduced using the following equation:

$$S_{\text{adj}} = S_{\text{table}} \cdot (D_{\text{red}}/D_{\text{table}})^2$$

where

- $S_{\text{adj}}$  = adjusted nail spacing  $\geq 20 \times$  nail diameter,
- $S_{\text{table}}$  = nail spacing required by Table 9.23.3.4.,
- $D_{\text{red}}$  = smaller nail diameter than that required by Table 9.23.3.1., and
- $D_{\text{table}}$  = nail diameter required by Table 9.23.3.1.

The number of nails can be increased using the following equation:

$$N_{\text{adj}} = N_{\text{table}} \cdot (D_{\text{table}}/D_{\text{red}})^2$$

where

- $N_{\text{adj}}$  = adjusted number of nails,
- $N_{\text{table}}$  = number of nails required by Table 9.23.3.4.,
- $D_{\text{table}}$  = nail diameter required by Table 9.23.3.1., and
- $D_{\text{red}}$  = smaller nail diameter than required by Table 9.23.3.1.

Note that nails should be spaced sufficiently far apart—preferably no less than 55 mm apart—to avoid splitting of framing lumber.



**A-9.23.3.1.(3) Standard for Screws.** The requirement that wood screws conform to ASME B18.6.1, “Wood Screws (Inch Series),” is not intended to preclude the use of Robertson head screws. The requirement is intended to specify the mechanical properties of the fastener, not to restrict the means of driving the fastener.

**A-9.23.3.3.(1) Prevention of Splitting.** Figure A-9.23.3.3.(1) illustrates the intent of the phrase “staggering the nails in the direction of the grain.”

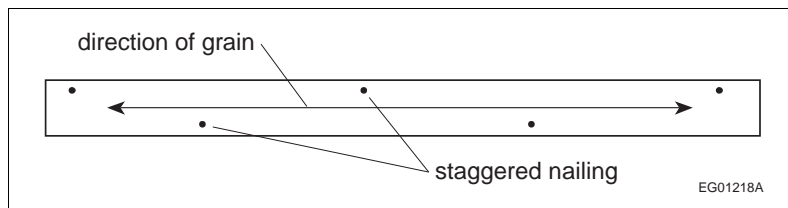


Figure A-9.23.3.3.(1)  
Staggered nailing

**A-Table 9.23.3.5.-B Alternative Nail Sizes.** Where power nails or nails having a different diameter than the diameters listed in CSA B111, “Wire Nails, Spikes and Staples,” are used to connect the edges of the wall sheathing to the wall framing of wood-sheathed braced wall panels, the maximum spacing should be as shown in Table A-Table 9.23.3.5.-B.

Table A-Table 9.23.3.5.-B  
Alternative Nail Diameters and Spacing

Element	Nail Diameter, mm <sup>(1)</sup>	Maximum Spacing of Nails Along Edges of Wall Sheathing, mm o.c.
Plywood, OSB or waferboard	2.19-2.52	75
	2.53-2.82	100
	2.83-3.09	125
	> 3.09	150

**Notes to Table A-Table 9.23.3.5.-B:**

(1) For alternative nail lengths of 63 mm or longer.

**A-9.23.4.2. Span Tables for Wood Joists, Rafters and Beams.** In these span tables the term “rafter” refers to a sloping wood framing member which supports the roof sheathing and encloses an attic space but does not support a ceiling. The term “roof joist” refers to a horizontal or sloping wood framing member that supports the roof sheathing and the ceiling finish but does not enclose an attic space.

Where rafters or roof joists are intended for use in a locality having a higher specified roof snow load than shown in the tables, the maximum member spacing may be calculated as the product of the member spacing and specified snow load shown in the span tables divided by the specified snow load for the locality being considered. The following examples show how this principle can be applied:

- (a) For a 3.5 kPa specified snow load, use spans for 2.5 kPa and 600 mm o.c. spacing but space members 400 mm o.c.
- (b) For a 4.0 kPa specified snow load, use spans for 2.0 kPa and 600 mm o.c. spacing but space members 300 mm o.c.

The maximum spans in the span tables are measured from the inside face or edge of support to the inside face or edge of support.

In the case of sloping roof framing members, the spans are expressed in terms of the horizontal distance between supports rather than the length of the sloping member. The snow loads are also expressed in terms of the horizontal projection of the sloping roof. Spans for odd size lumber may be estimated by straight line interpolation in the tables.

These span tables may be used where members support a uniform live load only. Where the members are required to be designed to support a concentrated load, they must be designed in conformance with Subsection 4.3.1.

Supported joist length in Span Tables 9.23.4.2.-H, 9.23.4.2.-I and 9.23.4.2.-J means half the sum of the joist spans on both sides of the beam. For supported joist lengths between those shown in the tables, straight line interpolation may be used in determining the maximum beam span.

Span Tables 9.23.4.2.-A to 9.23.12.3.-D cover only the most common configurations. Especially in the area of floors, a wide variety of other configurations is possible: glued subfloors, concrete toppings, machine stress rated lumber, etc. The Canadian Wood Council publishes "The Span Book," a compilation of span tables covering many of these alternative configurations. Although these tables have not been subject to the formal committee review process, the Canadian Wood Council generates, for the CCBFC, all of the Code's span tables for wood structural components; thus Code users can be confident that the alternative span tables in "The Span Book" are consistent with the span tables in the Code and with relevant Code requirements.

Spans for wood joists, rafters and beams which fall outside the scope of these tables, including those for U.S. species and individual species not marketed in the commercial species combinations described in the span tables, can be calculated in conformance with CSA O86, "Engineering Design in Wood."

**A-9.23.4.2.(2) Numerical Method to Establish Vibration-Controlled Spans for Wood-Frame Floors.** In addition to the normal strength and deflection analyses, the calculations on which the floor joist span tables are based include a method of ensuring that the spans are not so long that floor vibrations could lead to occupants perceiving the floors as too "bouncy" or "springy." Limiting deflection under the normal uniformly distributed loads to 1/360 of the span does not provide this assurance.

Normally, vibration analysis requires detailed dynamic modelling. However, the calculations for the span tables use the following simplified static analysis method of estimating vibration-acceptable spans:

- The span which will result in a 2 mm deflection of a single joist supporting a 1 kN concentrated midpoint load is calculated.
- This span is multiplied by a factor, K, to determine the "vibration-controlled" span for the entire floor system. If this span is less than the strength- or deflection-controlled span under uniformly distributed load, the vibration-controlled span becomes the maximum span.
- The K factor is determined from the following relationship:

$$\ln(K) = A - B \cdot \ln(S_i/S_{184}) + G$$

where

- A, B = constants, the values of which are determined from Tables A-9.23.4.2.(2)-A or A-9.23.4.2.(2)-B,
- G = constant, the value of which is determined from Table A-9.23.4.2.(2)-C,
- $S_i$  = span which results in a 2 mm deflection of the joist in question under a 1 kN concentrated midpoint load,
- $S_{184}$  = span which results in a 2 mm deflection of a 38 x 184 mm joist of same species and grade as the joist in question under a 1 kN concentrated midpoint load.

For a given joist species and grade, the value of K shall not be greater than  $K_3$ , the value which results in a vibration-controlled span of exactly 3 m. This means that for vibration-controlled spans 3 m or less, K always equals  $K_3$ , and for vibration-controlled spans greater than 3 m, K is as calculated.

Note that, for a sawn lumber joist, the ratio  $S_i/S_{184}$  is equivalent to its depth (mm) divided by 184.

Due to rounding differences, the method, as presented here, might produce results slightly different from those produced by the computer program used to generate the span tables.

**Table A-9.23.4.2.(2)-A**  
**Constants A and B for Calculating Vibration-Controlled Floor Joist Spans – General Cases**  
 Forming Part of Note A-9.23.4.2.(2)

Subfloor Thickness, mm	With Strapping <sup>(1)</sup>			With Bridging			With Strapping and Bridging		
	Joist Spacing, mm			Joist Spacing, mm			Joist Spacing, mm		
	300	400	600	300	400	600	300	400	600
Constant A									
15.5	0.30	0.25	0.20	0.37	0.31	0.25	0.42	0.35	0.28
19.0	0.36	0.30	0.24	0.45	0.37	0.30	0.50	0.42	0.33
Constant B									
	0.33			0.38			0.41		

**Notes to Table A-9.23.4.2.(2)-A:**

(1) Gypsum board attached directly to joists can be considered equivalent to strapping.

**Table A-9.23.4.2.(2)-B**  
**Constants A and B for Calculating Vibration-Controlled Floor Joist Spans – Special Cases**  
 Forming Part of Note A-9.23.4.2.(2)

Subfloor Thickness, mm	Joists with Ceiling Attached to Wood Furring <sup>(1)</sup>						Joists with Concrete Topping <sup>(2)</sup>		
	Without Bridging			With Bridging			With or Without Bridging		
	Joist Spacing, mm			Joist Spacing, mm			Joist Spacing, mm		
	300	400	600	300	400	600	300	400	600
Constant A									
15.5	0.39	0.33	0.24	0.49	0.44	0.38	0.58	0.51	0.41
19.0	0.42	0.36	0.27	0.51	0.46	0.40	0.62	0.56	0.47
Constant B									
	0.34			0.37			0.35		

**Notes to Table A-9.23.4.2.(2)-B:**

(1) Wood furring means 19 x 89 mm boards not more than 600 mm o.c., or 19 x 64 mm boards not more than 300 mm o.c. For all other cases, see Table A-9.23.4.2.(2)-A.

(2) 30 mm to 51 mm normal weight concrete (not less than 20 MPa) placed directly on the subflooring.

**Table A-9.23.4.2.(2)-C**  
**Constant G for Calculating Vibration-Controlled Floor Joist Spans**  
 Forming Part of Note A-9.23.4.2.(2)

Floor Description	Constant G
Floors with nailed <sup>(1)</sup> subfloor	0.00
Floor with nailed and field-glued <sup>(2)</sup> subfloor, vibration-controlled span greater than 3 m	0.10
Floor with nailed and field-glued <sup>(2)</sup> subfloor, vibration-controlled span 3 m or less	0.15

**Notes to Table A-9.23.4.2.(2)-C:**

(1) Common wire nails, spiral nails or wood screws can be considered equivalent for this purpose.

(2) Subfloor field-glued to floor joists with elastomeric adhesive complying with CAN/CGSB-71.26-M, "Adhesive for Field-Gluing Plywood to Lumber Framing for Floor Systems."

Additional background information on this method can be found in the following publications:

- Onysko, D.M. "Deflection Serviceability Criteria for Residential Floors." Project 43-10C-024. Forintek Canada Corp., Ottawa, Canada 1988.
- Onysko, D.M. "Performance and Acceptability of Wood Floors – Forintek Studies." Proceedings of Symposium/Workshop on Serviceability of Buildings, Ottawa, May 16-18, National Research Council of Canada, Ottawa, 1988.

**A-9.23.4.3.(1) Maximum Spans for Steel Beams Supporting Floors in Dwellings.** A beam may be considered to be laterally supported if wood joists bear on its top flange at intervals of 600 mm or less over its entire length, if all the load being applied to this beam is transmitted through the joists and if 19 mm by 38 mm wood strips in contact with the top flange are nailed on both sides of the beam to the bottom of the joists supported. Other additional methods of positive lateral support are acceptable.

For supported joist lengths intermediate between those in the table, straight line interpolation may be used in determining the maximum beam span.

**A-Table 9.23.4.3. Spans for Steel Beams.** The spans provided in Table 9.23.4.3. reflect a balance of engineering and acceptable proven performance. The spans have been calculated based on the following assumptions:

- simply supported beam spans
- laterally supported top flange
- yield strength 350 MPa
- deflection limit  $L/360$
- live load: first floor = 1.9 kPa; second floor = 1.4 kPa
- dead load: 1.5 kPa (0.5 kPa floor + 1.0 kPa partition)

The calculation used to establish the specified maximum beam spans also applies a revised live load reduction factor to account for the lower probability of a full live load being applied over the supported area in Part 9 buildings.

**A-9.23.4.4. Concrete Topping.** Vibration-controlled spans given in Span Table 9.23.4.2.-B for concrete topping are based on a partial composite action between the concrete, subflooring and joists. Normal weight concrete having a compressive strength of not less than 20 MPa, placed directly on the subflooring, provides extra stiffness and results in increased capacity. The use of a bond breaker between the topping and the subflooring, or the use of lightweight concrete topping limits the composite effects.

Where either a bond breaker or lightweight topping is used, Span Table 9.23.4.2.-A may be used but the additional dead load imposed by the concrete must be considered. The addition of 51 mm of concrete topping can impose an added load of 0.8 to 1.2 kPa, depending on the density of the concrete.

Example

Assumptions:

- basic dead load	= 0.5 kPa
- topping dead load	= 0.8 kPa
- total dead load	= 1.3 kPa
- live load	= 1.9 kPa
- vibration limit	per Note A-9.23.4.2.(2)
- deflection limit	= $1/360$
- ceiling attached directly to joists, no bridging	

The spacing of joists in the span tables can be conservatively adjusted to allow for the increased load by using the spans in Span Table 9.23.4.2.-A for 600 mm spacing, but spacing the joists 400 mm apart. Similarly, floor beam span tables can be adjusted by using 4.8 m supported length spans for cases where the supported length equals 3.6 m.

A-9.23.8.3. Joint Location in Built-Up Beams.

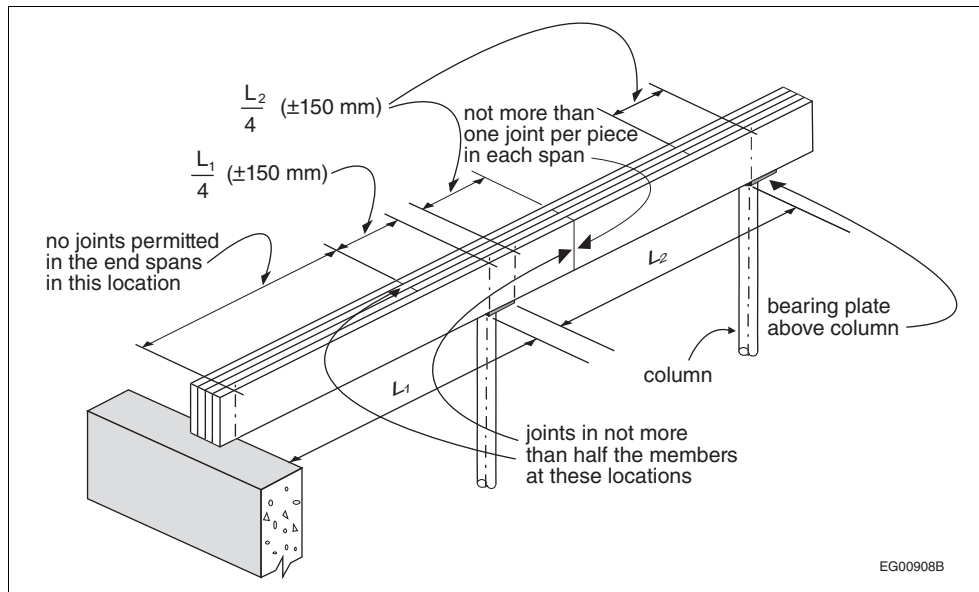
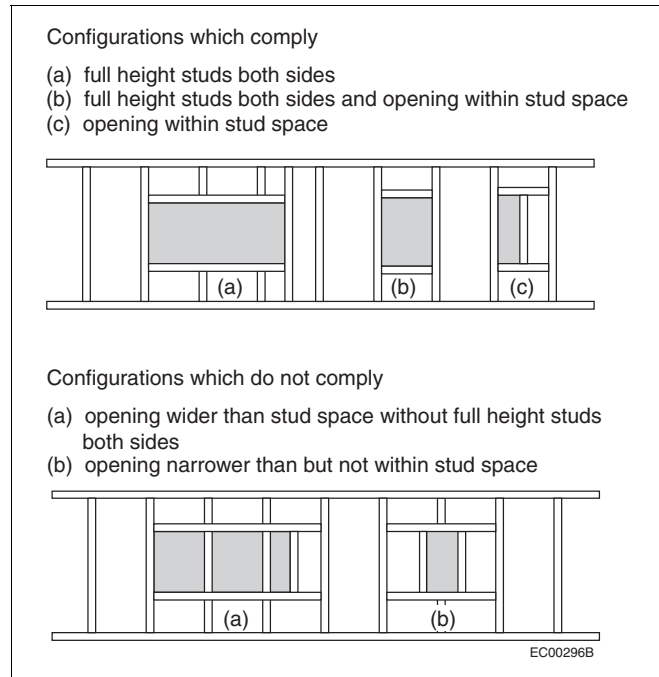


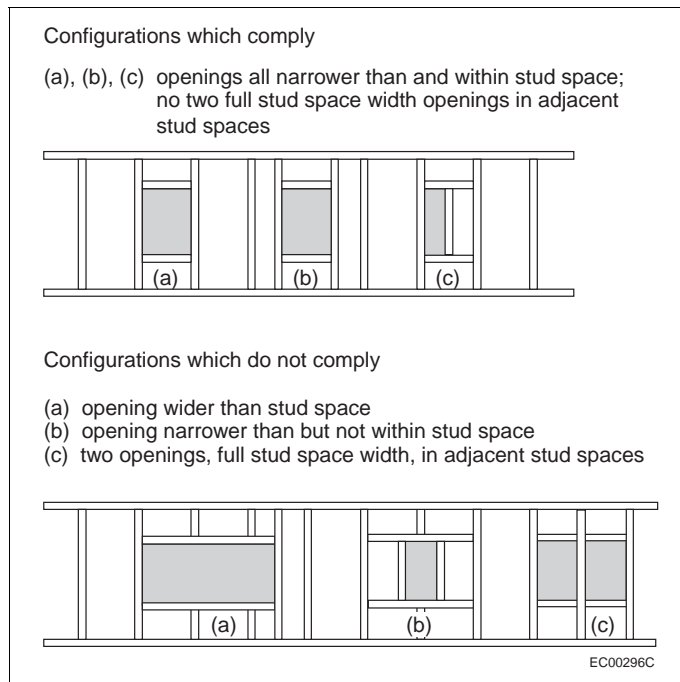
Figure A-9.23.8.3.  
Joint location in built-up beams

**A-9.23.10.4.(1) Fingerjoined Lumber.** NLGA 2014, “Standard Grading Rules for Canadian Lumber,” referenced in Article 9.3.2.1., refers to two special product standards, SPS-1, “Fingerjoined Structural Lumber,” and SPS-3, “Fingerjoined “Vertical Stud Use Only” Lumber,” produced by NLGA. Material identified as conforming to these standards is considered to meet the requirements in this Sentence for joining with a structural adhesive. Lumber fingerjoined in accordance with SPS-3 should be used as a vertical end-loaded member in compression only, where sustained bending or tension-loading conditions are not present, and where the moisture content of the wood will not exceed 19%. Fingerjoined lumber may not be visually regraded or remanufactured into a higher stress grade even if the quality of the lumber containing fingerjoints would otherwise warrant such regrading.

**A-9.23.10.6.(3) Single Studs at Sides of Openings.**



**Figure A-9.23.10.6.(3)-A**  
**Single studs at openings in non-loadbearing interior walls**



**Figure A-9.23.10.6.(3)-B**  
**Single studs at openings in all other walls**

**A-9.23.13. Bracing for Resistance to Lateral Loads.** Subsection 9.23.14. along with Articles 9.23.3.4., 9.23.3.5., 9.23.6.1., 9.23.9.8., 9.23.15.5., 9.29.5.8., 9.29.5.9., 9.29.6.3. and 9.29.9.3. provide explicit requirements to address resistance to wind and earthquake loads in higher wind and earthquake regions of Canada.

**Table A-9.23.13.**  
**Application of Lateral Load Requirements**

Applicable Requirements	Wind (HWP)			Earthquake $S_a(0.2)$				
	Low to Moderate	High	Extreme	Low to Moderate	High	Extreme	High	Extreme
	$HWP < 0.80$ kPa	$0.80 \leq HWP < 1.20$ kPa	$HWP \geq 1.20$ kPa	$S_a(0.2) \leq 0.70$	$0.70 < S_a(0.2) \leq 1.8$	$S_a(0.2) > 1.8$	$0.70 < S_a(0.2) \leq 1.8$	$S_a(0.2) > 1.8$
	All Construction			All Construction	Heavy Construction <sup>(1)</sup>		Light Construction	
Design requirements in 9.23.16.2., 9.27., 9.29.	X <sup>(2)</sup>	N/A	N/A	X	N/A	N/A	N/A	N/A
Bracing requirements in 9.23.13.	X	X	N/A	X	X <sup>(3)(4)</sup>	N/A	X <sup>(4)(5)</sup>	N/A
Part 4 or CWC Guide	X	X	X	X	X	X	X	X
X = requirements are applicable								

**Notes to Table A-9.23.13.:**

- (1) See Note A-9.23.13.2.(1)(a)(i).
- (2) Requirements apply to exterior walls only.
- (3) Requirements apply where lowest exterior frame walls support not more than one floor.
- (4) All constructions may include the support of a roof in addition to the stated number of floors.
- (5) Requirements apply where lowest exterior frame walls support not more than two floors.

**A-9.23.13.1.**

**Bracing to Resist Lateral Loads in Low Load Locations**

Of the 679 locations identified in Appendix C, 614 are locations where the seismic spectral response acceleration,  $S_a(0.2)$ , is less than or equal to 0.70 and the 1-in-50 hourly wind pressure is less than 0.80 kPa. For buildings in these locations, Sentence 9.23.13.1.(2) requires only that exterior walls be braced using the acceptable materials and fastening specified. There are no spacing or dimension requirements for braced wall panels in these buildings.

**Structural Design for Lateral Wind and Earthquake Loads**

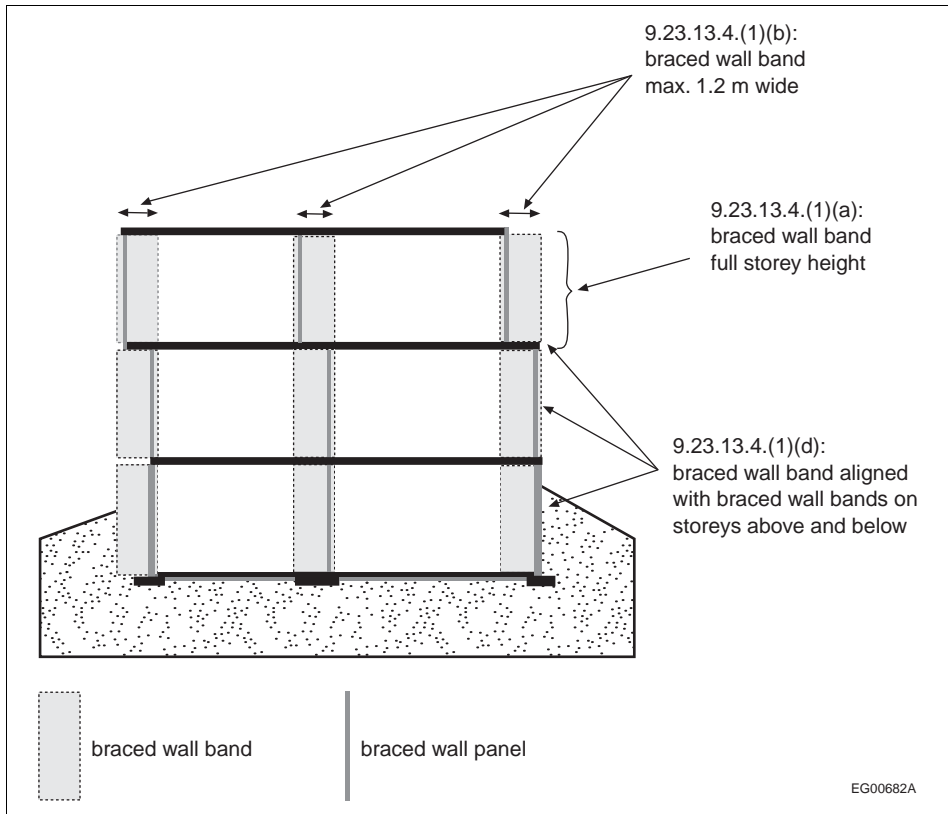
In cases where lateral load design is required, CWC 2014, "Engineering Guide for Wood Frame Construction," provides acceptable engineering solutions as an alternative to Part 4. The CWC Guide also contains alternative solutions and provides information on the applicability of the Part 9 prescriptive structural requirements to further assist designers and building officials to identify the appropriate design approach.

**A-9.23.13.2.(1)(a)(i) Heavy Construction.** "Heavy construction" refers to buildings with tile roofs, stucco walls or floors with concrete topping, or that are clad with directly-applied heavyweight materials.

Heavyweight construction assemblies increase the lateral load on the structure during an earthquake. Assemblies should be considered as heavyweight where their average dead weight is as follows (an additional partition weight of 0.5 kPa per floor is assumed):

- floor: 0.5 to 1.5 kPa
- roof: 0.5 to 1.0 kPa
- wall (vertical area): 0.32 to 1.2 kPa

**A-9.23.13.4. Braced Wall Bands.** Article 9.23.13.4. specifies the required characteristics of braced wall bands and their position in the building. Figures A-9.23.13.4.-A, A-9.23.13.4.-B and A-9.23.13.4.-C illustrate these requirements.



**Figure A-9.23.13.4-A**  
**Braced wall bands in an example building section [Clauses 9.23.13.4.(1)(a), (b) and (d)]**



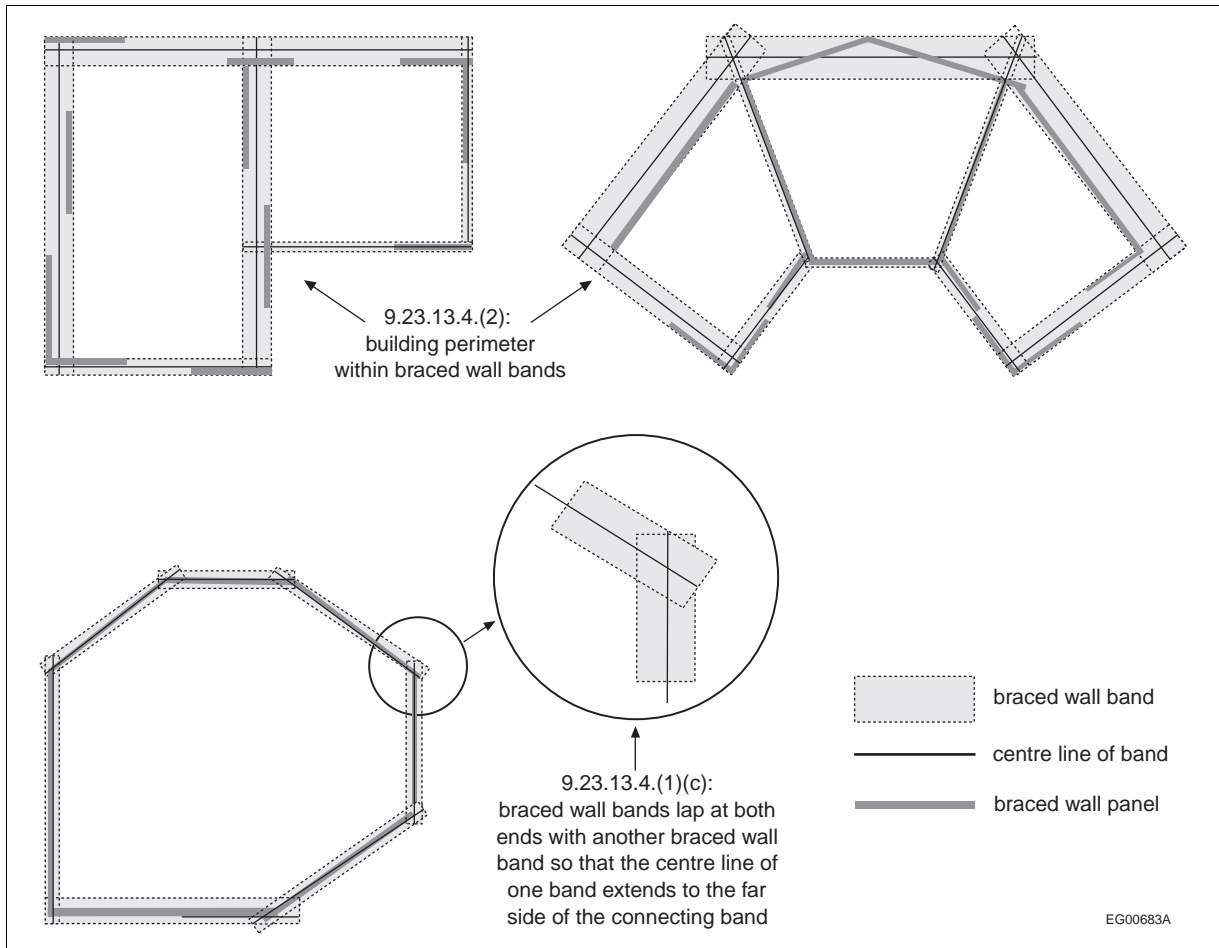


Figure A-9.23.13.4-B  
Lapping bands and building perimeter within braced wall bands [Clause 9.23.13.4.(1)(c) and Sentence 9.23.13.4.(2)]

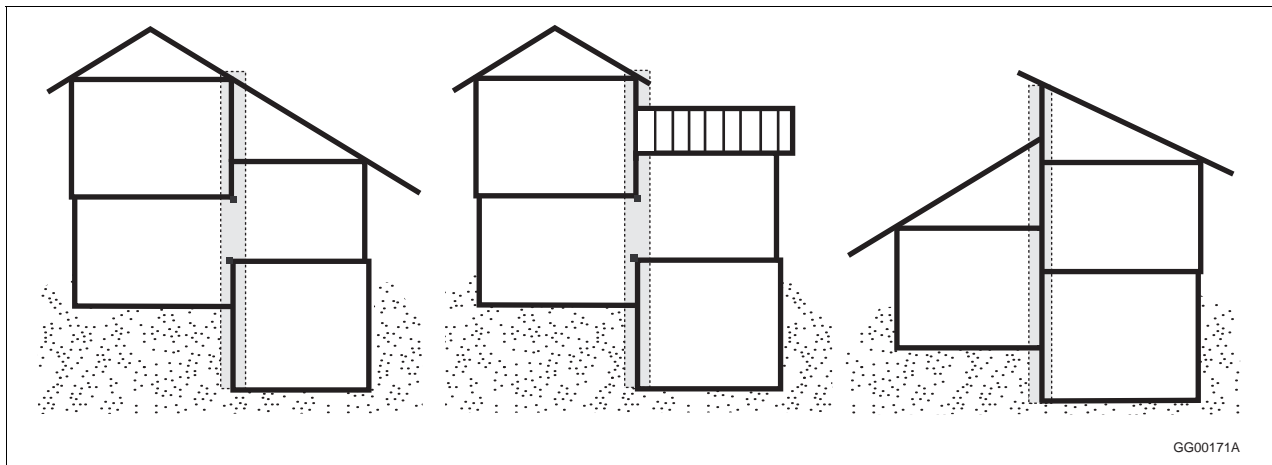
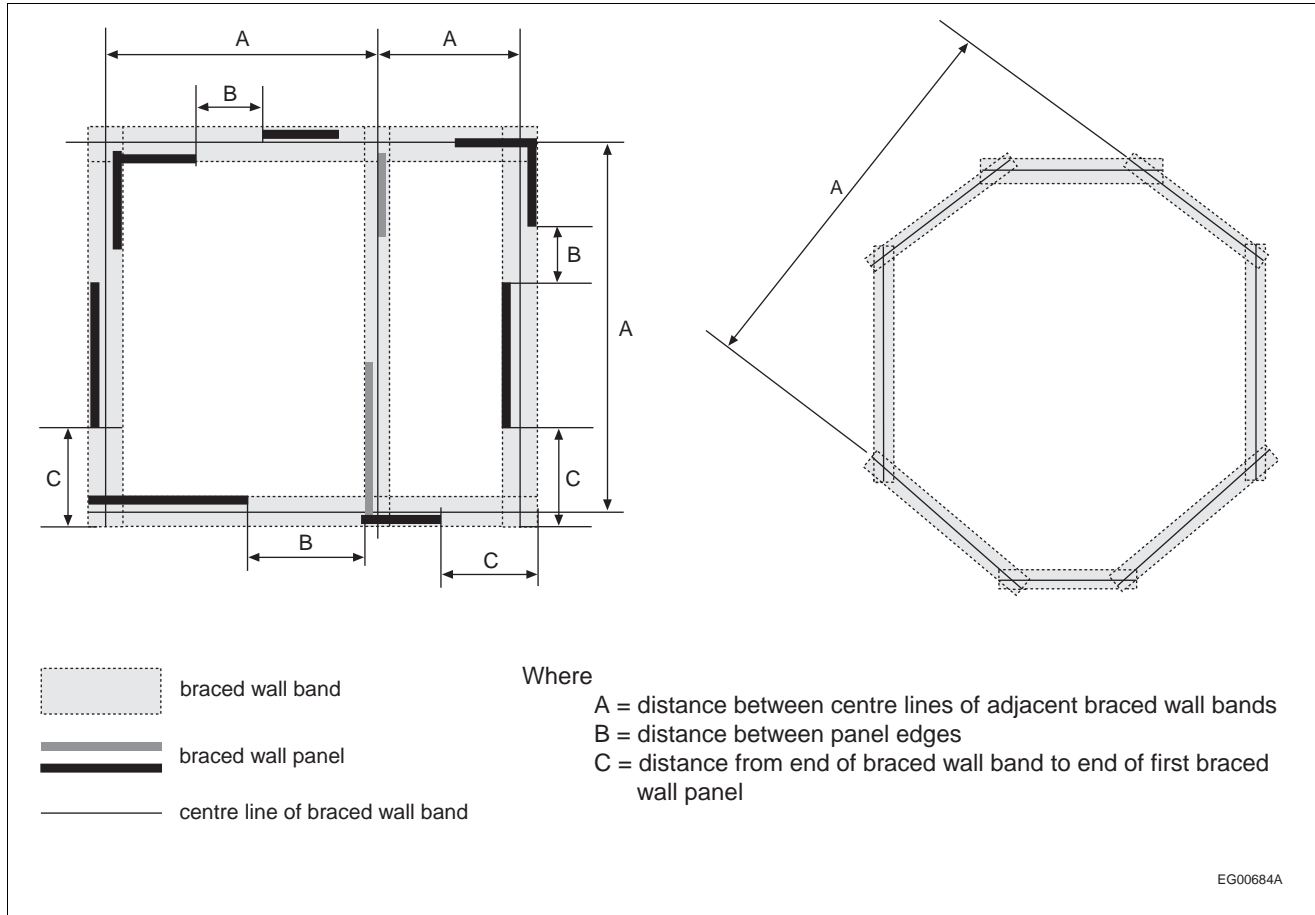


Figure A-9.23.13.4-C  
Braced wall band at change in floor level in split-level buildings [Sentence 9.23.13.4.(3)]

**A-Table 9.23.13.5. Spacing of Braced Wall Bands and Braced Wall Panels.** Identifying adjacent braced wall bands and determining the spacing of braced wall panels and braced wall bands is not complicated where the building plan is orthogonal or there are parallel braced wall bands: the adjacent braced wall band is the nearest parallel band. Figure Table A-9.23.13.5.-A illustrates spacing.



**Figure Table A-9.23.13.5.-A**  
**Spacing of parallel braced wall bands and spacing of braced wall panels**

**Identifying and Spacing Adjacent Non-Parallel Braced Wall Bands**

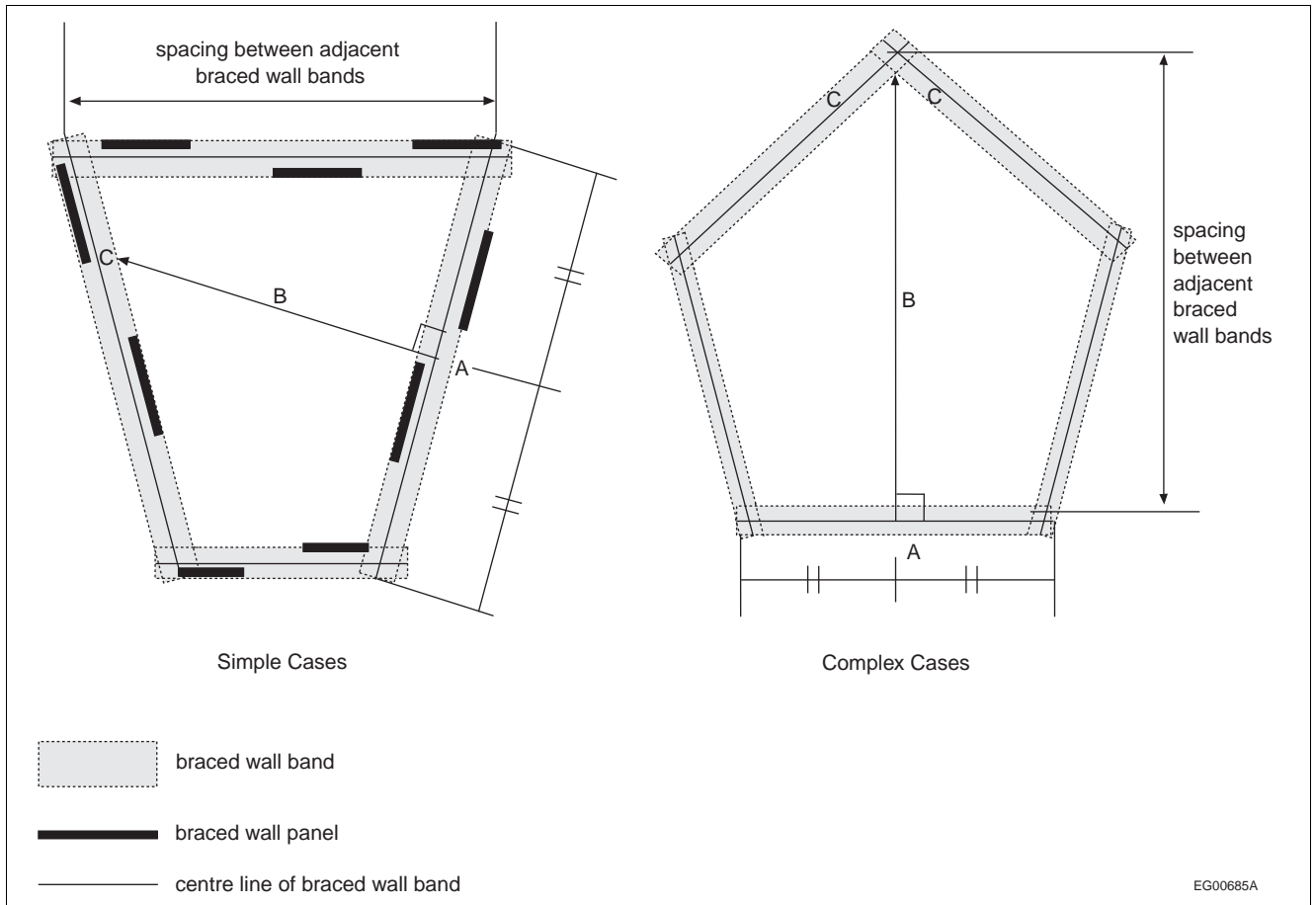
Identifying the adjacent braced wall band and the spacing between braced wall bands is more complicated where the building plan is not orthogonal.

Where the plan is triangular, all braced wall bands intersect with the subject braced wall band. The prescriptive requirements in Part 9 do not apply to these cases and the building must be designed according to Part 4 with respect to lateral load resistance.

Where the braced wall bands are not parallel, the adjacent band is identified as follows using Figure Table A-9.23.13.5.-B as an example:

1. Determine the mid-point of the centre line of the subject braced wall band (A);
2. Project a perpendicular line from this mid-point (B);
3. The first braced wall band encountered is the adjacent braced wall band (C);
4. Where the projected line encounters an intersection point between two braced wall bands, either wall band may be identified as the adjacent braced wall band (complex cases).

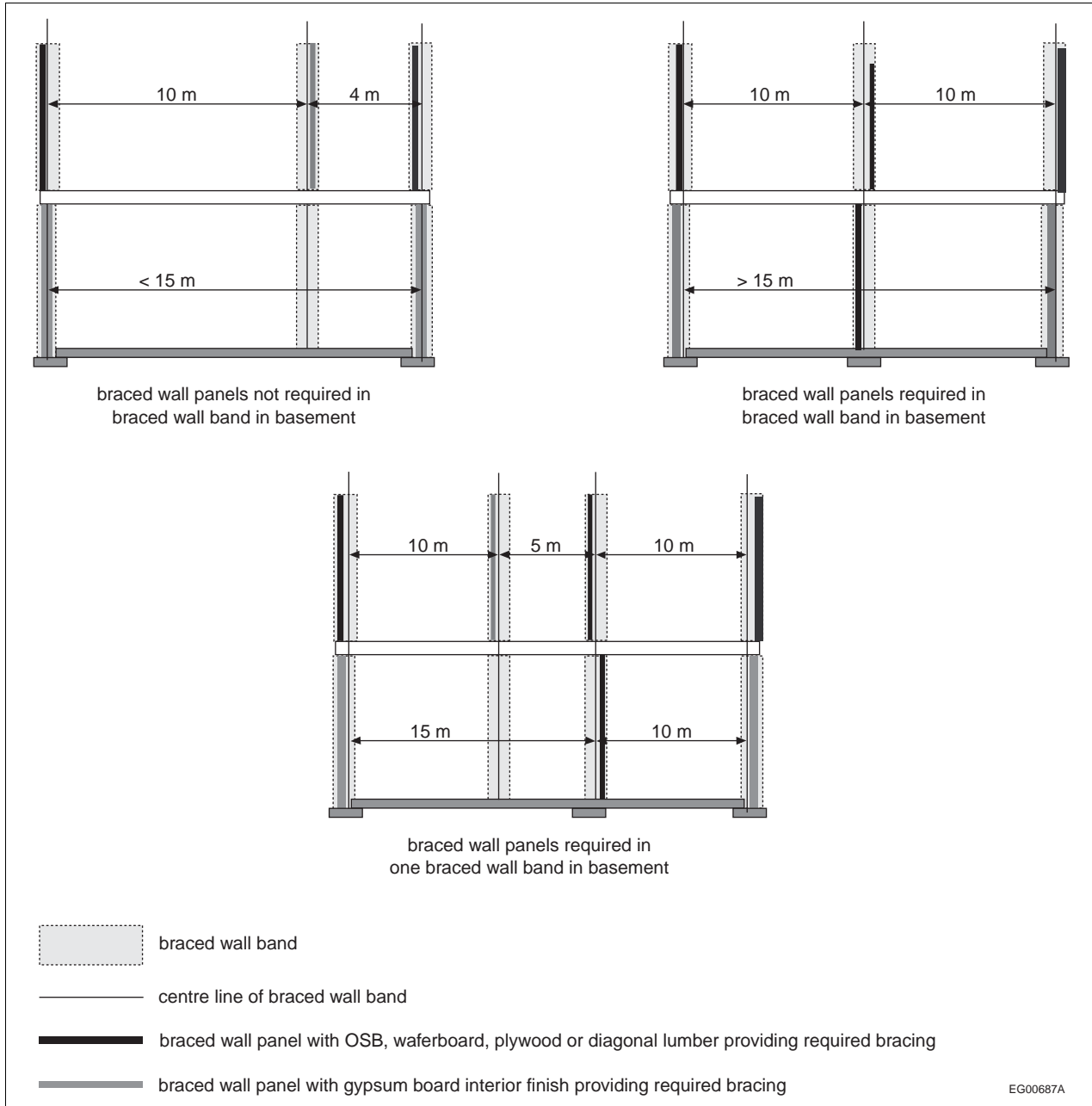
The spacing of non-parallel braced wall bands is measured as the greatest distance between the centre lines of the bands.



EG00685A

**Figure Table A-9.23.13.5.-B**  
**Identification and spacing of adjacent non-parallel braced wall bands**

**A-9.23.13.5.(2) Perimeter Foundation Walls.** Where the perimeter foundation walls in basements and crawl spaces extend from the footings to the underside of the supported floor, these walls perform the same function as braced wall bands with braced wall panels. All other braced wall bands in the basement or crawl space that align with bands with a wood-based bracing material on the upper floors need to be constructed with braced wall panels, which must be made of a wood-based bracing material, masonry or concrete. See Figure A-9.23.13.5.(2).



**Figure A-9.23.13.5.(2)**

**Braced wall bands in basements or crawl spaces with optional and required braced wall panels**

A-9.23.13.5.(3) Attachment of a Porch Roof to Exterior Wall Framing.

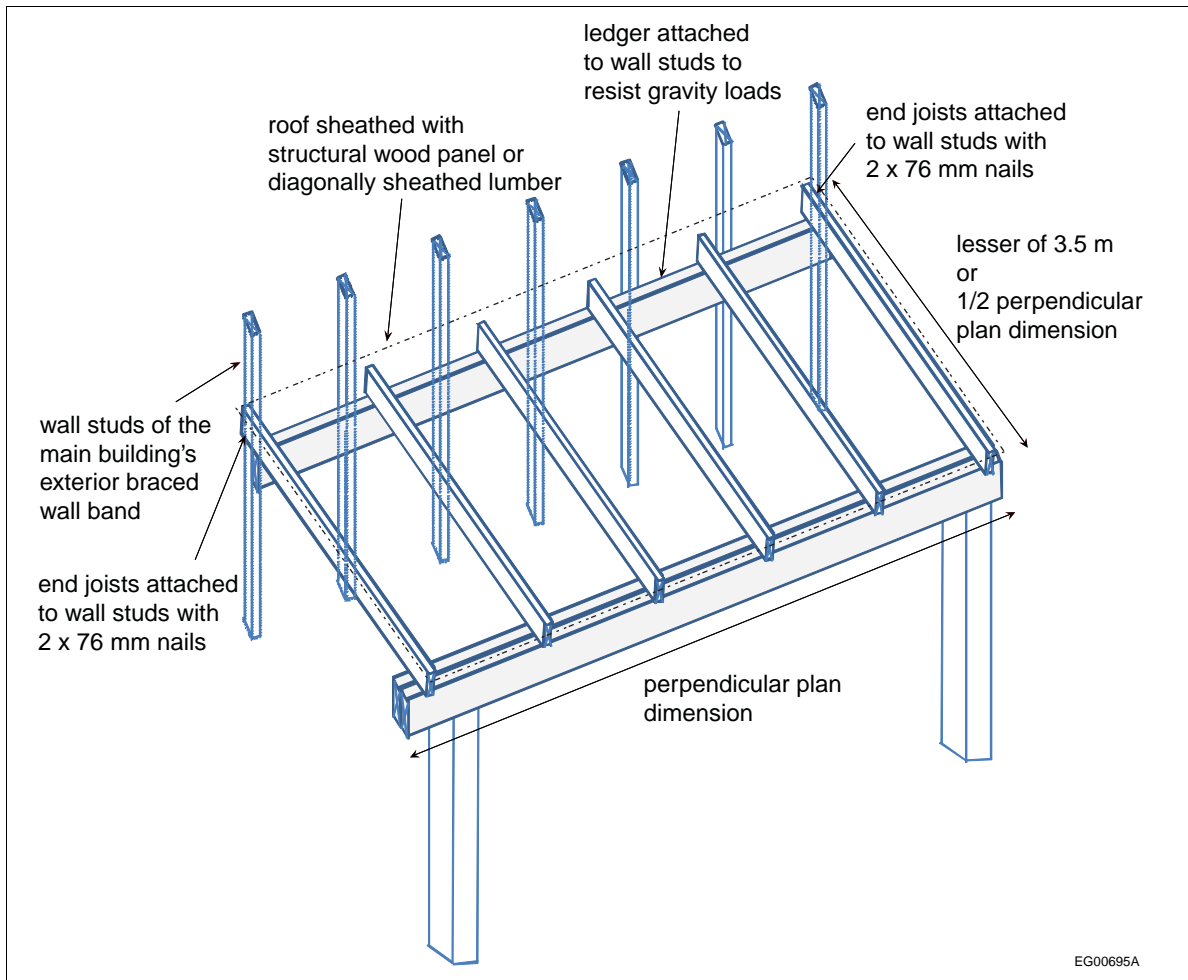
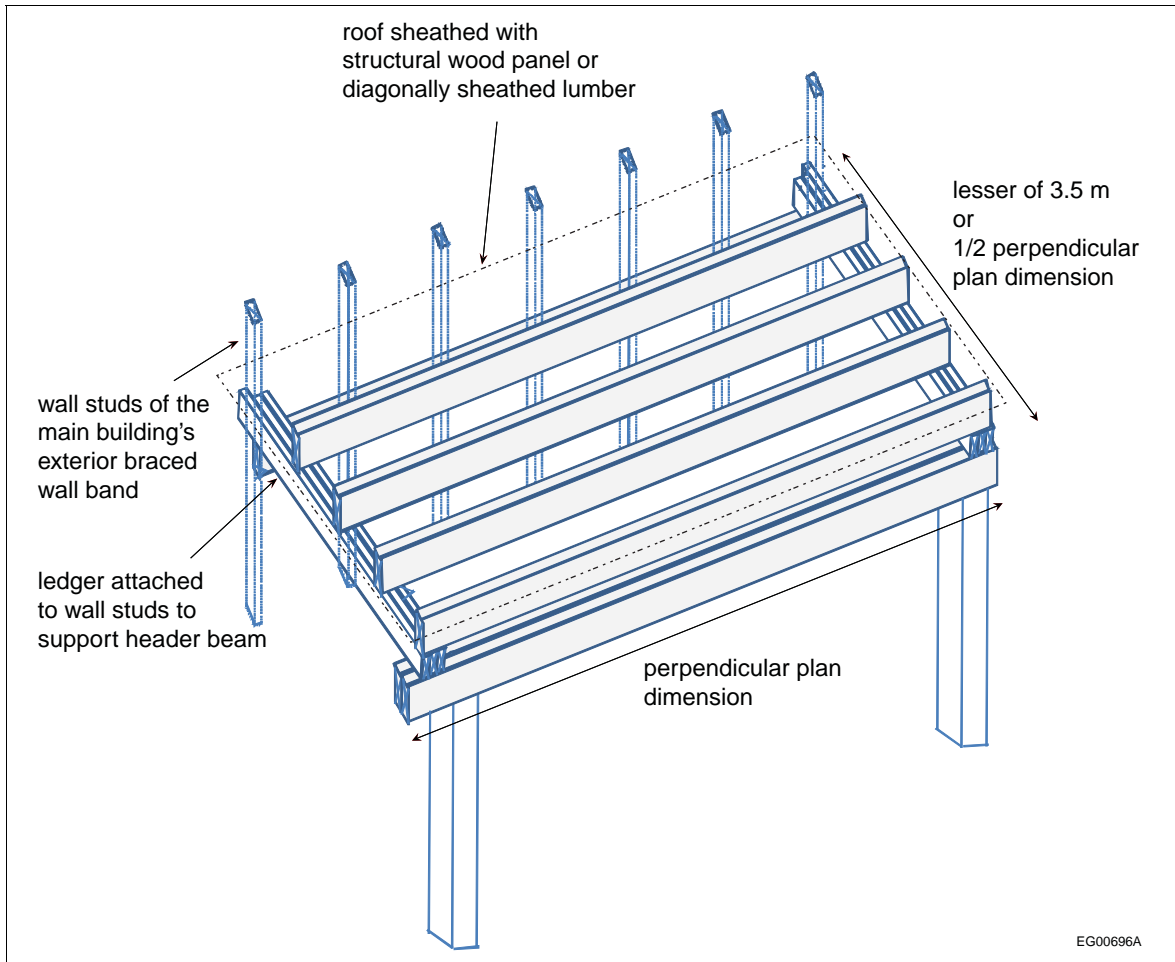


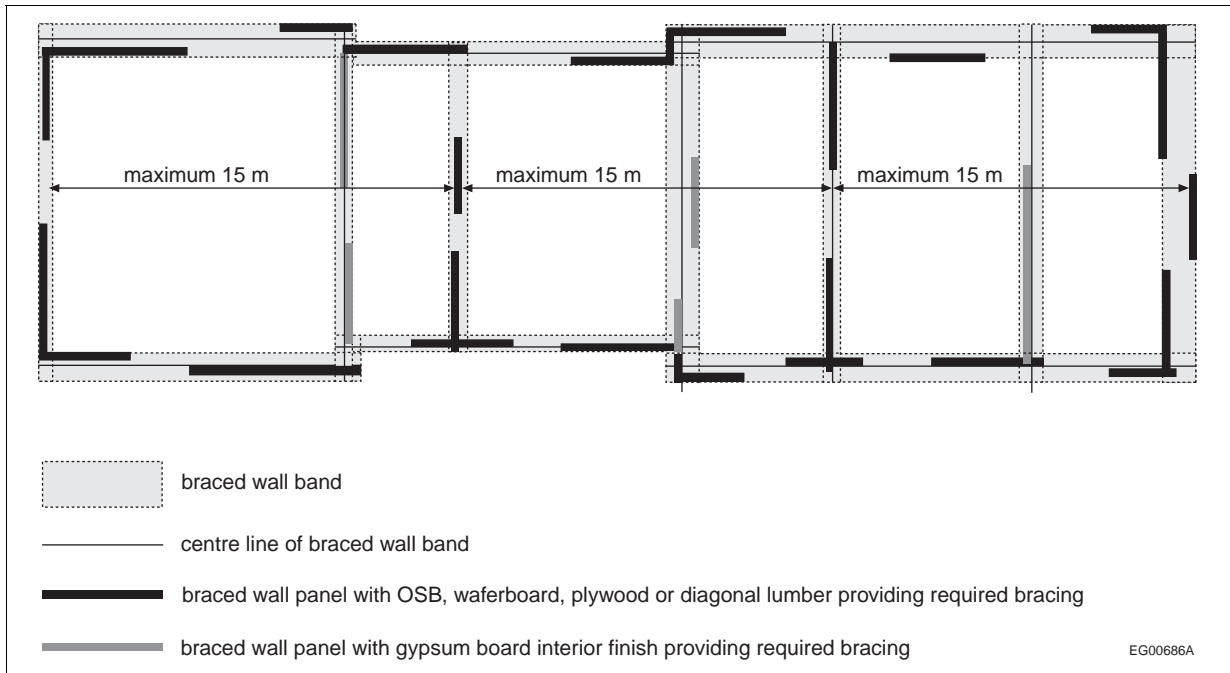
Figure A-9.23.13.5.(3)-A  
Framing perpendicular to plane of wall (balloon construction)

EG00695A



**Figure A-9.23.13.5.(3)-B**  
**Framing parallel to plane of wall**

**A-9.23.13.6.(5) and (6) Use of Gypsum Board Interior Finish to Provide Required Bracing.** Braced wall panels constructed with gypsum board provide less resistance to lateral loads than panels constructed with OSB, waferboard, plywood or diagonal lumber; Sentence (5) therefore limits the use of gypsum board to interior walls. Sentence (6) further limits its use to provide the required lateral resistance by requiring that walls not more than 15 m apart be constructed with panels made of wood or wood-based sheathing. See Figure A-9.23.13.6.(5) and (6).



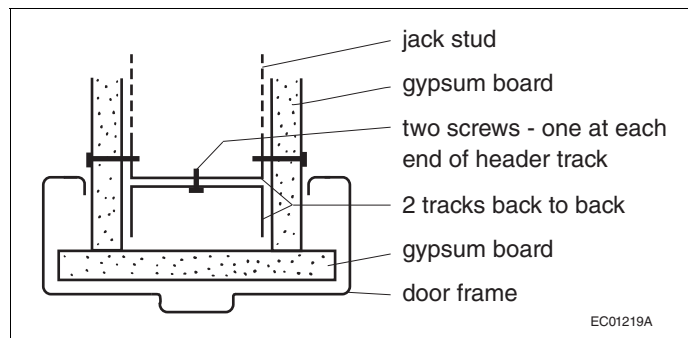
**Figure A-9.23.13.6.(5) and (6)**  
**Braced wall panels constructed of wood-based material**

**A-9.23.14.11.(2) Wood Roof Truss Connections.** Sentence 9.23.14.11.(2) requires that the connections used in wood roof trusses be designed in conformance with Subsection 4.3.1. and Sentence 2.2.1.2.(1) of Division C, which applies to all of Part 4, requires that the designer be a professional engineer or architect skilled in the work concerned. This has the effect of requiring that the trusses themselves be designed by professional engineers or architects. Although this is a departure from the usual practice in Part 9, it is appropriate, since wood roof trusses are complex structures which depend on a number of components (chord members, web members, cross-bracing, connectors) working together to function safely. This complexity precludes the standardization of truss design into tables comprehensive enough to satisfy the variety of roof designs required by the housing industry.

**A-9.23.15.2.(4) Water Absorption Test.** A method for determining water absorption is described in ASTM D 1037, "Evaluating Properties of Wood-Base Fiber and Particle Panel Materials." The treatment to reduce water absorption may be considered to be acceptable if a 300 mm x 300 mm sample when treated on all sides and edges does not increase in weight by more than 6% when tested in the horizontal position.

**A-9.23.15.4.(2) OSB.** CSA O437.0, "OSB and Waferboard," requires that Type O (aligned or oriented) panels be marked to show the grade and the direction of face alignment.

**A-9.24.3.2.(3) Framing Above Doors in Steel Stud Fire Separations.**



**Figure A-9.24.3.2.(3)**  
**Steel stud header detail**

**A-9.25.2.2.(2) Flame-Spread Ratings of Insulating Materials.** Part 9 has no requirements for flame-spread ratings of insulation materials since these are seldom exposed in parts of buildings where fires are likely to start. Certain of the insulating material standards referenced in Sentence 9.25.2.2.(1) do include flame-spread rating criteria. These are included either because the industry producing the product wishes to demonstrate that their product does not constitute a fire hazard or because the product is regulated by authorities other than building authorities (e.g., “Hazardous Products Act”). However, the Code cannot apply such requirements to some materials and not to others. Hence, these flame-spread rating requirements are excepted in referencing these standards.

**A-9.25.2.3.(3) Position of Insulation.** For thermal insulation to be effective, it must not be short-circuited by convective airflow through or around the material. If low-density fibrous insulation is installed with an air space on both sides of the insulation, the temperature differential between the warm and cold sides will drive convective airflow around the insulation. If foamed plastic insulation is spot-adhered to a backing wall or adhered in a grid pattern to an air-permeable substrate, and is not sealed at the joints and around the perimeter, air spaces between the insulation and the substrate will interconnect with spaces behind the cladding. Any temperature or air pressure differential across the insulation will again lead to short circuiting of the insulation by airflow. Thermal insulation must therefore be installed in full and continuous contact with the air barrier or another continuous component with low air permeance. (See Note A-9.25.5.1.(1) for examples of low-air-permeance materials.)

**A-9.25.2.4.(3) Loose-Fill Insulation in Existing Wood-Frame Walls.** The addition of insulation into exterior walls of existing wood-frame buildings increases the likelihood of damage to framing and cladding components as a result of moisture accumulation. Many older homes were constructed with little or no regard for protection from vapour transmission or air leakage from the interior. Adding thermal insulation will substantially reduce the temperature of the siding or sheathing in winter months, possibly leading to condensation of moisture at this location.

Defects in exterior cladding, flashing and caulking could result in rain entering the wall cavity. This moisture, if retained by the added insulation, could initiate the process of decay.

Steps should be taken therefore, to minimize these effects prior to the retrofit of any insulation. Any openings in walls that could permit leakage of interior heated air into the wall cavity should be sealed. The inside surface should be coated with a low-permeability paint to reduce moisture transfer by diffusion. Finally, the exterior siding, flashing and caulking should be checked and repaired if necessary to prevent rain penetration.

**A-9.25.2.4.(5) Loose-Fill Insulation in Masonry Walls.** Typical masonry cavity wall construction techniques do not lend themselves to the prevention of entry of rainwater into the wall space. For this reason, loose-fill insulation used in such space must be of the water repellent type. A test for water-repellency of loose-fill insulation suitable for installation in masonry cavity walls can be found in ASTM C 516, “Vermiculite Loose Fill Thermal Insulation.”

**A-9.25.3.1.(1) Air Barrier Systems for Control of Condensation.** The majority of moisture problems resulting from condensation of water vapour in walls and ceiling/attic spaces are caused by the leakage of moist interior heated air into these spaces rather than by the diffusion of water vapour through the building envelope.

Protection against such air leakage must be provided by a system of air-impermeable materials joined with leak-free joints. Generally, air leakage protection can be provided by the use of air-impermeable sheet materials, such as gypsum board or polyethylene of sufficient thickness, when installed with appropriate structural support. However, the integrity of the airtight elements in the air barrier system can be compromised at the joints and here special care must be taken in design and construction to achieve an effective air barrier system.

Although Section 9.25. refers separately to vapour barriers and airtight elements in the air barrier system, these functions in a wall or ceiling assembly of conventional wood-frame construction are often combined as a single membrane that acts as a barrier against moisture diffusion and the movement of interior air into insulated wall or roof cavities. Openings cut through this membrane, such as for electrical boxes, provide opportunities for air leakage into concealed spaces, and special measures must be taken to make such openings as airtight as possible. Attention must also be paid to less obvious leakage paths, such as holes for electric wiring, plumbing installations, wall-ceiling and wall-floor intersections, and gaps created by shrinkage of framing members.

In any case, air leakage must be controlled to a level where the occurrence of condensation will be sufficiently rare, or the quantities accumulated sufficiently small, and drying sufficiently rapid, to avoid material deterioration and the growth of mould and fungi.



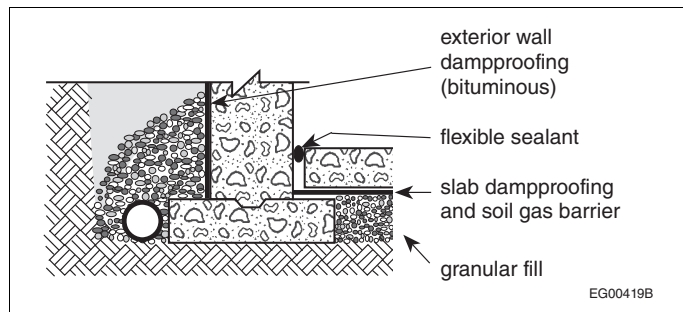
Generally the location in a building assembly of the airtight element of the air barrier system is not critical; it can restrict air leakage whether it is located near the outer surface of the assembly, near the inner surface or at some intermediate location. However, if a material chosen to act as an airtight element in the air barrier system also has the characteristics of a vapour barrier (i.e., low permeability to water vapour), its location must be chosen more carefully in order to avoid moisture problems. (See Notes A-9.25.5.1.(1) and A-9.25.4.3.(2).)

In some constructions, an airtight element in the air barrier system is the interior finish, such as gypsum board, which is sealed to framing members and adjacent components by gaskets, caulking, tape or other methods to complete the air barrier system. In such cases, special care in sealing joints in a separate vapour barrier is not critical. This approach often uses no separate vapour barrier but relies on appropriate paint coatings to give the interior finish sufficient resistance to water vapour diffusion that it can provide the required vapour diffusion protection.

The wording in Section 9.25. allows for such innovative techniques, as well as the more traditional approach of using a continuous sheet, such as polyethylene, to act as an “air/vapour barrier.”

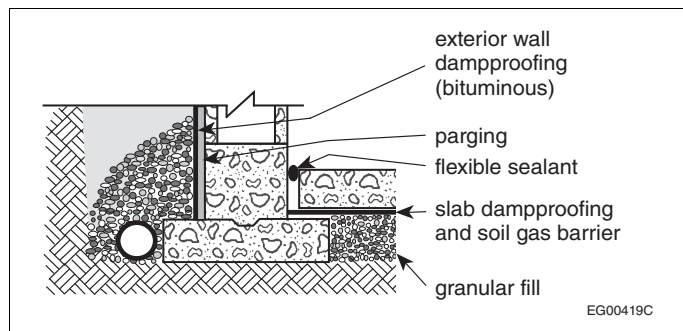
Further information can be found in CBD 231, “Moisture Problems in Houses” (Canadian Building Digest 231), by A.T. Hansen, which is available from NRC.

**A-9.25.3.4. and 9.25.3.6. Air Leakage and Soil Gas Control in Floors-on-ground.** The requirement in Sentence 9.25.3.3.(6) regarding the sealing of penetrations of the air barrier also applies to hollow metal and masonry columns penetrating the floor slab. Not only the perimeters but also the centres of such columns must be sealed or blocked.



**Figure A-9.25.3.4. and 9.25.3.6.-A**  
**Dampproofing and soil gas control at foundation wall/floor junctions with solid walls**

The requirement in Sentence 9.25.3.6.(6) regarding drainage openings in slabs can be satisfied with any of a number of proprietary devices that prevent the entry of radon and other soil gases through floor drains. Some types of floor drains incorporate a trap that is connected to a nearby tap so that the trap is filled every time the tap is used. This is intended to prevent the entry of sewer gas but would be equally effective against the entry of radon and other soil gases.



**Figure A-9.25.3.4. and 9.25.3.6.-B**  
**Dampproofing and soil gas control at foundation wall/floor junctions with hollow walls**

**A-9.25.3.6.(2) and (3) Polyethylene Air Barriers under Floors-on-Ground.** Floors-on-ground separating conditioned space from the ground must be constructed to reduce the potential for the entry of air, radon or other soil gases. In most cases, this will be accomplished by placing 0.15 mm polyethylene under the floor.

Finishing a concrete slab placed directly on polyethylene can, in many cases, cause problems for the inexperienced finisher. A rule of finishing, whether concrete is placed on polyethylene or not, is to never finish or “work” the surface of the slab while bleed water is present or before all the bleed water has risen to the surface and evaporated. If finishing operations are performed before all the bleed water has risen and evaporated, surface defects such as blisters, crazing, scaling and dusting can result. In the case of slabs placed directly on polyethylene, the amount of bleed water that may rise to the surface and the time required for it to do so are increased compared to a slab placed on a compacted granular base. Because of the polyethylene, the excess water in the mix from the bottom portion of the slab cannot bleed downward and out of the slab and be absorbed into the granular material below. Therefore, all bleed water, including that from the bottom of the slab, must now rise through the slab to the surface. Quite often in such cases, finishing operations are begun too soon and surface defects result.

One solution that is often suggested is to place a layer of sand between the polyethylene and the concrete. However, this is not an acceptable solution for the following reason: it is unlikely that the polyethylene will survive the slab pouring process entirely intact. Nevertheless, the polyethylene will still be effective in retarding the flow of soil gas if it is in intimate contact with the concrete; soil gas will only be able to penetrate where a break in the polyethylene coincides with a crack in the concrete. The majority of concrete cracks will probably be underlain by intact polyethylene. On the other hand, if there is an intervening layer of a porous medium, such as sand, soil gas will be able to travel laterally from a break in the polyethylene to the nearest crack in the concrete and the total system will be much less resistant to soil gas penetration.

To reduce and/or control the cracking of concrete slabs, it is necessary to understand the nature and causes of volume changes of concrete and in particular those relating to drying shrinkage. The total amount of water in a mix is by far the largest contributor to the amount of drying shrinkage and resulting potential cracking that may be expected from a given concrete. The less total amount of water in the mix, the less volume change (due to evaporation of water), which means the less drying shrinkage that will occur. To lessen the volume change and potential cracking due to drying shrinkage, a mix with the lowest total amount of water that is practicable should always be used. To lower the water content of a mix, superplasticizers are often added to provide the needed workability of the concrete during the placing operation. Concretes with a high water-to-cementing-materials ratio usually have high water content mixes. They should be avoided to minimize drying shrinkage and cracking of the slab. The water-to-cementing-materials ratio for slabs-on-ground should be no higher than 0.55.

**A-9.25.4.2.(2) Normal Conditions.** The requirement for a 60 ng/Pa·s·m<sup>2</sup> vapour barrier stated in Sentence 9.25.4.2.(1) is based on the assumption that the building assembly is subjected to conditions that are considered normal for typical residential occupancies, and business and personal services occupancies.

However, where the intended use of an occupancy includes facilities or activities that will generate a substantial amount of moisture indoors during the heating season, such as swimming pools, greenhouses, laundromats, and any continuous operation of hot tubs and saunas, the building envelope assemblies would have to demonstrate acceptable performance levels in accordance with the requirements in Part 5.

**A-9.25.4.3.(2) Location of Vapour Barriers.** Assemblies in which the vapour barrier is located partway through the insulation meet the intent of this Article provided it can be shown that the temperature of the vapour barrier will not fall below the dew point of the heated interior air.

#### **A-9.25.5.1. Location of Low Permeance Materials.**

##### **Low Air- and Vapour-Permeance Materials and Implications for Moisture Accumulation**

The location in a building assembly of a material with low air permeance is generally not critical; the material can restrict outward movement of indoor air whether it is located near the outer surface of the assembly, near the inner surface, or at some intermediate location, and such restriction of air movement is generally beneficial, whether or not the particular material is designated as part of the air barrier system. However, if such a material also has the characteristics of a vapour barrier (i.e. low permeability to water vapour), its location must be chosen more carefully in order to avoid moisture accumulation.

Any moisture from the indoor air that diffuses through the inner layers of the assembly or is carried by air leakage through those layers may be prevented from diffusing or being transferred through the assembly by a low air- and vapour-permeance material. This moisture transfer will usually not cause a problem if the material is located where the temperature is above the dew point of the indoor air: the water vapour will remain as vapour, the humidity level in the assembly will come to equilibrium with that of the indoor air, further accumulation of moisture will cease or stabilize at a low rate, and no harm will be done.

But if the low air- and vapour-permeance material is located where the temperature is below the dew point of the air at that location, water vapour will condense and accumulate as water or ice, which will reduce the humidity level and encourage the movement of more water vapour into the assembly. If the temperature remains below the dew point for any length of time, significant moisture could accumulate. When warmer weather returns, the presence of a material with low water vapour permeance can retard drying of the accumulated moisture. Moisture that remains into warmer weather can support the growth of decay organisms.

Due consideration should be given to the properties and location of any material in the building envelope, including paints, liquid-applied or sprayed-on and trowelled-on materials. It is recognized that constructions that include low air- and vapour-permeance materials are acceptable, but only where these materials are not susceptible to damage from moisture or where they can accommodate moisture, for example insulated concrete walls. Further information on the construction of basement walls may be found in "Performance Guidelines for Basement Envelope Systems and Materials," published by NRC-IRC.

#### Cladding

Different cladding materials have different vapour permeances and different degrees of susceptibility to moisture deterioration. They are each installed in different ways that are more or less conducive to the release of moisture that may accumulate on the inner surface. Sheet or panel-type cladding materials, such as metal sheet, have a vapour permeance less than  $60 \text{ ng}/(\text{Pa}\cdot\text{s}\cdot\text{m}^2)$ . Sheet metal cladding that has lock seams also has a low air leakage characteristic and so must be installed outboard of a drained and vented air space. Assemblies clad with standard residential vinyl or metal strip siding do not require additional protection as the joints are not so tight as to prevent the dissipation of moisture.

#### Sheathing

Like cladding, sheathing materials have different vapour permeances and different degrees of susceptibility to moisture deterioration.

Low-permeance sheathing may serve as the vapour barrier if it can be shown that the temperature of the interior surface of the sheathing will not fall below that at which saturation will occur. This may be the case where insulating sheathing is used.

#### Thermal Insulation

Where low-permeance foamed plastic is the sole thermal insulation in a building assembly, the temperature of the inner surface of this element will be close to the interior temperature. If the foamed plastic insulation has a permeance below  $60 \text{ ng}/\text{Pa}\cdot\text{s}\cdot\text{m}^2$ , it can fulfill the function of a vapour barrier to control condensation within the assembly due to vapour diffusion. However, where low-permeance thermal insulating sheathing is installed on the outside of an insulated frame wall, the temperature of the inner surface of the insulating sheathing may fall below the dew point; in this case, the function of vapour barrier has to be provided by a separate building element installed on the warm side of the assembly.

#### Normal Conditions

The required minimum ratios given in Table 9.25.5.2. are based on the assumption that the building assembly is subjected to conditions that are considered normal for typical residential occupancies, and business and personal services occupancies.

However, where the intended use of an occupancy includes facilities or activities that will generate a substantial amount of moisture indoors during the heating season, such as swimming pools, greenhouses, the operation of a laundromat or any continuous operation of

hot tubs and saunas, the building envelope assemblies would have to demonstrate acceptable performance levels in accordance with the requirements in Part 5.

**A-9.25.5.1.(1) Air and Vapour Permeance Values.** The air leakage characteristics and water vapour permeance values for a number of common materials are given in Table A-9.25.5.1.(1). These values are provided on a generic basis; proprietary products may have values differing somewhat from those in the Table (consult the manufacturers' current data sheets for their products' values).

The values quoted are for the material thickness listed. Water vapour permeance is inversely proportional to thickness: therefore, greater thicknesses will have lower water vapour permeance values.

**Table A-9.25.5.1.(1)**  
**Air and Vapour Permeance Values<sup>(1)</sup>**  
 Forming Part of Note A-9.25.5.1.(1)

Material	Air Leakage Characteristic, L/(s·m <sup>2</sup> ) at 75 Pa (Air Permeance)	Water Vapour Permeance, (Dry Cup) ng/(Pa·s·m <sup>2</sup> )
<b>Sheet and panel-type materials</b>		
12.7-mm gypsum board	0.02	2600
• painted (1 coat primer)	negligible	1300
• painted (1 coat primer + 2 coats latex paint)	negligible	180
12.7-mm foil-backed gypsum board	negligible	negligible
12.7-mm gypsum board sheathing	0.0091	1373
6.4-mm plywood	0.0084	23 – 74
11-mm oriented strandboard	0.0108	44 (range)
12.5-mm cement board	0.147	590
plywood (from 9.5 mm to 18 mm)	negligible – 0.01	40 – 57
fibreboard sheathing	0.012 – 1.91	100 – 2900
17-mm wood sheathing	high – depends on no. of joints	982
<b>Insulation</b>		
27-mm foil-faced polyisocyanurate	negligible	4.3
27-mm paper-faced polyisocyanurate	negligible	61.1
25-mm extruded polystyrene	negligible	23 – 92
25-mm expanded polystyrene (Type 2)	0.0214	86 – 160
fibrous insulations	very high	very high
25-mm polyurethane spray foam – low density	0.011	894 – 3791
25-mm polyurethane spray foam – medium density	negligible	96 <sup>(2)</sup>
<b>Membrane-type materials</b>		
asphalt-impregnated paper (10 min paper)	0.0673	370
asphalt-impregnated paper (30 min paper)	0.4	650
asphalt-impregnated paper (60 min paper)	0.44	1800
water-resistive barriers (9 materials)	negligible – 4.3	30 – 1200
0.15-mm polyethylene	negligible	1.6 – 5.8
asphalt-saturated felt (#15)	0.153	290
building paper	0.2706	170 – 1400
spun-bonded polyolefin film (expanded)	0.9593	3646
<b>Other materials</b>		
brick (6 materials)	negligible	102 – 602
metal	negligible	negligible
mortar mixes (4 materials)	negligible	13 – 690
stucco	negligible	75 – 240
50-mm reinforced concrete (density: 2 330 kg/m <sup>3</sup> )	negligible	23

**Notes to Table A-9.25.5.1.(1):**

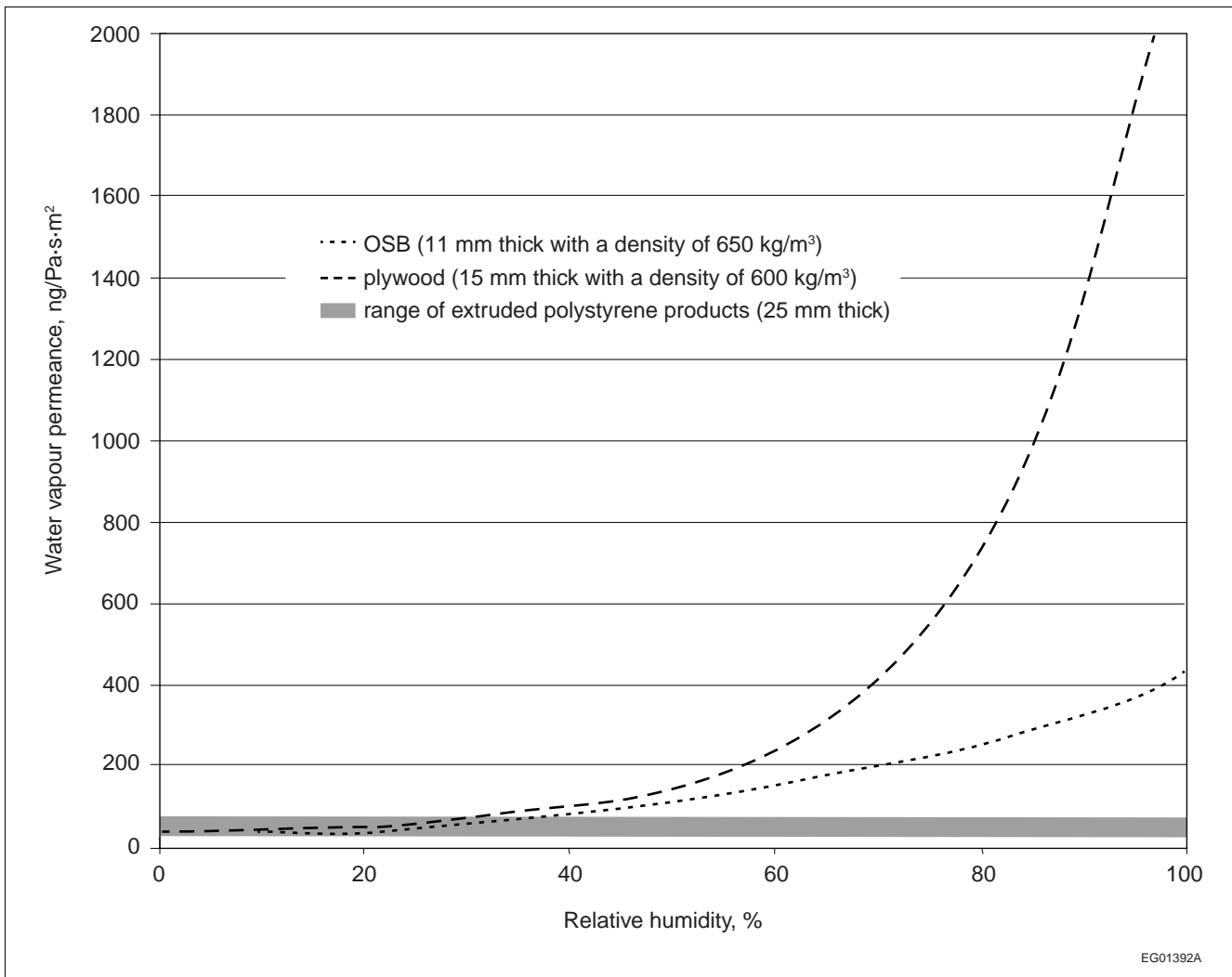
<sup>(1)</sup> Air leakage and vapour permeance values derived from:

Table A-9.25.5.1.(1) (Continued)

- Bombaru, D., Jutras, R. and Patenaude, A. "Air Permeance of Building Materials." Summary Report prepared by AIR-INS Inc. for Canada Mortgage and Housing Corporation, Ottawa, 1988. Values indicate properties of tested materials only; values for specific products may vary significantly.
  - "Details of Air Barrier Systems for Houses." Tarion Warranty Corporation (formerly Ontario New Home Warranty Program), Toronto, 1993.
  - Kumaran, M.K., et al., ASHRAE Research Report 1018 RP, A Thermal and Moisture Transport Property Database for Common Building and Insulating Materials.
  - Kumaran, M.K., Lackey, J., Normandin, N., van Reenen, D., Tariku, F., Summary Report from Task 3 of MEWS Project at the Institute for Research in Construction-Hygrothermal Properties of Several Building Materials, IRC-RR-110, March 2002.
  - Mukhopadhyaya, P., Kumaran, M.K., et al., Hygrothermal Properties of Exterior Claddings, Sheathings Boards, Membranes and Insulation Materials for Building Envelope Design, Proceedings of Thermal Performance of the Exterior Envelopes of Whole Building X, Clearwater, Florida, December 2-7, 2007, pp. 1-16 (NRCC-50287).
- (2) This water vapour permeance value is for a 25-mm-thick core layer of medium-density polyurethane spray foam. When installed in the field, a low permeance resin layer forms where the foam is in contact with the substrate. The water vapour permeance of the installed foam, were it measured including the resin layer, would therefore likely be lower than the value listed in the Table.

**A-9.25.5.1.(1)(a)(ii) Reduced Potential for Condensation in the Building Envelope.** The requirements in Article 9.25.5.2. aim to reduce the risk of condensation being introduced into wall assemblies due to the water vapour permeance of the outboard materials. Research has confirmed that the reduced condensation potential of exterior continuous insulation with a thermal resistance of at least 0.7 (m<sup>2</sup>·K)/W and a water vapour permeance between 30 and 1 800 ng/(Pa·s·m<sup>2</sup>) compares to reference assemblies without exterior insulation in a given geographic location and climatic exposure.

**A-9.25.5.1.(3) Wood-based Sheathing Materials.** Wood-based sheathing materials, such as plywood and OSB, that are not more than 12.5 mm thick are exempt from complying with Sentence 9.25.5.1.(1) because wood has an adaptive vapour permeance based on relative humidity: it has a low vapour permeance in an environment with low relative humidity and a higher vapour permeance in an environment with high relative humidity (see Figure A-9.25.5.1.(3)). This adaptive vapour permeance means that wood-based materials located on the outboard side of an assembly in winter, where the RH is typically 75% or higher, are relatively vapour-open, thus allowing greater vapour movement. The same wood-based material located on the inboard side of an assembly, where the RH is typically much lower in winter, has a low vapour permeance, thus mitigating the movement of vapour.



EG01392A

**Figure A-9.25.5.1.(3)**  
Adaptive water vapour permeance of wood-based sheathing materials

**A-9.25.5.2. Assumptions Followed in Developing Table 9.25.5.2.** Article 9.25.5.2. specifies that a low air- and vapour-permeance material must be located on the warm face of the assembly, outboard of a vented air space, or within the assembly at a position where its inner surface is likely to be warm enough for most of the heating season such that no significant accumulation of moisture will occur. This last position is defined by the ratio of the thermal resistance values outboard and inboard of the innermost impermeable surface of the material in question.

The design values given in Table 9.25.5.2. are based on the assumption that the building includes a mechanical ventilation system (between 0.3 and 0.5 air changes per hour), a 60 ng/Pa·s·m<sup>2</sup> vapour barrier, and an air barrier (values between 0.024 and 0.1 L/sm<sup>2</sup> through the assembly were used). The moisture generated by occupants and their use of bathrooms, cleaning, laundry and kitchen appliances was assumed to fall between 7.5 and 11.5 L per day.

It has been demonstrated through modelling under these conditions that assemblies constructed according to the requirements in Table 9.25.5.2. do not lead to moisture accumulation levels that may lead to deterioration as long as the average monthly vapour pressure difference between the exterior and interior sides over the heating season does not increase above 750 Pa, which would translate into an interior relative humidity of 35% in colder climates and 60% in mild climates.

Health Canada recommends an indoor relative humidity between 35% and 50% for healthy conditions. ASHRAE accepts a 30% to 60% range. Environments that are much drier tend to exacerbate respiratory problems and allergies; more humid environments tend to support the spread of microbes, moulds and dust mites, which can adversely affect health.

In most of Canada in the winter, indoor RH is limited by the exterior temperature and the corresponding temperature on the inside of windows. During colder periods, indoor RH higher than 35% will cause significant condensation on windows. When this occurs, occupants are likely to increase the ventilation to remove excess moisture. Although indoor RH may exceed 35% for short periods when the outside temperature is warmer, the criteria provided in Table 9.25.5.2. will still apply. Where higher relative humidities are maintained for extended periods in these colder climates, the ratios listed in the Table may not provide adequate protection. Some occupancies require that RH be maintained above 35% throughout the year, and some interior spaces support activities such as swimming that create high relative humidities. In these cases, Table 9.25.5.2. cannot be used and the position of the materials must be determined according to Part 5.

It should be noted that Part 9 building envelopes in regions with colder winters have historically performed acceptably when the interior RH does not exceed 35% over most of the heating season. With tighter building envelopes, it is possible to raise interior RH levels above 35%. There is no information, however, on how Part 9 building envelopes will perform when exposed to these higher indoor RH levels for extended periods during the heating season over many years. Operation of the ventilation system, as intended to remove indoor pollutants, will maintain the lower RH levels as necessary.

Calculating Inboard to Outboard Thermal Resistance

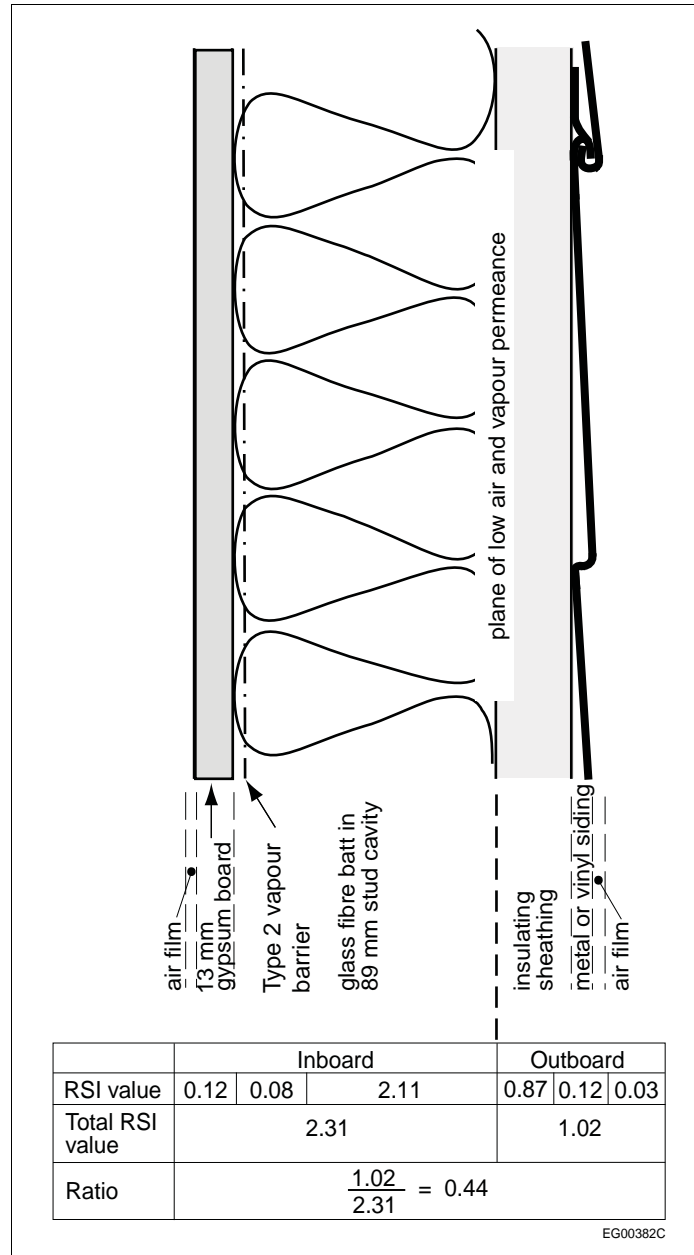


Figure A-9.25.5.2.

Example of a wall section showing thermal resistance inboard and outboard of a plane of low air and vapour permeance

The method of calculating the inboard to outboard thermal resistance ratio is illustrated in Figure A-9.25.5.2. The example wall section shows three planes where low air- and vapour-permeance materials have been installed. A vapour barrier, installed to meet the requirements of Subsection 9.25.4., is on the warm side of the insulation consistent with Clause 9.25.5.2.(1)(a) and Sentences 9.25.4.1.(1) and 9.25.4.3.(2). The vinyl siding has an integral drained and vented air space consistent with Clause 9.25.5.2.(1)(c). The position of the interior face of the low-permeance insulating sheathing, however, must be reviewed in terms of its thermal resistance relative to the overall thermal resistance of the wall, and the climate where the building is located.

Comparing the RSI ratio from the example wall section with those in Table 9.25.5.2. indicates that this wall would be acceptable in areas with Celsius degree-day values up to 7999, which includes, for example,



Whitehorse, Fort McMurray, Yorkton, Flin Flon, Geraldton, Val-d’Or and Wabush. (Degree-day values for various locations in Canada are provided in Appendix C.)

A similar calculation would indicate that, for a similar assembly with a 140 mm stud cavity filled with an RSI 3.52 batt, the ratio would be 0.28. Thus such a wall could be used in areas with Celsius degree-day values up to 4999, which includes, for example, Cranbrook, Lethbridge, Ottawa, Montreal, Fredericton, Sydney, Charlottetown and St. John’s.

Similarly, if half the thickness of the same low-permeance sheathing were used, the ratio with an 89 mm cavity would be 0.25, permitting its use in areas with Celsius degree-day values up to 4999. The ratio with a 140 mm cavity would be 0.16; thus this assembly could not be used anywhere, since this ratio is below the minimum permitted in Table 9.25.5.2.

Table A-9.25.5.2. shows the minimum thicknesses of low-permeance insulating sheathing necessary to satisfy Article 9.25.5.2. in various degree-day zones for a range of resistivity values of insulating sheathing. These thicknesses are based on the detail shown in Figure A-9.25.5.2. but could also be used with cladding details, such as brick veneer or wood siding, which provide equal or greater outboard thermal resistance.

**Table A-9.25.5.2.**  
**Minimum Thicknesses of Low-Permeance Insulating Sheathing**  
 Forming Part of Note A-9.25.5.2.

Celsius Heating Degree-days	Min. RSI Ratio	38 x 89 Framing					38 x 140 Framing				
		Min. Outboard Thermal Resistance, RSI	Min. Sheathing Thickness, mm				Min. Outboard Thermal Resistance, RSI	Min. Sheathing Thickness, mm			
			Sheathing Thermal Resistance, RSI/mm					Sheathing Thermal Resistance, RSI/mm			
			0.0300	0.0325	0.0350	0.0400		0.0300	0.0325	0.0350	0.0400
≤ 4999	0.20	0.46	10	10	9	8	0.72	19	17	16	14
5000 to 5999	0.30	0.69	18	17	16	14	1.07	31	28	26	23
6000 to 6999	0.35	0.81	22	20	19	16	1.25	37	34	32	28
7000 to 7999	0.40	0.92	26	24	22	19	1.43	43	39	37	32
8000 to 8999	0.50	1.16	34	31	29	25	1.79	55	50	47	41
9000 to 9999	0.55	1.27	37	34	32	28	1.97	61	56	52	45
10000 to 10999	0.60	1.39	41	38	35	31	2.15	67	61	57	50
11000 to 11999	0.65	1.50	45	42	39	34	2.33	73	67	62	54
≥ 12000	0.75	1.73	53	49	45	40	2.69	85	78	72	63

**References**

- (1) “Exposure Guidelines for Residential Indoor Air Quality,” Environmental Health Directorate, Health Protection Branch, Health Canada, Ottawa, April 1987 (Revised July 1989).
- (2) ANSI/ASHRAE 62, “Ventilation for Acceptable Indoor Air Quality.”

**A-9.26.1.1.(1) Platforms that Effectively Serve as Roofs.** Decks, balconies, exterior walkways and similar exterior surfaces effectively serve as roofs where these platforms do not permit the free drainage of water through the deck. When water is driven by wind across the deck (roof) surface, it can be driven upward when it encounters an interruption.

**A-9.26.2.3.(4) Fasteners for Treated Shingles.** Where shingles or shakes have been chemically treated with a preservative or a fire retardant, the fastener should be of a material known to be compatible with the chemicals used in the treatment.

**A-9.26.4.1. Junctions between Roofs and Walls or Guards.** Drainage of water from decks and other platforms that effectively serve as roofs will be blocked by walls, and blocked or restricted by guards where significant lengths and heights of material are connected to the deck. Without proper flashing at such roof-wall junctions or roof-guard junctions, water will generally leak into the adjoining constructions and can penetrate into supporting constructions below. Exceptions include platforms where waterproof curbs of sufficient height are cast-in or where the deck and wall or guard are unit-formed. In these cases, the monolithic deck-wall or deck-guard junctions will minimize the likelihood of water ingress. (See also Note A-9.26.1.1.(1).)

**A-9.26.17.1.(1) Installation of Concrete Roof Tiles.** Where concrete roof tiles are to be installed, the dead load imposed by this material should be considered in determining the minimum sizes and maximum spans of the supporting roof members.

**A-9.27.1.1.(5) EIFS on Walls with Cold-Formed Steel Stud Framing.** While Part 9 permits the installation of exterior insulation finish systems on walls with cold-formed steel stud framing, the design of loadbearing steel walls is outside the scope of Part 9 and is addressed in Part 4 (see Sentence 9.24.1.1.(2)).

**A-9.27.2. Required Protection from Precipitation.** Part 5 and Part 9 of the NBC recognize that mass walls and face-sealed, concealed barrier and rainscreen assemblies have their place in the Canadian context.

Mass walls are generally constructed of cast-in-place concrete or masonry. Without cladding or surface finish, they can be exposed to precipitation for a significant period before moisture will penetrate from the exterior to the interior. The critical characteristics of these walls are related to thickness, mass, and moisture transfer properties, such as shedding, absorption and moisture diffusivity.

Face-sealed assemblies have only a single plane of protection. Sealant installed between cladding elements and other envelope components is part of the air barrier system and is exposed to the weather. Face-sealed assemblies are appropriate where it can be demonstrated that they will provide acceptable performance with respect to the health and safety of the occupants, the operation of building services and the provision of conditions suitable for the intended occupancy. These assemblies, however, require more intensive, regular and ongoing maintenance, and should only be selected on the basis of life-cycle costing considering the risk of failure and all implications should failure occur. Climate loads such as wind-driven rain, for example, should be considered. Face-sealed assemblies are not recommended where the building owner may not be aware of the maintenance issue or where regular maintenance may be problematic.

Concealed barrier assemblies include both a first and second plane of protection. The first plane comprises the cladding, which is intended to handle the majority of the precipitation load. The second plane of protection is intended to handle any water that penetrates the cladding plane. It allows for the dissipation of this water, primarily by gravity drainage, and provides a barrier to further ingress.

Like concealed barrier assemblies, rainscreen assemblies include both a first and second plane of protection. The first plane comprises the cladding, which is designed and constructed to handle virtually all of the precipitation load. The second plane of protection is designed and constructed to handle only very small quantities of incidental water; composition of the second plane is described in Note A-9.27.3.1. In these assemblies, the air barrier system, which plays a role in controlling precipitation ingress due to air pressure difference, is protected from the elements. (See Figure A-9.27.2.)

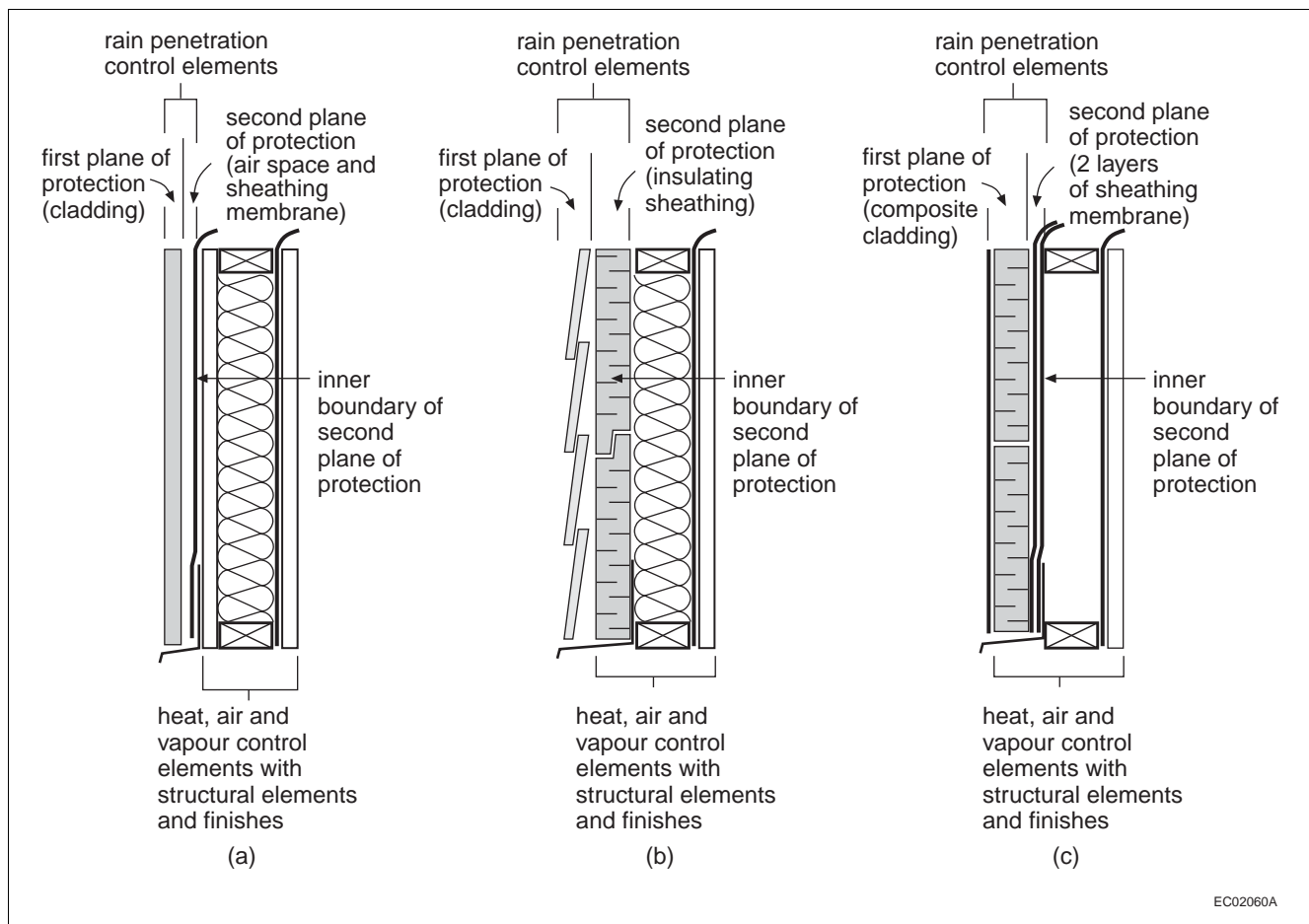


Figure A-9.27.2.  
Generic rainscreen assemblies

The cladding assembly described in Sentence 9.27.2.2.(4) is a basic rainscreen assembly. This approach is required for residential buildings where a higher level of ongoing performance is expected without significant maintenance. This approach, however, is recommended in all cases.

The cladding assemblies described in Sentence 9.27.2.2.(5) are also rainscreen assemblies. The assembly described in Clause 9.27.2.2.(1)(c) is again a basic rainscreen assembly. A wall with a capillary break as described in Clause 9.27.2.2.(1)(a) is an open rainscreen assembly. Walls with a capillary break as described in Clause 9.27.2.2.(1)(b) have been referred to as drainscreen assemblies.

**A-9.27.2.1.(1) Minimizing Precipitation Ingress.** The total prevention of precipitation ingress into wall assemblies is difficult to achieve and, depending on the wall design and construction, may not be absolutely necessary. The amount of moisture that enters a wall, and the frequency with which this occurs, must be limited. The occurrence of ingress must be sufficiently rare, accumulation sufficiently small and drying sufficiently rapid to prevent the deterioration of moisture-susceptible materials and the growth of fungi.

**A-9.27.2.2. Required Levels of Protection from Precipitation.** Precursors to Part 9 and all editions of the NBC containing a Part 9 applying to housing and small buildings included a performance-based provision requiring that cladding provide protection from the weather for inboard materials. Industry requested that Part 9 provide additional guidance to assist in determining the minimum levels of protection from precipitation to be provided by cladding assemblies. As with all requirements in the NBC, the new requirements in Article 9.27.2.2. describe the minimum cladding assembly configuration. Designers must still consider local accepted good practice, demonstrated performance and the specific conditions to which a particular wall will be exposed when designing or selecting a cladding assembly.

**Capillary Breaks**

The properties that are necessary for a material or assembly to provide a capillary break, and quantitative values for those properties, have not been defined. Among the material properties that need to be addressed are water absorption and susceptibility to moisture-related deterioration. Among the assembly characteristics to be considered are bridging of spaces by water droplets, venting and drainage.

Clause 9.27.2.2.(1)(a) describes the capillary break configuration typical of open rainscreen construction. The minimum 10 mm will avoid bridging of the space by water droplets and allow some construction tolerance.

Clause 9.27.2.2.(1)(b) describes a variation on the typical open rainscreen configuration. Products used to provide the capillary break include a variety of non-moisture-susceptible, open-mesh materials.

Clause 9.27.2.2.(1)(c) describes a configuration that is typical of that provided by horizontal vinyl and metal siding, without contoured insulating backing. The air space behind the cladding components and the loose installation reduce the likelihood of moisture becoming trapped and promote drying by airflow.

Clause 9.27.2.2.(1)(d) recognizes the demonstrated performance of masonry cavity walls and masonry veneer walls.

**Moisture Index**

The moisture index (MI) for a particular location reflects both the wetting and drying characteristics of the climate and depends on

- annual rainfall, and
- the temperature and relative humidity of the outdoor ambient air.

MI values are derived from detailed research and calculations.

Due to a lack of definitive data, the MI values identified in Sentence 9.27.2.2.(5), which trigger exceptions to or additional precipitation protection, are based on expert opinion. Designers should consider local experience and demonstrated performance when selecting materials and assemblies for protection from precipitation. For further information on MI, see Appendix C.

**A-9.27.3.1. Second Plane of Protection.** As specified in Sentence 9.27.3.1.(1), the second plane of protection consists of a drainage plane with an appropriate material serving as the inner boundary and flashing to dissipate rainwater or meltwater to the exterior.

**Drainage Plane**

Except for masonry walls, the simplest configuration of a drainage plane is merely a vertical interface between materials that will allow gravity to draw the moisture down to the flashing to allow it to dissipate to the exterior. It does not necessarily need to be constructed as a clear drainage space (air space).

For masonry walls, an open rainscreen assembly is required; that is, an assembly with first and second planes of protection where the drainage plane is constructed as a drained and vented air space. Such construction also constitutes best practice for walls other than masonry walls.

Section 9.20. requires drainage spaces of 25 mm for masonry veneer walls and 50 mm for cavity walls. In other than masonry walls, the drainage space in an open rainscreen assembly should be at least 10 mm deep. Drainage holes must be designed in conjunction with the flashing.

**Sheathing Membrane**

The sheathing membrane described in Article 9.27.3.2. is not a waterproof material. When installed to serve as the inner boundary of the second plane of protection, and when that plane of protection includes a drainage space at least 10 mm deep, the performance of the identified sheathing membrane has been demonstrated to be adequate. This is because the material is expected to have to handle only a very small quantity of water that penetrates the first plane of protection.

If the 10 mm drainage space is reduced or interrupted, the drainage capacity and the capillary break provided by the space will be reduced. In these cases, the material selected to serve as the inner boundary may need to be upgraded to provide greater water resistance in order to protect moisture-susceptible materials in the backing wall.

### Appropriate Level of Protection

It is recognized that many cladding assemblies with no space or with discontinuous space behind the cladding, and with the sheathing membrane material identified in Article 9.27.3.2., have provided acceptable performance with a range of precipitation loads imposed on them. Vinyl and metal strip siding, and shake and shingle cladding, for example, are installed with discontinuous drained spaces, and have demonstrated acceptable performance in most conditions. Lapped wood and composite strip sidings, depending on their profiles, may or may not provide discontinuous spaces, and generally provide little drainage. Cladding assemblies with limited drainage capability that use a sheathing membrane meeting the minimum requirements are not recommended where they may be exposed to high precipitation loads or where the level of protection provided by the cladding is unknown or questionable. Local practice with demonstrated performance should be considered. (See also Article 9.27.2.2. and Note A-9.27.2.2.)

**A-9.27.3.4.(2) Detailing of Joints in Exterior Insulating Sheathing.** The shape of a joint is critical to its ability to shed water. Tongue and groove, and lapped joints can shed water if oriented correctly. Butt joints can drain to either side and so should not be used unless they are sealed. However, detailing of joints requires attention not just to the shape of the joint but also to the materials that form the joint. For example, even if properly shaped, the joints in insulating sheathing with an integral sheathing membrane could not be expected to shed water if the insulating material absorbs water, unless the membrane extends through the joints.

**A-9.27.3.5.(1) Sheathing Membranes in lieu of Sheathing.** Article 9.23.17.1., Required Sheathing, indicates that sheathing must be installed only where the cladding requires intermediate fastening between supports (studs) or where the cladding requires a solid backing. Cladding such as brick or panels would be exempt from this requirement and in these cases a double layer of sheathing membrane would generally be needed. The exception (Article 9.27.3.6.) applies only to those types of cladding that provide a face seal to the weather.

**A-9.27.3.6. Sheathing Membrane under Face Sealed Cladding.** The purpose of sheathing membrane on walls is to reduce air infiltration and to control the entry of wind-driven rain. Certain types of cladding consisting of very large sheets or panels with well-sealed joints will perform this function, eliminating the need for sheathing membrane. This is true of the metal cladding with lock-seamed joints sometimes used on mobile homes. However, it does not apply to metal or plastic siding applied in narrow strips which is intended to simulate the appearance of lapped wood siding. Such material does not act as a substitute for sheathing membrane since it incorporates provision for venting the wall cavity and has many loosely-fitted joints which cannot be counted on to prevent the entry of wind and rain.

Furthermore, certain types of sheathing systems can perform the function of the sheathing membrane. Where it can be demonstrated that a sheathing material is at least as impervious to air and water penetration as sheathing membrane and that its jointing system results in joints that are at least as impervious to air and water penetration as the material itself, sheathing membrane may be omitted.

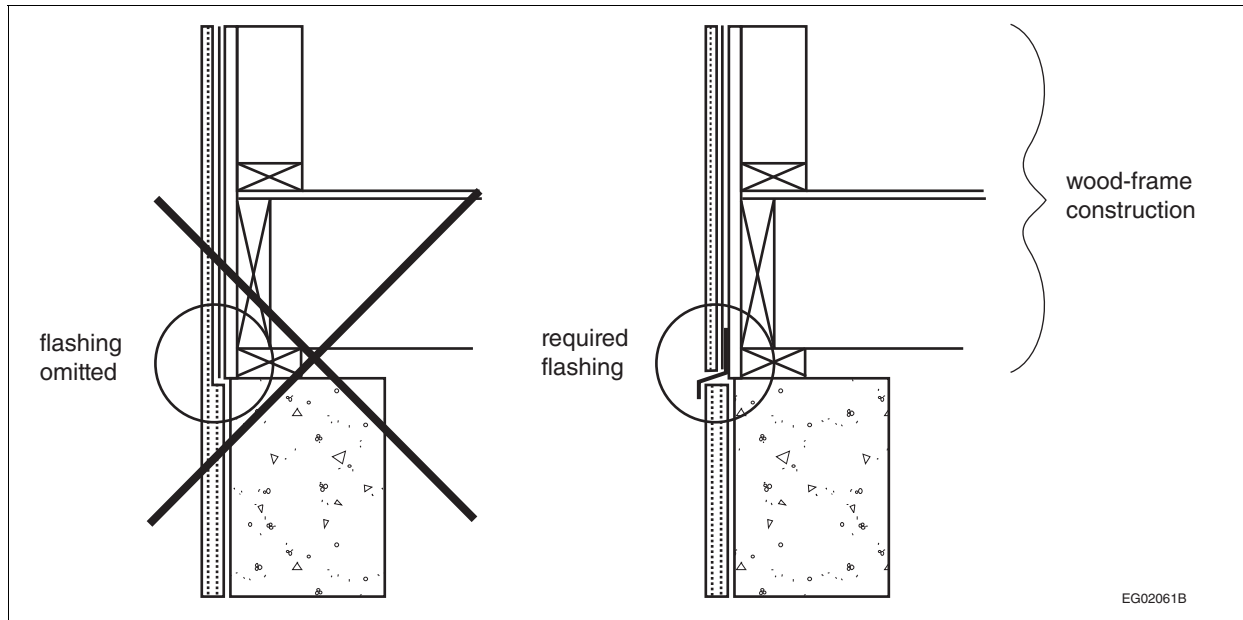
### A-9.27.3.8.(1) Required Flashing.

#### Horizontal Offsets

Where a horizontal offset in the cladding is provided by a single cladding element, there is no joint between the offset and the cladding above. In this case, and provided the cladding material on the offset provides effective protection for the construction below, flashing is not required.

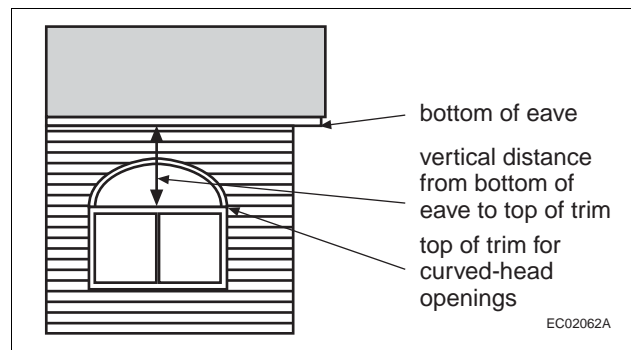
#### Changes in Substrate

In certain situations, flashing should be installed at a change of substrate: for example, where stucco cladding is installed on a wood-frame assembly, extending down over a masonry or cast-in-place concrete foundation and applied directly to it. Such an application does not take into account the potential for shrinkage of the wood frame and cuts off the drainage route for moisture that may accumulate behind the stucco on the frame construction.



**Figure A-9.27.3.8.(1)**  
**Flashing at change in substrate**

**A-9.27.3.8.(3) Flashing over Curved-Head Openings.** The requirement for flashing over openings depends on the vertical distance from the top of the trim over the opening to the bottom of the eave compared to the horizontal projection of the eave. In the case of curved-head openings, the vertical distance from the top of the trim increases as one moves away from the centre of the opening. For these openings, the top of the trim must be taken as the lowest height before the trim becomes vertical. (See Figure A-9.27.3.8.(3).)



**Figure A-9.27.3.8.(3)**  
**Flashing over curved-head openings**

**A-9.27.3.8.(4) Flashing Configuration and Positive Drainage.**

**Flashing Configuration**

A 6% slope is recognized as the minimum that will provide effective flashing drainage. The 10 mm vertical lap over the building element below and the 5 mm offset are prescribed to reduce transfer by capillarity and surface tension. Figure A-9.27.3.8.(4) illustrates two examples of flashing configurations.

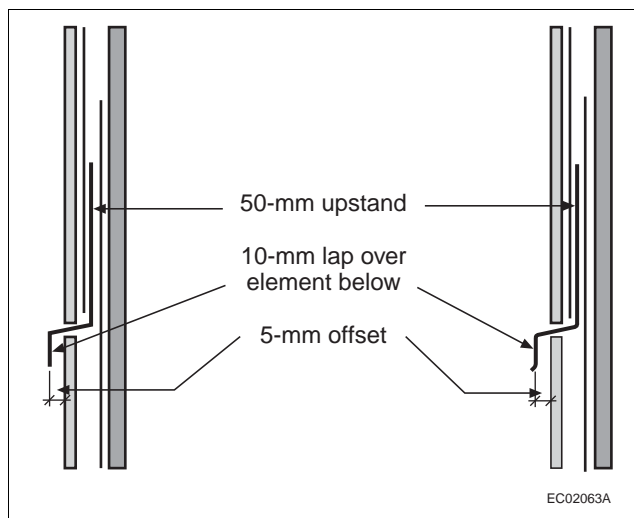


Figure A-9.27.3.8.(4)  
Examples of flashing configurations showing upstands, horizontal offsets and vertical laps

**Maintaining Positive Slope**

Sentence 9.27.3.8.(4) requires that the minimum 6% flashing slope remain after expected shrinkage of the building frame. Similarly, Sentence 9.26.3.1.(4) requires that a positive slope remain on roofs and similar constructions after expected shrinkage of the building frame.

For Part 9 wood-frame constructions, expected wood shrinkage can be determined based on the average equilibrium moisture content (MC) of wood, within the building envelope assembly, in various regions of the country (see Table A-9.27.3.8.(4)).

Table A-9.27.3.8.(4)  
Equilibrium Moisture Content for Wood  
Forming Part of Note A-9.32.3.1.(1)

Regions	Equilibrium MC, % <sup>(1)</sup>
British Columbia and Atlantic Canada	10
Ontario and Quebec	8
Prairies and the North	7

**Notes to Table A-9.27.3.8.(4):**

<sup>(1)</sup> CWC 2000, "Wood Reference Handbook."

For three-storey constructions to which Part 9 applies, cumulative longitudinal shrinkage is negligible. Shrinkage need only be calculated for horizontal framing members using the following formula (from CWC 1997, "Introduction to Wood Building Technology"):

$$\text{Shrinkage} = (\text{total horizontal member height}) \times (\text{initial MC} - \text{equilibrium MC}) \times (.002)$$

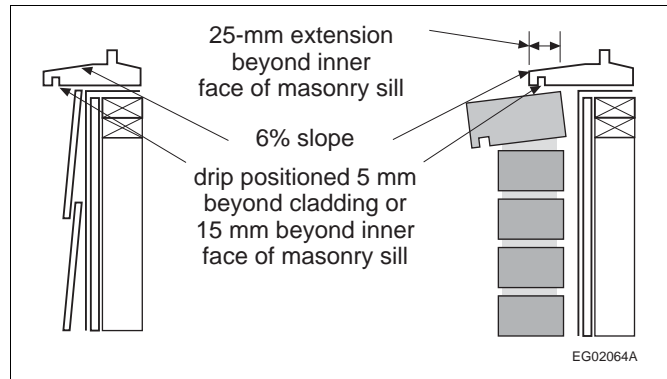
**A-9.27.3.8.(5) Protection against Precipitation Ingress at the Sill-to-Cladding Joint.** Many windows are configured in such a way that a line of sealant is the only protection against water ingress at the sill-to-cladding joint—a location that is exposed to all of the water that flows down the window. In the past, many windows were constructed with self-flashing sills—sills that extend beyond the face of the cladding and have a drip on the underside to divert water away from the sill-to-cladding joint. This sill configuration was considered to be accepted good practice and is recognized today as providing a degree of redundancy in precipitation protection.

Self-flashing sills are sills that

- slope toward the exterior where the sills have an upward facing surface that extends beyond the jambs,
- where installed over a masonry sill, extend not less than 25 mm beyond the inner face of that sill,

- incorporate a drip positioned not less than 5 mm outward from the outer face of the cladding below or not less than 15 mm beyond the inner edge of a masonry sill, and
- terminate at the jambs or, where the face of the jambs is not at least flush with the face of the cladding and the sills extend beyond the jambs, incorporate end dams sufficiently high to protect against overflow in wind-driven rain conditions.

A wind pressure of 10 Pa can raise water 1 mm. Thus, for example, if a window is exposed to a driving rain wind pressure of 200 Pa, end dams should be at least 20 mm high.



**Figure A-9.27.3.8.(5)**  
**Examples of configurations of self-flashing sills**



**A-9.27.4.2.(1) Selection and Installation of Sealants.** Analysis of many sealant joint failures indicates that the majority of failures can be attributed to improper joint preparation and deficient installation of the sealant and various joint components. The following ASTM guidelines describe several aspects that should be considered when applying sealants in unprotected environments to achieve a durable application:

- ASTM C 1193, "Use of Joint Sealants,"
- ASTM C 1299, "Selection of Liquid-Applied Sealants," and
- ASTM C 1472, "Calculating Movement and Other Effects When Establishing Sealant Joint Width."

The sealant manufacturer's literature should always be consulted for recommended procedures and materials.

**A-9.27.9.2.(3) Grooves in Hardboard Cladding.** Grooves deeper than that specified may be used in thicker cladding providing they do not reduce the thickness to less than the required thickness minus 1.5 mm. Thus for type 1 or 2 cladding, grooves must not reduce the thickness to less than 4.5 mm or 6 mm depending on method of support, or to less than 7.5 mm for type 5 material.

**A-9.27.10.2.(2) Thickness of Grade O-2 OSB.** In using Table 9.27.8.2. to determine the thickness of Grade O-2 OSB cladding, substitute "face orientation" for "face grain" in the column headings.

**A-9.27.11.1.(3) and (4) Material Standards for Aluminum Cladding.** Compliance with Sentence 9.27.11.1.(3) and CAN/CGSB-93.2-M, "Prefinished Aluminum Siding, Soffits, and Fascia, for Residential Use," is required for aluminum siding that is installed in horizontal or vertical strips. Compliance with Sentence 9.27.11.1.(4) and CAN/CGSB-93.1-M, "Sheet, Aluminum Alloy, Prefinished, Residential," is required for aluminum cladding that is installed in large sheets.

**A-9.27.13.1.(1) Geometrically Defined Drainage Cavity.** "Geometrically defined drainage cavity" (GDDC) refers to the channels, grooves or profiles cut into the insulation backing of an EIFS panel for the purpose of providing a way for water that gets behind the system to drain out. The channels, grooves or profiles of one panel need to connect to the channels, grooves or profiles of adjacent panels in order for drainage to occur consistently and uniformly across the entire EIFS. While the size of a channel, groove or profile can be verified by inspecting a single panel, the intent of Sentence 9.27.13.1.(1) is that the required drainage capacity be achieved across the entire system.

Additional information on the design and installation of EIFS can be found in

- the "EIFS Practice Manual," published by the EIFS Council of Canada, and
- the manufacturer's literature.

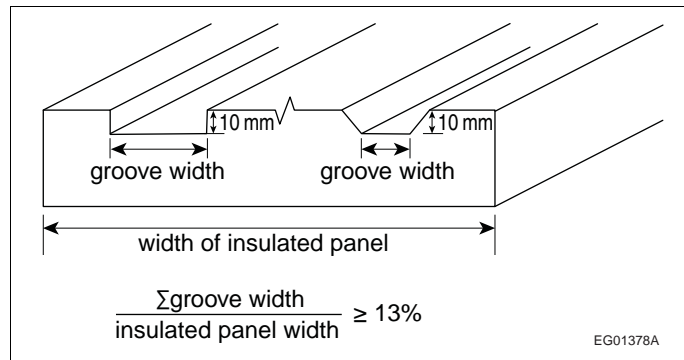


Figure A-9.27.13.1.(1)  
Geometrically defined drainage cavity

**A-9.27.13.2.(2)(a) Substrates for Exterior Insulation Finish Systems.** The list of acceptable substrates for each type of EIFS can be found in a system's respective test report to CAN/ULC-S716.1, "Exterior Insulation and Finish Systems (EIFS) - Materials and Systems"; however, the following substrates are generally considered acceptable:

- minimum 11 mm thick exposure 1 OSB classified as PS2 exterior wall sheathing
- minimum 11 mm thick exterior-rated plywood sheathing
- minimum 12.7 mm thick exterior gypsum sheathing conforming to ASTM C 1177/C 1177M, "Glass Mat Gypsum Substrate for Use as Sheathing"
- cementitious panels

- fibre-cement panels
- concrete block
- clay masonry
- cast-in-place concrete

Note that, in some cases, the list of acceptable substrates may be limited by the EIFS manufacturer.

**A-Table 9.28.4.3. Stucco Lath.** Paper-backed welded wire lath may also be used on horizontal surfaces provided its characteristics are suitable for such application.

**A-9.30.1.2.(1) Water Resistance.** In some areas of buildings, water and other substances may frequently be splashed or spilled onto the floor. It is preferable, in such areas, that the finish flooring be a type that will not absorb moisture or permit it to pass through; otherwise, both the flooring itself and the subfloor beneath it may deteriorate. Also, particularly in food preparation areas and bathrooms, unsanitary conditions may be created by the absorbed moisture. Where absorbent or permeable flooring materials are used in these areas, they should be installed in such a way that they can be conveniently removed periodically for cleaning or replacement, i.e., they should not be glued or nailed down. Also, if the subfloor is a type that is susceptible to moisture damage (this includes virtually all of the wood-based subfloor materials used in wood-frame construction), it should be protected by an impermeable membrane placed between the finish flooring and the subfloor. The minimum degree of impermeability required by Sentence 9.30.1.2.(1) would be provided by such materials as polyethylene, aluminum foil, and most single-ply roofing membranes (EPDM, PVC).

**A-9.31.6.2.(3) Securement of Service Water Heaters.**

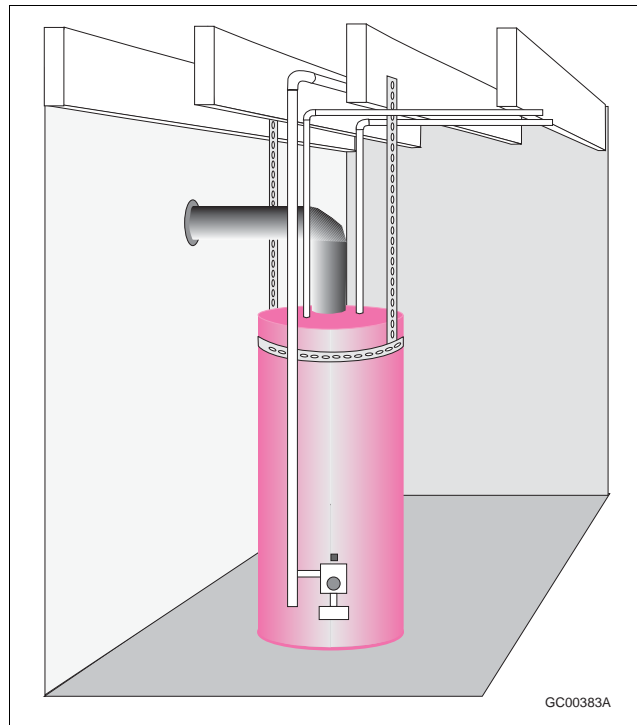


Figure A-9.31.6.2.(3)  
Securement of service water heater using strapping fastened to floor joists overhead

**A-9.32.1.2.(2) Application of Subsection 9.32.3. and Ventilation of Houses Containing a Secondary Suite.**

**Ventilation for Smoke Control**

The control of smoke transfer between dwelling units in a house with a secondary suite, or between the dwelling units and other spaces in the house, is a critical safety issue. Although providing a second ventilation system to serve the two dwelling units is expensive—and potentially difficult in an existing building—it is necessary to achieving a minimum acceptable level of fire safety.

Alternative solutions to providing separate ventilation systems for the dwelling units must address smoke control. Although smoke dampers restrict the spread of smoke by automatically closing in the event of a fire, their installation in a ventilation system that serves both dwelling units in a house with a secondary suite is not considered to be a workable solution because they are very expensive, require regular inspection and maintenance, and must be reset after every activation.

### Ventilation for Air Exchange

The provision of a ventilation system for the purpose of maintaining acceptable indoor air quality is a critical health issue. However, Sentence 9.32.1.2.(3) allows exits and public corridors in houses with a secondary suite to be unventilated. Lack of active ventilation of these spaces is considered acceptable because occupants do not spend long periods of time there and because exits are somewhat naturally ventilated when doors are opened.

Considering the cost of installing separate ventilation systems, Sentence 9.32.1.2.(4) also exempts ancillary spaces in houses with a secondary suite from the requirement to be ventilated, provided that make-up air is supplied in accordance with Article 9.32.3.8.

**A-9.32.1.3.(2) Venting of Laundry-Drying Equipment.** Sentence 9.32.1.3.(2) applies to the piping and ducting located within the wall assembly and not to the often flexible duct used to connect the appliance to the rigid exhaust vent duct.

**A-9.32.3. Heating-Season Mechanical Ventilation.** For many years, houses were constructed without mechanical ventilation systems. They relied on natural air leakage through the building envelope for winter ventilation. However, houses have become progressively more airtight through the introduction of new products and practices, e.g., the substitution of panel sheathings, such as plywood and waferboard, for board sheathing, the replacement of paper-backed insulation batts with friction-fit batts and polyethylene film, improved caulking materials, and tighter windows and doors.

Following the energy crisis in the early 1970s, considerable emphasis was placed on reducing air leakage in order to conserve energy. Electric heating systems were encouraged and higher efficiency furnaces were developed, which further reduced air change rates in buildings. This led to concern that the natural air change in dwelling units might be insufficient in some instances to provide adequate indoor air quality. Condensation problems resulting from higher humidity levels were also a concern.

### Evolution of NBC Ventilation Requirements

Mechanical ventilation requirements in the NBC have evolved from a simple requirement in the 1980 edition that exhaust fans be incorporated in electrically heated houses, through requirements in the 1985 and 1990 editions that all houses have mechanical ventilation systems capable of exchanging the indoor air for outdoor air at a specified rate: 0.5 air changes per hour in the 1985 edition and 0.3 air changes per hour in the 1990 edition.

The 1995 NBC addressed not only the overall air change rate created by the mechanical ventilation system but also the need to ensure that the outdoor air brought into the house by the system is distributed throughout the house.

### Current Requirements

The current requirements are a further refinement. The ventilation systems described herein are essentially the same as those described in the 1995 NBC but additional provisions have been included with the following goals in mind:

- provisions that are easier to understand,
- reduced probability that outdoor air distributed through a forced-air heating system will be cool enough to cause premature deterioration of the furnace heat exchanger, and
- reduced probability that the ventilation system will cause excessive depressurization of the dwelling unit.

To some extent, the first of these goals conflicts with the other two and its achievement has suffered accordingly. Only in the manner of determining the capacity of the principal ventilation fan [see Sentence 9.32.3.3.(2)] has any significant simplification been achieved.

See also Note A-9.32.3.3.(2).

**A-9.32.3.1.(1) Required Ventilation.****Performance Approach [Clause 9.32.3.1.(1)(a)]**

CAN/CSA-F326-M, "Residential Mechanical Ventilation Systems," is a comprehensive performance standard. It gives experienced ventilation system designers the flexibility to design a variety of residential ventilation systems that satisfy those requirements.

**Prescriptive Approach [Clause 9.32.3.1.(1)(b)]**

The prescriptively described systems are intended to provide a level of performance approaching that provided by systems complying with CAN/CSA-F326-M, "Residential Mechanical Ventilation Systems." They are included in the NBC for use by those less experienced in ventilation system design. Code users who do not find these prescriptively described systems satisfactory for their purposes, or who find them too restrictive, are free to use any other type of ventilation system that satisfies the performance requirements of CAN/CSA-F326-M.

**A-9.32.3.3. Principal Ventilation System.** The principal ventilation system circulates air throughout the house for the purpose of maintaining acceptable indoor air quality. Each ventilation system has three main components:

- indoor air exhaust
- outdoor air supply
- distribution of air

**Indoor Air Exhaust**

The principal ventilation fan extracts indoor air. Its operation is linked with a means of introducing and distributing outdoor air to the dwelling unit at approximately the same rate at which the indoor air is exhausted, except as permitted by Article 9.32.3.6.

The principal ventilation fan must be capable of drawing air from throughout the dwelling unit and exhausting it to the outdoors. Though actual usage will be determined by the occupants, the fan must be capable of continuous operation. Unfortunately, there is no standard method of testing and designating fans for continuous use. Therefore, such a designation is not a mandatory requirement [see Sentence 9.32.3.3.(4)].

Supplemental exhaust fans, such as kitchen cooktop hoods and bathroom fans, provide more ventilation at point of source when needed (see Article 9.32.3.7. and Note A-9.32.3.7.).

**Outdoor Air Supply**

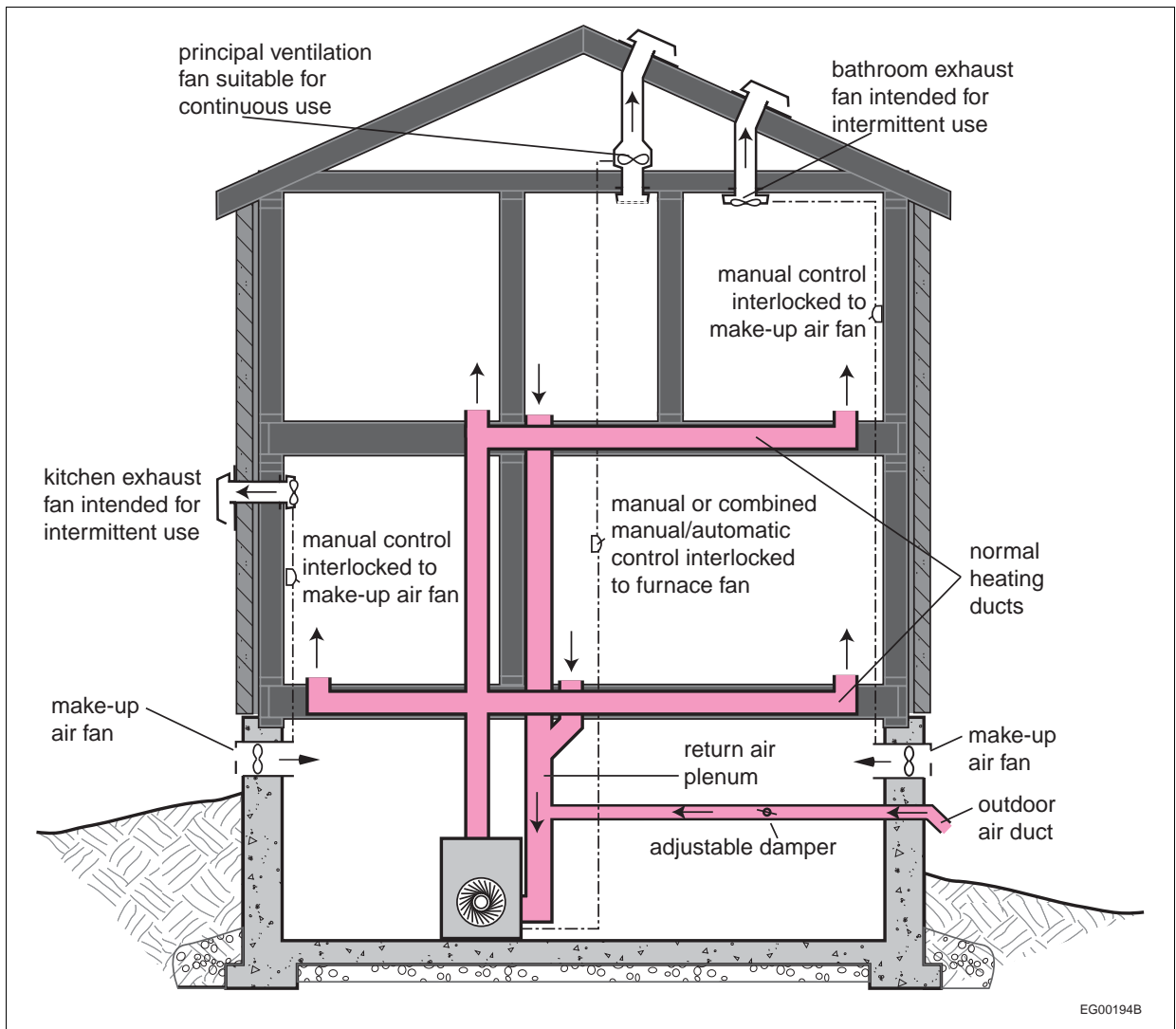
Outdoor air is brought into a house either through a supply duct in the exterior wall or, in exhaust-only systems, by leaks through the building envelope. See also Note A-9.32.3.6.

**Distribution of Air**

There are two approaches to ensuring air is distributed to all parts of the house:

- in forced air heating systems, the furnace circulation fan moves the air through heating distribution ducts (see Note A-9.32.3.4.),
- in non-forced air heating systems, a supply fan circulates air through dedicated ventilation distribution ducts (see Note A-9.32.3.5.).

Figures A-9.32.3.3.-A to A-9.32.3.3.-F and A-9.32.3.6. show possible configurations of principal ventilation systems. However, even within these prescriptive solutions, a significant degree of flexibility is available. The configurations illustrated should therefore not be regarded as the only configurations acceptable under Sentence 9.32.3.1.(2).

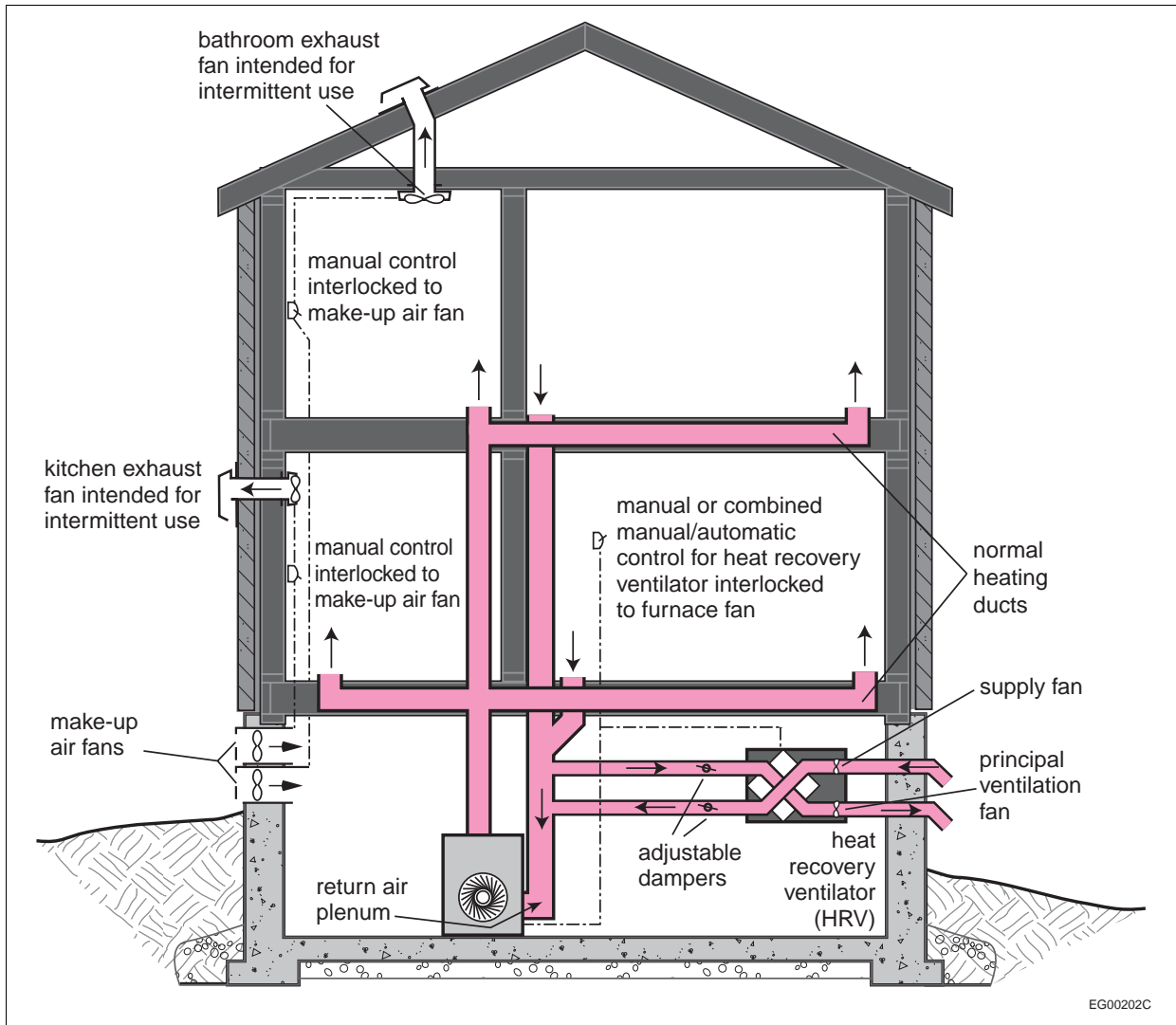


EG00194B

**Figure A-9.32.3.3-A**  
**Possible configuration of a ventilation system coupled with a forced air heating system**

**Note to Figure A-9.32.3.3-A:**

- (1) The outdoor air supply duct shall be connected not less than 3 m upstream of the plenum connection to the furnace.



**Figure A-9.32.3.3.-B**

**Possible configuration of a ventilation system using a heat recovery ventilator coupled with a forced air heating system**

**Notes to Figure A-9.32.3.3.-B:**

- (1) The outdoor air supply duct shall be connected not less than 3 m upstream of the plenum connection to the furnace.
- (2) The HRV supply inlet and exhaust outlet shall be separated by a distance of not less than 900 mm.

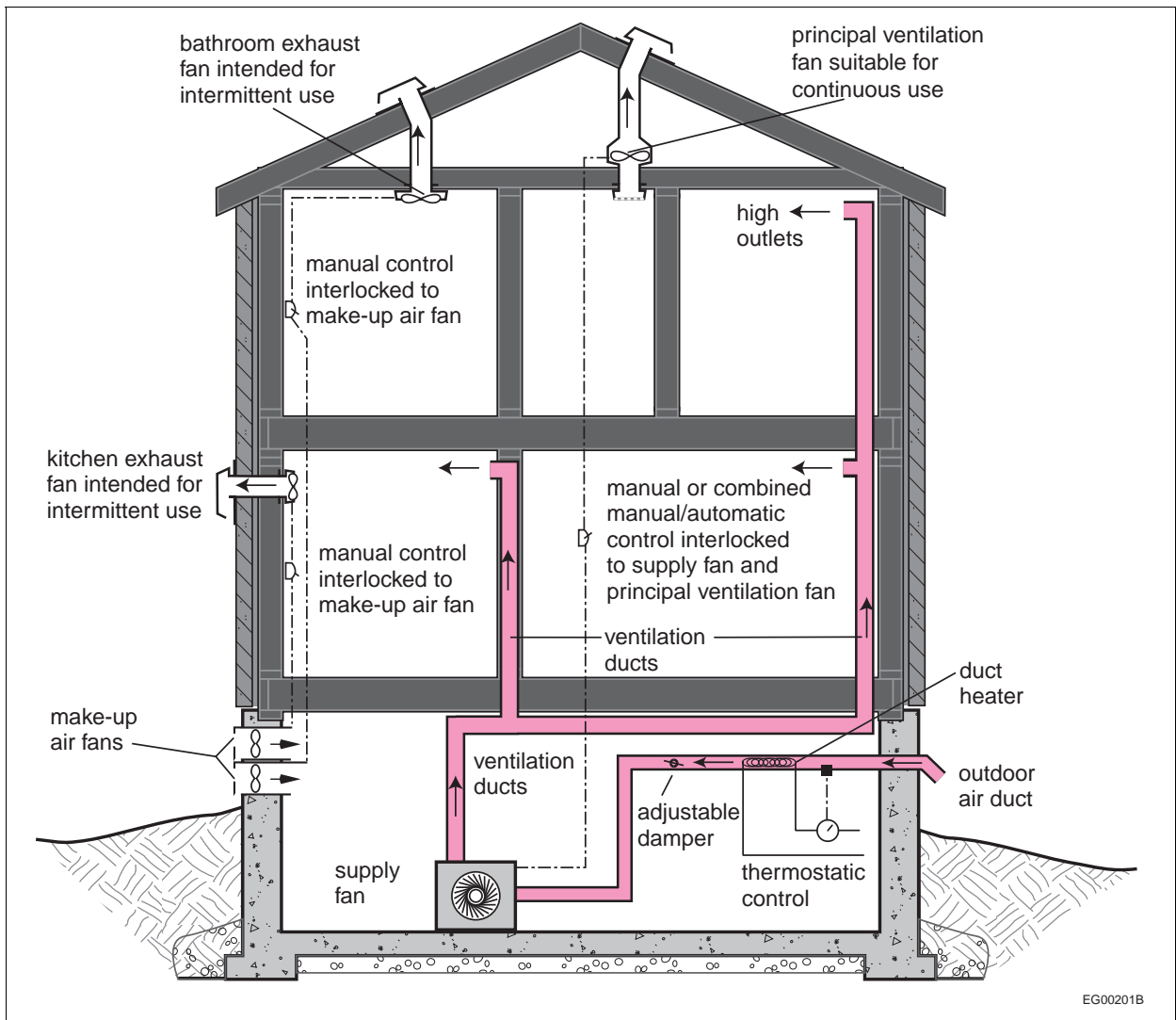
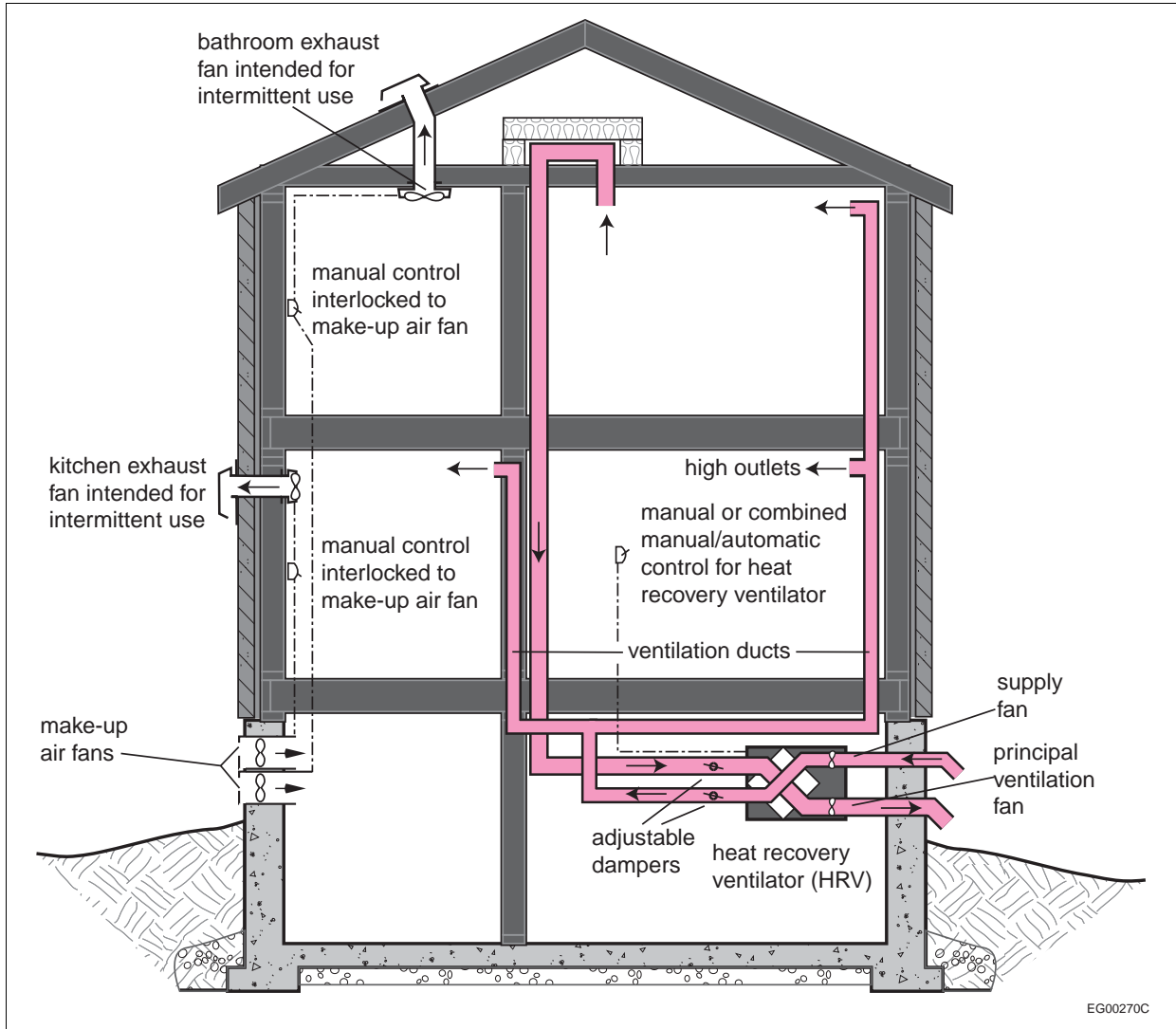


Figure A-9.32.3.3-C

Possible configuration of a ventilation system not coupled with a forced air heating system

Note to Figure A-9.32.3.3-C:

- (1) The outdoor air supply duct shall be connected not less than 3 m upstream of the plenum connection to the furnace.



EG00270C

**Figure A-9.32.3.3.-D**

**Possible configuration of a ventilation system using a heat recovery ventilator not coupled with a forced air heating system**

**Note to Figure A-9.32.3.3.-D:**

- (1) The HRV supply inlet and exhaust outlet shall be separated by a distance of not less than 900 mm.



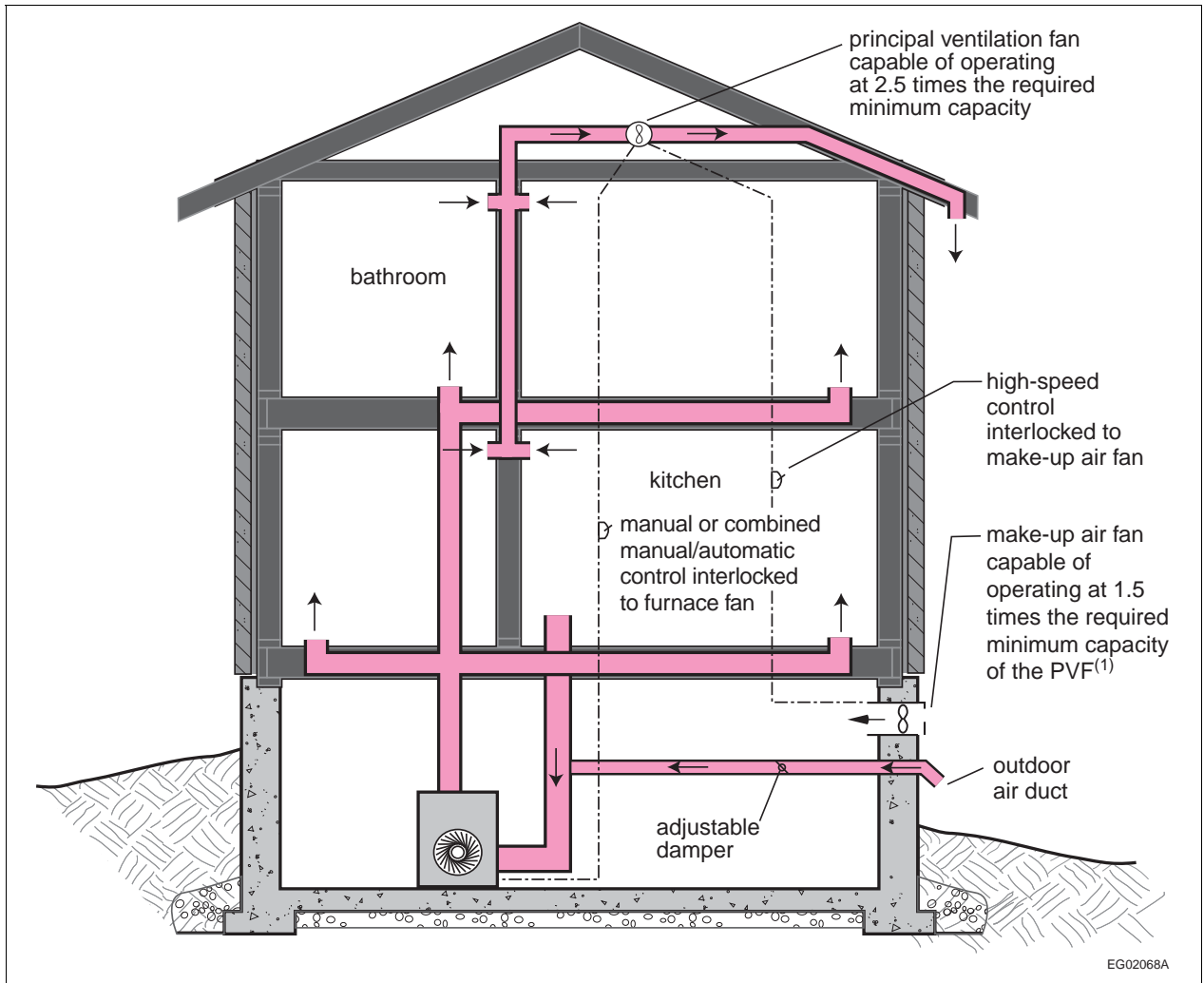
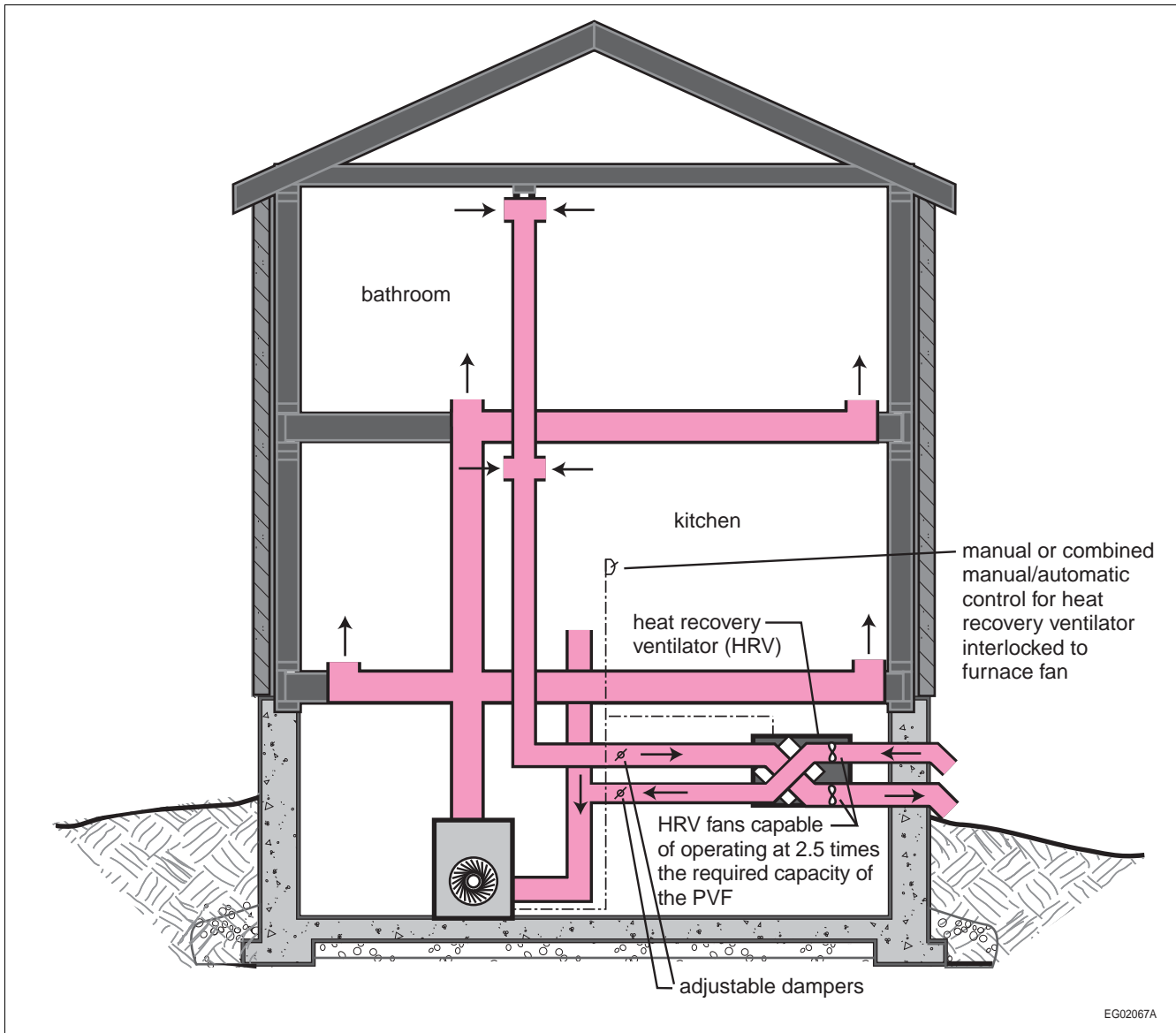


Figure A-9.32.3.3-E

Ventilation system coupled with a forced air heating system and using a dual-capacity principal ventilation fan to eliminate the need for supplemental fans

Notes to Figure A-9.32.3.3-E:

- (1) The make-up air fan operates when the PVF operates at 2.5 times the required capacity.
- (2) The outdoor air supply duct shall be connected not less than 3 m upstream of the plenum connection to the furnace.



**Figure A-9.32.3.3.-F**

**Ventilation system coupled with a forced air heating system and using a heat recovery ventilator as the principal ventilation fan to eliminate the need for supplemental fans**

**Notes to Figure A-9.32.3.3.-F:**

- (1) The outdoor air supply duct shall be connected not less than 3 m upstream of the plenum connection to the furnace.
- (2) The HRV supply inlet and exhaust outlet shall be separated by a distance of not less than 900 mm.

EG02067A

**A-9.32.3.3.(2) Normal Operating Exhaust Capacity.** The principal ventilation fan operates at a rate known as the “normal operating exhaust capacity.” This rate is intended to be suitable for use on a continuous basis at any time that an ongoing, background level of ventilation is needed, e.g. the late fall or early spring when air leakage driven by wind and inside/outside temperature differences is lowest but it is too cold to rely on open windows.

The capacity of the principal ventilation fan is determined on the basis of the number of bedrooms in the house rather than on the basis of some fraction of the house volume, as in previous editions of the NBC. This is because the amount of ventilation required is related to the activities of people, and the number of people in the house is usually related to the number of bedrooms rather than to the size of the house. It should be emphasized that this air change rate refers to the installed capacity of the system, not to the rate of ventilation that is actually used in the house.

In many households, ventilating even at the background rate would provide more ventilation than required, resulting in unnecessarily high heating bills and perhaps excessively low indoor relative humidity. Thus, although a system with the minimum capacity must be installed, it can incorporate controls that allow the system to be used at less than its full capacity most of the time.

A maximum is set for the capacity of the principal ventilation fan because, if it were to be much larger than the ventilation needs of the household, it might never be used. The principal ventilation fan is intended to provide a relatively low level of ventilation such that it can be run continuously without too much noise and without serious energy penalty. If the installed capacity exceeds the minimum by a large margin and the fan flow cannot be reduced, there is increased probability that the fan will not be used at all, thus defeating the purpose of having it in the first place. Sentence 9.32.3.3.(2) therefore places limits on oversizing.

**A-9.32.3.3.(3) Required Controls.** The principal ventilation fan must incorporate controls that allow it to be turned off. There are four main types of controls used in residential applications:

- (a) **Manual on-off switch:** This is the simplest form of control but, while acceptable, it is not the best means of maintaining indoor air quality. Occupants may turn the system off and forget to turn it back on, or may turn it off to save on heating bills or to reduce noise, not realizing the importance of proper ventilation.
- (b) **Dehumidistat:** A dehumidistat automatically activates the ventilation system in response to rising humidity. Humidity is often the main reason why ventilation is required, but not always. Depending on the activities of the occupants and the relative strengths of other sources of pollutants and humidity, the amount of ventilation required to control humidity may not be enough to control other pollutants.
- (c) **Carbon Dioxide Sensor:** Ventilation systems in large buildings are sometimes controlled by carbon dioxide (CO<sub>2</sub>) sensors and this technology is just beginning to be available on a residential scale. Increasing CO<sub>2</sub> concentration is usually a good indication of decreasing air quality. But even this form of control may not be satisfactory in cases where there are unusual pollutants, such as those generated by certain hobbies.
- (d) **Periodic Cycling Control:** Devices are available that cause the furnace circulation fan to operate at user-set intervals if the thermostat does not call for heat. If such a device were wired so that it turns on the principal ventilation fan as well as the furnace circulation fan, it would satisfy the requirements of Article 9.32.3.4. However, if it were wired to only operate the furnace circulation fan in a system designed to Article 9.32.3.4., at times the principal ventilation fan would operate without the furnace circulation fan. Since such systems rely on the furnace circulation fan drawing in outdoor air to balance the exhaust flow through the principal ventilation fan, this would result in the exhaust flow not being balanced and the dwelling being depressurized. This configuration would therefore not be acceptable. This device would be acceptable in conjunction with a system designed in accordance with Article 9.32.3.6.

**A-9.32.3.3.(5) Location of Controls.** The intent of the requirement to locate the controls in the living area is to have them easily accessible to the occupants, rather than in a little used room or unfinished basement, for example.

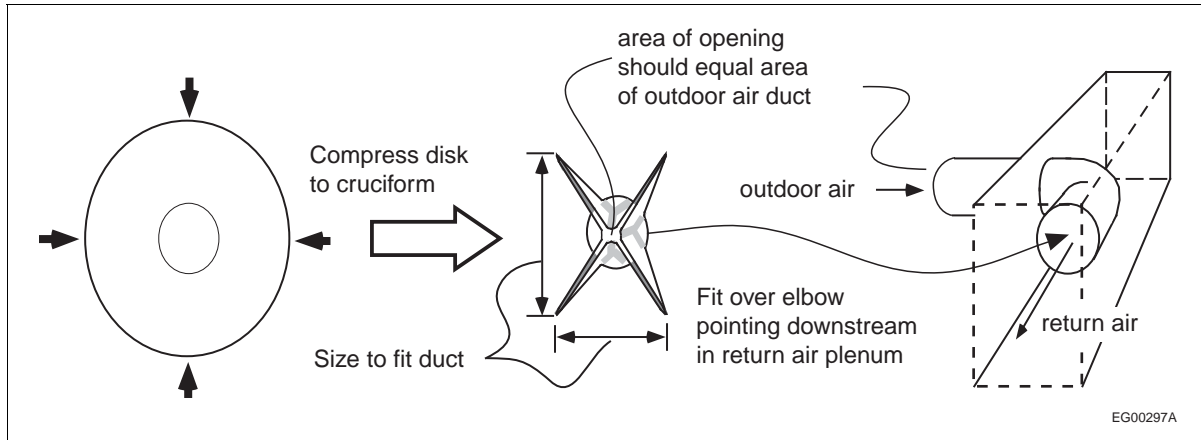
Installers should consider marking the manual switch with an icon depicting a fan as well as the words “Ventilation Fan.”

**A-9.32.3.3.(10) Location of Exhaust Air Intakes.** Where the kitchen or a bathroom is chosen as the location for the air intake of the principal ventilation fan, the intake must be positioned high enough to capture contaminants, warm moist air, and hot gases, which tend to rise and stratify near the ceiling. These restrictions prevent the use of a cooktop exhaust or hood fan as the principal ventilation fan.

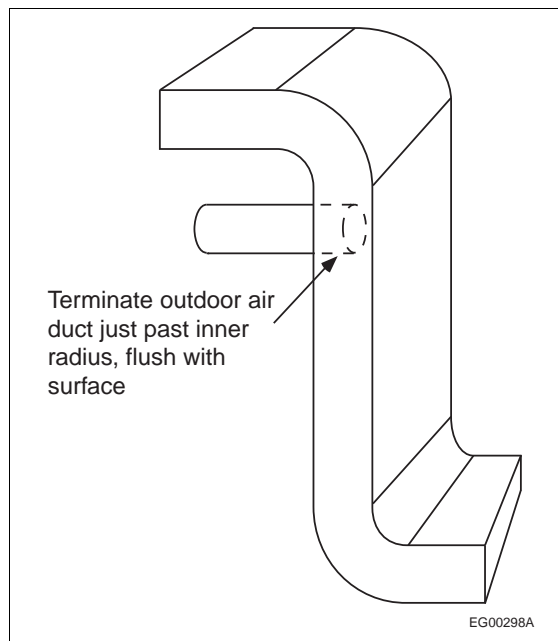
**A-9.32.3.4. Ventilation Systems Used in Conjunction with Forced Air Heating**

**Systems.** Coupling a ventilation system with a forced air heating system to provide the necessary distribution of outdoor air is relatively simple. A duct brings air from outdoors to the heating system’s return air plenum. Whenever the principal ventilation fan is activated, the furnace fan is automatically activated to distribute the outdoor air [see Sentence 9.32.3.4.(9)]. Where no auxiliary supply fan is installed as per Sentence 9.32.3.4.(8), the furnace fan also drives the flow of outdoor air in through the outdoor air duct. Use of an auxiliary supply fan allows the size of the outdoor air supply duct to be reduced.

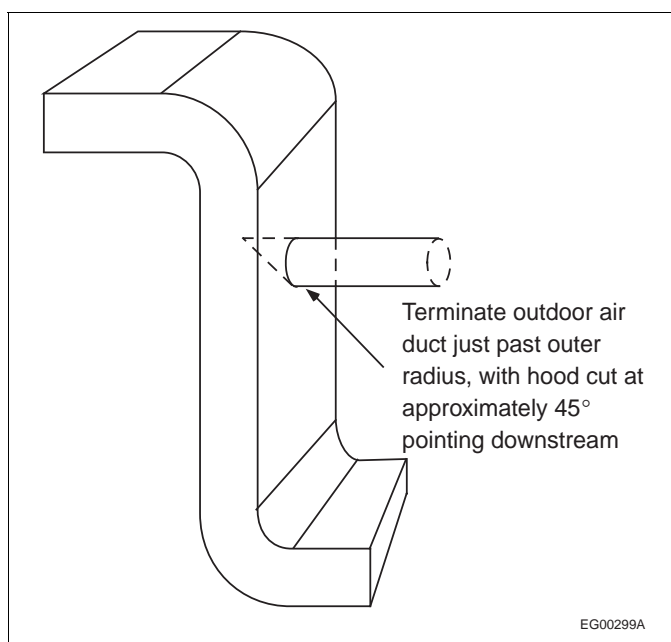
This system tempers the outdoor air before it reaches occupied areas of the house by mixing it with return air in the furnace’s return air plenum. It is important that thorough mixing occur before the cold air reaches the furnace’s heat exchanger, otherwise condensation could reduce the service life of the heat exchanger. The 3-m minimum distance between the furnace and the outdoor air duct connection is one means of addressing this concern. However, a well designed mixing device is likely to be more effective, as are certain arrangements of the outdoor air duct’s connection to the return air plenum. Figures A-9.32.3.4.-A, A-9.32.3.4.-B, and A-9.32.3.4.-C illustrate one such device and arrangements that have been shown to be effective in research carried out by Canada Mortgage and Housing Corporation (“Testing of Fresh Air Mixing Devices,” IRTA Research for Research Division of CMHC, March 1993).



**Figure A-9.32.3.4.-A**  
Simple air mixing device



**Figure A-9.32.3.4.-B**  
Outdoor air duct directly connected to drop plenum – inner side of corner



**Figure A-9.32.3.4.-C**  
**Outdoor air duct directly connected to drop plenum – outer side of corner**

Even if the outdoor air is well mixed with the return air, in very cold weather the resulting mixed air temperature could still be lower than what the furnace heat exchanger can tolerate if there is too much outdoor air. That is why Article 9.32.3.4. includes several provisions, including Table 9.32.3.4. and the requirement to actually measure the outdoor airflow [see Sentence 9.32.3.4.(10)], to guard against this possibility. In some cases, it will not be possible to use the forced air heating system to circulate the outdoor air unless additional heating devices are used to temper the outdoor air before it reaches the furnace heat exchanger. This would be the case, for example, in a highly insulated house with a small furnace that is located in a very cold region.

The maximum outdoor airflow permitted by Table 9.32.3.4. must equal or exceed the “normal operating exhaust capacity” of the principal ventilation fan, as determined in accordance with Sentence 9.32.3.3.(2); otherwise there is an increased possibility that the mixed airflow over the furnace heat exchanger in cold weather will be colder than what the heat exchanger can tolerate. No values are listed in Table 9.32.3.4. when the maximum flow permitted exceeds the maximum capacity found in Table 9.32.3.3. since no higher outdoor airflow is required to match the flow of the principal ventilation fan.

Sentence 9.32.3.3.(9) is intended to avoid having the principal ventilation fan exhaust the outdoor air brought in through the outdoor air supply duct before it is circulated to the dwelling. The design of some advanced integrated mechanical systems is such that some portion of the outdoor air is exhausted before being circulated but this is taken into account in the design of the system and the total amount of outdoor air brought in is adjusted accordingly. This provision is not intended to preclude the use of such systems.

The duct bringing outdoor air to the furnace return air plenum must be equipped with a manual damper [see Sentence 9.32.3.4.(6)] that is adjusted [see Sentence 9.32.3.4.(10)] to balance the outdoor airflow with the flow through the principal ventilation fan. It is recommended, but not mandatory, that a motorized damper also be installed in this duct and that it be wired to be fully open when the principal ventilation fan is operating and fully closed when the principal ventilation fan is not operating. This damper will allow ventilation to occur only when the occupants have called for it by turning the “Ventilation Fan” switch to “on.” The absence of such a damper can lead to unwanted ventilation, which can result, in turn, in excessive dryness and increased heating costs in winter, and increased loading on air-conditioning equipment in the summer.

**A-9.32.3.5. Ventilation Systems Not Used in Conjunction with Forced Air Heating**

**Systems.** If there is no forced air heating system or if, for some reason, the heating system is not used to distribute the outdoor air, then a special air distribution system must be installed. Because such a system only handles ventilation air and not heating distribution air, smaller ducts can generally be used and the supply fan is quite a bit smaller than a normal furnace circulation fan. Sentences 9.32.3.5.(2) to (7) require that the supply fan operate at the same time and at the same rate as the principal ventilation fan in order to avoid either pressurizing or depressurizing the house. Pressurizing the house can lead to interstitial condensation within the building envelope. Depressurization can lead to the spillage of combustion products from heating equipment and increased entry of soil gas.

**Tempering of Outdoor Air**

The system described in Article 9.32.3.5. requires that the outdoor air be tempered before being circulated to the occupied areas of the house [see Sentence 9.32.3.5.(8)]. Tempering can be accomplished by passing the outdoor air over some type of heating element or by mixing it with indoor air. However, the latter approach is more complex, since it requires that the ratio between the outdoor air and indoor air ducts or openings be neither too large nor too small. It was judged to be too complex to include within the context of these prescriptive requirements. Therefore, where tempering by mixing with indoor air is chosen, the system must be designed in accordance with CAN/CSA-F326-M, "Residential Mechanical Ventilation Systems."

**Distribution of Outdoor Air**

Whereas a duct system associated with a forced air heating system would have ducts leading to almost all rooms, the requirements for these ventilation systems are more limited [see Sentences 9.32.3.5.(10) to (14)]. The most important point is that outdoor air must be provided to each bedroom; people often spend long periods of time in the bedroom with the door closed. It is also required that at least one duct lead to every storey, including the basement.

In houses where there is no storey without a bedroom (e.g. bungalows with no basement), a duct must lead to the principal living area. Where there is more than one area that could be considered as a "living area," at least one such area must be designated as the "principal living area."

There is also the alternative of locating one of the exhaust air intakes for the principal ventilation fan in the principal living area, rather than supplying outdoor air directly to it; in this arrangement, the outdoor air will pass through the principal living area on its way to the exhaust fan. However, this arrangement will be less effective if only a small portion of the exhaust is withdrawn from the principal living area; thus, there is a limitation on the number of other exhaust air intakes for the principal ventilation fan [see Sentence 9.32.3.5.(11)].

**A-9.32.3.6. Exhaust-Only Ventilation Systems.** If a house does not incorporate any provision for the introduction of outdoor air, the air extracted by the principal ventilation fan will be replaced by outdoor air leaking in through the building envelope. The house will be depressurized by operation of the principal ventilation fan, and the negative internal pressure will draw outdoor air inside through any available opening. See Figure A-9.32.3.6.

This need not be of concern if the house also does not incorporate any spillage-susceptible combustion equipment. Such a system is significantly simpler in that the concern about too-cold air contacting the furnace heat exchanger is eliminated. However, in an exhaust-only system there is no control over where the outdoor air enters; e.g., the majority of envelope leaks could be into an infrequently occupied basement. Thus it is required that houses using this system have an air distribution system so that, no matter where the outdoor air comes in, it will be mixed with the indoor air and circulated throughout the house. A forced air heating system complying with Section 9.33. satisfies the criteria for the air distribution system in Clause 9.32.3.6.(1)(b).

In a house with a very airtight building envelope, it may be difficult for the principal ventilation fan to achieve its full rated flow capacity due to high levels of house depressurization. Therefore fans used as the principal ventilation fan in an exhaust-only ventilation system are required to have their flow rated at a higher static pressure [see Sentence 9.32.3.10.(3)]. See Figure A-9.32.3.6.

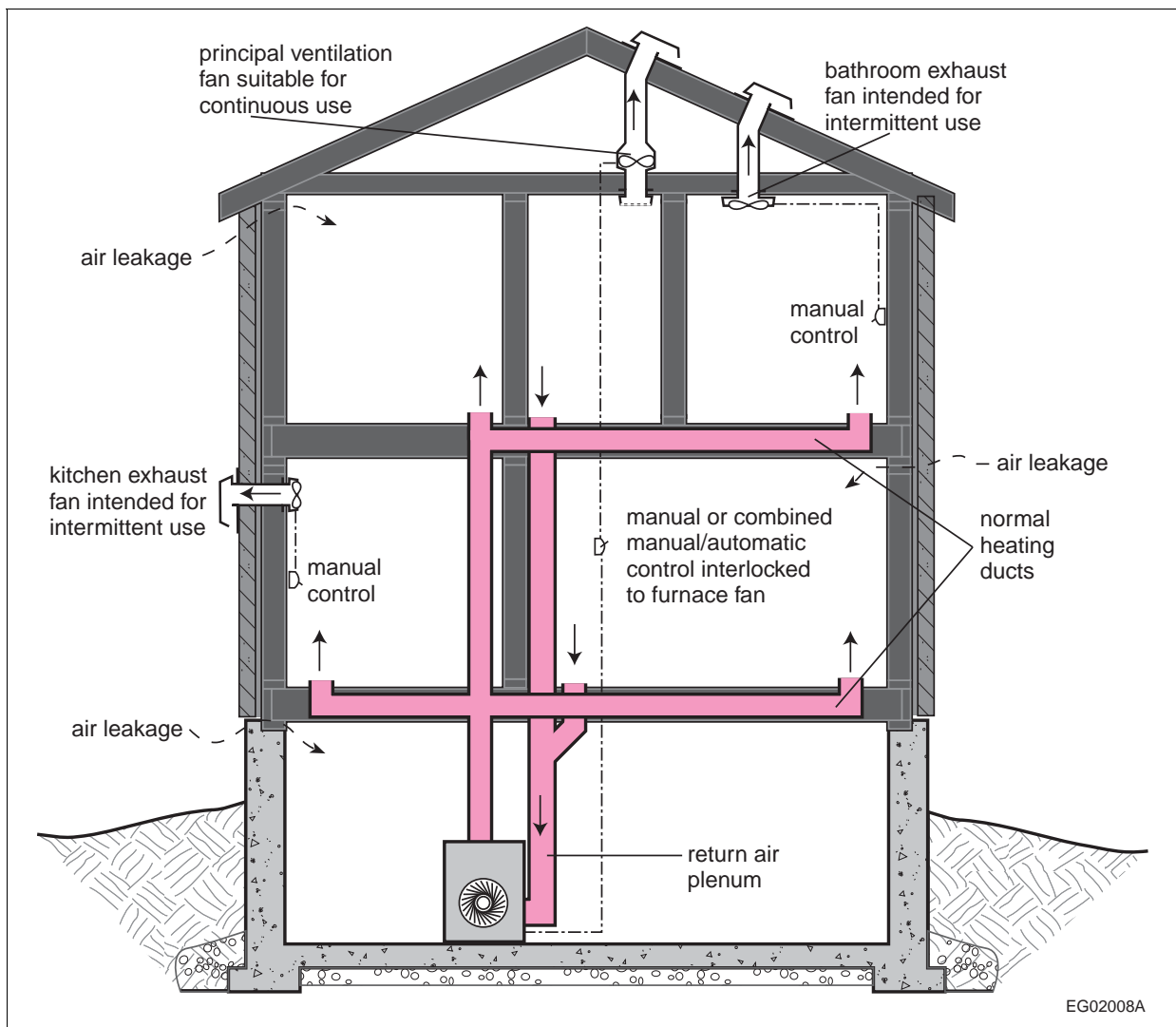


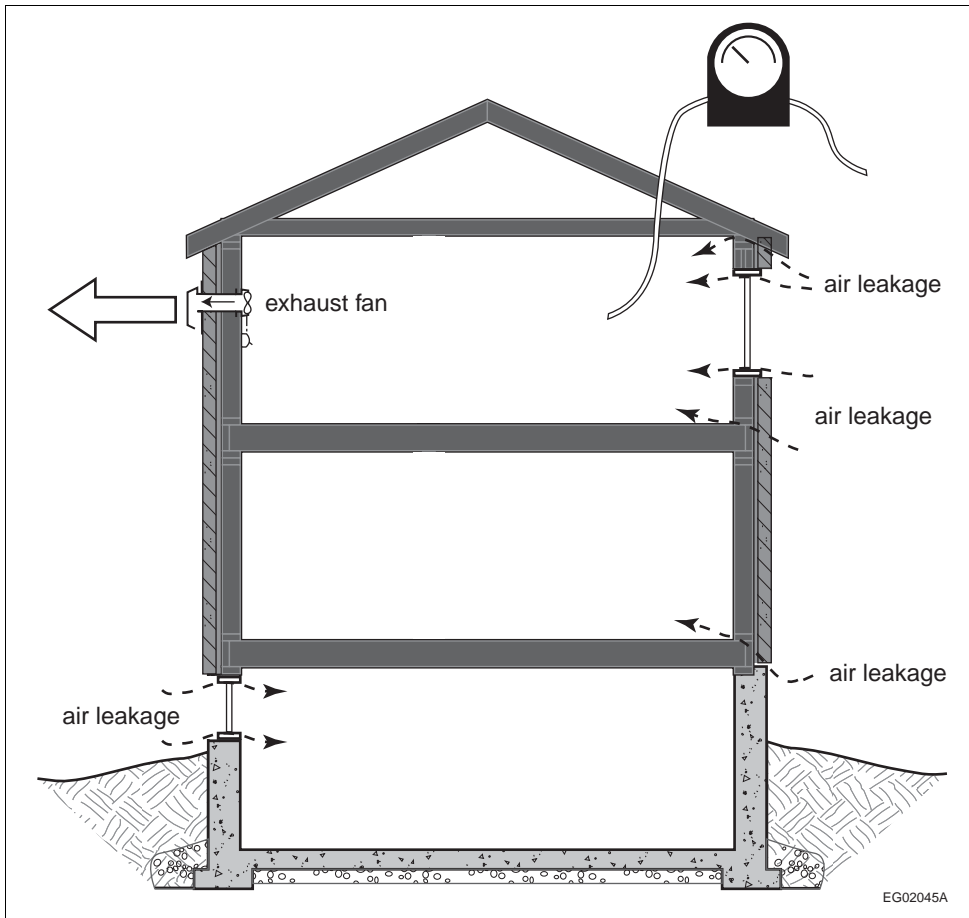
Figure A-9.32.3.6. Possible configuration of an exhaust-only ventilation system coupled with a forced air heating system

**A-9.32.3.7. Supplemental Exhaust.** CAN/CSA-F326-M, “Residential Mechanical Ventilation Systems,” requires a certain amount of exhaust from kitchens to capture pollutants at the source. When the principal ventilation fan air intake is not located in the kitchen, a separate kitchen exhaust fan must be installed [see Sentence 9.32.3.7.(1)]. However, when the principal ventilation fan is located in the kitchen but is connected to multiple inlets, there will not be enough exhaust from the kitchen. Therefore, a separate kitchen exhaust fan is required in this circumstance as well, unless the exhaust rate of the principal ventilation fan can be increased when additional kitchen ventilation is needed [see Sentence 9.32.3.7.(3)].

The bathroom is another possible location for an air intake of a principal ventilation fan. As with the kitchen, if this option is not chosen, a separate bathroom exhaust fan must be installed [see Sentence 9.32.3.7.(4)].

Supplemental exhaust fans, which in most instances are located in kitchens and bathrooms, are required to be coupled to supply fans of similar capacity. The make-up air is necessary so that operation of the supplementary exhaust fan(s) will not depressurize the house [see Sentence 9.32.3.8.(2)]. See also Note A-9.32.3.8.

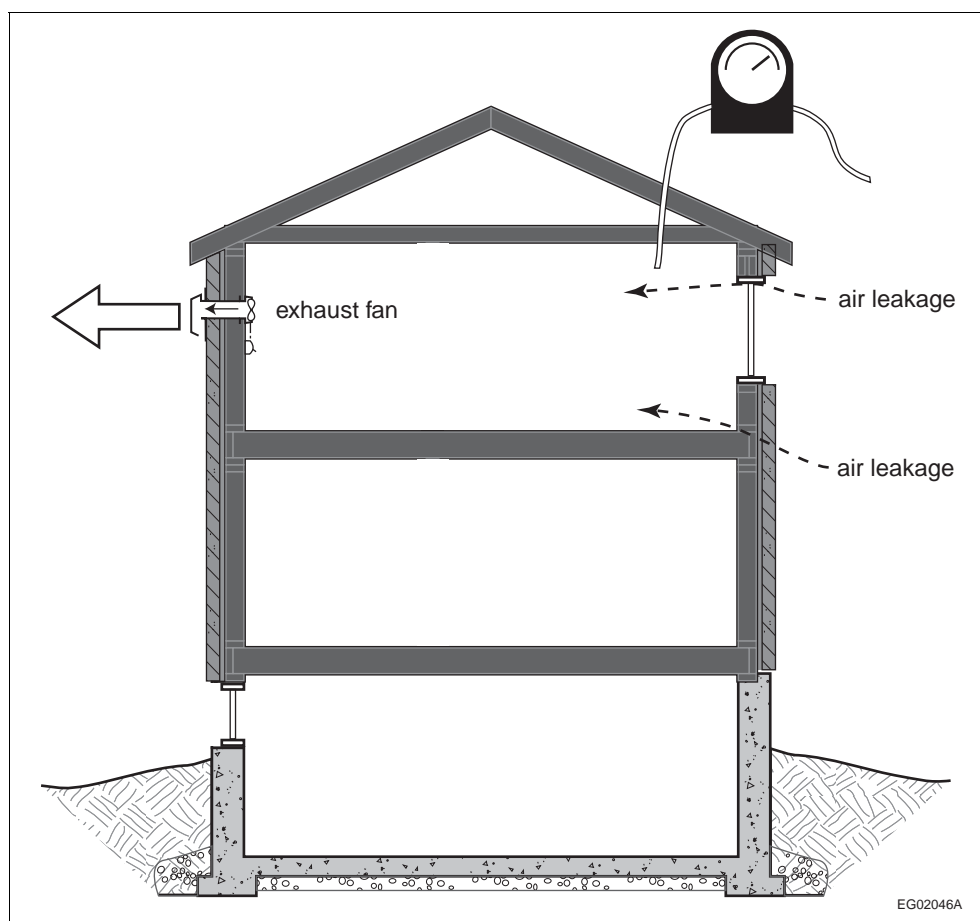
**A-9.32.3.8. Protection against Depressurization.** When an exhaust device extracts air from a house and there are no provisions for the introduction of outdoor air, such as by means of an outdoor air duct as required by Articles 9.32.3.4. and 9.32.3.5., and no supply fans are operating simultaneously, the exhausted air will automatically be replaced by outdoor air that has infiltrated through the house’s building envelope. The rate of inward leakage will automatically equal the rate of outward extraction: otherwise the house would eventually implode. The instant the exhaust device is turned on, the house pressure is lowered and the inside/outside pressure difference drives outdoor air in through any leaks it can find. See Figure A-9.32.3.8.-A.



**Figure A-9.32.3.8.-A**  
**Outdoor air drawn through a leaky envelope**

Even if the house is made more airtight, the inward leakage will equal the outward fan flow. However, because there are fewer and/or smaller leakage sites in an airtight house, it will take a larger inside/outside pressure difference to drive the same amount of air through the remaining leakage sites. See Figure A-9.32.3.8.-B.





**Figure A-9.32.3.8.-B**  
**Outdoor air drawn through a tighter envelope**

It is possible that the exhaust device will no longer be able to achieve its rated flow when operating against a very high inside/outside pressure difference. However, in this case, the inward flow will also decrease and will still be in equilibrium with the outward flow, but now at a higher inside/outside pressure difference than in a leakier house.

An exhaust device not operated in conjunction with a supply fan will always depressurize a house to some extent—even a leaky house. But it will depressurize a tight house more than it will depressurize a leaky house. And, of course, an exhaust device with a higher capacity will depressurize a house more than a device with a smaller capacity.

### Spillage of Combustion Products

Depressurization of the house by the ventilation system or other exhaust devices can cause the spillage of combustion products from certain types of combustion appliances. The types of appliances that are susceptible to pressure-induced spillage can generally be identified by the fact that they are vented through a natural draft chimney rather than through an arrangement that uses a fan to draw the products of combustion out of the house. Naturally aspirated gas furnaces with draft hoods and oil furnaces with barometric dampers are examples of spillage-susceptible appliances.

On the other hand, some gas furnaces with induced draft venting systems and the “sealed combustion” oil furnaces commonly used in mobile homes, are more resistant to spillage. Terms used in gas appliance standards to describe categories of spillage-resistant appliances include “direct-vented” and “side-wall-vented.”

Almost all fireplaces are spillage-susceptible, even those with so called “airtight” glass doors and outside combustion air intakes, since most “airtight” doors are not really airtight. Certain types of gas combustion appliances, such as cooking appliances and “decorative appliances,” are not required to be vented. Their operation will not be significantly affected by depressurization of the house.

The NBC addresses the potential for spillage from combustion appliances with requirements for:

- makeup air, and
- carbon monoxide alarms.

### Makeup Air Requirements

Depressurization caused by the principal ventilation system itself is not an issue in houses with balanced systems (that is, non-exhaust-only systems). However, the operation of other exhaust devices, such as stove-top barbecues, can cause depressurization. Therefore, in a house with spillage-susceptible appliances, any such exhaust devices, including the required supplemental exhaust fans, must be provided with makeup air [see Sentence 9.32.3.8.(2)].

In the past, the NBC and other codes and standards have tended to rely on the passive supply of makeup air through makeup air openings. This is no longer considered to be a reliable approach in the context of a simple, prescriptively described system without sophisticated controls on depressurization. Therefore, the makeup air must be provided by a supply fan that is automatically activated whenever the exhaust device that requires the makeup air is activated [see Sentences 9.32.3.8.(2) and (3)].

The need for makeup air can be avoided by not using spillage-susceptible combustion equipment.

### Carbon Monoxide Alarm Requirements for Solid-Fuel-Burning Appliances

Even at a relatively low level of depressurization, certain open-type solid-fuel-burning appliances, such as fireplaces, or even closed-type solid-fuel-burning appliances whose stoking doors are left open, can spill products of combustion into the house when operating in their “die down” or smouldering stages. In the absence of more sophisticated design and installation controls to prevent such levels of depressurization (such as those mentioned in CAN/CSA-F326-M, “Residential Mechanical Ventilation Systems,” the only available safeguard is to require the installation of a carbon monoxide (CO) alarm in any room incorporating a solid-fuel-burning device [see Sentence 9.32.3.9.(3)]. Where this is not acceptable, the prescriptively described alternatives must be abandoned and a system fully complying with CAN/CSA-F326-M must be designed.

One advantage of solid-fuel-burning devices is that their spillage is readily detected by a carbon monoxide alarm (which is not true of gas- or oil-burning devices). Therefore, where this is the only type of spillage-susceptible combustion device present, one has the choice of not providing makeup air for exhaust devices [see Sentence 9.32.3.8.(6)]: the carbon monoxide alarm required by Sentence 9.32.3.9.(3) will warn occupants when depressurization is causing spillage.

Battery-operated carbon monoxide alarms are permitted, but they must be mechanically fixed to a surface.

See also Note A-9.32.3.9.

**A-9.32.3.9. Carbon Monoxide Alarms.** Carbon monoxide (CO) is a colourless, odourless gas that can build up to lethal concentrations in an enclosed space without the occupants being aware of it. Thus, where an enclosed space incorporates or is near a potential source of CO, it is prudent to provide some means of detecting its presence.

Dwelling units have two common potential sources of CO:

- fuel-fired space- or water-heating equipment within the dwelling unit or in adjacent spaces within the building, and
- attached storage garages.

Most fuel-fired heating appliances do not normally produce CO and, even if they do, it is normally conveyed outside the building by the appliance’s venting system. Nevertheless, appliances can malfunction and venting systems can fail. Therefore, the provision of appropriately placed CO alarms in the dwelling unit is a relatively low-cost back-up safety measure.

Similarly, although Article 9.10.9.16. requires that the walls and floor/ceiling assemblies separating attached garages from dwelling units incorporate an air barrier system, there have been several instances of CO from garages being drawn into houses, which indicates that a fully gas-tight barrier is difficult to achieve. The likelihood of preventing the entry of all CO is decreased if the dwelling unit is depressurized in relation to the garage. This can readily occur due to the operation of exhaust equipment or simply due to the stack effect created by heating the dwelling unit. Again, CO alarms in the dwelling unit provide a relatively low-cost back-up safety measure.

See also Note A-9.32.3.8.

**A-9.32.3.10. Fans.** The principal ventilation fan is intended to be run for long periods. Even the supplemental exhaust fans may be used for significant periods. Therefore, all fans that are mounted such that their sound is likely to intrude on the household, other than kitchen exhaust fans, are required to have reasonably low sound ratings so that building occupants will not turn them off before the need for ventilation has been met.

**A-9.32.3.11. Ducts.** Table 9.32.3.11.-A is based on the data listed in Table 9, "Friction Chart for Round Ducts," Chapter 32, of the ASHRAE Handbook of Fundamentals 1997. The allowable duct lengths listed in the Table have been calculated assuming the "equivalent lengths" of ducts are four times their physical lengths. The static pressure offset to account for building pressures is 10 Pa. Using Table 9.32.3.11.-A will generally result in very conservatively sized (i.e. larger) ducts compared to what would be achieved using the normal duct design procedures referenced in Subsection 9.33.4.

**A-9.32.3.12. Heat Recovery Ventilators.** Enthalpy recovery ventilators (ERVs) are a type of heat recovery ventilator and must therefore comply with the requirements of Article 9.32.3.12.

**A-9.33.1.1.(2) Combustion Air and Tight Houses.** The operation of an air exhaust system or of a fuel-burning appliance removes the air from a house, creating a slight negative pressure inside. In certain cases the natural flow of air up a chimney can be reversed, leading to a possible danger of carbon monoxide poisoning for the inhabitants.

Newer houses are generally more tightly constructed than older ones because of improved construction practices, including tighter windows, weather stripping and caulking. This fact increases the probability that infiltration may not be able to supply enough air to compensate for simultaneous operation of exhaust fans, fireplaces, clothes dryers, furnaces and space heaters. It is necessary, therefore, to introduce outdoor air to the space containing the fuel-burning appliance. Information regarding combustion air requirements for various types of appliances can be found in the installation standards referenced in Sentences 6.2.1.5.(1) and 9.33.5.2.(1). In the case of solid-fuel-burning stoves, ranges and space heaters, CSA B365, "Installation Code for Solid-Fuel-Burning Appliances and Equipment," suggests that the minimum size of openings be determined by trial and error to accommodate the flue characteristics, the firing rate, the building characteristics, etc., and that, as a guide, the combustion air opening should be 0.5 times the flue collar area.

Further information can be found in CBD 222, "Airtight Houses and Carbon Monoxide Poisoning," which is available from NRC.

**A-9.33.4.3.(1) Heating System Controls.** Where a single heating system serves two dwelling units and common spaces in a house with a secondary suite, it must be possible for the occupants to control the temperature in their own suites. Sentence 9.33.4.3.(1), which applies only to electric, fuel-fired or unitary heaters and hydronic heating systems, specifies that separate temperature controls must be provided in each dwelling unit in a house with a secondary suite; however, the controls for shared spaces may be located in those spaces or in one of the suites.

**A-9.33.5.3. Design, Construction and Installation Standard for Solid-Fuel-Burning Appliances.** CSA B365, "Installation Code for Solid-Fuel-Burning Appliances and Equipment," is essentially an installation standard, and covers such issues as accessibility, air for combustion and ventilation, chimney and venting, mounting and floor protection, wall and ceiling clearances, installation of ducts, pipes, thimbles and manifolds, and control and safety devices. But the standard also includes a requirement that solid-fuel-burning appliances and equipment satisfy the requirements of one of a series of standards, depending on the appliance or equipment, therefore also making it a design and construction standard. It is required that cooktops and ovens as well as stoves, central furnaces and other space heaters be designed and built in conformity with the relevant referenced standard.

**A-9.33.6.13. Return Air System.** It is a common practice to introduce outdoor air to the house by means of an outdoor air duct connected to the return air plenum of a forced air furnace. This is an effective method and is a component of one method of satisfying the mechanical ventilation requirements of Subsection 9.32.3. However, some caution is required. If the proportion of cold outside to warm return air is too high, the resulting mixed air temperature could lead to excessive condensation in the furnace heat exchanger and possible premature failure of the heat exchanger. CAN/CSA-F326-M, "Residential Mechanical Ventilation Systems," requires that this mixed air temperature not be below 15.5°C when the outdoor temperature is at the January 2.5% value. It is also important that the outdoor air and the return air mix thoroughly before reaching the heat exchanger. Note A-9.32.3. provides some guidance on this.

**A-9.33.10.2.(1) Factory-Built Chimneys.** Under the provisions of Article 1.2.1.1. of Division A, certain solid-fuel-burning appliances may be connected to factory-built chimneys other than those specified in Sentence 9.33.10.2.(1) if tests show that the use of such a chimney will provide an equivalent level of safety.

**A-9.34.2. Lighting Outlets.** The “Canadian Electrical Code, Part I” contains requirements relating to lighting that are similar to those in the NBC. However, the Electrical Code requirements apply only to residential occupancies, whereas many of the requirements in the NBC apply to all Part 9 buildings. Code users must therefore be careful to ensure that all applicable provisions of the NBC are followed, irrespective of the limitations in the Electrical Code.

**A-9.35.2.2.(1) Garage Floor.** Sources of ignition, such as electrical wiring and appliances, can set off an explosion if exposed to gases or vapours such as those that can be released in garages. This provision applies where the frequency and concentration of such releases are low. Where the garage can accommodate more than 3 vehicles, and where wiring is installed within 50 mm of the garage floor, the “Canadian Electrical Code, Part I” should be consulted as it specifies more stringent criteria for wiring.

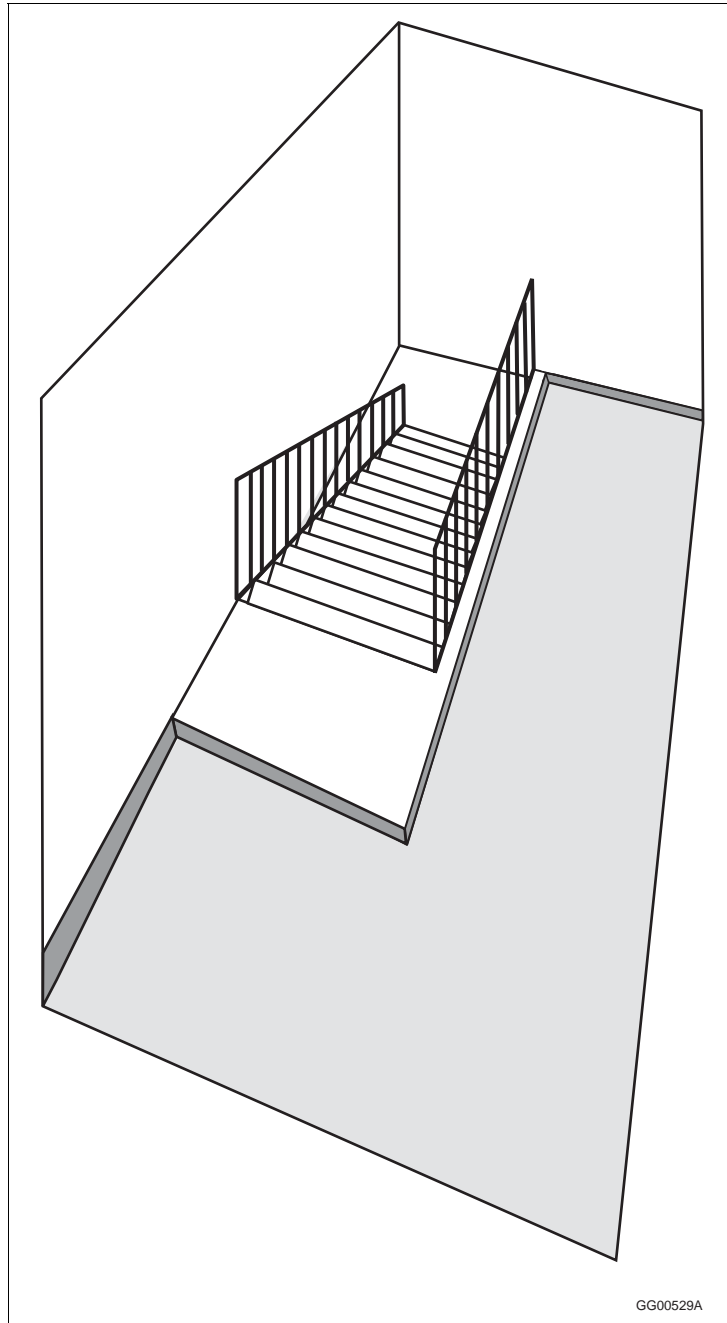
The capacity of the garage is based on standard-size passenger vehicles such as cars, mini-vans and sport utility vehicles, and half-ton trucks. In a typical configuration, the capacity of the garage is defined by the width of the garage doors—generally single or double width—which correlates to the number of parking bays.

In many constructions, floor areas adjacent to the garage are either above the garage floor level or separated from it by a foundation wall. Where the foundation wall is cast-in-place concrete and rises at least 50 mm above the garage floor, it can serve as the airtight curb. Where the foundation wall is block or preserved wood, extra measures may be needed to provide airtightness. In many instances, the construction will be required to be airtight to conform with Sentence 9.25.3.1.(1), and in any case, must comply with Sentences 9.10.9.16.(4) and (5).

Where the space adjacent to the garage is at the same level as the garage, a 50 mm curb or partition is not needed if the wall complies with Sentences 9.10.9.16.(4) and (5), and there is no connecting door. Where there is a connecting door, it must be raised at least 50 mm off the floor or be installed so it closes against the curb.

In some instances, access to the basement is via a stair from the garage. In such cases, a curb must be installed at the edge of the garage floor area and must be sealed to the foundation wall, curb or partition between the garage and adjacent spaces.

See Figure A-9.35.2.2.(1).



**Figure A-9.35.2.2.(1)**  
**Curb around garage floor at stairs**

Copyright © NRC 1941 - 2021 World Rights Reserved © CNRC 1941-2021 Droits réservés pour tous pays

**A-9.36.1.1.(1) Energy Used by the Building.**

- Energy used by the building = space-heating energy lost and gained through building envelope  
 + losses due to inefficiencies of heating equipment  
 + energy necessary to heat outdoor air to ventilate the building  
 + energy used to heat service water

**A-9.36.1.2.(2) Overall Thermal Transmittance.** The U-value represents the amount of heat transferred through a unit area in a unit of time induced under steady-state conditions by a unit temperature difference between the environments on its two faces. The U-value reflects the capacity of all elements to transfer heat through the thickness of the assembly, as well as, for instance, through air films on both faces of above-ground components. Where heat is not transferred homogeneously across the area being considered, the thermal transmittance of each component is determined: for example, the thermal transmittance values of the glazing and the frame of a window are combined to determine the overall thermal transmittance (U-value) of the window.

**A-9.36.1.2.(3) Conversion of Metric Values to Imperial Values.** To convert a metric RSI value to an imperial R-value, use  $1 \text{ (m}^2\text{-K)/W} = 5.678263 \text{ h} \cdot \text{ft}^2 \cdot \text{°F/Btu}$ . “R-value,” or simply the prefix “R” (e.g. R20 insulation), is often used in the housing industry to refer to the imperial equivalent of “RSI value.” Note that R-values in Section 9.36. are provided for information purposes only; the stated metric RSI values are in fact the legally binding requirements.

**A-9.36.1.2.(4) Fenestration.** The term “fenestration” is intentionally used in Articles 9.36.2.3. (prescriptive provisions) and 9.36.2.11. (trade-off provisions), and in Subsection 9.36.5. (performance provisions) as opposed to the terms “window,” “door” and “skylight,” which are used in the prescriptive provisions in Subsections 9.36.2. to 9.36.4. that address these components individually. The term “fenestration” is sometimes used in conjunction with the term “doors” depending on the context and the intent of the requirement.

**A-9.36.1.3. Compliance Options According to Building Type and Size.** Table A-9.36.1.3. describes the types and sizes of Part 9 buildings to which Section 9.36. and the NECB apply.

**Table A-9.36.1.3.**  
**Energy Efficiency Compliance Options for Part 9 Buildings**  
 Forming Part of Note A-9.36.1.3.

Building Types and Sizes	Energy Efficiency Compliance Options		
	NBC 9.36.2. to 9.36.4. (Prescriptive)	NBC 9.36.5. (Performance)	NECB
<ul style="list-style-type: none"> <li>houses with or without a secondary suite</li> <li>buildings containing only dwelling units with common spaces ≤ 20% of building's total floor area<sup>(1)</sup></li> </ul>	✓	✓	✓
<ul style="list-style-type: none"> <li>Group C occupancies</li> <li>buildings containing Group D, E or F3 occupancies whose combined total floor area ≤ 300 m<sup>2</sup> (excluding parking garages that serve residential occupancies)</li> <li>buildings with a mix of Group C and Group D, E or F3 occupancies where the non-residential portion's combined total floor area ≤ 300 m<sup>2</sup> (excluding parking garages that serve residential occupancies)</li> </ul>	✓	X	✓
<ul style="list-style-type: none"> <li>buildings containing Group D, E or F3 occupancies whose combined total floor area &gt; 300 m<sup>2</sup></li> <li>buildings containing F2 occupancies of any size</li> </ul>	X	X	✓

**Notes to Table A-9.36.1.3.:**

(1) The walls that enclose a common space are excluded from the calculation of floor area of that common space.

**A-9.36.1.3.(3) Houses and Common Spaces.****Houses**

For the purpose of Sentence 9.36.1.3.(3), the term “houses” includes detached houses, semi-detached houses, duplexes, triplexes, townhouses, row houses and boarding houses.

**Common spaces**

The walls that enclose a common space are excluded from the calculation of floor area of that common space.

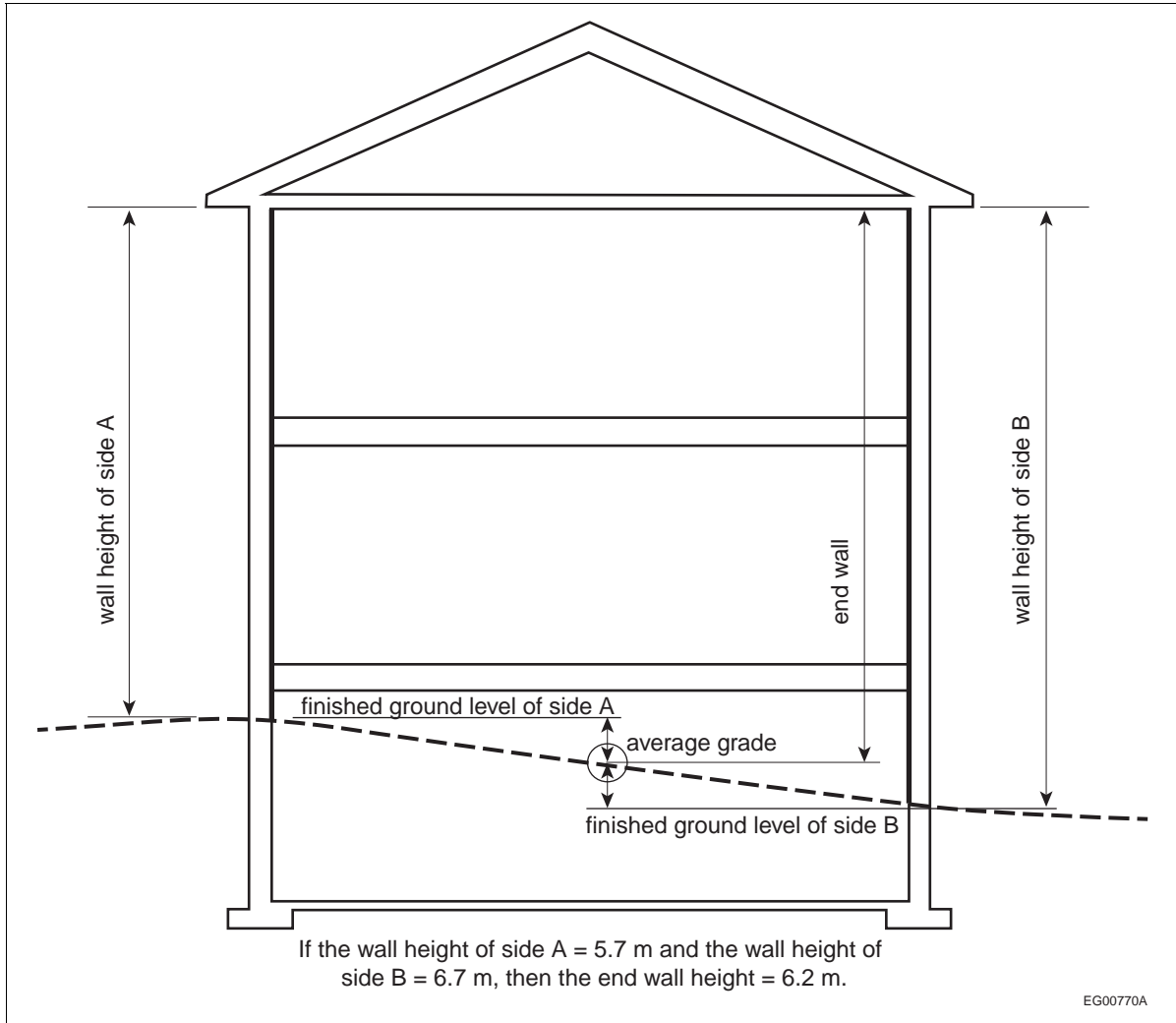
**A-9.36.1.3.(5) Exemptions.** Examples of buildings and spaces that are exempted from the requirements of Section 9.36. include seasonally heated buildings, storage and parking garages, small service buildings or service rooms and unconditioned spaces in buildings. However, note that, where a building envelope assembly of an exempted building is adjacent to a conditioned space, this assembly must meet the requirements of Section 9.36.

**A-9.36.2.1.(2) Wall or Floor between a Garage and a Conditioned Space.** A wall or a floor between a conditioned space and a residential garage must be airtight and insulated because, even if the garage is equipped with space-heating equipment, it may in fact be kept unheated most of the time.

**A-9.36.2.2.(3) Calculation Tools.** The thermal characteristics of windows, doors and skylights can be calculated using software tools such as THERM and WINDOW.

**A-9.36.2.2.(5) Calculating Effective Thermal Resistance of Log Walls.** ICC 400, “Design and Construction of Log Structures,” defines log wall thickness as the “average cross sectional area divided by the stack height.” This approach equalizes all log profiles regardless of their size or shape by eliminating the need to vary, average or round out log thickness measurements, which would otherwise be necessary to determine applicable profile factors for different log shapes. The ICC 400 standard lists R-values for log walls, including the exterior and interior air film coefficients, based on wall thickness and wood species’ specific gravity.

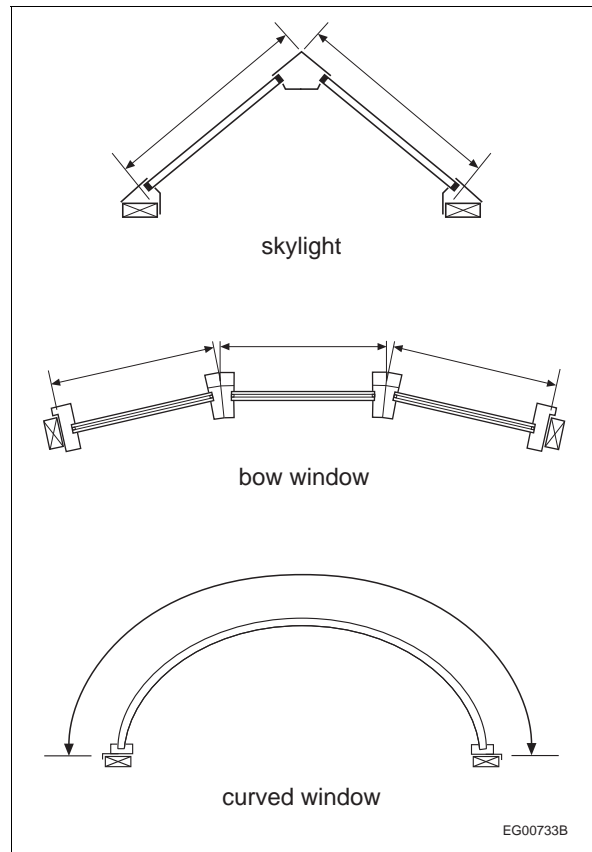
**A-9.36.2.3.(2) and (3) Calculating Gross Wall Area.** Where the structure of the lowest floor and rim joist assembly is above the finished ground level or where the above-grade portion of foundation walls separates conditioned space from unconditioned space, they should be included in the calculation of gross wall area. Figure A-9.36.2.3.(2) and (3) shows the intended measurements for the most common type of housing construction.



**Figure A-9.36.2.3.(2) and (3)**  
**Example of interior wall height to be used in the calculation of gross wall area**



**A-9.36.2.3.(5) Areas of Other Fenestration.** Figure A-9.36.2.3.(5) illustrates how to measure the area of glass panes as described in Sentence 9.36.2.3.(5).



**Figure A-9.36.2.3.(5)**  
Measuring the area of glazing that is not in the same plane

**A-9.36.2.4.(1) Calculating the Effective Thermal Resistance of Building Envelope Assemblies.** The general theory of heat transfer is based on the concept of the thermal transmittance through an element over a given surface area under the temperature difference across the element (see Sentence 9.36.1.2.(2)). As such, the NECB requires all building envelope assemblies and components to comply with the maximum U-values (overall thermal transmittance) stated therein. However, the requirements in Subsection 9.36.2. are stated in RSI values (effective thermal resistance values), which are the reciprocal of U-values.

To calculate effective thermal resistance, Section 9.36. requires that contributions from all portions of an assembly—including heat flow through studs and insulation—be taken into account because the same insulation product (nominal insulation value) can produce different effective thermal resistance values in different framing configurations. The resulting effective thermal resistance of an assembly also depends on the thermal properties and thickness of the building materials used and their respective location.

The following paragraphs provide the calculations to determine the effective thermal resistance values for certain assemblies and the thermal characteristics of common building materials. The Tables in Notes A-9.36.2.6.(1) and A-9.36.2.8.(1) confirm the compliance of common building assemblies.

**Calculating the Effective Thermal Resistance of an Assembly with Continuous Insulation: Isothermal Planes Method**

To calculate the effective thermal resistance of a building envelope assembly containing only continuous materials—for example, a fully insulated floor slab— simply add up the RSI values for each material. This procedure is described as the “isothermal-planes method” in the “ASHRAE Handbook – Fundamentals.”

### Calculating the Effective Thermal Resistance of a Wood-frame Assembly: Isothermal-Planes and Parallel-Path Flow Methods

To calculate the effective thermal resistance of a building envelope assembly containing wood framing,  $RSI_{eff}$ , add up the results of the following calculations:

- A. calculate the effective thermal resistance of all layers with continuous materials using the isothermal-planes method, and
- B. calculate the effective thermal resistance of the framing portion,  $RSI_{parallel}$ , using the following equation, which is taken from the parallel-path flow method described in the "ASHRAE Handbook – Fundamentals":

$$RSI_{parallel} = \frac{100}{\frac{\% \text{ area of framing}}{RSI_F} + \frac{\% \text{ area of cavity}}{RSI_C}}$$

where

$RSI_F$  = thermal resistance of the framing member obtained from Table A-9.36.2.4.(1)-D,

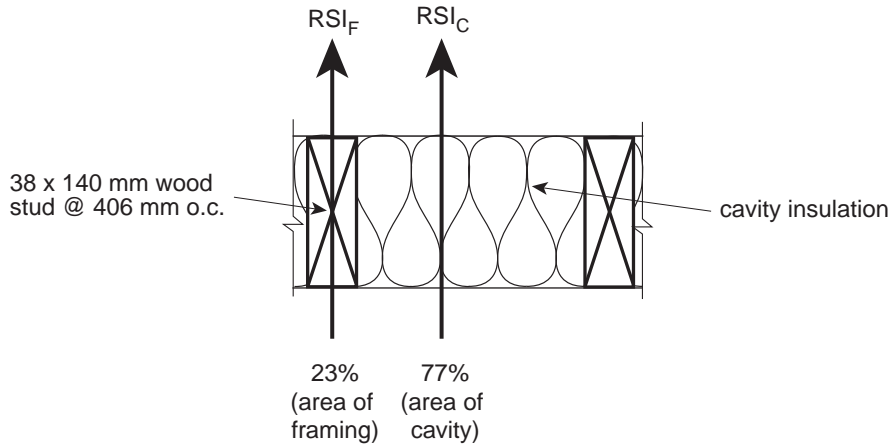
$RSI_C$  = thermal resistance of the cavity (usually filled with insulation) obtained from Table A-9.36.2.4.(1)-D,

% area of framing = value between 0 and 100 obtained from Table A-9.36.2.4.(1)-A or by calculation, and

% area of cavity = value between 0 and 100 obtained from Table A-9.36.2.4.(1)-A or by calculation.

When the values in Table A-9.36.2.4.(1)-D are used in the calculation of effective thermal resistance of assemblies, they must not be rounded; only the final result,  $RSI_{eff}$ , can be rounded to the nearest significant digit.

Example of Calculation of  $RSI_{eff}$  for a Typical 38 x 140 mm Wood-frame Wall Assembly Using the Isothermal Planes and Parallel-Path Flow Methods



EG00775A

1. Determine the thermal resistance of each continuous material layer incorporated in the assembly using Table A-9.36.2.4.(1)-D
2. Calculate the thermal resistance of a section of framing and adjacent cavity portion,  $RSI_{parallel}$ , using the parallel-path flow method as follows:
  - (i) along a line that goes through the framing, which is designated  $RSI_F$ , and
  - (ii) along a line that goes through the cavity (usually filled with insulation), which is designated  $RSI_C$ .

Look up the % area of framing and cavity for a typical 38 x 140 mm wood-frame wall assembly with studs 400 mm o.c. using Table A-9.36.2.4.(1)-A:

% area of framing = 23%, and  
 % area of cavity = 77%

Then, combine the sums of  $RSI_F$  and  $RSI_C$  in proportion to the relative areas of framing and insulation to calculate the value of  $RSI_{parallel}$  (thermal resistance of the framing portion):

$$RSI_{parallel} = \frac{100}{\left(\frac{23}{1.19}\right) + \left(\frac{77}{3.34}\right)} = 2.36 \text{ (m}^2 \cdot \text{K) / W} \quad (\text{U-value} = 0.42 \text{ W / (m}^2 \cdot \text{K)})$$

3. Add up the values obtained in steps 1 and 2 to determine the effective thermal resistance of the wall assembly,  $RSI_{eff}$ .

Layers in 38 x 140 mm Wood-frame Wall Assembly with Studs Spaced 400 mm o.c.:			RSI, (m <sup>2</sup> ·K)/W
Outside air film			0.03
Metal siding			0.11
Sheathing paper			—
Gypsum sheathing (12.7 mm)			0.08
Stud (140 mm x 0.0085 RSI/mm)	$RSI_F = 1.19$	% area of framing = 23%	$RSI_{parallel} = 2.36$ (U-value = 0.42 W/(m <sup>2</sup> ·K))
Insulation (140 mm thick; RSI 3.34)	$RSI_C = 3.34$	% area of cavity = 77%	
Polyethylene (vapour barrier)			—
Gypsum (12.7 mm)			0.08
Interior air film			0.12
			$RSI_{eff} = 2.78 \text{ (m}^2 \cdot \text{K)/W}$ (U-value = 0.36 W/(m <sup>2</sup> ·K))

**Table A-9.36.2.4.(1)-A  
Framing and Cavity Percentages for Typical Wood-frame Assemblies<sup>(1)</sup>**

Wood-frame Assemblies		Frame Spacing, mm o.c.									
		304		406		488		610		1220	
		% Area Framing	% Area Cavity	% Area Framing	% Area Cavity	% Area Framing	% Area Cavity	% Area Framing	% Area Cavity	% Area Framing	% Area Cavity
Floors	lumber joists	–	–	13	87	11.5	88.5	10	90	–	–
	I-joists and truss	–	–	9	91	7.5	92.5	6	94	–	–
Roofs/ Ceilings	ceilings with typical trusses	–	–	14	86	12.5	87.5	11	89	–	–
	ceilings with raised heel trusses	–	–	10	90	8.5	91.5	7	93	–	–
	roofs with lumber rafters and ceilings with lumber joists	–	–	13	87	11.5	88.5	10	90	–	–
	roofs with I-joist rafters and ceilings with I-joists	–	–	9	91	7.5	92.5	6	94	–	–
	roofs with structural insulated panels (SIPs)	–	–	–	–	–	–	–	–	9	91
Walls	typical wood-frame	24.5	75.5	23	77	21.5	78.5	20	80	–	–
	advanced wood-frame with double top plate <sup>(2)</sup>	–	–	19	81	17.5	82.5	16	84	–	–
	SIPs	–	–	–	–	–	–	–	–	14	86
	basement wood-frame inside concrete foundation wall	–	–	16	84	14.5	85.5	13	87	–	–

**Notes to Table A-9.36.2.4.(1)-A:**

- (1) The framing percentages given in this Table account not just for the repetitive framing components but also for common framing practices, such as lintels, double top plates, cripple studs, etc., and include an allowance for typical mixes of studs, lintels and plates. The values listed represent the percentage of wall area taken up by framing and are based on the net wall area (i.e. gross wall area minus fenestration and door area). If the actual % areas of framing and cavity are known, those should be used rather than the ones in this Table. Rim joists are not accounted for in this Table because they are addressed separately in Sentence 9.36.2.6.(2).
- (2) “Advanced framing” refers to a variety of framing techniques designed to reduce the thermal bridging and therefore increase the energy efficiency of a building. Some advanced framing solutions require that some framing components be insulated or eliminated; in such cases, it may be appropriate to calculate the actual % area of framing. Note that using an advanced framing technique may require additional engineering of the framing system. The framing percentage values listed in this Table for advanced framing are based on constructions with insulated lintels or framing designed without lintels, corners with one or two studs, no cripple or jack studs, and double top plates.

**Calculating the Effective Thermal Resistance of a Steel-frame Assembly**

The parallel-path flow method described above for wood-frame assemblies involves simple one-dimensional heat flow calculations based on two assumptions:

- that the heat flow through the thermal bridge (the stud) is parallel to the heat flow through the insulation, and
- that the temperature at each plane is constant.

Tests performed on steel-frame walls have shown that neither of these assumptions properly represents the highly two-dimensional heat flow that actually occurs. The difference between what is assumed and what actually occurs is even more significant in steel-frame assemblies. The results achieved using the calculation method below compare well with those achieved from actual tests. The method provides a good approximation if a thermal resistance value of 0.0000161 (m<sup>2</sup>·K)/W per mm (or a conductivity of 62 (W·m)/(m<sup>2</sup>·°C)) is used (this value is associated with galvanized steel with a carbon content of 0.14%).

To calculate the effective thermal resistance of a building envelope assembly consisting of steel framing, RSI<sub>eff</sub> use the following equation:

$$RSI_{eff} = K_1 \cdot RSI_{T1} + K_2 \cdot RSI_{T3}$$

where

$RSI_{T1}$  = effective thermal resistance of building envelope assembly determined using parallel-path flow method for wood-frame assemblies (use framing and cavity percentages in Table A-9.36.2.4.(1)-C),

$RSI_{T3}$  =  $RSI_{T2}$  + thermal resistance values of all other components except steel studs and insulation, where  $RSI_{T2}$  = effective thermal resistance of steel studs and insulation determined using parallel-path flow method for wood-frame assemblies,

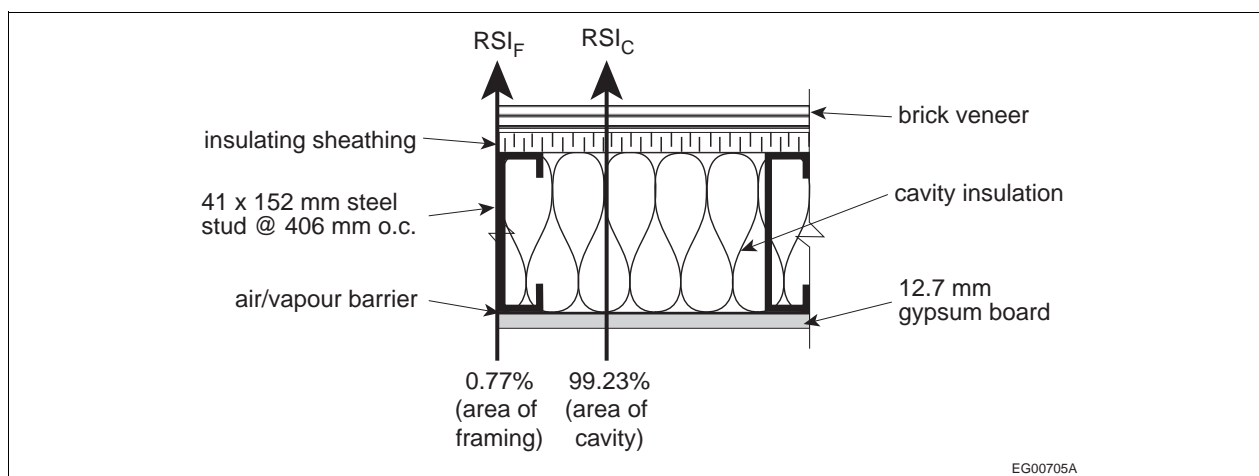
$K_1$  = applicable value from Table A-9.36.2.4.(1)-B, and

$K_2$  = applicable value from Table A-9.36.2.4.(1)-B.

**Table A-9.36.2.4.(1)-B  
Values for  $K_1$  and  $K_2$**

Framing Spacing, mm	$K_1$	$K_2$
< 500 without insulating sheathing	0.33	0.67
< 500 with insulating sheathing	0.40	0.60
≥ 500	0.50	0.50

**Example of Calculation of  $RSI_{eff}$  for a 41 x 152 mm Steel-frame Wall Assembly with Studs 406 mm o.c.**



EG00705A

**1. Calculate  $RSI_{T1}$**

Materials in Assembly	$RSI_F$ (thermal resistance through framing)	$RSI_C$ (thermal resistance through cavity)
Outside air film	0.03	0.03
Brick veneer	0.07	0.07
Air space (25 mm thick)	0.18	0.18
Extruded polystyrene (38 mm thick x RSI 0.035/mm)	1.33	1.33
Steel stud (152 mm thick x RSI 0.0000161/mm)	0.0023	—
Insulation (152 mm thick; RSI 3.52 (R20) batts)	—	3.52
Polyethylene (vapour barrier)	—	—
Gypsum (12.7 mm thick)	0.08	0.08
Interior air film	0.12	0.12
<b>Total</b>	<b>1.81</b>	<b>5.33</b>
% area framing and cavity from Table A-9.36.2.4.(1)-C	0.77%	99.23%

$$RSI_{T1} = \frac{100}{\left(\frac{0.77}{1.81}\right) + \left(\frac{99.23}{5.33}\right)} = 5.25 \text{ (m}^2 \cdot \text{K) / W} \quad (\text{U-value} = 0.19 \text{ W/(m}^2 \cdot \text{K)})$$

<b>2. Calculate RSI<sub>T2</sub></b>		
Materials in Assembly	RSI <sub>F</sub> (thermal resistance through framing)	RSI <sub>C</sub> (thermal resistance through cavity)
Steel stud (152 mm thick x RSI 0.0000161/mm)	0.0023	—
Insulation (152 mm thick; RSI 3.52 (R20) batts)	—	3.52
	Total	0.0023      3.52
% area framing and cavity from Table A-9.36.2.4.(1)-C	0.77%	99.23%
$RSI_{T2} = \frac{100}{\left(\frac{0.77}{0.0023}\right) + \left(\frac{99.23}{3.52}\right)} = 0.27 \text{ (m}^2 \cdot \text{K) / W} \quad \text{(U-value = 3.69 W/(m}^2\cdot\text{K))}$		
<b>3. Calculate RSI<sub>T3</sub></b>		
Materials in Assembly	RSI through Assembly	
Outside air film	0.03	
Brick veneer	0.07	
Air space (25 mm thick)	0.18	
Extruded polystyrene (38 mm thick x RSI 0.035/mm)	1.33	
RSI <sub>T2</sub>	0.27	
Polyethylene (vapour barrier)	—	
Gypsum (12.7 mm thick)	0.08	
Interior air film	0.12	
	RSI <sub>T3</sub> = 2.08 (m <sup>2</sup> ·K)/W (U-value = 0.48 W/(m <sup>2</sup> ·K))	
<b>4. Calculate RSI<sub>eff</sub></b>		
$RSI_{eff} = (K_1 \cdot RSI_{T1}) + (K_2 \cdot RSI_{T3}) = (0.40 \cdot 5.25) + (0.60 \cdot 2.08) = 3.35 \text{ (m}^2\cdot\text{K)/W (U-value = 0.30 W/(m}^2\cdot\text{K))}$		

**Table A-9.36.2.4.(1)-C**  
**Framing and Cavity Percentages for Typical Steel-frame Assemblies<sup>(1)</sup>**

Steel-frame Assemblies	Frame Spacing, mm o.c.							
	< 500		≥ 500		< 2100		≥ 2100	
	% Area Framing	% Area Cavity	% Area Framing	% Area Cavity	% Area Framing	% Area Cavity	% Area Framing	% Area Cavity
Roofs, ceilings, floors	0.43	99.57	0.33	99.67	—	—	—	—
Above-grade walls and strapping	0.77	99.23	0.67	99.33	—	—	—	—
Below-grade walls and strapping	0.57	99.43	0.33	99.67	—	—	—	—
Sheet steel wall	—	—	—	—	0.08	99.92	0.06	99.94

**Notes to Table A-9.36.2.4.(1)-C:**

<sup>(1)</sup> The framing percentages given in this Table are based on common framing practices and not simply on the width of the studs and cavity. They are based on 18-gauge (1.2 mm) steel; however, test results indicate that, for the range of thicknesses normally used in light-steel framing, the actual thickness has very little effect on the effective thermal resistance. If the actual % areas of framing and cavity are known, those should be used rather than the ones in this Table.

**Table A-9.36.2.4.(1)-D  
Thermal Resistance Values of Common Building Materials<sup>(1)</sup>**

<b>Air Films</b>	<b>Thickness of Material</b>	<b>Thermal Resistance (RSI), (m<sup>2</sup>·K)/W per mm</b>	<b>Thermal Resistance (RSI), (m<sup>2</sup>·K)/W for thickness listed</b>
Exterior: ceiling, floors and walls wind 6.7 m/s (winter)	—	—	0.03
Interior: ceiling (heat flow up)	—	—	0.11
floor (heat flow down)	—	—	0.16
walls (heat flow horizontal)	—	—	0.12
<b>Air Cavities<sup>(2)(3)</sup></b>	<b>Thickness of Air Space</b>	<b>Thermal Resistance (RSI), (m<sup>2</sup>·K)/W per mm</b>	<b>Thermal Resistance (RSI), (m<sup>2</sup>·K)/W for thickness listed</b>
Ceiling (heat flow up) faced with non-reflective material <sup>(4)</sup>	13 mm	—	0.15
	20 mm	—	0.15
	40 mm	—	0.16
	90 mm	—	0.16
Floors (heat flow down) faced with non-reflective material <sup>(4)</sup>	13 mm	—	0.16
	20 mm	—	0.18
	40 mm	—	0.20
	90 mm	—	0.22
Walls (heat flow horizontal) faced with non-reflective material <sup>(4)</sup>	13 mm	—	0.16
	20 mm	—	0.18
	40 mm	—	0.18
	90 mm	—	0.18

Copyright © NRC 1941 - 2021 World Rights Reserved © CNRC 1941-2021 Droits réservés pour tous pays

**Table A-9.36.2.4.(1)-D (Continued)**

<b>Cladding Materials</b>	<b>Thickness of Material</b>	<b>Thermal Resistance (RSI), (m<sup>2</sup>·K)/W per mm</b>	<b>Thermal Resistance (RSI), (m<sup>2</sup>·K)/W for thickness listed</b>
Brick:			
fired clay (2400 kg/m <sup>2</sup> )	100 mm	0.0007	0.07
concrete: sand and gravel, or stone (2400 kg/m <sup>2</sup> )	100 mm	0.0004	0.04
Cement/lime, mortar, and stucco	—	0.0009	—
Wood shingles:			
400 mm, 190 mm exposure	—	—	0.15
400 mm, 300 mm exposure (double exposure)	—	—	0.21
insulating backer board	8 mm	—	0.25
Siding:			
Metal or vinyl siding over sheathing:			
hollow-backed	—	—	0.11
insulating-board-backed	9.5 mm nominal	—	0.32
foiled-backed	9.5 mm nominal	—	0.52
Wood:			
bevel, 200 mm, lapped	13 mm	—	0.14
bevel, 250 mm, lapped	20 mm	—	0.18
drop, 200 mm	20 mm	—	0.14
hardboard	11 mm	—	0.12
plywood, lapped	9.5 mm	—	0.10
Stone:			
quartzitic and sandstone (2240 kg/m <sup>3</sup> )	—	0.0003	—
calcitic, dolomitic, limestone, marble, and granite (2240 kg/m <sup>3</sup> )	—	0.0004	—
Fibre-cement: single-faced, cellulose fibre-reinforced cement	6.35 mm	0.003	0.023
	8 mm	0.003	0.026
<b>Roofing Materials<sup>(5)</sup></b>	<b>Thickness of Material</b>	<b>Thermal Resistance (RSI), (m<sup>2</sup>·K)/W per mm</b>	<b>Thermal Resistance (RSI), (m<sup>2</sup>·K)/W for thickness listed</b>
Asphalt roll roofing	—	—	0.03
Asphalt/tar	—	0.0014	—
Built-up roofing	10 mm	—	0.06
Crushed stone	—	0.0006	—
Metal deck	—	—	negligible
Shingle:			
asphalt	—	—	0.08
wood	—	—	0.17
Slate	13 mm	—	0.01

Copyright © NRC 1941 - 2021 World Rights Reserved © CNRC 1941-2021 Droits réservés pour tous pays



**Table A-9.36.2.4.(1)-D (Continued)**

<b>Sheathing Materials</b>	<b>Thickness of Material</b>	<b>Thermal Resistance (RSI), (m<sup>2</sup>·K)/W per mm</b>	<b>Thermal Resistance (RSI), (m<sup>2</sup>·K)/W for thickness listed</b>
Gypsum sheathing	12.7 mm	0.0063	0.08
Insulating fibreboard	—	0.016	—
Particleboard:			
low density (593 kg/m <sup>3</sup> )	—	0.0098	—
medium density (800 kg/m <sup>3</sup> )	—	0.0077	—
high density (993 kg/m <sup>3</sup> )	—	0.0059	—
Plywood – generic softwood	9.5 mm	0.0087	0.083
	11 mm		0.096
	12.5 mm		0.109
	15.5 mm		0.135
	18.5 mm		0.161
Plywood – Douglas fir	9.5 mm	0.0111	0.105
	11 mm		0.122
	12.5 mm		0.139
	15.5 mm		0.172
	18.5 mm		0.205
Sheet materials:			
permeable felt	—	—	0.011
seal, 2 layers of mopped (0.73 kg/m <sup>3</sup> )	—	—	0.210
seal, plastic film	—	—	negligible
Waferboard (705 kg/m <sup>3</sup> )	—	0.0095	—
Oriented strandboard (OSB)	9.5 mm	0.0098	0.093
	11 mm		0.108
<b>Insulation Materials<sup>(6)</sup></b>	<b>Thickness of Material</b>	<b>Thermal Resistance (RSI), (m<sup>2</sup>·K)/W per mm</b>	<b>Thermal Resistance (RSI), (m<sup>2</sup>·K)/W for thickness listed</b>
Blanket and batt: rock or glass mineral fibre (CAN/ULC-S702)			
R12	89/92 mm	—	2.11
R14	89/92 mm	—	2.46
R19 <sup>(7)</sup> (R20 compressed)	140 mm	—	3.34
R20	152 mm	—	3.52
R22	140/152 mm	—	3.87
R22.5	152 mm	—	3.96
R24	140/152 mm	—	4.23
R28	178/216 mm	—	4.93
R31	241 mm	—	5.46
R35	267 mm	—	6.16
R40	279/300 mm	—	7.04

**Table A-9.36.2.4.(1)-D (Continued)**

Insulation Materials <sup>(8)</sup> (continued)	Thickness of Material	Thermal Resistance (RSI), (m <sup>2</sup> ·K)/W per mm	Thermal Resistance (RSI), (m <sup>2</sup> ·K)/W for thickness listed
<b>Boards and slabs:</b>			
Roof board	—	0.018	—
Building board or ceiling tile, lay-in panel	—	0.016	—
Polyisocyanurate/polyurethane-faced sheathing: Types 1, 2 and 3 (CAN/ULC-S704)			
permeably faced	25 mm	0.03818	0.97
	50 mm	0.0360	1.80
impermeably faced	25 mm	0.03937	1.00
	50 mm	0.0374	1.87
Expanded polystyrene (CAN/ULC-S701) <sup>(9)</sup>			
Type 1	25 mm	0.026	0.65
Type 2	25 mm	0.028	0.71
Type 3	25 mm	0.030	0.76
Extruded polystyrene: Types 2, 3 and 4 (CAN/ULC-S701)			
	25 mm	0.035	0.88
	50 mm	0.0336	1.68
Semi-rigid glass fibre wall/roof insulation (48 kg/m <sup>3</sup> )	25 mm	0.0298	0.757
Semi-rigid rock wool wall insulation (56 kg/m <sup>3</sup> )	25 mm	0.0277	0.704
<b>Loose-fill insulation</b>			
Cellulose (CAN/ULC-S703)	—	0.025	—
Glass fibre loose fill insulation for attics (CAN/ULC-S702)	112 to 565 mm	0.01875	—
Glass fibre loose fill insulation for walls (CAN/ULC-S702)	89 mm	0.02865	2.55
	140 mm	0.0289	4.05
	152 mm	0.030	4.23
Perlite	—	0.019	—
Vermiculite	—	0.015	—
<b>Spray-applied insulation</b>			
Sprayed polyurethane foam			
medium density (CAN/ULC-S705.1)	25 mm	0.036	0.90
	50 mm	0.036	1.80
light density (CAN/ULC-S712.1)	25 mm	0.026	0.65
Sprayed cellulosic fibre (CAN/ULC-S703)	settled thickness	0.024	—
Spray-applied glass-fibre insulation (CAN/ULC-S702)			
density: 16 kg/m <sup>3</sup>	89 mm	0.025	2.30
	140 mm	0.025	3.53
density: 28.8 kg/m <sup>3</sup>	89 mm	0.029	2.64
	140 mm	0.029	4.06

Copyright © NRC 1941 - 2021 World Rights Reserved © CNRC 1941-2021 Droits réservés pour tous pays

**Table A-9.36.2.4.(1)-D (Continued)**

<b>Structural Materials</b>	<b>Thickness of Material</b>	<b>Thermal Resistance (RSI), (m<sup>2</sup>·K)/W per mm</b>	<b>Thermal Resistance (RSI), (m<sup>2</sup>·K)/W for thickness listed</b>
Concrete			
Low-density aggregate			
expanded shale, clay, slate or slags, cinders (1 600 kg/m <sup>3</sup> )	—	0.0013	—
perlite, vermiculite, and polystyrene bead (480 kg/m <sup>3</sup> )	—	0.0063	—
Normal-density aggregate			
sand and gravel or stone aggregate (2 400 kg/m <sup>3</sup> )	—	0.0004	—
Hardwood <sup>(10)(11)</sup>			
Ash	—	0.0063	—
Birch	—	0.0055	—
Maple	—	0.0063	—
Oak	—	0.0056	—
Softwood <sup>(10)(11)</sup>			
Amabilis fir	—	0.0080	—
California redwood	—	0.0089	—
Douglas fir-larch	—	0.0069	—
Eastern white cedar	—	0.0099	—
Eastern white pine	—	0.0092	—
Hemlock-fir	—	0.0084	—
Lodgepole pine	—	0.0082	—
Red pine	—	0.0077	—
Western hemlock	—	0.0074	—
Western red cedar	—	0.0102	—
White spruce	—	0.0097	—
Yellow cyprus-cedar	—	0.0077	—
Wood, structural framing, spruce-pine-fir <sup>(12)</sup>	—	0.0085	—
Steel, galvanized sheet, 0.14% carbon content	—	0.0000161	—

Copyright © NRC 1941 - 2021 World Rights Reserved © CNRC 1941-2021 Droits réservés pour tous pays

**Table A-9.36.2.4.(1)-D (Continued)**

<b>Concrete Blocks</b>	<b>Thickness of Material</b>	<b>Thermal Resistance (RSI), (m<sup>2</sup>·K)/W per mm</b>	<b>Thermal Resistance (RSI), (m<sup>2</sup>·K)/W for thickness listed</b>	
Limestone aggregate with 2 cores cores filled with perlite	190 mm	—	0.37	
	290 mm	—	0.65	
Light-weight units (expanded shale, clay, slate or slag aggregate) with 2 or 3 cores	no insulation in cores	90 mm	—	0.24
		140 mm	—	0.30
		190 mm	—	0.32
		240 mm	—	0.33
		290 mm	—	0.41
	cores filled with perlite	140 mm	—	0.74
		190 mm	—	0.99
		290 mm	—	1.35
	cores filled with vermiculite	140 mm	—	0.58
		190 mm	—	0.81
		240 mm	—	0.98
		290 mm	—	1.06
	cores filled with molded EPS beads molded EPS inserts in cores	190 mm	—	0.85
		190 mm	—	0.62
Medium-weight units (combination of normal- and low-mass aggregate) with 2 or 3 cores	no insulation in cores	190 mm	—	0.26
	cores filled with molded EPS beads	190 mm	—	0.56
	molded EPS inserts in cores	190 mm	—	0.47
	cores filled with perlite	190 mm	—	0.53
	cores filled with vermiculite	190 mm	—	0.58
	Normal-weight units (sand and gravel aggregate) with 2 or 3 cores	no insulation in cores	90 mm	—
140 mm			—	0.19
190 mm			—	0.21
240 mm			—	0.24
290 mm			—	0.26
cores filled with perlite cores filled with vermiculite		190 mm	—	0.35
		140 mm	—	0.40
		190 mm	—	0.51
		240 mm	—	0.61
		290 mm	—	0.69

Copyright © NRC 1941 - 2021 World Rights Reserved © CNRC 1941-2021 Droits réservés pour tous pays

**Table A-9.36.2.4.(1)-D (Continued)**

<b>Hollow Clay Bricks</b>	<b>Thickness of Material</b>	<b>Thermal Resistance (RSI), (m<sup>2</sup>·K)/W per mm</b>	<b>Thermal Resistance (RSI), (m<sup>2</sup>·K)/W for thickness listed</b>	
Multi-cored without insulation in cores	90 mm	—	0.27	
Rectangular 2-core no insulation in cores	140 mm	—	0.39	
	190 mm	—	0.41	
	290 mm	—	0.47	
	cores filled with vermiculite	140 mm	—	0.65
		190 mm	—	0.86
		290 mm	—	1.29
Rectangular 3-core no insulation in cores	90 mm	—	0.35	
	140 mm	—	0.38	
	190 mm	—	0.41	
	240 mm	—	0.43	
	290 mm	—	0.45	
	cores filled with vermiculite	140 mm	—	0.68
		190 mm	—	0.86
		240 mm	—	1.06
		290 mm	—	1.19

**Table A-9.36.2.4.(1)-D (Continued)**

Interior Finish Materials <sup>(13)</sup>	Thickness of Material	Thermal Resistance (RSI), (m <sup>2</sup> ·K)/W per mm	Thermal Resistance (RSI), (m <sup>2</sup> ·K)/W for thickness listed
Gypsum board	—	0.0061	—
Hardboard – medium-density (800 kg/m <sup>3</sup> )	—	0.0095	—
Interior finish (plank, tile) board	—	0.0198	—
Particleboard			
low-density (590 kg/m <sup>3</sup> )	—	0.0098	—
medium-density (800 kg/m <sup>3</sup> )	—	0.0074	—
high-density (1 000 kg/m <sup>3</sup> )	—	0.0059	—
underlay	15.9 mm	—	0.140
Plywood	—	0.0087	—
Flooring material			
Carpet and fibrous pad	—	—	0.370
Carpet and rubber pad	—	—	0.220
Cork tile	3.2 mm	—	0.049
Hardwood flooring	19 mm	—	0.120
Terrazzo	25 mm	—	0.014
Tile (linoleum, vinyl, rubber)	—	—	0.009
Tile (ceramic)	9.5 mm	—	0.005
Wood subfloor	19 mm	—	0.170
Plastering			
Cement plaster: sand aggregate	—	0.0014	—
Gypsum plaster			
low-density aggregate	—	0.0044	—
sand aggregate	—	0.0012	—

**Notes to Table A-9.36.2.4.(1)-D:**

- (1) The thermal resistance values given in Table A-9.36.2.4.(1)-D are generic values for the materials listed or minimum acceptable values taken from the standards listed. Values published by manufacturers for their proprietary materials may differ slightly but are permitted to be used, provided they were obtained in accordance with the test methods referenced in Article 9.36.2.2. For materials not listed in the Table or where the listed value does not reflect the thickness of the product, the thermal resistance value has to be calculated by dividing the material's thickness, in m, by its conductivity, in W/(m·K), which can be found in the manufacturer's literature.
- (2) RSI values can be interpolated for air cavity sizes that fall between 13 and 90 mm, and they can be moderately extrapolated for air cavities measuring more than 90 mm. However, air cavities measuring less than 13 mm cannot be included in the calculation of effective thermal resistance of the assembly.
- (3) Where strapping is installed, use the RSI value for an air layer of equivalent thickness.
- (4) Reflective insulation material may contribute a thermal property value depending on its location and installation within an assembly. Where a value is obtained through evaluation carried out in accordance with Clause 9.36.2.2.(4)(b), it may be included in the calculation of the thermal resistance or transmittance of the specific assembly.
- (5) Materials installed towards the exterior of a vented air space cannot be included in the calculation of effective thermal resistance of the assembly.
- (6) All types of cellular foam plastic insulation manufactured to be able to retain a blowing agent, other than air, for a period longer than 180 days shall be tested for long-term thermal resistance (LTTR) in accordance with CAN/ULC-S770, "Determination of Long-Term Thermal Resistance of Closed-Cell Thermal Insulating Foams." This LTTR value shall be input as the design thermal resistance value for the purpose of energy calculations in Section 9.36. Product standards contain a baseline LTTR for a thickness of 50 mm, from which the LTTR for other thicknesses can be calculated.
- (7) An RSI 3.52 (R20) batt compressed into a 140 mm cavity has a thermal resistance value of 3.34 (R19); if installed uncompressed in a 152 mm cavity (e.g. in a metal stud assembly), it will retain its full thermal resistance value of 3.52 (m<sup>2</sup>·K)/W.
- (8) All types of cellular foam plastic insulation manufactured to be able to retain a blowing agent, other than air, for a period longer than 180 days shall be tested for long-term thermal resistance (LTTR) in accordance with CAN/ULC-S770, "Determination of Long-Term Thermal Resistance of Closed-Cell Thermal Insulating Foams." This LTTR value shall be input as the design thermal resistance value for the purpose of energy calculations in Section 9.36. Product standards contain a baseline LTTR for a thickness of 50 mm, from which the LTTR for other thicknesses can be calculated.
- (9) Expanded polystyrene insulation is not manufactured to be able to retain a blowing agent; it is therefore not necessary to test its LTTR. See Note (8).

Table A-9.36.2.4.(1)-D (Continued)

- (10) The thermal resistance values for wood species are based on a moisture content (MC) of 12%. In Canada, equilibrium moisture content for wood in buildings ranges from 8–14%. The difference between the thermal properties of wood species with 12% MC and those with 14% MC is negligible.
- (11) For wood species not listed in the Table, the RSI value of a wood species of equal or greater density (or specific gravity (relative density)) can be used since the thermal resistance of wood is directly related to its density (higher density wood has a lower thermal resistance).
- (12) 0.0085 is considered a common value for structural softwood (see also the “ASHRAE Handbook – Fundamentals”).
- (13) Materials installed towards the interior of a conditioned air space cannot be included in the calculation of effective thermal resistance of the assembly.

**A-9.36.2.4.(3) Calculating Thermal Resistance of Major Structural Penetrations.** Projecting slabs contribute a large area to the 2% exclusion so calculation and analysis of the heat loss through the area they penetrate should be carried out; where construction features only occasional penetrations by beams or joists, the heat loss is less critical to the overall energy performance of a building. Although the 2% exemption is based on gross wall area, it applies to penetrations through any building envelope assembly.

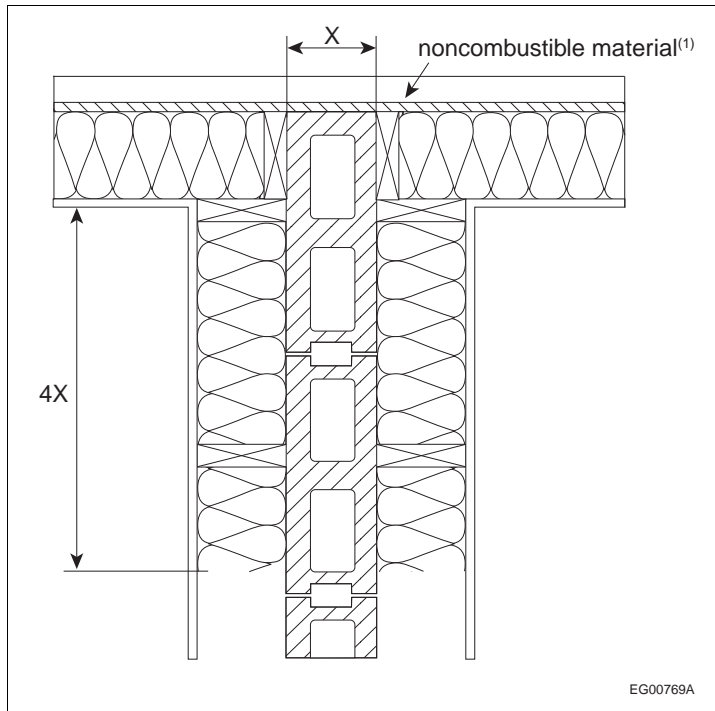
**A-9.36.2.4.(4) Credit for Unheated Spaces Protecting the Building Envelope.** The reduction in RSI afforded by Sentence 9.36.2.4.(4) is intended to provide a simple credit under the prescriptive path for any unheated space that protects a component of the building envelope. The credited value is conservative because it cannot take into account the construction of the enclosure surrounding the unheated space, which may or may not comply with the Code; as such, too many variables, such as its size or airtightness, may negate any higher credit that could be allowed.

There may be simulation tools that can be used under the performance path to provide a better assessment of the effect of an indirectly heated space; these tools may be used to calculate the credit more accurately when an unheated space is designed to provide significantly better protection than the worst-case situation assumed here. Vented spaces, such as attic and roof spaces or crawl spaces, are considered as exterior spaces; the RSI-value credit allowed in Sentence 9.36.2.4.(4) can therefore not be applied in the calculation of the effective thermal resistance of assemblies separating conditioned spaces from vented spaces.

**A-9.36.2.5.(1) Continuity of Insulation.** Sentence 9.36.2.5.(1) is intended to apply to building components such as partitions, chimneys, fireplaces, and columns and beams that are embedded along exterior walls, but not to stud framing and ends of joists. Stud and joists in frame construction are not considered to break the continuity of the insulation because the method for calculating the effective thermal resistance of such assemblies, which is described in Note A-9.36.2.4.(1), takes their presence into consideration.

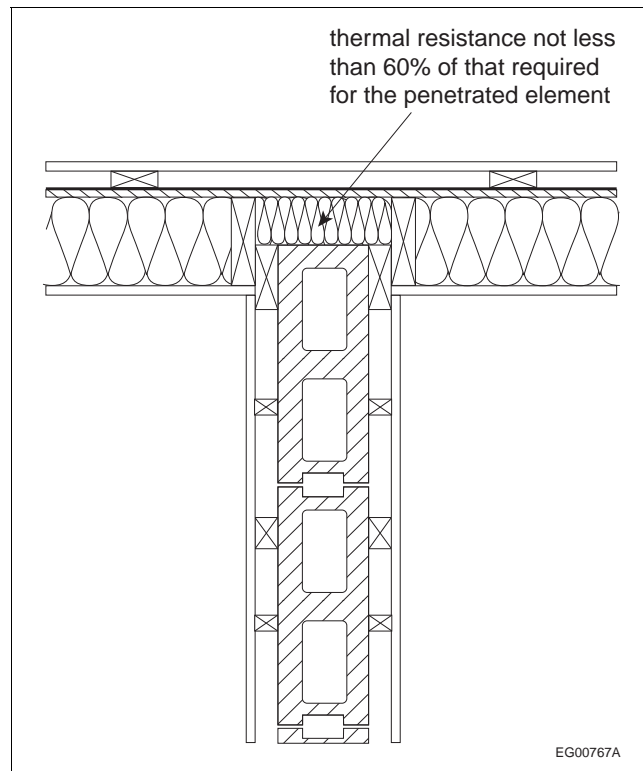
The rest of Article 9.36.2.5. contains exceptions to Sentence (1): Sentences (2) to (8) introduce relaxations for various construction details while Sentence (9) allows a complete exemption to the requirements in Sentence (1) for three specific construction details. Balcony and canopy slabs are also exempt from the requirements in Sentence (1) because their presence is permitted to be disregarded when calculating the overall effective thermal resistance of walls they penetrate.

**A-9.36.2.5.(2) Thermal Bridging.** Sentence 9.36.2.5.(2) aims to minimize thermal bridging within the building envelope, which occurs when building elements conduct more heat than the insulated portion of the building envelope, which can lead to significant heat loss through the thermal bridge. The most typical case to which Clause 9.36.2.5.(2)(a) applies is that of a firewall that must completely penetrate the building envelope (see Figure A-9.36.2.5.(2)-A). Figures A-9.36.2.5.(2)-B and A-9.36.2.5.(2)-C illustrate the insulation options presented in Clauses 9.36.2.5.(2)(b) and (c).



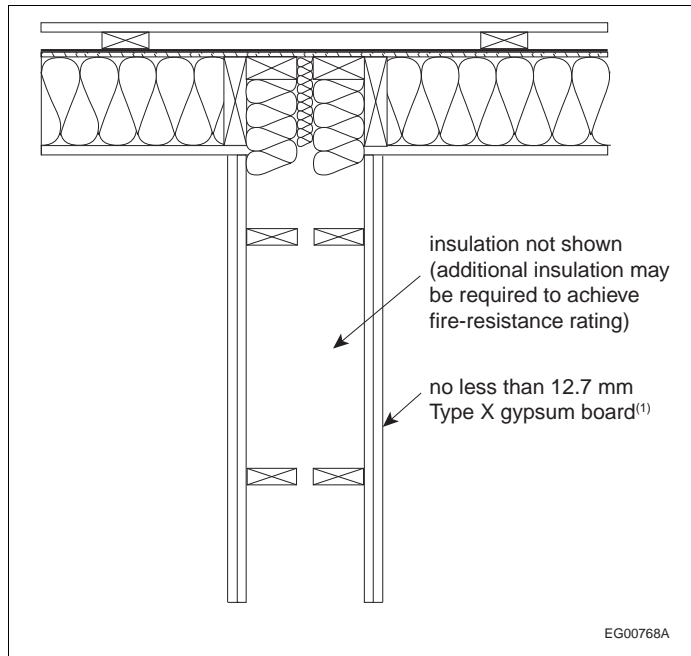
**Figure A-9.36.2.5(2)-A**  
**Penetrating element insulated on both sides**

**Note to Figure A-9.36.2.5(2)-A:**  
(1) See Article 3.1.10.7.



**Figure A-9.36.2.5(2)-B**  
**Penetrating element insulated within exterior wall**



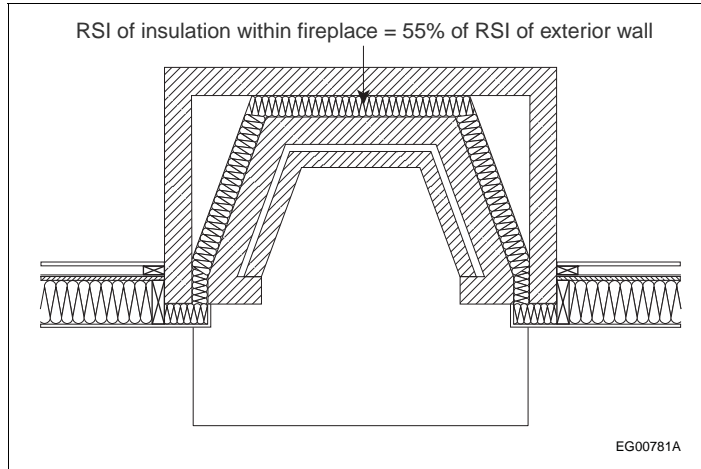


**Figure A-9.36.2.5.(2)-C**  
**Penetrating element insulated within itself**

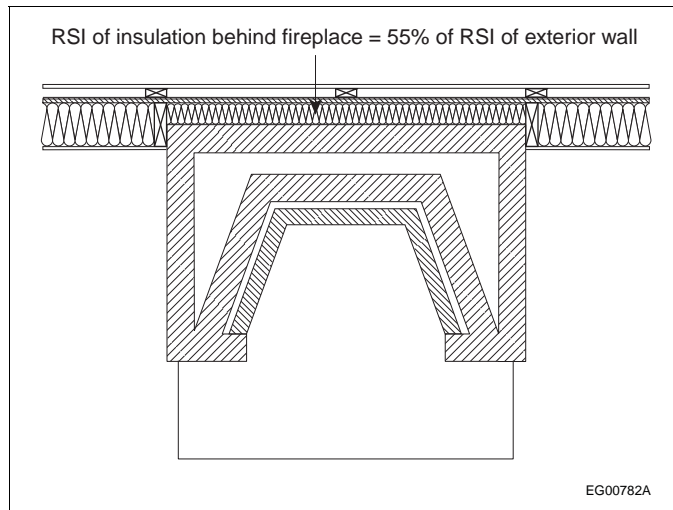
**Note to Figure A-9.36.2.5.(2)-C:**

(1) See Article 9.10.11.2.

**A-9.36.2.5.(3) Insulation of Masonry Fireplaces.** The two insulation options for masonry fireplaces and flues presented in Sentence 9.36.2.5.(3) are consistent with those presented in Sentences 9.36.2.5.(2) and (4) with the exception of the option to insulate the sides of the penetrating element to 4 times the thickness of the penetrated wall, which would not be an energy-efficient option in cases where the penetration by the fireplace or flue is several feet wide. Figures A-9.36.2.5.(3)-A and A-9.36.2.5.(3)-B illustrate the options for achieving a continuously insulated exterior wall where it is penetrated by a masonry fireplace or flue.



**Figure A-9.36.2.5.(3)-A**  
**Masonry fireplace insulated within itself**

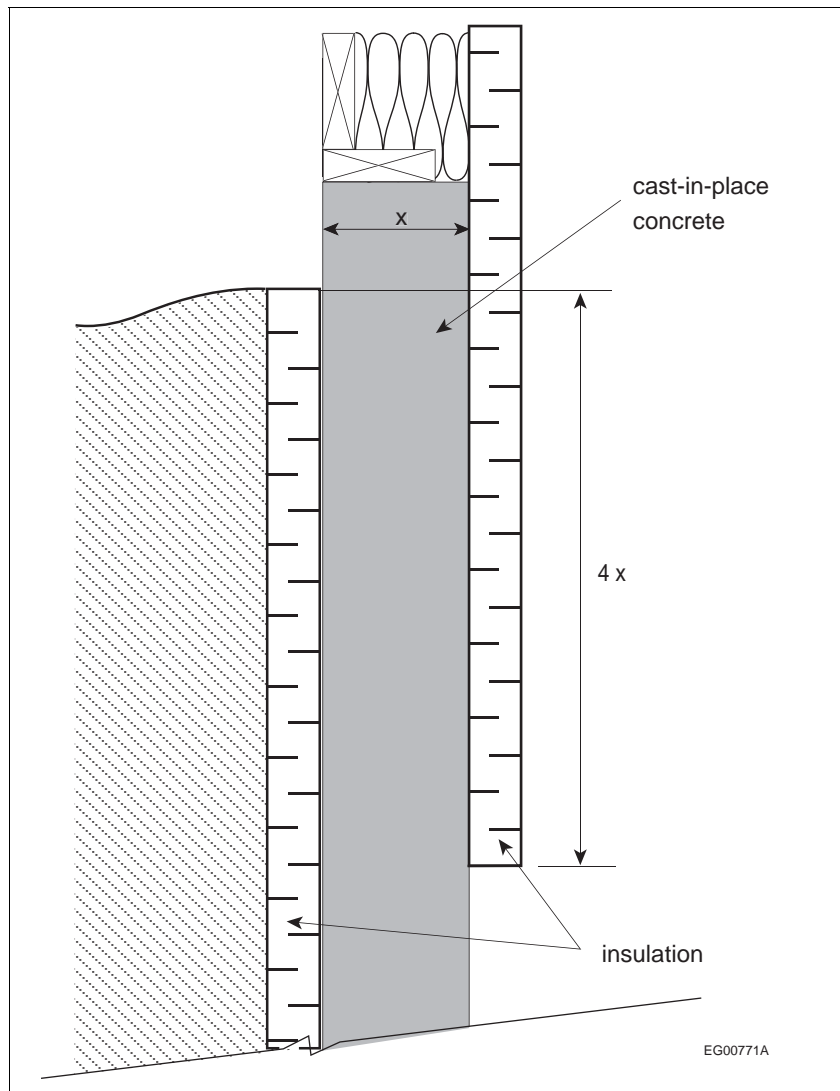


**Figure A-9.36.2.5.(3)-B**  
**Masonry fireplace insulated within plane of insulation of exterior wall**

**A-9.36.2.5.(5) Maintaining Continuity of Insulation.** An example to which Sentence 9.36.2.5.(5) does not apply is that of a foundation wall that is insulated on the inside and the insulation continues through the joist cavity and into the wall assembly. An example to which Sentence (5) does apply is a foundation wall that is insulated on the outside below grade and on the inside above grade, in which case the distance separating the two planes of insulation is the thickness of the foundation wall.

In the configuration described in Sentence (5), the top of the foundation wall might also be required to be insulated to reduce the effect of thermal bridging through it. Insulation is not required to be overlapped as stated in Sentence (5) in cases where the joist cavities on top of the foundation wall are filled with insulation.

For cast-in-place concrete foundation walls, Sentence (5) ensures that the continuity of the insulation is maintained at every section across the wall.



**Figure A-9.36.2.5.(5)-A**  
**Application of Sentence 9.36.2.5.(5) to a cast-in-place concrete foundation wall**

In the case of hollow-core masonry walls, the effect of convection in the cores needs to be addressed. The cores of the block course that coincide with the respective lowest and highest ends of each plane of insulation should be filled with grout, mortar or insulation to reduce convection within the cores, which could short-circuit the insulation's function.

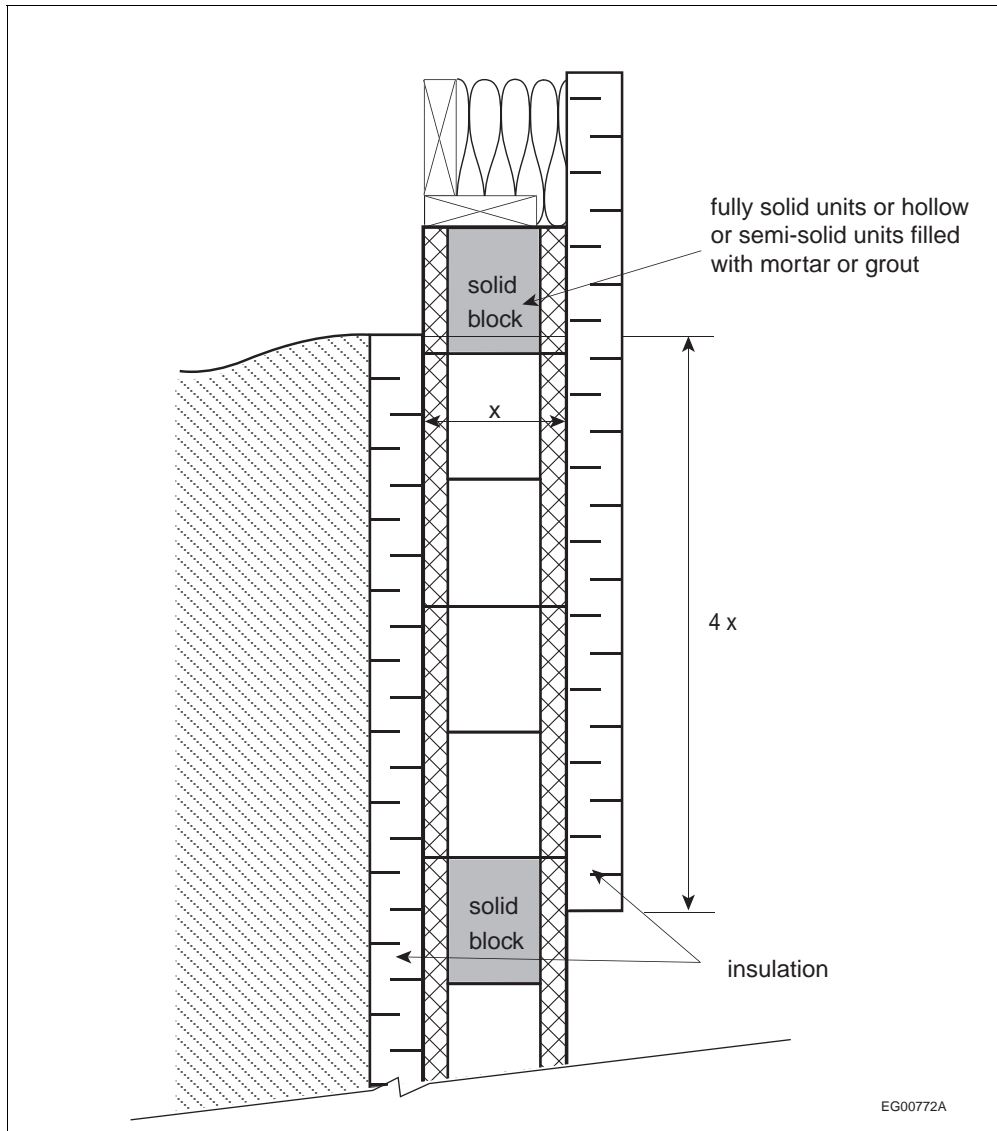


Figure A-9.36.2.5.(5)-B

Application of Sentence 9.36.2.5.(5) to a hollow-core masonry foundation wall

**A-9.36.2.5.(6) Effective Thermal Resistance at Projected Area.** Sentence 9.36.2.5.(6) does not apply to components that completely penetrate the building envelope, such as air intake or exhaust ducts. However, it does apply to components that are installed within or partially within the building envelope but that don't penetrate to the outdoors, and to any piece of equipment that is merely recessed into the wall.

**A-9.36.2.5.(8) Effective Thermal Resistance at Joints in the Building**

**Envelope.** Sentence 9.36.2.5.(8) calls for continuity of the effective thermal resistance at the junction between two components of the building envelope, such as a wall with another wall, a wall with a roof, or a wall with a window. For example, where the gap is between a door frame (required U-value 1.8 = RSI value 0.56) and the rough framing members (required RSI value 2.93), it would have to be insulated to the RSI value of the door as a minimum. However, completely filling the gap with insulation may not be necessary as this may in fact compromise the rainscreen principle where required. Care should therefore be taken when installing insulation between windows, doors and walls.

**A-9.36.2.6.(1) Thermal Characteristics of Above-ground Opaque Building Assemblies.**

**Building Envelope Insulation and Ventilation Options**

Although the Code does not present any formal trade-off options between the building envelope requirements and the ventilation or water-heating requirements, Tables 9.36.2.6.-A and 9.36.2.6.-B recognize that the same level of energy performance can be achieved through two different combinations of building envelope insulation levels and different ventilation strategies. The insulation values in Table 9.36.2.6.-A are based on mechanical ventilation solutions without heat recovery, while those in Table 9.36.2.6.-B are based on a heat recovery ventilator (HRV) that operates for at least 8 hours a day throughout the year at the minimum required ventilation capacity. The operation of the HRV affords a reduction in the RSI values for some assemblies, most notably for walls and rim joists.

**Nominal Insulation Values for Above-ground Walls**

Tables A-9.36.2.6.(1)-A and A-9.36.2.6.(1)-B are provided to help Code users assess the compliance of above-ground walls with Table 9.36.2.6.-A or 9.36.2.6.-B. Table A-9.36.2.6.(1)-A presents the minimum nominal thermal resistance to be made up in a given wall assembly for it to achieve the applicable RSI value required by Table 9.36.2.6.-A or 9.36.2.6.-B. The amount of additional materials needed to meet the prescribed RSI value can then be estimated using the thermal resistance values listed in Table A-9.36.2.4.(1)-D for the rest of the building materials in the assembly, any finishing materials, sheathing or insulation, if applicable, and the interior and exterior air films. See the example given in Note (4) of Table A-9.36.2.6.(1)-A.

Note that the wall assemblies described in Table A-9.36.2.6.(1)-A do not necessarily address other building envelope requirements (see Section 9.25.).

**Table A-9.36.2.6.(1)-A  
Minimum Nominal Thermal Resistance (RSI) to be Made up by Insulation, Sheathing or Other Materials and Air Films  
in Above-ground Wall Assemblies**

Description of Framing or Material	Thermal Resistance of Insulated Assembly			Minimum Effective Thermal Resistance Required by Article 9.36.2.6. for Above-ground Wall Assemblies, (m <sup>2</sup> ·K)/W			
	Nominal, (m <sup>2</sup> ·K)/W (ft <sup>2</sup> ·°F·h/Btu)		Effective, (m <sup>2</sup> ·K)/W	2.78	2.97	3.08	3.85
	Insulation in Framing Cavity	Continuous Materials					
38 x 140 mm wood at 406 mm o.c.	3.34 (R19) <sup>(3)</sup>	None	2.36	0.42 <sup>(4)</sup>	0.61	0.72	1.49
		1.32 (R7.5)	3.68	—	—	—	0.17
	3.87 (R22)	None	2.55	0.23	0.42	0.54	1.30
		0.88 (R5)	3.43	—	—	—	0.42
4.23 (R24)	None	2.66	0.12	0.30	0.42	1.18	
38 x 140 mm wood at 610 mm o.c.	3.34 (R19) <sup>(3)</sup>	None	2.45	0.33	0.52	0.63	1.40
		0.88 (R5)	3.33	—	—	—	0.52
		1.32 (R7.5)	3.77	—	—	—	0.08
	3.87 (R22)	None	2.67	0.11	0.30	0.42	1.18
4.23 (R24)	None	2.80	—	0.17	0.28	1.05	
38 x 89 mm wood at 406 mm o.c.	2.11 (R12)	0.88 (R5)	2.37	0.40	0.59	0.71	1.47
		1.32 (R7.5)	2.81	—	0.15	0.27	1.03
		1.76 (R10)	3.25	—	—	—	0.59
	2.46 (R14)	0.88 (R5)	2.50	0.28	0.47	0.58	1.35
		1.76 (R10)	3.38	—	—	—	0.47
38 x 89 mm wood at 610 mm o.c.	2.11 (R12)	0.88 (R5)	2.43	0.35	0.54	0.65	1.42
		1.32 (R7.5)	2.87	—	0.10	0.21	0.98
	2.46 (R14)	1.76 (R10)	3.46	—	—	—	0.39

**Table A-9.36.2.6.(1)-A (Continued)**

Description of Framing or Material	Thermal Resistance of Insulated Assembly			Minimum Effective Thermal Resistance Required by Article 9.36.2.6. for Above-ground Wall Assemblies, (m <sup>2</sup> ·K)/W			
	Nominal, (m <sup>2</sup> ·K)/W (ft <sup>2</sup> ·°F·h/Btu)		Effective, (m <sup>2</sup> ·K)/W	2.78	2.97	3.08	3.85
	Insulation in Framing Cavity	Continuous Materials	Entire Assembly	Minimum Nominal Thermal Resistance, <sup>(1)</sup> in (m <sup>2</sup> ·K)/W, to be Made up by Insulation, Sheathing <sup>(2)</sup> or Other Materials and Air Film Coefficients			
Insulating concrete form (ICF), 150 mm thick <sup>(5)</sup>	n/a	3.52 (R20)	3.58	—	—	—	0.27
		3.73 (R21.2)	3.79	—	—	—	0.06
Concrete block masonry: lightweight, 190 mm thick	n/a	1.76 (R10)	2.08	0.70	0.89	1.00	1.77
		2.64 (R15)	2.96	—	0.01	0.12	0.89
		3.52 (R20)	3.84	—	—	—	0.01
Concrete block masonry: normal-weight, 190 mm thick	n/a	1.76 (R10)	1.97	0.81	1.00	1.11	1.88
		2.64 (R15)	2.85	—	0.12	0.23	1.00
		3.52 (R20)	3.73	—	—	—	0.12

**Notes to Table A-9.36.2.6.(1)-A:**

- (1) A dash (—) means that no additional materials are needed in order to meet the minimum required effective thermal resistance for the assembly in question; however, sheathing may be required for fastening of cladding or lateral bracing.
- (2) Where insulating sheathing is installed towards the exterior of the assembly, low permeance requirements addressed in Article 9.25.5.2. must be taken into consideration.
- (3) When RSI 3.52 (R20) insulation batts are installed in 140 mm wood framing, they undergo some compression, which reduces their original RSI value to 3.34 (m<sup>2</sup>·K)/W (R19). However, when they are installed in 152 mm metal framing, R20 batts retain their original thermal resistance value.
- (4) Example: To determine what additional materials would be needed to make up 0.42 (m<sup>2</sup>·K)/W, the RSI values of the other components in the wall assembly are added up as follows:  
 interior air film coefficient (walls): 0.12 (m<sup>2</sup>·K)/W  
 12.7 mm gypsum board interior finish: 0.08 (m<sup>2</sup>·K)/W  
 12.7 mm gypsum board exterior sheathing: 0.08 (m<sup>2</sup>·K)/W  
 metal or vinyl siding: 0.11 (m<sup>2</sup>·K)/W  
 exterior air film coefficient (walls): 0.03 (m<sup>2</sup>·K)/W  
 RSI of other components in assembly: 0.12 + 0.08 + 0.08 + 0.11 + 0.03 = 0.42 (m<sup>2</sup>·K)/W  
 Result: no additional materials are needed to meet the effective thermal resistance required for this particular wall assembly.
- (5) There are many types of ICF designs with different form thicknesses and tie configurations. Where ICF systems incorporate metal ties, thermal bridging should be accounted for. Where permanent wood blocking (bucks) for windows and doors is not covered by the same interior and exterior levels of insulation, it shall be accounted for in the calculation of effective thermal resistance.

Table A-9.36.2.6.(1)-B can be used to determine the total effective thermal resistance (RSI) value of the framing/cavity portion of a number of typical above-ground wall assemblies as well as some atypical ones not covered in Table A-9.36.2.6.(1)-A. Additional configurations and assembly types are listed in EnergyStar tables available online at <http://ENERGYSTARforNewHomesStandard.NRCan.gc.ca>.

Select the applicable stud/joist size and spacing and the RSI/R-value of the insulation to obtain the resultant effective RSI value for that frame configuration. If the RSI/R-value of the insulation product to be installed falls between two RSI/R-values listed in the Table, the lower value must be used. Once the effective RSI value of the framing/cavity portion is known, add up the nominal RSI values of all other materials in the assembly (see Table A-9.36.2.4.(1)-D) to obtain the total effective RSI value for the entire assembly. See the calculation examples in Note A-9.36.2.4.(1) for further guidance.

**Table A-9.36.2.6.(1)-B**  
**Effective Thermal Resistance (RSI) Values of the Framing/Cavity Portion of Above-Ground Wall Assemblies**

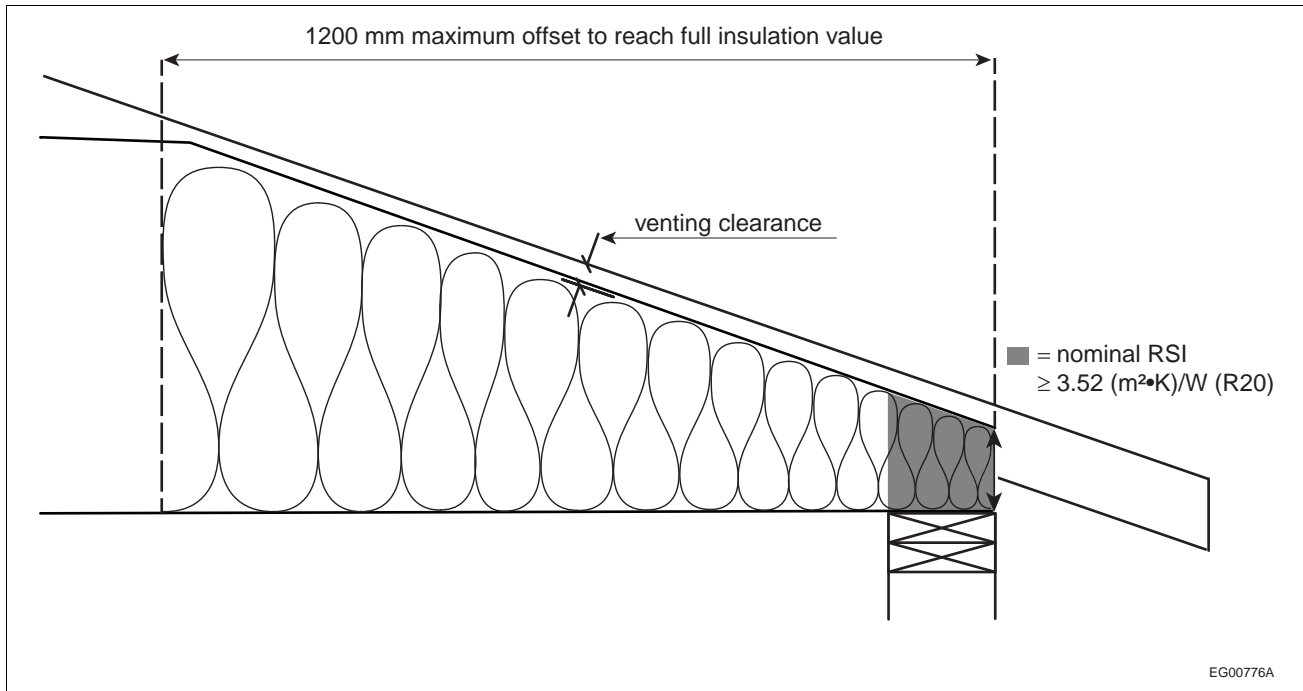
Nominal Thermal Resistance of Cavity Insulation		Size, mm, and Spacing, mm o.c., of Above-ground Wood-frame Wall Assembly							
		38 x 89				38 x 140			
		304	406	488	610	304	406	488	610
RSI, (m <sup>2</sup> ·K)/W	R, ft <sup>2</sup> ·°F·h/Btu	Effective Thermal Resistance of Framing/Cavity Portion, <sup>(1)</sup> (m <sup>2</sup> ·K)/W							
1.94	11	1.40	1.43	1.45	1.48	—	—	—	—
2.11	12	1.47	1.49	1.52	1.55	—	—	—	—
2.29	13	1.53	1.56	1.59	1.63	—	—	—	—
2.47	14	1.59	1.62	1.66	1.70	1.95	1.98	2.01	2.03
2.64	15	1.64	1.68	1.72	1.76	2.03	2.06	2.09	2.12
2.82	16	1.69	1.73	1.78	1.82	2.11	2.14	2.18	2.21
2.99	17	1.74	1.78	1.83	1.88	2.18	2.22	2.26	2.30
3.17	18	1.78	1.83	1.88	1.94	2.25	2.29	2.33	2.38
3.34	19	1.82	1.87	1.93	1.98	2.32	2.36	2.41	2.45
3.52	20	1.86	1.91	1.97	2.03	2.38	2.43	2.48	2.53
3.70	21	—	—	—	—	2.44	2.49	2.55	2.60
3.87	22	—	—	—	—	2.49	2.55	2.61	2.67
4.05	23	—	—	—	—	2.55	2.61	2.67	2.74
4.23	24	—	—	—	—	2.60	2.66	2.73	2.80
4.40	25	—	—	—	—	2.65	2.72	2.78	2.86
4.58	26	—	—	—	—	2.70	2.77	2.84	2.92
4.76	27	—	—	—	—	2.74	2.82	2.89	2.98
4.93	28	—	—	—	—	2.79	2.86	2.94	3.03
5.11	29	—	—	—	—	2.83	2.91	2.99	3.08
5.28	30	—	—	—	—	2.87	2.95	3.04	3.13

**Notes to Table A-9.36.2.6.(1)-B:**

<sup>(1)</sup> These RSI values are valid where the cavity is completely filled with insulation and they do not account for air space in the cavity. A dash (—) means that it is not feasible to install the cavity insulation listed within the frame configuration in question.

**A-9.36.2.6.(3) Reduced Effective Thermal Resistance Near the Eaves of Sloped**

**Roofs.** Minimum thermal resistance values for attic-type roofs are significantly higher than those for walls. The exemption in Sentence 9.36.2.6.(3) recognizes that the effective thermal resistance of a ceiling below an attic near its perimeter will be affected by roof slope, truss design and required ventilation of the attic space. It is assumed that the thickness of the insulation will be increased as the roof slope increases until there is enough space to allow for the installation of the full thickness of insulation required.



**Figure A-9.36.2.6.(3)**

**Area of ceiling assemblies in attics permitted to have reduced thermal resistance**

**A-9.36.2.7.(1) and (2) Design of Windows, Glazed Doors and Skylights.** The design of windows, glazed doors and skylights involves many variables that impact their energy performance and their compliance with the Code's energy efficiency requirements, such as the type of framing material, number of glass layers, type and position of low-emissivity (low-e) coating, type and size of spacer between glass layers, type of gas used to fill the glass unit, and additionally for glazed doors, type of materials used to construct the door slab.

Here are a few examples of common window and glazed door constructions:

- a U-value of about 1.8 is typically achieved using argon-filled glazing units with a low-e coating and energy-efficient spacer materials installed in a frame chosen mostly for aesthetic reasons;
- a U-value of about 1.6 is typically achieved using triple glazing but may be achieved using double glazing with an optimized gas, spacer and coating configuration installed in an insulated frame;
- a U-value of about 1.4 is typically achieved using triple glazing and multiple low-e coatings.

U-values and Energy Ratings (ER) for manufactured windows, glazed doors and skylights are obtained through testing in accordance with the standards referenced in Sentence 9.36.2.2.(3). The U-value and/or ER number for a proprietary product that has been tested can be found in the manufacturer's literature or on a label affixed to the product.

**A-Table 9.36.2.7.-A Thermal Characteristics of Windows and Doors.** Energy Ratings, also known as ER numbers, are based on CSA A440.2/A440.3, "Fenestration Energy Performance/User Guide to CSA A440.2-14, Fenestration Energy Performance."

They are derived from a formula that measures the overall performance of windows or doors based on solar heat gain, heat loss and air leakage through frames, spacers and glass. The ER formula produces a single unitless ER number between 0 and 50 for each of the specified sample sizes found in CSA A440.2/A440.3 (the number only applies to the product at the sample size and not to a particular proprietary window or door).



The higher the ER number, the more energy-efficient the product. Note that the ER formula does not apply to sloped glazing so skylights do not have an ER value.

The maximum U-values specified in Table 9.36.2.7.-A are based on the following assumptions:

- that of moderate solar gain for each window and glazed door,
- that houses have a mix of picture and sash windows, each of which performs differently from an energy-efficiency perspective, and
- that fenestration area to gross wall area ratios typically vary between 8% and 25%.

**A-9.36.2.7.(3) Site-built Windows.** Site-built windows are often installed in custom-built homes or in unique configurations for which manufactured units are not available. The airtightness requirements in Section 9.7. also apply to site-built windows.

**A-9.36.2.8.(1) Nominal Insulation Values for Walls Below-Grade or in Contact with the Ground.** Tables A-9.36.2.8.(1)-A, A-9.36.2.8.(1)-B and A-9.36.2.8.(1)-C are provided to help Code users assess the compliance of walls that are below-grade or in contact with the ground with Table 9.36.2.8.-A or 9.36.2.8.-B. Table A-9.36.2.8.(1)-A presents the minimum nominal thermal resistance to be made up in a given wall assembly for it to achieve the applicable RSI value required by Table 9.36.2.8.-A or 9.36.2.8.-B. The amount of additional materials needed to meet the prescribed RSI value can then be estimated using the thermal resistance values listed in Table A-9.36.2.4.(1)-D for the rest of the building materials in the assembly, any finishing materials, sheathing or insulation, if applicable, and the interior air film. For example, an RSI value of 0.20 (m<sup>2</sup>-K)/W needed to achieve the minimum RSI for a given assembly could be made up by installing 12.7 mm gypsum board, which has an RSI value of 0.0775 (m<sup>2</sup>-K)/W, and by taking into account the air film coefficient on the interior side of the wall, which is 0.12 (m<sup>2</sup>-K)/W.

Note that the wall assemblies described in Table A-9.36.2.8.(1)-A do not necessarily address other structural or building envelope requirements (see Section 9.25.).

**Table A-9.36.2.8.(1)-A**  
**Minimum Nominal Thermal Resistance (RSI) to be Made up by Insulation, Sheathing or Other Materials and Air Films in Wall Assemblies Below-Grade or in Contact with the Ground**

Description of Framing or Material	Size and Spacing of Wood Framing	Thermal Resistance of Insulated Assembly			Minimum Effective Thermal Resistance Required by Article 9.36.2.8. for Wall Assemblies Below-Grade or in Contact with the Ground, (m <sup>2</sup> -K)/W			
		Nominal, (m <sup>2</sup> -K)/W (ft <sup>2</sup> -°F-h/Btu)		Effective, (m <sup>2</sup> -K)/W	1.99	2.98	3.46	3.97
		Insulation in Framing Cavity	Continuous Materials	Entire Assembly	Minimum Nominal Thermal Resistance, <sup>(1)</sup> in (m <sup>2</sup> -K)/W, to be Made up by Insulation, Sheathing <sup>(2)</sup> or Other Materials and Air Film Coefficients			
200 mm cast-in-place concrete	38 x 89 mm, 610 mm o.c.	2.11 (R12)	None	1.79	0.20	1.19	1.67	2.18
			1.41 (R8)	3.20	—	—	0.26	0.77
		2.46 (R14)	1.76 (R10)	3.75	—	—	—	0.22
	38 x 140 mm, 610 mm o.c.	3.34 (R19) <sup>(3)</sup>	None	2.78	—	0.20	0.68	1.19
		4.23 (R24)	None	3.26	—	—	0.20	0.71
	None	n/a	1.76 (R10)	1.84	0.15	1.14	1.62	2.13
			2.64 (R15)	2.72	—	0.26	0.74	1.25
			3.52 (R20) <sup>(3)</sup>	3.60	—	—	—	0.37
	190 mm concrete block masonry: normal-weight, no insulation in cores	38 x 89 mm, 610 mm o.c.	2.11 (R12)	None	1.92	0.07	1.06	1.54
1.41 (R8)				3.33	—	—	0.13	0.64
2.11 (R12)				4.03	—	—	—	—
38 x 140 mm, 610 mm o.c.		3.34 (R19) <sup>(3)</sup>	None	2.91	—	0.07	0.55	1.06
		4.23 (R24)	None	3.39	—	—	0.07	0.58
None		n/a	1.76 (R10)	1.97	0.02	1.01	1.49	2.00
			2.64 (R15)	2.85	—	0.13	0.61	1.12
			3.52 (R20) <sup>(3)</sup>	3.73	—	—	—	0.24

**Table A-9.36.2.8.(1)-A (Continued)**

Description of Framing or Material	Size and Spacing of Wood Framing	Thermal Resistance of Insulated Assembly			Minimum Effective Thermal Resistance Required by Article 9.36.2.8. for Wall Assemblies Below-Grade or in Contact with the Ground, (m <sup>2</sup> -K)/W			
		Nominal, (m <sup>2</sup> -K)/W (ft <sup>2</sup> ·°F·h/Btu)		Effective, (m <sup>2</sup> -K)/W	1.99	2.98	3.46	3.97
		Insulation in Framing Cavity	Continuous Materials	Entire Assembly	Minimum Nominal Thermal Resistance, <sup>(1)</sup> in (m <sup>2</sup> -K)/W, to be Made up by Insulation, Sheathing <sup>(2)</sup> or Other Materials and Air Film Coefficients			
190 mm concrete block masonry: light-weight, no insulation in cores	38 x 89 mm, 610 mm o.c.	2.11 (R12)	None	2.03	—	0.95	1.43	1.94
			1.41 (R8)	3.44	—	—	0.02	0.53
			2.11 (R12)	4.14	—	—	—	—
	38 x 140 mm, 610 mm o.c.	3.34 (R19) <sup>(3)</sup>	None	3.02	—	—	0.44	0.95
		4.23 (R24)	None	3.50	—	—	—	0.47
	None	n/a	1.76 (R10)	2.08	—	0.90	1.38	1.89
			2.64 (R15)	2.96	—	0.02	0.50	1.01
			3.52 (R20)	3.84	—	—	—	0.13
			3.52 (R20) <sup>(3)</sup>	3.58	—	—	—	0.39
Insulating concrete form (ICF): <sup>(4)</sup> 150 mm concrete	n/a	n/a	3.73 (R21.2)	3.79	—	—	—	0.18
			3.34 (R19) <sup>(3)</sup>	None	2.33	—	0.65	1.13
Pressure-treated wood frame	38 x 140 mm, 203 mm o.c.	4.23 (R24)	None	2.62	—	0.36	0.84	1.35
		4.93 (R28)	None	2.81	—	0.17	0.65	1.16
	38 x 235 mm, 203 mm o.c.	5.28 (R31)	None	3.86	—	—	—	0.11
	38 x 140 mm, 406 mm o.c.	3.34 (R19) <sup>(3)</sup>	None	2.59	—	0.39	0.87	1.38
		4.23 (R24)	None	3.00	—	—	0.46	0.97
	38 x 186 mm, 406 mm o.c.	4.93 (R28)	None	3.85	—	—	—	0.12
	38 x 235 mm, 406 mm o.c.	5.28 (R31)	None	4.11	—	—	—	—

**Notes to Table A-9.36.2.8.(1)-A:**

- (1) A dash (—) means that no additional materials are needed in order to meet the minimum required effective thermal resistance for the assembly in question; however, sheathing may be required for fastening of cladding or lateral bracing.
- (2) Wood-based sheathing ≥ 11 mm thick generally has a thermal resistance of 0.11 (m<sup>2</sup>-K)/W (R0.62). However, thicker sheathing may be required for structural stability or fastening of cladding. Note that thinner R0.62 wood-based sheathing products are also available (see Table A-9.36.2.4.(1)-D).
- (3) When RSI 3.52 (R20) insulation batts are installed in 140 mm wood framing, they undergo some compression, which reduces their original RSI value to 3.34 (m<sup>2</sup>-K)/W (R19). However, when they are installed in 152 mm metal framing or in a wood frame that is offset from the back-up wall, R20 batts retain their original thermal resistance value.
- (4) There are many types of ICF designs with different form thicknesses and tie configurations. Where ICF systems incorporate metal ties, thermal bridging should be accounted for.

Tables A-9.36.2.8.(1)-B and A-9.36.2.8.(1)-C can be used to determine the total effective thermal resistance (RSI) value of the framing/cavity portion of a number of typical below-grade wall assemblies as well as some atypical ones not covered in Table A-9.36.2.8.(1)-A. Additional configurations and assembly types are listed in EnergyStar tables available online at <http://ENERGYSTARforNewHomesStandard.NRCan.gc.ca>.

Select the applicable stud/joist size and spacing and the RSI/R-value of the insulation to obtain the resultant effective RSI value for that frame configuration. If the RSI/R-value of the insulation product to be installed falls between two RSI/R-values listed in the Table, the lower value must be used. Once the effective RSI value of the framing/cavity portion is known, add up the nominal RSI values of all other materials in the assembly (see Table A-9.36.2.4.(1)-D) to obtain the total effective RSI value of the entire assembly. See the calculation examples in Note A-9.36.2.4.(1) for further guidance.

**Table A-9.36.2.8.(1)-B**  
**Effective Thermal Resistance (RSI) Values of the Framing/Cavity Portion of Pressure-treated Foundation Wall Assemblies**

Nominal Thermal Resistance of Cavity Insulation		Size, mm, and Spacing, mm o.c., of Pressure-treated Wood-frame Foundation Wall Assembly					
		38 x 185			38 x 235		
		203	304	406	203	304	406
RSI, (m <sup>2</sup> ·K)/W	R, ft <sup>2</sup> ·°F·h/Btu	Effective Thermal Resistance of Framing/Cavity Portion, <sup>(1)</sup> (m <sup>2</sup> ·K)/W					
2.11	12	1.95	1.98	2.00	2.08	2.09	2.09
2.29	13	2.06	2.10	2.13	2.21	2.23	2.24
2.47	14	2.17	2.23	2.26	2.34	2.36	2.38
2.64	15	2.27	2.33	2.38	2.45	2.49	2.51
2.82	16	2.36	2.45	2.50	2.57	2.62	2.65
2.99	17	2.45	2.55	2.61	2.67	2.73	2.77
3.17	18	2.54	2.65	2.72	2.78	2.85	2.90
3.34	19	2.62	2.75	2.83	2.88	2.96	3.02
3.52	20	2.71	2.84	2.93	2.98	3.07	3.14
3.70	21	2.79	2.94	3.04	3.07	3.18	3.26
3.87	22	2.86	3.02	3.13	3.16	3.28	3.37
4.05	23	2.93	3.11	3.23	3.25	3.39	3.48
4.23	24	3.00	3.20	3.32	3.34	3.49	3.59
4.40	25	3.07	3.27	3.41	3.41	3.58	3.69
4.58	26	3.13	3.35	3.50	3.50	3.68	3.79
4.76	27	3.19	3.43	3.59	3.57	3.77	3.90
4.93	28	3.25	3.50	3.67	3.65	3.85	3.99
5.11	29	3.31	3.57	3.75	3.72	3.94	4.09
5.28	30	3.36	3.64	3.83	3.79	4.02	4.18
5.46	31	3.42	3.71	3.90	3.86	4.11	4.27

**Notes to Table A-9.36.2.8.(1)-B:**

(1) These RSI values are valid where the cavity is completely filled with insulation and they do not account for air space in the cavity.

**Table A-9.36.2.8.(1)-C**  
**Effective Thermal Resistance (RSI) Values of the Framing/Cavity Portion of Below-Grade Interior Non-loadbearing Wood-frame Wall Assemblies**

Nominal Thermal Resistance of Cavity Insulation		Size, mm, and Spacing, mm o.c., of Below-Grade Interior Non-loadbearing Wood-frame Wall Assembly							
		38 x 89				38 x 140			
		203	304	406	610	203	304	406	610
RSI, (m <sup>2</sup> ·K)/W	R, ft <sup>2</sup> ·°F·h/Btu	Effective Thermal Resistance of Framing/Cavity Portion, <sup>(1)</sup> (m <sup>2</sup> ·K)/W							
0.00	0	0.22	0.21	0.20	0.20	—	—	—	—
1.41	8	1.17	1.21	1.24	1.27	—	—	—	—
1.94	11	1.41	1.50	1.55	1.61	—	—	—	—
2.11	12	1.48	1.57	1.64	1.71	—	—	—	—
2.29	13	1.54	1.65	1.73	1.81	—	—	—	—
2.47	14	1.60	1.73	1.81	1.91	—	—	—	—
2.64	15	1.65	1.79	1.89	1.99	—	—	—	—
2.82	16	1.70	1.86	1.96	2.08	2.12	2.24	2.31	2.39
2.99	17	1.75	1.92	2.03	2.16	2.19	2.32	2.41	2.50
3.17	18	1.80	1.97	2.10	2.24	2.27	2.41	2.50	2.61
3.34	19	1.84	2.03	2.16	2.31	2.33	2.49	2.59	2.70
3.52	20	1.88	2.08	2.22	2.39	2.39	2.57	2.68	2.81
3.70	21	1.91	2.13	2.28	2.46	2.46	2.64	2.77	2.90
3.87	22	1.95	2.17	2.33	2.52	2.51	2.71	2.84	2.99
4.05	23	1.98	2.22	2.39	2.59	2.57	2.78	2.93	3.09
4.23	24	2.01	2.26	2.44	2.65	2.62	2.85	3.00	3.18
4.40	25	—	—	—	—	2.67	2.91	3.07	3.26
4.58	26	—	—	—	—	2.72	2.97	3.15	3.34
4.76	27	—	—	—	—	2.77	3.03	3.22	3.42
4.93	28	—	—	—	—	2.81	3.09	3.28	3.50

**Notes to Table A-9.36.2.8.(1)-C:**

(1) These RSI values are valid where the cavity is completely filled with insulation and they do not account for air space in the cavity. A dash (—) means that it is not feasible to install the cavity insulation listed within the frame configuration in question.

**A-Tables 9.36.2.8.-A and -B Multiple Applicable Requirements.** In cases where a single floor assembly is made up of several types of the floor assemblies listed in Tables 9.36.2.8.-A and 9.36.2.8.-B, each portion of that floor must comply with its respective applicable RSI value. For example, in the case of a walkout basement, the portion of floor that is above the frost line—i.e. the walkout portion—should be insulated in accordance with the values listed in the applicable Table whereas the portion below the frost line can remain uninsulated.

**A-9.36.2.8.(2) Combination Floor Assemblies.** An example of a floor assembly to which Sentence 9.36.2.8.(2) would apply is a heated slab-on-grade with an integral footing.

**A-9.36.2.8.(4) Unheated Floors-on-ground Above the Frost Line.** Figure A-9.36.2.8.(4) illustrates the insulation options for unheated floors-on-ground that are above the frost line.

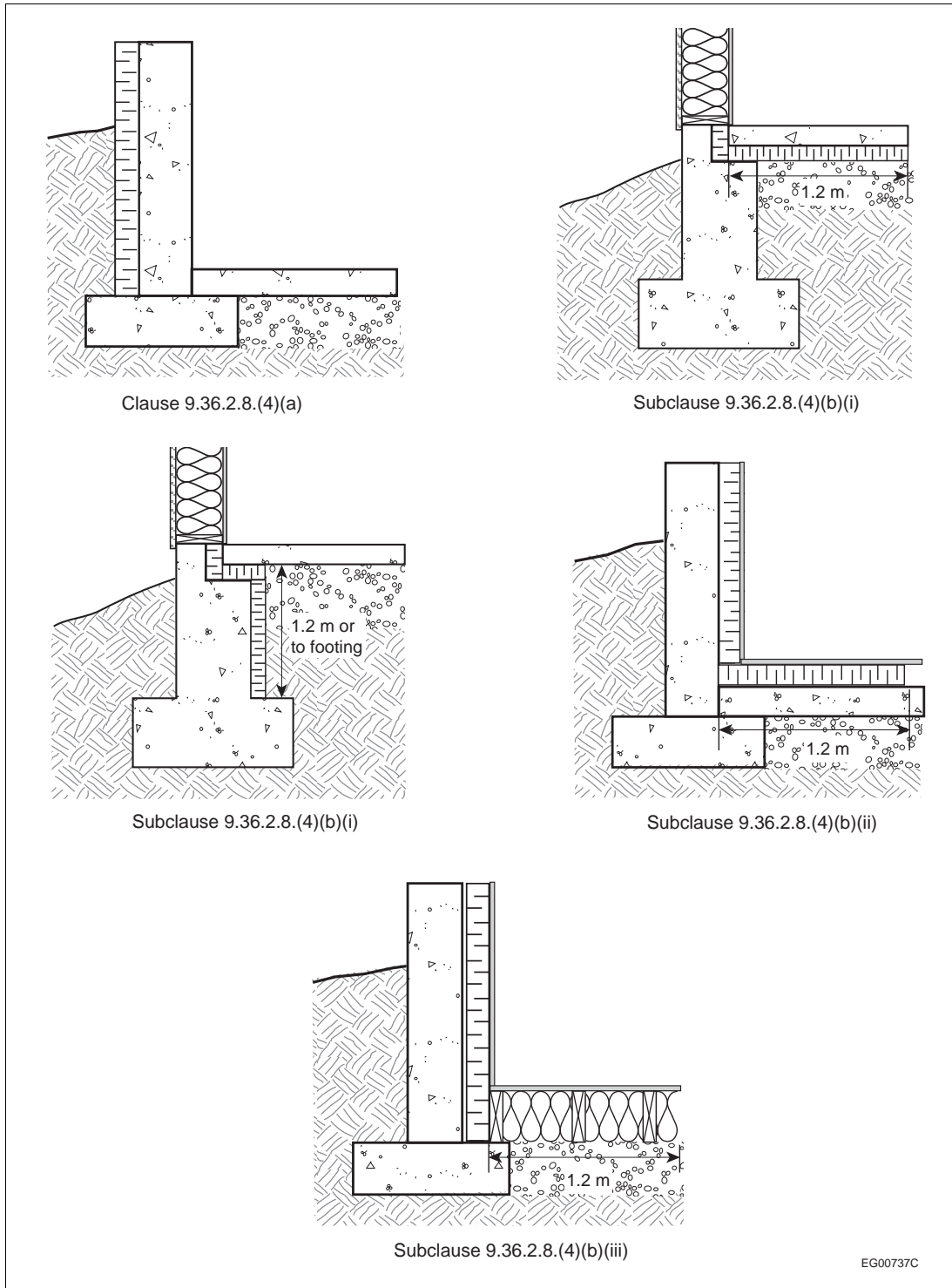


Figure A-9.36.2.8.(4)  
Options for insulating unheated floors-on-ground

**A-9.36.2.8.(9) Skirt Insulation.** “Skirt insulation” refers to insulation installed on the exterior perimeter of the foundation and extended outward horizontally or at a slope away from the foundation. In cold climates, skirt insulation is typically extended 600 to 1000 mm out from the vertical foundation wall over the footings to reduce heat loss from the house into the ground and to reduce the chance of frost forming under the footings.

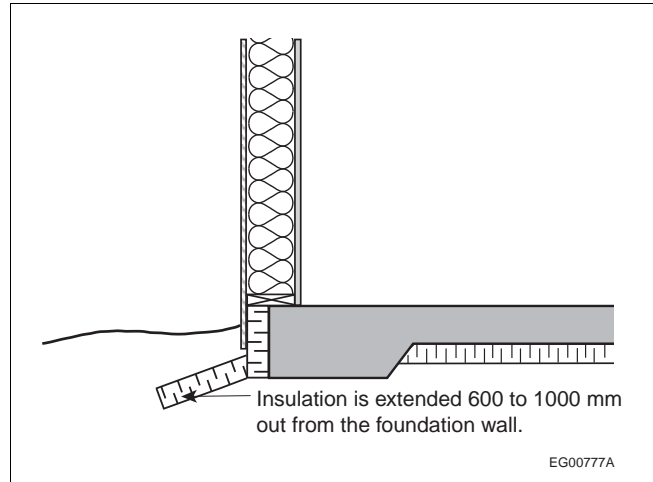


Figure A-9.36.2.8.(9)  
Skirt insulation

### A-9.36.2.9.(1) Controlling air leakage.

#### Airtightness Options

Sentence 9.36.2.9.(1) presents three options for achieving an airtight building envelope: one prescriptive option (Clause (a)) and two testing options (Clauses (b) and (c)).

#### Air Barrier Assembly Testing

Air barrier assemblies are subjected to structural loading due to mechanical systems, wind pressure and stack effect. In addition, they may be affected by physical degradation resulting from thermal and structural movement. Both CAN/ULC-S742, “Air Barrier Assemblies – Specification,” and ASTM E 2357, “Determining Air Leakage of Air Barrier Assemblies,” outline testing limits for such issues, which can compromise the performance of the air barrier assembly. Where local climatic data and building conditions exceed these limits, the maximum building height and sustained 1-in-50 hourly wind pressure values covered in Table 1 of CAN/ULC-S742 are permitted to be extrapolated beyond the listed ranges to apply to any building height, in any location, provided the air barrier assembly in question has been tested to the specific building site and design parameters. However, air barrier assemblies tested to ASTM E 2357 are not subjected to temperature variations during testing, and there is no indication that testing data is permitted to be extrapolated beyond the 0.65 kPa limit.

#### Air Barrier System Approaches

For an air barrier system to be effective, all critical junctions and penetrations addressed in Articles 9.36.2.9. and 9.36.2.10. must be sealed using either an interior or exterior air barrier approach or a combination of both.

The following are examples of typical materials and techniques used to construct an interior air barrier system:

- airtight-drywall approach
- sealed polyethylene approach
- joint sealant method
- rigid panel material (i.e. extruded polystyrene)
- spray-applied foams
- paint or parging on concrete masonry walls or cast-in-place concrete

Where the air barrier and vapour barrier functions are provided by the same layer, it must be installed toward the warm (in winter) side of the assembly or, in the case of mass walls such as those made of cast-in place concrete, provide resistance to air leakage through much of the thickness of the assembly. Where these functions are provided by separate elements, the vapour barrier is required to be installed toward the interior of the assembly while the airtight element can be installed toward the interior or exterior depending on its vapour permeance.

The following are examples of typical materials and techniques used to construct an exterior air barrier system:

- rigid panel material (i.e. extruded polystyrene)
- house wraps
- peel-and-stick membranes
- liquid-applied membranes

When designing an exterior air barrier system, consideration should be given to the strength of the vapour barrier and expected relative humidity levels as well as to the climatic conditions at the building's location and the properties of adjoining materials.

**A-9.36.2.9.(5) Making Fireplaces Airtight.** Besides fireplace doors, other means to reduce air leakage through fireplaces are available; for example, installing a glass-enclosed fireplace.

**A-9.36.2.9.(6) Exterior Air Barrier Design Considerations.** Any airtight assembly—whether interior or exterior—will control air leakage for the purpose of energy efficiency. However, the materials selected and their location in the assembly can have a significant impact on their effectiveness with regard to moisture control and the resistance to deterioration of the entire building envelope.

**A-9.36.2.10.(5)(b) Sealing the Air Barrier System with Sheathing Tape.** One method of sealing air barrier materials at joints and junctions is to apply sheathing tape that has an acceptable air leakage characteristic, is compatible with the air barrier material and resistant to the mechanisms of deterioration to which the air barrier material will be exposed. Where an assembly tested to CAN/ULC-S742, "Air Barrier Assemblies – Specification," includes sheathing tape as a component, the sheathing tape will have been tested for compatibility and resistance to deterioration and will be referenced in the manufacturer's literature as acceptable for use with that air barrier assembly.

**A-9.36.2.10.(7)(a) Components Designed to Provide a Seal at Penetrations.** An example of the component referred to in Clause 9.36.2.10.(7)(a) is a plastic surround for electrical outlet boxes that has a flange to which sealant can be applied or that has an integrated seal.

**A-9.36.2.10.(9) Sealing the Air Barrier around Windows, Doors and Skylights.** A continuous seal between windows, doors and skylights and adjacent air barrier materials can be achieved by various means including applying exterior sealant, interior sealant, low-expansion foam or sheathing tape in combination with drywall, polyethylene, a closed-cell backer rod, or a wood liner.

**A-9.36.2.10.(14) Sealing Duct Penetrations.** Article 9.32.3.11. requires that joints in all ventilation system ducting be sealed with mastic, metal foil duct tape or sealants specified by the manufacturer. Sentence 9.36.2.10.(14) requires that penetrations made by ducts through ceilings or walls be sealed with appropriate sealant materials and techniques to prevent air leakage. Mechanical fastening of the duct at the penetration may further reduce the likelihood of air leakage through the penetration.

**A-9.36.2.11. Concept of Trade-offs.** The trade-off options presented in Sentences 9.36.2.11.(2) to (4) afford some degree of flexibility in the design and construction of energy-efficient features in houses and buildings as they allow a builder/designer to install one or more assemblies with a lower RSI value than that required in Articles 9.36.2.1. to 9.36.2.7. as long as the discrepancy in RSI value is made up by other assemblies and that the total area of the traded assemblies remains the same.

#### Limitations to Using Trade-off Options

In some cases, the energy-conserving impact of requirements cannot be easily quantified and allowing trade-offs would be unenforceable: this is the case, for instance, for airtightness requirements (Article 9.36.2.10.). In other cases, no credit can be given for improving energy performance where the Code permits reduced performance: for example, the Code allows insulation to be reduced at the eaves under a sloped roof so no credit can be given for installing raised heel trusses to accommodate the full

insulation value otherwise required by the Code; in other words, the increased RSI value that would be achieved with the raised truss cannot be traded.

Furthermore, the trade-off calculations only address conductive heat loss through the building envelope and are therefore limited in their effectiveness at keeping the calculated energy performance of a building in line with its actual energy performance, which includes solar heat gains. The limitations stated in Sentence 9.36.2.11.(6) address this by ensuring that the thermal resistances are relatively evenly distributed across all building assemblies.

**Terms Used in Trade-off Provisions**

For the purposes of Article 9.36.2.11., the term “reference” (e.g. reference assembly) refers to a building element that complies with the prescriptive requirements of Articles 9.36.2.1. to 9.36.2.7., whereas the term “proposed” refers to a building element whose RSI value can be traded in accordance with Sentence 9.36.2.11.(2), (3) or (4), as applicable.

**A-9.36.2.11.(2) Trading RSI Values of Above-Ground Opaque Building Envelope**

**Assemblies.** Sentence 9.36.2.11.(2) applies where a designer wants to use a wall or ceiling assembly with a lower effective thermal resistance than required by Subsection 9.36.2. in one building envelope area and an assembly with a compensating higher effective thermal resistance in another building envelope area to achieve the same energy performance through the combined total areas as would be achieved by complying with Subsection 9.36.2.

**Example**

A designer wants to reduce the insulation in 40 m<sup>2</sup> of wall area in the proposed design from the required effective RSI value of 3.27 (R24 batts in a 38 x 140 mm frame, 406 mm o.c.) to a value of 2.93 (R20 batts). The proposed design has 200 m<sup>2</sup> of attic space where more insulation could be added to compensate for the lower RSI value in the 40 m<sup>2</sup> of wall.

Assemblies Being Traded	Area of Each Assembly (A)	Reference Design Values		Proposed Design Values	
		RSI values (R)	A/R Values	RSI values (R)	A/R Values
Attic	200 m <sup>2</sup>	8.66 (m <sup>2</sup> -K)/W	23.09 W/K	8.66 (m <sup>2</sup> -K)/W	23.09 W/K
Wall	40 m <sup>2</sup>	3.27 (m <sup>2</sup> -K)/W	12.23 W/K	2.93 (m <sup>2</sup> -K)/W	13.65 W/K
		Total A/R value: 35.32 W/K		Total A/R value: 36.74 W/K	

The increased total A/R value for the attic and wall assemblies of the proposed design, which is caused by less insulation in the wall, now has to be compensated for by an increase in attic insulation while keeping the respective areas of the building assemblies constant. To determine the RSI value to be made up by insulation in the attic (i.e. increase in effective thermal resistance of attic assembly), first calculate the difference between the two total A/R values:

$$36.74 \text{ W/K} - 35.32 \text{ W/K} = 1.42 \text{ W/K}$$

Then, subtract this residual A/R value from the A/R value required for the attic insulation:

$$23.09 \text{ W/K} - 1.42 \text{ W/K} = 21.67 \text{ W/K}$$

Adding this decreased A/R value for the proposed attic to the increased A/R value for the proposed wall now gives a total A/R value that is less than or equal to that of the reference design:

$$21.67 \text{ W/K} + 13.65 \text{ W/K} = 35.32 \text{ W/K}$$

To determine the RSI value to be made up by insulation in the attic of the proposed design, divide the area of the attic by the decreased A/R value required for the attic of the proposed design (21.67 W/K):

$$200 \text{ m}^2 / 21.67 \text{ W/K} = 9.23 \text{ (m}^2\text{-K)/W (R52.4)}$$

Assemblies Being Traded	Area of Each Assembly (A)	Reference Design Values		Proposed Design Trade-off Values	
		RSI values (R)	A/R Values	RSI values (R)	A/R Values
Attic	200 m <sup>2</sup>	9.23 (m <sup>2</sup> -K)/W	21.67 W/K	9.23 (m <sup>2</sup> -K)/W	21.67 W/K
Wall	40 m <sup>2</sup>	3.27 (m <sup>2</sup> -K)/W	12.23 W/K	2.93 (m <sup>2</sup> -K)/W	13.65 W/K
		Total A/R value: 35.32 W/K		Total A/R value: 35.32 W/K	



**A-9.36.2.11.(2) and (3) Calculating Trade-off Values.** To trade effective thermal resistance values between above-ground building envelope components or assemblies, the ratios of area and effective thermal resistance of all such components or assemblies for the reference case (in which all components and assemblies comply with Article 9.36.2.6.) and the proposed case (in which the effective thermal resistance values of some areas are traded) must be added up and compared using the following equation:

$$\sum_{i=1}^n \frac{A_{ir}}{R_{ir}} \geq \sum_{i=1}^n \frac{A_{ip}}{R_{ip}}$$

where

- $R_{ir}$  = effective thermal resistance of assembly  $i$  of the reference case,
- $A_{ir}$  = area of assembly  $i$  of the reference case,
- $R_{ip}$  = effective thermal resistance of assembly  $i$  of the proposed case,
- $A_{ip}$  = area of assembly  $i$  of the proposed case,
- $n$  = total number of above-ground components or assemblies, and
- $i = 1, 2, 3, \dots, n$ .

The sum of the areas of the above-ground assemblies being traded in the proposed case ( $A_{ip}$ ) must remain the same as the sum of the areas of the corresponding above-ground assemblies in the reference case ( $A_{ir}$ ). Only the trade-off option described in Sentence 9.36.2.11.(4) allows a credit for a reduction in window area where the window to gross wall area ratio is less than 17%.

**A-9.36.2.11.(3) Trading R-values of Windows.** Sentence 9.36.2.11.(3) applies where a designer wants to install one or more windows having a U-value above the maximum permitted by Article 9.36.2.7. and reduce the U-value of other windows to achieve the same overall energy performance through the combined total area of all windows as would be achieved by complying with Article 9.36.2.7. (Note that R-values, not U-values as are typically used in relation to windows, are used in this Note.)

**Example**

A designer wants to install a large stained glass window on the south side of the proposed house as well as other windows for a total 12 m<sup>2</sup> in area. The designer wants the stained glass window to have a U-value of 2.7 W/(m<sup>2</sup>·K) (R-value 0.37 (m<sup>2</sup>·K)/W), which is higher than the maximum permitted by Subsection 9.7.3. for condensation resistance, and proposes to compensate for its reduced energy performance by reducing the U-value of the remaining windows on that side, which total 10 m<sup>2</sup>.

Assemblies on South Side	Total Area of Assemblies (A)	Reference Design Values	
		R-value (R)	A/R Value
Windows	12 m <sup>2</sup>	0.56 (m <sup>2</sup> ·K)/W	21.54 W/K
		Total A/R value: 21.54 W/K	
Assemblies Being Traded on South Side	Total Area of Assemblies (A)	Proposed Design Values	
		R-value (R)	A/R Values
Stained glass window	2 m <sup>2</sup>	0.37 (m <sup>2</sup> ·K)/W	5.41 W/K
Other windows	10 m <sup>2</sup>	0.56 (m <sup>2</sup> ·K)/W	17.86 W/K
		Total A/R value: 23.27 W/K	
<p>The increased total A/R value for the window assemblies on the south side of the proposed house, which is due to the stained glass window, now has to be compensated for by better windows (i.e. with a lower U-value than the maximum allowed) while keeping the total area of windows in the house constant (12 m<sup>2</sup>). To determine the R-value required to be made up by the rest of the windows on the south side, first calculate the difference between the two total A/R values:</p> $23.27 \text{ W/K} - 21.54 \text{ W/K} = 1.73 \text{ W/K}$ <p>This value (1.73 W/K) now has to be subtracted from the A/R value for the 10 m<sup>2</sup> of windows to determine the compensating energy performance needed:</p> $17.86 \text{ W/K} - 1.73 \text{ W/K} = 16.13 \text{ W/K}$ <p>Adding this decreased A/R value for the windows to the increased A/R value for the stained glass window will now give a total A/R value that is less than or equal to that of the reference design:</p> $16.13 \text{ W/K} + 5.41 \text{ W/K} = 21.54 \text{ W/K}$ <p>To determine the R-value to be made up by the rest of the windows on the south side of the proposed house, divide the area of the remaining windows by the decreased A/R value for the 10 m<sup>2</sup> of windows:</p> $10 \text{ m}^2 / 16.13 \text{ W/K} = 0.62 \text{ (m}^2\text{·K)/W (or a U-value of 1.6 W/(m}^2\text{·K))}$			
Assemblies Being Traded on South Side	Total Area of Assemblies (A)	Proposed Design Trade-off Values	
		R-values (R)	A/R Values
Stained glass window	2 m <sup>2</sup>	0.37 (m <sup>2</sup> ·K)/W	5.41 W/K
Other windows	10 m <sup>2</sup>	0.62 (m <sup>2</sup> ·K)/W	16.13 W/K
		Total A/R value: 21.54 W/K	

**A-9.36.2.11.(4) RSI Values of Insulation in Attics under Sloped Roofs.**

**Trade-off Option for Buildings with Low Ceilings**

The trade-off option presented in Sentence 9.36.2.11.(4) relating to buildings with a low floor-to-ceiling height and a relatively low window and door area to wall area ratio recognizes the proven energy performance of single-section factory-constructed buildings, which have very low sloped roofs in order to comply with transportation height limitations. This option is provided to avoid unnecessarily imposing performance modeling costs. It is unlikely to be applied to site-constructed buildings or to factory-constructed buildings that are not subject to stringent transportation height restrictions because low ceilings are not the preferred choice, and the cost of cutting framing and interior finish panel products to size would exceed the cost of meeting the prescriptive attic and floor insulation levels.

**Trade-off Calculation**

The trade-off option presented in Sentence 9.36.2.11.(4) allows the trading of a credit based on the difference between the reference (prescriptive) and actual (proposed) window and door area. This credit can be used to reduce the required effective thermal resistance of all ceiling or floor assemblies (attics).

$$\frac{(A_{w,r(17\%)} - A_{w,p(max. 15\%)})}{R_{w,r}} \geq \sum_{i=1}^n \frac{A_{i,c/f,r}}{R_{i,c/f,r}} - \sum_{i=1}^n \frac{A_{i,c/f,p}}{R_{i,c/f,p}}$$

where

- $R_{i,c/f,r}$  = effective thermal resistance of ceiling/floor assembly i of the reference case,
- $A_{i,c/f,r}$  = area of ceiling/floor assembly i of the reference case,
- $R_{i,c/f,p}$  = effective thermal resistance of ceiling/floor assembly i of the proposed case,
- $A_{i,c/f,p}$  = area of ceiling/floor assembly i of the proposed case,
- $A_{w,r(17\%)}$  = area of windows constituting 17% of gross wall area (see Article 9.36.2.3.),
- $R_{w,r}$  = effective thermal resistance of windows (see Article 9.36.2.7.),
- $A_{w,p(max.15\%)}$  = area of windows constituting 15% or less of gross wall area (see Article 9.36.2.3.),
- $n$  = total number of ceiling/floor assemblies, and
- $i = 1, 2, 3, \dots, n.$

The sum of  $A_{i,c/f,p}$  must equal the sum of  $A_{i,c/f,r}$ . The sum of the areas of all other building envelope assemblies must remain the same in both the proposed and reference cases.

**Trading Window Area for Reduced Attic Insulation**

Sentence 9.36.2.11.(4) applies where a proposed design has a fenestration and door area to gross wall area ratio (FDWR) of 15% or less. The resulting reduction in energy loss due to the fact that there are fewer windows is traded for a reduction in R-value for a specific area in the attic where it is impossible to install the required insulation level due to roof slope.

**Example**

A designer wants to use a FDWR of 12% in the proposed design in order to be able to install less insulation in the 100 m <sup>2</sup> of attic space.			
Assemblies Being Traded	Area of Each Assembly (A)	Reference Design Values (FDWR 17%)	
		RSI values (R)	A/R Values
Attic	100 m <sup>2</sup>	8.67 (m <sup>2</sup> ·K)/W	11.5 W/K
Windows	25 m <sup>2</sup>	0.63 (m <sup>2</sup> ·K)/W	39.7 W/K
		Total A/R value: 51.2 W/K	
Assemblies Being Traded	Area of Each Assembly (A)	Proposed Design Values (FDWR 12%)	
		RSI values (R)	A/R Values
Attic	100 m <sup>2</sup>	8.67 (m <sup>2</sup> ·K)/W	11.5 W/K
Windows	18 m <sup>2</sup>	0.63 (m <sup>2</sup> ·K)/W	28.6 W/K
		Total A/R value: 40.1 W/K	
To determine the reduction in RSI value permitted for the attic insulation in the proposed design, first calculate the difference between the two A/R values:			
$51.2 \text{ W/K} - 40.1 \text{ W/K} = 11.1 \text{ W/K}$			
This residual A/R value can now be used as a credit towards the A/R value of the attic insulation in the proposed design:			
$11.1 \text{ W/K} + 11.5 \text{ W/K} = 22.6 \text{ W/K}$			
Adding this increased A/R value for the proposed attic to the A/R value for the proposed window area will now give a total A/R value that is less than or equal to that of the reference design:			
$22.6 \text{ W/K} + 28.6 \text{ W/K} = 51.2 \text{ W/K}$			
To determine the new RSI value of the attic insulation, divide the area of the attic by its new increased A/R value:			
$100 \text{ m}^2 / 22.6 \text{ W/K} = 4.42 \text{ (m}^2\text{·K)/W}$			
Because Clause 9.36.2.11.(6)(b) limits the reduction of a traded RSI value for opaque building envelope assemblies—in this case, an attic—to 60% of the minimum RSI value permitted by Article 9.36.2.6., this new RSI value of 4.42 (m <sup>2</sup> ·K)/W for the attic is too low (60% x 8.67 = 5.20 (m <sup>2</sup> ·K)/W). Therefore, the full potential trade-off for this example cannot be used.			
Assemblies Being Traded	Area of Each Assembly (A)	Proposed Design Trade-off Values (FDWR 12%)	
		RSI values (R)	A/R Values
Attic	100 m <sup>2</sup>	5.20 (m <sup>2</sup> ·K)/W	19.2 W/K
Windows	18 m <sup>2</sup>	0.63 (m <sup>2</sup> ·K)/W	28.6 W/K
		Total A/R value: 47.8 W/K (< 51.2 W/K)	

**A-9.36.2.11.(6)(a) Reduction in Thermal Resistance of Ceilings in Buildings with Low Ceilings.** Sentence 9.36.2.11.(4) allows insulation in attics under sloped roofs to be reduced to less than the prescriptive level required for the exterior walls, which may be less than 55% of the required values for the attic insulation.

**A-9.36.3.2.(1) Load Calculations.** Subsection 9.33.5. requires that heating systems serving single dwelling units be sized in accordance with CSA F280, “Determining the Required Capacity of Residential Space Heating and Cooling Appliances.” The HRAI Digest is also a useful source of information on the sizing of HVAC systems for residential buildings.

**A-9.36.3.2.(2) Design and Installation of Ducts.** The following publications contain useful information on this subject:

- the ASHRAE Handbooks
- the HRAI Digest
- the ANSI/SMACNA 006, “HVAC Duct Construction Standards – Metal and Flexible”

**A-9.36.3.2.(5) Increasing the Insulation on Sides of Ducts.** Table A-9.36.3.2.(5) can be used to determine the level of insulation needed on the sides of ducts that are 127 mm deep to compensate for a reduced level of insulation on their underside.

Table A-9.36.3.2.(5)  
RSI Required on Sides of Ducts where RSI on Underside is Reduced

RSI Required for Exterior Walls, <sup>(1)</sup> (m <sup>2</sup> ·K)/W	RSI <sup>(2)</sup> on Underside of 127 mm Deep Duct, (m <sup>2</sup> ·K)/W	Width of Duct, mm						
		304	356	406	457	483	508	533
		RSI Required on Sides of Ducts, (m <sup>2</sup> ·K)/W						
2.78	2.11	4.47	4.98	5.61	6.43	6.94	n/a	n/a
	2.29	3.74	3.97	4.23	4.52	4.69	4.86	5.05
	2.64	2.97	3.00	3.03	3.07	3.09	3.10	3.12
2.96	2.11	5.70	6.75	8.25	n/a	n/a	n/a	n/a
	2.29	4.56	5.02	5.58	6.27	6.68	n/a	n/a
	2.64	3.46	3.57	3.67	3.78	3.84	3.90	3.97
3.08	2.29	5.26	5.96	6.88	n/a	n/a	n/a	n/a
	2.64	3.85	4.02	4.20	4.40	4.50	4.62	4.73
3.85	3.43	4.67	4.84	5.03	5.23	5.34	5.45	5.56

Notes to Table A-9.36.3.2.(5):

(1) See Article 9.36.2.6.

(2) See Note A-9.36.1.2.(3) for the formula to convert metric RSI values to imperial R values.

**A-9.36.3.3.(4) Exemption.** The exemption in Sentence 9.36.3.3.(4) typically applies to heat-recovery ventilators and ventilation systems that are designed to run or are capable of running continuously for specific applications. See also Sentence 9.32.3.13.(8).

**A-9.36.3.4.(1) Piping for Heating and Cooling Systems.** CSA B214, “Installation Code for Hydronic Heating Systems,” the ASHRAE Handbooks, the HRAI Digest, and publications of the Hydronics Institute are useful sources of information on the design and installation of piping for heating and cooling systems.

**A-9.36.3.4.(2) High-Temperature Refrigerant Piping.** Piping for heat pumps is an example of high-temperature refrigerant piping.

**A-9.36.3.5.(1) Location of Heating and Air-conditioning Equipment.** Locating certain types of equipment for heating and air-conditioning systems—for example, heat-recovery ventilators or furnaces—outdoors or in an unconditioned space may result in lower efficiencies and higher heat loss. Where components of a system are intended to be installed outside—for example, portions of heat pump systems and wood-fired boilers—efficiency losses, if any, have already been accounted for in their design.

**A-9.36.3.6.(7) Heat Pump Controls for Recovery from Setback.** The requirements of Sentence 9.36.3.6.(7) can be achieved through several methods:

- installation of a separate exterior temperature sensor,
- setting a gradual rise of the control point,
- installation of controls that “learn” when to start recovery based on stored data.

**A-9.36.3.8. Application.** Article 9.36.3.8. is intended to apply to any vessel containing open water in an indoor setting, not only swimming pools and hot tubs; however, it does not apply to bathtubs. In the context of this Article, the terms “hot tub” and “spa” are interchangeable.

**A-9.36.3.8.(4)(a) Heat Recovery from Dehumidification in Spaces with an Indoor Pool or Hot Tub.** Sentence 9.36.3.8.(4) is not intended to require that all air exhausted from a swimming pool or hot tub area pass through a heat-recovery unit, only sufficient air to recover 40% of the total sensible heat. Most heat-recovery units can recover more than 40% of the sensible heat from the exhausted air, but because it may not be cost-effective to reclaim heat from all exhaust systems, the overall recovery requirement is set at 40%.

**A-9.36.3.9.(1) Heat Recovery in Dwelling Units.** Whereas Section 9.32. addresses the effectiveness of mechanical ventilation systems in dwelling units from a health and safety perspective, Section 9.36. is concerned with their functioning from an energy efficiency perspective.

The requirements of Subsection 9.32.3. can be met using one of several types of ventilation equipment, among them heat-recovery ventilators (HRVs), which are typically the system of choice in cases where heat recovery from the exhaust component of the ventilation system is required. As such, Article 9.36.3.9. should be read in conjunction with the provisions in Subsection 9.32.3. that deal with HRVs.

**A-9.36.3.9.(3) Efficiency of Heat-Recovery Ventilators (HRVs).** HRVs are required to be tested in conformance with CAN/CSA-C439, “Rating the Performance of Heat/Energy-Recovery Ventilators,” under different conditions to obtain a rating: to be rated for colder locations, HRVs must be tested at two different temperatures, as stated in Clause 9.36.3.9.(3)(b), whereas their rating for locations in mild climates relies only on the 0°C test temperature, as stated in Clause 9.36.3.9.(3)(a).

The performance of an HRV product and its compliance with Sentence 9.36.3.9.(3) can be verified using the sensible heat recovery at the 0°C and/or –25°C test station (i.e. location where the temperature is measured) published in the manufacturer’s literature or in product directories, such as HVI’s Certified Home Ventilating Products Directory.

The rating of HRVs also depends on the flow rate used during testing. Therefore, the minimum flow rate required in Section 9.32. needs to be taken into consideration when selecting an HRV product.

**A-9.36.3.10.(1) Unit and Packaged Equipment.** The minimum performance values stated in Table 9.36.3.10. were developed based on values and technologies found in the Model National Energy Code of Canada for Houses 1997, the NECB, federal, provincial and territorial energy efficiency regulations as well as in applicable standards on equipment typically installed in housing and small buildings.

In some cases—after a review of current industry practices (industry sales figures)—the performance requirements were increased from regulated minimums where it could be shown that the cost and availability of the equipment are acceptable. Some of the performance requirements are based on anticipated efficiency improvements in the energy efficiency regulations and revisions to standards.

**A-9.36.3.10.(3) Multiple Component Manufacturers.** Where components from more than one manufacturer are used as parts of a heating, ventilating or air-conditioning system, the system should be designed in accordance with good practice using component efficiency data provided by the component manufacturers to achieve the overall efficiency required by Article 9.36.3.10.

**A-9.36.4.2.(1) Unit and Packaged Equipment.** The minimum performance values stated in Table 9.36.4.2. were developed based on values and technologies found in the Model National Energy Code of Canada for Houses 1997, the NECB, federal, provincial and territorial energy efficiency regulations as well as in applicable standards on equipment typically installed in housing and small buildings.

In some cases—after a review of current industry practices (industry sales figures)—the performance requirements were increased from regulated minimums where it could be shown that the cost and availability of the equipment are acceptable.

**A-9.36.4.2.(3) Exception.** Components of solar hot water systems and heat pump systems are examples of service water heating equipment that is required to be installed outdoors.

**A-9.36.4.6.(2) Required Operation of Pump.** The water in indoor pools is pumped through filtration equipment at rates that will help prevent the build-up of harmful bacteria and algae based on water volume and temperature, frequency of pool use, number of swimmers, etc.

**A-9.36.5.2. Use of Terms “Building” and “House”.** Although the word “house” is used in the terms “proposed house” and “reference house,” it is intended to include other types of residential buildings addressed by Subsection 9.36.5. The terms “proposed building” and “reference building” used in the NECB apply to other types of buildings.

**A-9.36.5.3.(2) Concept of Comparing Performance.** Comparing the performance of a reference house to that of a proposed house is one way to benchmark the performance of a proposed house in relation to Code requirements. There are other ways to benchmark energy consumption models: for example, by setting a quantitative energy target or using a benchmark design. In the performance compliance option presented in Subsection 9.36.5., the user must demonstrate that their design results in a similar level of performance to that of the prescriptive requirements— an approach that is consistent with the concept of objective-based codes.

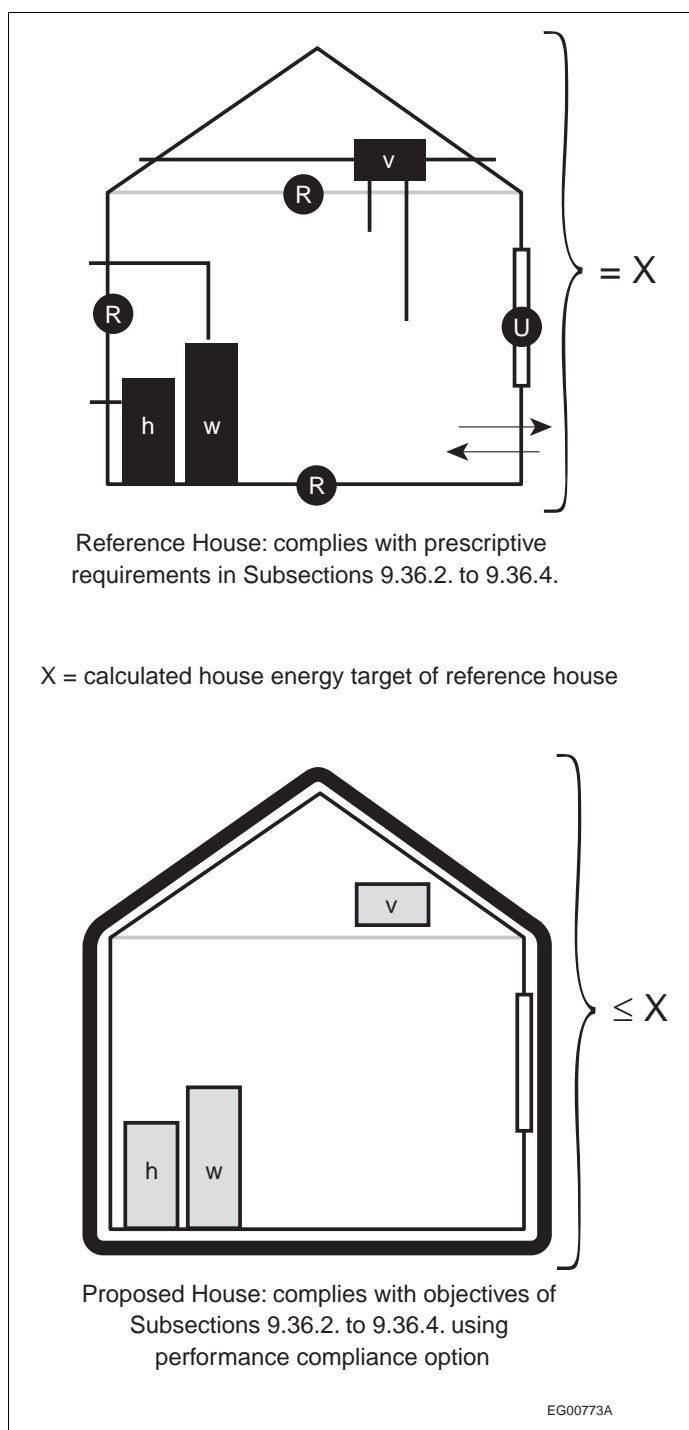


Figure A-9.36.5.3.(2)  
Energy consumption of proposed house versus that of reference house

**A-9.36.5.4.(1) Calculation Procedure.** It is important to characterize actual heat transfer pathways such as areas of fenestration, walls, floors, ceilings, etc. An accurate geometric model of a house, including volume, captures such information, but modeling can be carried out with other calculations.

**A-9.36.5.4.(2) Space-Conditioning Load.** Supplementary heating systems form part of the principal heating system and must be able to meet the space-conditioning load of the house.

**A-9.36.5.4.(7) Thermostatic Control.** The thermostat's response to temperature fluctuations described in Sentence 9.36.5.4.(7) represents a thermostat deadband of  $\pm 0.5^{\circ}\text{C}$ .

**A-9.36.5.5.(1) Source of Climatic Data.** Climatic data sources include the Canadian Weather Year for Energy Calculations (CWEC) and the Canadian Weather Energy and Engineering Data Sets (CWEEDS). The CWEC represent average heating and cooling degree-days which impact heating and cooling loads in buildings. The CWEC follow the ASHRAE WYEC2 format and were derived from the CWEEDS of hourly weather information for Canada from the 1953-1995 period of record. The CWEC are available from Environment Canada at [http://climate.weatheroffice.gc.ca/prods\\_servs/index\\_e.html](http://climate.weatheroffice.gc.ca/prods_servs/index_e.html).

Where climatic data for a target location are not available, climatic data for a representative alternative location should be selected based on the following considerations: same climatic zone, same geographic area or characteristics, heating degree-days (HDD) of the alternative location are within 10% of the target location's HDD, and the January 1% heating design criteria of the alternative location is within 2°C of the target location's same criteria (see Appendix C). Where several alternative locations are representative of the climatic conditions at the target location, their proximity to the target location should also be a consideration.

**A-9.36.5.6.(6) Contents of the House.** In the context of Subsection 9.36.5., "contents of the house" refers to cabinets, furniture and other elements that are not part of the building structure and whose removal or replacement would not require a building permit.

**A-9.36.5.6.(11) Application.** Sentence 9.36.5.6.(11) is not intended to apply to the fenestration area to wall area ratio.

**A-9.36.5.7.(1) Consumption of HVAC systems.** The energy consumption of HVAC systems typically includes the distribution system and the effect of controls.

**A-9.36.5.7.(5) Zoned Air Handlers.** Zoned air handler systems may also have duct and piping losses.

**A-9.36.5.8.(5) Water Delivery Temperature.** A value of 55°C is used in the energy model calculations; Article 2.2.10.7. of Division B of the NPC contains different requirements relating to water delivery temperature.

### **A-9.36.5.9.(1) Modeling the Proposed House.**

#### **Completeness of the Energy Model Calculations**

The specifications for a building typically include the following inputs and variables, among others, which are needed for modeling:

- space-heating and domestic hot water (DHW) systems
- air-, ground- and water-source heat pumps
- central air-conditioning systems
- primary and secondary DHW systems
- efficiencies of heating and cooling equipment
- solar gain through windows facing each cardinal direction
- sloped glazing, including skylights
- overhangs, taking into account the hourly position of the sun with respect to each window and overhang on a typical day each month
- the various levels of thermal mass
- slab-on-grade, crawl space (open, ventilated or closed), basement and walkout foundations, taking into account dimensions, thermal resistance and placement of insulation, soil conductivity, depth of water table, and weather/climate, and
- heat transfer between the three zones of the house, i.e. the attic, main floor and foundation

#### **Opaque Building Envelope Assemblies**

In the context of Sentence 9.36.5.9.(1), the term "opaque building envelope assembly" includes above-ground assemblies and those that are in contact with the ground.

**A-9.36.5.10.(2) Assembly Type.** Sentence 9.36.5.10.(2) sets a limit on the size of building envelope assemblies that have to be considered separately in the energy model calculations. In this context, assembly type is intended to mean either walls, roof, fenestration, exposed floors, or foundation walls and is intended to include the respective assembly type areas of the entire building.



**A-9.36.5.10.(9)(c)(ii) Equivalent Leakage Area (ELA).** The ELA is the size of an imaginary hole through which the same amount of air would pass that passes through all of the unintended openings in the building envelope if the pressure across all those openings were equal. This value is needed in the calculation because it is a good indicator of the airtightness of the house: a leaky house will have a large ELA and a very tight house will have a small ELA. For example, an energy-efficient house might have an ELA as low as 200 cm<sup>2</sup> whereas a very leaky house can have an ELA of more than 3000 cm<sup>2</sup>.

**A-9.36.5.10.(11) Timing of the Airtightness Test.** The blower door test described in CAN/CGSB-149.10-M, "Determination of the Airtightness of Building Envelopes by the Fan Depressurization Method," should be carried out once the building is substantially completed. Sufficient time should be allotted before completion to allow for subsequent air sealing in the event the desired airtightness is not achieved. Interim testing while the air barrier is still accessible for service can also be helpful.

#### **A-9.36.5.11.(9) Part-Load Performance of Equipment.**

##### **Measured Data**

Where available, the measured part-load performance data are provided by the equipment manufacturer.

##### **Modeled Part-Load Performance Data**

Part-load performance ratings differ depending on the equipment. The intent of Sentence 9.36.5.11.(9) is to indicate that the same modeled data source should be used for both the proposed and reference houses.

#### **A-9.36.5.11.(10) Sensible Heat Recovery.**

##### **Treatment of Humidity in the Calculations**

The calculations using sensible heat do not take latent heat (humidity) into account.

##### **Energy-Recovery Ventilators**

Energy-recovery ventilators can be used in lieu of heat-recovery ventilators.

**A-9.36.5.11.(11) Circulation Fans.** Sentences 9.36.5.11.(12) to (19) calculate the energy consumption of the circulation fan. The results are intended to be used in energy model calculations only and are not intended to address the performance of the ventilation system. The actual sizing of ventilation systems must comply with Section 9.32.

**A-9.36.5.12.(2) Assumptions Relating to Drain-Water Heat Recovery.** Energy savings associated with drain water heat recovery depend on the duration of showers and the vertical drop in the drain pipe. Similar to the service water heating load distribution, the length of showers depends on occupant behaviour. The values provided in Sentence 9.36.5.12.(2) are intended to be used in the energy model calculations only and take into consideration the loads stated in Table 9.36.5.8. The efficiency of a drain-water heat-recovery unit must be modeled using the same physical configuration intended for installation.

**A-9.36.5.14.(10) Above-Ground Gross Wall Area.** The determination of above-ground gross wall area is consistent with the prescriptive requirements of Article 9.36.2.3. in that it is based on the measurement of the distance between interior grade and the uppermost ceiling and on interior areas of insulated wall assemblies.

**A-9.36.5.15.(5) Sizing of Heating and Cooling Systems.** The intent of Sentence 9.36.5.15.(5) is that the cooling system be sized only for the portion of the house that is cooled.

Article 9.33.5.1. references CSA F280, "Determining the Required Capacity of Residential Space Heating and Cooling Appliances," which contains a number of different methods for determining the capacity of heating appliances. The intent of Sentence 9.36.5.15.(5) is that the equipment be sized according to the methods for total heat output capacity and nominal cooling capacity without being oversized.

**A-9.36.5.15.(6) Default Settings.** The default settings in energy performance modeling software for houses are an appropriate source of part-load performance values of equipment.

**A-9.36.5.15.(8) Treatment of Humidity in the Calculations.** The calculations using sensible heat do not take latent heat (humidity) into account.

# Index

## A

### Abbreviations

- acronyms, 1.3.2.1.
- symbols and, 1.2.2.1.
- terms and, 1.4.1.2.[A]

### Acceptable solutions, 1.1.2.1., 1.2.1.1.[A]

### Access

- attics or roof spaces, 3.6.4.4., 9.19.2.1.
- chimneys, 6.3.3.4.
- crawl spaces, 3.6.4.6., 9.18.2.1., 9.18.4.1.
- fire dampers, 3.1.8.10.
- hatchways to roof, 9.19.2.1.
- horizontal service spaces, 3.6.4.5., 9.18.2.1., 9.18.4.1., 9.19.2.1.
- HVAC equipment, 6.2.1.6., 9.33.4.4.
- smoke dampers, 3.1.8.11.

### Access to exits

- capacity, 3.3.1.17., 9.9.3.
- corridors in assembly occupancy, 3.3.2.6.
- corridor width, 3.3.1.9.
- dead-end corridors, 9.9.7.3.
- definition, 1.4.1.2.[A]
- dimensions, 9.9.3.
- doors, 3.3.1.13., 3.3.2.7., 9.9.6., 9.9.7.4.
- doors, sliding, 3.3.1.12.
- doors, transparent, 3.3.1.19.
- dwelling units, 9.9.9.
- flame-spread rating, 9.10.21.6.
- within floor areas, 3.3.1.3.
- headroom clearance, 3.3.1.8., 9.9.3.4.
- independent access to, 9.9.7.5.
- lighting, 9.9.12.2.
- podiums, terraces, platforms and contained open spaces, 9.9.7.1.
- residential occupancy, 3.3.4.4.
- roofs, 3.3.1.3., 9.9.7.1.
- service rooms, 9.9.7.5.
- suites, 9.9.7.2.
- transparent panels, 3.3.1.19.
- travel distance, 9.9.7.6.
- when exits are means of egress, 9.9.7.
- width, 9.9.3.2., 9.9.3.3.

### Access for firefighting

- access routes, 3.2.5.4., 3.2.5.5., 3.2.5.6.
- basements, 3.2.5.2., 9.10.20.2.
- and building size determination, 1.3.3.4.[A]

- provisions, 9.10.20.
- roof area, 3.2.5.3.
- storeys below ground, 3.2.2.15.
- storeys above grade, 3.2.5.1.
- street frontages, 3.2.2.10.

### Accessibility (see Barrier-free)

### Access openings

- construction barricades, 8.2.1.3.
- HVAC systems, 6.8.1.1.

### Access panels, 3.2.5.1., 9.10.20.1.

### Access routes

- design, 3.2.5.6.
- location, 3.2.5.5., 9.10.20.3.
- need for, 3.2.5.4.
- self-service storage buildings, 3.9.2.3.
- as streets, 3.2.2.10.

### Adfreezing, 1.4.1.2.[A], 4.2.4.4.

### Adhesives

- ceramic wall tiles, 9.29.10.3.
- ducts, 3.6.5.4., 9.33.6.4.

### Administration of the Code, 2.2.[C]

### Admixtures

- concrete, 9.3.1.8.
- mortar and grout, 9.20.3.2.

### Aggregate

- for built-up-roofing, 9.26.11.1., 9.26.11.4.
- for concrete, 9.3.1.1., 9.3.1.4., 9.3.1.7.
- for mortar, 5.9.1.1., 9.20.3.1., 9.20.3.2., 9.29.10.2.
- for stucco, 9.28.2.2., 9.28.5.1.

### Air

- circulation, 6.3.2.7., 9.33.6.7.
- distribution, 9.33.6.11.
- flow through and around insulation, 5.3.1.3., 9.19.1.3., 9.25.2.3., 9.25.2.4.
- leakage, 3.1.8.4., 5.1.1.1., 5.4.1.1., 5.9.3.4., 5.9.4.1., 9.25.5.1.
- leakage resistance, 5.4.1.1., 5.4.1.2., 9.13.4., 9.18.6.2., 9.25.5.1.
- makeup, 6.3.2.8., 9.32.3.8.
- permeance, 5.4.1.2., 9.25.5.1.
- tempering, 9.32.3.4., 9.32.3.8.
- transfer, 5.1.1.1., 5.2.1.3.

### Air barrier systems

- airtightness, 5.4.1.1., 9.36.2.9., 9.36.2.10.
- assemblies in contact with the ground, 9.13.4., 9.25.3.6.
- continuity, 5.4.1.2., 9.25.3.3., 9.36.2.9.
- crawl space floors, 9.18.6.2.

[A] – Reference occurs in Division A. [C] – Reference occurs in Division C. All other references occur in Division B.

- definition, 1.4.1.2.[A]
- deflections, 5.2.2.1.
- energy efficiency, 9.36.2.9.
- environmental loads, 5.1.4.1.
- environmental separation, 5.1.1.1.
- floors-on-ground, 9.18.6.2., 9.25.3.6.
- housing and small buildings, 9.25.3.
- installation, 9.23.2.2., 9.25.3.3.
- material standards, 5.9.1.1., 9.18.6.2., 9.25.3.2., 9.25.3.6.
- properties, 9.25.3.1., 9.25.5.1.
- properties of, 5.4.1.2., 9.25.3.2.
- repair garages, 9.10.9.17.
- requirement for, 9.25.3.1.
- storage garages, 9.10.9.16.
- Airborne sound rating, 3.3.4.6., 5.8.1.2., 9.11.
- Air cleaning devices, 6.3.2.14.
- Air-conditioning systems and equipment
  - access, 6.2.1.6., 6.8.1.1., 9.33.4.4.
  - cleaning, 6.2.1.6., 9.33.4.4.
  - continuity of insulation, 9.36.3.5.
  - cooling units, 6.6.1.1.
  - design, 6.2.1., 9.33.1.1., 9.33.3.2., 9.33.4.1., 9.33.5.3.
  - energy efficiency, 9.36.
  - fire safety characteristics, 6.9.1.1., 9.33.6.
  - installation, 6.2.1., 6.6.1.1., 9.32.3.2., 9.33.1.1., 9.33.4., 9.33.5.2., 9.33.9.1.
  - installation standards, 6.2.1.5., 9.33.5.2., 9.33.5.3., 9.33.6.7.
  - performance requirements, 9.36.3.10.
  - protection from freezing, 6.2.1.6., 9.33.4.5.
  - structural movement, 4.1.8.18., 6.2.1.4., 9.33.4.7.
  - system pressure, 6.2.1.3., 9.33.4.6.
  - temperature controls, 9.36.3.6.
- Air duct systems
  - application of Code, 6.3.2.1.
  - clearance of ducts and plenums, 6.3.2.6.
  - connections, 6.3.2.4.
  - drain pans, 6.3.2.2.
  - duct coverings and linings, 6.3.2.5.
  - interconnection, 6.3.2.7.
  - makeup air, 6.3.2.8.
  - materials, 6.3.2.3.
  - supply, return, intake and exhaust air openings, 6.3.2.9.
- Air filters, 6.8.1.3., 9.33.6.14.
- Air intakes
  - area, 9.32.3.13.
  - connection, 9.33.6.6.
  - grilles, 6.3.2.9., 9.33.6.10.
  - labeling, 9.32.3.13.
  - location, 6.3.2.9., 9.32.3.13., 9.33.6.10., 9.33.6.12.
  - protection, 6.3.2.9., 9.32.3.13., 9.33.6.10.
- Air outlets
  - area, 9.32.3.13.
  - capacity, 9.33.6.11.
  - diffusers, 9.33.6.10., 9.33.6.11.
  - grilles, 6.3.2.9., 9.32.3.13., 9.33.6.10.
  - labeling, 9.32.3.13.
  - location, 6.3.2.9., 9.32.3.13., 9.33.6.10., 9.33.6.11.
  - protection, 6.3.2.9., 9.32.3.13., 9.33.6.10.
  - warm air heating, 9.33.6.10., 9.33.6.11.
- Air quality, emergency power supply, 3.2.7.9.
- Air-supported structures
  - clearance to flammable material, 3.1.6.4.
  - clearance to other structures, 3.1.6.3.
  - definition, 1.4.1.2.[A]
  - electrical systems, 3.1.6.7.
  - emergency air supply, 3.1.6.6.
  - fire protection, 9.10.1.3.
  - fire safety restrictions, 3.1.6.2.
  - flame resistance, 3.1.6.5.
  - means of egress, 3.1.6.1.
  - roof coverings, 3.1.15.2.
  - structural design basis, 4.4.1.1.
- Airtightness
  - building envelope, 9.36.2.9., 9.36.2.10.
  - material standards, 5.9.1.1.
  - requirement for, 5.4.1.1.
  - windows, doors and skylights, 5.9.2.3., 9.7.4.
- Air washers, 6.3.2.16.
- Aisles
  - with fixed seats, 3.3.2.5.
  - within floor areas, 3.3.1.10.
  - leading to exits, 3.4.2.5.
  - minimum clear width, 3.3.2.1.
  - outdoor places of assembly, 3.3.2.11.
  - with steps, handrails for, 3.3.2.10.
  - width, 3.4.3.2.
- Alarm signal
  - audibility, 3.2.4.17., 3.2.4.18.
  - definition, 1.4.1.2.[A]
  - design, 3.2.4.4.
  - high buildings, 3.2.6.7.
  - silencing, 3.2.4.6.
  - system monitoring, 3.2.4.15.
- Alert signal
  - audibility, 3.2.4.17., 3.2.4.18.
  - definition, 1.4.1.2.[A]
  - design, 3.2.4.4.
  - high buildings, 3.2.6.7.
  - system monitoring, 3.2.4.15.
- Alterations to buildings, 1.1.1.1.[A], 1.4.1.2.[A]
- Alternative materials, 1.2.2.1.[A]
- Alternative solutions, 1.2.1.1.[A], 2.3.1.[C]
- Aluminum
  - flashing, 9.20.13.1., 9.26.4.2., 9.27.3.7., 9.28.1.5.
  - nails, 9.26.2.3.
  - roofing, 9.26.13.1.
  - siding, 9.27.11.1.
  - structural design basis, 4.3.5.
- Ammonium nitrate, 3.3.6.6.
- Anchorage
  - anchor bolts, 9.20.11.6., 9.20.17.6.
  - columns, 9.23.6.2., 9.35.4.3.
  - concrete stairs, 9.8.10.2.
  - cornices, 9.20.11.5.
  - floors, 9.20.11.
  - foundations, 9.23.6., 9.35.4.3.
  - framing, 9.23.6.
  - horizontal force factor, 4.1.8.18.

- lateral loads, 9.23.6.1.
- masonry, 9.20.9., 9.20.11.
- masonry walls to wood-frame construction, 9.20.11.3., 9.20.11.4.
- roofs, 9.20.11., 9.20.17.6.
- sills, 9.20.11.5.
- small buildings, 9.23.6.3.
- walls, 9.20.11., 9.23.3.4.
- Anhydrous ammonia, storage, 3.3.6.3.
- Annual energy consumption
  - building envelope, 9.36.5.6.
  - climatic data calculations, 9.36.5.5.
  - definition, 9.36.5.2.
  - HVAC systems, 9.36.5.7.
  - modeling, proposed house, 9.36.5.9. - 9.36.5.12.
  - modeling, reference house, 9.36.5.13. - 9.36.5.16.
  - performance compliance, 9.36.5.3.
  - performance compliance calculations, 9.36.5.4.
  - service water heating systems, 9.36.5.8.
- Annunciators, fire alarm, 3.2.4.8., 3.2.4.9., 3.2.4.15., 3.2.5.14., 3.2.7.10.
- Antennas and antenna-supporting structures
  - earthquake loads and effects, 4.1.8.1.
  - wind loads, 4.1.7.11.
- Apparent sound transmission class (ASTC)
  - calculation of, 5.8.1.4., 5.8.1.5.
  - definition, 1.4.1.2.[A]
- Appliances
  - (see also Heating appliances; Heating systems and equipment; Heating, ventilating and air-conditioning (HVAC) systems and equipment)
  - in access to exit, 3.3.1.2.
  - air-conditioning, 6.2.1., 9.33.4.1., 9.33.5.2.
  - characteristics, 1.2.2.1.[A]
  - cooling, 6.2.1., 6.6.1.1., 9.33.4.1., 9.33.5.2., 9.33.9.1.
  - definition, 1.4.1.2.[A]
  - in exit, 3.4.4.4.
  - exterior, 3.6.1.5.
  - fuel-fired, 3.6.2.1., 9.10.10.4.
  - heating, 6.2.1.1., 9.33.4.1., 9.33.5.2.
  - location, 3.6.1.5., 6.3.2.17., 6.4.1.1., 9.10.10.4.
  - in means of egress, 9.9.5.7.
  - outdoor location, 6.2.1.6., 6.3.2.17., 6.4.1.2.
  - protection from freezing, 6.2.1.6., 9.33.4.5.
  - roof-top, 3.6.1.5., 3.6.2.1., 6.4.1.2., 9.10.1.3.
  - solid-fuel-burning, 3.6.2.1., 6.2.1.5., 9.33.5.3.
  - storage, 1.2.2.2.[A]
  - used, 1.2.2.3.[A]
  - ventilating, 6.2.1., 9.32.3.2.
- Application of National Building Code
  - divisions A, B, C, 1.3.[A]
  - factory-constructed buildings, 1.1.1.1.[A]
  - farm buildings, 1.1.1.1.[A]
  - new buildings, 1.1.1.1.[A]
  - objectives, 2.1.1.[A], 3.2.[A]
  - seasonally and intermittently occupied buildings, 9.1.1.1.
- Arches
  - fire-resistance ratings, 9.10.8.3.
  - in storeys below ground, 3.2.2.15.
  - supporting floor above basement, 3.2.1.4.
  - supporting masonry over openings, 9.20.5.2.
  - supporting service room/space, 3.1.7.5.
- Arch roofs, snow and rain loads, 4.1.6.10.
- Areas of refuge, 3.3.3.6.
- Areas and spaces
  - design, 9.5.
  - dimensions, 9.5.1.1.
- Arena-type buildings
  - building classification, 3.1.2.3.
  - building height exceptions, 3.2.1.1.
  - roof assemblies, 3.2.2.17.
  - seating, 3.3.2.2.
- Artesian groundwater, 1.4.1.2.[A], 4.2.5.5.
- Asbestos in air distribution systems and equipment, 6.2.1.7., 9.33.4.8.
- Asbestos cement pipe, 9.14.3.
- Assembly areas
  - loads on floor or roof, 4.1.5.3.
  - loads on tributary areas, 4.1.5.8.
  - sway forces and load, 4.1.5.10.
- Assembly occupancy (Group A)
  - air-supported structure as, 3.1.6.6.
  - assistive listening devices, 3.8.2.9., 3.8.3.18.
  - building classification, 3.1.2.1.
  - corridors, 3.3.2.6.
  - definition, 1.4.1.2.[A]
  - doors, 3.3.2.7.
  - fire protection, 3.2.2.17., 3.2.2.20. - 3.2.2.35., 9.10.1.3.
  - fire safety within floor areas, 3.3.1., 3.3.2.1.
  - location of smoke/fire dampers, 3.1.8.7.
  - occupant load, 3.1.17.1.
  - signals to fire department, 3.2.4.7.
  - visual alarm signals, 3.2.4.19.
  - washrooms, 3.7.2.
  - wheelchair spaces, 3.8.2.3.
- Assistive listening devices, 3.8.2.9., 3.8.3.18.
- Atomizers, 6.3.2.16.
- Attendant booths, 6.3.1.4.
- Attics or roof spaces
  - access, 3.6.4.4., 9.19.2.
  - clearances, 9.19.1.3.
  - definition, 1.4.1.2.[A]
  - exterior wall enclosing, 3.2.3.3.
  - fire blocks, 3.1.11.1., 3.1.11.5., 9.10.16.1.
  - fire protection, 9.10.12.4.
  - foamed plastics in, 3.1.4.2., 9.10.17.10.
  - housing and small buildings, 9.19.
  - insulation, 9.25.2.4.
  - loads, 4.1.5.3., 9.4.2.4.
  - in noncombustible construction, 3.1.5.3.
  - service spaces, 3.6.1.1.
  - soffits protection, 3.2.3.16.
  - venting, 5.3.1.2., 6.3.1.2., 9.19.1.
- Audible signal devices, 3.2.4.17., 3.2.4.18.
- Auditoriums, 3.2.2.21., 3.2.2.22.
- Authority having jurisdiction, 1.4.1.2.[A]
- Automatic locking devices, 3.3.4.5.
- Automatic sprinkler systems (see Sprinkler systems)

## B

Backdraft prevention, 6.3.2.10., 9.32.3.13.

### Backfill

(see also Fill)

excavations, 9.12.3.

material, 4.2.5.8., 9.12.3.3.

### Backfilling

(see also Fill)

beneath concrete stairs, 9.8.10.3.

beneath floors on grade, 4.2.5.8.

beneath footings, 4.2.5.8.

beneath foundations, 4.2.5.8.

grading, 9.12.3.2.

placement, 4.2.5.8., 9.12.3.1.

review, 4.2.2.3.

Bacteria, minimizing growth of, 6.3.1.6., 6.3.2.15.

Balance stops, 9.33.6.9.

### Balconies

as access to exit, 9.9.9.3.

concealed spaces in, 3.1.11.5.

doors and door hardware, 3.3.1.13.

earthquake load and effects, 4.1.8.1.

exception to travel limit, 9.9.9.1.

exterior, 3.2.2.11.

guards around, 3.3.1.18., 9.8.8.

horizontal exits, 3.4.6.10.

limiting distance, 3.2.3.6.

loads on floor or roof, 4.1.5.3., 4.1.5.4., 9.4.2.3.

occupant load, 3.1.17.1.

snow loads, 9.4.2.3.

sprinkler systems, 3.2.5.12.

wind loads, 4.1.7.5.

Banks, 3.4.6.17.

Barricades, construction and demolition sites, 8.2.1.3., 8.2.3.3.

### Barrier-free

balconies, 3.3.1.7.

bathrooms, 3.8.2.8., 3.8.3.17.

controls, 3.8.2.6., 3.8.3.8.

counters, 3.8.2.11., 3.8.3.19.

definition, 1.4.1.2.[A]

design standards, 3.8., 3.8.3.1., 9.5.2.

doors and doorways, 3.8.3.6.

drinking fountains, 3.8.2.8., 3.8.3.10.

elevators, 3.3.1.7., 3.5.2.1., 3.8.2.3., 3.8.3.7.

entrances, 3.8.2.2.

exterior walks, 3.8.3.3.

floor areas, 3.8.2.3.

floor surfaces, 3.8.3.2.

lavatories, 3.8.2.8., 3.8.3.15.

parking areas, 3.8.2.5.

path of travel (see Path of travel, barrier-free)

ramps, 3.8.3.5.

showers, 3.8.2.8., 3.8.3.16.

signs, 3.8.2.10., 3.8.3.9.

soap and towel dispensers, 3.8.3.15., 3.8.3.16.

spaces in seating areas, 3.8.2.3., 3.8.3.21.

telephone shelves, 3.8.2.11., 3.8.3.20.

universal washrooms, 3.8.2.8., 3.8.3.12.

urinals, 3.8.2.8., 3.8.3.14.

vestibules, 3.8.3.6.

washrooms, 3.8.2.8., 3.8.3.9., 3.8.3.11., 3.8.3.15.

water closets, 3.8.3.11., 3.8.3.13.

### Barriers

across transparent panels, 3.3.1.19.

preventing exit obstruction, 3.4.6.11., 9.9.11.2.

### Basements

access, 3.2.5.2., 9.10.20.2.

ceiling height, 9.5.3.1.

crawl spaces considered as, 3.2.2.9., 9.10.8.9.

definition, 1.4.1.2.[A]

exit signs, 3.4.5.2.

fire containment, 3.2.1.5.

fire protection, 3.2.2.15., 9.10.1.3.

fire-resistance of floor assemblies over, 3.2.1.4.

fire separations, 9.10.9.4., 9.10.9.14.

heating requirements, 9.33.3.1.

industrial occupancy (Group F), 3.3.5.3.

insulation, 9.25.2.2.

large or multi-storey, 9.10.1.3.

lighting, 9.34.2.3., 9.34.2.4.

residential occupancy (Group C), 3.2.2.47.

storage garages, 3.1.10.3., 3.2.1.2., 9.10.4.3.

supply outlets, 9.33.6.11.

Bathroom accessories, 3.7.2.3., 3.7.2.9., 3.8.3.8., 3.8.3.11., 3.8.3.15., 3.8.3.17.

### Bathrooms

(see also Washrooms)

ceiling height, 9.5.3.1.

doorways, 9.4.4.3.

flame-spread rating, 3.1.13.3.

Bathtubs, 3.7.2.9., 3.8.3.17., 9.6.1.4.

### Beams

bearing, 9.23.8.1.

built-up, 9.23.4.2., 9.23.4.4., 9.23.8.3.

dimensions, 9.23.4.1.

glued-laminated, 9.23.4.1., 9.23.4.2., 9.23.4.4.

in heavy timber construction, 3.1.4.7.

lumber grade, 9.3.2.1.

preservative treatment, 9.23.2.2., 9.23.2.3.

ridge, 9.23.14.8.

spans, 9.23.4.1., 9.23.4.2., 9.23.4.4.

spans, maximum, 9.23.4.

steel, 9.23.4.3., 9.23.8.2.

supported on masonry or concrete, 9.10.9.9., 9.15.5., 9.20.8.3., 9.20.8.4., 9.21.5.3., 9.23.2.2., 9.23.2.3.

to support floors, 9.23.8.

wood, 9.23.4.2., 9.23.4.4.

Bearing surface, 1.4.1.2.[A]

### Bedrooms

means of egress, 9.9.10.1.

mechanical ventilation, 9.32.2.3.

natural ventilation, 9.32.2.2.

windows, 9.9.10.1.

### Bleachers

aisles, 3.3.2.5.

guards, 3.3.2.9.

inspection, 4.1.5.12.

load analysis, 4.1.5.12.

locking, 4.1.5.12.

- seats, 3.3.2.5.
- steps, 3.3.2.5., 3.3.2.12.
- Blocking
  - cladding, 9.27.5.2.
  - cladding and interior finishing materials, 9.23.10.5.
  - doors, 9.7.5.2.
  - with handrails, 9.8.7.7.
  - joists, 9.23.9.3., 9.23.9.4., 9.23.14.9.
  - nailing, 9.23.3.4.
  - in noncombustible construction, 3.1.5.2.
  - rafters and joints, 9.23.14.7.
  - roof edges, 9.23.16.6., 9.23.16.7.
  - subflooring, 9.23.15.3.
  - walls, 9.23.9.8., 9.23.10.2.
- Boarding and lodging houses, 9.10.9.14.
- Boiler rooms, 3.6.2.2., 9.10.10.4.
- Boilers
  - definition, 1.4.1.2.[A]
  - installation standard, 6.2.1.5.
  - performance requirements, 9.36.3.10.
- Bonding
  - intersecting masonry walls, 9.20.11.2.
  - masonry, 9.20.9.
- Book shelves, 3.3.2.13.
- Braced wall bands, 1.4.1.2.[A], 9.23.13.4., 9.23.13.5.
- Braced wall panels
  - anchorage, 9.23.6.1., 9.23.13.5.
  - definition, 1.4.1.2.[A]
  - fastening, 9.23.3.4., 9.23.3.5.
  - gypsum board, 9.29.5.9.
  - lateral loads, 9.23.13.5., 9.23.13.6.
  - plywood, 9.29.6.3.
  - and wall supports, 9.23.9.8.
- Bracing, wood-frame walls, 9.23.13., 9.23.13.4., 9.23.13.5.
- Breeching, 1.4.1.2.[A]
- Bridging floor joists, 9.23.9.4.
- Builder (see Constructor)
- Building area
  - assembly occupancy (Group A, Division 1), 3.2.2.20.
  - assembly occupancy (Group A, Division 2), 3.2.2.23.
  - assembly occupancy (Group A, Division 3), 3.2.2.29.
  - business and personal services occupancy (Group D), 3.2.2.55.
  - care, treatment or detention occupancy (Group B Division 1), 3.2.2.36., 3.2.2.37.
  - care, treatment or detention occupancy (Group B Division 2), 3.2.2.38. - 3.2.2.41.
  - care, treatment or detention occupancy (Group B Division 3), 3.2.2.42. - 3.2.2.46.
  - definition, 1.4.1.2.[A]
  - determination, 1.3.3.4.[A]
  - determination of fire safety requirements, 3.2.2.5.
  - high-hazard industrial occupancy (Group F, Division 1), 3.2.2.70.
  - low-hazard industrial occupancy (Group F, Division 3), 3.2.2.80.
  - medium-hazard industrial occupancy (Group F, Division 2), 3.2.2.74.
  - mercantile occupancy (Group E), 3.2.2.64.
  - residential occupancy (Group C), 3.2.2.47., 3.2.2.50., 3.2.2.51.
  - self-service storage buildings, 3.9.2.1.
- Building assemblies
  - effective thermal resistance, 9.36.2.6.
  - fire-resistance rating, 3.1.7.5.
  - off-site review, 2.2.7.5.[C]
  - replacement options, 9.36.2.11.
  - thermal resistance calculation, 9.36.2.4.
- Building classification
  - by major occupancy, 3.1.2.1., 9.10.2.
  - for wind load calculations, 4.1.7.2.
- Building, definition, 1.4.1.2.[A]
- Building envelope
  - energy efficiency, 9.36.2.
  - energy performance calculations, 9.36.5.6.
  - energy performance modeling, 9.36.5.10., 9.36.5.14.
  - replacement options, 9.36.2.11.
  - thermal resistance calculation, 9.36.2.4.
- Building height
  - access route design, 3.2.5.6.
  - assembly occupancy (Group A, Division 1), 3.2.2.20.
  - assembly occupancy (Group A, Division 2), 3.2.2.23.
  - assembly occupancy (Group A, Division 3), 3.2.2.29.
  - business and personal services occupancy (Group D), 3.2.2.55., 3.2.2.57., 3.2.2.58.
  - care, treatment or detention occupancy (Group B Division 1), 3.2.2.36., 3.2.2.37.
  - care, treatment or detention occupancy (Group B Division 2), 3.2.2.38. - 3.2.2.41.
  - care, treatment or detention occupancy (Group B Division 3), 3.2.2.42. - 3.2.2.46.
  - definition, 1.4.1.2.[A]
  - determination, 1.3.3.4.[A], 9.10.4.
  - determination of fire safety requirements, 3.2.2.5.
  - exceptions, 3.2.1.1.
  - garages as separate buildings, 9.10.4.3.
  - high-hazard industrial occupancy (Group F, Division 1), 3.2.2.70.
  - low-hazard industrial occupancy (Group F, Division 3), 3.2.2.80.
  - medium-hazard industrial occupancy (Group F, Division 2), 3.2.2.74.
  - mercantile occupancy (Group E), 3.2.2.64.
  - mezzanines excluded, 9.10.4.1.
  - mezzanines included, 9.10.4.2.
  - residential occupancy (Group C), 3.2.2.47., 3.2.2.50., 3.2.2.51.
  - roof-top enclosures excluded, 9.10.4.4.
- Building services
  - barrier-free controls, 3.8.3.8.
  - emergency power supply, 3.2.7.9.
  - and fire alarm systems, 3.2.4.2.
  - and firewalls, 3.1.10.1.
  - penetrating fire separations and fire-rated assemblies, 3.1.9.2., 9.10.9.6.

Building size determination  
application of Code, 1.3.3.4.[A]  
inclusions, 9.10.4.1.  
relative to occupancy, 9.10.8.

Built-up roofing, 9.26.11.

Business and personal services occupancy (Group D)  
classification, 3.1.2.1., 9.10.2.  
definition, 1.4.1.2.[A]  
emergency power for fire alarm systems, 3.2.7.8.  
emergency power for lighting, 3.2.7.4.  
exit stairs, 9.9.4.7.  
exposing building face, 9.10.14.5.  
fire access route design, 3.2.5.6.  
fire alarm systems, 3.2.4.1., 9.10.18.  
fire protection, 3.2.2.55. - 3.2.2.63.  
fire-resistance rating, 9.10.8.  
fire safety within floor areas, 3.3.1.  
flame-spread rating, 9.10.17.  
occupant load, 3.1.17.1.  
sprinkler systems, 3.2.5.12.  
washrooms, 3.7.2.

## C

Cabinetry, around cooktops, 9.10.22.3.

Cables  
in air barrier systems, 9.36.2.10.  
in combustible construction, 3.1.4.3.  
elevator, 3.1.5.22.  
in noncombustible construction, 3.1.5.21.  
penetrating fire separations, 3.1.9.3.  
in plenums, 3.6.4.3.

Caissons (see Pile foundations)

Calculations and analyses  
heat, air and moisture transfer, 5.2.1.2., 5.2.1.3.  
HVAC equipment and systems, 6.2.1.1., 9.33.4.1.  
limit states design, 4.1.3.  
snow, rain and ice load, 4.1.6.  
structural, 2.2.4.5.[C], 4  
wind load, 4.1.7., 5.2.1.3., 5.2.2.2.

Canopies  
fabrics, 3.1.16.1.  
for vertically separated openings, 3.2.3.17.

Capacity of exit, 3.4.3.2.

Carbon monoxide  
alarms, 9.32.3.8., 9.32.3.9.  
concentration, 6.3.1.4.  
detectors, 6.3.1.4., 6.9.3.1., 9.32.3.8., 9.32.3.9.

Care, definition, 1.4.1.2.[A]

Care, treatment or detention occupancy (Group B)  
building classification, 3.1.2.1.  
definition, 1.4.1.2.[A]  
door hold-open devices, 3.1.8.14.  
doorway width, 3.3.3.4.  
electromagnetic locks, 3.4.6.17.  
emergency lighting, 3.2.7.3.  
emergency power supply, 3.2.7.6.  
evaporative cooling towers, 6.3.2.15.  
fire alarm systems, 3.2.4.1., 3.2.4.18.  
fire protection, 3.2.2.36. - 3.2.2.46.

fire safety within floor areas, 3.3.1., 3.3.3., 3.3.3.1.  
location of smoke/fire dampers, 3.1.8.7.  
occupant load, 3.1.17.1.  
ramp slope maximum, 3.4.6.7.  
as residential occupancy, 3.1.2.5.  
self-closing door hardware, 3.1.8.13.  
sleeping room exits, 3.4.1.6.  
smoke alarms, 3.2.4.20.  
smoke detectors, 3.2.4.11.  
sprinkler systems, 3.2.2.19., 3.2.5.12.  
visual alarm signals, 3.2.4.19.

Carpets, 3.1.13.1.

Carports  
(see also Garages)  
columns, 9.35.4.2., 9.35.4.3.  
concrete for floors, 9.3.1.6.  
for dwelling units, 9.35.  
spatial separation from other buildings, 9.10.14.4.  
walls, 9.35.4.1., 9.35.4.3.

Catch basins, 9.14.6.4.

Caulking  
(see also Sealants)  
for ceramic wall tile, 9.29.10.5.  
door frames, 9.20.13.11.  
material standards, 9.29.10.5.  
in noncombustible construction, 3.1.5.2.  
requirements, 9.27.4., 9.27.4.1.  
sill plates, 9.23.7.2.  
stucco, 9.28.1.5.  
windows and frames, 9.7.6.2., 9.20.13.11.

Cavity walls  
corbelling, 9.20.12.2.  
definition, 1.4.1.2.[A]  
flashing, 9.20.13.5., 9.20.13.6.  
framing supported by, 9.20.8.2.  
height and thickness, 9.20.6.2.  
lateral support, 9.20.10.1.  
mortar droppings, 9.20.13.10.  
precipitation protection, 9.27.2.2.  
tying, 9.20.9.4.

Ceiling membranes  
fire-resistance rating, 3.6.4.3., 9.10.3.4.  
fire stop flaps, 9.10.13.14.  
openings in, 3.1.9.6., 9.10.5., 9.10.9.6., 9.10.9.7.  
suspended, 9.10.3.4.

Ceiling panels, factory-assembled, 3.1.5.7.

Ceilings  
air barrier systems, 9.25.3.  
area, calculating, 9.36.2.3.  
assembly used as plenum, 3.1.9.7.  
in corridors, 3.1.13.6.  
effective thermal resistance, 9.36.2.6.  
fastened to floor joists, 9.23.9.4.  
finish, 3.1.5.12., 9.29.  
foamed plastics in, 9.10.17.10.  
framing, 9.23.14.  
framing around openings, 9.23.14.2.  
height, 9.5.3.  
joists, 9.23.14.1., 9.23.14.7.  
thermal insulation, 9.25.1.1.

Cement, standards for, 9.3.1.2.



- Central alarm and control facility, 3.2.4.22., 3.2.6.4., 3.2.6.7.
- Ceramic tile  
as flooring, 9.30.6.  
installation, 9.29.10.1.  
as interior finish, 9.29.10.  
subfloor, 9.23.15.5.  
underlay, 9.23.15.5., 9.30.2.1., 9.30.2.2.
- Chases, 9.20.7.
- Children's custodial homes, 3.1.2.5., 3.2.4.3., 9.10.2.2.
- Chimneys  
access ladders, 6.3.3.4.  
airtightness, 9.36.2.10.  
bracing, 9.21.4.5.  
caps, 9.21.4.6.  
cleanouts, 9.21.4.7.  
clearances, 6.3.3.1., 9.21.5., 9.25.3.3.  
concrete, 1.4.1.2.[A], 6.3.3.2., 9.21., 9.21.4.2., 9.33.10.3.  
construction, 9.21.4.  
definition, 1.4.1.2.[A]  
design of, 6.3.3.2., 9.20.2.3., 9.21., 9.33.10.3.  
earthquake loads and effects, 4.1.8.1.  
factory-built, 1.4.1.2.[A], 9.33.10.2.  
fireplace, 9.21.2.4., 9.21.2.5.  
flashing, 9.21.4.6., 9.21.4.10., 9.26.4.4., 9.26.4.6., 9.26.4.8.  
flues, 9.21.2., 9.21.4.4.  
footings, 9.21.4.3.  
fuel-fired appliances, 6.3.3.1., 9.33.10.1.  
incinerators, 9.10.10.5., 9.21.2.1.  
lateral stability, 9.21.4.5.  
liners (see Liners, chimney)  
masonry, 1.4.1.2.[A], 6.3.3.2., 9.21., 9.21.4.1., 9.33.10.3.  
metal, 6.3.3.3., 9.33.10.2.  
saddles, 9.26.4.8.  
sealing, 9.21.5.2.  
venting equipment, 6.3.1.  
walls, 9.21.1.2.  
wall thickness, 9.21.4.8.
- Chutes  
linen, 3.6.3.3., 9.10.1.3.  
refuse, 3.6.3.3., 9.10.1.3.  
sprinklers, 3.6.3.3.  
venting, 3.6.3.3.
- Cladding  
attachment, 9.27.5.  
for braced wall panels, 9.23.13.6.  
combustible, 9.10.14.5., 9.10.15.5.  
in combustible construction, 3.1.4.8.  
exposing building face, 3.2.3.7.  
fastening to steel studs, 9.24.1.4.  
housing and small buildings, 9.27.  
installation, 5.6.1.2., 5.9.1.1., 9.27.2.4., 9.27.3.6., 9.27.5.  
interior, 3.1.13.1.  
noncombustible, 3.1.4.8., 3.2.3.7., 3.2.3.9.  
in noncombustible construction, 3.1.5.5.  
protection against precipitation, 5.6.  
requirement for, 5.6.1.1., 9.27.2.1.  
sealing, 5.6.2.1., 9.27.3.6., 9.27.4.  
on steel studs, 9.24.1.5.  
support of, 9.20.5., 9.23.10.5., 9.24.3.4.  
waterproofing, 9.27.4.  
wind loads, 4.1.7.5., 4.1.7.6., 4.1.7.12.
- Cladding, clay tile, 9.23.4.5.
- Cladding, concrete  
design, 9.20.6.6.  
water absorption, 9.20.2.6.  
weight, 9.20.2.6.
- Cladding, decorative, 3.1.5.24.
- Cladding, hardboard  
clearances, 9.27.2.4., 9.27.9.5.  
dimensions, 9.27.9.2.  
housing and small buildings, 9.27.9.  
installation, 9.27.2.4., 9.27.3.6., 9.27.5., 9.27.9.3.  
material standards, 5.9.1.1., 9.27.9.1.
- Cladding, lumber  
dimensions, 9.27.6.2.  
housing and small buildings, 9.27.6.  
installation, 5.9.1.1., 9.27.2.4., 9.27.3.6., 9.27.5.  
material standards, 5.9.1.1.
- Cladding, masonry  
bonding and tying, 9.20.9.  
flashing, 9.20.13.  
housing and small buildings, 9.20., 9.27.2.2.  
installation, 5.6.1.2.  
material standards, 5.9.1.1.  
mortar joints, 9.20.4.  
support of, 9.20.5.
- Cladding, metal  
housing and small buildings, 9.27.11.  
installation, 5.9.1.1., 9.27.3.6., 9.27.5.  
material standards, 5.9.1.1., 9.27.11.1.
- Cladding, OSB and waferboard  
clearances, 9.27.2.4., 9.27.10.4.  
dimensions, 9.27.10.2.  
housing and small buildings, 9.27.10.  
installation, 9.27.2.4., 9.27.3.6., 9.27.5., 9.27.10.3., 9.27.10.4.  
material standards, 5.9.1.1., 9.27.10.1.
- Cladding, plywood  
dimensions, 9.27.8.2.  
housing and small buildings, 9.27.8.  
installation, 9.27.2.4., 9.27.3.6., 9.27.5., 9.27.8.3.  
material standards, 5.9.1.1., 9.27.8.1.  
sealing, 5.6.2.1., 9.27.8.3., 9.27.8.4.
- Cladding, stone, 9.20.6.6.
- Cladding, vinyl  
housing and small buildings, 9.27.12.  
installation, 9.27.5., 9.27.12.2.  
material standards, 5.9.1.1., 9.27.12.1.
- Cladding, waferboard (see Cladding, OSB and waferboard)
- Cladding, wood shingles and shakes  
grades, 9.27.7.1.  
housing and small buildings, 9.27.7.  
material standards, 5.9.1.1., 9.27.7.1.
- Classification of buildings/building parts  
by major occupancy, 3.1.2.1., 9.10.2.  
for wind load calculations, 4.1.7.2.

## Clearances

- (see also Headroom clearance)
- attic or roof spaces, 9.19.1.3.
- chimneys, 6.3.3.1., 9.21.5., 9.25.3.3.
- cladding above ground, 9.27.2.4.
- cladding to roof, 9.27.2.4.
- combustible framing, 9.22.9.3.
- combustible material, 6.3.2.6., 9.22.9., 9.33.6.8.
- cooktops, 9.10.22.1.
- cooling towers, 6.3.2.15.
- crawl spaces, 9.18.4.1.
- door frames, 9.27.9.5., 9.27.10.4.
- ducts, 6.3.2.6., 9.22.9.4., 9.33.6.8.
- electric ranges, 9.10.22.1.
- furnace plenums, 6.3.2.6., 9.33.6.8.
- furnaces, 6.2.1.5., 9.33.5.2.
- gas-fired ranges, 9.10.22.1.
- gas vents, 9.25.3.3.
- above ground, 9.15.4.6., 9.27.2.4.
- handrails, 9.8.7.5.
- hardboard siding, 9.27.9.5., 9.27.10.4.
- heating and air-conditioning equipment, 6.2.1.5., 9.33.5.2.
- ovens, 9.10.22.1.
- pipes, 6.7.1.2., 9.33.8.3.
- propane ranges, 9.10.22.1.
- siding above ground, 9.27.2.4.
- siding to roof, 9.27.2.4.
- smoke chambers, 9.22.9.3.
- solid-fuel-burning appliances, 9.33.5.3.
- solid-fuel fired appliances, 6.2.1.5.
- stucco from ground, 9.28.1.4.
- supply ducts, 6.3.2.6., 9.33.6.8.
- unit heaters, 6.4.2.1.
- vented products of combustion, 6.3.3.1.
- window frames, 9.27.9.5., 9.27.10.4.
- wood-frame construction, 9.23.2.2.
- wood above ground, 9.3.2.9., 9.23.2.3.

Climatic data, 1.1.3., 9.36.5.5.

## Closures

- (see also Doors; Windows)
- chutes, 3.6.3.3.
- definition, 1.4.1.2.[A]
- door latches, 3.1.8.15., 3.4.6.16., 9.10.13.9.
- elevator shaft openings, 3.2.6.5.
- exterior wall openings, 3.2.3.5.
- fire dampers, 9.10.13.13.
- fire-protection rating, 3.1.8.4., 3.1.8.5., 9.10.13.1.
- in fire separations, 3.2.8.2., 3.3.3.5., 9.10.9.3., 9.10.13., 9.10.13.8.
- glass blocks, 3.1.8.16., 3.2.3.5., 9.10.13.7.
- hold-open devices, 3.1.8.14., 9.10.13.11.
- installation, 3.1.8.5., 9.10.13.1.
- protection of exit facilities, 3.2.3.13.
- self-closing devices, 3.1.8.13., 3.4.6.13., 9.9.6.7., 9.10.13.10., 9.10.13.15.
- temperature limits, 3.1.8.17.
- twenty-minute, 3.1.8.12.
- unprotected openings, 3.2.3.1.
- wired glass, 3.1.8.16., 3.2.3.5.

## Cold weather requirements

- concrete, 9.3.1.9.
- excavations, 9.12.1.3.
- gypsum board, 9.29.5.10.
- HVAC systems and equipment, 6.2.1.6., 9.33.4.5.
- masonry, 9.20.14.
- stucco, 9.28.6.1.

Collar ties, 9.23.14.7.

## Columns

- anchorage, 9.23.6.2., 9.35.4.3.
- carports, 9.35.3.4., 9.35.4.2., 9.35.4.3.
- concrete, 9.17.6.
- fire-resistance rating, 9.10.8.3.
- garages, 9.35.4.2., 9.35.4.3.
- heavy timber construction, 3.1.4.7.
- housing and small buildings, 9.17.
- lateral support, 9.17.2.2.
- masonry, 9.17.5.
- steel, 9.10.14.5., 9.10.15.5., 9.17.3.
- supported on masonry or concrete, 9.20.8.4.
- wood, 9.10.14.5., 9.10.15.5., 9.17.4.

Combustible cladding, 3.2.3.7., 9.10.14.5., 9.10.15.2.

## Combustible construction

- definition, 1.4.1.2.[A]
- exterior cladding, 3.1.4.8.
- fire-retardant-treated wood in, 3.1.4.5., 3.1.4.8.
- foamed plastics in, 3.1.4.2., 9.10.17.10.
- heavy timber in, 3.1.4.6., 3.1.4.7.
- materials permitted, 3.1.4.1.
- projections, 9.10.12.4., 9.10.14.5., 9.10.15.5.
- raceways in, 3.1.4.4.
- supports, 3.1.8.2., 9.10.9.8.
- wires and cables in, 3.1.4.3.

Combustible content, 3.2.8.8.

## Combustible dusts

- definition, 1.4.1.2.[A]
- and fire hose nozzles, 3.2.5.11.

## Combustible fibres

- definition, 1.4.1.2.[A]
- storage building classification, 3.1.2.6.

## Combustible gases

- compressed, indoor storage, 3.3.6.3.
- storage, 3.3.6.2.

## Combustible liquids

- definition, 1.4.1.2.[A]
- storage, 3.3.2.16., 3.3.4.3.
- storage and dispensing rooms, 3.3.6.4.

## Combustible materials

- clearances to ducts, 3.6.5.6., 6.3.2.6., 9.33.6.8.
- in combustible construction, 3.1.4.1.
- in noncombustible construction, 3.1.5.2., 3.1.5.6., 9.10.6.
- storage, 3.3.6.2.

## Combustible piping

- drain, waste and vent, 3.1.9.5., 9.10.9.7.
- in noncombustible construction, 3.1.5.19.
- in sprinkler systems, 3.1.9.5., 3.2.5.13., 9.10.9.6.
- in vacuum cleaning systems, 3.1.9.5.
- for water distribution, 3.1.9.5., 9.10.9.6.

## Combustible projections

- exposing building face, 3.2.3.6., 9.10.14.5., 9.10.15.5.

- at firewalls, 3.1.10.7.
- limiting distance, 3.2.3.6.
- soffit protection, 3.2.3.16., 9.10.12.4.
- Combustible refuse storage, 3.6.2.5.
- Combustion venting, 6.3.3.1., 9.32.3.8.
- Commercial cooking equipment, 3.3.1.2., 6.3.1.7., 9.10.1.4., 9.10.13.13.
- Communication, voice (see Voice communication systems)
- Compatibility
  - fasteners for cladding, 9.27.5.5.
  - resistance to deterioration, 5.1.4.2.
- Compliance
  - definition, 1.2.1.1.[A]
  - energy performance, 2.2.8.3.[C]
- Concealed spaces
  - fire blocks in, 3.1.11.1., 3.1.11.3., 3.1.11.4., 3.1.11.5., 3.1.11.7., 9.10.16., 9.10.16.1.
  - above fire separations, 3.1.8.3.
  - fire separations in, 3.6.4.2., 3.6.4.3., 9.10.9.10.
  - insulation, 3.1.11.2.
- Concrete
  - admixtures, 9.3.1.8.
  - aggregate for, 9.3.1.1., 9.3.1.4., 9.3.1.7.
  - cantilevered precast steps, 9.8.10.
  - cellular, 9.20.2.4.
  - chimneys, 1.4.1.2.[A], 6.3.3.2., 9.21., 9.33.10.3.
  - cold weather requirements, 9.3.1.9.
  - columns, 9.17.6.
  - dampproofing, 9.13.2.3., 9.13.2.4., 9.13.2.5.
  - design, 4.2.3.5., 4.2.3.6., 9.3.1., 9.4.1.1.
  - flues, 9.21.
  - foundations, 4.2.3.5., 4.2.3.6., 9.15.
  - joints, 9.15.4.9.
  - mixes, 9.3.1.7.
  - plain, reinforced and prestressed, 4.3.3., 9.3.1.
  - roof tiles, 9.26.2.1., 9.26.17.
  - slabs, for floors-on-ground, 9.16.4., 9.25.2.3., 9.33.6.7.
  - stairs, 9.8.9.2., 9.8.10.
  - standards for, 9.3.1.1., 9.3.1.3.
  - strength, compressive, 9.3.1.6.
  - structural design basis, 4.3.3.1.
  - sulphate-resistant, 9.3.1.3.
  - surface finish, 9.16.4.1.
  - as thermal barrier, 3.1.5.14., 3.1.5.15.
  - topping, 9.16.4.2., 9.23.4.4.
  - water used in, 9.3.1.5.
- Concrete block, 9.15.2.2., 9.17.5.1., 9.20.2.6.
- Condensation control
  - air barrier systems, 9.25.3.1.
  - in exhaust ducts, 6.3.2.10.
  - and heat transfer, 5.3.1.2.
  - properties, 9.25.5.1.
  - scope of Code, 5.1.1.1.
  - thermal insulation, 9.25.2.1.
  - vapour barrier properties, 5.5.1.2.
  - vapour barriers, 9.25.4.3.
- Conditioned space, 1.4.1.2.[A]
- Conflicting requirements, 1.5.1.2.[A]
- Connected buildings, 3.2.6.3.
- Construction
  - relative to occupancy, 9.10.8.
  - review of work, 2.2.7.2.[C]
  - types, 9.10.6.
- Construction camps, 9.10.21.
- Construction sites
  - excavations, 8.2.2.
  - guard persons, 8.2.1.4.
  - repair of damaged public property, 8.2.3.4.
  - safety measures, 8.1.
  - unoccupied, 8.2.1.5.
  - use of streets or public property, 8.2.3.
  - vehicular traffic control, 8.2.4.
  - warning lights, 8.2.3.5.
  - waste material, 8.2.5.
- Constructor, definition, 1.4.1.2.[A]
- Contained use areas
  - definition, 1.4.1.2.[A]
  - doors and door hardware, 3.3.1.13., 3.4.6.11., 3.4.6.16.
  - fire alarm systems, 3.2.4.1.
  - fire annunciators, 3.2.4.8.
  - fire separations, 3.3.3.7.
  - smoke detectors, 3.2.4.11.
  - sprinkler system requirements, 3.2.2.19.
- Contaminated air
  - minimum distances of air intakes from, 6.3.2.9.
  - movement, 3.2.6.2., 3.2.6.3.
  - removal, 6.3.1.6., 6.3.2.14.
- Continental seating, 3.3.2.4.
- Controls
  - barrier-free, 3.8.2.6., 3.8.3.8., 3.8.3.10., 3.8.3.16., 3.8.3.17.
  - location, 3.8.3.8.
  - operation, 3.8.3.8.
  - temperature, 9.33.4.3.
- Convalescent homes
  - fire alarm systems, 3.2.4.3.
  - as residential occupancies, 3.1.2.5., 9.10.2.2.
- Convectors, 9.33.7.1.
- Cooking equipment, commercial, 3.3.1.2., 6.3.1.7., 9.10.1.4., 9.10.13.13.
- Cooktops
  - (see also Stoves)
  - clearances, 9.10.22.1., 9.10.22.2.
  - definition, 1.4.1.2.[A]
  - fans, 9.32.3.11.
  - hoods, 9.32.3.11.
  - installation, 9.10.22.1., 9.33.5.3.
  - protection around, 9.10.22.3.
- Coolers, walk-in, 3.1.4.2., 3.1.5.7., 9.10.17.10.
- Cooling systems and equipment
  - installation, 6.6.1.1., 9.33.9.1.
  - structural movement, 4.1.8.18., 6.2.1.4., 9.33.4.7.
  - system pressure, 6.2.1.3., 9.33.4.6.
- Cooling towers and sections, 6.3.2.15.
- Corbelling, 9.15.4.8., 9.20.12.
- Cornices, 3.1.11.5.
- Corridors
  - (see also Public areas; Public corridors)
  - access to exit, 3.3.2.6., 9.9.7.

- assembly occupancy, 3.3.2.6.
  - care, treatment or detention occupancy, 3.3.3.3., 3.3.3.5.
  - dead-end, 3.1.8.17., 3.3.1.9., 3.3.3.3., 3.3.4.4., 9.9.7.3.
  - dimensions, 3.3.1.9., 9.9.5.2.
  - doors opening into, 3.3.1.11., 9.9.6.1.
  - emergency lighting, 3.2.7.3.
  - fire separations, 9.10.9.15.
  - flame-spread rating, 3.1.13.6., 9.10.21.6.
  - illumination, 3.2.7.1., 3.2.7.3.
  - loads on floor or roof, 4.1.5.3., 4.1.5.4.
  - obstructions, 3.3.1.9., 9.9.5.2., 9.9.5.3., 9.9.6.1.
  - paired doors in, 3.3.3.3.
  - serving patients' sleeping rooms, 3.3.3.5.
  - sliding glass partitions, 9.6.1.4.
  - smoke detectors, 3.2.4.11.
  - temperature rise and area limits exception, 3.1.8.19.
  - transparent doors in, 3.3.1.19.
  - transparent panels in, 3.3.1.19.
  - width, 3.3.1.9., 9.9.3.3., 9.9.5.2.
  - width, in dwelling units, 9.5.4.1.
  - windows in, 3.3.1.19.
  - Corrosion protection
    - (see also Corrosion resistance)
    - pipes, 9.31.2.2.
    - service water heaters, 9.31.6.3.
    - steel beams, 9.23.8.2.
    - steel lintels, 9.20.5.2.
  - Corrosion resistance
    - (see also Corrosion protection)
    - ducts, 6.3.2.3., 9.33.6.2., 9.33.6.7.
    - elements in environmental separators, 5.1.4.2.
    - fasteners for cladding, 9.27.5.5.
    - masonry connectors, 9.20.16.1.
    - plumbing, 9.31.2.2.
    - screens and grilles, 6.3.2.9., 9.32.3.13.
    - service water heaters, 9.31.6.3.
  - Counters
    - for service to the public, 3.8.3.1., 3.8.3.19.
    - for telephones, 3.8.3.20.
  - Covered ways, 8.2.1.1., 8.2.1.2.
  - Coverings
    - ducts, 3.6.5.4., 6.3.2.5., 9.33.6.4.
    - pipes, 6.3.2.5.
  - Crack control joints, 9.15.4.9.
  - Cranes, loads due to, 4.1.3.2., 4.1.5.11.
  - Crawl spaces
    - access, 3.6.4.6., 9.18.2.1., 9.18.4.1.
    - air barrier systems in, 9.18.1.3.
    - application of Code, 3.6.1.1.
    - clearance, 9.18.4.1.
    - drainage, 9.18.5.
    - fire blocks in, 3.1.11.1., 3.1.11.6.
    - fire resistance of floors over, 9.10.8.1., 9.10.9.4.
    - fire separations, 3.3.1.4.
    - flame-spread rating, 9.18.7.1.
    - ground cover, 9.18.6.
    - heated, 9.13.4.2., 9.18.1.3., 9.33.3.1.
    - housing and small buildings, 9.18.
    - insulation, 9.18.1.3., 9.25.2.2., 9.25.2.3.
    - regulated as basements, 3.2.2.9., 9.10.8.9.
    - return-air inlets, 9.33.6.12.
    - supply outlets, 9.33.6.11.
    - unheated, 9.18.1.3.
    - vapour barrier in, 9.18.1.3.
    - ventilation, 6.3.1.2., 9.18.3.
      - as warm-air plenums, 9.18.7.1.
  - Curbs, repair and storage garages, 3.3.5.4., 9.8.8.4.
  - Curtain walls (see Fenestration)
  - Curved roofs, snow and rain loads, 4.1.6.10.
  - Cutting operations room, 3.3.1.25.
- ## D
- Dampers
    - (see also Fire dampers)
    - access, 6.2.1.6., 9.33.4.4.
    - adjustable, 9.33.6.9.
    - fireplaces, 9.22.6.1.
  - Dampproofing
    - crawl spaces, 9.18.6.
    - floors, 9.23.2.3.
    - floors-on-ground, 9.13.2.1., 9.13.2.6.
    - foundations, 9.13.2.
    - installation, 9.13.2.4.
    - material standards, 5.9.1.1., 9.13.2.2.
    - preparation of surface, 9.13.2.3.
    - protection from groundwater, 5.7.3.4.
    - protection of interior finishes, 9.13.2.5., 9.20.13.9., 9.23.2.3.
    - requirement for, 9.13.2.1.
    - walls, 9.13.2.1., 9.13.2.3., 9.13.2.4., 9.20.13.9., 9.23.2.3.
  - Dance halls
    - access to exit, 3.3.1.17.
    - principal entrances, 3.4.2.6.
  - Dangerous goods
    - access openings, 3.2.5.1.
    - definition, 1.4.1.2.[A]
    - hazardous areas design, 3.3.6.
    - process plants, 3.3.6.8., 3.3.6.9.
    - storage, 3.3.6.2., 3.3.6.3.
  - Dead-end corridors, 3.1.8.17., 3.3.1.9., 3.3.3.3., 3.3.4.4., 9.9.7.3.
  - Dead loads, 1.4.1.2.[A], 4.1.3.2., 4.1.4., 9.4.3.1.
  - Decay, protection against, 9.3.2.9., 9.23.2.2., 9.23.2.3.
    - (see also Deterioration)
  - Decking for wood shingled roofs, 9.26.9.1.
  - Decks
    - foundations, 9.12.2.2.
    - snow loads, 9.4.2.3.
    - sprinkler systems, 3.2.5.12.
  - Deep foundations
    - damaged, 4.2.7.6.
    - definition, 1.4.1.2.[A]
    - design, 4.2.7.2.
    - installation, 4.2.7.5.
    - load testing, 4.2.7.2.
    - location and alignment, 4.2.7.3., 4.2.7.4.
  - Definitions of words and phrases, 1.4.1.2.[A], 4.1.3.1.

- Deflections  
 air barrier systems, 5.2.2.1., 5.4.1.1.  
 structure, 4.1.3.5., 4.1.8.13., 9.4.3.
- Deformation resistance, 5.2.2.1., 9.12.2.2., 9.15.1.3.
- Demolition sites, safety measures, 8.1.1.3.
- Depressurization, protection against, 9.32.3.8.
- Design  
 environmental separation, 5  
 HVAC systems, 6.2.1.1., 9.33.1.1., 9.33.4.1.  
 structural, 4, 9.4.
- Design calculations and analyses, 2.2.4.5.[C]
- Designer  
 definition, 1.4.1.2.[A]  
 of parts and components, 2.2.4.4.[C]  
 as reviewer of work, 2.2.7.2.[C], 2.2.7.3.[C],  
 2.2.7.4.[C]  
 signature requirements, 2.2.4.2.[C], 2.2.4.4.[C]  
 structural, requirements for, 2.2.1.2.[C]  
 subsurface inspection, 4.2.2.3., 4.2.2.4., 4.2.4.1.
- Design temperatures  
 indoor, 5.2.1.2., 5.3.1.2., 5.5.1.2., 9.33.3.1.  
 outdoor, 1.1.3.1., 5.2.1.1., 5.3.1.2., 5.5.1.2., 6.2.1.2.,  
 9.33.3.2., 9.33.5.1.
- Detectors  
 carbon monoxide, 6.3.1.4., 6.9.3.1., 9.32.3.8.,  
 9.32.3.9.  
 fire, 1.4.1.2.[A], 3.2.4.4., 3.2.4.10.  
 heat, 1.4.1.2.[A], 9.10.18.3., 9.10.18.4.  
 smoke, 1.4.1.2.[A], 3.1.8.14., 3.2.4.8., 3.2.4.11.,  
 3.2.4.12., 3.2.4.14., 3.2.4.20., 3.2.4.21., 3.6.2.7.,  
 6.9.2.2., 9.10.18., 9.10.18.3., 9.10.18.4., 9.10.18.5.,  
 9.10.21.7.  
 sprinklers installed in lieu of, 9.10.18.4.
- Detention occupancy (see Care, treatment or  
 detention occupancy)
- Deterioration  
 (see also Decay, protection against)  
 due to moisture, 5.5.1.2.  
 resistance to, 5.1.4.2., 9.20.16.1.
- Diaphragms, earthquake design, 4.1.8.15.
- Differential movement  
 columns, 9.17.2.2.  
 decks and other accessible platforms, 9.12.2.2.,  
 9.23.6.2.  
 elements in environmental separation, 5.1.4.1.,  
 5.2.2.1.  
 metal and vinyl cladding, 9.27.5.6.
- Diffusers, 3.6.5.7., 9.33.6.10., 9.33.6.11.  
 (see also Air outlets)
- Dining areas, loads, 4.1.5.6.
- Direct-vented, 1.4.1.2.[A]
- Dispensing rooms, flammable and combustible  
 liquids, 3.3.6.4.
- Distilled beverage alcohol, 1.4.1.2.[A]
- Distilleries, 1.4.1.2.[A], 3.2.5.11.
- Distribution panel, emergency lighting, 3.2.7.10.
- Domes, snow and rain loads, 4.1.6.10.
- Door assemblies  
 as fire-protection closures, 3.1.8.5.  
 leakage rates, 3.1.8.4.
- Door frames  
 caulking, 9.20.13.11.  
 sealant, 9.27.4.1.  
 steel, 9.10.13.6.  
 thermal breaks, 9.7.3.3.  
 wood, 9.10.13.3.
- Doors  
 (see also Closures; Doorways)  
 action of, 9.9.6.4.  
 airtightness, 9.36.2.9., 9.36.2.10.  
 area, calculating, 9.36.2.3.  
 barrier-free path of travel, 3.8.3.6.  
 in bedrooms, 9.9.10.1.  
 containing foamed plastics, 3.1.4.2.  
 in corridors, 3.3.1.13., 3.3.3.3., 9.9.6.1., 9.10.13.  
 dimensions, 3.3.3.4., 9.5.5., 9.9.6.3.  
 direction of swing, 3.3.1.11., 3.3.3.3., 3.4.6.10.,  
 3.4.6.12., 3.6.2.6., 9.9.6.5., 9.10.13.12.  
 between dwelling unit and garage, 9.10.13.15.  
 in dwelling units, 3.1.13.2.  
 emergency crossover access to floor areas, 3.4.6.18.  
 for exits, 3.1.8.14., 3.4.5.1., 3.4.6.11., 3.4.6.12.,  
 3.4.6.16., 9.9.6.  
 exterior, 5.3.1.2., 5.4.1.2., 9.7.4.3., 9.7.5.2.  
 in fire separations, 3.1.8.12. - 3.1.8.15., 3.1.8.17.,  
 3.3.3.5., 9.10.13.  
 flame-spread rating, 3.1.13.2., 3.1.13.7., 9.10.17.1.  
 force required to open, 9.9.6.8.  
 glass or transparent, 3.3.1.19., 3.4.1.8., 9.6., 9.6.1.3.,  
 9.9.4.3.  
 hardware (see Hardware for doors)  
 housing and small buildings, 9.7.  
 incinerator rooms, 3.6.2.6.  
 installation, 9.7.6.  
 at landings, 9.8.6.2.  
 manufactured and pre-assembled, 9.7.4.  
 in means of egress, 3.3.1.13., 3.4.6.10., 3.4.6.11.,  
 9.9.6., 9.9.7., 9.10.13.  
 in means of egress from dwelling units, 9.9.9.  
 in means of egress from suites, 9.9.6., 9.9.7.4.,  
 9.9.7.6., 9.9.8.  
 near steps or stairs, 3.4.6.11., 9.8.6.2., 9.9.6.6.  
 opening onto landings, 9.8.6.3.  
 performance expectations, 9.7.3.  
 power operators, 3.8.2.7., 3.8.3.6.  
 protection, 9.8.8.1.  
 resistance to forced entry, 9.7.5.2.  
 revolving, 3.4.6.15., 9.9.6.4.  
 service rooms, 3.6.2.6., 9.10.13.12.  
 site-built, 9.7.5.  
 sliding (see Sliding doors)  
 in smoke-tight barriers, 9.10.9.3.  
 of solid core wood, 9.10.13.  
 standards for, 5.3.1.2., 5.4.1.2., 9.7.4., 9.10.13.2.  
 storage garages, 9.9.6.4.  
 storage suites, 9.9.6.4.  
 storm, 5.9.2.4., 9.6.1.4., 9.7.3.1., 9.7.3.3.  
 temperature limits, 3.1.8.17.  
 thermal breaks, 5.9.2.4., 9.7.3.3.  
 thermal characteristics, 9.36.2.7.

thresholds, 3.3.1.13., 3.4.6.1., 3.8.3.6., 3.8.3.16.  
water-closet stalls, 3.8.3.11.

Door stops, 9.10.13.16.

Doorways  
(see also Doors)  
barrier-free path of travel, 3.8.3.6.  
bathrooms, 9.5.5.3.  
dimensions, 3.3.3.4., 3.4.3.2., 9.5.5., 9.7.2.2., 9.9.6.2.,  
9.9.6.3.  
between dwelling unit and garage, 9.10.13.15.  
dwelling units, 9.5.5.1.  
headroom clearance, 3.4.3.4.  
at landings, 9.8.6.2., 9.8.6.3.  
means of egress, 3.3.1.5.  
means of egress from dwelling units, 9.9.9.  
means of egress from suites, 3.3.1.3., 3.3.1.5.,  
9.9.7.2., 9.9.7.4., 9.9.7.6., 9.9.8.  
near stairs, 9.8.6.2.  
obstructions, 9.9.6.1., 9.9.6.3.  
at ramp landings, 9.8.6.3.  
secondary suites, 9.5.5.1.  
service rooms, 9.9.5.9.  
water closet rooms, 9.5.5.2.  
width, 3.3.3.4., 3.4.3.2.

Downspouts, 5.6.2.2., 9.14.6.5., 9.26.18.1.

Draft stops, 3.2.8.6.

Drainage  
above-ground masonry walls, 9.20.13.9.  
building envelopes, 5.6.2.2.  
crawl spaces, 9.18.5.  
disposal, 5.6.2.2., 9.14.5.  
evacuation site, 9.14.4.3.  
floors, 9.16.3.3.  
floors-on-ground, 9.16.3.  
footings, 9.14.  
foundations, 9.14.2., 9.35.3.3.  
granular layer installation, 9.14.4.2., 9.14.4.4.  
granular layers, 9.14.2.1., 9.14.4.  
granular material, 9.14.4.1.  
housing and small buildings, 9.14.  
pipes, 9.14.3.  
pipes and tiles installation, 9.14.3.3.  
roofs, 5.6.2.2., 9.26.18.  
second plane of protection, 9.27.3.  
surface water, 5.7., 9.12.3.2., 9.14., 9.14.6.  
tiles, 9.14.3.  
underground ducts, 6.3.2.12., 9.33.6.7.

Drainage systems, sanitary, 1.4.1.2.[A], 9.31., 9.31.2.1.,  
9.31.5.  
(see also Plumbing)

Drain pans, 6.3.2.2.

Drains  
floors, 9.31.4.3.  
from noncombustible water closets, 9.10.9.7.  
roofs, 5.6.2.2., 9.26.18.2.

Drain, waste and vent piping, 3.1.9.5., 9.10.9.7.  
(see also Plumbing)

Draperies, in exits, 9.9.5.6.

Drift limits, earthquake design, 4.1.8.13.

Drilling of framing members, 9.23.5.1.

Drinking fountains, 3.8.2.8., 3.8.3.10.

Dry standpipes, 3.2.5.9.

Dry wells, 9.14.5.3.

Ducts  
access, 3.6.4.5., 6.2.1.6., 9.33.4.4.  
access openings, 6.3.2.4.  
adhesives, 3.6.5.4., 9.33.6.4.  
air filters in, 6.8.1.3.  
aluminum, 9.33.6.5.  
in ceiling spaces, 3.1.9.6., 9.10.5.1.  
cleaning, 6.2.1.6., 9.33.4.4.  
clearances, 3.6.5.6., 6.3.2.6., 9.22.9.4., 9.33.6.8.  
combustible, 3.6.5.1., 9.33.6.2.  
in or beneath concrete slabs, 9.33.6.7.  
connections, 6.3.2.4., 9.33.6.6., 9.33.6.7.  
connectors, 3.6.5.1., 6.3.2.3., 6.3.2.18., 9.33.6.2.  
construction, 9.33.6.6.  
for cooking equipment, 3.1.8.8., 3.1.8.9., 3.6.3.5.  
coverings, 3.6.5.4., 6.3.2.5., 9.10.17.12., 9.33.6.4.  
design, 6.2.3., 9.33.6.1., 9.33.6.5.  
dimensions, 9.32.3.11.  
drainage, 6.3.2.12., 9.33.6.7.  
drain pans, 6.3.2.2.  
exhaust (see Exhaust ducts)  
in exits, 6.9.2.4.  
in fire-rated assemblies, 3.1.9.6., 9.10.5.1., 9.10.9.6.  
fire stops, 9.33.6.6.  
fittings, 6.3.2.3., 9.32.3.11., 9.33.6.2., 9.33.6.5.  
galvanized, 9.33.6.5.  
installation, 6.2.3., 9.33.6.1., 9.33.6.7.  
insulation, 3.6.5.4., 6.3.2.5., 9.32.3.11., 9.33.6.4.  
interconnection, 6.3.2.7., 9.33.6.7.  
joints, 6.3.2.4., 9.32.3.11., 9.33.6.3., 9.33.6.6., 9.33.6.7.  
leakage, 6.3.2.7.  
linings, 3.6.5.4., 6.3.2.5., 9.10.17.12., 9.33.6.4.  
materials, 6.3.2.3., 9.32.3.11., 9.33.6.2.  
metal, 9.33.6.5.  
noncombustible, 3.1.8.8., 3.1.8.9., 3.6.5.1.  
in noncombustible construction, 3.1.5.18.  
penetrating fire blocks, 9.10.16.4.  
penetrating fire separations, 3.1.8.7., 3.1.8.8.,  
3.1.8.9., 3.1.9.2., 9.10.9.6., 9.10.13.13.  
penetrating fire stops, 3.1.11.7.  
return air systems, 1.4.1.2.[A], 3.6.5.8., 6.3.2.11.,  
9.33.6.7., 9.33.6.13.  
sealing, 3.6.5.3., 6.3.2.19., 9.32.3.11., 9.33.6.3.,  
9.33.6.7.  
smoke detectors in, 6.9.2.2.  
supply, 9.32.3.11., 9.33.6.7.  
systems, 6.2.3., 9.33.6.  
trunk, 9.33.6.7.  
underground, 6.3.2.12., 9.33.6.7.  
ventilation, 6.2.3., 9.32.3.11., 9.33.6.2.

Duct-type smoke detectors, 3.2.4.12.

Dumbwaiters, 3.5.1.1., 3.5.2.1., 3.5.3.2.

Dusts, hazardous, 6.9.1.2.

Dwelling units  
(see also Housing and small buildings)  
alarm audibility, 3.2.4.18.  
combustible projections, 3.2.3.6., 9.10.14.5.  
definition, 1.4.1.2.[A]  
doors in means of egress, 9.9.6.

- door swing, 3.4.6.12., 9.9.6.5.
  - doorways, 9.5.5., 9.9.6.2., 9.9.6.3.
  - egress, 3.3.4.4., 9.9.9.
  - electrical outlets, 9.34.2.2.
  - exception for combustible projections, 9.10.15.5.
  - fire alarms, 9.10.18.2.
  - fire alarm systems, 3.2.4.1.
  - fire detectors, 3.2.4.10.
  - fire protection, 3.2.2.47. - 3.2.2.54., 9.10.
  - fire-protection closures, 3.1.8.5.
  - fire-resistance rating, 9.10.8.10.
  - fire separations, 3.3.4.2., 9.9.4., 9.10.9.4., 9.10.9.11., 9.10.9.12., 9.10.9.14.
  - firewalls, 9.10.11.2.
  - floors-on-ground, 9.16.1.3.
  - guards, 3.3.4.7., 9.8., 9.8.8.
  - hallways, 9.5.4.1.
  - handrails, 3.3.4.7., 9.8., 9.8.7.
  - height of rooms and spaces, 3.7.1.1., 9.5.3.
  - landings, 9.8.6., 9.8.6.3.
  - manual fire alarm stations, 3.2.4.16.
  - ramps, 9.8., 9.8.5.2.
  - secondary suites, 9.1.2.1.
  - in self-service storage buildings, 3.9.3.1.
  - shared egress facilities, 9.9.9.3.
  - smoke alarms, 3.2.4.20., 9.10.19.
  - sound control, 3.3.4.6., 5.8.1.1., 9.11.
  - spatial separation between houses, 9.10.15.
  - sprinkler systems, 3.2.5.12.
  - stairs, 3.3.4.7., 9.8.
  - travel limit to exits, 9.9.9.1.
  - uniformity of runs in flights with mixed treads, 9.8.4.5.
  - water closets, 9.31.4.1.
- Dynamic procedure
- earthquake load and effects calculations, 4.1.8.12.
  - wind load calculations, 4.1.7.8.
- ## E
- Earthquake design
- accidental torsional effects, 4.1.8.12.
  - analysis, 4.1.8.1., 4.1.8.7.
  - anchorage of building frames, 9.23.6.1.
  - bracing to resist lateral loads, 9.23.13.
  - building strength and stability, 4.1.3.2.
  - deflections, 4.1.8.13.
  - direction of loading, 4.1.8.8.
  - dynamic analysis, 4.1.8.12.
  - equivalent static force analysis, 4.1.8.11.
  - fasteners for sheathing or subflooring, 9.23.3.5.
  - foundations, 4.1.8.16., 4.1.8.17.
  - joints in top plates of loadbearing walls, 9.23.11.4.
  - masonry walls, 9.20.1.2., 9.20.15.
  - notation, 4.1.8.2.
  - requirements, 4.1.8.3.
  - roof sheathing, 9.23.16.1.
  - seismic force reduction factors and system overstrength factors, 4.1.8.9.
  - seismic isolation, 4.1.8.19., 4.1.8.20.
  - site properties, 4.1.8.4.
  - special provisions, 4.1.8.10., 4.1.8.15.
  - structural irregularities, 4.1.8.6.
  - structural separation, 4.1.8.14.
  - supplemental energy dissipation, 4.1.8.21., 4.1.8.22.
- Eave projections, 9.10.14.5., 9.10.15.5., 9.26.5.
- Eave protection, 9.26.2.1., 9.26.5.1., 9.26.5.2.
- Effective thermal resistance (RSI value), definition, 9.36.1.2.
- Egress (see Doors; Doorways; Means of egress)
- Egress doorways, 3.3.1.5., 3.3.1.6.
- Electrical conductors
- protection of, 3.2.7.10.
  - tests, 3.2.7.10.
- Electrical equipment, 3.6.1.2., 9.33.5.2., 9.34.
- Electrical equipment vaults, 3.6.2.7.
- Electrical supervision, fire alarm systems, 3.2.4.9.
- Electrical wiring
- exit signs, 3.4.5.2.
  - housing and small buildings, 9.34.
  - service facilities, 3.6.1.2.
- Electric cables, storage, 3.3.6.2.
- Electromagnetic locking device, 3.3.1.13., 3.4.6.16., 3.4.6.18., 9.9.6.7.
- Elevating devices, 3.8.2.3., 3.8.3.7.
- Elevator cables, 3.1.5.22.
- Elevator cars, flame-spread rating, 3.1.13.11.
- Elevators
- application of Code, 3.5.1.1.
  - barrier-free path of travel, 3.3.1.7., 3.8.2.3., 3.8.3.2., 3.8.3.7.
  - dimensions, 3.5.4.1.
  - earthquake design, 4.1.8.18.
  - emergency operation, 3.2.6.4., 3.2.7.9.
  - emergency recall, 3.2.4.14., 3.2.6.4.
  - for firefighters, 3.2.6.5., 3.2.7.9.
  - fire protection, 9.10.1.3.
  - flame-spread rating, 3.1.13.7.
  - high buildings, 3.2.7.9.
  - hoistway noise, 5.8.1.1.
  - hoistways, 3.2.6.4., 3.2.6.6., 3.2.8.4., 3.5.3.1., 3.5.3.3., 3.5.4.2., 9.10.18.4.
  - machine rooms, 3.2.1.1., 3.2.2.14., 3.2.5.12., 3.5.3.3.
  - not a means of egress, 9.9.2.3.
  - smoke detectors, 3.2.4.11., 3.2.4.14.
  - standards, 3.5.2.1., 3.8.3.7.
- Emergency cables and conductors, 3.2.7.10.
- Emergency elevators, 3.2.6.4., 3.2.6.5., 3.2.7.9.
- Emergency lighting, 3.2.7.3., 3.2.7.4., 3.2.7.10., 9.9.12., 9.9.12.3.
- Emergency power supply
- exit signs, 9.9.11.3.
  - installation, 3.2.7.5., 3.6.2.8.
  - lighting, 3.2.7.4., 9.9.12.3.
  - smoke alarms, 9.10.19.4.
- Emergency return, elevators, 3.2.4.14., 3.2.6.4.
- Energy efficiency
- building envelope, 9.36.2.
  - definition, 9.36.1.2.
  - energy performance compliance, 9.36.5.
  - housing and small buildings, 9.36.

- HVAC systems and equipment, 9.36.3.
- service water heating systems, 9.36.4.
- Energy performance
  - compliance, 9.36.5.
  - definitions, 9.36.5.2.
  - drawings and specifications, 2.2.8.[C]
- Entrances, barrier-free, 3.8.2.2.
- Environmental loads, 5.1.4.1., 5.2.1., 5.2.1.3., 5.9.3.2.
- Environmental separation
  - air leakage, 9.25., 9.25.3.
  - application of Code, 5
  - compliance with standards, 5.9.1.1.
  - condensation control, 9.25.
  - crawl spaces, 9.18.
  - dampproofing, 9.13., 9.13.2.
  - drawings and specifications, 2.2.5.2.[C]
  - fire (see Fire separations)
  - heat transfer, 9.25., 9.25.2.
  - roof spaces, 9.19.
  - soil gas control, 9.13., 9.13.4.
  - sound control, 5.8.1., 9.11.
  - waterproofing, 9.13., 9.13.3.
- Equipment
  - air-conditioning, 9.33.5.
  - characteristics, 1.2.2.1.[A]
  - cooking, 3.3.1.2., 6.3.1.7., 9.10.1.4., 9.10.13.13.
  - electrical installations, 9.33.5.2., 9.34.1.1.
  - HVAC, 6.1.1.2., 9.33.1.1., 9.33.5.
  - loads on floors and roofs, 4.1.5.3.
  - odour removal, 9.33.6.14.
  - space cooling, 9.33.5.2., 9.33.9.
  - space heating, 9.33.5.2.
  - storage, 1.2.2.2.[A]
  - used, 1.2.2.3.[A]
- Escalators, 3.2.8.2., 3.5.1.1., 3.5.2.1., 3.8.2.4., 9.10.1.3.
  - earthquake design, 4.1.8.18.
- Evaporative air coolers, 6.3.2.16.
- Evaporative condensers, 6.3.2.15.
- Evaporative cooling towers, 6.3.2.15.
- Evaporative fluid coolers, 6.3.2.15.
- Excavations
  - backfill, 9.12.3.
  - definition, 1.4.1.2.[A]
  - depth, 9.12.2.
  - design of, 4.2.5.1.
  - erosion, 4.2.5.6.
  - grading, 9.14.4.3.
  - housing and small buildings, 9.12.
  - native soil, 9.12.1.1.
  - organic material, 9.12.1.1.
  - protection from freezing, 4.2.5.7., 9.12.1.3.
  - safety measures, 8.2.2.
  - structural design, 4.2.5.
  - support of, 4.2.5.3.
  - water control, 4.2.5.5.
  - water in, 8.2.2.1., 9.12.1.2.
- Exhaust
  - capacity, 9.32.3.3., 9.32.3.4., 9.32.3.7.
  - discharge, 6.3.2.10.
  - fans, 9.32.3.7.
  - to garages, 6.3.2.10.
  - intakes, 9.32.3.3., 9.32.3.5., 9.32.3.7.
  - outlets, 3.6.5.7., 6.3.2.10.
  - systems, 3.2.6.6., 3.2.8.7., 3.3.1.20., 9.10.9.18.
- Exhaust air openings, 6.3.2.9.
- Exhaust ducts
  - combining, 6.3.2.10.
  - condensation, 6.3.2.10.
  - definition, 1.4.1.2.[A]
  - fire dampers in, 9.10.13.13.
  - fire dampers waived, 3.1.8.8.
  - insulation, 6.3.2.5., 9.32.3.11., 9.33.6.4.
  - interconnection, 6.3.2.7., 6.3.2.10.
  - laboratory enclosures, 6.3.4.3.
  - serving cooking equipment, 6.3.2.10.
  - serving laundry equipment, 6.3.2.10., 9.32.1.3.
  - serving more than one fire compartment, 9.10.9.18.
  - smoke dampers waived, 3.1.8.9.
  - vertical service spaces, 3.6.3.4.
- Exhibitions, 3.1.2.3.
- Existing buildings, application of Code, 1.1.1.1.[A]
- Exits
  - (see also Means of egress)
  - access to, 3.4.6.17., 9.9.7., 9.9.7.1.
  - aggregate width, 3.4.3.1., 3.4.3.2., 9.9.3.
  - appliances in, 9.9.5.7.
  - balconies, 3.4.4.1.
  - capacity, 3.4.3.2.
  - combustible glazing restrictions, 3.4.1.10.
  - convergence, 3.4.1.2.
  - cumulative width, 3.4.3.2.
  - definition, 1.4.1.2.[A]
  - distance between, 3.4.2.3.
  - door hardware, 3.4.6.16., 3.4.6.17.
  - doors, 3.2.3.13., 3.4.3.3., 3.4.6.11., 3.4.6.13., 3.4.6.16., 9.7.2.2.
  - door swing, 3.4.6.12.
  - ducts in, 6.9.2.4.
  - dwelling units, 3.3.4.4., 9.9.9.
  - emergency access, 3.4.6.18.
  - emergency lighting, 3.2.7.3., 9.9.12.
  - exterior passageways, 3.1.13.10., 3.4.1.5.
  - finish, interior, 9.10.17.
  - fire alarm systems, 3.2.4.1.
  - fire hose connections, 3.2.5.10.
  - fire separations, 3.4.4.1., 9.9.4.
  - from floor areas, 9.9.8.
  - general requirements, 9.9.2.
  - glass block in, 3.2.3.13., 9.9.4.3. - 9.9.4.7.
  - glass doors, 9.6., 9.9.4.3.
  - glass and transparent panels and doors, 3.4.1.8.
  - guards, 3.4.6.6.
  - headroom clearance, 3.4.3.4., 9.8.2.2., 9.9.3.4., 9.9.6.2.
  - horizontal, 3.4.1.4., 3.4.1.6., 9.9.2.1.
  - housing and small buildings, 9.9.
  - integrity, 3.4.4.4., 9.9.4.2.
  - interconnected floor space, 3.2.8.4., 3.4.3.2.
  - landings, 9.8.1.3.
  - level, lowest, and smoke contamination, 3.2.6.2.
  - levels, 1.4.1.2.[A], 3.2.6.2.
  - lighting, 3.2.7.1., 9.9.12.



loads on floor or roof, 4.1.5.3.  
 through lobbies, 3.4.4.2., 9.9.8.5.  
 location, 3.4.2.5., 9.9.8.4.  
 manual fire alarm stations, 3.2.4.16.  
 from mezzanine, 3.4.2.2., 9.9.8.6.  
 minimum number, 3.4.2.1.  
 mirror restrictions, 3.4.1.9., 9.9.5.6.  
 number, 9.9.7.1., 9.9.7.2., 9.9.8.2., 9.9.9.  
 obstructions, 3.4.6.11., 9.9.5., 9.9.5.5., 9.9.6.1.,  
 9.9.6.2., 9.9.11.2.  
 obstructions permitted, 3.4.3.3.  
 protected floor space, 3.2.8.5., 3.4.3.2.  
 purpose, 9.9.2.2.  
 ramps, 3.4.5.2.  
 revolving doors, 3.4.6.15., 9.9.6.4.  
 rooms opening into, 3.4.4.4., 9.9.5.9., 9.9.8.5.  
 secondary suites, 9.9.9.  
 separation, 3.4.1.2.  
 service rooms under, 3.6.2.2., 9.9.5.8.  
 signs, 3.4.5.1., 3.4.5.2., 9.9.11., 9.9.11.3.  
 smoke detectors, 3.2.4.11.  
 stairs, 3.4.5.2., 3.4.6.8., 3.4.6.9., 9.8.1.3., 9.8.2.1.,  
 9.8.3.1.  
 storage garages, 9.9.6.4.  
 storeys, 1.4.1.2.[A], 3.2.6.2.  
 travel distance, 3.4.2.1., 3.4.2.3., 3.4.2.4., 9.9.8.2.  
 types, 3.4.1.4., 9.9.2.1.  
 visibility, 9.9.11.2.  
 wall openings near, 9.9.4.4.  
 weather protection, 3.4.6.11.  
 width, 3.4.3.3., 9.9.3.2., 9.9.3.3., 9.9.8.3.  
 windows, 3.2.3.13., 9.7.2.2., 9.9.4.  
 wired glass in, 3.2.3.13., 9.9.4.3. - 9.9.4.6.

Expansion and contraction  
 elements in environmental separation, 5.1.4.1.,  
 5.2.2.1.  
 heating and cooling systems, 6.2.1.3., 9.33.4.6.,  
 9.33.8.1.  
 metal and vinyl siding, 9.27.5.6.  
 piping, 6.7.1.1., 9.33.8.1.  
 structural, 4.1.2.1.

Explosion venting, 3.3.1.20.

Exposing building face  
 area, 3.2.3.2.  
 area and aspect ratio, 9.10.14.5.  
 area and location, 9.10.14.2., 9.10.15.2.  
 construction, 3.2.3.7., 9.10.14.5., 9.10.15.5.  
 definition, 1.4.1.2.[A]  
 exits, 3.2.3.13.  
 fire resistance waived, 9.10.14.5., 9.10.15.5.  
 first storey facing a street, 9.10.14.4.  
 garage serving a dwelling unit, 9.10.14.5.  
 glazed openings, 9.10.15.2.  
 limiting distance, 3.2.3.5., 3.2.3.6., 3.2.3.7., 9.10.14.5.,  
 9.10.15.5.  
 low-hazard industrial occupancy (Group F,  
 Division 3), 3.2.3.11.  
 in noncombustible construction, 3.1.5.5.  
 protection of, 3.2.3.8.  
 restrictions on combustible projections, 3.2.3.6.,  
 9.10.14.5., 9.10.15.5.

spatial separation between buildings, 9.10.14.,  
 9.10.15.  
 structural members, 3.2.3.9.  
 unlimited openings, 3.2.3.10., 9.10.14.4., 9.10.15.4.  
 unprotected openings, 3.2.3.1., 3.2.3.2., 3.2.3.12.,  
 9.10.14.4., 9.10.15.4.

Exterior areas, loads on, 4.1.5.5.  
 Exterior insulation finish systems, 5.9.4., 9.27.12.  
 Exterior ornamentations  
 earthquake loads, 4.1.8.1.  
 wind loads, 4.1.7.11.

## F

Fabrics, for canopies and marquees, 3.1.16.1.

Factories  
 loads on floor or roof, 4.1.5.3.  
 storage areas, 4.1.5.3.

Factory-built chimneys, 1.4.1.2.[A], 9.33.10.2.

Factory-constructed buildings, 1.1.1.1.[A]

Falsework, 4.1.1.3.

Fans  
 access, 6.2.1.6., 9.33.4.4.  
 auxiliary, 9.32.3.4.  
 bathrooms, 9.32.3.3.  
 capacity, 9.32.3.3., 9.32.3.10.  
 controls, 9.32.3.3.  
 cooktops, 9.32.3.7., 9.32.3.11.  
 dehumidistat, 9.32.3.3., 9.32.3.7.  
 emergency power supply, 3.2.7.9.  
 emergency stoppage, 3.2.6.2.  
 exhaust, 9.32.3.3., 9.32.3.5.  
 housing and small buildings, 9.32.3.  
 installation, 6.3.2.17., 9.32.3.3. - 9.32.3.6., 9.32.3.10.  
 kitchens, 9.32.3.3., 9.32.3.7.  
 location, 6.3.2.17., 9.32.3.2.  
 noise, 9.32.3.2.  
 sound ratings, 9.32.3.10.  
 standards for, 9.32.3.10.  
 supplementary exhaust, 9.32.3.7.  
 supply, 9.32.3.4., 9.32.3.5.  
 vibration, 9.32.3.2.

Farm buildings  
 application of Code, 1.1.1.1.[A]  
 definition, 1.4.1.2.[A]

Fasteners  
 cladding, 9.27.5.4.  
 dimensions, 9.27.5.4.  
 gypsum board, 9.29.5.5.  
 roofing, 9.26.2.3., 9.26.2.4.  
 siding, 9.27.5.4.  
 standard for, 9.23.3.1.  
 stucco, 9.28.3.1., 9.28.3.2.

Fastening  
 cladding, 9.27.5.4.  
 furring, 9.29.3.2.  
 gypsum board, 9.29.5.8., 9.29.5.9.  
 hardboard finish, 9.29.7.3.  
 plywood finish, 9.29.6.3.  
 sheathing, 9.23.3.5.

- shingles, 9.26.7.4., 9.26.8.4., 9.26.8.5.
- siding, 9.27.5.4.
- steel framing, 9.24.3.6.
- steel studs, 9.24.1.4.
- stucco lath, 9.28.4.6.
- subflooring, 9.23.3.5.
- underlay, 9.30.2.3.
- wood-frame construction, 9.23.3.
- wood shingles and shakes, 9.26.9.5., 9.26.10.3.
- Faucets and other bathroom accessories, 3.7.2.3., 3.7.2.9., 3.8.3.8., 3.8.3.11., 3.8.3.15., 3.8.3.17.
- Fences, at construction and demolition sites, 8.2.1.3.
- Fenestration
  - (see also Windows)
  - airtightness, 5.9.3.4., 9.36.2.9.
  - area, calculating, 9.36.2.3.
  - definition, 9.36.1.2.
  - heat transfer, 5.9.3.3.
  - resistance to water penetration, 5.9.3.5.
  - structural and environmental loads, 5.9.3.2.
  - thermal characteristics, 9.36.2.2., 9.36.2.7.
  - thermal resistance calculation, 9.36.2.11.
  - types, 5.9.3.1.
  - water penetration, 5.9.3.5.
- Fibreboard
  - fastening, 9.29.8.3.
  - installation, 9.29.8.3., 9.29.8.4.
  - as insulating finish, 9.29.8.
  - material standard, 9.29.8.1.
  - nailing, 9.29.8.3.
  - as roof sheathing, 9.23.16.7.
  - thickness, 9.29.8.2.
  - as wall sheathing, 9.23.17.2., 9.23.17.3.
- Fill
  - (see also Backfill; Backfilling)
  - definition, 1.4.1.2.[A]
  - beneath floors-on-ground, 9.16.2.1., 9.16.2.2.
  - beneath footings, 9.15.3.2.
  - beneath foundations, 4.2.4.13.
- Filters, air, 6.8.1.3., 9.33.6.14.
- Finishes
  - interior (see Interior finishes)
  - slip-resistant, 3.4.6.1.
- Fire alarm and detection systems
  - annunciators, 3.2.4.8.
  - audibility, 3.2.4.18., 3.2.4.21.
  - audible alert and alarm signals, 3.2.4.17.
  - central alarm and control facility, 3.2.6.7.
  - central vacuum shutdown, 3.2.4.13.
  - continuity, 3.2.4.2.
  - design, 9.10.18.3.
  - and door hold-open devices, 3.1.8.14.
  - electrical supervision, 3.2.4.9.
  - emergency power supply, 3.2.7.8.
  - fire detectors, 3.2.4.4., 3.2.4.10.
  - fire separations for, 3.6.2.8.
  - installation, 3.2.4.1., 3.2.4.5., 9.10.18.3.
  - manual stations, 3.2.4.16.
  - requirements, 9.10.18.
  - residential fire warning systems, 3.2.4.21., 9.10.19.8.
  - signal devices, 3.2.4.18.
  - signals to fire department, 3.2.4.7.
  - silencing, 3.2.4.6.
  - single stage systems, 3.2.4.3., 3.2.4.4., 3.2.4.7.
  - smoke alarms, 3.2.4.20.
  - smoke detectors, 3.2.4.11., 3.2.4.12., 9.10.18., 9.10.18.5.
  - sprinkler systems, 3.2.4.8.
  - testing, 3.2.4.5.
  - two-stage systems, 3.2.4.3., 3.2.4.4., 3.2.4.7.
  - types, 3.2.4.3.
  - vacuum cleaning systems, 9.10.18.7.
  - visual signal devices, 3.2.4.19.
  - voice communication systems, 3.2.4.22.
  - waterflow trigger, 3.2.5.14.
- Fire blocks
  - (see also Fire stops)
  - in concealed spaces, 3.1.11., 9.10.16.
  - definition, 1.4.1.2.[A]
  - in eave overhangs, 3.2.3.16.
  - in floor assemblies, 3.1.11.5.
  - in mansard and gambrel roofs, 3.1.11.5., 9.10.16.1.
  - materials, 3.1.11.7., 9.10.16.3.
  - in noncombustible construction, 3.1.5.2., 3.1.11.3.
  - pipes and ducts in, 9.10.16.4.
  - in roof assemblies, 3.1.11.5., 3.1.11.7.
  - in walls/wall assemblies, 3.1.11.2., 9.10.16.2.
- Fire chambers, 9.22.4.
- Fire compartments
  - annunciators, 3.2.4.8.
  - basements, 3.2.1.5.
  - combustible sprinkler piping, 3.2.5.13.
  - definition, 1.4.1.2.[A]
  - exits, 3.2.3.13.
  - exposing building face area, 3.2.3.2.
  - unprotected openings, 3.2.3.1.
  - wall exposed to another wall, 3.2.3.14.
- Fire curtains, 3.3.2.14.
- Fire dampers
  - (see also Dampers)
  - access, 3.1.8.10.
  - as closures, 3.1.8.5.
  - definition, 1.4.1.2.[A]
  - in ducts, 9.10.13.13.
  - in fire separations, 3.1.8.7.
  - in HVAC systems, 6.9.2.1.
  - installation, 3.1.8.10.
  - leakage rates, 3.1.8.4.
  - in non-loadbearing walls, 9.24.3.7.
  - penetrating fire separations, 9.10.9.6.
  - waived, 3.1.8.8.
- Fire department
  - access routes, 3.2.5.4., 3.2.5.6.
  - limiting distance, 9.10.15.3.
  - signals to, 3.2.4.7., 3.2.4.9., 3.2.6.7.
- Fire department connections on buildings, 3.2.5.5., 3.2.5.9., 3.2.5.15.
- Fire detectors, 1.4.1.2.[A], 3.2.4.4., 3.2.4.10.
- Fire escapes
  - access, 3.4.7.3.
  - balconies, 3.4.7.3.
  - closures, 3.4.7.4.

- construction, 3.4.7.2.
- dwelling units, 3.4.7.3.
- existing buildings, 3.4.7.1.
- guards, 3.4.7.6.
- handrails, 3.4.7.6.
- headroom, 3.4.7.5.
- landings, 3.4.7.7.
- loads on, 4.1.5.3.
- as means of egress, 3.4.1.4., 9.9.2.3.
- protection of, 3.4.7.4.
- scope of Code, 3.4.7.1.
- stairs, 3.4.6.8., 3.4.7.5.
- Fire extinguishers, 3.2.5.16., 9.10.20.4., 9.10.21.8.
- Fire extinguishing systems, industrial occupancies, 3.3.5.2.
- Firefighters, 3.2.6.2., 3.2.6.5., 3.2.8.7.
- Firefighting (see Access for firefighting)
- Firefighting services (see Fire department)
- Fire hose cabinets, 3.2.5.11.
- Fire hose nozzles, 3.2.5.11.
- Fire hose stations, 3.2.5.11., 9.10.21.9.
- Fire load, 1.4.1.2.[A], 3.2.2.89., 3.2.3.11.
- Fireplaces
  - airtightness, 9.36.2.9.
  - chimneys, 9.21.2.5., 9.21.2.6.
  - clearances, 9.22.9.
  - combustion air, 9.22.1.4.
  - concrete materials, 9.22.1.2.
  - continuity of insulation, 9.36.2.5.
  - dampers, 9.22.6.1.
  - design and installation, 6.9.4.2.
  - factory-built, 9.22.8.
  - fire chamber, 9.22.4.
  - footings, 9.22.1.3.
  - hearth, 9.22.5.
  - housing and small buildings, 9.22., 9.33.5.4.
  - inserts, 9.22.10.
  - liners (see Liners, fireplace)
  - masonry materials, 9.22.1.2.
  - protection against depressurization, 9.32.3.8.
  - smoke chambers, 9.22.7.
  - walls, 9.22.3.
- Fire protection
  - air-supported structures, 3.1.6.
  - building classification, 3.1.2.
  - combustible construction, 3.1.4.
  - commissioning of life safety and fire protection systems, 9.10.1.2.
  - components, 2.2.3.[C], 3.1.1.4.
  - construction camps, 9.10.21.
  - cooktops, 9.10.22.
  - crawl spaces, 9.18.7.
  - dwelling units, 9.10.
  - electric ranges, 9.10.22.
  - electrical conductors, 3.2.7.10.
  - exceptions, 3.2.2.3.
  - exits, 9.9.4.
  - fire-resistance ratings, 3.1.7.
  - fire safety plan, 1.1.4.
  - gas ranges, 9.10.22.
  - limiting distance and spatial separation between buildings, 3.2.3.1.
  - multiple occupancy requirements, 3.1.3.
  - noncombustible construction, 3.1.5.
  - ovens, 9.10.22.
  - penetrations in fire separations and fire-rated assemblies, 3.1.9.1.
  - propane ranges, 9.10.22.
  - structural, 3.2.2.3.
  - structural members, 3.2.3.9.
  - tents, 3.1.6.
  - testing of integrated fire protection and life safety systems, 9.10.1.2.
  - tests, 3.2.9.1.
- Fire-protection rating
  - of closures, 3.1.8.4., 3.1.8.5.
  - definition, 1.4.1.2.[A]
  - of doors, 3.1.8.12.
  - exceptions, 9.10.13.2., 9.10.13.5., 9.10.13.7.
  - of fire dampers, 3.1.8.7.
  - tests, 3.1.8.4., 9.10.3.1.
- Fire protection systems, 3.2.5.17., 9.10.18., 9.10.20.5.
- Fire pumps, 3.2.4.9., 3.2.5.9., 3.2.5.18., 9.10.1.3.
- Fire-resistance ratings
  - about, 9.10.3.
  - arena-type building roof assemblies, 3.2.2.17.
  - ceilings, 9.10.3.3.
  - definition, 1.4.1.2.[A]
  - determination of, 3.1.7.1., 9.10.3.1.
  - doors, 5.3.1.2.
  - exemptions, 9.10.8., 9.10.8.11., 9.10.14.
  - exits, 9.9.4.2.
  - exposing building face, 3.2.3.7.
  - fire separations, 3.1.7.3.
  - firewalls, 3.1.7.3., 3.1.10.2., 9.10.3.3.
  - floors and floor assemblies, 3.1.7.3., 3.2.1.4., 9.10.3.1., 9.10.3.3., 9.10.8.
  - grease duct enclosures, 3.6.3.5.
  - membrane ceilings, 9.10.3.4.
  - minimum, 3.1.7.4.
  - relation to occupancy and height, 9.10.8.
  - roofs, 9.10.8.
  - separation of suites, 3.3.1.1., 9.10.9.13., 9.10.9.14.
  - steel framing, 9.24.2.4., 9.24.3.2.
  - supporting construction, 3.1.7.5., 9.10.8.3.
  - test methods, 9.10.3.1.
  - vertical fire separations, 9.10.3.3.
  - walls, 9.10.3.3.
  - walls, exterior, 3.1.7.2., 3.1.7.3., 3.2.3.7., 3.2.3.11., 9.10.3.1., 9.10.3.3., 9.10.14.5., 9.10.15.5.
  - walls, interior, 9.10.3.1., 9.10.3.3.
  - walls, loadbearing, 3.1.7.5., 9.10.8.3.
  - windows, 5.3.1.2.
- Fire-retardant-treated wood
  - in assembly occupancy (Group A, Division 2), 3.2.2.25.
  - in assembly occupancy (Group A, Division 3), 3.2.2.32.
  - in business and personal services occupancy (Group D), 3.2.2.60.
  - in combustible construction, 3.1.4.5., 3.1.4.8.

- for decorative cladding, 3.1.5.24.
- definition, 1.4.1.2.[A]
- in low-hazard industrial occupancy (Group F, Division 3), 3.2.2.83.
- in medium-hazard industrial occupancy (Group F, Division 2), 3.2.2.76.
- in mercantile occupancy (Group E), 3.2.2.66.
- in noncombustible construction, 3.1.5.5., 3.1.5.12., 3.1.13.8.
- in roof systems, 3.1.14.1.
- Fire safety
  - and building size, 3.2.1.1., 9.10.8.
  - construction sites, 8.1.1.1.
  - demolition sites, 8.1.1.1.
  - in HVAC systems and equipment, 6.9.1.1., 9.33.6.
  - and occupancy, 9.10.8.
  - self-service storage buildings, 3.9.2.
  - tests, 3.2.9.1.
- Fire separations
  - airtightness of windows and doors in, 5.4.1.2.
  - barrier-free floor areas, 3.3.1.7.
  - boarding and lodging houses, 9.10.9.14.
  - on building face, 3.2.3.2.
  - business and personal services occupancy, 3.3.1.1.
  - care, treatment or detention occupancy, 3.3.3.1.
  - closures in, 3.1.8.1., 3.1.8.4., 3.1.8.5., 9.10.13.
  - in combustible construction, 3.1.8.2.
  - construction camps, 9.10.21.2.
  - containment in basements, 3.2.1.5.
  - continuity, 3.1.8.1., 3.1.8.3., 9.10.9.2., 9.10.11.2.
  - crawl spaces, 3.2.2.9., 9.10.9.4.
  - definition, 1.4.1.2.[A]
  - and door hold-open devices, 3.1.8.14.
  - and door self-closing devices, 3.1.8.13.
  - dumbwaiters, 3.5.3.2.
  - dwelling units, 3.3.4.2., 9.10.9.11., 9.10.9.12., 9.10.9.13.
  - elevator machine rooms, 3.5.3.3.
  - elevators, 3.2.6.5., 3.5.3.1.
  - exits, 3.4.4.1., 9.9.4.
  - fire dampers in, 3.1.8.7.
  - fire-resistance rating, 3.1.7.3.
  - firewalls, 3.1.10.1.
  - floor assemblies, 3.3.4.2.
  - floors over basements, 3.2.1.4.
  - garages, 9.10.4.3., 9.10.9.16., 9.10.9.17.
  - grease duct enclosures, 3.6.3.5.
  - horizontal, 3.1.8.8.
  - in horizontal service spaces, 3.1.8.3.
  - horizontal service spaces, 3.6.4.2., 9.10.9.10.
  - industrial occupancy (group F), 3.3.5.1., 9.10.9.11., 9.10.9.12., 9.10.9.16., 9.10.9.17.
  - integrity, 9.10.9.3.
  - interconnected floor spaces, 9.10.9.5.
  - interior walls, 9.10.12.3.
  - laboratory ventilation enclosures, 3.3.1.20.
  - libraries, 3.3.2.13.
  - and major occupancy, 9.10.9.11., 9.10.9.16., 9.10.9.17.
  - meeting of two exterior walls, 9.10.12.3.
  - mercantile occupancy (group E), 3.3.1.1.
  - mezzanines, 3.2.8.1.
  - and multiple occupancies, 3.1.3.1., 9.10.9.11., 9.10.10.
  - between openings, 3.2.3.17.
  - openings in, 3.1.8.1., 3.1.8.6., 3.1.8.17., 3.2.8.2., 9.10.13., 9.24.3.7.
  - openings protected by glass blocks or wired glass, 3.1.8.16.
  - operating, recovery and delivery rooms, 3.3.3.6.
  - protected floor spaces, 3.2.8.5.
  - public corridors, 3.3.1.4., 9.10.9.15.
  - rating, 9.10.3.
  - repair garages, 3.3.5.5.
  - residential occupancy (Group C), 3.2.2.47., 3.3.4.2., 9.10.9.11., 9.10.9.12., 9.10.9.14.
  - roof-top enclosures, 3.2.2.14.
  - between rooms and spaces within buildings, 9.10.9.
  - secondary suites, 9.10.9.4., 9.10.9.14., 9.10.9.15., 9.10.10.4., 9.10.11.2., 9.10.12.3.
  - self-service storage buildings, 3.9.3.1.
  - self-storage warehouses, 3.3.5.9.
  - service penetrations, 3.1.9.2. - 3.1.9.6., 9.10.9.6.
  - service rooms, 3.6.2.1., 9.10.8.5., 9.10.10.
  - soffit protection, 9.10.12.4.
  - steel framing, 9.24.2.4., 9.24.3.7.
  - storage of dangerous goods, 3.3.6.2.
  - storage garages, 3.2.1.2., 3.3.4.2., 3.3.5.6., 3.3.5.7.
  - storage rooms, 3.3.4.3., 9.10.10.6.
  - storeys below ground, 3.2.2.15.
  - suites, 3.3.1.1., 3.3.4.2., 9.10.9.13., 9.10.9.14.
  - temperature rise and area limits, 3.1.8.19.
  - theatre stages, 3.3.2.14.
  - thermal breaks in windows and doors in, 5.3.1.2.
  - twenty-minute closures, 3.1.8.12.
  - vehicular passageways, 3.2.3.18.
  - vertical, 3.1.8.8., 3.1.8.9.
  - vertical service spaces, 3.6.3.1.
  - in vertical shafts, 3.1.8.3.
  - vestibules, 3.2.8.4.
  - walkways, 3.2.3.19., 3.2.3.20.
  - wall exposed to another wall, 3.2.3.14.
  - watertightness of windows and doors in, 5.9.2.3.
  - between zones in hospitals or nursing homes, 3.3.3.5.
- Fire stop flaps, 1.4.1.2.[A], 3.6.4.3., 9.10.13.14.
- Fire stops
  - (see also Fire blocks)
  - definition, 1.4.1.2.[A]
  - in noncombustible construction, 3.1.5.2.
  - pipes and ducts in, 3.1.9.5., 9.10.9.6., 9.33.6.6.
  - and service penetrations, 3.1.9.1., 9.10.9.7.
- Firewalls
  - combustible projections, 3.1.10.7.
  - construction, 9.10.11.
  - continuity, 3.1.10.3.
  - continuity of insulation, 9.36.2.5.
  - definition, 1.4.1.2.[A]
  - exemptions, 9.10.11.2.
  - exterior walls meeting at, 3.1.10.6.
  - and fire alarm systems, 3.2.4.2.

- fire-resistance rating, 3.1.7.3., 3.1.10.2., 9.10.3.3., 9.10.11.3.
- maximum openings in, 3.1.10.5.
- mezzanines, 3.2.8.1.
- parapets, 3.1.10.4.
- party walls as, 9.10.11.1.
- penetrations in, 3.1.9.1.
- separating buildings, 1.3.3.4.[A]
- structural stability, 3.1.10.1., 4.1.5.17.
- support of, 3.1.10.1., 4.1.5.17.
- First storey, 1.4.1.2.[A], 3.2.2.15., 3.2.5.1., 3.2.8.2.
- Fixed seats, 3.3.2.4.
- Fixed seats, bench type without arms, 3.3.2.8.
- Flags, for directing traffic, 8.2.4.2.
- Flame-spread rating
  - bathrooms, 3.1.13.3., 9.10.17.11.
  - business and personal services occupancy, 9.10.17.
  - combustible insulation, 9.10.17.10., 9.10.17.12.
  - combustible piping, 3.1.5.19.
  - combustible skylights, 9.10.17.9.
  - corridors, 9.10.17.2., 9.10.17.5.
  - crawl spaces, 9.18.7.1.
  - definition, 1.4.1.2.[A]
  - diffusers and grilles, 9.33.6.10.
  - doors, 3.1.13.2., 9.7.2.2., 9.10.17.1.
  - ducts, linings and coverings, 9.10.17.12., 9.33.6.4.
  - elevator cars, 3.1.13.7., 3.1.13.11.
  - exits, 3.1.13.2., 3.1.13.7., 3.1.13.8., 9.10.17.2.
  - exterior exit passageways, 3.1.13.10., 9.10.17.4.
  - fire-retardant-treated wood, 3.1.4.5.
  - firewalls, 9.10.11.3.
  - foamed plastic insulation, 3.1.5.15., 9.10.17.10.
  - glazing, 3.1.5.4., 3.1.13.2., 9.10.17., 9.10.17.1., 9.10.17.6., 9.10.17.9.
  - gypsum board, 9.29.5.2.
  - high buildings, 3.1.13.7.
  - industrial occupancy, 9.10.17.
  - insulation, 5.9.1.1., 9.25.2.2.
  - insulation in concealed spaces, 9.10.17.
  - insulation in noncombustible construction, 3.1.5.14., 3.1.5.15.
  - interior finishes, 3.1.5.12., 9.10.17.
  - light diffusers and lenses, 3.1.13.4., 9.10.17.6., 9.10.17.8.
  - lobbies, 3.1.13.2., 9.10.17.3.
  - mercantile occupancy, 9.10.17.
  - public corridors, 3.1.13.6., 9.10.17.
  - residential occupancy, 3.1.13.3., 9.10.17.
  - service rooms, 3.1.13.7., 9.10.17.
  - skylights, 3.1.5.4., 3.1.13.2., 9.7.2.2., 9.10.17., 9.10.17.1., 9.10.17.6., 9.10.17.9.
  - tests, 3.1.12.1., 9.10.3.2.
  - vehicular passageways, 3.1.13.2.
  - ventilated laboratory enclosures, 6.3.4.4.
  - vestibules, 3.1.13.7.
  - windows, 9.7.2.2.
- Flammable gases (see Combustible gases)
- Flammable liquids
  - definition, 1.4.1.2.[A]
  - door thresholds, 3.3.1.13., 3.4.6.1.
  - piping for, in trench, 6.9.1.2.
  - storage, 3.3.2.16., 3.3.4.3., 3.3.6.2.
  - storage and dispensing rooms, 3.3.6.4.
- Flashing, chimney
  - caps, 9.21.4.6.
  - junctions with other materials, 9.21.4.10.
- Flashing, doors, 9.7.6.2.
- Flashing, roof
  - built-up-roofing at cant strips, 9.26.11.10.
  - built-up-roofing to masonry, 9.26.4.6.
  - built-up-roofing to other than masonry, 9.26.4.7.
  - at intersections, 9.26.4.
  - materials, 9.26.2.1., 9.26.4.2., 9.26.4.3.
  - purpose, 9.26.1.2.
  - sealing and drainage, 5.6.2.1.
  - shingles to masonry, 9.26.4.4.
  - shingles to other than masonry, 9.26.4.5.
  - valley, 9.26.4.3.
- Flashing, skylights, 9.7.6.2.
- Flashing, wall
  - cavity walls, 9.20.13.5., 9.20.13.6.
  - fastening, 9.20.13.2.
  - installation, 9.20.13.3., 9.27.3.8.
  - masonry veneer, 9.20.13.6.
  - masonry walls, 9.20.13.
  - materials, 9.20.13.1., 9.27.3.7.
  - sealing and drainage, 5.6.2.1.
  - stucco, 9.28.1.5.
- Flashing, windows, 9.7.6.2., 9.20.13.3., 9.20.13.4.
- Flash point, 1.4.1.2.[A]
- Flat roofs, wind loads, 4.1.7.6.
- Flight, 1.4.1.2.[A]
  - (see also Stairs)
- Floor areas
  - barrier-free design, 9.5.2.
  - barrier-free path of travel, 3.3.1.7.
  - care, treatment or detention occupancy, 3.3.3.1.
  - combination rooms, 9.5.1.2.
  - definition, 1.4.1.2.[A]
  - emergency access, 3.4.6.18.
  - general requirements, 3.3.1.
  - secondary suites, 9.1.2.1.
  - self-service storage buildings, 3.9.3.
  - separation of suites, 3.3.1.1.
  - termination, 9.10.12.1.
- Flooring
  - ceramic tile, 9.23.15.5., 9.30.6.
  - finish, 9.30.1.4.
  - in hazardous materials storage area, 3.3.6.7.
  - housing and small buildings, 9.30.
  - parquet, 9.30.4.
  - supports, 9.30.1.3.
  - underlay, 9.30.2.
  - water-resistant membranes, 9.30.1.2.
  - wood strip, 9.23.15.5., 9.30.3.
- Floor joists, support of, 9.15.5.1.
- Floor numbers
  - Arabic numerals, 3.4.6.19., 9.9.11.5.
  - elevator hoistways, 3.5.4.2.
  - exits, 3.4.6.19., 9.9.11.5.
- Floors
  - acting as diaphragms, 4.1.8.15., 4.1.8.18.

- air barrier systems, 9.25.3.
- anchorage, 9.20.11.1.
- cantilevered, 9.23.9.9.
- combustible elements in noncombustible construction, 3.1.5.10.
- concrete topping, 9.23.4.4.
- construction camps, 9.10.21.3.
- dampproofing, 9.13.2.1.
- drains, 9.31.4.3.
- fire-resistance ratings, 3.1.7.3., 9.10.3.1., 9.10.8.1., 9.10.8.8.
- as fire separations, 9.10.9.4.
- framing, 9.23.4.
- garages, 9.35.2.2.
- in heavy timber construction, 3.1.4.7.
- joists, 9.23.4.1., 9.23.4.2., 9.23.4.4., 9.23.9.
- loads due to use of, 4.1.5.
- loads on, 9.23.1.1., 9.23.4.1., 9.23.4.2., 9.23.4.4.
- subfloors, 9.23.15.
- supports, 3.2.1.4., 9.30.1.3.
- thermal insulation, 9.25.1.1.
- vibrations, 4.1.3.6.
- Floors on ground, thermal resistance, 9.36.2.8.
- Floors-on-ground
  - concrete, 9.16.4.
  - dampproofing, 9.13.2.1., 9.13.2.6.
  - drainage, 9.16.3.
  - hydrostatic uplift, 9.16.3.2.
  - in dwelling units, 9.16.1.3.
  - in housing and small buildings, 9.16.
  - material beneath, 9.16.2.
  - soil gas control, 9.13.4., 9.25.3.6.
- Flue collars, 1.4.1.2.[A]
- Flue pipes, 1.4.1.2.[A], 9.21.1.2.
- Flues, chimney
  - connections, 9.21.2.2.
  - definition, 1.4.1.2.[A]
  - dimensions, 9.21.2.4., 9.21.2.5., 9.21.4.4.
  - fireplace, 9.21.2.5.
  - inclination, 9.21.2.3.
  - masonry and concrete, 9.21.
  - oval, 9.21.2.6.
  - rectangular, 9.21.2.5.
  - round, 9.21.2.5.
  - slope, 9.21.2.3.
  - standard for, 9.21.2.
- Foamed plastic
  - dampproofing, 9.13.2.5.
  - insulation, 3.1.5.14., 3.1.5.15., 3.6.3.2., 5.3.1.3., 9.10.17.10., 9.25.2.2., 9.33.6.4.
  - in noncombustible construction, 3.1.5.2., 3.1.5.7., 3.1.5.14., 3.1.5.15.
  - protection of, 3.1.4.2., 9.10.17.10.
  - vapour barrier, 9.25.4.2.
- Footbridges, 4.1.5.3.
- Footings
  - area for column spacing, 9.15.3.3., 9.15.3.4., 9.15.3.7.
  - chimneys, 9.15.3.1., 9.21.4.3.
  - design, 9.4.4.1.
  - dimensions, 9.15.3.
  - drainage, 9.14.
  - fireplaces, 9.15.3.1., 9.22.1.3.
  - granular drainage layer, 9.14.4.
  - housing and small buildings, 9.15.
  - non-loadbearing masonry walls, 9.15.3.6.
  - projections, 9.15.3.8.
  - stepped, 9.15.3.9.
  - thickness, 9.15.3.8.
  - trenches, 9.12.4.1.
  - width, 9.15.3.3., 9.15.3.4., 9.15.3.5., 9.15.3.6., 9.15.3.8.
- Forced-air furnace, 1.4.1.2.[A]
- Forced-air heating systems
  - (see also Ducts; Heating systems and equipment)
  - coupled with heat recovery ventilators, 9.32.3.12.
  - ventilation systems coupled with, 9.32.3.4.
  - ventilation systems not coupled with, 9.32.3.5.
- Formwork, 4.1.1.3.
- Foundations
  - adfreezing, 4.2.4.4.
  - backfilling, 4.2.5.8., 9.12.3.
  - capacity in weaker soil or rock, 9.4.4.2.
  - of concrete, 4.2.3.5., 9.3.1.6., 9.3.1.7., 9.15.1.1., 9.15.2., 9.15.4.
  - of concrete block, 9.15.4.2.
  - dampproofing, 9.13.2.
  - deep, 1.4.1.2.[A], 4.2.7.
  - definition, 1.4.1.2.[A]
  - for deformation-resistant buildings, 9.12.2.2., 9.15.1.3.
  - depth, 4.2.4.4., 9.12.2.
  - design, 4.2.4., 9.4.4., 9.15.1.1.
  - drainage, 9.14.2., 9.35.3.3.
  - drawings and specifications, 2.2.4.6.[C], 2.2.4.7.[C], 4.2.2.2.
  - dynamic loading, 4.2.4.7.
  - earthquake design, 4.1.8.16., 4.1.8.17.
  - eccentric loading, 4.2.4.6.
  - equivalent approaches to design, 4.1.1.5.
  - excavations, 4.2.5., 9.12.
  - extension above ground, 9.15.4.6.
  - on filled ground, 4.2.4.13.
  - of flat insulating concrete forms, 9.15.1.1., 9.15.3.3., 9.15.4., 9.15.4.5.
  - footing size, 9.15.3.
  - frost action, 4.2.4.4., 9.12.2.2.
  - on frozen ground, 9.12.1.3.
  - for garages and carports, 9.35.3.
  - granular drainage layer, 9.14.4.
  - and groundwater level, 4.2.4.9., 9.4.4.3.
  - for housing and small buildings, 9.15.
  - hydrostatic pressure, 4.2.4.8., 9.16.3.2.
  - insulation, 9.25.2.2., 9.25.2.3.
  - lateral support, 9.15.4.2., 9.15.4.3., 9.15.4.4., 9.15.4.5.
  - limit states design, 4.2.4.1.
  - loads, 4.2.4.1.
  - of masonry, 4.2.3.3., 4.2.3.4., 9.15.1.1., 9.15.2., 9.15.4., 9.15.4.10.
  - materials, 4.2.3., 9.15.2.
  - movement, 4.2.4.1., 9.12.2.2.
  - on organic soils, 9.12.1.1.
  - on permafrost, 4.2.4.10., 9.15.1.2.
  - of permanent form material, 9.15.4.1.

pier type, 9.15.2.3.  
 protection from surface water, 5.7.1.1.  
 review, 4.2.2.3.  
 on rock, 9.15.3.1., 9.15.3.2.  
 shallow, 1.4.1.2.[A], 4.2.6.  
 site stability, 4.1.8.17.  
 on sloping ground, 4.2.4.5.  
 special, 4.2.8.  
 stairs with, 9.12.2.2.  
 of steel, 4.2.3.7.  
 structural design, 4.2.4.14.  
 subsurface investigation, 4.2.2.1., 4.2.4.2.  
 supporting floor joists, 9.15.5.1.  
 on swelling and shrinking soils, 4.2.4.11., 9.4.4.4.  
 thermal resistance, 9.36.2.8.  
 thickness, 9.15.4.2., 9.15.4.7.  
 trenches beneath, 9.12.4.  
 vertical reinforcement, 9.15.4.6.  
 walls, 9.4.4.6., 9.15.4., 9.36.2.8.  
 of wood, 4.2.3.1., 4.2.3.2., 9.15.1.1., 9.15.2.4.  
 for wood-frame construction, 9.15.1.1., 9.15.2.4.

**Foundation units**  
 definition, 1.4.1.2.[A]  
 drawing alterations, 2.2.4.7.[C]

**Framing**  
 anchorage, 9.23.6.  
 ceiling, 9.23.14.  
 drilling, 9.23.5.1.  
 maximum spans, 9.23.4.  
 notching, 9.23.5.2.  
 over openings, 9.23.12.  
 roof, 9.23.14.  
 sheet steel stud, 9.24.  
 supported on masonry or concrete, 9.20.8.  
 trusses, 9.23.14.11.  
 wood-frame construction, 9.23.

**Freezers, walk-in, 3.1.4.2., 3.1.5.7., 9.10.17.10.**

**Freezing, protection from (see Protection from freezing)**

**Frost action**  
 (see also Frost penetration, depth; Protection from freezing)  
 definition, 1.4.1.2.[A]  
 floors-on-ground, 9.16.2.2.  
 soil under foundations, 9.4.4.4.

**Frost penetration, depth, 1.1.3.2., 9.12.2.2.**

**Fuel dispensing facilities, 3.3.5.8., 9.10.1.3.**

**Fuel supply, shut-off valves, 3.2.7.7.**

**Functional statements**  
 application, 3.1.[A]  
 list of, 3.2.1.[A]

**Furnaces**  
 capacity, 9.33.3.1., 9.33.5.1.  
 clearances, 6.2.1.5., 9.33.5.2., 9.33.6.8.  
 definition, 1.4.1.2.[A]  
 forced-air, 1.4.1.2.[A]  
 installation, 6.2.1.6., 9.33.5.2.  
 performance requirements, 9.36.3.10.  
 plenums, 9.33.6.6., 9.33.6.7., 9.33.6.8.

**Furring**  
 cladding, 9.27.5.3.

dimensions, 9.29.3.1.  
 fastening, 9.29.3.2.  
 interior finish, 9.29.3.  
 metal thickness, 9.24.1.3.  
 nailing, 9.29.3.2.  
 stucco lath, 9.28.4.4.

## G

**Gable roofs**  
 snow and rain loads, 4.1.6.9.  
 wind loads, 4.1.7.6.

**Galvanized sheet metal, 9.3.3.2.**

**Gambrel roof**  
 fire blocks, 9.10.16.1.  
 venting, 9.19.1.4.

**Garages**  
 (see also Carports)  
 clear height, 3.3.5.4.  
 columns, 9.35.4.2., 9.35.4.3.  
 detached, 9.10.14.4., 9.10.14.5., 9.10.15.4., 9.10.15.5., 9.35.3.3.  
 doors, 9.10.13.15., 9.36.2.9.  
 for dwelling units, 9.7.5.2., 9.10.9.16., 9.35.  
 exhaust discharge into, 6.3.2.10.  
 floors, 9.3.1.6., 9.35.2.2.  
 foundations, 9.35.3.  
 guards and guardrails, 9.8.8.4.  
 interconnection of ducting, 6.3.2.7., 9.33.6.7.  
 lighting, 9.34.2.6.  
 loads on floor or roof, 4.1.5.3.  
 open-air, 9.10.14.4.  
 pressure, 6.3.1.4.  
 repair (see Repair garages)  
 resistance to forced entry, 9.7.5.2.  
 storage (see Storage garages)  
 ventilation, 3.3.5.4., 6.3.1.4., 9.32.1.1.  
 walls, 9.35.4.1., 9.35.4.3.

**Gas-burning equipment, installation standard, 6.2.1.5., 9.33.5.2.**

**Gases, hazardous, 6.9.1.2.**

**Gas mains, under buildings, 3.2.3.21.**

**Gas vents**  
 definition, 1.4.1.2.[A]  
 materials and installation, 9.33.10.1.  
 sealing around, 9.25.3.3.

**Girders, in heavy timber construction, 3.1.4.7.**

**Glass**  
 (see also Transparent panels)  
 area limits, maximum, 9.6.1.3.  
 design, 9.6.1.3.  
 doors, 3.3.1.19., 9.6.1.4., 9.7.5.2.  
 earthquake design, 4.1.8.18.  
 in exits, 3.4.1.8.  
 in fire separations, 3.2.3.13., 5.3.1.2., 9.10.13.5.  
 in guards, 9.8.8.7.  
 panels, 3.3.1.19.  
 public areas, 9.6.1.4., 9.7.5.  
 safety (see Safety glass)

- sidelights, 9.6.1.4.
- standards for, 5.9.1.1., 9.6.1.2., 9.6.1.3., 9.6.1.4., 9.7.5.2., 9.8.8.7.
- structural design basis, 4.3.6.
- structural strength, 9.6.1.3.
- thermal breaks, 5.9.2.4., 9.7.3.3.
- thickness, 9.6.1.3.
- types of, 9.6.1.4.
- wired (see Wired glass)
- Glass block assemblies, thermal characteristics, 9.36.2.7.
- Glass blocks
  - area limits, 3.1.8.18.
  - as closures, 3.1.8.5., 9.10.13.7.
  - excluding, and temperature limits, 3.1.8.19.
  - in exits, 9.9.4.3. - 9.9.4.6.
  - in fire separations, 3.1.8.16.
  - not to be used as closures, 3.2.3.5.
  - not in fireplaces or chimneys, 9.20.2.3.
  - protection of exit facilities, 3.2.3.13.
  - reinforcing, 9.20.9.6.
  - in unprotected openings, 3.2.3.12., 9.10.14.4.
- Glass-reinforced polyester roofing, 9.26.14.1.
- Glazed architectural structures (see Fenestration)
- Glazed openings, 9.10.15., 9.10.15.2., 9.10.15.4.
- Glazing
  - in doors, 9.7.1.1.
  - exit restrictions, 3.4.1.10.
  - in fire separations, 3.1.8.16.
  - in noncombustible construction, 3.1.5.4.
  - in public areas, 9.8.8.1.
  - in unprotected openings, 3.2.3.12.
  - wired glass, 3.1.8.16., 3.1.8.18., 3.1.8.19., 3.2.3.5.
- Glued-laminated timber
  - beams, 9.23.4.1., 9.23.4.2., 9.23.4.4.
  - flooring, 3.1.4.7.
  - lintels, 9.23.12.3.
- Grab bars
  - bathrooms, 3.7.2.9., 3.8.3.17.
  - loads on, 9.31.2.3.
  - showers, 3.8.3.16.
  - universal washrooms, 3.8.3.12.
  - washrooms, 3.7.2.8., 3.8.3.11.
- Grade, 1.4.1.2.[A], 3.2.3.18., 3.2.5.1.
- Grading, site
  - backfill, 9.8.10.3., 9.12.3.2.
  - environmental separation, 5.1.2.1.
  - excavations, 9.14.4.3.
  - surface drainage, 9.14.6.
  - water control, 5.7.1.1., 9.16.3., 9.18.5.
- Granular material
  - beneath floors-on-ground, 9.16.1.1., 9.16.2.1.
  - beneath footings and foundations, 9.14.2.1., 9.14.4.
- Grease duct enclosures, 3.6.3.5.
- Ground cover
  - crawl spaces, heated, 9.18.6.2.
  - crawl spaces, unheated, 9.18.6.1.
  - warm-air plenums, 9.18.7.1.
- Groundwater
  - around excavations, 4.2.5.5.
  - definition, 1.4.1.2.[A]
  - and foundations, 2.2.4.6.[C], 4.2.2.1., 4.2.2.4., 4.2.4.3., 4.2.4.9.
  - level, 1.4.1.2.[A], 4.2.4.9., 9.4.4.3., 9.14.5.3., 9.15.3.4., 9.16.3.1.
  - protection from, 5.7.3.
- Group A occupancy (see Assembly occupancy)
- Group B occupancy (see Care, treatment or detention occupancy)
- Group C occupancy (see Residential occupancy)
- Group D occupancy (see Business and personal services occupancy)
- Group E occupancy (see Mercantile occupancy)
- Group F occupancy (see Industrial occupancy)
- Grout, 9.20.3.2.
- Guards (devices)
  - balconies and decks, 4.1.7.5., 9.8.8.1., 9.8.8.3.
  - cane-detectable, on doors, 3.8.3.6.
  - definition, 1.4.1.2.[A]
  - doorways, 9.8.8.1.
  - dwelling units, 3.3.4.7., 9.8.1.
  - exits, 3.4.6.6.
  - fire escapes, 3.4.7.6.
  - fixed seats, 3.3.2.9.
  - garages, 3.3.5.4., 9.8.8.4.
  - glass, 9.8.8.7.
  - height, 3.3.1.18., 3.3.5.4., 3.4.6.6., 9.8.8.3.
  - housing and small buildings, 9.8.8.
  - industrial occupancies, 3.3.5.10.
  - landings, 3.4.6.6., 9.8.8.3.
  - loads, 3.3.5.4., 4.1.5.14., 9.8.8.2., 9.8.8.4.
  - means of egress, 9.9.1.1.
  - to not facilitate climbing, 9.8.8.6.
  - openable windows, 3.3.4.8.
  - openings through, 3.3.1.18., 3.4.6.6., 3.4.7.6., 9.8.8.5.
  - porches, 9.8.8.3.
  - as protection for vehicles, 4.1.5.15.
  - ramps, 3.4.6.6., 3.8.3.5., 9.8.8.1., 9.8.8.4.
  - secondary suites, 9.8.1.
  - stairs, 3.4.6.6.
  - where required, 9.8.8.1.
  - windows in public areas, 3.3.1.19.
  - windows in residential occupancy, 9.8.8.1.
- Guards (human), for danger zones, 8.2.1.4.
- Gypsum board
  - application standard, 9.29.5.1.
  - on exposing building face, 3.2.3.7.
  - fasteners for, 9.29.5.5.
  - fastening, 9.29.5.8., 9.29.5.9.
  - as fire separation in exit, 9.9.4.2.
  - as fire stop, 3.1.11.7.
  - installation, 9.29.5.3., 9.29.5.8., 9.29.5.9.
  - as interior finish, 9.29.5.
  - material standard, 9.29.5.2.
  - in noncombustible construction, 3.1.5.13.
  - standards, 9.10.9.2.
  - as thermal barrier, 3.1.5.14., 3.1.5.15.
  - as wall sheathing, 9.23.17.2., 9.23.17.3.
- Gypsum lath, 9.29.4.1.



## H

Hallways (see Corridors)

Handrails

- in aisles with steps, 3.3.2.10.
- attachment, 9.8.7.7.
- continuity, 3.4.6.5., 9.8.7.2.
- design, 9.8.7.7.
- in dwelling units, 3.3.4.7., 9.8.1., 9.8.7.1.
- ergonomic design, 9.8.7.5.
- graspability, 3.4.6.5., 9.8.7.5.
- height, 3.4.6.5., 9.8.7.4.
- in housing and small buildings, 9.8.7.
- loads, 3.4.6.5., 4.1.5.14., 9.8.7.7.
- in means of egress, 9.9.1.1.
- projecting into means of egress, 3.4.3.3.
- projecting into stair or ramp, 9.8.7.6.
- for ramps, 3.4.6.5., 3.8.3.5., 9.8.7.
- in secondary suites, 9.8.1., 9.8.7.
- for stairs, 3.4.6.5., 3.4.6.9., 9.8.7.
- termination, 9.8.7.3.

Hardboard

- as cladding, 9.27.2.4., 9.27.3.6., 9.27.5.
- fastening, 9.29.7.3.
- as insulating finish, 9.25.5.1.
- as interior finish, 9.29.7.
- material standards, 5.9.1.1., 9.27.9.1., 9.29.7.1.
- nailing, 9.29.7.3.
- as siding, 9.27.2.4., 9.27.3.6., 9.27.9.
- thickness, 9.3.2.7., 9.29.7.2.
- as underlay, 9.30.2.2.
- as wall sheathing, 9.25.5.1.

Hardware for doors

- access to exit, 3.3.1.13.
- automatic locking devices, 3.3.4.5.
- bolts, 9.7.5.2.
- closers in barrier-free path of travel, 3.8.3.6.
- closures, 3.1.8.5.
- door release devices, 3.3.1.13., 3.3.2.7., 3.4.6.16., 9.9.6.7.
- height, 3.4.6.16.
- hinges, 9.7.5.2.
- hold-open devices, 3.1.8.14., 9.10.13.11.
- locks and latches, 3.3.1.13., 3.4.6.16., 3.4.6.17., 3.4.6.18., 9.7.5.2., 9.9.6.7., 9.9.6.8., 9.10.13.9.
- power operators, 3.8.3.6.
- self-closing devices, 3.1.8.13., 3.4.6.13., 9.9.6.7., 9.10.13.10., 9.10.13.15.
- strikeplates, 9.7.5.2.
- on transparent doors and panels, 3.3.1.19.
- universal washrooms, 3.8.3.12.

Hatchways, 9.19.2.1., 9.25.3.3.

Hazardous substances

- explosion venting, 3.3.1.20.
- fire detectors, 3.2.4.10.
- fire protection, 9.10.1.3.
- heat and smoke detection, 9.10.18.4.
- prohibited in basements, 3.3.5.3.
- safety within floor areas, 3.3.1.2.
- storage, 9.10.1.3.

Headroom clearance

- access to exits, 9.9.3.4.
- doorways, 3.4.3.4., 9.5.5.1.
- exits, 3.4.3.4., 9.9.3.4.
- stairways, 3.4.3.4., 9.8.2.2.

Hearths, fireplace

- extensions, 9.22.5.1.
- standard for, 9.22.5.
- support, 9.22.5.2.

Heat detectors, 1.4.1.2.[A], 9.10.18.3., 9.10.18.4.

Heating appliances

- capacity, 9.33.3.1., 9.33.5.1.
- design, 6.4.1.2., 9.33.5.3.
- installation, 6.2.1.6.
- installation standards, 6.2.1.5., 9.33.5.2., 9.33.5.3.
- location, 6.4.1.1.

Heating coils, service water heaters, 9.31.6.5.

Heating systems and equipment

- access, 6.2.1.6., 6.8.1.1., 9.33.4.4.
- asbestos in, 6.2.1.7., 9.33.4.8.
- capacity, 9.33.3.1., 9.33.5.1.
- cleaning, 6.2.1.6., 9.33.4.4.
- continuity of insulation, 9.36.3.5.
- design, 6.2.1.1., 6.4.1.2., 9.33.1.1., 9.33.4.1., 9.33.5.3.
- drawings and specifications, 2.2.6.2.[C]
- energy efficiency, 9.36.
- fire safety characteristics, 6.9.1.1., 9.33.6.2. - 9.33.6.4.
- installation, 6.2.1., 9.33.1.1., 9.33.4.1.
- installation standards, 6.2.1.1., 6.2.1.5., 9.33.5.2., 9.33.5.3.
- location, 6.4.1.1.
- performance requirements, 9.36.3.10.
- protection from freezing, 6.2.1.6., 9.33.4.5.
- in residential buildings, 9.33.2.1.
- solid-fuel-burning, 6.2.1.5., 9.33.5.3.
- structural movement, 4.1.8.18., 6.2.1.4., 9.33.4.7.
- system pressure, 6.2.1.3., 9.33.4.6.
- temperature controls, 9.33.4.3., 9.36.3.6.

Heating, ventilating and air-conditioning (HVAC)

- systems and equipment
- access, 6.2.1.1., 6.2.1.6., 6.8.1.1., 9.33.4.4.
- air intakes and outlet dampers, 9.36.3.3.
- airtightness, 9.36.2.10.
- application of Code, 6
- asbestos in, 6.2.1.7., 9.33.4.8.
- cleaning, 6.2.1.6., 9.33.4.4.
- contaminant transfer prevention, 9.33.4.8.
- continuity of insulation, 9.36.3.5.
- design, 6.2., 6.2.1.1., 6.4.1.2., 9.32.3.2., 9.33.1.1., 9.33.4.1., 9.33.5.3.
- drawings and specifications, 2.2.6.2.[C]
- energy efficiency, 9.36., 9.36.3.
- energy performance calculations, 9.36.5.7.
- energy performance modeling, 9.36.5.11., 9.36.5.15.
- equipment and ducts, 9.36.3.2.
- fire safety characteristics, 6.9.1.1., 9.33.6.2. - 9.33.6.4.
- heat recovery, 9.36.3.8., 9.36.3.9.
- humidification, 6.3.2.16., 9.36.3.7.
- installation, 6.2., 9.32.3.2., 9.33.1.1., 9.33.4.1.
- installation standards, 6.2.1.1., 6.2.1.5., 9.33.5.2., 9.33.5.3.

- outdoor design conditions, 6.2.1.2.
- performance requirements, 9.36.3.10.
- pipng, 9.36.3.4.
- protection from freezing, 6.2.1.6., 9.33.4.5.
- structural movement, 4.1.8.18., 6.2.1.4., 9.33.4.7.
- system pressure, 6.2.1.3., 9.33.4.6.
- temperature controls, 9.36.3.6.
- Heat pumps, 9.36.3.6., 9.36.3.10.
- Heat recovery
  - indoor pools and hot tubs, 9.36.3.8.
  - ventilation systems, 9.36.3.9.
- Heat recovery ventilators
  - balancing, 9.32.3.12.
  - capacity, 6.3.1.5., 9.32.3.10.
  - condensate, 9.32.3.12.
  - installation, 6.3.1.5., 9.32.3.12.
  - standards for, 9.32.3.10.
- Heat transfer
  - application of Code, 5.1.1.1.
  - calculations and analyses, 5.2.1.3.
  - exterior insulation finish systems, 5.9.4.1.
  - performance in doors, windows and skylights, 5.9.2.4., 9.7.3.2.
  - performance in other fenestration assemblies, 5.9.3.3.
  - and required thermal insulation, 9.25.2.1.
  - thermal resistance of assemblies, 5.3.1., 5.3.1.2.
- Heavy timber construction
  - assembly occupancy (Group A, Division 1), 3.2.2.21.
  - assembly occupancy (Group A, Division 3), 3.2.2.30., 3.2.2.31.
  - assembly occupancy (Group A, Division 4), 3.2.2.35.
  - construction of exposing building faces, 9.10.15.5.
  - definition, 1.4.1.2.[A]
  - dimensions, 3.1.4.7.
  - exposing building faces, 9.10.14.5.
  - fire resistance, 9.10.6.2.
  - fire safety requirements, 3.1.4.7.
  - flame-spread rating, 3.1.13.8.
  - high-hazard industrial occupancy (Group F, Division 1), 3.2.2.71.
  - low-hazard industrial occupancy (Group F, Division 3), 3.2.2.87., 3.2.2.88.
  - roofs, 3.2.2.16.
  - structural members, 3.2.3.9.
  - walkways, 3.2.3.19.
  - when permissible, 3.1.4.6., 3.2.2.16.
- Height
  - access to exit, 3.3.1.8., 9.9.3.4.
  - between landings, 9.8.3.3., 9.8.4.4., 9.8.5.5.
  - ceilings, 9.5.3.
  - doorways, 9.5.5., 9.9.6.2.
  - exits, 9.9.3.4., 9.9.6.2.
  - guards, 9.8.8.3.
  - handrails, 9.8.7.4.
  - mezzanines, 9.5.3.2.
  - over landings, 9.8.6.4.
  - over ramps, 9.8.5.3.
  - over stairs, 9.8.2.2.
  - rooms and spaces, 9.5.3.1.
  - storage garages, 9.5.3.3., 9.9.3.4.
- Helicopter landing areas, 3.2.4.7., 3.2.4.16., 4.1.5.13., 9.23.16.7.
- High buildings
  - additional requirements, 3.2.6.1.
  - anchorage, 9.23.6.1.
  - central alarm and control facility, 3.2.6.7.
  - construction site protection of public, 8.2.3.2.
  - interior finishes, 3.1.13.7.
  - smoke control system testing, 3.2.6.9.
  - smoke movement limits, 3.2.6.2.
  - vertical transportation in, 3.5.1.1.
  - voice communication systems, 3.2.6.8.
  - wind loads, 4.1.7.3.
- High-hazard industrial occupancy (Group F, Division 1)
  - building classification, 3.1.2.1.
  - definition, 1.4.1.2.[A]
  - egress doorways, 3.3.1.5.
  - fire alarm systems, 3.2.4.1., 3.2.4.3.
  - fire protection, 3.2.2.70. - 3.2.2.73.
  - occupant load, 3.1.17.1.
  - safety within floor areas, 3.3.1.2.
- Hipped roofs, wind loads, 4.1.7.6.
- Hold-open devices, 3.1.8.14., 9.10.13.11.
- Horizontal exits
  - balconies, 3.4.6.10.
  - bridges, 3.4.6.10.
  - definition, 1.4.1.2.[A]
  - hose station beside, 3.2.5.11.
  - and other types of exits, 3.4.1.4.
  - restricted use, 3.4.1.6.
  - vestibules, 3.4.6.10.
  - width, 3.4.6.10.
- Horizontal service spaces
  - access, 3.6.4.5.
  - application of Code, 3.6.1.1., 3.6.4.1.
  - definition, 1.4.1.2.[A]
  - fire blocks in, 3.1.11.5.
  - above fire separations, 3.1.8.3., 9.10.9.10.
  - fire separations for, 3.6.4.2.
  - sprinkler systems, 3.2.5.14.
- Hose connections, 3.2.5.9., 3.2.5.10.
- Hospitals, 3.1.8.13., 3.3.3.5., 3.4.1.6.
- Hot tubs, heat recovery, 9.36.3.8.
- Hot water supply, 9.31.4.2.
- Housing and small buildings
  - (see also Dwelling units)
  - air leakage, 9.25.
  - cladding, 9.27.
  - columns, 9.17.
  - concrete materials, 9.3.1.
  - condensation control, 9.25.
  - crawl spaces, 9.18.
  - dampproofing, 9.13.
  - design of areas and spaces, 9.5.
  - drainage, 9.14.
  - electrical facilities, 9.34.
  - energy efficiency, 9.36.
  - excavations, 9.12.

fire protection, 9.10.  
fireplaces, 9.22.  
flooring, 9.30.  
floors-on-ground, 9.16.  
footings and foundations, 9.15.  
glass, 9.6.  
heat transfer, 9.25.  
heating and air-conditioning, 9.33.  
interior wall and ceiling finishes, 9.29.  
lumber and wood products for, 9.3.2.  
masonry and concrete chimneys, 9.21.  
masonry and insulating concrete walls, 9.20.  
materials, systems and equipment, 9.3.  
means of egress, 9.9.  
plumbing facilities, 9.31.  
roof spaces, 9.19.  
roofing, 9.26.  
sheet steel stud wall framing, 9.24.  
soil gas control, 9.13.  
sound control, 9.11.  
stairs, ramps, handrails and guards, 9.8.  
structural requirements, 9.4.  
stucco, 9.28.  
ventilation, 9.32.  
waterproofing, 9.13.  
windows, doors and skylights, 9.7.  
wood-frame construction, 9.23.  
Humidification, 6.3.2.16., 9.36.3.7.  
HVAC (see Heating, ventilating and air-conditioning (HVAC) systems and equipment)  
Hydrants, 3.2.5.5., 3.2.5.15.  
Hydronic heating  
  design, 9.33.4.1.  
  installation, 9.33.4.2.  
  secondary suites, 9.33.1.1.  
Hydrostatic pressure, 4.2.4.8., 5.7.2., 9.13.3.1., 9.16.3.2.

█

Ice, accumulation, 4.1.6.2., 4.1.6.15., 4.1.7.11., 5.3.1.2., 5.6.2.2.  
Impeded egress zones  
  definition, 1.4.1.2.[A]  
  door release hardware, 3.4.6.16.  
  doors and door hardware, 3.3.1.13.  
  fire alarm systems, 3.2.4.1.  
  fire annunciators, 3.2.4.8.  
  sliding doors, 3.4.6.14.  
  sprinkler system requirements, 3.2.2.19.  
Importance categories for buildings, 4.1.2.1.  
Importance factors  
  earthquake loads, 4.1.8.5.  
  snow loads, 4.1.6.2.  
  wind loads, 4.1.7.3.  
Incinerator rooms, 3.6.2.4., 9.10.10.5.  
Indirect service water heaters (see Service water heaters)  
Indoor design temperature, 5.2.1.2., 5.3.1.2., 5.5.1.2., 9.33.3.1.

Indoor pools  
  heat recovery, 9.36.3.8.  
  temperature controls, 9.36.4.6.  
  water heaters, 9.36.4.2.  
Industrial occupancy (Group F)  
  (see also High-hazard industrial occupancy;  
  Low-hazard industrial occupancy;  
  Medium-hazard industrial occupancy)  
  classification, 9.10.2.  
  definition, 1.4.1.2.[A]  
  door thresholds, rooms with flammable liquids, 3.3.1.13., 3.4.6.1.  
  exposing building face, 9.10.14.5.  
  fire alarm systems, 9.10.18.  
  fire-resistance rating, 9.10.8.  
  fire separations, 9.10.9.11., 9.10.9.12.  
  flame-spread rating, 9.10.17.  
  guards, 3.3.5.10., 9.8.8.5.  
  ramps and stairways, 3.3.1.14., 3.4.6.7., 3.4.6.8.  
  self-service storage buildings, 3.9.1.3.  
  washrooms, 3.7.2.  
Information required for proposed work, 2.2.2.1.[C]  
Institutional occupancy (see Care, treatment or detention occupancy)  
Insulation  
  attic or roof spaces, 9.25.2.4.  
  basements, 9.25.2.2.  
  combustible, in noncombustible construction, 3.1.5.14., 3.1.5.15.  
  concealed spaces, 3.1.11.2.  
  continuity of, 9.36.2.5.  
  crawl spaces, 9.25.2.2., 9.25.2.3.  
  ducts, 3.1.5.18., 6.3.2.5., 9.32.3.11., 9.33.6.4.  
  environmental separation, 5.1.1.1.  
  exposure to exterior space on ground, 5.1.2.1.  
  foamed plastic, 3.1.5.14., 3.1.5.15., 5.3.1.3., 9.10.17.10., 9.25.2.2., 9.33.6.4.  
  foundations, 9.12.2.2., 9.25.2.2., 9.25.2.3.  
  installation, 5.3.1.3., 9.25.2.3., 9.27.3.4.  
  loose-fill, 9.25.2.4.  
  materials, 9.25.2.2.  
  material standards, 5.9.1.1., 9.25.2.2.  
  pipes, 3.1.5.18., 6.5.1.1., 9.33.8.2., 9.33.8.4.  
  plenums, 9.33.6.4.  
  properties, 9.25.5.1.  
  protection of, 9.10.17.10., 9.25.2.3.  
  requirement for, 5.3.1.1., 9.25.2.1.  
  roofs, 9.25.2.2.  
  slabs-on-ground, 9.25.2.3.  
  spray-applied, 5.3.1.3., 9.25.2.5.  
  supported by gypsum board, 9.29.5.4.  
  thermal, 9.25.2.  
  thermal resistance, 5.3.1.  
  walls, 9.25.2.4.  
  wall sheathing, 9.23.17.2., 9.23.17.3., 9.27.3.4.  
  wires and cables, 3.1.5.21.  
Interconnected floor spaces, 1.4.1.2.[A], 3.2.3.2., 3.2.8.2., 3.2.8.8., 9.10.9.5.  
Interconnection of duct systems, 6.3.2.7., 6.3.2.10., 9.33.6.7.

## Interior finishes

- for braced wall panels, 9.23.13.6.
- ceilings, 9.23.9.4., 9.29.
- dampproofing, 9.13.2.5.
- fastening to steel studs, 9.24.1.4.
- flame-spread limits, 9.10.17.
- flame-spread rating, 3.1.13.2.
- floors, 9.30.
- gypsum board, 9.29.5.
- hardboard, 9.29.7.
- in noncombustible construction, 3.1.5.12.
- insulating fibreboard, 9.29.8.
- masonry walls, 9.20.13.9.
- materials, 3.1.13.1.
- OSB, 9.29.9.
- particle board, 9.29.9.
- plastering, 9.29.4.
- plywood, 9.29.6.
- public corridor ceilings, 3.1.13.6.
- on steel studs, 9.24.1.5.
- support, 9.23.10.5., 9.24.3.4.
- tiles, 9.29.10.
- underground walkways, 3.1.13.9.
- waferboard, 9.29.9.
- walls, 9.29.
- waterproof, 9.29.2.

## J

- Janitors' rooms, 3.2.4.10., 3.3.1.21., 9.10.18.4.
- Joints and connections for ducts, 9.33.6.2., 9.33.6.3., 9.33.6.6., 9.33.6.7.
- Joists
  - bearing, 9.23.9.1.
  - cantilevered, 9.23.9.9.
  - ceilings, 9.23.14.1., 9.23.14.7.
  - continuity, 9.23.14.1.
  - dimensions, 9.23.4.1., 9.23.14.7., 9.23.14.10.
  - end bearing length, 9.23.14.3.
  - floors, 9.23.4.1., 9.23.4.2., 9.23.4.4., 9.23.9.
  - framing around openings, 9.23.14.2.
  - header, 9.23.9.5., 9.23.9.7.
  - lumber grade, 9.3.2.1.
  - nailing, 9.23.3.4., 9.23.9.3., 9.23.14.9.
  - preservative treatment, 9.23.2.2., 9.23.2.3.
  - roofs, 9.23.4.2., 9.23.4.5., 9.23.14.1., 9.23.14.7., 9.23.14.9.
  - spans, 9.23.4.1., 9.23.4.2., 9.23.4.4., 9.23.4.5., 9.23.14.7., 9.23.14.10.
  - strapping, bridging and furring, 9.23.9.4.
  - support, 9.23.14.7.
  - supported on beams, 9.23.9.2.
  - supported on masonry or concrete, 9.20.8.2., 9.20.8.3., 9.21.5.3., 9.23.2.2., 9.23.2.3.
  - supporting walls, 9.23.9.8.
  - tail, 9.23.9.7.
  - trimmer, 9.23.9.6.
  - wood, 9.23.4.1., 9.23.4.2., 9.23.4.4., 9.23.4.5.
- Junction boxes, electrical, 3.1.5.2., 9.10.9.6.

## K

### Kitchens

- commercial cooking equipment, 3.3.1.2., 6.3.1.7., 9.10.1.4., 9.10.13.13.
- emergency lighting, 3.2.7.3.
- exhaust ducts, 3.1.8.8., 3.1.8.9., 6.3.2.10., 9.32.3.11.
- exhaust fans, 9.32.3.3., 9.32.3.7.
- exhaust outlets, 6.3.2.10.
- grease duct enclosures, 3.6.3.5.
- loads on floor or roof, 4.1.5.3.

## L

### Laboratories

- enclosure exhaust ventilation, 3.3.1.20., 6.3.4.3.
- live loads on floor or roof, 4.1.5.3.
- ventilated enclosure construction, 6.3.4.4.

### Landings

- barrier-free, 3.8.3.5.
- configurations, 9.8.6.3.
- dimensions, 3.4.3.4., 3.4.6.4., 9.8.6.3.
- at doorways, 3.4.3.3., 3.4.6.3., 9.8.6.2., 9.8.6.3., 9.9.6.1.
- fire escapes, 3.4.7.7.
- guards, 3.4.6.6., 9.8.8.
- height between, 3.4.6.3., 9.8.3.3., 9.8.4.4., 9.8.5.5.
- height over, 9.8.6.4.
- in housing and small buildings, 9.8.6.
- omitted, 3.4.6.3.
- openings in, 3.4.6.4.
- as part of exit, 9.8.1.3.
- on ramps, 9.8.6.
- slip-resistance, 3.4.6.1., 9.8.9.6.
- on stairs, 9.8.6.

### Lateral loads

- anchorage, 9.23.6.1.
- braced wall bands, 9.23.13.4., 9.23.13.5.
- braced wall panels, 9.23.13.5., 9.23.13.6.
- bracing considerations, 9.23.13.7.
- bracing requirements, 9.23.13., 9.23.13.1.
- fasteners for framing, 9.23.3.4.
- fasteners for sheathing and subfloors, 9.23.3.5.
- floor joists supporting walls, 9.23.9.8.
- lumber roof sheathing, 9.23.16.5.
- materials, 9.23.13.6.
- particleboard, OSB or waferboard finishes, 9.29.9.3.
- plywood finish, 9.29.6.3.
- roof sheathing, required, 9.23.16.1.
- spacing of nails in gypsum board, 9.29.5.8.
- spacing of screws in gypsum board, 9.29.5.9.

### Lath, plaster

- gypsum, 9.29.4.1.
- metal, 9.29.4.1.

### Lath, stucco

- attachment to sheathing, 9.27.5.1.
- dimensions, 9.28.4.3.
- fastening, 9.27.5.7., 9.27.7.5., 9.28.4.6.
- installation, 9.28.4.2., 9.28.4.5., 9.28.4.6.
- materials, 9.28.4.1., 9.28.4.3.

- nailing, 9.27.5., 9.28.4.6.
- self-furring, 9.28.4.4.
- standard for, 9.28.4.
- stapling, 9.27.5., 9.28.4.6.
- uses, 9.28.1.2.
- Lattice structures, ice loading, 4.1.6.15.
- Laundry-drying equipment, 9.32.1.3.
- Laundry rooms, 3.2.4.10., 3.3.1.22., 9.10.18.4.
- Lavatories, 3.7.2.3., 3.8.2.8., 3.8.3.15.
- Libraries, 3.3.2.13., 4.1.5.3.
- Licensed beverage establishments
  - access to exit, 3.3.1.17.
  - principal entrances, 3.4.2.6.
- Life safety systems, 3.2.9.1., 9.10.1.2.
- Light diffusers and lenses, 3.1.13.4., 9.10.17.6., 9.10.17.8.
- Lighting
  - basements, 9.34.2.3., 9.34.2.4.
  - elements, 3.1.13.1., 9.10.17.6., 9.10.17.8.
  - emergency, 3.2.7.3., 3.2.7.4., 9.9.12.3., 9.34.2.7., 9.34.3.
  - entrances, 9.34.2.1.
  - exits, 3.2.7.1.
  - fixtures, recessed, 3.2.7.2., 9.34.1.4.
  - garages and carports, 9.34.2.6.
  - levels, 9.9.12.2., 9.9.12.3.
  - levels, minimum, 3.2.7.1.
  - means of egress, 9.9.12.
  - outlets for, 3.2.7.1., 9.34.2.
  - public corridors, 3.2.7.1., 9.9.12.2., 9.9.12.3.
  - public and service areas, 9.34.2.7.
  - stairways, 9.34.2.3.
- Lightning protection systems, 3.6.1.3.
- Limiting distance
  - between construction camp buildings, 9.10.21.5.
  - definition, 1.4.1.2.[A]
  - exposing building face, 3.2.3.5., 3.2.3.6., 3.2.3.7., 9.10.14.5., 9.10.15.5.
  - exterior walls, 9.10.3.3.
  - fire department response time, 3.2.3.1.
  - and firefighting services, 9.10.15.3.
  - fire-resistance rating exception, 3.1.7.2.
  - less than 1.2 m, 3.2.3.5.
  - low-hazard industrial occupancy (Group F, Division 3), 3.2.3.11.
  - maximum concentrated area, 3.2.3.1.
  - spatial separation between buildings, 3.2.3.1., 9.10.14.3., 9.10.15.
  - unprotected openings, 3.2.3.1., 3.2.3.10.
  - wall exposed to another wall, 3.2.3.14.
- Limit states design
  - application, 4.1.3.
  - dead load, 4.1.3.2.
  - definition of terms, 4.1.3.1.
  - effect of factored loads, 4.1.3.2.
  - fatigue check, 4.1.3.3.
  - importance factors, 4.1.6.2., 4.1.8.5.
  - load factors, 4.1.3.2.
  - resistance, 4.1.3.2.
  - serviceability check, 4.1.3.4.
  - strength and stability check, 4.1.3.2.
- Linen chutes, 3.6.3.3., 9.10.1.3.
- Liners, chimney
  - clay, 9.21.3.3.
  - clearances, 9.21.3.8.
  - concrete, 9.21.3.5.
  - definition, 1.4.1.2.[A]
  - extensions, 9.21.3.10.
  - firebrick, 9.21.3.4.
  - installation, 9.21.3.7.
  - joints, 9.21.3.2.
  - materials, 9.21.3.1.
  - metal, 9.21.3.6.
  - mortar, 9.21.3.9.
  - separation, 9.21.4.9.
  - standard for, 9.21.3.
- Liners, fireplace
  - firebrick, 9.22.2.2.
  - standard for, 9.22.2.
  - steel, 9.22.2.3.
  - wall thickness, 9.22.3.
- Linings
  - for ducts and plenums, 3.1.5.18., 6.3.2.5., 9.33.6.4.
  - for radiators and convectors, 6.4.3.1., 9.33.7.1.
- Lintels
  - dimensions, 9.23.12.3.
  - fireplaces, 9.22.1.2.
  - nailing, 9.23.12.3.
  - spans, 9.23.12.3.
  - steel, 3.2.2.3., 9.10.7.1., 9.20.5.2., 9.22.1.2.
  - supporting masonry over openings, 9.20.5.2.
  - wood, 9.23.12.
- Liquids, combustible (see Combustible liquids)
- Liquids, flammable (see Flammable liquids)
- Liquids, hazardous, 6.9.1.2.
- Live loads (see Loads)
- Loadbearing, definition, 1.4.1.2.[A]
- Loads
  - in attics, 9.4.2.4.
  - bearing pressure for soil or rock, 9.4.4.1.
  - climatic, 1.1.3., 5.2.1.1.
  - combinations, 4.1.3.2.
  - concentrated, 4.1.5.9.
  - dead, 1.4.1.2.[A], 4.1.3.2., 4.1.4., 9.4.3.1.
  - deflections under, 4.1.3.5., 9.4.3.
  - design requirement, 4.1.1.3.
  - in dining areas, 4.1.5.3., 4.1.5.6.
  - due to crane, 4.1.3.2., 4.1.5.11.
  - due to earthquakes, 4.1.3.2., 4.1.8.
  - due to ice, 4.1.6.15.
  - due to partitions, 4.1.4.1.
  - due to resonance, 4.1.3.6.
  - due to snow and rain, 4.1.6., 4.1.6.4., 9.4.2.2., 9.4.2.3.
  - due to sway forces, 4.1.5.10.
  - due to use and occupancy, 4.1.5.
  - during construction, 4.1.1.3.
  - eccentric, on foundations, 4.2.4.6.
  - environmental, 5.1.4.1., 5.2.1., 5.2.1.3.
  - on exterior areas, 4.1.5.5.
  - on firewalls, 4.1.5.17.
  - on floors, 4.1.5.3., 9.23.1.1., 9.23.4.1., 9.23.4.2., 9.23.4.4.

## M

on foundations, 4.2.4.1., 9.4.4.6.  
full and partial, 4.1.5.3.  
on grab bars, 3.7.2.8., 9.31.2.3.  
on guards, 3.3.5.4., 4.1.5.14., 9.8.8.2., 9.8.8.4.  
on handrails, 3.4.6.5., 4.1.5.14., 9.8.7.7.  
and helipads, 4.1.5.13.  
hydrostatic, 4.2.4.8., 9.13.3.1., 9.16.3.2.  
impact of machinery and equipment, 4.1.5.11.  
lateral (see Lateral loads)  
limit states, 4.1.3.  
live, 1.4.1.2.[A], 4.1.5.  
with more than one occupancy, 4.1.5.7.  
not specified, 4.1.2.2.  
permanent, 4.1.3.2.  
on ramps, 9.8.9.1.  
on residential balconies, 4.1.5.3., 9.4.2.3.  
on retaining walls, 9.4.4.5., 9.4.4.6.  
specified, 4.1.2., 9.4.2.  
on stairs, 9.8.9.1.  
structural, 4.1., 9.4.  
structural, on environmental separators, 5.1.4.1.,  
5.2.2.  
and structural strength, 5.2.2.  
variation with tributary area, 4.1.5.8.  
on vehicle guardrails, 4.1.5.15.  
vibration, 4.1.3.6.  
on walls acting as guards, 4.1.5.16.  
wind (see Wind load)

Lobbies, 3.4.4.2., 9.9.8.5., 9.10.17.3.  
(see also Vestibules)

Locking devices  
automatic, 3.3.4.5.  
contained use area, 3.3.1.13.  
electromagnetic, 3.3.1.13., 3.4.6.16., 3.4.6.18., 9.9.6.7.  
impeded egress zone, 3.3.1.13.  
principal entrances, 9.9.6.7.

Locks, deadbolt, 9.7.5.2.

Low buildings, wind loads, 4.1.7.5., 4.1.7.6.

Lowest exit level, 3.2.6.2., 3.4.3.2., 3.4.5.2., 9.9.11.4.

Low fire load, 3.2.2.89., 3.2.3.11.

Low-hazard industrial occupancy (Group F, Division  
3)  
building classification, 3.1.2.1.  
definition, 1.4.1.2.[A]  
fire alarm systems, 3.2.4.1., 9.10.18.  
fire protection, 3.2.2.80. - 3.2.2.90., 3.2.3.11.  
fire safety within floor areas, 3.3.1., 3.3.5.  
occupant load, 3.1.17.1.

Lumber  
dimensions, 9.3.2.6.  
fire stops, 3.1.11.7.  
grades, 9.3.2.1., 9.3.2.2., 9.3.2.3.  
for housing and small buildings, 9.3.2.  
moisture content, 9.3.2.5.  
protection from termites and decay, 9.3.2.9.  
sheathing, 9.23.16.5.  
structural uses, 9.3.2.9.  
undersized, 9.3.2.8.

Main entrances (see Principal entrances)

Major occupancy  
and building classification, 3.1.2.1., 9.10.2.  
definition, 1.4.1.2.[A]  
occupancy combination prohibitions, 3.1.3.2.

Major occupancy and fire safety requirements  
building area determination, 3.2.2.5.  
exceptions, 3.2.2.8.  
fire separations, 3.1.3.1.  
multiple occupancies, 3.1.3., 3.2.2.4., 3.2.2.6.,  
9.10.2., 9.10.9.11., 9.10.9.16., 9.10.9.17.  
superimposed occupancies, 3.2.2.7.

Makeup air  
and depressurization protection, 9.32.3.8.  
fans, 9.32.3.10.  
requirements, 6.3.2.8.  
for subfloor depressurization, 9.13.4.3.

Mansard roofs  
fire stopping, 3.1.11.5.  
sheathing, 9.23.17.6.  
venting, 9.19.1.4.

Manual stations, fire alarm systems, 3.2.4.4., 3.2.4.16.

Manufactured buildings, foundations, 9.12.2.2.,  
9.15.1.3.

Marquees, 3.1.5.24., 3.1.16.1., 3.2.2.3.

Masonry  
bonding, 9.20.9., 9.20.11.2.  
chases and recesses, 9.20.7.  
chimneys, 1.4.1.2.[A], 6.3.3.2., 9.21., 9.33.10.3.  
cold weather requirements, 9.20.14.  
columns, 9.17.5.  
corbelling, 9.20.12.  
dampproofing, 9.13.2.3.  
earthquake reinforcement, 9.20.1.2., 9.20.15.  
exposure to weather, 9.20.2.6.  
flashing, 9.20.13., 9.26.4.4., 9.26.4.6.  
flues, 9.21.  
foundations, 4.2.3.3., 4.2.3.4., 9.15.1.1., 9.15.2.,  
9.15.4., 9.15.4.10.  
grout, 9.20.3.2.  
installation, 5.6.1.2., 9.15.2.2., 9.15.2.3., 9.20.  
joints, 9.20.4., 9.20.9.1.  
lateral support, 9.20.10.  
material standards, 5.6.1.2., 5.9.1.1., 9.15.2.2.,  
9.17.5.1.  
mortar, 9.20.3.1., 9.20.3.2.  
parapet walls, 9.20.6.5.  
for pilasters, 9.15.5.3.  
solid, 1.4.1.2.[A]  
structural design basis, 4.3.2.1.  
stucco on, 9.28.1.3.  
supporting beams, 9.15.5.2.  
supporting floor joists, 9.15.5.1.  
support of loads, 9.20.5., 9.20.8.  
as thermal barrier, 3.1.5.14., 3.1.5.15.  
ties, 9.20.9.5.  
tying, 9.20.9., 9.20.11.2.  
units, 1.4.1.2.[A], 9.20.2., 9.20.2.1.  
used brick, 9.20.2.2.

- veneer, 9.20.6.4., 9.20.8.5., 9.20.9.5., 9.20.12.3.
- walls, 9.20.
- weep holes, 5.6.2.1., 9.20.13.5., 9.20.13.6., 9.20.13.8.
- Mastics, 3.1.5.2.
- Materials
  - braced wall panels, 9.23.13.6.
  - characteristics, 1.2.2.1.[A]
  - cladding, hardboard, factory-finished, 9.27.9.1.
  - cladding, lumber, 9.27.6.1.
  - cladding, OSB and waferboard, 9.27.10.1.
  - cladding, plywood, 9.27.8.1.
  - cladding, strip steel, 9.27.11.1.
  - cladding, vinyl, 9.27.12.1.
  - columns, unit masonry, 9.17.5.1.
  - columns, wood, 9.17.4.2.
  - combustible, in noncombustible construction, 9.10.6.
  - concrete, 9.3.1.
  - dampproofing, 9.13.2.2.
  - design requirements, 4.3.
  - drainage tile and pipe, 9.14.3.1.
  - ducts, 6.3.2.3., 9.32.3.11., 9.33.6.2.
  - eave protection, 9.26.5.2.
  - exterior insulation finish systems, 9.27.13.
  - fibreglass, insulating, 9.29.8.1.
  - fire blocks, 9.10.16.3.
  - fire stops, 3.1.9.1., 3.1.11.7.
  - flashing, 9.20.13.1., 9.26.4.2., 9.27.3.7.
  - foundations, 4.2.3.
  - glass, 9.6.1.2.
  - granular, beneath floors, 9.16.2.
  - gypsum products, 9.29.5.2.
  - hardboard, 9.29.7.1.
  - for housing and small buildings, 9.30.
  - lumber and wood products, 9.3.2.
  - metal, 9.3.3.
  - particleboard finish, 9.29.9.1.
  - pipes for heating and cooling systems, 6.7.1.1., 9.33.8.1.
  - review of, 2.2.7.4.[C]
  - roofing, 9.26.2.1.
  - roof sheathing, 9.23.16.2.
  - sealants, 9.27.4.2.
  - shingles and shakes, 9.27.7.1.
  - standards, 1.5.[A], 5.9.1.1.
  - steel studs and runners, 9.24.1.2.
  - storage, 1.2.2.2.[A], 9.10.1.3.
  - subflooring, 9.23.15.2.
  - testing, 4.1.1.5.
  - thermal characteristics, 9.36.2.2.
  - underlay, panel-type, 9.30.2.2.
  - used, 1.2.2.3.[A]
  - waterproofing, 9.13.3.2., 9.29.2.2.
- Materials, appliances, systems and equipment
  - characteristics, 1.2.2.1.[A]
  - storage, 1.2.2.2.[A]
  - used, 1.2.2.3.[A]
- Means of egress
  - (see also Exits)
  - from air-supported structures, 3.1.6.1.
  - from care, treatment or detention occupancy, 3.3.3.3.
  - definition, 1.4.1.2.[A]
  - dimensions, 9.9.3.
  - through doors and windows in dwelling units, 9.7.2.2.
  - from dwelling units, 3.3.4.4., 9.9.9.
  - exterior passageways as, 3.2.2.12.
  - and fire hose cabinets, 3.2.5.11.
  - within floor areas, 3.3.1.3.
  - from housing and small buildings, 9.9.
  - lighting of, 9.9.12.2.
  - obstructions in, 3.3.1.23., 3.4.3.3., 9.9.5., 9.9.5.5., 9.9.11.2.
  - from outdoor places of assembly, 3.3.2.11.
  - from secondary suites, 9.9.9.
  - sliding doors in, 3.3.1.12.
  - from tents, 3.1.6.1.
  - transparent panels or doors in, 3.3.1.19., 9.6.1.4.
  - with two separate exits, 9.9.9.2.
- Measurement, rooms and spaces, 9.5.1.1.
- Mechanical systems and equipment (see Heating, ventilating and air-conditioning (HVAC) systems and equipment)
- Mechanical ventilation (see Ventilation)
- Medical gas piping, 3.7.3.1., 9.31.1.1.
- Medium-hazard industrial occupancy (Group F, Division 2)
  - ammonium nitrate storage, 3.3.6.6.
  - building classification, 3.1.2.1.
  - definition, 1.4.1.2.[A]
  - fire alarm systems, 3.2.4.1., 9.10.18.
  - fire protection, 3.2.2.74. - 3.2.2.79.
  - fire safety within floor areas, 3.3.1., 3.3.5.
  - occupant load, 3.1.17.1.
- Mercantile occupancy (Group E)
  - classification, 3.1.2.1., 9.10.2.
  - definition, 1.4.1.2.[A]
  - exit stairs, 9.9.4.7.
  - exposing building face, 9.10.14.5.
  - fire alarm systems, 3.2.4.1., 9.10.18.
  - fire protection, 3.2.2.64. - 3.2.2.69.
  - fire-resistance rating, 9.10.8.
  - fire safety within floor areas, 3.3.1.
  - flame-spread rating, 9.10.17.
  - occupant load, 3.1.17.1.
  - security, 3.4.6.17.
- Metal
  - cladding, 5.6.1., 5.9.1.1., 9.27.3.6., 9.27.5.6., 9.27.11.
  - for housing and small buildings, 9.3.3.
  - galvanized sheet, 9.3.3.2.
  - roof deck assembly, 3.1.14.2.
  - sheet thickness, 9.3.3.1.
  - siding, 5.6.1., 5.9.1.1., 9.27.3.6., 9.27.5.6., 9.27.11.
- Mezzanines
  - application of requirements to exterior passageways, 3.2.2.12.
  - assembly occupancy (Group A, Division 1), 3.2.2.20.
  - assembly occupancy (Group A, Division 2), 3.2.2.23.

- assembly occupancy (Group A, Division 3), 3.2.2.29.
  - and building height, 3.2.1.1., 9.10.4.1., 9.10.4.2.
  - business and personal services occupancy (Group D), 3.2.2.55.
  - care, treatment or detention occupancy (Group B, Division 1), 3.2.2.36., 3.2.2.37.
  - care, treatment or detention occupancy (Group B, Division 2), 3.2.2.38. - 3.2.2.41.
  - care, treatment or detention occupancy (Group B, Division 3), 3.2.2.42. - 3.2.2.46.
  - ceiling height, 9.5.3.2.
  - definition, 1.4.1.2.[A]
  - fire-resistance rating, 9.10.8.6., 9.10.9.4.
  - fire separations, 3.2.1.6., 3.2.8.1., 9.10.12.1.
  - guards, 3.3.1.18., 9.8.8.1.
  - high-hazard industrial occupancy (Group F, Division 1), 3.2.2.70.
  - loads on floor or roof, 4.1.5.3., 4.1.5.4.
  - low-hazard industrial occupancy (Group F, Division 3), 3.2.2.80.
  - means of egress, 3.4.2.2., 9.9.8.6.
  - medium-hazard industrial occupancy (Group F, Division 2), 3.2.2.74.
  - mercantile occupancy (Group E), 3.2.2.64.
  - occupant load, 3.1.17.1.
  - openings in floor assemblies, 3.2.8.2.
  - residential occupancy (Group C), 3.2.2.47.
  - termination, 9.10.12.1.
  - Micro-organisms, minimizing growth of, 6.3.1.6., 6.3.2.15.
  - Mild climate indicator, 9.25.4.2., 9.25.5.1.
  - Millwork, combustible, 3.1.5.9.
  - Mirrors
    - in exits, 9.9.5.6.
    - in washrooms, 3.8.3.15.
  - Misters, 6.3.2.16.
  - Mobile home parks, sanitary facilities, 3.7.2.4.
  - Moisture
    - diffusion, 5.1.1.1., 5.5.1.2.
    - flooring resistant to, 9.30.1.2.
    - protection against, application of Code, 9.13.1.1.
    - resistant backing for wall tile, 9.29.10.4.
    - transfer, 5.1.1.1., 5.2.1.3., 5.5.1.2.
  - Moisture index, 9.27.2.2.
  - Mortar
    - aggregate for, 5.9.1.1., 9.20.3.1., 9.20.3.2., 9.29.10.2.
    - as base for ceramic wall tile, 9.29.10.2.
    - cold weather requirements, 9.20.14.
    - joints, 9.20.4.
    - material standards, 9.20.3.1.
    - mixes, 9.20.3.2.
    - standard for, 9.20.3.
    - uses, 9.20.3.2.
  - Movement, differential
    - columns, 9.17.2.2.
    - decks and other accessible platforms, 9.12.2.2., 9.23.6.2.
    - elements in environmental separation, 5.1.4.1., 5.2.2.1.
    - metal and vinyl cladding, 9.27.5.6.
  - Moving walks, 3.2.8.2., 3.8.2.3., 3.8.2.4., 9.8.1.4.
  - Multiple occupancies
    - and building classification, 9.10.2.
    - building size and construction requirements, 3.2.2.4.
    - fire separations, 3.1.3.
    - requirements decided by most restricted occupancy, 3.2.2.6.
    - separation of repair garages, 9.10.9.17.
    - separation of residential occupancies, 9.10.9.11.
    - separation of storage garages, 9.10.9.16.
- ## N
- Nailing
    - bracing, 9.23.10.2.
    - built-up beams, 9.23.8.3.
    - cladding, 9.27.5., 9.27.7.3.
    - columns, 9.17.4.2.
    - fibreboard finish, 9.29.8.3.
    - framing, 9.23.3.4.
    - furring, 9.29.3.2.
    - gypsum board, 9.29.5.5., 9.29.5.8.
    - hardboard finish, 9.29.7.3.
    - joists, 9.23.9.2., 9.23.9.3., 9.23.14.9.
    - lintels, 9.23.12., 9.23.12.3.
    - OSB finish, 9.29.9.3.
    - particleboard finish, 9.29.9.3.
    - plywood finish, 9.29.6.3.
    - prevention of splitting, 9.23.3.3.
    - rafters, 9.23.14.4.
    - roofing, 9.26.2.3.
    - runners, 9.24.3.1.
    - shakes, 9.27.7.3.
    - sheathing, 9.23.3.5.
    - shingles, 9.26.7.4., 9.26.7.6., 9.26.8.5., 9.27.7.3.
    - siding, 9.27.5., 9.27.7.3.
    - stucco, 9.28.3.2.
    - subflooring, 9.23.3.5., 9.23.15.6.
    - underlay, 9.30.2.3.
    - waferboard finish, 9.29.9.3.
    - wall plates, 9.23.11.3.
    - wood-frame construction, 9.23.3.
    - wood shingles and shakes, 9.26.9.5., 9.26.10.4.
    - wood strip flooring, 9.30.3.3.
  - Nailing and supporting elements
    - fire blocks required, 3.1.11.3.
    - in noncombustible construction, 3.1.5.8.
  - Nails
    - for cladding, 9.27.5., 9.27.5.4., 9.27.7.3.
    - diameters, 9.23.3.1.
    - dimensions, 9.23.3.5., 9.26.2.3., 9.27.5.4.
    - for fibreboard finish, 9.29.8.3.
    - for gypsum board, 9.29.5.6.
    - length, 9.23.3.2.
    - for OSB finish, 9.29.9.3.
    - for particleboard finish, 9.29.9.3.
    - for roofing, 9.23.3.5., 9.26.2.3.
    - for shingles, 9.26.7.4.



- standard for, 9.23.3.1., 9.26.2.3., 9.29.5.6.
  - for underlay, 9.30.2.3.
  - for waferboard finish, 9.29.9.3.
  - National Building Code
    - acceptable solutions, 1.2.1.1.[A]
    - administration, 2.2.[C]
    - alternative solutions, 1.2.1.1.[A]
    - application, 1.1.1.[A], 1.1.1.[C], 1.3.[A], 2.1.1.[A], 3.1.[A]
    - compliance, 2.2.[A]
    - conflicting requirements, 1.5.1.2.[A]
    - objectives, 2.2.1.1.[A]
    - referenced documents, 1.3.1., 1.5.1.[A]
    - scope, 1.1.1.[C], 1.3.1.[B]
  - Noise, protection from, 5.8., 9.32.3.10.
  - Noncombustible cladding, 3.2.3.7., 3.2.3.9.
  - Noncombustible construction
    - assembly occupancy (Group A, Division 1), 3.2.2.20., 3.2.2.21.
    - assembly occupancy (Group A, Division 2), 3.2.2.23., 3.2.2.24.
    - assembly occupancy (Group A, Division 3), 3.2.2.29.
    - assembly occupancy (Group A, Division 4), 3.2.2.35.
    - business and personal services occupancy (Group D), 3.2.2.55.
    - care, treatment or detention occupancy (Group B, Division 1), 3.2.2.36., 3.2.2.37.
    - care, treatment or detention occupancy (Group B, Division 2), 3.2.2.38. - 3.2.2.41.
    - care, treatment or detention occupancy (Group B, Division 3), 3.2.2.42. - 3.2.2.46.
    - combustible elements, 3.1.5.6., 9.10.6.1.
    - combustible finishes in, 3.1.5.12.
    - combustible flooring in, 3.1.5.10.
    - combustible insulation in, 3.1.5.14.
    - combustible stairs in, 3.1.5.11.
    - decorative wood cladding, 3.1.5.24.
    - definition, 1.4.1.2.[A]
    - ducts (combustible) in, 3.1.5.18.
    - exposing building face, 3.2.3.7.
    - exterior walls, 3.1.5.5., 3.1.5.6.
    - factory-assembled panels, 3.1.5.7.
    - fire stops, 3.1.11.3.
    - firewalls, 3.1.10.1., 3.1.10.2.
    - flame-spread rating, 3.1.13.8.
    - glazing and skylights, 3.1.5.4.
    - high-hazard industrial occupancy (Group F, Division 1), 3.2.2.70., 3.2.2.71.
    - low-hazard industrial occupancy (Group F, Division 3), 3.2.2.80., 3.2.2.87.
    - materials permitted in, 3.1.5.1.
    - medium-hazard industrial occupancy (Group F, Division 2), 3.2.2.74., 3.2.2.75.
    - mercantile occupancy (Group E), 3.2.2.64.
    - metal roof decks, 3.1.14.2.
    - minor combustible components, 3.1.5.2.
    - nailing elements, 3.1.5.8.
    - non-metallic raceways in, 3.1.5.23.
    - partitions in, 3.1.5.16.
    - plumbing fixtures, 3.1.5.20.
    - residential occupancy (Group C), 3.2.2.47.
    - roofing materials, 3.1.5.3.
    - support of, 9.10.8.4.
    - vehicular passageways, 3.2.3.18.
    - walkways, 3.2.3.19., 3.2.3.20.
    - wires and cables, 3.1.5.21., 3.1.5.22.
  - Noncombustible materials
    - permitted in noncombustible construction, 3.1.5.1.
    - return air ducts, 3.6.5.8.
  - Notching of framing members, 9.23.5.2.
  - Nursing homes, 3.1.8.13., 3.3.3.5., 3.4.1.6.
- O**
- Objectives of the Code
    - application, 2.1.1.2.[A], 3.2.[A]
    - definition, 2.2.1.1.[A]
  - Obstructions
    - in corridors, 3.3.1.9., 9.9.5.2., 9.9.5.3., 9.9.6.1.
    - in doorways, 9.9.6.1., 9.9.6.3.
    - in exits, 3.4.3.3., 9.9.5., 9.9.5.5., 9.9.6.1., 9.9.6.2.
    - in means of egress, 3.3.1.23., 9.9.5., 9.9.5.5.
  - Occupancy
    - and building classification, 3.1.2.1., 9.10.2.
    - and building size determination, 1.3.3.4.[A]
    - combination prohibitions, 3.1.3.2., 9.10.9.12.
    - definition, 1.4.1.2.[A]
    - and live loads, 4.1.5.3.
    - multiple (see Multiple occupancies)
  - Occupant load
    - and access to exits, 9.9.7.1.
    - definition, 1.4.1.2.[A]
    - and exit stairway, 3.4.3.1.
    - and fire alarm systems, 3.2.4.1.
    - fire alarm systems, 3.2.4.22.
    - fire safety requirements, 3.1.17.1.
    - and means of egress, 9.9.1.3.
    - and seating, 3.3.2.2.
  - Odour removal equipment, 6.8.1.3., 9.33.6.14.
  - Office areas, 4.1.5.3.
  - Oil-burning equipment, 6.2.1.5., 9.33.5.2.
  - Open-air storage garages, 9.10.18.8.
  - Open-air storey
    - access route, 3.2.5.4.
    - definition, 1.4.1.2.[A]
    - exposing building face, 9.10.14.4.
    - fire containment exception, 3.2.1.5., 3.2.2.80.
    - low-hazard industrial occupancy (Group F, Division 3), 3.2.2.90.
    - storage garages, 6.3.1.4.
    - unprotected openings, 3.2.3.10.
  - Openings
    - (see also Unprotected openings)
    - through barricades, 8.2.1.3.
    - in barrier-free path of travel, 3.8.3.2.
    - care, treatment or detention occupancy, 3.3.3.2.
    - for ducts, 6.3.2.9., 9.10.5.1., 9.33.6.10.
    - for escalators, 3.2.8.2.

in exposing building face, 9.10.14., 9.10.15.  
 in exterior walls, 3.2.3.13., 3.2.3.17., 9.10.12.3.  
 for fire dampers, 9.24.3.7.  
 fire protection, 9.10.1.3.  
 in fire separations, 3.1.8.1., 3.1.8.6., 3.2.3.13., 3.3.3.2.,  
 3.4.4.4., 9.10.5., 9.10.9.3., 9.10.13., 9.10.13.8.  
 through floor assemblies, interconnected floor  
 spaces, 3.2.8.  
 in garage floors, 3.3.5.4.  
 in guards, 9.8.8.5.  
 guards for, 3.3.1.18., 3.4.6.6.  
 in membrane ceilings, 3.1.9.6., 9.10.5.  
 for moving walks, 3.2.8.2.  
 for natural ventilation, 9.32.2.2.  
 near exterior exits, 9.9.4.4. - 9.9.4.6.  
 onto landings, 3.4.6.4.  
 in repair garages, 3.3.3.2.  
 for stairways, 3.2.8.2.  
 support of masonry above, 9.20.5.2.  
 in walls above adjoining roof, 9.10.12.2.  
 in walls exposed to adjoining roof, 3.2.3.15.  
 Operating rooms, 3.3.3.6., 4.1.5.3.  
 Oriented strand board (see OSB)  
 Orphanages, 3.2.4.3.  
 OSB  
 as cladding, 5.9.1.1., 9.27.2.4., 9.27.3.6., 9.27.5.,  
 9.27.10.  
 fire blocks, 9.10.16.3.  
 fire protection of soffits, 9.10.12.4.  
 fire stopping, 3.1.11.7.  
 as interior finish, 9.29.9.  
 material, 9.3.2.4.  
 material standard, 5.9.1.1., 9.23.15.2., 9.23.16.2.,  
 9.23.17.2., 9.27.10.1., 9.29.9.1., 9.30.2.2.  
 as roof sheathing, 9.3.2.4., 9.23.3.5., 9.23.16.2.  
 as siding, 9.27.2.4., 9.27.3.6., 9.27.5., 9.27.10.  
 as subflooring, 9.3.2.4., 9.23.15.2., 9.23.15.5.  
 thickness, 9.3.2.7.  
 as underlay, 9.30.2.  
 as wall sheathing, 9.3.2.4., 9.23.3.5., 9.23.10.2.,  
 9.23.13., 9.23.17.2., 9.23.17.5.  
 Outdoor places of assembly, 3.3.2.11.  
 Outdoor process equipment, 3.2.3.21.  
 Outdoors  
 air quality, 6.2.1.2., 6.3.2.14.  
 air supply rates, 6.3.1.1., 6.3.1.4.  
 design temperatures, 1.1.3.1., 5.2.1.1., 5.3.1.2.,  
 5.5.1.2., 6.2.1.2., 9.33.3.2., 9.33.5.1.  
 Outlet boxes, electrical  
 combustible, in noncombustible construction,  
 3.1.5.2.  
 penetrating fire separations, 3.1.9.2., 3.1.9.3.,  
 3.1.9.4., 9.10.5.1., 9.10.9.6.  
 Ovens, fire protection, 9.10.22.  
 Owner, definition, 1.4.1.2.[A]  
 Oxidizing gases (see Combustible gases)

## P

Paint  
 in noncombustible construction, 3.1.5.2.  
 on steel columns, 9.17.3.3., 9.23.8.2.  
 Parapets  
 design, 4.1.8.18., 5.6.2.2., 9.20.6.5.  
 firewalls as, 3.1.10.4.  
 in noncombustible construction, 3.1.5.3.  
 Parging  
 of above-grade masonry, 9.20.13.9.  
 for dampproofing, 9.13.2.3., 9.13.2.4.  
 of foundation walls, 9.15.6.  
 for protection of insulation, 9.25.2.3.  
 for waterproofing, 9.13.3.3.  
 Parking areas  
 access, 3.8.2.5.  
 barrier-free path of travel, 3.8.2.5.  
 ventilation, 6.3.1.4.  
 Parking decks on roofs, 4.1.5.5.  
 Parking garages (see Storage garages)  
 Parking structures, structural design basis, 4.4.2.1.  
 Particleboard  
 as interior finish, 9.29.9.  
 material standard, 9.23.15.2., 9.29.9.1., 9.30.2.2.  
 subflooring, 9.23.15.2.  
 thickness, 9.3.2.7.  
 underlay, 9.30.2.2.  
 Partitions  
 dead loads, 4.1.4.1.  
 definition, 1.4.1.2.[A]  
 exceptions for mezzanines, 3.2.8.2.  
 in lieu of sliding doors, 3.3.1.12.  
 in noncombustible construction, 3.1.5.16.  
 sliding glass, 3.3.1.19.  
 Party walls  
 airtightness, 9.36.2.10.  
 continuity of insulation, 9.36.2.5.  
 definition, 1.4.1.2.[A]  
 fire separations, 9.10.9.  
 as firewalls, 3.2.3.4., 9.10.11.1.  
 not as firewalls, 9.10.11.2.  
 Passageways  
 as exits, 3.4.1.4.  
 as means of egress, 9.9.2.1.  
 vehicular, 3.2.3.18.  
 Passageways, exterior  
 as access to exit, 9.9.9.3.  
 exemptions, 3.4.4.3.  
 as exits, 3.3.1.15., 3.4.1.5.  
 fire-resistance rating, 9.10.8.8.  
 fire separations, 9.9.4.2.  
 flame-spread rating, 9.10.17.4.  
 interior finishes, 3.1.13.10.  
 as means of egress, 3.2.2.12.  
 Passenger pickup areas, barrier-free, 3.8.3.1.  
 Path of travel, barrier-free  
 access to storeys served by escalators and moving  
 walks, 3.8.2.3.  
 apartment buildings, 9.5.2.3.  
 application of Code, 3.8.2.1.

- doors and doorways, 3.8.3.6.
- drinking fountains, 3.8.3.10.
- elevators, 3.3.1.7., 3.8.2.3., 3.8.3.2., 3.8.3.7.
- floor areas, 3.3.1.7., 9.5.2.2.
- parking areas, 3.8.2.5.
- signs, 3.8.2.4.
- universal washrooms, 3.8.3.12.
- walkways, 3.8.3.3.
- wheelchair spaces, 3.8.2.3., 3.8.3.21.
- width, 3.8.3.2.
- Patients' bedrooms, 3.3.3.5., 3.4.1.6., 4.1.5.3.
- Pedestrian traffic, construction sites, 8.2.3.1., 8.2.3.2.
- Penetrations in fire assemblies, 3.1.9.1.
- Penthouses, 3.6.1.1., 4.1.8.1.
- Perched groundwater, 1.4.1.2.[A], 4.2.5.5.
- Permafrost, 4.2.4.10., 9.15.1.2.
- Piers
  - anchoring to, 9.20.11.6.
  - dimensions, 9.35.3.4.
- Pier-type foundations, 9.15.2.3.
- Pilasters, 9.15.5.3., 9.20.8.4.
- Pile foundations, 1.4.1.2.[A], 4.1.8.16., 4.2.3.8.
- Pipes
  - clearances, 6.7.1.2., 9.33.8.3.
  - combustible (see Combustible piping)
  - corrosion protection, 9.31.2.2.
  - coverings, 3.6.5.5.
  - drainage, 9.14.3.
  - expansion and contraction, 6.7.1.1., 9.33.8.1.
  - for heating and cooling systems, 9.33.8.
  - insulation, 3.6.5.5., 6.5.1.1., 9.33.8.2., 9.33.8.4.
  - materials, 6.7.1.1., 9.14.3.1.
  - for medical gas, 3.7.3.1.
  - metal, 9.14.3., 9.31.2.2.
  - in noncombustible construction, 3.1.5.18., 3.1.5.19.
  - penetrating fire separations, 3.1.9.2., 3.1.9.5., 9.10.9.6., 9.10.9.7.
  - plumbing, 9.31.2.2.
  - polypropylene, 3.1.5.19.
  - for service water heating systems, 9.36.4.4.
  - in shafts, 6.7.1.5.
  - sleeves for, 6.7.1.4., 9.33.8.4.
  - standards for drainage, 9.14.3.1.
  - support, 6.7.1.1., 9.33.8.1.
- Plans, specifications and calculations
  - administration, 2.2.[C]
  - energy performance compliance, 2.2.8.[C]
  - environmental separation, 2.2.5.2.[C]
  - fire protection components, 2.2.3.[C]
  - foundations, 2.2.4.[C], 2.2.4.6.[C], 2.2.4.7.[C]
  - general information, 2.2.2.1.[C]
  - HVAC systems, 2.2.6.2.[C], 6.1.3.1.
  - site, 2.2.2.2.[C]
  - sprinkler systems, 2.2.3.2.[C]
  - structural, 2.2.4.[C], 4.1.1.4.
- Plastering, 9.29.4.
- Plaster, material standard, 9.29.4.1.
- Plates
  - fastening of, 9.23.3.4.
  - sill, 9.23.7.
  - wall, 9.23.11.
- Platforms, serving as roofs, 9.26.1.1.
- Plenums
  - in air duct systems, 3.6.5.1.
  - ceiling assemblies used as, 3.1.9.7.
  - ceilings used as, 3.6.4.3.
  - clearances, 3.6.5.6., 6.3.2.6., 9.33.6.8.
  - combustible, 9.33.6.2.
  - in combustible construction, 3.1.4.3.
  - connectors, 9.33.6.2.
  - construction, 6.3.2.3., 9.33.6.6.
  - coverings, 3.6.5.4., 9.33.6.4.
  - crawl spaces used as, 9.18.7.1.
  - definition, 1.4.1.2.[A]
  - fittings, 6.3.2.3., 9.33.6.2.
  - furnace, 9.33.6.6., 9.33.6.7., 9.33.6.8.
  - insulation, 9.33.6.4.
  - linings, 3.6.5.4., 6.3.2.5., 9.33.6.4.
  - materials, 6.3.2.3., 9.33.6.2., 9.33.6.3.
  - in noncombustible construction, 3.1.5.18.
  - return air, 3.6.4.3., 9.32.3.4.
- Plumbing
  - barrier-free design, 3.8.2.8.
  - combustible piping, 9.10.9.7.
  - in dwelling units, 3.7.2., 9.31.
  - facilities required, 3.7.2., 3.8.2.8., 9.31.4.
  - fixtures, 3.1.5.20., 3.7.2., 9.31.4.
- Plumbing services, 7
- Plumbing systems
  - definition, 1.4.1.2.[A]
  - design and installation, 7.1.2.1.
  - in dwelling units, 7.1.3.2.
  - facilities required, 7.1.3.
- Plywood
  - as cladding, 5.9.1.1., 9.27.2.4., 9.27.3.6., 9.27.5., 9.27.8.
  - fastening, 9.29.6.3.
  - fire blocks, 9.10.16.3.
  - fire protection of soffits, 9.10.12.4.
  - fire stops, 3.1.11.7.
  - grooved, 9.29.6.2.
  - as interior finish, 9.29.6.
  - lapped strips, 9.27.8.5.
  - material, 9.3.2.4.
  - material standards, 5.9.1.1., 9.23.15.2., 9.23.16.2., 9.23.17.2., 9.27.8.1., 9.30.2.2.
  - as roof sheathing, 9.3.2.4., 9.23.3.5., 9.23.16.2., 9.23.16.6., 9.23.16.7.
  - as siding, 5.9.1.1., 9.27.8.
  - as subflooring, 9.23.3.5., 9.23.15.
  - thickness, 9.3.2.7., 9.29.6.1.
  - as underlay, 9.30.2.
  - as wall sheathing, 9.23.3.5., 9.23.10.2., 9.23.13., 9.23.17.2., 9.23.17.5.
- Police stations, 3.1.2.4.
- Pool heaters, 9.36.4.2.
- Portable fire extinguishers, 3.2.5.16., 9.10.20.4., 9.10.21.8.
- Post-disaster buildings
  - definition, 1.4.1.2.[A]
  - earthquake load and effects, 4.1.8.1., 4.1.8.5., 4.1.8.10., 4.1.8.13., 4.1.8.14.

- loads and effects, 4.1.2.1.
  - snow loads, 4.1.6.2.
  - structural loads, 5.2.2.1.
  - wind loads, 4.1.7.3.
  - Potable water systems, 9.31.3.
  - Power-operated doors, 3.8.2.7., 3.8.3.6.
  - Precipitation
    - ingress, 5.6.1.1., 5.6.2.1., 9.27.2.
    - protection from, 5.6.1.1., 5.6.2.1., 9.20.13., 9.26.
  - Pressure piping, 6.2.1.5., 9.33.5.2.
  - Pressure vessels, 6.2.1.5., 9.33.5.2.
  - Principal entrances
    - access routes, 3.2.5.4., 3.2.5.5.
    - door requirements, 9.7.2.1.
    - as exits, 3.3.1.17., 3.4.2.6.
    - latching, locking and opening mechanisms, 9.9.6.7.
    - manual fire alarm stations, 3.2.4.16.
    - as means of egress, 9.9.2.4.
  - Private sewage disposal systems (see Sewage disposal systems, private)
  - Process plants
    - basements and pits, 3.3.6.9.
    - definition, 1.4.1.2.[A]
    - volatile liquids, 3.3.6.9.
  - Protected floor space, 1.4.1.2.[A], 3.2.8.5., 3.4.3.2.
  - Protection from freezing (see also Frost action)
    - concrete, 9.3.1.9.
    - concrete stairs, 9.8.10.3.
    - excavations, 9.12.1.3.
    - fire hose stations, 9.10.21.9.
    - fire protection systems, 3.2.5.17., 9.10.20.5.
    - foundations, 9.12.1.3.
    - gypsum board, 9.29.5.10.
    - HVAC systems and equipment, 6.2.1.6., 9.33.4., 9.33.4.5.
    - masonry, 9.20.14.1.
    - stucco, 9.28.6.1.
  - Protection from high temperature piping, 6.7.1.4., 9.33.8.4.
  - Public areas (see also Corridors)
    - glass doors in, 3.3.1.19.
    - glass used in, 3.3.1.14., 9.6.1.4.
    - transparent panels used in, 3.3.1.19., 9.6.1.4., 9.7.5.
    - windows in, 3.3.1.19., 9.7.5.
  - Public corridors (see also Corridors)
    - access to exit, 9.9.9.1., 9.9.9.3.
    - containing occupancy, 9.10.17.7.
    - definition, 1.4.1.2.[A]
    - doors and door hardware, 3.3.1.13.
    - doors opening onto, 9.10.13.12.
    - emergency lighting, 3.2.7.3., 9.9.12.3.
    - exit signs, 3.4.5.2.
    - fire separations, 3.3.1.4.
    - flame-spread rating, 3.1.13.6., 9.10.17.2., 9.10.17.5.
    - lighting, 3.2.7.1., 9.9.12.2.
    - serving sprinklered buildings, 3.3.1.1.
    - smoke control measures, 3.2.6.2.
    - travel distance to exit, 3.4.2.5.
    - width, 3.3.1.9.
  - Public thoroughfares, 3.2.3.9., 3.2.5.6., 9.10.20.3.
  - Public ways
    - combustible projections near, 3.2.3.6.
    - at construction sites, 8.2.1.1., 8.2.3.2., 8.2.3.5., 8.2.4.1.
    - definition, 1.4.1.2.[A]
  - Pyritic soil and rock
    - drainage, 9.14.2.1., 9.14.4.1.
    - beneath floors-on-ground, 9.16.2.2.
    - and footings, 9.15.3.2.
    - foundations on, 9.4.4.4.
    - not in backfill, 9.12.3.3.
- ## R
- Raceways
    - collapse of, in firewalls, 3.1.10.1.
    - in combustible construction, 3.1.4.4.
    - in exit areas, 3.4.4.4.
    - and fire alarm systems, 3.2.4.2.
    - in noncombustible construction, 3.1.5.21., 3.1.5.23.
    - penetrating fire separations, 3.1.9.2., 9.10.9.6.
    - in plenums, 3.6.4.3.
  - Radiation from interior fires, control, 3.2.3.1., 9.10.14., 9.10.15.
  - Radiators, 6.7.1.3., 9.33.7.1.
  - Radon gas infiltration (see also Soil gas control)
    - air barriers, 9.25.3.
    - depressurization system, 9.32.3.8.
    - and HVAC design, 6.2.1.1.
    - required resistance to, 5.4.1.1.
    - rough-in for subfloor depressurization system, 9.13.4.3.
  - Rafters
    - anchoring to masonry, 9.20.11.4.
    - continuity, 9.23.14.1.
    - deflection, 9.4.3.1.
    - dimensions, 9.23.4.2., 9.23.14.6., 9.23.14.7.
    - fastening, 9.23.3.4., 9.23.14.4.
    - framing around openings, 9.23.14.2.
    - hip and valley, 9.23.14.6.
    - installation, 9.23.14.4.
    - lumber grade, 9.3.2.1.
    - nailing, 9.23.3.4., 9.23.14.4.
    - ridge support, 9.23.14.8.
    - shaping, 9.23.14.5.
    - spans, 9.23.4.2., 9.23.4.5., 9.23.14.7.
    - support, 9.23.14.3., 9.23.14.7.
    - in wood-frame construction, 9.23.14.
  - Rain loads, 4.1.6.4., 4.1.6.12., 9.4.2.2. (see also Moisture index)
  - Rain penetration control, 5.6., 9.20.13., 9.26., 9.27.4.
  - Ramps
    - barrier-free, 3.8.2.2., 3.8.3.2., 3.8.3.5., 9.8.5.1.
    - barrier-free floor areas, 3.3.1.7.
    - basement, 3.4.5.2.

- at doors, 9.8.6.2., 9.9.4.4.
- for dwelling units, 9.8.1.
- as exits, 3.4.1.4., 9.8.1.3., 9.9.2.1.
- exit signs, 9.9.11.4.
- finishes, 9.8.9.6.
- in garages, 9.8.8.4.
- guards, 3.4.6.6., 3.8.3.5., 9.8.8.
- handrails, 3.4.6.5., 3.8.3.5., 9.8.7., 9.8.7.1.
- height, 9.8.5.5.
- height over, 9.8.5.3.
- for housing and small buildings, 9.8.5.
- landings on, 3.4.6.3., 9.8.6.
- loads, 9.8.9.1.
- rise, 9.8.5.5.
- safety requirements, 3.3.1.14.
- for secondary suites, 9.8.1.
- slip-resistance, 3.4.6.1., 9.8.9.6.
- slope, 3.4.6.7., 3.8.3.5., 9.8.5.4.
- width, 3.4.3.2., 9.8.5.2.
- Ranges (see Stoves)
- Receptacles, electrical, 9.34.1.1., 9.34.2.2.
- Recessed lighting fixtures, 3.2.7.2., 9.34.1.4.
- Recesses, 9.20.7.
- Referenced documents, 1.3.1., 1.5.1.[A]
- Reference house
  - definition, 9.36.5.2.
  - modeling of energy performance, 9.36.5.13. - 9.36.5.16.
- Refrigerating systems and equipment
  - in housing and small buildings, 9.33.9.
  - installation, 6.2.1.5., 6.6.1.1., 9.33.5.2., 9.33.9.1.
- Refuse
  - bins, 3.6.3.3.
  - chutes, 3.6.3.3., 5.8.1.1., 9.10.1.3.
  - combustible, 9.10.10.6.
  - rooms, 3.6.2.5., 3.6.3.3.
- Registers and outlets
  - (see also Air outlets; Diffusers)
  - exhaust, 6.3.2.10., 9.32.3.13.
  - heating, 9.33.6.10., 9.33.6.11.
  - over pipeless furnaces, 9.33.6.8.
  - ventilation, 9.32.3.5., 9.32.3.6.
- Reinforced concrete, 4.3.3.1., 9.3.1.1.
- Reinforcing
  - concrete block foundations, 9.20.15.2.
  - earthquakes, 9.20.1.2., 9.20.15.
  - glass block, 9.20.9.6.
  - insulating concrete form walls, 9.3.1.1., 9.15.4.5., 9.20.17.
  - masonry, 9.20.15.
  - stucco, 9.28.1.2., 9.28.4.5.
- Repair garages
  - definition, 1.4.1.2.[A]
  - fire separation requirements, 9.10.9.17.
  - in industrial occupancies, 3.3.5.4.
  - separation from care, treatment or detention occupancies, 3.3.3.2.
  - solid-fuel burning appliances prohibited in, 3.6.2.1.
- Residential fire warning systems, 3.2.4.21., 9.10.19.8.
- Residential occupancy (Group C)
  - (see also Dwelling units; Secondary suites)
  - below ground level, 3.2.2.15.
  - classification, 3.1.2.1., 9.10.2.
  - convalescent and children's homes as, 3.1.2.5.
  - definition, 1.4.1.2.[A]
  - door hold-open devices, 3.1.8.14.
  - emergency power for fire alarm systems, 3.2.7.8.
  - emergency power for lighting, 3.2.7.4.
  - fire access route design, 3.2.5.6.
  - fire alarm systems, 3.2.4.1., 3.2.4.11., 3.2.4.18., 9.10.18.
  - fire protection, 3.2.2.47. - 3.2.2.54.
  - fire-resistance rating, 9.10.8.
  - fire safety within floor areas, 3.3.1., 3.3.4.1.
  - fire separations, 9.10.9.11., 9.10.9.12., 9.10.9.14.
  - firewalls, 9.10.11.2.
  - flame-spread rating, 3.1.13.3., 9.10.17.
  - lighting requirements, 3.2.7.1.
  - location of smoke/fire dampers, 3.1.8.7.
  - occupant load, 3.1.17.1.
  - ramp slope maximum, 3.4.6.7.
  - smoke alarms, 3.2.4.20., 9.10.19.
  - smoke control measures, 3.2.6.2.
  - sprinkler piping, 3.2.5.13.
  - sprinkler systems, 3.2.5.12.
  - storage lockers, 3.1.5.17.
- Resilient flooring, 9.30.2.1., 9.30.5.
- Resistance to deterioration, 5.1.4.2., 9.20.16.1.
  - (see also Corrosion protection; Corrosion resistance; Decay, protection against)
- Resistance to forced entry
  - doors, 9.7.5.2.
  - windows, 9.7.5.3.
- Resistant design, earthquake load, 4.1.3.2.
- Restaurants, 3.2.4.1., 3.3.2.15., 6.3.1.7.
- Return air inlets, 9.33.6.12.
- Return air systems, 3.6.5.8., 6.3.2.11., 9.33.6.13.
  - (see also Air intakes; Ducts)
- Return ducts, 1.4.1.2.[A], 6.3.2.11., 9.33.6.13.
- Review of work, 2.2.7.[C]
- Revolving doors, 3.4.6.15., 9.9.6.4.
- Rim joists
  - airtightness, 9.36.2.10.
  - definition, 1.4.1.2.[A]
  - effective thermal resistance, 9.36.2.6.
  - and exterior wall framing, 9.23.3.4.
- Risers
  - aisle steps, 3.3.2.5.
  - bleacher steps, 3.3.2.12.
  - curved flights, 3.3.1.16.
  - dimensions, 3.4.6.8., 9.8.4.1.
  - minimum number, 3.4.6.2., 9.8.3.2.
  - restaurant stairs, 3.3.2.15.
  - uniformity and tolerances, 3.4.6.8., 9.8.4.4.
- Rock
  - bearing pressure, 9.4.4.1., 9.4.4.2.
  - definition, 1.4.1.2.[A]
  - foundations on, 9.12.2.2.
- Rock, pyritic
  - drainage, 9.14.2.1., 9.14.4.1.
  - beneath floors-on-ground, 9.16.2.2.
  - and footings, 9.15.3.2.

- foundations on, 9.4.4.4.
- not in backfill, 9.12.3.3.
- Roof aggregate, 9.26.11.1., 9.26.11.4.
- Roof arches (see Roof and ceiling framing)
- Roof assemblies
  - effective thermal resistance, 9.36.2.6.
  - fire-resistance rating, 3.1.7.5., 3.2.2.17., 3.2.2.25., 3.2.2.35., 3.2.2.49., 3.2.2.52., 3.2.2.56., 3.2.2.60., 3.2.2.66., 3.2.2.76., 3.2.2.81., 3.2.2.83.
  - non-contiguous, 3.1.15.2., 3.2.2.50., 3.2.2.58.
- Roof and ceiling framing
  - bearing on cavity walls, 9.20.8.2.
  - fire-resistance rating, 3.1.7.3.
  - in heavy timber construction, 3.1.4.7.
  - loads on, 9.4.2.2., 9.4.2.4.
  - in noncombustible construction, 3.1.5.3.
  - sheathing, 9.3.2.4., 9.23.16.
  - trusses, 9.4.2.2., 9.23.5.5., 9.23.14.11.
  - in wood-frame construction, 9.23.14.
- Roof coverings, 3.1.15.1., 3.1.15.2., 9.26. (see also Roofing)
- Roofing
  - (see also Roof covering)
  - asphalt shingles, 5.6.1.2., 5.9.1.1., 9.26.1.3., 9.26.2.1., 9.26.7., 9.26.8.
  - bituminous, 9.26.2.1.
  - built-up, 5.9.1.1., 9.26.11.
  - built-up materials, 9.26.2.1.
  - cedar shingles and shakes, 9.26.2.1., 9.26.3.1., 9.26.10.
  - clay tile, 9.23.4.5.
  - concrete tile, 5.9.1.1., 9.23.4.5., 9.26.2.1., 9.26.17.
  - definition, 9.26.1.1.
  - elastomeric sheets, 5.9.1.1., 9.26.2.1.
  - fasteners, 9.26.2.3., 9.26.2.4.
  - flashing, 9.26.4.
  - glass-reinforced polyester, 9.26.14.
  - installation alternatives, 9.26.1.3.
  - installation of materials, 9.26.2.2.
  - installation standards, 5.6.1.2.
  - material standards, 9.26.2.1.
  - metal, 9.26.13.
  - nails, 9.26.2.3.
  - over wood-based sheathing, 9.26.11.8.
  - polyvinyl chloride sheets, 5.6.1.2., 5.9.1.1., 9.26.2.1., 9.26.16.
  - prefabricated bituminous membranes, 9.26.2.1.
  - prefabricated modified bituminous membranes, 5.9.1.1.
  - requirement for, 5.6.1.1., 9.26.1.2.
  - rubberized asphalt, 5.6.1.2., 9.26.2.1., 9.26.15.
  - selvage, 9.26.12.
  - slope of, 9.26.3.
  - standards for, 5.9.1.1.
  - staples, 9.26.2.4.
  - vegetative, 5.6.1.2.
  - wood shakes, 9.26.10.
  - wood shingles, 9.26.9.
- Roofs
  - access, 3.2.5.3.
  - acting as diaphragms, 4.1.8.15., 4.1.8.18.
  - anchorage of, 9.20.11.1., 9.20.11.4., 9.20.17.6.
  - appliances mounted on, 3.6.1.5., 6.4.1.2., 9.10.1.3.
  - arched or curved, snow loads, 4.1.6.10.
  - beams, 9.23.4.2., 9.23.4.5.
  - considered as walls, 3.2.1.3., 9.10.1.1.
  - definition, 9.26.1.1.
  - deflection, 9.4.3.1.
  - drains, 5.6.2.2., 9.26.18.2.
  - egress from, 3.3.1.3., 9.9.7.1.
  - fire blocks, 9.10.16.1.
  - fire rating, 9.10.3.3.
  - fire-resistance rating, 9.10.8.1., 9.10.8.2., 9.10.8.7.
  - fire-retardant-treated wood, 3.1.14.1.
  - fire separations, 3.2.2.13.
  - firewall termination, 3.1.10.3.
  - framing, 9.23.4., 9.23.14.
  - framing around openings, 9.23.14.2.
  - gable, snow loads, 4.1.6.9.
  - guards, 3.3.1.18.
  - heavy timber construction, 3.1.4.7., 3.2.2.16.
  - helipad loads, 4.1.5.13.
  - insulation, 9.25.2.2.
  - joists, 9.23.4.2., 9.23.4.5., 9.23.14.1., 9.23.14.7., 9.23.14.9.
  - loads due to use, 4.1.5., 9.4.2.4.
  - metal decking, 3.1.14.2.
  - multi-level, 4.1.6.5.
  - in noncombustible construction, 3.1.5.3.
  - parapets, 3.1.5.3., 3.1.10.4., 4.1.8.18., 5.6.2.2., 9.20.6.5.
  - rain loads, 4.1.6.4., 5.6.2.2., 9.4.2.2.
  - ridge support, 9.23.14.8.
  - sheathing installation, 9.23.16.3., 9.23.16.4., 9.23.16.6.
  - sheathing materials, 9.3.2.1., 9.3.2.4., 9.23.16.2., 9.23.16.5., 9.23.16.7.
  - sloped, 4.1.6.12., 9.10.1.1.
  - snow loads, 4.1.6.2., 4.1.6.3., 4.1.6.5., 4.1.6.7., 4.1.6.8., 4.1.6.11., 4.1.6.12., 9.4.2.2.
  - sprinklers in lieu of structural fire resistance, 9.10.8.2.
  - supporting an occupancy, 3.2.2.13., 9.10.8.7.
  - trusses, 9.4.2.2., 9.23.5.5., 9.23.14.11.
  - of underground structures, 9.13.1.1., 9.13.3., 9.25.3.5.
  - venting, 9.19.1.
  - wind loads, 4.1.7.6., 5.2.2.2.
- Roof spaces (see Attics or roof spaces)
- Roof-top
  - air-handling equipment, 6.3.2.17.
  - appliances, 3.6.1.5., 3.6.2.1., 6.4.1.2., 9.10.1.3.
  - enclosures, 3.2.1.1., 3.2.2.14., 9.10.4.4.
- Rooms, height, 3.7.1.1., 9.5.3.
- Runners, sheet steel framing
  - fastening, 9.24.3.1.
  - in fire-rated walls, 9.24.3.2.
  - installation, 9.24.3.1.
  - metal thickness, 9.24.1.3., 9.24.2.3., 9.24.2.4.
  - at openings, 9.24.2.4.
- Runs, stairs
  - aisle steps, 3.3.2.5.

bleacher steps, 3.3.2.12.  
curved flights, 3.3.1.16.  
definition, 1.4.1.2.[A]  
landing dimensions, 3.4.6.4.  
minimum, 3.4.6.8.  
rectangular treads, 9.8.4.2.  
tapered treads, 3.3.1.16., 3.4.6.9., 9.8.4.3.  
uniformity and tolerances, 9.8.4.4., 9.8.4.5.

## S

Safety glass  
in guards, 9.8.8.7.  
on revolving doors, 3.4.6.15.  
standards for, 9.6.1.2.  
transparent panels and doors, 3.3.1.19., 3.4.1.8.  
uses, 9.6.1.4.  
washrooms, 3.7.2.5.

Safety of public, construction and demolition sites, 8.2.

Sanitary drainage systems, 1.4.1.2.[A], 9.31., 9.31.2.1., 9.31.5.

Sawtooth roofs, wind loads, 4.1.7.6.

Scaffolding, 4.1.1.3.

Screens  
in exhaust outlets, 6.3.2.9., 9.32.3.13.  
in intake openings, 6.3.2.9., 9.32.3.13.  
in natural ventilation openings, 9.32.2.2.

Screw installation  
gypsum board, 9.29.5.9.  
sheet steel framing, 9.24.1.5., 9.24.3.1.

Screws  
dimensions, 9.23.3.5.  
fastening to steel studs, 9.24.1.4.  
for gypsum board, 9.29.5.5., 9.29.5.7.  
sheathing, 9.23.3.5.  
standard for, 9.23.3.1., 9.24.1.4., 9.29.5.7.  
subflooring, 9.23.3.5.  
wood-frame construction, 9.23.3.5.

Sealants  
cladding, 9.27.4., 9.27.8.4., 9.27.9.3., 9.27.9.4., 9.27.10.3.  
material properties, 9.27.4.2.  
material standards, 9.27.4.2.  
in noncombustible construction, 3.1.5.2.  
siding, 9.27.4., 9.27.8.4., 9.27.9.3., 9.27.9.4., 9.27.10.3.  
windows, doors and skylights, 9.7.6.2.

Sealing  
(see also Air barrier systems; Soil gas control; Waterproofing)  
against precipitation, 5.6.2., 9.27.4.  
against soil gas, 9.25.3.6.  
air barrier systems, 5.4.1.2., 9.10.9.16., 9.10.9.17., 9.25.3.3.  
at chimneys, 9.21.5.2., 9.25.3.3.  
ducts, 3.6.5.3., 6.3.2.19., 9.32.3.11., 9.33.6.3., 9.33.6.7.  
floors-on-ground, 9.25.3.6.  
at gas vents, 9.25.3.3.  
ground cover, 9.18.6.2.

sill plates, 9.23.7.2.  
windows, doors and skylights, 9.7.6., 9.20.13.11., 9.27.4.

Seasonally and intermittently occupied buildings  
application of Part 9, 9.1.1.1.  
ventilation, 6.3.1.3.

Seating  
aisle width, 3.3.2.1.  
not fixed, 3.3.2.2.  
occupant load, 3.3.2.2., 4.1.5.10.  
in showers, 3.8.3.16.  
wheelchair space, 3.8.2.3., 3.8.3.21.

Secondary suites  
ceiling height, 9.5.3.1.  
definition, 1.4.1.2.[A]  
doors, direction of swing, 9.9.6.5.  
doors in means of egress, 9.9.6.  
doorways, 9.5.5., 9.9.6.2., 9.9.6.3.  
egress, 9.9.9.  
electrical outlets, 9.34.2.3.  
fire protection, 9.10.8.  
fire-resistance rating, 9.10.8.8.  
fire separations, 9.9.4., 9.10.9.4., 9.10.9.14., 9.10.9.15., 9.10.10.4., 9.10.12.3.  
firewalls, 9.10.11.2.  
floor area limits, 9.1.2.1.  
guards, 9.8., 9.8.8.  
handrails, 9.8., 9.8.7.  
heating and air-conditioning, 9.33.1.1., 9.33.3.1., 9.33.3.2.  
height of rooms and spaces, 9.5.3.  
landings, 9.8.6., 9.8.6.3.  
ramps, 9.8., 9.8.5.2.  
smoke alarms, 9.10.19.  
soffit protection, 9.10.12.4.  
sound control, 9.11.  
spatial separation, 9.10.15.  
sprinkler systems, 3.2.5.12.  
stairs, 9.8.  
ventilation, 9.32.1.2., 9.32.3.8., 9.32.3.9.

Seismic data, 1.1.3.

Seismic isolation  
definitions and analysis, 4.1.8.19.  
design provisions, 4.1.8.20.

Seismic loads (see Earthquake design)

Self-closing devices, 3.1.8.13., 3.4.6.13., 9.9.6.7., 9.10.13.10., 9.10.13.15.

Self-contained emergency lighting, 3.2.7.4., 9.9.12.3.

Self-service storage buildings, 3.9.

Self-storage warehouses, 3.3.5.9., 9.9.6.4.

Septic disposal beds, 9.14.6.2.

Service lines under buildings, 3.2.3.21.

Service rooms  
access to exit, 9.9.7.5.  
application of Code, 3.6.1.1.  
and building height, 9.10.4.4.  
carbon monoxide alarms, 9.32.3.9.  
construction supporting, 9.10.8.5.  
definition, 1.4.1.2.[A]  
doors, 9.10.13.12.  
doors and door hardware, 3.3.1.13., 3.4.6.11.

- emergency lighting, 3.2.7.3.
- exits, 3.4.4.4., 3.6.2.2.
- fire alarm systems, 3.2.4.2.
- fire detectors, 3.2.4.10.
- fire resistance of supporting construction, 3.1.7.5.
- fire separations, 3.6.2.1., 9.10.10.3.
- heat and smoke detectors, 9.10.18.4.
- for housing and small buildings, 9.10.10.
- loads on floor or roof, 4.1.5.3.
- opening into exit, 9.9.5.9.
- ramps and stairways, 3.3.1.14.
- roof-top, 3.2.1.1., 3.2.2.14., 9.10.4.4.
- service equipment in, 3.6.2.3.
- under exits, 9.9.5.8.
- Service spaces
  - and building height, 3.2.1.1.
  - definition, 1.4.1.2.[A]
  - egress, 3.3.1.24.
  - emergency lighting, 3.2.7.3.
  - exits, 3.4.4.4.
  - fire alarm systems, 3.2.4.18.
  - horizontal (see Horizontal service spaces)
  - lightning protection systems, 3.6.1.3.
  - means of egress, 3.3.1.3.
  - protection of electrical conductors, 3.2.7.10.
  - ramps and stairways, 3.3.1.14.
  - signage, 3.3.1.24.
  - sprinkler systems, 3.2.5.14.
  - storage use prohibition, 3.6.1.4.
  - travel distance to exit, 3.4.2.4.
  - vertical (see Vertical service spaces)
- Service water heaters
  - definition, 1.4.1.2.[A]
  - in housing and small buildings, 9.31.6.
  - indirect, 1.4.1.2.[A]
  - protection from corrosion, 9.31.6.3.
  - steel, 9.31.6.3.
  - storage type, 1.4.1.2.[A], 9.31.6.2., 9.31.6.3.
- Service water heating systems
  - energy efficiency, 9.36., 9.36.4.
  - energy performance calculations, 9.36.5.8.
  - energy performance modeling, 9.36.5.12., 9.36.5.16.
  - equipment efficiency, 9.36.4.2.
  - temperature controls, 9.36.4.5.
- Sewage disposal, 9.14.5., 9.31.2.1., 9.31.5.
- Sewage disposal systems, private, 1.4.1.2.[A], 9.31.2.1., 9.31.5.2.
- Shafts
  - installation, 6.7.1.5.
  - opening into an interconnected floor space, 3.2.8.4.
  - piping in, 6.7.1.5.
  - service, 9.10.1.3.
- Shakes, wood
  - cladding, 9.27.7.
  - dimensions, 9.27.7.2., 9.27.7.6.
  - eave protection, 9.26.5.1., 9.26.10.7.
  - flashing, 9.26.10.6.
  - grades, 9.26.10.8., 9.27.7.1.
  - installation, 9.27.5., 9.27.7.3.
  - material standards, 5.9.1.1., 9.26.2.1., 9.27.7.1.
  - roofing, 9.26.10.
- spacing and joints, 9.26.10.3.
- underlay, 9.26.10.2.
- Shallow foundations
  - damaged, 4.2.6.4.
  - definition, 1.4.1.2.[A]
  - design, 4.2.6.1.
  - footing design, 9.4.4.1.
  - incorrect placement, 4.2.6.3.
  - support, 4.2.6.2.
- Sheathing
  - (see also Subflooring)
  - for braced wall panels, 9.23.13.6.
  - for bracing and lateral support, 9.23.10.2.
  - in exposing building face, 9.10.14.5., 9.10.15.2.
  - fastening, 9.23.3.5.
  - fibreboard as, 9.23.16.7.
  - installation, 9.23.3.5., 9.23.16.3., 9.23.16.4., 9.23.17.4., 9.23.17.5.
  - insulating, 9.20.13.6., 9.27.3.4.
  - low permeance, 9.25.5.1.
  - lumber as, 9.3.2.1., 9.23.16.5., 9.23.17.2., 9.23.17.4.
  - material standards, 9.23.16.2., 9.23.17.2., 9.26.2.1.
  - in noncombustible construction, 3.1.5.3.
  - OSB as, 9.3.2.4., 9.23.16.2., 9.23.17.2.
  - plywood as, 9.3.2.4., 9.23.16.2., 9.23.17.2.
  - roofs, 9.3.2.1., 9.3.2.4., 9.23.16., 9.26.2.1.
  - on steel studs, 9.24.1.5.
  - beneath stucco, 9.28.1.1., 9.28.4.2.
  - support, 9.23.10.5., 9.24.3.4.
  - thickness, 9.23.16.7., 9.23.17.2.
  - waferboard as, 9.3.2.4., 9.23.16.2., 9.23.17.2.
  - walls, 9.3.2.1., 9.3.2.4., 9.23.17.
- Sheathing membranes
  - installation, 9.27.3.3. - 9.27.3.6.
  - insulation, 9.27.3.5.
  - interior of masonry walls, 9.20.13.9.
  - mansard roofs, 9.23.17.6.
  - material standard, 9.27.3.2.
  - for precipitation protection, 9.27.3.1. - 9.27.3.6.
- Sheathing paper (see Sheathing membranes)
- Shingles, asphalt
  - eave protection, 9.26.5.1., 9.26.7.7.
  - flashing, 9.26.4.
  - installation, 9.26.1.3., 9.26.7., 9.26.8.
  - material standards, 5.9.1.1., 9.26.2.1.
  - nails, 9.26.2.3.
  - slope, 9.26.3.1.
  - staples, 9.26.2.4.
  - underlay, 9.26.6.
- Shingles, wood
  - cladding, 9.27.7.
  - dimensions, 9.26.9.3., 9.27.7.2., 9.27.7.6.
  - eave protection, 9.26.9.8.
  - exposure, 9.26.9.6.
  - flashing, 9.26.9.7.
  - grade, 9.26.9.2., 9.27.7.1.
  - installation, 9.26.9.4., 9.27.2.4., 9.27.5., 9.27.7.3.
  - materials, 9.27.7.1.
  - material standards, 5.9.1.1., 9.26.2.1., 9.27.7.1.
  - roofing, 9.26.9.
- Shop drawings, review of work, 2.2.7.3.[C]



- Showers, 3.8.3.16.  
 Sidelights, 3.3.1.19., 9.6.1.4., 9.7.1.1., 9.7.2.1., 9.9.4.3.  
 Sidewalks, 4.1.5.3., 8.2.1.2., 8.2.3.1.  
 Siding (see Cladding)  
 Signs  
   barrier-free accessibility, 3.8.2.4., 3.8.2.10., 3.8.3.9.  
   construction sites, 8.2.3.3., 8.2.3.5., 8.2.4.1.  
   directing traffic, 8.2.4.3.  
   egress points, 3.3.1.24.  
   emergency crossover access to floor areas, 3.4.6.18.  
   exit obstruction prevention, 3.4.6.11., 9.9.11.2.  
   exits, 3.4.5.1., 9.9.11., 9.9.11.3.  
   floor numbers, 3.4.6.19., 3.5.4.2., 9.9.11.5.  
   graphical symbols, 3.4.5.2.  
   occupant load, 3.1.17.1.  
   stairs and ramps, 9.9.11.4.  
 Silencing devices, 3.2.4.18., 3.2.4.20., 3.2.4.22., 3.2.6.7.  
 Sill plates  
   dimensions, 9.23.7.1.  
   leveling, 9.23.7.2.  
   sealing, 9.23.7.2.  
   standard for, 9.23.7.  
 Site plans, 2.2.2.2.[C]  
 Site stability, earthquake design, 4.1.8.17.  
 Skylights  
   airtightness, 9.36.2.9., 9.36.2.10.  
   area, 9.10.17.9.  
   in area calculations, 9.10.17.6.  
   combustible, in corridors, 3.1.13.5.  
   flame-spread rating, 3.1.13.2., 9.10.17.1.  
   glass standards, 9.6.1.3.  
   in housing and small buildings, 9.7.  
   installation, 9.7.6.  
   manufactured and pre-assembled, 9.7.4.  
   in noncombustible construction, 3.1.5.4.  
   performance expectations, 9.7.3.  
   requirements, 9.7.2.2.  
   on roof adjacent to wall with windows, 3.2.3.15.  
   site-built, 9.7.5.  
   standards for, 5.4.1.2., 5.9.2.1., 5.9.2.2., 9.7.4.  
   thermal characteristics, 9.7.3.3., 9.36.2.7.  
   in unsprinklered compartments, 9.10.12.2.  
 Slabs-on-ground  
   (see also Floors-on-ground)  
   bond break, 9.16.4.4.  
   concrete, 9.16.4.  
   ducts in or beneath, 9.33.6.7.  
   finishing, 9.16.4.1., 9.16.4.2.  
   insulation, 9.25.2.3.  
   thickness, 9.16.4.3.  
 Sleepers, 9.30.1.3.  
 Slide escapes, 3.4.1.6.  
 Sliding doors  
   barrier-free, 3.8.3.6.  
   exits, 3.4.6.14.  
   glass used in, 9.6.1.4.  
   as means of egress, 3.3.1.12., 9.9.6.4.  
   performance expectations, 9.7.3.1., 9.7.3.2.  
   standards for, 5.3.1.2., 5.4.1.2., 9.7.4.2.  
 Slip-resistance  
   barrier-free path of travel, 3.8.3.2.  
   bathtubs, 3.8.3.17.  
   exterior walks, 3.8.3.3.  
   ramps and stairways, 3.3.1.14., 3.4.6.1.  
   showers, 3.8.3.16.  
   treads and landings, 9.8.9.6.  
 Smoke  
   circulation prevention, 3.2.4.12., 9.10.18.5.  
   contamination, 3.2.6.2., 3.2.8.4.  
   control of, 3.1.8.14., 3.2.6.1., 3.2.6.9., 3.3.1.7., 3.3.3.5., 3.3.3.7.  
 Smoke alarms  
   definition, 1.4.1.2.[A]  
   in housing and small buildings, 9.10.19.  
   interconnection, 9.10.19.5.  
   location, 9.10.19.3.  
   maintenance and care instructions, 9.10.19.7.  
   power supply, 9.10.19.4.  
   requirements, 3.2.4.20., 9.10.19.1.  
   silencing, 9.10.19.6.  
   smoke detectors in lieu of, 3.2.4.20., 3.2.4.21.  
   sound patterns, 9.10.19.2.  
 Smoke barrier doors, 3.2.3.20.  
 Smoke barriers, 9.10.9.2., 9.10.9.15.  
 Smoke chambers  
   clearances, 9.22.9.3.  
   slope, 9.22.7.1.  
   standard for, 9.22.7.  
   wall thickness, 9.22.7.2.  
 Smoke dampers  
   access, 3.1.8.11.  
   as closures, 3.1.8.5.  
   in fire separations, 3.1.8.7.  
   installation, 3.1.8.11.  
   leakage rates, 3.1.8.4.  
   waived, 3.1.8.9.  
 Smoke detectors  
   in air-handling systems, 6.9.2.2., 9.10.18.5.  
   annunciators, 3.2.4.8.  
   for construction camps, 9.10.21.7.  
   definition, 1.4.1.2.[A]  
   design and installation, 9.10.18.3.  
   duct-type, 3.2.4.12.  
   in electrical equipment rooms, 3.6.2.7.  
   in elevators, 3.2.4.11., 3.2.4.14.  
   in fire alarm systems, 9.10.18.  
   in lieu of smoke alarms, 3.2.4.20., 3.2.4.21., 9.10.19.8.  
   and release of hold-open devices, 3.1.8.14.  
   requirements, 3.2.4.11., 9.10.18.4.  
 Smoke developed classification  
   duct requirements, 3.6.5.1.  
   high buildings, 3.1.13.7.  
   plenum requirements, 3.6.4.3.  
   tests, 3.1.12.1.  
 Smoke shafts (venting to aid firefighting), 3.2.6.6.  
 Smoke stacks (venting for chimneys), 6.3.3.3.  
 Snow accumulation, 4.1.6.2., 4.1.6.3., 4.1.6.7., 4.1.6.10., 5.6.2.2.  
 Snow loads  
   arch roofs, 4.1.6.10.  
   areas adjacent to roof projections, 4.1.6.7.  
   basic load factors, 4.1.6.2.

- curved roofs, 4.1.6.10.
- domes, 4.1.6.10.
- due to sliding, 4.1.6.11.
- exterior platforms, 9.4.2.3.
- full and partial, 4.1.6.3.
- gable roofs, 4.1.6.9.
- and gap between roof and higher roof, 4.1.6.6.
- multi-level roofs, 4.1.6.5.
- snow drift at roof corners, 4.1.6.8., 4.1.6.13.
- specified, 4.1.6.2., 9.4.2.2.
- and structural design, 4.1.6.
- valleys in curved or sloped roofs, 4.1.6.12.
- weight calculations for drifts, 4.1.6.13.
- Snow removal, 4.1.6.14.
- Soffits
  - projections, 3.2.3.6., 9.10.14., 9.10.14.5., 9.10.15., 9.10.15.4., 9.10.15.5.
  - protection of, 3.2.3.16., 9.10.12.4.
  - venting, 9.19.1.2., 9.19.1.3., 9.25.2.4.
- Soil gas control
  - application of Code, 9.13.1.1.
  - crawl spaces, 9.13.4.2.
  - floors-on-ground, 9.16.2.1., 9.25.3.6.
  - requirements, 5.4.1.1., 9.13.4., 9.13.4.2.
  - walls in contact with the ground, 9.25.3.4.
- Soil, pyritic
  - drainage, 9.14.2.1., 9.14.4.1.
  - beneath floors-on-ground, 9.16.2.2.
  - and footings, 9.15.3.2.
  - foundations on, 9.4.4.4.
  - not in backfill, 9.12.3.3.
- Soils
  - bearing pressure, 9.4.4.1., 9.4.4.2.
  - definition, 1.4.1.2.[A]
  - erosion control, 5.6.2.2.
  - excavations, 4.2.5., 9.12.
  - beneath footings and foundations, 9.12.4.1., 9.15.1.1., 9.15.3.2.
  - identification and classification, 4.2.4.3., 9.4.4.
  - subsurface investigation, 4.2.2.1., 4.2.4.1., 4.2.4.2.
  - swelling and shrinking, 4.2.4.11., 9.4.4.4., 9.12.3.3., 9.14.2.1., 9.14.4.1., 9.15.3.2., 9.16.2.2.
  - temperature, 5.2.1.1., 5.2.1.3., 9.12.2.2., 9.16.2.2.
- Solar domestic hot water systems, 9.36.4.3.
- Solar thermal systems, 9.36.3.11.
- Solid-fuel-burning appliances
  - carbon monoxide alarms, 6.9.3.1., 9.32.3.9.
  - design, 9.33.5.3.
  - fireplace inserts and hearth-mounted stoves, 9.22.10.
  - and fire separations, 3.6.2.1.
  - installation standard, 6.2.1.5., 9.22.10.2., 9.33.5.3.
- Solid masonry, 1.4.1.2.[A]
- Solid masonry units, 1.4.1.2.[A], 9.15.5.1.
- Sound
  - protection from, 3.3.4.6., 5.1.1.1., 5.8.1., 9.11.
  - rating for fans, 9.32.3.10.
  - smoke alarms, 9.10.19.3.
- Sound transmission class (STC)
  - calculation of, 5.8.1.2.
  - compliance, 5.8.1.3.
  - definition, 1.4.1.2.[A]
- Space heaters
  - (see also Heating appliances)
  - definition, 1.4.1.2.[A]
  - design and standards, 9.33.5.3.
  - performance requirements, 9.36.3.10.
- Space heating appliances
  - definition, 1.4.1.2.[A]
  - installation standards, 9.33.5.2.
- Spans
  - maximums, 9.23.4.
  - steel, 9.23.4.3.
  - wood, 9.23.4.1., 9.23.4.2., 9.23.4.4., 9.23.4.5.
- Spatial separation between buildings, 3.2.3., 9.10.14., 9.10.21.5.
- Spatial separation between houses, 3.2.3.
- Special structures, 3.2.2.2.
- Sprinklered buildings or spaces
  - egress from bedrooms, 9.9.10.1.
  - fire-resistance rating, 9.10.8.2., 9.10.9.15., 9.10.10.6.
  - fire separations, 3.3.1.4., 3.6.2.5., 9.10.9.6., 9.10.9.13., 9.10.9.15., 9.10.10.6.
  - heat and smoke detection, 9.10.18.4.
  - limiting distance, 9.10.14.3.
  - lobbies, 3.4.4.2., 9.9.8.5.
  - openings in exposing building faces, 3.2.3.1., 9.10.14.4., 9.10.15.4.
  - openings in fire separations, 9.10.13.8.
  - and safety within floor areas, 3.3.
  - service spaces, 3.6.
  - soffit protection, 9.10.12.4.
  - and travel distance, 3.4.2.4., 3.4.2.5., 9.9.8.1., 9.9.8.2., 9.9.8.6.
- Sprinklered, definition, 1.4.1.2.[A]
- Sprinkler systems
  - for arena-type buildings, 3.1.2.3.
  - for assembly occupancy (Group A, Division 1), 3.2.2.20.
  - for assembly occupancy (Group A, Division 2), 3.2.2.23., 3.2.2.24., 3.2.2.26., 3.2.2.27.
  - for assembly occupancy (Group A, Division 3), 3.2.2.29., 3.2.2.31., 3.2.2.33.
  - for assembly occupancy (Group A, Division 4), 3.2.2.35.
  - for barrier-free floor areas, 3.3.1.7.
  - for basements, 3.2.1.5.
  - for business and personal services occupancy (Group D), 3.2.2.55., 3.2.2.57., 3.2.2.58., 3.2.2.59., 3.2.2.61., 3.2.2.63.
  - for care, treatment or detention occupancy (Group B, Division 1), 3.2.2.36., 3.2.2.37.
  - for care, treatment or detention occupancy (Group B, Division 2), 3.2.2.38. - 3.2.2.41.
  - for care, treatment or detention occupancy (Group B, Division 3), 3.2.2.42. - 3.2.2.46.
  - combustible pipes in, 3.1.9.5., 3.2.5.13., 9.10.9.6.
  - construction of, 3.2.5.12.
  - for contained use areas, 3.3.3.7.
  - and controlled egress, 3.4.6.17.
  - for corridors, 3.1.13.6., 3.3.2.6.

design, 3.2.5.12.  
 and door hold-open devices, 3.1.8.14.  
 and egress doorways, 3.3.1.5.  
 electrical supervision, 3.2.4.9.  
 exceptions for mezzanines, 3.2.8.2.  
 for exposing building face, 3.2.3.2.  
 and fire alarm systems, 3.2.4.1., 3.2.4.7., 3.2.4.8.,  
 9.10.18.4.  
 fire department connection, 3.2.5.15.  
 and firefighting access, 3.2.5.1.  
 fire hose connections, 3.2.5.10.  
 fire hose stations, 3.2.5.11.  
 fire separations in residential occupancy, 3.3.4.2.  
 flame-spread rating, 3.1.13.8.  
 for garages, 3.2.1.2., 3.3.5.4., 3.3.5.7.  
 in heavy timber construction, 3.1.4.7., 3.2.2.16.  
 for high buildings, 3.1.13.7.  
 for high-hazard industrial occupancy (Group F,  
 Division 1), 3.2.2.70.  
 for impeded egress areas, 3.2.2.19.  
 installation, 3.2.5.12., 9.10.1.3.  
 for interconnected floor space, 3.2.8.3.  
 for libraries, 3.3.2.13.  
 in lieu of fire detectors, 3.2.4.10.  
 limiting distance, 3.2.3.1.  
 for low-hazard industrial occupancy (Group F,  
 Division 3), 3.2.2.80., 3.2.2.82., 3.2.2.84., 3.2.2.86.,  
 3.2.2.88.  
 for medium-hazard industrial occupancy (Group F  
 Division 2), 3.2.2.74., 3.2.2.75., 3.2.2.77., 3.2.2.79.  
 for mercantile occupancy (Group E), 3.2.2.64.,  
 3.2.2.65., 3.2.2.67., 3.2.2.69.  
 and metal roof deck, 3.1.14.2.  
 in noncombustible construction, 3.1.5.19.  
 plans, 2.2.3.2.[C]  
 for repair garages, 3.3.5.4.  
 required, 3.2.2.18.  
 for residential occupancy (Group C), 3.2.2.47.,  
 3.2.2.48., 3.2.2.50., 3.2.2.51., 3.2.2.54.  
 self-storage warehouses, 3.3.5.9.  
 and separation of public corridors, 3.3.1.4.  
 and separation of suites, 3.3.1.1.  
 and service penetrations, 3.1.9.5.  
 for service spaces, 3.2.5.14.  
 and soffit protection, 3.2.3.16.  
 stages, 3.3.2.14.  
 and standpipes, 3.2.5.8., 3.2.5.9.  
 for storage garages, 3.2.1.2., 3.3.5.4., 3.3.5.7.  
 for storage rooms, 3.3.4.3.  
 for storeys below ground, 3.2.2.15.  
 system monitoring, 3.2.4.15.  
 testing, 3.2.5.12.  
 for theatres, 3.3.2.14.  
 for underground walkways, 3.2.3.20.  
 and unprotected openings, 3.2.3.1., 3.2.3.12.,  
 3.2.3.14., 3.2.3.15., 3.2.3.17.  
 Stability, structural, 4.1.3.2.  
 Stages, theatrical, 1.4.1.2.[A], 3.3.1.18., 3.3.2.14.  
 Stairs  
   cantilevered, 9.8.9.2., 9.8.10.  
   clear height over, 9.8.2.2.  
   concrete, 9.8.9.2., 9.8.10.  
   construction, 9.8.9.  
   curved, 3.3.1.16., 3.4.6.5., 3.4.6.9., 9.8.3.1.  
   dimensions, 3.3.2.15., 9.8.2.  
   doors onto, 3.4.6.3., 3.4.6.11., 9.8.6.2., 9.9.4.4.,  
   9.9.6.6.  
   in dwelling units, 3.3.4.7., 9.8.  
   for exits, 9.8.1.3., 9.8.2.1., 9.8.3.1., 9.9.9.3.  
   exit signs with, 9.9.11.4.  
   exterior, 9.3.1.6., 9.8.9.2., 9.8.9.3.  
   finishes, 3.4.6.1., 9.8.9.6.  
   fire blocks required, 3.1.11.4., 9.10.16.1.  
   on fire escapes, 3.4.7.5.  
   with foundations, 9.12.2.2.  
   guards for, 9.8.8.  
   handrails, 3.4.6.5., 9.8.7., 9.8.7.1.  
   height of, 9.8.3.3.  
   horizontal exit prohibition, 3.4.6.10.  
   landings (see Landings)  
   loads on, 9.8.9.1.  
   in noncombustible construction, 3.1.5.11.  
   nosings, 9.8.4.8.  
   permitted configurations, 9.8.3.1.  
   in restaurants, 3.3.2.15.  
   rise, 3.4.6.8., 9.8.3.3., 9.8.4.1., 9.8.4.4.  
   risers (see Risers)  
   runs (see Runs, stairs)  
   in secondary suites, 9.8.  
   slip-resistance, 3.4.6.1., 9.8.9.6.  
   spiral, 9.8.3.1., 9.8.4.7.  
   tolerances, 9.8.4.4.  
   treads (see Treads)  
   vertical rise, 3.4.6.3.  
   width, 9.8.2.1.  
   winders, 9.8.3.1., 9.8.4.6.  
   wood, 9.8.9.3., 9.8.9.4.  
 Stairways  
   as exits, 3.2.3.13., 3.4.1.4., 3.4.2.3., 3.4.3.3., 3.4.6.6.,  
   9.9.4.7.  
   headroom clearance, 3.4.3.4., 9.8.2.2., 9.8.6.4.  
   landings, 3.4.3.3.  
   lighting, 3.2.7.1., 9.9.12.2., 9.34.2.3.  
   in means of egress, 9.9.1.1.  
   mezzanine egress, 9.9.8.6.  
   projections into, 9.8.7.6.  
   requirements, 3.3.1.14.  
   roof-top enclosures, 3.2.2.14.  
   weather protection, 3.3.5.4., 3.4.6.11.  
   width, 3.4.3.2., 3.4.3.3., 9.8.2.1.  
 Standards, materials, 1.5.[A], 5.9.1.1.  
 Standpipe systems  
   in construction camps, 9.10.21.9.  
   design, 3.2.5.9.  
   fire department connection, 3.2.5.15.  
   fire hose connections, 3.2.5.10.  
   fire protection, 9.10.1.3.  
   installation, 3.2.5.9.  
   requirements, 3.2.5.8.  
   testing, 3.2.5.9.  
   trouble switch, 3.2.4.9.

**Staples**

- for cladding, 9.27.5.4.
- dimensions, 9.23.3.5., 9.26.2.4., 9.27.5.4.
- for roofing, 9.26.2.4.
- for sheathing, 9.23.3.5.
- for stucco lath, 9.28.3.2.
- for subflooring, 9.23.3.5.
- for underlay, 9.30.2.3.
- for wood strip flooring, 9.30.3.4.

**Stapling**

- asphalt shingles, 9.26.7.4., 9.26.7.6., 9.26.8.5.
- cladding, 9.27.5.4., 9.27.7.3.
- plywood finish, 9.29.6.3.
- roofing, 9.26.7.4., 9.26.7.6., 9.26.8.5., 9.26.9.5.
- sheathing, 9.23.3.5.
- sheathing membrane, 9.27.3.5.
- siding, 9.27.5.4., 9.27.7.3.
- subflooring, 9.23.3.5.
- underlay, 9.30.2.3.
- wood-frame construction, 9.23.3.
- wood shingles and shakes, 9.26.9.5., 9.27.7.3.
- wood strip flooring, 9.30.3.4.

**Static procedure, wind load calculations, 4.1.7.3.****Steel**

- beams, 9.23.4.3., 9.23.8.2.
- cold-formed, structural design basis, 4.3.4.2.
- columns, 9.10.14.5., 9.10.15.5., 9.17.3.
- design, 9.4.1.1.
- door frames, 9.10.13.6.
- fire protection, 3.2.2.3., 9.10.7.
- flashing, 9.20.13.1., 9.27.3.7.
- in foundations, 4.2.3.7.
- in foundations, high-strength tendons in, 4.2.3.9.
- framing, 9.24.
- lintels, 9.20.5.2., 9.22.1.2.
- protection from corrosion, 4.2.3.10., 5.1.4.2., 9.3.3.2., 9.17.3.3., 9.20.5.2., 9.20.16., 9.23.8.2.
- roofing, 5.9.1.1., 9.26.13.
- runners, 9.24.1.2., 9.24.1.3., 9.24.2.3., 9.24.2.4., 9.24.3.1., 9.24.3.2., 9.24.3.6.
- siding, 5.9.1.1., 9.27.11.1.
- structural design basis, 4.3.4.
- studs, 9.24.1.1., 9.24.2.1., 9.24.2.2., 9.24.2.4., 9.24.2.5., 9.24.3.2.

**Stone**

- facings, 9.20.6.6.
- masonry units, 9.20.2.5.
- veneer, 9.20.8.5.

**Storage**

- of ammonium nitrate, 3.3.6.6.
- of anhydrous ammonia, 3.3.6.3.
- on the building site, 1.2.2.2.[A]
- of dangerous goods, 3.3.6.2.
- of flammable and combustible liquids, 3.3.6.4.
- of flammable, toxic and oxidizing gases, 3.3.6.3.
- of materials, 1.2.2.2.[A], 9.10.1.3.
- outdoors, 3.2.3.21.
- of tires, 3.3.6.5.

**Storage areas, theatres, 3.3.2.14.****Storage bins****Storage bins**

- for ash, 6.9.4.1.
- for solid fuel, 6.7.2.1.

**Storage buildings, self-service**

- application of Code, 3.9.1.2.
- definition, 3.9.1.1.
- fire safety, 3.9.2.
- floor areas, 3.9.3.
- occupancy classification, 3.9.1.3.
- sanitary facilities, 3.9.3.2.

**Storage garages**

- (see also Garages)
- access through vestibule, 3.3.5.7.
- in basements, 9.10.4.3.
- in buildings with superimposed major occupancies, 3.2.2.7.
- carbon monoxide alarms, 6.9.3.1.
- cladding, 9.10.14.5.
- construction, 9.10.14.5., 9.35.
- definition, 1.4.1.2.[A]
- doors, 9.9.6.4., 9.10.17.10.
- exhaust to, 6.3.2.10.
- exposing building face, 9.10.14.4., 9.10.14.5.
- fire alarms, 3.2.4.1., 9.10.18.8.
- fire separations, 3.3.5.6., 9.10.9.16.
- headroom clearance, 3.3.1.8.
- height, 3.3.5.4., 9.5.3.3., 9.9.3.4.
- interconnection of ducting, 6.3.2.7., 9.33.6.7.
- limiting distance, 9.10.14.4.
- in low-hazard industrial occupancies (Group F, Division 3), 3.2.2.90.
- open-air, 9.10.14.4., 9.10.18.8.
- openings for vehicular ramps, 3.2.8.2.
- pressure less than in adjoining occupancies, 6.3.1.4.
- as separate buildings, 3.2.1.2.
- standpipes requirement, 3.2.5.9.
- unprotected openings in, 3.2.3.10., 9.10.14.4.
- ventilation, 3.3.5.4., 6.3.1.4., 9.32.1.1.

**Storage lockers, 3.1.5.17.****Storage racks, earthquake design, 4.1.8.18.****Storage rooms**

- in assembly occupancy, 3.3.2.16.
- for combustible garbage, 9.10.10.6.
- electrical outlets in, 9.34.2.5.
- fire alarm and detection systems, 9.10.18.6.
- fire detectors in, 3.2.4.10., 9.10.18.4.
- fire separations, 3.3.4.3., 3.6.2.5., 9.10.10.6.
- for flammable and combustible liquids, 3.3.6.4.
- flooring in areas of dangerous goods, 3.3.6.7.

**Storage tanks, 3.1.1.3.****Storage-type service water heaters, 1.4.1.2.[A], 9.31.6.2., 9.31.6.3.****Storefronts (see Fenestration)****Storeys**

- below ground, 3.2.2.15.
- definition, 1.4.1.2.[A]
- open-air, 1.4.1.2.[A], 3.2.1.5., 3.2.2.80., 3.2.2.90., 3.2.3.10., 3.2.5.4., 6.3.1.4., 9.10.14.4.
- sprinkler system requirements, 3.2.2.18.

**Stoves**

- (see also Cooktops)

- clearances, 9.10.22.2.
- definition, 1.4.1.2.[A]
- design and installation standard, 9.33.5.2., 9.33.5.3.
- hearth-mounted, 9.22.10.
- installation, 9.10.22.1.
- Strandboard (see OSB)
- Strapping, floor joists, 9.23.3.4., 9.23.9.3., 9.23.9.4.
- Streets
  - definition, 1.4.1.2.[A]
  - exposing building face on, 9.10.14.4.
  - fire access routes, 3.2.2.10.
  - repairs following construction, 8.2.3.4.
  - safe passage past construction sites, 8.2.3.1., 8.2.3.2.
  - unprotected openings facing, 3.2.3.10.
- Stress reversal, 4.1.3.2.
- Structural design
  - Code requirements, 4
  - housing and small buildings, 9.4.
  - limit states design, 4.1.3.
  - and structural loads, 5.2.2.
- Structural drawings, 2.2.4.3.[C]
- Structural fire protection, 3.2.2.3., 3.2.3.9., 9.10.8.
- Structural loads and design procedures, 4.1., 5.2.2., 5.9.3.2., 9.4.
  - exterior insulation finish systems, 5.9.4.1.
- Structural movement
  - mechanical systems and equipment, 4.1.8.18., 6.2.1.4., 9.33.4.7.
  - service water heaters, 9.31.6.2.
- Structures, special, 3.2.2.2.
- Stucco
  - aggregate for, 9.28.2.2., 9.28.5.1.
  - application, 9.28.6.
  - fasteners, 9.28.3.1., 9.28.3.2.
  - flashing for, 9.28.1.5.
  - ground clearance, 9.28.1.4.
  - for housing and small buildings, 9.28.
  - installation, 9.28.1.2., 9.28.1.3., 9.28.3.1., 9.28.3.2., 9.28.6.
  - lath (see Lath, stucco)
  - materials, 9.28.2., 9.28.5.
  - mixes, 9.28.5.1.
  - mixing, 9.28.5.3.
  - nails for, 9.28.3.
  - pigments, 9.28.5.2.
  - sheathing beneath, 9.28.1.1., 9.28.4.2.
  - staples for, 9.28.3.
  - thickness, 9.28.6.
- Studs, steel
  - bracing and lateral support, 9.24.1.5.
  - dimensions, 9.24.2.1., 9.24.2.5.
  - fastening, 9.24.1.4., 9.24.3.6.
  - in fire-rated walls, 9.24.2.4., 9.24.3.2.
  - in housing and small buildings, 9.24.
  - metal thickness, 9.24.1.3., 9.24.2.2., 9.24.2.4., 9.24.2.5.
  - notching and drilling, 9.23.5.3.
  - at openings, 9.24.2.4., 9.24.3.5., 9.24.3.7.
  - orientation, 9.24.3.3.
  - spacing, 9.24.2.1., 9.24.2.5.
  - standard for, 9.24.1.2.
- Studs, wood
  - bracing, 9.23.10.2.
  - continuity, 9.23.10.4.
  - at corners and intersections, 9.23.10.5.
  - dimensions, 9.23.10.1.
  - lateral support, 9.23.10.2.
  - lumber grade, 9.3.2.1.
  - notching and drilling, 9.23.5.3.
  - at openings, 9.23.10.6.
  - orientation, 9.23.10.3.
  - spacing, 9.23.10.1.
  - standard for, 9.24.1.2.
- Subflooring
  - depressurization, 9.13.4., 9.13.4.3.
  - direction of installation, 9.23.15.4.
  - edge support, 9.23.15.3.
  - lumber, 9.23.15.7.
  - materials, 9.23.15.2., 9.23.15.7.
  - nailing, 9.23.15.6.
  - thickness, 9.23.15.5.
  - wood-frame construction, 9.23.15.
- Subsurface investigation, 1.4.1.2.[A], 2.2.4.6.[C], 4.2.2., 4.2.4.2.
- Suites
  - definition, 1.4.1.2.[A]
  - doors and door hardware, 3.3.1.13.
  - fire separations, 9.10.9.13., 9.10.9.14.
  - separation of, 3.3.1.1.
  - smoke control measures, 3.2.6.2.
- Sump pits, 9.14.5.2.
- Sumps, evaporative air coolers and air washers, 6.3.2.16.
- Supervisory signal and switch for alarms, 3.2.4.9., 3.2.6.7.
- Supplemental energy dissipation
  - definitions and analysis, 4.1.8.21.
  - design considerations, 4.1.8.22.
- Supply air
  - capacity, 9.32.2.3., 9.32.3.6., 9.32.3.7., 9.33.3.1., 9.33.5.1., 9.33.6.11.
  - diffusers, 9.33.6.10., 9.33.6.11.
  - duct clearances, 3.6.5.6.
  - ducts, 1.4.1.2.[A], 6.3.2.7., 9.32.3.4., 9.32.3.11., 9.33.6.5., 9.33.6.11.
  - fans, 9.32.3.4., 9.32.3.5., 9.32.3.6.
  - outlets, 9.32.3.5., 9.32.3.6., 9.33.6.10., 9.33.6.11.
  - systems, 9.32.3.4., 9.32.3.6., 9.33.5.
  - tempering, 6.3.2.8., 9.32.3.4., 9.32.3.5., 9.32.3.8., 9.32.3.11.
- Supporting construction, fire-resistance rating, 3.1.7.5.
- Supports
  - beams, 9.23.8.
  - cladding, 9.20.5., 9.23.10.5., 9.24.3.4.
  - combustible construction, 3.1.8.2., 9.10.9.8.
  - excavations, 4.2.5.3.
  - firewalls, 3.1.10.1., 4.1.5.17.
  - floors, 3.2.1.4., 9.23.4.1., 9.23.4.2., 9.23.4.4., 9.23.8.3., 9.30.1.3.
  - hearths, 9.22.5.2.
  - interior finishes, 9.23.10.5., 9.24.3.4.

joists, 9.23.14.7.  
 noncombustible construction, 9.10.8.4.  
 pipes, 6.7.1.1., 9.33.8.1.  
 walls, 9.23.9.8.

Surface temperature  
 of pipes, 6.7.1.4., 9.33.8.2.  
 of radiators, 6.7.1.3., 9.33.7.2.

Swinging doors, 3.8.3.6.

Symbols, 1.2.2.1., 1.4.2.1.[A]

Systems  
 characteristics, 1.2.2.1.[A]  
 storage, 1.2.2.2.[A]  
 used, 1.2.2.3.[A]

**T**

Tablet arms, 3.3.2.4.

Tape, sealing, 3.1.5.2., 3.6.5.3., 6.3.2.19., 9.33.6.3.

Telephones, 3.2.4.22., 3.2.6.7., 3.4.6.17., 3.8.3.20.

Temperature  
 indoor design, 5.2.1.2., 5.3.1.2., 5.5.1.2., 9.33.3.1.  
 outdoor design, 1.1.3.1., 5.2.1.1., 5.3.1.2., 5.5.1.2.,  
 6.2.1.2., 9.33.3.2., 9.33.5.1.  
 of pipes, 6.7.1.4., 9.33.8.2.  
 of radiators, 6.7.1.3., 9.33.7.2.  
 soils, 5.2.1.1., 5.2.1.3., 9.12.2.2., 9.16.2.2.  
 supply air, 9.33.6.11.  
 transfer calculations, 5.2.1.3.

Temperature controls  
 HVAC systems, 9.36.3.6.  
 indoor pools, 9.36.4.6.  
 service water heating systems, 9.36.4.5.

Tempering of make-up air, 6.3.2.8., 9.32.3.4., 9.32.3.5.,  
 9.32.3.8.

Tents  
 clearance to flammable material, 3.1.6.4.  
 clearance to other structures, 3.1.6.3.  
 electrical systems, 3.1.6.7.  
 fire protection, 9.10.1.3.  
 fire safety restrictions, 3.1.6.2.  
 flame resistance, 3.1.6.5.  
 means of egress, 3.1.6.1.  
 roof coverings, 3.1.15.2.

Termites, protection against, 4.3.1.3., 9.3.2.9., 9.12.1.1.,  
 9.15.5.1.

Tests  
 building fire safety, 3.2.9.1.  
 fire-protection rating, 3.1.8.4., 9.10.3.1.  
 fire-resistance rating, 3.1.7.1., 9.10.3.1.  
 flame-spread rating, 3.1.12.1., 3.1.13.4., 6.9.1.1.,  
 9.10.3.2., 9.33.6.3., 9.33.6.4.  
 load, 4.1.1.5., 4.2.4.1., 9.23.14.11.  
 roof coverings, 3.1.15.1.  
 smoke developed classification, 3.1.12.1.  
 smoke movement in high buildings, 3.2.6.9.  
 sound transmission, 5.8.1.2., 9.11.1.2.  
 vapour permeance, 9.25.4.2.

Theatres, 1.4.1.2.[A], 3.3.2.14.

Thermal barriers  
 for foamed plastic, 9.10.17.10.  
 in noncombustible construction, 3.1.5.14., 3.1.5.15.

Thermal breaks, 5.9.2.4., 9.7.3.3.

Thermal bridging, 5.3.1.3., 9.25.1., 9.25.5.1.

Thermal insulation systems, 6.5.

Thermal resistance  
 building assemblies, 9.36.2.4., 9.36.2.6.  
 building assemblies below grade or in contact with  
 ground, 9.36.2.8.  
 location and installation of materials, 5.3.1.3.  
 materials in the building envelope, 9.25.5.1.  
 replacement options, 9.36.2.11.  
 requirements, 5.3.1., 9.25.1.  
 windows, doors and skylights, 9.36.2.7.

Thermal systems, solar, 9.36.3.11.

Ticket booths, 6.3.1.4.

Tile  
 clay, 9.23.4.5.  
 concrete, 9.23.4.5.

Tile, drainage, 9.14.3.

Tile, floor, 9.30.2.1., 9.30.2.2., 9.30.6.

Tile, roof  
 concrete, 5.9.1.1., 9.26.2.1.  
 eave protection, 9.26.5.1.  
 installation, 9.26.17.

Tile, wall  
 installation, 9.29.10.1.  
 moisture-resistant backing, 9.29.10.4.

Tires, storage, 3.3.6.5.

Top plates, walls, 9.23.5.4., 9.23.11.4.

Towers  
 earthquake loads and effects, 4.1.8.1.  
 wind loads, 4.1.7.11.

Toxic gases, storage, 3.3.6.3.

Trade shows, 3.1.2.3.

Traffic control, construction sites, 8.2.4.

Transformer vaults, 3.6.2.7., 9.10.1.3.

Transparent panels, 3.3.1.19., 3.4.1.8., 9.6.1.4., 9.7.2.1.

Transponder, for fire alarm, 3.2.7.10.

Travel distance  
 banks and mercantile facilities, 3.4.6.17.  
 to egress doorways, 3.3.1.5., 3.3.1.6.  
 to exit, 3.4.2.1., 3.4.2.3., 3.4.2.4., 9.9.8.2.  
 in fire compartments, 3.3.3.5.  
 measurement of, 9.9.8.1.  
 mezzanines, 9.9.8.6.  
 and number of required exits, 9.9.8.2.  
 rooms and suites, 9.9.7.4., 9.9.7.6.  
 to unlocked doors, 3.4.6.18.

Treads  
 dimensions, 3.3.1.16., 3.4.6.8., 9.8.4., 9.8.4.3.  
 finishes, 9.8.9.6.  
 mixed, 9.8.4.5.  
 nosings, 9.8.4.8.  
 rectangular, 9.8.3.1., 9.8.4.1., 9.8.4.2.  
 slip-resistance, 3.4.6.1., 9.8.9.6.  
 tapered, 3.3.1.16., 3.4.6.9., 9.8.3.1., 9.8.4.1., 9.8.4.3.,  
 9.8.4.4.  
 thickness, 9.8.9.5.

uniformity and tolerances, 9.8.4.4.  
in winders, 9.8.4.6.  
Treatment occupancy (see Care, treatment or  
detention occupancy)  
Trench, for piping of flammable liquids, 6.9.1.2.  
Trim, for windows, doors and skylights, 9.7.6.2.  
Trouble signals, 3.2.4.8., 3.2.4.9., 3.2.6.7.  
Trusses  
  design, 9.4.1.1., 9.4.2.2., 9.23.14.11.  
  lumber grade, 9.3.2.1.  
  maximum deflections, 9.23.14.11.  
  snow loads, 9.4.2.2.  
Tubing for pneumatic controls, 3.1.5.2., 3.6.4.3.  
Turnstiles, 3.4.3.3., 9.9.5.4., 9.9.5.5.  
Tying (see Anchorage)

## U

Underground ducts, 6.3.2.12., 9.33.6.7.  
Underground walkways, 3.1.13.9., 3.2.3.20., 3.2.7.3.,  
9.9.12.3.  
Underlay  
  fastening, 9.30.2.3.  
  for flooring, 9.30.2.  
  hardboard, 9.30.2.2.  
  installation, 9.26.6.2., 9.26.10.2., 9.30.2.3.  
  materials, 9.26.6.1., 9.30.2.2., 9.30.2.5.  
  material standards, 9.30.2.2.  
  nailing, 9.30.2.3.  
  OSB, 9.30.2.2.  
  particleboard, 9.30.2.2.  
  plywood, 9.30.2.2.  
  roofing, 9.26.6., 9.26.10.2.  
  beneath shakes, 9.26.10.2.  
  beneath shingles, 9.26.6.  
  stapling, 9.30.2.3.  
  thickness, 9.30.2.2.  
Unit heaters, 1.4.1.2.[A]  
Universal washrooms, 3.8.3.12.  
Unprotected openings  
  (see also Openings)  
  area increase, 3.2.3.12.  
  definition, 1.4.1.2.[A]  
  in exposing building face, 3.2.3.7.  
  in exterior walls, 3.2.3.1.  
  in floors, 9.10.1.3.  
  maximum area, 9.10.14.4.  
  and spatial separation between buildings, 9.10.14.,  
9.10.15.  
  unlimited, 3.2.3.10.  
  in wall exposed to another wall, 3.2.3.14.  
Unsafe conditions, 1.4.1.2.[A]  
Unstable liquids, 1.4.1.2.[A]  
Unusual structures, 3.2.2.2.  
Urinals, barrier-free design, 3.8.2.8., 3.8.3.14.

## V

Vacuum cleaning systems  
  emergency shutdown, 3.2.4.13.  
  fire safety shutdown, 9.10.18.7.  
  penetrating fire separations, 3.1.9.5., 9.10.9.6.  
  suites served, 9.10.9.19.  
Vapour  
  diffusion, 5.1.1.1., 5.2.1.2., 5.2.1.3., 5.5., 5.9.4.1.,  
9.25.4.1., 9.25.5.1.  
  permeance, 5.5.1.2., 9.25.4.2., 9.25.5.1.  
  transfer, 5.1.1.1., 5.2.1.2., 5.2.1.3.  
Vapour barriers  
  and dampproofing, 9.13.2.5.  
  definition, 1.4.1.2.[A]  
  in housing and small buildings, 9.25.4.  
  installation, 5.5.1.2., 9.23.2.2., 9.25.4.3.  
  in noncombustible construction, 3.1.5.2.  
  permeance, 5.5.1.2., 9.25.4.2.  
  products used, 9.25.4.3.  
  required resistance to vapour diffusion, 5.5.1.1.  
  requirements, 9.25.4.1.  
  standards for, 5.9.1.1., 9.25.4.2.  
Vapour pressure, 5.5.1.1.  
  (see also Flammable liquids)  
Vehicle guardrails, 4.1.5.15., 9.8.8.4.  
Vehicular passageways, 3.1.13.2., 3.2.3.18.  
Vehicular ramps, 3.2.8.2., 3.3.1.18., 9.8.8.4.  
Vehicular traffic, construction sites, 8.2.3.1., 8.2.4.1.  
Veneer  
  flashing, 5.6.2.1., 9.20.13.3.  
  masonry, 5.6.1.2., 9.20.6.4., 9.20.8.5., 9.20.9.5.,  
9.20.12.3.  
Vent connectors, 1.4.1.2.[A]  
Ventilating systems (see Heating, ventilating  
and air-conditioning (HVAC) systems and  
equipment)  
Ventilation  
  of air contaminants, 6.3.1.6.  
  attic or roof spaces, 6.3.1.2., 9.19.1.  
  capacity, 9.32.2.3., 9.32.3.3.  
  crawl spaces, 6.3.1.2., 9.18.3., 9.18.3.1., 9.18.3.2.  
  definition, 1.4.1.2.[A]  
  direct-vent, 9.32.3.8.  
  dwelling units, 6.3.1.1., 9.32.  
  electrical equipment vaults, 3.6.2.7.  
  exhaust, 3.3.1.20., 9.10.9.18., 9.32.3.6., 9.32.3.13.  
  exhaust ducts and outlets, 6.3.2.10.  
  garages, 3.3.5.4.  
  housing and small buildings, 9.32.  
  mechanical, 6.3.1.1., 6.3.1.4. - 6.9.1.2., 9.32.2.3.,  
9.32.3., 9.32.3.3. - 9.32.3.6.  
  natural, 6.3.1.3., 9.32.2.2.  
  outlets, 9.32.3.5., 9.32.3.6.  
  requirements, 6.2.2., 6.3.1.1., 9.32.1.2., 9.32.2.1.,  
9.32.3.1.  
  residential, 6.3.1.1.  
  restaurants, 6.3.1.7.  
  secondary suites, 9.32.1.2., 9.32.3.8., 9.32.3.9.  
  storage garages, 3.3.5.7., 6.3.1.4., 9.32.1.1.  
  windows for, 9.32.2.2.

## Venting

- air space in building envelopes, 9.25.5.1., 9.27.2.2.
- attic or roof spaces, 5.3.1.2., 6.3.1.2., 9.19.1.
- chimneys, 9.21., 9.33.10.1.
- combustion products, 6.3.3.1., 9.32.3.8., 9.33.10.1.
- crawl spaces, 6.3.1.2., 9.18.3., 9.18.3.1., 9.18.3.2.
- explosion relief devices, 3.3.1.20.
- firefighting, 3.2.8.7.
- firefighting in high buildings, 3.2.6.6., 3.2.6.9.
- heating appliances, 9.21., 9.33.5.2., 9.33.5.3., 9.33.10.1.
- laundry-drying equipment, 9.32.1.3.
- mansard or gambrel roofs, 9.19.1.4.
- soffits, 9.19.1.2., 9.19.1.3., 9.25.2.4.

## Vents

- area, 9.19.1.2.
- gas, 9.33.10.1.
- installation, 9.19.1.2.
- in stair shafts, 3.2.6.2.
- standard for, 9.19.1.2.

## Vertical service spaces

- application of Code, 3.6.1.1., 3.6.3.1.
- combustible piping in, 3.1.9.5.
- definition, 1.4.1.2.[A]
- for dumbwaiters, 3.5.3.2.
- elevator machinery, 3.5.3.3.
- exhaust ducts, 3.6.3.4., 9.10.9.18.
- fire dampers, 9.10.13.13.
- fire protection, 9.10.1.3.
- fire separations, 3.6.3.1.
- flame-spread rating, 3.1.13.2.
- penetrating floor assemblies, 3.2.8.1.

## Vestibules

- (see also Lobbies)
- access to storage garages, 3.3.5.7.
- barrier-free doors, 3.8.3.6.
- and closure devices, 3.1.8.19.
- elevators for use by firefighters, 3.2.6.5.
- garages, 3.3.5.4.
- high buildings, 3.1.13.7.
- horizontal exits, 3.4.6.10.
- interconnected floor space, 3.2.8.4.

## Vibrations

- combustible isolation connector, 3.6.5.2., 6.3.2.18.
- floors, 9.23.4.1., 9.23.4.2.
- limit states design, 4.1.3.6.

## Visual disability, 3.3.1.9.

## Visual signal devices, 3.2.4.19.

## Voice communication systems

- central alarm and control facility, 3.2.6.7.
- emergency power supply, 3.2.7.8.
- high buildings, 3.2.6.8.
- requirements, 3.2.4.22.
- speakers, 3.2.4.22.
- use of alarm circuitry, 3.2.4.18.

# W

## Waferboard

- as cladding, 5.9.1.1., 9.27.2.4., 9.27.3.6., 9.27.5., 9.27.10.
- fire blocks, 9.10.16.3.
- fire protection of soffits, 9.10.12.4.
- fire stops, 3.1.11.7.
- as interior finish, 9.29.9.
- material, 9.3.2.4.
- material standard, 5.9.1.1., 9.23.15.2., 9.23.16.2., 9.23.17.2., 9.27.10.1., 9.29.9.1., 9.30.2.2.
- as roof sheathing, 9.3.2.4., 9.23.3.5., 9.23.16.
- as siding, 9.27.3.6., 9.27.5., 9.27.10.
- as subflooring, 9.3.2.4., 9.23.3.5., 9.23.15.2., 9.23.15.5.
- thickness, 9.3.2.7.
- as underlay, 9.30.2.
- as wall sheathing, 9.3.2.4., 9.23.3.5., 9.23.10.2., 9.23.17.2., 9.23.17.5.

## Walk-in coolers/freezers, 3.1.4.2., 3.1.5.7., 9.10.17.10.

## Walks, moving, 3.2.8.2., 3.8.2.3., 3.8.2.4., 9.8.1.4.

## Walkways

- barrier-free path of travel, 3.8.3.3.
- between buildings, 3.2.3.19.
- construction camps, 9.10.21.4.
- construction sites, 8.2.1.1.
- definition, 1.4.1.2.[A]
- exterior, 3.8.3.3., 9.9.4.2., 9.9.9.3., 9.10.8.8., 9.10.17.4.
- fire protection, 9.10.1.3.
- smoke detectors, 3.2.4.11.
- underground, 3.1.13.9., 3.2.3.20., 3.2.7.3., 9.9.12.3.

## Wall membranes, 9.10.5.

## Wall panels

- braced (see Braced wall panels)
- factory-assembled, 3.1.5.7.

## Wall plates, 9.23.3.4., 9.23.11.

## Walls

- (see also Walls, exterior)
- air barrier systems, 9.25.3.
- anchorage, 9.20.11., 9.23.3.4., 9.35.4.3.
- area, calculating, 9.36.2.3.
- bracing, 9.23.10.2., 9.23.13.
- in carports, 9.35.4.1., 9.35.4.3.
- cladding, 9.27.
- continuity of insulation, 9.36.2.5.
- exposed to adjoining roof, 3.2.3.15., 9.10.12.2.
- fire blocks in, 9.10.16.2.
- fire-resistance rating, 3.2.3.7., 3.2.3.11., 9.10.8.3., 9.10.14.5., 9.10.15.5.
- firewalls (see Firewalls)
- foamed plastics in, 9.10.17.10.
- foundations, 4.2., 9.15.4.
- framing, 9.23.10., 9.24.
- garages, 9.35.4.1.
- as guards, 4.1.5.16.
- in health facilities, 3.3.3.5.
- height, 9.20.6.
- intersecting, anchorage, 9.20.11.
- lateral support, 9.20.10., 9.23.10.2.



- loadbearing, 3.2.1.4., 9.10.8.3., 9.23.9.8., 9.23.10.1., 9.23.10.2., 9.23.10.6., 9.23.12.2., 9.23.12.3., 9.24.1.1.
- masonry, 5.6.1.2., 9.20., 9.25.3.4.
- masonry veneer, 5.6.1.2., 9.20.6.4.
- non-loadbearing, 9.23.9.8., 9.23.10.1., 9.23.10.6., 9.23.12.1., 9.24.
- openings in loadbearing, 9.23.10.6., 9.23.12.2., 9.23.12.3.
- openings in non-loadbearing, 9.23.10.6., 9.23.12.1., 9.24.2.4., 9.24.3.5., 9.24.3.7.
- in public corridors, 9.10.17.5.
- recesses, 9.20.7.
- retaining, 9.3.2.9., 9.4.4.5., 9.4.4.6.
- sheathing, 9.23.13., 9.23.17., 9.27.3.4., 9.27.3.5.
- steel stud, 9.24.
- support on framed floors, 9.23.9.8.
- supports, 9.23.9.8.
- thermal insulation, 9.25.1.1.
- thickness, 9.20.6.
- wind loads, 4.1.7.5., 4.1.7.6.
- Walls, exterior**
  - in combustible construction, 3.1.4.8.
  - continuity of insulation, 9.36.2.5.
  - enclosing attic or roof space, 3.2.3.3.
  - exposed to another wall, 3.2.3.14., 9.10.12.3.
  - fire-resistance rating, 3.1.7.2., 3.1.7.3., 3.2.3.7., 3.2.3.11., 9.10.3.1., 9.10.3.3., 9.10.14.5., 9.10.15.5.
  - at firewall, 3.1.10.6.
  - in noncombustible construction, 3.1.5.5., 3.1.5.6.
  - restrictions on combustible projections, 3.2.3.6., 9.10.14.5., 9.10.15.5.
  - thickness, 9.20.6.1.
- Walls, interior**
  - airtightness, 9.36.2.10.
  - finish, 9.29.
  - not fire separations, 9.10.12.3.
  - thickness, 9.20.6.3.
- Wall studs (see Studs, steel; Studs, wood)**
- Warehouses**
  - door swing, 3.3.1.11.
  - loads on floor or roof, 4.1.5.3.
  - self-storage, 3.3.5.9., 9.9.6.4.
- Warm air outlets, 9.33.6.10., 9.33.6.11.**
- Warning lights, construction sites, 8.2.3.5.**
- Wash fountains, circular, 3.7.2.3.**
- Washrooms**
  - (see also Bathrooms)
  - barrier-free, 3.8.2.8., 3.8.3.9., 3.8.3.11., 3.8.3.15.
  - emergency lighting, 3.2.7.3.
  - floor drains, 3.7.2.7.
  - requirements, 3.7.2.2.
  - self-service storage buildings, 3.9.3.2.
  - signage, 3.8.3.9.
  - surface protection, 3.7.2.6.
  - universal, 3.8.3.12.
- Waste material**
  - chutes, 8.2.5.4.
  - enclosures, 8.2.5.3.
  - removal, 8.2.5.2.
- Water**
  - (see also Groundwater)
  - accumulation, 5.6.2.2., 5.7.1.1.
  - drainage, 5.6.2.2., 9.14.
  - drainage disposal, 9.14.5.
  - in excavations, 9.12.1.2.
  - flooring resistant to, 9.30.1.2.
  - ingress, 5.7.1.1.
  - protection against, application of Code, 9.13.1.1.
  - protection against, in exterior insulation finish systems, 5.9.4.1.
  - protection against, in fenestration, 5.9.3.5.
  - protection against hydrostatic pressure, 5.7.2.
  - protection from groundwater, 5.7.3.
  - required protection against, 5.7.1.2.
  - surface, 5.7., 5.7.1.1.
- Water closets**
  - bathtubs, 3.7.2.9.
  - doorways, 9.5.5.2.
  - in dwelling units, 9.31.4.1.
  - floor drains, 3.7.2.7.
  - grab bars, 3.7.2.8.
  - for persons with disabilities, 3.8.3.13.
  - requirements, 3.7.2.2.
  - stalls, 3.8.3.11.
  - surface protection, 3.7.2.6.
- Waterflow detecting devices, 3.2.4.4., 3.2.4.7., 3.2.4.15., 3.2.5.14., 3.2.6.7.**
- Water heaters, solar, 9.36.4.3.**
- Waterproof flooring, 9.30.1.2.**
- Waterproofing**
  - floors-on-ground, 9.13.3.1., 9.13.3.5.
  - installation, 5.6.1.2., 9.13.3.4.
  - installation standards, 9.26.15.1.
  - material standards, 5.9.1.1., 9.13.3.2., 9.26.2.1.
  - preparation of surface, 9.13.3.3.
  - protection from groundwater, 5.7.3.3.
  - requirement for, 9.13.3.1.
  - roofs, 5.6.1.2., 9.13.3.1., 9.26.2.1.
  - walls, 9.13.3.1., 9.13.3.3., 9.13.3.4.
- Waterproof interior wall finish, 9.29.2.**
- Water supply**
  - for firefighting, 3.2.5.7., 3.2.5.9., 3.2.7.9.
  - hot water, 9.31.4.2.
  - potable water, 9.31.3.
- Water supply valves, 3.2.4.9.**
- Water systems**
  - dwelling units, 9.31.3.
  - potable water, 9.31.3.1.
- Water treatment, evaporative cooling systems, 6.3.2.15.**
- Weep holes, 9.20.13.5., 9.20.13.6., 9.20.13.8.**
- Welding operations room, 3.3.1.25.**
- Wells**
  - dry, 9.14.5.3.
  - water supply, 9.14.6.2.
- Wheelchair spaces, and path of travel, 3.8.2.3., 3.8.3.21.**
- Wheelchair turning space, universal washrooms, 3.8.3.12.**
- Winders, 9.8.3.1., 9.8.4.1., 9.8.4.4., 9.8.4.6.**

**Wind load**

- and air barrier systems, 9.25.3.2.
- anchorage of building frames, 9.23.6.1.
- bracing to resist, 9.23.13.
- calculation of, 4.1.7., 5.2.1.3., 5.2.2.2.
- dynamic effects, 4.1.7.2.
- dynamic procedure, 4.1.7.8.
- environmental separation, 5.1.4.1.
- exterior ornamentations, equipment and appendages, 4.1.7.11.
- external pressure coefficients, 4.1.7.5.
- external pressure coefficients, low buildings, 4.1.7.6.
- fasteners for sheathing or subflooring, 9.23.3.5.
- full and partial, 4.1.7.9.
- interior walls and partitions, 4.1.7.10.
- internal pressure coefficient, 4.1.7.7.
- pressure differences due to, 4.1.7.10., 5.4.1.2.
- roof sheathing, 9.23.16.1.
- specified, 4.1.7.1.
- static procedure, 4.1.7.3.
- and structural design, 4.1.7.
- structural strength, 9.4.1.1., 9.6.1.3.
- topographic factor, 4.1.7.4., 9.6.1.3.
- wind tunnel procedure, 4.1.7.12.

**Windows**

- (see also Closures; Fenestration; Glass; Skylights)
- access for firefighting, 9.10.20.1.
- airtightness, 5.9.1.1., 5.9.2.3., 9.7.4., 9.36.2.9., 9.36.2.10.
- barriers or railings with, 3.3.1.19.
- in bedrooms, 9.9.10.1.
- caulking and sealing, 9.7.4., 9.20.13.11., 9.27.4.
- as closures, 3.1.8.5.
- dimensions, 9.32.2.2.
- in exits, 9.9.4.5.
- in exposing building faces, 9.10.14.4., 9.10.15.4.
- flashing, 9.20.13.3., 9.20.13.4., 9.20.13.12., 9.27.3.8.
- glass thickness, 9.6.1.3.
- for housing and small buildings, 9.7.
- installation, 9.7.6.
- manufactured and pre-assembled, 9.7.4.
- as means of egress, 9.7.2.2.
- for natural ventilation, 9.32.2.2.
- in noncombustible construction, 3.1.5.4.
- not a means of egress, 9.9.2.3.
- opening into window wells, 9.9.10.1.
- openings, 9.8.8.1., 9.9.10.1.
- performance expectations, 9.7.3.
- protection of, 3.3.4.8.
- protection in public areas, 9.8.8.1.
- protection in residential occupancy, 9.8.8.1.
- requirements, 9.7.2.2.
- resistance to forced entry, 9.7.5.3.
- sills, 9.20.13.12., 9.27.3.8.
- site-built, 9.7.5.
- standard for, 5.9.1.1., 5.9.2.2., 9.7.4.
- thermal breaks, 5.9.2.4., 9.7.3.3.
- thermal resistance calculation, 9.36.2.11.
- thermal transmittance (U-value), 9.7.3.3.
- unobstructed opening area, 9.9.10.1., 9.32.2.2.

watertightness, 5.9.1.1., 5.9.2.3., 9.7.4.

wind load resistance, 5.2.2.2., 9.7.4.

Window walls (see Fenestration)

Window wells, 9.9.10.1., 9.14.6.3.

Wind tunnel procedure, 4.1.7.12.

Wired glass

- area limits, 3.1.8.18.
- area limits waived, 3.1.8.19.
- as closure, 9.10.13.5.
- in exits, 3.2.3.13., 9.9.4.3.
- in fire separations, 3.1.8.16.
- in guards, 9.8.8.7.
- not to be used as closures, 3.2.3.5.
- temperature rise limits waived, 3.1.8.19.
- in transparent panels and doors, 3.3.1.19.
- in unprotected openings, 3.2.3.12., 9.10.14.4.
- uses, 9.6.1.4.
- in windows, doors and skylights, 5.9.1.1., 5.9.2.1.

Wires and cables

- in combustible construction, 3.1.4.3.
- electrical, 3.2.6.5., 9.34., 9.34.1.5.
- in fire separations, 9.10.9.6.
- in noncombustible construction, 3.1.5.21.
- penetrating fire separations, 3.1.9.3.
- in plenums, 3.6.4.3.
- protection of electrical conductors, 3.2.7.10.
- storage, 3.3.6.2.

Wood

- bracing, 9.23.13.
- cant strips, 9.26.4.6., 9.26.4.7., 9.26.11.10.
- columns, 9.10.14.5., 9.10.15.5., 9.17.4., 9.35.4.2.
- design and construction, 9.23.
- door frames, 9.10.13.3.
- doors, 9.7.5.2.
- fire-resistance rating, 9.10.6.2.
- fire-retardant-treated (see Fire-retardant-treated wood)
- floor beams, 9.23.8.1.
- floor joists, 9.23.9.
- flooring, 9.30.3., 9.30.4.
- floors-on-ground, 9.16.5.
- floor supports, 9.23.4.1., 9.23.4.2., 9.23.4.4., 9.23.8.3., 9.30.1.3.
- foundations, 4.2.3.1., 4.2.3.2., 9.15.1.1., 9.15.2.4.
- in heavy timber construction, 3.1.4.7.
- in noncombustible construction, 3.1.5.2., 3.1.5.3., 3.1.5.5., 3.1.5.8., 3.1.5.10.
- preservative treatment, 4.2.3.2., 9.8.9.3., 9.23.2.2., 9.23.2.3.
- roofs, 3.1.14.1., 9.23.4.1., 9.23.4.2., 9.23.4.5., 9.23.16.
- shingles and shakes, 9.26.2.1., 9.26.2.3., 9.26.3.1., 9.26.9., 9.26.10., 9.27.7.
- siding, 9.27.6., 9.27.7., 9.27.8., 9.27.9., 9.27.10.
- stairs, 9.8.9.3., 9.8.9.4.
- structural design basis, 4.3.1.

Wood blocking

- cladding, 9.23.10.5., 9.27.5.2.
- doors, 9.7.5.2.
- with handrails, 9.8.7.7.
- interior finishing materials, 9.23.10.5.
- joists, 9.23.9.3., 9.23.9.4., 9.23.14.9.

nailing, 9.23.3.4.  
in noncombustible construction, 3.1.5.2.  
rafters and joists, 9.23.14.7.  
roof edges, 9.23.16.6., 9.23.16.7.  
subflooring, 9.23.15.3.  
walls, 9.23.9.8., 9.23.10.2.

Wood-burning appliances  
chimney liners, 9.21.3.9., 9.22.2.3.  
chimneys and flues, 6.3.3.2., 6.3.3.3., 9.21.1.1.,  
9.21.2.1., 9.21.2.2., 9.33.10.2.  
ducts serving, 3.6.5.8., 9.33.6.13.  
factory-built fireplaces, 9.22.1.4., 9.22.8.1.  
hearth-mounted stoves, 9.22.10.  
inserts, 9.22.10.  
installation, 3.6.2.1.  
installation standard, 6.2.1.5., 9.22.10.2., 9.31.6.2.  
masonry fireplaces, 9.22.  
product standards, 9.22.2.3., 9.22.8.1., 9.22.10.1.,  
9.33.5.3.  
protection against depressurization, 9.32.3.8.  
venting, 6.3.3.1., 9.33.10.1.

Wood-frame construction  
alternative structural components, 9.23.1.1.  
beams to support floors, 9.23.8.  
bracing for earthquake and wind loads, 9.23.13.  
fasteners, 9.23.3.  
floor joists, 9.23.9.  
framing over openings, 9.23.12.  
housing and small buildings, 9.23.  
maximum spans, 9.23.4.  
notching and drilling, 9.23.5.  
roof and ceiling framing, 9.23.14.  
roof sheathing, 9.23.16.  
sill plates, 9.23.7.  
subflooring, 9.23.15.  
wall plates, 9.23.11.  
wall sheathing, 9.23.17.  
wall studs, 9.23.10.

Wood products  
dimensions, 9.3.2.6., 9.3.2.7.  
for housing and small buildings, 9.3.2.  
preservative treatment, 9.3.2.9.  
protection against moisture, 9.3.2.9.  
undersized, 9.3.2.8.

Workmanship review, 2.2.7.4.[C]

## Y

Yard, as access for firefighters, 9.10.20.3.

### Conversion Factors

To Convert	To	Multiply by
°C	°F	1.8 and add 32
kg	lb.	2.205
kPa	lbf/in. <sup>2</sup> (psi)	0.1450
kPa	lbf/ft. <sup>2</sup>	20.88
kW	Btu/h	3412
L	gal. (imp.)	0.2200
L/s	gal./min (gpm)	13.20
lx	ft.-candle	0.09290
m	ft.	3.281
m <sup>2</sup>	ft. <sup>2</sup>	10.76
m <sup>3</sup>	ft. <sup>3</sup>	35.31
mm	in.	0.03937
m <sup>3</sup> /h	ft. <sup>3</sup> /min (cfm)	0.5886
m/s	ft./min	196.8
MJ	Btu	947.8
N	lbf	0.2248
ng/(Pa·s·m <sup>2</sup> )	Btu/h	3.412